

A Revolutionary

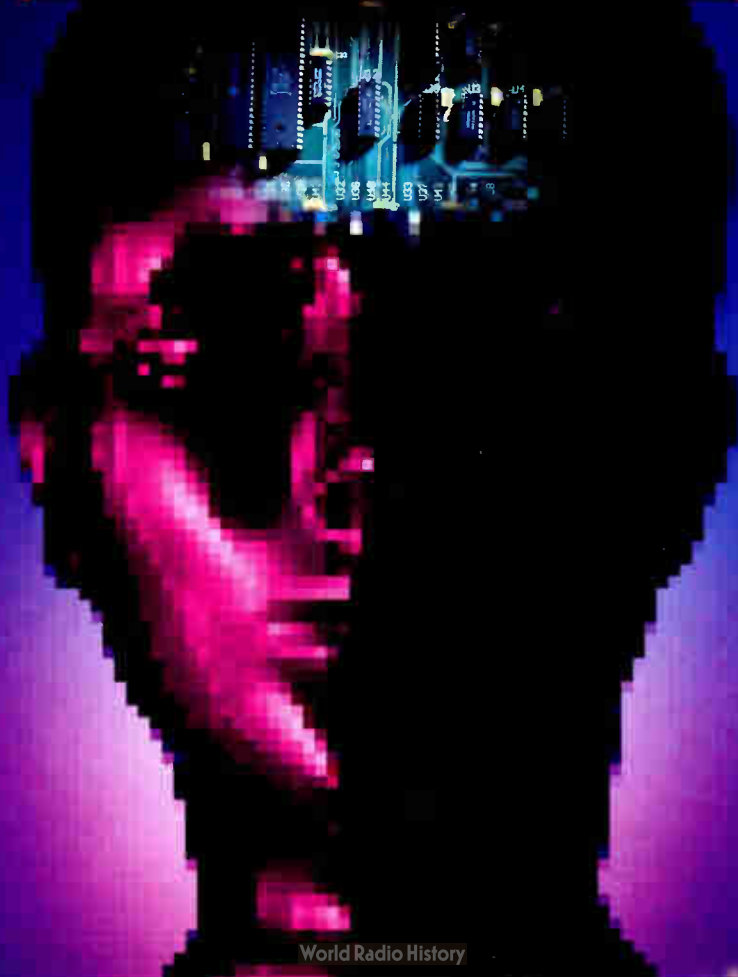

State of Mind

When we introduce a revolutionary product, we introduce a revolutionary training program to support it. IED has become known for innovative audio products... components that are unsurpassed for quality and reliability... as well as continuing field support. Our newest componentry, the Universal Digital Audio Processing System (UDAPS)™ with its digital domain processing functions of up to 508 simultaneous signal paths... is the world's first system to allow routing, signal delay, equalization and level control in one integrated system. But we provide more than componentry. The sophisticated features that make UDAPS™ the future of signal processing and distribution require a compatible training program. We provide complete technical training for UDAPS™ and every component we design and market. And we provide continuing technical support, regardless of when or where our products are installed. We instill technology through education and documentation, so you can install technology that solves audio problems more creatively than ever before. For innovation in technology, training and support – the only choice is IED.

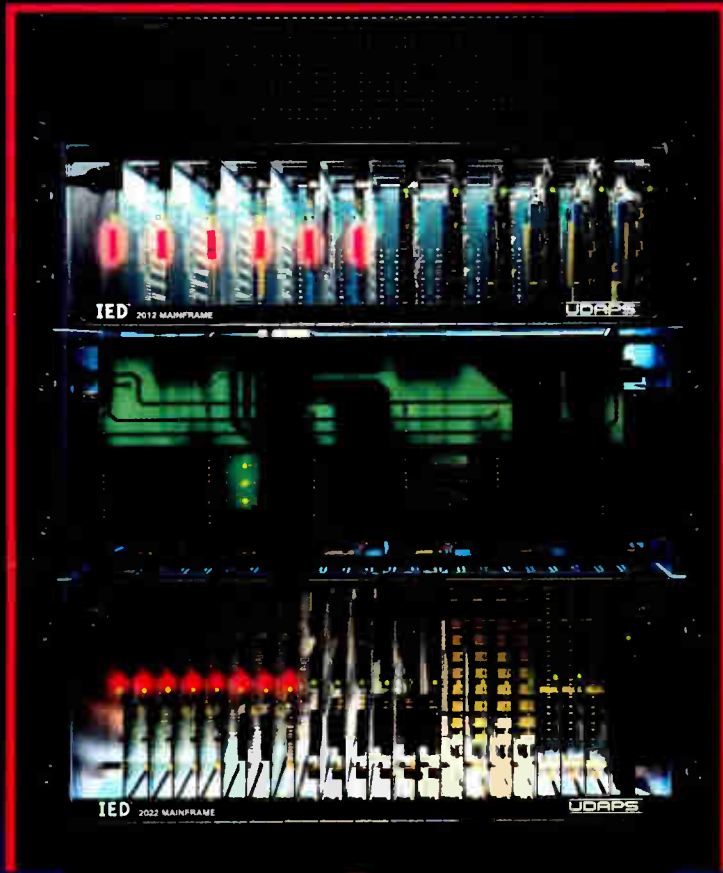
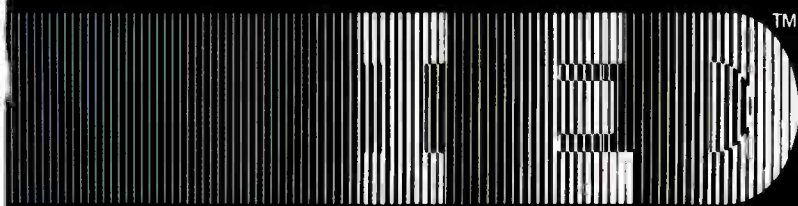

Innovative Electronic Designs, Inc.
9701 Taylorsville Road
Louisville, Kentucky 40299 U.S.A.
Tel 502.267.7436
FAX 502.267.9070

World Radio History

Circle 226 on Reader Response Card



By integrating sound processing, SAORI has reinvented system design, and in the process, revolutionized the way sound is controlled, shaped, refined and distributed. SAORI makes processing not only easier, more precise and reliable, but *repeatable*, with one-touch-recallable presets. So



you can switch the house from rock to Bach in an instant. Eight presets are built in, for house curves, zonal selection — virtually any desirable parameter. Limitless presets and acoustic control are a keystroke away via a PC interface port. Now, instead of engineering each venue from scratch, start with a head start — SAORI. 

MORE THAN THE SUM OF ITS PARTS, SAORI SIMPLY REDEFINES ENGINEERED SOUND.



This powerful control is, in part, because SAORI flawlessly integrates dozens of heretofore separate signal processors — equalizers, notch filters, CD horn compensators, crossover/band pass filters and digital

delays. With 32-bit digital purity, it eliminates the inherent noise, hiss, hum and distortion . . . the ground loops, feedback, interconnects and leveling that come with orchestrating a rack of gear. Time alignment, high-end rolloff and normal or asymmetric crossovers are precisely controlled.

More? SAORI is modular, with plug-ins for A/D and D/A conversion, 4-way channel dividers, delays, multi-equalizers . . . all individually programmable and repeatable through the LCD display.

Software upgrades and subframe expansion mean SAORI is immune to obsolescence. Still more? It really is easy to program and operate. SAORI. Just five rack units tall,

it's a small wonder.



From TOA. For more information, contact our

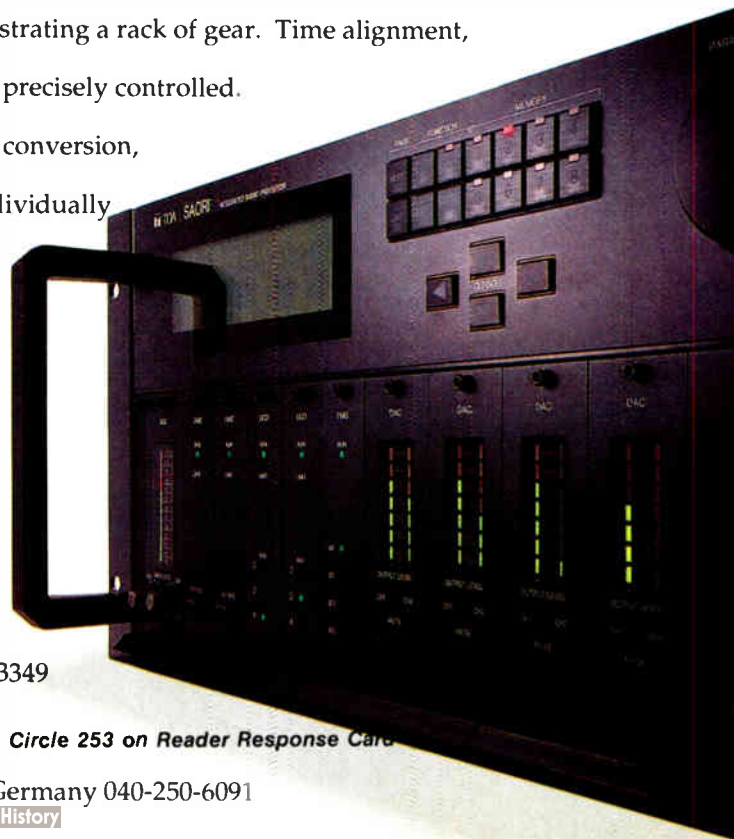

Engineered Products Group, 800/733-4750 FAX 415/588-3349

601 Gateway Blvd., South San Francisco, CA 94080.

Circle 253 on Reader Response Card

TOA Canada 416-564-3570, TOA U.K. 0277-233882, TOA Germany 040-250-6091

World Radio History

SOUND COMMUNICATIONS

BLUE BOOK TABLE OF CONTENTS

GENERAL

- 6 LETTER FROM THE EDITOR
- 18 CONTRACTORS CALENDAR
& INDUSTRY ASSOCIATIONS & SHOWS
- 20 31st ANNUAL DIRECTORY OF
INDUSTRY SUPPLIERS
- 50A READER SERVICE CARD
Send for more information
- 200 CLASSIFIED/MARKETPLACE

INDICES

- 5 QUICK REFERENCE CATEGORY INDEX
- 7 PRODUCT DIRECTORY & INDEX
- 10 MANUFACTURER INDEX
- 17 TRADE NAME INDEX
- 202 ADVERTISER INDEX

CATEGORIES

ACCESSORIES	20
ACOUSTICAL TREATMENT	22
ALARM & SECURITY	24
AUDIO AMPLIFIERS	31
AUDIO SIGNAL PROCESSORS	42
AUDIO-VISUAL EQUIPMENT/SYSTEMS	52
BACK/BACKGROUND SYSTEMS & LIBRARIES ..	60
CABINETS, FURNITURE, RACKS & CASES	62
CARILLONS & CHIMES	68
CCTV/VIDEO COMPONENTS & SYSTEMS	68
CLUB COMPONENTS & SYSTEMS	73
HARDWARE & TOOLS	78
HEADPHONES & HEADSETS	81
HEARING ASSISTANCE SYSTEMS	84
IN/OUT REGISTERS	86
INTERCOM — APARTMENT/RESIDENTIAL	87
INTERCOM — DUPLEX	90
INTERCOM — HOSPITAL HEALTH CARE	96
INTERCOM — INDUSTRIAL	99
INTERCOM — INSTITUTIONAL/SCHOOL	101
INTERCOM — PRODUCTION & THEATRICAL ..	104
INTERCOM — SIMPLEX	105
LIFE-SAFETY & VOICE EVACUATION SYSTEMS ..	108

LOUDSPEAKER ACCESSORIES	109
LOUDSPEAKERS — COMPONENTS	113
LOUDSPEAKERS — SYSTEMS	118
LOUDSPEAKERS — WALL & CEILING	131
LOUDSPEAKERS — PAGING	138
MESSAGE REPEATERS/STORECASTERS	145
MICROPHONES — WIRELESS	149
MICROPHONES	151
MIDI	157
MIXERS & MIXING CONSOLES	158
PA SYSTEMS	165
PATCH BAYS, ROUTING SWITCHERS	171
PORTABLE SOUND SYSTEMS	173
POWER PROTECTION/CONDITIONERS	175
REMOTE CONTROLS	176
SIGNALING SYSTEMS	178
SOFTWARE	179
SOUND MASKING PRODUCTS & SYSTEMS	181
TELECONFERENCING SYSTEMS	183
TEST EQUIPMENT & TOOLS	185
WIRE/CABLE COMPONENTS	190
WIRE/CABLE SYSTEMS	197

A New Edition of the Blue Book

This is the thirty-first edition of the Sound & Communications Blue Book, the most complete and accessible directory of manufacturers and products in the sound and communications industry.

The Blue Book has, through the years, become indispensable to a wide variety of industry members, not the least of whom are the dealers, contractors, installers and consultants who need information on suppliers and their products in an immediately accessible format.

The listings in the Blue Book are provided free for suppliers. The information is provided by them, so that the products they make, their personnel and their identities are as pertinent and up-to-the-minute as we can make them. The Blue Book is provided to Sound & Communications readers as a service and as part of a year's subscription.

Our data base is the most comprehensive available to a wide readership. Our listings include not only the manufacturer's name and address, but the main personnel, products and reps. You can find everything you need for a job through the Blue Book.

But that's not all folks. We've found that the range of the Blue Book's reach is far beyond particular jobs. This directory is in use all year round by all members of the industry. We're proud of it; and actually, we're glad we do it, because *we* use it too.

You can find all the manufacturers of particular equipment in one place, with all the information you need initially. The Blue Book is formulated through questionnaires sent to manufacturers each year so that they can update their own information. Each year we add to the list because of

the expansion of the market (and unfortunately, each year we also do some deletions).

We thank all the manufacturers who took the time to fill out our forms. We know the process is time consuming. And we know you're all busy. But your efforts help to make the Blue Book a valuable service to the entire industry and in particular to Sound & Communications readers who make up the influentials in the field. The distribution of the Blue Book begins with the basic distribution of Sound & Communications — meaning that it hits virtually every contractor and consultant.

If, by any oversight, a company has been excluded, please let us know. Our goal is to include every supplier doing business in the sound and communications market.

We have largely accomplished this feat. We know you'll use the Blue Book all year round. We know we do.

Thanks to everyone who helped put this issue to bed. And please send your suggestions on how we can make the 1992 Blue Book even better. We're always listening; because our reason for being is to serve our readers.

Best regards,

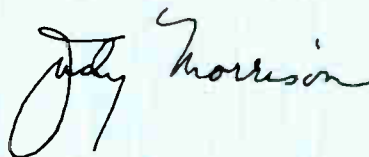

Judith Morrison
Editor in Chief

SOUND COMMUNICATIONS

Publisher/Editorial Director
Vincent P. Testa
Editor-in-Chief
Judith Morrison
Technical Editor
Mike Klasco
Associate Editor
Steve Jacobs

Assistant Research Editor
Liz Krumenacker
Editorial Assistant
Hal Bienstock

Blue Book Editorial Assistant
Jeff Colchamiro
Technical Council
Dr. Mort Altshuler

*Professor Audiology, Hahneman University,
Chief of Audiology, V.A. Hospital, Phila., PA*

C. Leroy James
Rees Associates, Inc.
Richard N. Jamieson
Jamieson and Associates, Inc.
Russell Johnson
Artec Consultants, Inc.

Joel Lewitz
Lewitz and Associates
William Parry
Maryland Sound Industries, Inc.
Daniel Queen

Daniel Queen Associates
Jon Sank
Cross Country Consultants
Neil Shaw

Paul Veneklasen Associates
William R. Thornton
Phd, PE

Art Director
Joyce Dolce
Artists

Alicia Celli, Janice Pupelis,
Scott Schlemmer, Colleen Warenik
Production Manager
Michelle Montoya
Typography

Christina Buckley
Diane Catanzaro
Circulation Director
Arturo Lizarraga

Advertising Manager
John Carr

Classified Ad Manager

Tom Dorsam
Traffic Manager
Ron Perone

Director of Sales and Marketing
Nancy Davis

Editorial and Sales Office
Sound & Communications
25 Willowdale Avenue
Port Washington, New York 11050
(516) 767-2500
FAX: (516) 767-9335

AUGUST 1991
VOL. 37 NO. 8



Sound & Communications • DJ Times • Post
Sound & Communications Blue Book
The Music & Sound Retailer • The Retailer Red Book
The Music & Sound Buyer's Guide
CES-TV News • NAB-TV News • NAMM-TV News
NSCA-TV News • CROSSTALK / AES-TV News

THE BLUE BOOK PRODUCT DIRECTORY & INDEX

- ACCESSORIES** 20
direct boxes; audio interfaces; transformers; lights
- ACOUSTICAL TREATMENT** 22
absorption; absorptive partitions; ceiling panels; dampening material; diffusion; grille cloth; noise control panels and enclosures; spray-on absorption materials; vibration isolation materials, systems, and devices; wall coverings; wall panels
- ALARM & SECURITY** 24
access control; ancillary components; announcement systems; audio surveillance; burglar alarms; CCTV; door-lock systems; duress; fire alarm; intercom; intrusion detection; signaling devices; sirens; smoke detectors; strobes; vibration sensing; video motion detection; video surveillance; wireless systems
- AUDIO AMPLIFIERS** 31
70-volt amplifiers; bi-amp systems; computer-controlled; dual-channel; low-frequency amplifiers; mixer amplifiers; modular amplifiers; monitor amplifiers; portable; signal processing amplifiers; single-channel; telephone paging amplifiers; tri-amp systems; zone-paging amplifiers
- AUDIO SIGNAL PROCESSORS** 42
1/3 octave equalizers; ambient noise level controllers; audio/video synchronizers; automatic/programmable equalizers; compressors. crossovers; de-essers; digital effects; digital encoding; digital reverbs; digital delays; digital signal processors; equalizers; graphic equalizers; interface units; levelers; limiters; noise gates; notch filters; parametric equalizers; octave equalizers; signal enhancers; signal metering; transcription preamps; VCAs
- AUDIO-VISUAL EQUIPMENT/SYSTEMS** 52
A/V speakers; audio for A/V; boardroom sound systems; closed-loop audio systems; computer control; electronic displays; image projectors; intercom; interface units; lecterns; multi-media controls; screens; supplies; wireless control
- BACK/FOREGROUND SYSTEMS & LIBRARIES** 60
automatic mixers; cassette players and changers; cassette recorders; CATV; CD changers; music libraries, stock and custom; music services; SCA equipment; tape systems
- CABINETS, FURNITURE, RACKS & CASES** 62
accessories; ATA cases and racks; chassis; computer consoles; consoles; electronic racks; enclosure systems, custom cabinets and consoles; equipment cabinets and enclosures; flight cases; furniture systems; hardware; instrument cabinets; modular boxes; molded racks and cases; panels; portable tables; rack AC power; rack fans; rack hardware; shelves, rack-mounts; shock-mount racks and cases; slides; soft cases and bags; specialty cases; stands; storage racks and cases; tables; technical workbenches; tool cases
- CARILLONS & CHIMES** 68
analog & digital tones for time and signaling; music playback-type
- CCTV/VIDEO COMPONENTS & SYSTEMS** 68
accessories; cameras; channel converters; computer interfaces; connectors; dummy cameras; effects generators; enclosures; fiber optics; hardware; lenses; message generators; modulators; monitors; multiplexers; pan/tilts; remote controls; signal distribution; specialty cameras; surveillance; switchers; time-lapse recorders; transmission systems; video mixers; video projectors; VTRs
- CLUB COMPONENTS & SYSTEMS** 73
CD players; DJ mixers; headphones; karaoke; lighting controls and effects; processors; sub-woofers; turntable cartridges and accessories; turntables
- HARDWARE & TOOLS** 78
cabinet hardware; cable clamps; cable testers; cleaning chemicals; connectors; fabrication supplies; hanging systems; knobs; lamps; linemen's test sets; markers; panels; raceways, stands; rangefinders; speaker hardware; tool kits; wire pulling devices; wire terminations
- HEADPHONES & HEADSETS** 81
boom-mic headsets; communications headsets; intercommunications headsets; isolation headsets; personal/stereo headphones; telecommunications headsets
- HEARING ASSISTANCE SYSTEMS** 84
closed loops inductive; infrared systems; multi-channel processors; programmable; wireless systems AM/FM
- IN/OUT REGISTERS** 86
access control; intercom; manual personnel; medical; monitor reporting; PC-bases; telephone reporting; terminal reporting; visual
- INTERCOM—APARTMENT/RESIDENTIAL** 87
access control; apartment station; custom; duplex; lobby; mailbox panels; microprocessor; music combination; panel/entrance; simplex; talk-back; telephone; video
- INTERCOM—DUPLEX** 90
closed-circuit; custom; digital; drive-thru; loudspeaking; microprocessor; multi-channel; programmable; telephone; video/audio; VOX; wireless
- INTERCOM—HOSPITAL HEALTH CARE** 96
A/V; annunciators; direct select; emergency call; microprocessor; nurse-call; pillow speakers; visual; voice paging
- INTERCOM—INDUSTRIAL** 99
drive-thru; environmentally protected; headset/handset; loudspeaking; telephone
- INTERCOM—INSTITUTIONAL/SCHOOL** 101
clock; console; microprocessor, multi-channel; paging; talkback; telephone; video
- INTERCOM—PRODUCTION & THEATRICAL** 104
handset; headset; IFB; loudspeaker; microprocessor; multi-channel; processors; radio interface; VOX; wireless
- INTERCOM—SIMPLEX** 105
closed-circuit; custom; digital; IFB; loudspeaking; microprocessor; multi-channel; programmable; telephone; video/audio; VOX; wireless
- LIFE-SAFETY & VOICE EVACUATION SYSTEMS** 108
audio; DC battery supply; emergency intercom; handset; message announce; tone; visual
- LOUDSPEAKER ACCESSORIES** 109
attenuators; baffles; connectors; crossovers; enclosure hardware; enclosure; grille cloth; grille cloth, fire resistant; grilles; mounting devices; mounting hardware; protection; stands; transformers

THE BLUE BOOK PRODUCT DIRECTORY & INDEX

- LOUDSPEAKERS—COMPONENTS** 113
coax; custom; drivers; environment protected; full range; high-frequency drivers; high power; horns; low-frequency drivers; mid-bass; omnidirectional; outdoor; tweeters; underwater; woofers
- LOUDSPEAKERS—SYSTEMS** 118
compact; components; custom; decorative; environment protected; foreground; full-range; high power; monitor panels; multi-way/high powered; music system speakers; near-field monitors; omnidirectional; outdoor; portable; powered; processor-controlled; stage monitors; studio/reference monitors; sub-woofers; underwater
- LOUDSPEAKERS—WALL & CEILING** 131
components; custom; decorative; environment protected; flush mount; foreground; full range; high power; music system speakers; omni-directional; outdoor; processor-controlled
- LOUDSPEAKERS—PAGING** 138
columns; components; custom; decorative; environment protected; explosion proof; flush mount; foreground; full range; high frequency drivers; high power; horns; outdoor; portable; powered; siren/voice warning; talkback; underwater
- MESSAGE REPEATERS/STORECASTERS** 145
digital systems; cart machines; message units; digital voice recording; sign systems
- MICROPHONES—WIRELESS** 149
batteries; body packs; hand-held; lavalier; multi-channel; noise reduction; receivers; single channel; true diversity; UHF; VHF
- MICROPHONES** 151
boundary; carbon; communications; condenser; contact pickups; dynamic; electret condenser; goosenecks, hand-held; headset boom; implant; instrumentation; miniature; podium; push-to-talk; ribbon; shotgun; specialty; stands; stereo; wind screens
- MIDI** 157
cable; hardware; signal processing; software; system controllers
- MIXERS & MIXING CONSOLES** 158
automatic; broadcast; combo; compressor/leveler computer controlled; custom; digital; disco; ENG; gated; microprocessor; MIDI; modular; monitor; paging; portable; powered; production, rack-mount; recording, theatrical; VCA
- PA SYSTEMS** 165
mixer/amplifier; mixer/preamps; modular; music distribution; processors; signaling; telephone; zoned
- PATCH BAYS & ROUTING SWITCHERS** 171
audio/video; cleaners; components; digital; matrix; microprocessor; mic splitters; multi boxes; pre-wired; remote controllable; telephone type
- PORTABLE SOUND SYSTEMS** 173
amplifiers; batteries; columns; DC battery powered; lecterns; megaphones; mixer amplifiers; mixers; powered lecterns; powered speakers; processors; speakers; weatherproof speakers; wireless
- POWER PROTECTION/CONDITIONERS** 175
inverters; line isolators; line protectors; noise suppression; outlet strips; power control; power conversion; power relays; transformers; uninterrupted power
- REMOTE CONTROLS** 176
A/V; audio level; boardroom; custom; DTMF; EQ/remote; hardwired; microprocessor; remote monitoring; video; wireless
- SIGNALING SYSTEMS** 178
alarm; annunciator; audio; bell; call-light; timer; tone; visual
- SOFTWARE** 179
bid software; business software; CAD software; cluster probing prediction; flow chart programs; graphics plotting; mechanical design/layout; operational software; project management; sound system design; speaker design
- SOUND MASKING PRODUCTS & SYSTEMS** 181
central; graphic equalizers; loudspeakers; noise generators; processors; programmable; self-contained/pre-engineered; zoned
- TELECONFERENCING SYSTEMS** 183
automixing; manual; microphone specific; microprocessor; telephone interface
- TEST EQUIPMENT & TOOLS** 185
analog multimeters; audio tape diagnostics; bench-top instrumentation; cable testers; calculators; CD test disks; data acquisition; digital multimeters; digital storage oscilloscopes; distortion analyzers; DSP hardware; DSP software; dual-channel spectrum analyzers; electronic tools; FFT-spectrum analyzers; filter sets; FM stereo testing; frequency-domain acquisition/analysis; function generators; hand-held instruments; linemen's test sets; logic analyzers; metering systems; mic cable testers; microprocessor systems; MTS test equipment; noise & vibration analyzers; oscilloscopes; PC systems, software; plotters; precision amplifiers; realtime analyzers; RF signal generators; RT60 meters; sound intensity measurement equipment & microphones; speech transmission analysis/intelligibility; SPL meters; tool kits; transducers; transmission link testing; vector scopes; video test signal generators; waveform recorders
- WIRE/CABLE COMPONENTS** 190
accessories; adapters; alarm; audio; computer cable & peripherals; conduits; connectors, control; data; fiber optics; fuses and holders; hardware; hybrids; jacks; low-capacitance; markers; panels; plenum cable; plugs; pre-wired systems; raceways; security; shielded; sleeving; solid; specials; stranded; switches; telecommunications; terminals; transformers; tubing; video; XLR connectors
- WIRE/CABLE SYSTEMS** 197
audio; cable reels; custom; data; fiber optics; instrument; microphone cable, snakes; MIDI; multi-pair; multi-pin disconnect; panels; snakes, digital; snakes, fiber optic; speaker; splitting; stageboxes; video

What sound does a loudspeaker make when it's on backorder?



No sound at all, obviously.
But you may hear loud noise from customers
whose requirements can't wait.

At Quam, we don't like backorders any more than you do... in fact, we won't tolerate them! To give you total protection from backorders, we keep 60,000 speakers in stock at the factory, so we can always ship, within 24 hours of your order, any standard item, including line matching transformers and ceiling grills or speaker/transformer/baffle assemblies. So when you deal with Quam, your work schedule won't be delayed because the

Quam:
The Sound
Decision

speakers you need are missing from your shelf. Nor will you have to tie up cost in inactive inventory to guard against shortages. Nor will you ever have to worry about a speaker causing a call-back. At Quam, we believe in allowing sound contractors the peace of mind that comes from having a totally reliable source for speakers.

Doesn't that sound good to you?

234 E. MARQUETTE ROAD • CHICAGO, ILLINOIS 60637
PHONE: 1 (312) 488-5800 FAX: 1 (312) 488-6944

Circle 216 on Reader Response Card
World Radio History

INDEX OF MANUFACTURERS

- 360 Systems - 145
 3M SOUND PRODUCTS - 60, 99, 145
 A & S Case Company - 62
 A.E.S. - 131
 A.W. Sperry Instruments - 185
 AB INTERNATIONAL ELECTRONICS INC. - 31, 42
 Ac-cetera Inc. - 151
 Accurate Sound Corp. - 62
 Accusonics Systems - 113, 131, 138
 ACO Pacific, Inc. - 185
 Acoustical Supply International - 113
 Acoustiflex - 22
 Acoustilog, Inc. - 185
 Acoustone Corp. - 22
 ACS Communications - 81
 ADA Amplification Systems - 42
 Adams-Smith - 42
 ADAMSON ACOUSTIC DESIGN CORP. - 42, 113, 118
 Adaptive Micro Systems, Inc. - 52
 ADC Telecommunications - 171, 190, 197
 ADI, a subsidiary of Pittway Corp. - 24
 ADM Technology - 158
 Adpro Pty. - 24
 Advanced Music Systems - 42
 Advanced Video Assoc. - 68
 Advantage - 158
 Aegis Development, a div. Oxxl Inc. - 179
 AEI Music Network, Inc. - 60
 AFA/Martin Pro Audio Group - 158
 Alphone Corp. - 24, 32, 52, 68, 86, 87, 90, 96,
 99, 101, 104, 105, 109, 113, 131,
 138, 165, 178
 Akai/IMC - 157
 AKG Acoustics, Inc. - 44, 81, 151
 ALARM ACCESSORY LTD. - 24, 190
 Alarm Controls Corp. - 24
 Alarmco - 145
 Alaun Engineering - 68
 Alesis - 32, 44, 157, 158
 All Electronics - 190
 Allen and Heath - 158
 Allsafe Company, Inc. - 24
 Almetek Industries, Inc. - 190
 Alpha Audio Acoustics - 22
 Alpha Communications - 24, 87, 90, 96, 99,
 101, 105, 178
 Alpha Wire Corp. - 197
 Altair Electronics - 185
 Altec Lansing Corp. - 32, 44, 113, 118,
 151, 158, 179
 Amber Electro Design, div. Coreco - 185
 Ambetl - 24
 Amco Engineering Co. - 62
 AMEK/TAC U.S. Operations - 44, 158
 American Acoustical Products - 22
 American DJ Supply, Inc. - 73
 American Dynamics - 68
 American Laser Systems, Inc. - 68
 American Lightwave Systems - 68
 American Zettler, Inc. - 96
 AMP Inc. - 190
 AMP Netcon - 190
 Ampex Recording Media Corporation - 60
 AmPro Corporation - 52
 Amprobe Instrument - 185
 AMS Industries, Inc. - 44, 151
 Amseco - 24
 AMX Corporation - 54, 68, 157, 176, 183
 Anaheim Technologies Inc. - 179
 Ancha Electronics Inc. - 44, 54, 176
 Anchor Audio - 173
 Anixter Bros. - 81
 ANTEX ELECTRONICS CORP. - 44, 145
 Anvil Cases (subsidi. of Zero Corp.) - 62
 Aphex Systems - 20, 32, 44, 157, 176
 API Audio Products Inc. - 158
 Apogee Electronics Corporation - 44
 Apogee Sound Inc. - 118
 Apollo Audio Visual/Apollo Lighting - 54
 Applied Research and Technology Inc - 44
 APPLIED TECHNICAL SYSTEMS - 26, 54, 101,
 145, 176, 178
 Argos Products Co. - 118
 Ariel Corp. - 185
 Arion Corp. - 54
 Armstrong Cork - 22
 ARX - 44
 ASC/Tube Trap - 22
 Ashly Audio, Inc. - 32, 44, 158, 165, 173, 181
 ATC Supply - 90
 ATI-Audio Technologies Inc. - 20, 32, 44,
 158, 181, 183
 Atls - 145
 Atkinson Dynamics - 99
 Atlas Wire & Cable - 197
 ATLAS/SOUNDOLIER - 26, 62, 105, 108, 110, 113,
 118, 131, 138, 178, 181
 ATM Fly-Ware - 110
 Audex - 149
 Audico Chicago, Inc. - 60
 Audio Accessories, Inc. - 171
 Audio Analysts U.S.A. Inc. - 165
 Audio Centron - 173
 Audio Control Industrial - 185
 Audio Design Associates, Inc. - 54
 Audio Electronics Systems - 132
 Audio Engineering Associates - 54, 151
 Audio Logic - 46
 Audio Precision - 185
 Audio Systems Co. - 46, 86, 158, 165, 171
 Audio Technology - 46
 Audio Teknology Inc. - 158, 179
 AUDIO-TECHNICA U.S., INC. - 81, 118, 149, 151,
 158, 183, 197
 Audio/Digital - 46, 165
 Audio/Video Supply, Inc. - 68
 Audioaccess - 176
 Audicom, Inc. - 60, 145
 Audioease - 54
 Audiolab Electronics Inc. - 61
 Audioparts Corp. - 81
 Audiosone - 178
 Audiotech - 113
 Audiovisual Inc. - 54
 Audiotronics, Inc. - 158
 Audix Corp. - 151
 Audra Int'l - 113
 Auernheimer Laboratories and Co. - 118
 Aural Corporation - 120
 Auratone Corporation - 120
 Australian Monitor, U.S.A. - 32
 Auto Patch, Div. of XN Technologies - 171
 Autocall - 26
 Autodesk Inc. - 179
 Autogram Corporation - 159
 Automation Devices - 145
 Automation Electronics Corp. - 145
 AV Systems Engineering Pty. Ltd. - 54, 159
 AVA Electronics - 78
 AVL Audio Visual Laboratories Inc. - 54
 AVL Systems, Inc. - 23
 AVNC/Instrument Div. - 185
 Azden - 46
 B & B Systems, Inc. - 186
 B & K Precision - 186
 B.E.S.T. - 132
 Bag End Loudspeaker Systems - 120
 Banner Magnetics - Toroids - 20
 Barco, Incorporated - 54
 Bauer Communications Inc. - 20
 BBE SOUND, INC. - 46, 73, 104, 165
 Beckman Industrial Corporation - 186
 Benchmark Media Systems, Inc. - 20, 32, 171
 Benjamin International, Inc. - 61
 Berk-Tek - 190
 beyerdynamic))) - 81, 149, 151

- BGM International - 61
 BGW Systems, Inc. - 32
 BI-Tronics, Inc. - 78, 175, 190, 197
 Blamp Systems - 159
 BJM Electronics Ltd. - 63, 78, 171, 186, 190, 197
 Black Audio Devices - 63, 78, 151, 190, 197
 BLI - 23
 Blonder-Tongue Laboratories, Inc. - 68
 Bobadilla Cases - 63
 Bogen Communications, Inc. - 26, 32, 87, 90, 99, 107, 110, 113, 120, 132, 138, 145, 151, 159, 165
 Boonton Electronics - 186
 BOSE CORP. - 54, 120, 132, 138, 166, 174, 179
 Bostick - 23
 Boston Acoustics - 120
 Boulder Amplifiers, Inc. - 32
 Bourns Inc. - 20
 Brahler - 84
 Brejtfus Business Environments - 23
 Bretford Manufacturing - 63
 Brim Electronics - 78, 190, 197
 Broadcast Audio - 159
 Broadcast Electronics - 159
 Broadcast Equipment Sales - 159
 Brooks Electronic System Technology - 46
 Bruel & Kjaer Instruments, Inc. - 186
 Bryston/ Brystonvermont Limited - 32, 46
 BSM Systems - 171
 BSS Audio/ Div. of AKG - 46
 Bud Industries, Inc. - 63
 Burle Industries Inc. - 26
 C & K Systems, Inc. - 26
 C-Cor/Comlux, Inc. - 68
 C-T Audio - 151
 Cableready, Inc., 190
 Cabletronix - 197
 Cabtron Systems - 63
 CADD Creative Audio Design & Dev. - 159
 Cal Switch - 190
 Calculated Industries, Inc. - 186
 Calibration Standard Instruments - 120
 Callfone Int'l - 54
 Calrad Electronics - 110
 Calzone Case - 63
 Cambridge Electronics Laboratories - 90
 Canare - 171, 191, 197
 Caraway Audio - 120
 Carol Products Co. Inc. - 68
 Carver Corp. - 34
 Carvin Corporation - 174
 Casco Background Sound, Inc. - 61
 Case Component Network - 78
 Caseworks of Chicago - 63
 Cat Wire and Cable Corp. - 191
 Catel Telecommunications, Inc. - 70
 CBM Metal - 63
 CCTV Corporation - 70
 Celestial Software - 186
 CELESTION INDUSTRIES, INC. - 113, 120
 Celotex - 23
 Cerwin-Vega - 114, 120, 132, 166
 CG Instruments - 186
 Chadwick Helmuth - 186
 Champlain Cable - 191
 Chandler Industries - 46
 Channel Master, Div. of Avnet - 70
 Channelmatic, Inc. - 70
 Chester Cable - 197
 Chief Manufacturing Inc. - 63
 Clair Brothers Audio Systems Inc - 120
 CLARITY - 34, 46, 110, 132, 138, 149, 151, 166, 198
 Clarostat Mfg. - 20
 Clear-Com Intercom Systems - 104
 Clever Devices Ltd. - 145
 Cliff Electronics Inc. - 78, 114, 191
 Clifford of Vermont, Inc. - 191
 CMX - 96
 Coherent Communications - 26
 Cohu Inc. Electronics Division - 70
 Colorado Video - 183
 Columbia Scientific Industries Corp - 90, 99, 107
 Com-Tec Inc. - 86, 99
 Comm/Scope, Inc.-Network Cable Div. - 191
 Commercial Sound Labs/ Cytech Ltd. - 175
 Communications Company, Inc. - 20, 54
 Communications Equipment - 90
 Communications Products - 26
 Community Professional Sound Sys. - 120
 Compact Monitor Systems - 120
 Compression Labs, Inc. (CLI) - 70
 Computational Systems - 186
 Comsec - 20
 Comtek - 84, 90, 104, 149
 Comutronix, Inc. - 34
 Conex Electro-Systems, Inc. - 171
 Connectronics Corp. - 198
 Conquest Sound, Inc. - 70, 157, 171, 191, 198
 Consolidated Elec. Wire & Cable - 198
 Contact East, Inc. - 186
 Continental Instruments - 26
 Controlled Acoustics Corp. - 23
 Cooper Industries/Belden Division - 191
 Cornell Electronic Products, Inc. - 26, 86, 87, 96, 101, 178
 Countryman Associates, Inc. - 151
 Covox - 157
 Createc Signal Computer USA - 186
 Creative Acoustics, Inc. - 132
 Crest Audio Inc. - 34
 Crest Electronics Inc. - 34, 70
 Crestron Electronics, Inc. - 54, 176, 183
 Crown - 34, 151
 CSI-Components Specialties, Inc. - 114
 CTI Audio, Inc. - 152
 Current Designs Corporation - 54
 Cyborg - 186
 CZ Labs - 191
 D & R USA - 159
 D.A.S. Audio, S.A. - 114
 D.J. Associates, Inc. - 78
 D.O. Industries - 54
 Da-Lite Screen Co., Inc. - 54
 Daburn Electronics and Cable Corp. - 191, 198
 Dan Dugan Sound Design - 46, 159, 183
 Danavox/Telecommunications Div. - 81
 Data Check - 186
 Data Physics - 186
 David Clark Company, Inc. - 81
 Davis Instrument Mfg. Co., Inc. - 186
 Dawn Speaker Systems - 120
 DAX - 159
 Dayton Industrial Corporation - 61
 dbx Professional Products-AKG Inc. - 47
 DCL - 120
 DCS Audio Products - 36
 DDA - 159
 De-Tech Systems - 26
 Decoustics Limited - 23
 Dekoron Div. Of Furon Co. - 198
 Delta Communications Co. - 101
 Delta Wire/Cable - 198
 Deltec Electronics Corp. - 175
 Denon America, Inc. - 73
 Design Direct Sound Inc. - 114
 Detection Systems - 26
 Detector Systems Inc. - 26, 99
 Developmental Technologies Grp. Inc - 198
 DIA General - 26
 Diamond Electronics - 70
 Digital Designs International - 73, 120
 Digital Music Corp. - 157
 DigITech - 47
 Diversified Case Company, Inc. - 63
 DOD Electronics - 47
 Dolby Laboratories - 47
 Door Alarm Devices Corp. - 101
 Doorguard Systems, Inc. - 26
 Doorking, Inc. - 87
 Dorado Systems Corp. - 26
 Dorrough Electronics - 47, 186
 DRA Laboratories - 186
 Draper Shade and Screen Company Inc - 54
 Drawmer/QMI - 47
 Drive-Thru Intercoms - 99

- DSP Development Corp. - 186
 Dukane Corp. - 47, 54, 64, 90, 96, 99, 101, 107, 108, 110, 114, 122
 132, 138, 152, 159, 166, 174, 181
 Duncan Electronics - 191
 Dunegan Div., Physical Acoustics - 186
 Duracote Corp. - 23
 Dyma Engineering - 172
 Dynaco - 132
 Dynacord - 48
 Dynair Electronics, Inc. - 172
 Dynamic Software Systems - 186
 Dynamote Corporation - 175
 Dynasound, Inc. - 181
 Dynaware USA, Inc. - 179
 E.A.W. - 122
 E.M. Long Associates - 122
 E3MC - 114
 Eastman Wire & Cable Company - 191
 Eby Co. - 183
 Eckel Industries Inc. - 23
 Ecler/TEI Electronics - 36, 48, 70, 159
 EDCOR ELECTRONICS - 20, 36, 48, 159, 166, 183
 Eden Electronics, Inc. - 73, 114, 122, 132, 138
 Edstan, Inc. - 86
 Edwards Company, Inc. - 26, 96, 178
 EECO - 172
 Elbex America (NY) Inc. - 70
 Electro Force Corporation - 36
 Electro Space Fabricators - 64
 Electro-Voice Inc. - 36, 73, 122, 152, 159
 Electro-Vox - 26
 Electrohome Limited - 55
 Electron Processing - 149
 Electrorack Products Co., Inc. - 64
 Electrosonic Systems, Inc. - 55
 Elenex, Inc. - 99
 Elkay Industries - 26, 64, 99, 102, 110, 132, 139, 176, 181
 Elma Electronic, Inc. - 64
 Elmo Manufacturing Corporation - 55, 70
 Eitrex Int'l - 26
 Emcor Products/Crenlo, Inc. - 64
 EMI - 70
 EMS/Music - 37, 61
 ENCOM PRODUCTS CO., INC. - 26, 99, 108
 Endevco - 186
 Eneractive Group Inc. - 108
 Engineered Electronics Inc. - 96
 ENVIRONMENTAL SOUND - 55, 73, 104, 110, 114, 122, 133, 139
 Equipro Electronics Corp. - 64
 Equity Sound Investments - 122
 ERL Electronic Products, Inc. - 87
 ESE - 20, 48, 55, 70, 172, 178, 183
 Esoteric Sound - 48
 ETA Lighting Systems - 175
 Ethereal Concepts - 175
 Eventide Inc. - 48
 EVG - 191
 EXI ELECTRONICS MANUFACTURING
 27, 86, 96, 178
 Extron Electronics - 55
 Fanon Courier - 87, 139, 166, 174
 Faraday, Inc. - 27
 Federal Signal Corp. Comm. Products - 27
 Fender Musical Instruments/Sunn - 122
 FGS Intergalactic Cartel & Holding Co. - 48
 Fiber Optek - 198
 Fiber Options - 27, 70, 191, 198
 Fidellpac Corp. - 61
 Fire Burglary Instruments - 27
 Fire Control Instruments, Inc. - 27, 108
 Fisher Berkeley Corporation - 86, 87, 90, 96, 99, 107
 Flight Form Cases Inc. - 64
 Florence Manufacturing Co. - 87
 Floyd Bell, Inc. - 27
 FM Acoustics Ltd. of Switzerland - 37
 Formula Audio, Incorporated - 122
 Forward Innovations - 186
 FOSTEX CORPORATION OF AMERICA -
 48, 64, 82, 111, 122, 133, 152, 157, 159, 166, 172
 Fotec, Inc. - 198
 Four Designs - 64
 Fourjay Industries Inc. - 111
 Franklin Instrument/Time Systems - 102
 Frazier/Div of SoundCraft Sys. Inc. - 122
 Freeform R & D - 78
 FSR Inc. - 20, 27, 55, 111, 176, 183
 Furman Sound, Incorporated - 48, 175
 G.R. Thurmond & Associates - 179
 GAI-Tronics Corp. - 139
 Galaxy Audio - 122
 Galaxy Control Systems - 28
 Gaslight Video - 70
 Gauss - 114
 GBE Group - 55
 Gefen Systems - 61, 73
 Gemco Electronics, Inc. - 37, 111, 133, 139
 Gemini Inc. - 64
 Genelec/QMI - 122
 General Devices Co., Inc. - 64
 General Instrument Network Cable - 191
 General Security Co., Inc. - 28
 Gentex Corporation - 28
 Gentner Communications Corporation - 183
 GEPCO INTERNATIONAL INC. -
 65, 79, 172, 191, 198
 GERR Electro Acoustics Ltd. - 122
 GHI Systems - 186
 Ghelmetti Inc. - 172
 Gilderfluke & Co. - 48, 68, 107, 145, 166
 GNWC Wire, Cable & Network Products - 191
 Gold Line - 186
 Gold Ribbon Sound Cinema - 55
 Gorman Redlich Mfg. Co - 178
 Graham-Patten Systems, Inc. - 159
 Grant Products d/b/a Pivottell/USA - 65
 GYYR, A DIVISION OF ODETICS - 28, 70
 H.M. Dyer Electronics - 172
 H.O.M.E. Inc. - 65
 Hacoustic Sound & Comm. of America - 37
 Hafler Professional - 37
 Hamilton Standard Controls - 191
 Hammond Mfg. - 65
 Harman Elec. Inc./JBL Video Products - 70
 Harnel Company - 65
 Harris Corp., Dracon Div. - 139
 Headwater USA - 122
 Heath - 20
 Heather Sound Amplification-HSA - 65
 Hedco - 172
 Heliotrope General - 145
 Henry Engineering - 20
 Hewlett-Packard - 187
 HI Lo Fabrication & Manufacturing - 65, 111, 122, 198
 Hill Audio/IMC - 159
 Hirschmann of America - 70
 Hitachi Denshi America, Ltd. - 70
 HM ELECTRONICS, INC. - 82, 91, 99, 104, 107, 149
 Hoffend & Sons - 187
 Holophonics - 37
 Home Safeguard Industries - 28
 Honeywell Test Instruments Div. - 187
 Hosa Technology Inc./Phonic - 159
 Hot House Marketing - 23
 Hot House Professional Audio - 37
 House of Metal Enclosures - 65
 Housing Devices Inc. - 87
 Howe Technologies - 160
 Hudson Photographic Industries - 55
 Hughes Electronic Devices - 172
 Hybrid Cases - 65
 Ideal Wire Products Inc. - 191
 Identcard Technologies - 28
 IGM Communications - 66
 Ikegami Electronics (USA), Inc. - 70
 Impart - 20
 Industrial Acoustics - 23

- Industry West Electronics - 20, 37, 57
 Infinity Systems, Inc. - 122
 Infonics, Inc. - 57
 INNOVATIVE ELECTRONIC DESIGNS, INC. -
 37, 48, 61, 108, 145, 160,
 166, 172, 176, 178, 179, 184
 Inovonics - 48
 Int'l Satellite Systems - 66
 Intec Video Systems - 71
 Intelix - 57, 160, 172, 177, 184
 Intelligent Controls, Inc. - 28
 Intercall Systems, Inc. - 96
 Interlor Acoustics, Inc. - 181
 International Components Corp. - 28, 82,
 111, 114, 124, 133, 139,
 149, 152, 178, 191, 192
 International Elec. Wire & Cable Co - 192
 International Electro-Magnetics Inc. - 61
 International Electronic Wire&Cable - 192
 International Logistics Systems Inc. - 28, 71,
 91, 149
 Intersonics, Inc. - 124
 IRP, A KNOWLES COMPANY - 37, 48, 57, 61,
 74, 160, 168, 172,
 174, 177, 184
 ITT Pomona Electronics - 192
 Ivie Technologies Inc. - 37, 50, 160, 187
 Iwatsu America - 187
 J.H. Sessions & Son - 79
 J.L. Cooper Electronics - 161
 J.N.S. Electronics, Inc. - 172
 J.W. DAVIS AND CO. - 20, 28, 37, 57, 66, 71, 79,
 84, 89, 100, 102, 104, 107, 111, 114,
 124, 133, 139, 145, 149, 152, 168,
 174, 181, 192, 198
 Jan-AI Cases - 66
 Javelln Electronics div. Atapco - 71
 JBL Professional - 37, 50, 114, 124,
 133, 139, 168, 174
 Jensen Tools - 187
 JENSEN TRANSFORMERS INC. - 20, 38, 180
 Jeron Electronic Systems, Inc. - 86, 89, 96,
 102, 107
 John Fluke Manufacturing Co., Inc. - 187
 JSC Wire & Cable - 192
 JVC Professional Products Co. - 71
 Kable King - 192
 Kalamazoo Technical Furniture Inc. - 66
 KARIBU SOUND INDUSTRIES INC. - 57, 66, 111,
 114, 124, 133, 139
 Kay Elemetrics Corp. - 187
 KDM Electronics Inc. - 124
 Keithley Instruments Div. - 187
 Keltron Corp. - 28
 Kelvin Electronics - 187
 Klnometrics/TrueTime - 187
 King Wire & Cable - 192
 Klark-Teknik Electronics Inc. - 50
 Klipsch and Associates, Inc. - 124
 Knight Industries - 66
 Knoll Systems - 124
 Knowles Electronics - 152
 Knox Security Engineering Corp. - 58
 Komotech - (Lite-Sonic) Inc. - 174
 Komtek Communications - 96
 Korfund Dynamics - 23
 Koss Corporation - 82
 Koyo Int'l of America - 71
 Krohn-Hite - 187
 Kulka-Smith - 192
 LA East, Inc. - 133
 LaBelle Display Sciences Group - 145
 Labor Saving Devices - 188
 Lake Inc. - 71
 LAR Electronics Corporation - 122
 Larson Davis Laboratories - 152, 188
 Lathem Time Corporation - 178
 Leader Instruments Corp. - 188
 Lectrosomics, Inc. - 38, 50, 139, 149,
 152, 161, 168, 174
 LEE DAN COMMUNICATIONS, INC. - 28, 57, 86,
 89, 91, 97, 100, 102, 107,
 112, 114, 139, 178, 192, 198
 Leek Building Products, Inc. - 23
 LeFebure - 28
 Lelch Inc. - 38
 Lemo USA, Inc. - 79, 192
 Len Finkler - 38
 Leprecon/ CAE Inc. - 74
 LEQ Measurements - 188
 Lester Audio Laboratories - 172, 198
 Lexicon Inc. - 50
 Lightronics - 20
 LIGHTSPEED TECHNOLOGIES, INC. - 82, 149
 Lightwave Communications - 71
 Linear & Digital Systems - 175
 Littlite/ CAE Inc. - 20
 LM Engineering - 66
 Logitek Electronics Systems Inc. - 161
 Lone Wolf - 157
 Louroe Electronics - 28
 Lowell Manufacturing Company - 112
 LPB Inc. - 161
 Lucasfilm Ltd./THX Group - 188
 LVW Electronics - 38
 LynTec - 50, 112, 161, 168, 172, 175, 177, 181
 M & S Systems, Inc. - 89
 Maas-Rowe Carllions, Inc. - 68
 MACKENZIE LABORATORIES, INC. - 28, 108,
 145, 168
 Mag-Tags Inc. - 21, 161
 MagnaSound - div. of UXL Corp. - 174
 Magne-Tronics - 66
 Magnefax International Inc. - 61
 Magnetic Reference Lab - 188
 Marantz Professional Audio - 61
 Marcom (The Scotts Valley Grp.) Inc - 184
 Marletta Wire & Cable - 192
 Markertek Video Supply - 71
 MARLEE ELECTRONICS - 28
 Marsh Products - 86
 Marshall Electronic - 50
 Marshall Electronics Inc. - 192
 Marshall Long Acoustics - 50
 Mason Industries - 23
 Math Associates, Inc. - 71, 192, 198
 Maxltron Corp. - 38
 MaxIVox - 102
 MBI Metal Building Interior Prod Co - 23
 McCauley Sound, Inc. - 112, 114, 124
 McCurdy Radio Industries Ltd. - 161
 McGohan Electronics - 28, 38, 168
 MED-TEK HEALTHCARE PRODUCTS - 97, 179
 Medi-Signal Systems Co. - 97
 Medisco, Inc. - 192
 Mehlich Electronics, Inc. - 97
 Mellotone - 23
 Meridian Communications - 161, 184
 Meridian Technologies, Inc. - 21, 28, 71, 79,
 188, 192, 198
 MetraByte - 188
 Metragen Ltd. - 82
 Metrosonics - 188
 Meyer Sound Laboratories Inc. - 38, 126, 188
 MFJ Enterprises, Inc. - 71
 MG Electronics - 21, 29, 112, 114,
 126, 134, 139
 MicroAudio Inc. - 50, 161
 Microframe Corporation - 179
 Microtran Company - 192
 Microvoice Corporation - 145
 Midas - 161
 Middle Atlantic Products - 66, 79, 112, 192, 198
 Midwest Electronic Industries - 168
 Mikrolab Video - 71
 Millab - 152
 Miller-Stephenson Chemical - 79
 Milliphonics - 152
 Mircom Communication & Security Inc - 89
 MISCO/Minneapolis Speaker Co., Inc. -
 116, 126, 134, 139
 Mitsubishi Electronics America, Inc. - 57, 71
 Modular Sound Systems, Inc. - 126
 Moduiock Inc. - 66
 Monster Cable - 199

- Morenz Development Corp. - 38
 Mortronics - 112
 Moseley Associates, Inc. - 177
 Motorola Inc. Ceramic Products - 116
 MPO Videotronics - 57
 MTX - 116
 MTX Oaktron - 134
 Multigon Industries, Inc. - 188
 Multiplex Technology Inc. - 71
 Music Programming Inc. - 61
 Music Springs, Inc. - 61
 Music Supply Company, Inc. - 79, 112, 188
 Musikos, Inc. - 61
 Muzak - 61
 Mystery Electronics - 199
 Nady Systems, Inc. - 149
 Nakamichi America - 61
 Napco Security System - 29
 Nasca Automated Systems - 180
 National Electric Cable - 192
 Navco Security Systems - 29
 Navitar AV - 57
 NEAR - New England Audio Resource -
 116, 126, 134
 Nel-Tech Labs, Inc. - 145
 Nema Electronics International Inc - 192
 Neotek Corp. - 162
 Ness - 74
 Network A-V Innovations - 57
 Neumann (USA) - 152
 Neutrik USA, Inc. - 79, 112, 145, 188, 192, 199
 Nicolet Instrument Corporation - 188
 Niles Audio - 21
 Non-Linear Systems - 188
 Noramco Wire & Cable - 192
 Norcon Electronics, Inc. - 91
 Norland - 188
 North Hills Electronics - 192
 North Star Sound, Inc. - 180
 Northern Information Technology Inc. - 71
 Nortronics Company, Inc. - 61
 Notifier - 29
 Novadyne - 172
 NSI Corporation - 74
 Numark Electronics - 74
 O'Brien Partition - 23
 O-Ryan Industries - 74
 OAP Audio Products - 126
 Old Colony Sound Laboratory - 180
 Olflex Wire & Cable - 192
 Olson Acoustics - 126
 Omni Q Inc. - 57
 Omnimount Systems - 112
 One Power - 175
 Opamp Labs Inc. - 38
 Optical Radiation Corporation - 162
 OptoDigital Design Inc. - 50, 57, 71, 199
 Orban Associates, div. AKG Acous. - 50
 Orchard Communications - 71, 184
 Oregon Scientific Inc. - 29
 Otari Corp. - 162
 Outline - 38, 50, 74, 116, 126, 162
 OVAL WINDOW AUDIO - 84
 Owens-Corning Fibrgls, Acous. Prod. - 23
 OWI INC. - 112, 126, 134, 139
 OXMOOR CORP. - 38, 50, 57, 162, 168,
 172, 177, 181, 184
 Oz Electronics, Inc. - 57
 P/H Electronics, Inc. - 57
 PA Concepts - 139
 Pacific Transformer Corp. - 112
 Paige Electric Corp. - 194
 Paladin Corp. - 79
 PANASONIC CCVED - 29, 71
 Panasonic Professional Audio Sys. - 38, 57,
 127, 152, 162, 168
 Panduit Corp. - 194
 PAR Metal Products/PAR Industrial - 66
 Paramount Picts. Home Theater Prods -
 127, 134
 Parasound Products Inc. - 127
 Parsons Mfg. Corp. - 21, 66
 PARTS EXPRESS INT'L INC. - 66, 112, 116, 134
 Paso Sound Products, Inc. - 21, 29, 38, 50,
 58, 62, 74, 89, 91, 102, 112, 116, 127,
 136, 140, 149, 150, 163, 168, 174, 181
 Patch Bay Designation Co. - 173
 PEAVEY ELECTRONICS CORP. - 21, 39, 51, 66,
 74, 79, 112, 116, 127, 136, 150,
 152, 157, 163, 168, 173, 174,
 181, 188, 194, 199
 Peerless Sales Company - 66, 71, 112
 Pelco - 71
 Penn Fabrication - 79
 Penny & Giles, Inc. - 21
 Pentagon Industries, Inc. - 62
 Perimeter Products, Inc. - 29
 Perma Power Electronics, Inc. - 174
 Petcom - 107
 Phonic Ear Inc. - 84, 150
 Pignose Industries - 39
 Pinkerton Controls System - 29
 Pioneer Laser Entertainment - 74
 Pittsburgh Corning - 23
 Plainview Batteries, Inc. - 150
 Plantronics - 82
 Polyphaser - 175
 Portac, Inc. - 71
 PORTLAND INSTRUMENT CORP. -
 39, 91, 104, 107
 Posthorn Recordings - 154
 Power Technologies - 194
 Powertronix - 29
 Precise Manufacturing Co. Inc. - 58
 Precision Electronics, Inc. - 39
 Precision Fabrication Technologies - 66
 Preh Electronic Industries, Inc. - 194
 Premier Metal Products Co. - 66
 Princeton Applied Research - 188
 Pro Co Sound Inc. - 199
 Professional Audio Systems - 116, 127
 Professional Sound - 163
 Progressive Electronics - 188
 Progressive Marketing Group, Inc. - 116
 Projected Sound Co., Inc. - 116
 Promark Electronics Inc. - 194
 Proprietary Controls Systems Corp. - 29
 Prosonus - 188
 Protech Audio Corporation - 21, 29, 39, 51,
 58, 100, 103, 163, 168, 173, 177, 179
 Proto-Tec - 194
 Pulnix America, Inc. - 29
 Pyle Industries, Inc. - 116
 Pyrok Inc. - 23
 QSC Audio Products, Inc. - 39
 Quabbin Wire & Cable Co., Inc. - 199
 Quam Nichols Co. - 136
 Quantam Audio Labs - 163
 Quest Electronics - 188
 Quickset International, Inc. - 72
 R-Columbia Products Co. - 82
 R.A. Gray, Inc. - 58
 R.B. Annis Co. Inc. - 21, 79, 188
 R.C. Electronics, Inc. - 188
 Racom Products, Inc. - 29, 147
 Racon, Inc. - 29
 Racware (Rackmounted Computers) - 67
 Radian Audio Engineering - 116, 128, 136
 Radio Design Labs - 39, 51, 163, 168
 RAG Electronics - 188
 Rainbow Sound and Lighting - 128
 Ramko Research - 39
 Rampart Cases, Inc. - 67
 Ramsdell Audio - 116
 Rane Corp. - 40, 51, 74, 158, 168
 Rapco International Inc. - 21, 199
 Rapid Systems, Inc. - 188
 Rauland-Borg Corp. - 29, 40, 51, 92, 97, 103,
 108, 170, 174
 Raxxess Metalsmiths - 67
 Raychem Corp. - 194
 RCI Systems, Inc. - 22, 67, 173
 RE Instruments Corp. - 188
 Recordex - 163
 Remeo Products Corporation - 194

- Renkus-Heinz, Inc. - 116, 128, 180
 Resco, Inc. - 194
 REVERE INDUSTRIES - 29, 40, 72, 112, 117,
 128, 137, 140, 154, 170, 179, 194, 199
 Richard J. Lemker & Associates - 180
 Richardson Electronics Limited, SSD -
 30, 72, 105
 Richmond Sound Design Ltd. - 180
 RING COMMUNICATIONS INC. - 40, 87, 92, 97,
 100, 107, 137
 Riser-Bond Instruments - 188
 RMS Electronics Inc. - 194
 Roadrunner Cases Inc. - 67
 Roanwell Corp. - 82
 Robot Research, Inc. - 72
 Rockland Scientific Corp. - 189
 Rocktron/RSP Tech. - 51
 Rockustics, Inc. - 128
 Rofu Int'l - 30
 ROH Products - 105
 Rolls Corp. - 40
 Ross Systems/IMC - 170
 Rowe International Inc. - 62
 RPG Diffusor Systems, Inc. - 23
 RTE Deltec - 176
 RTI-Research Technology Int'l - 72
 RTS Systems, A Telex Comm. Company -
 40, 82, 84, 92, 100, 105, 107
 Runco International - 58
 Russco Electronics Mfg., Inc. - 163
 S.E.M. Co. - 40, 51, 62, 164, 170, 173, 177
 Sabine Musical Mfg. Co., Inc. - 51, 74, 170, 181
 Samson Technologies Corp. - 150
 San Ming Sound Co. - 140
 Sandy Enterprises Inc. - 58
 Sanken Microphone/Developing Tech. - 154
 Sanyo-Industrial Video Division - 72
 SCA Data Systems, Inc. - 62
 Scantek, Inc. - 51
 Scantronic USA Inc. - 98
 Schell Electronics, Inc. - 84, 150
 Schlumberger Technologies - 189
 Schroff Inc. - 67
 Schulmerich Carillons, Inc. - 68
 Scientific Atlanta/OPTIMA Div. - 189
 Scientific Design Software - 180
 Scott Instrument Lab., DIV. of Lind - 189
 SCS Sound Code Systems, Inc. - 40
 SCV Audio/QMI - 51
 Seal-O-Matic Co. - 79
 Seam-Tech - 194
 Securitron Magnalock Corporation - 30
 Security Intercom - 30
 Security Resources - 72
 Seeburg Music Satellite Network - 67
 Selco Products Company - 79
 Select Engineered Systems - 30, 89
 Sencore - 189
 Sennheler Electronic Corp. - 82, 84, 150,
 154, 189
 Sensor Engineering Co. - 30
 Sentex Systems, Inc. - 30
 SESCOM, INC. - 67, 189
 Setcom Corporation - 82
 Seven Systems, Inc. - 62
 Sharp Electronics Corp. LCD Prods. - 72
 Sharp Electronics Corp./Pro. Prod. - 58
 Shigma/Ono Soki C. Ltd. - 189
 Shogyo International Corp. - 30, 117, 154,
 194, 199
 SHURE BROTHERS, INC. - 150, 154, 164, 184
 Siedle Communication Sys of America - 89
 Sieler Design Products - 175
 Siemens Hearing Instruments - 84
 Sierra Video Systems - 173
 Sight & Sound Entertainment - 67
 Signal Cable Company - 194, 199
 Silent Watchman - 30
 Simpson Electric - 189
 Sims Vibration Dynamics - 24
 SL Waber Inc. - 176
 SMC International, Inc. - 62
 Sola - 176
 SoliCo/mec - 194
 Solid State Systems - 185
 Soltec Corp. - 189
 SONANCE - 40, 51, 79, 112, 128,
 137, 140, 176, 177, 194, 199
 Sonex Acoustical Prod./Illbruck Inc - 24
 Sonic Research Assoc. - 51
 Sonic Systems Inc. - 128
 SonIn Inc. - 79
 Sonitrol - 30
 SonoMask Systems, Inc. - 181
 SONY CORP. OF AMERICA, A/V PRODUCTS -
 30, 58, 72, 103, 147, 185
 Sony Corp./Business & Pro. Aud. Grp. -
 58, 62, 72, 74, 82, 150, 154, 164, 173, 185
 Sony Security Systems - 72
 Sound Absorbent Materials Co. Inc. - 24
 Sound Advice - 158
 Sound Control Technologies, Inc. - 58, 185
 Sound Designers Studio - 67, 164
 SOUND DEVELOPMENT INDUSTRIES -
 129, 137, 140, 181
 Sound Powered Communications - 82
 Sound Quest - 194
 Sound Technology, Inc. - 189
 Sound-Craft Systems, Inc. - 58
 Soundcraft - 164
 Soundcraftsmen - 40
 Soundforms International - 24
 Soundhour Electronics - 129
 Soundings Electrotec, Inc. - 51
 SoundScape Speakers, Inc. - 117
 Soundsmith, Inc. - 89
 Soundstream Technologies - 40, 51, 58, 117,
 173, 177, 195
 SoundTech - 129
 Soundtracs PLC - 164
 Soundwall Corp. - 58
 Southwest Microwave, Inc. - 72
 Spatial Sound, Inc. - 51, 164
 SpeakerCraft - 129
 Speco - 117
 Spectra Sonics - 51
 Spectronics - 30
 Sphere Electronics - 165
 SPM Instrument - 189
 Square D/Topaz Products - 176
 St. Louis Music - 40
 STA - Sky-Tracker of America - 72
 Stagecraft Lighting - 74
 Stancor Div. White-Rodgers - 195
 Standard Tape Laboratory, Inc. - 189
 Standard Wire & Cable Co. - 195
 Stanford Acoustics(Sammi Snd. Tech) - 117
 Stanley Hirsch Associates Inc. - 154
 Stanton Elec. div. Stanton Magnetic - 74
 Star Case Manufacturing Co., Inc. - 67
 Starkey Labs & Telecommunications - 82
 STENTOFON COMMUNICATIONS, INC. -
 30, 89, 92, 98, 100, 105,
 107, 108, 170, 173
 Stewart Electronics - 40, 51
 Stewart Filmscreen Corporation - 58
 Stor-Com Inc. - 103
 Structural/Kinematics - 189
 Studer Revox America, Inc. - 62, 129, 165, 185
 Studio Technologies, Inc. - 51, 107
 STUDIOMASTER INC. - 40, 51, 158, 165, 170, 175
 Summa Technologies - 75
 Surveillance Video Systems - 72
 Swanson Analysis Systems, Inc. - 180
 Swintek Enterprises, Inc. - 92
 Switchcraft, Inc. Components Div. - 195
 Symco - 72
 Symetrix Inc., 52
 Synergistics, Inc. - 30
 Systems Design Associates - 52
 Systems Wireless, Ltd. - 82, 92, 100,
 105, 108, 150
 T-S-K ELECTRONICS, INC. - 30, 100, 103,
 108, 109, 137
 T.C. Electronic of Denmark - 52

- TA Instrument Case - 67
 Tag-It Division, Peter Mangone, Inc. - 195
 TALK-A-PHONE CO. - 30, 87, 89, 92, 98, 100, 103, 108, 109, 140, 179
 Tannoy - TGI North America Inc., 129
 Tape-Athon - 62
 Tappan Wire & Cable - 195
 TARGET TECHNOLOGY, INC. - 58
 Tascam - 165
 Taylor-Simtec Digital - 176
 TDM Design Inc. - 52
 Teatronics/Lighting Innovations - 177
 Technical Acoustics, Inc. - 58
 Technical Audio Devices (TAD) - 140
 Technical Projects, Inc. - 82, 105
 Technics Audio Products - 75
 Techron, div. Crown International - 189
 Teclab - 67
 TEI Electronics Inc. - 40, 52, 72, 75, 79, 113, 117, 195
 Teknicom Sales Co., Inc. - 92
 TEKSTONE SOUND & SIGNAL MFG. - 90, 98
 Tektronix Signal Analysis Unit - 190
 Tel-E-Tel Corp. - 72
 Tel-Tron - 109
 TELECALL AMERICA - 30, 90, 92, 98, 100, 104, 105, 108
 Teleconferencing Systems Int'l Inc. - 185
 Telecor Inc. - 104
 Teddyne Thermatics - 197
 TeleMatic - 197
 Telemetry Inc. - 72
 Telephone Components - 58
 Television Equipment Assoc., Inc. - 82
 Television Technology Corp. - 147
 TELEX COMMUNICATIONS, INC. - 31, 58, 75, 83, 86, 92, 101, 104, 105, 108, 150, 154, 175
 Telos Systems - 185
 Tentel Corp. - 190
 Texwipe - 79
 The Aeroacoustic Corp. - 24
 The Auth Company Inc. - 31
 The Music People, Inc. - 75, 83, 117, 130, 150, 154
 The Proudfoot Co, Inc. - 24
 The Q Line Corporation - 113
 The Sandell Company - 83, 150, 156
 The Soundcoat Company - 24
 Thermocon Products - 24
 Thermodyne International Ltd. - 67
 Thorn Automated Systems, Inc. - 31
 Time & Sound - 31
 TMB Assoc. - 197
 TOA ELECTRONICS, INC. - 41, 52, 59, 76, 84, 87, 90, 92, 99, 101, 104, 105, 113, 118, 130, 138, 140, 147, 150, 156, 165, 171, 175, 183
 Total Audio Concepts - 165
 Tracom - 76
 Transcience - 31
 Triad Speakers, LPC, Inc. - 138
 Trident Audio USA - 165
 Trigon Electronics, Inc. - 31
 Trimm Inc. - 173
 Tripp Lite - 176
 Trompeter Electronics - 197
 Trouper Industries, Ltd. - 197
 TSI (Tamco Systems Inc.) - 59, 156, 173, 177, 185
 Turbosound/ div. of AKG Acoustics - 130
 U.S. Audio - 41
 Uher of America - 62
 UHF Associates - 72
 Ultimate Support Systems, Inc. - 67
 Ultrak - 108
 Underwater Kinetics - 67
 Unex Corp. - 84
 Uni-Screen, Inc. - 59
 United States Gypsum - 24
 Universal Electronics Inc. - 118
 UNIVERSITY SOUND INC. - 41, 113, 118, 138, 140, 156, 171
 Uptown Technologies, Inc. - 173
 UREI/JBL Professional - 41, 52, 130
 Usatco (Universal Satellite Corp.) - 72
 USD Products - 197
 Utah Scientific, Inc. - 173
 Vaco Products - 67
 Valcom Inc. - 140
 Valley International Inc. - 60
 Van Etten Audio Labs - 41
 VanSan Corp. - 60
 Varitronics Inc. - 179
 VCS - 72
 Vega - 150
 Ventronic, Inc. - 73
 Vertigo Recording Products - 190
 Vestax Pro Audio - 76
 Vibration Specialty Corp. - 190
 Vibration Technology Ltd. - 41
 Vicon Industries Inc. - 73
 Video Accessory Corp. - 60
 Video Design Pro - 180
 Video Link - 22, 31, 60, 73, 138, 177
 Video Resources - 73
 Videolarm, Inc. - 73
 Videoplex, Inc. - 73
 Vidlicraft - 84
 Vidikron of America - 60
 VIF International - 62
 Viking Cases - 67
 Vikonics Inc. - 31
 Vis A Com - 179
 Visiplex Communications - 99
 Vista Group International Inc. - 86
 Visual Methods Inc. - 31, 73
 VIZ Test Equipment - 190
 Wadla Digital Corp. - 52, 199
 Waldom Electronics - 113, 118
 Ward-Beck Systems - 165
 Wavetek San Diego - 190
 Weircliffe Degaussers/div of Paltex - 60
 Wenger Corp. - 67
 Wescom - 99
 Wesflex - 197
 WEST PENN WIRE CORP. - 197, 199
 Westell - 185
 Westlake Audio - 130
 Westpark Communications - 190
 Wexler Music Co. (David Wexler & Co.) - 118
 Wharfedale Loudspeakers Ltd. - 131
 WHEELLOCK, INC. - 31, 41, 109, 113, 118, 138, 140, 147, 171, 179
 Whelen Engineering Company - 140
 Whirlwind - 199
 White Instruments, div. C Van R Inc. - 52
 Whitenton Industries - 176
 Wilco Communications - 199
 William Bal Corp. - 67
 Williams Sound Corp. - 86, 151
 Wiltron - 190
 Winsted Corp. - 67
 Wireless Technology, Inc. - 31, 73, 177
 Wireworks Corp. - 199
 Wissco - 151, 175
 Wohler Technologies - 131, 173, 190
 Workman Electronic Products - 131
 Wright Microphones - 156
 Wyle-Electronic Enclosures - 67
 Xedit Corp. - 60
 Xetron Corp. - 31
 YAMAHA CORP. OF AMERICA - 41, 52, 76, 84, 131, 156, 165, 171
 Yorkville Sound, Inc. - 171
 Zero Stantron - 68
 Zeta Music Systems - 52
 Zonic A & D Co. - 190
 Zoom Corp. - 52

INDEX OF TRADE NAMES

- A.T.A. Cases-----Jan-AI Cases
 Accutrex-----Franklin Instrument/Time Systems
 ACOustical Interface Sys-----ACO Pacific, Inc.
 Acousticlan-----Waldom Electronics
 Ampeg-----St. Louis Music
 Ampli-Vox-----Perma Power Electronics, Inc.
 Ampicenter-----Harris Corp., Dracon Div.
 Ampro-Scully-----Television Technology Corp.
 ANSYS-----Swanson Analysis Systems, Inc.
 Architectural Acoustics-----PEAVEY ELECTRONICS CORP.
 Astatic-----CTI Audio, Inc.
 Audio Centron-----St. Louis Music
 Audlocom-----TELEX COMMUNICATIONS, INC.
 Audsco-----Audio Systems Co.
 AutoCAD Release 11-----Autodesk Inc.
 Ballade-----Dynaware USA, Inc.
 Burnsed & Bradford System-----B & B Systems, Inc.
 C-Ducer Microphones-----C-T Audio
 Cinema Digital Sound-----Optical Radiation Corporation
 Cloudrite-----MBI Metal Building Interior Prod Co
 Colorsonix-----MBI Metal Building Interior Prod Co
 Command-----Richmond Sound Design Ltd.
 Communitron-----Stor-Com Inc.
 Concept Speaker Systems-----Headwater USA
 Confidencer-----Roanwell Corp.
 Conneaut Audio Devices-----CTI Audio, Inc.
 Crate-----St. Louis Music
 CrowdComp-----LynTec
 Cue-----Richmond Sound Design Ltd.
 DADCO-----Door Alarm Devices Corp.
 Daflex, Dafion-----Daburn Electronics and Cable Corp.
 Danyon, Dalite-----Daburn Electronics and Cable Corp.
 Diagnostic Instruments-----Scantek, Inc.
 DynaPerspective-----Dynaware USA, Inc.
 Ektacom-----Fisher Berkeley Corporation
 Electro-Mech Imagneering-----EMI
 Electro-Voice-----Electro-Voice
 Entraguard-----MARLEE ELECTRONICS
 Express Link-----LaBelle Display Sciences Group
 Fane Acoustics-----Acoustical Supply International
 FlatStack-----Microtran Company
 Flexible Arm Co.-----Stanley Hirsch Associates Inc.
 Fox's Rack 'N' Roll-----Sound Designers Studio
 Genelec-----Drawmer/QMI
 Gerraudio Dist. Inc.-----GERR Electro Acoustics Ltd.
 Gold Ribbon Sound-----Soundwall Corp.
 Hartke Systems-----Samson Technologies Corp.
 HME-----HM ELECTRONICS, INC.
 Intervox-----International Components Corp.
 Jersey Specialty Company-----JSC Wire & Cable
 Knoll-----Knoll Systems
 Lipsner-Smith Co.-----RTI-Research Technology Int'l
 MARK 5M-----Franklin Instrument/Time Systems
 McKenzie-----Waldom Electronics
 Mic-Eze-----Ac-cetera Inc.
 Microloop-----OVAL WINDOW AUDIO
 Micropass-----Racon, Inc.
 Millennium-----LEE DAN COMMUNICATIONS, INC.
 Miniloop-----OVAL WINDOW AUDIO
 Mobllpage-----Midwest Electronic Industries
 Mogami-----BI-Tronics, Inc.
 Mogami-----Marshall Electronics Inc.
 MultiVox-----MaxiVox
 Muscle Magnet Series-----Universal Electronics Inc.
 Noisebuster-----The Proudfoot Co., Inc.
 Norsonic-----Scantek, Inc.
 Notcoschow-Wright-----Acoustical Supply International
 NSO-----RTI-Research Technology Int'l
 Ohm (UK) Industries-----Headwater USA
 Omnicraft Noisegates-----C-T Audio
 P-Tec-----Harris Corp., Dracon Div.
 Pacific-----Knoll Systems
 Page Pac-----Harris Corp., Dracon Div.
 Patchprints-----Patch Bay Designation Co.
 Performance Automation-----Sound Designers Studio
 Plenair-----Teledyne Thermatics
 PowerRite-----Deltac Electronics Corp.
 PowerVoucher-----LynTec
 R2-----Lucasfilm Ltd./THX Group
 RCF-----Acoustical Supply International
 Redline-----MISCO/Minneapolis Speaker Co., Inc.
 Relchenbach Engineering-----Bauer Communications Inc.
 Reliable Security Systems-----Doorguard Systems, Inc.
 Rhino-----Jan-AI Cases
 Ring-Master-----RING COMMUNICATIONS INC.
 Rion Instruments-----Scantek, Inc.
 Rip-Tie Cable Wrap-----Seam-Tech
 Rogar Case Co.-----A & S Case Company
 ROH-----PORTLAND INSTRUMENT CORP.
 RTS Systems-----TELEX COMMUNICATIONS, INC.
 Rubber-Neck-----Ac-cetera Inc.
 s, Inc.-----B & B Systems, Inc.
 San Pan-----MBI Metal Building Interior Prod Co
 ServoDrive Subwoofers-----Intersonics, Inc.
 Shrink Wrap Systems-----Seal-O-Matic Co.
 Silentflow-----The Aeroacoustic Corp.
 Silentroom-----The Aeroacoustic Corp.
 Sockets-Plus-----Perma Power Electronics, Inc.
 Sound Enhancement-----TELEX COMMUNICATIONS, INC.
 Soundblox-----The Proudfoot Co., Inc.
 Soundsphere-----Sonic Systems Inc.
 Spiral Metal Prod.-----Stanley Hirsch Associates Inc.
 Splitform-----Microtran Company
 Stik Klip, TI Tite-----Daburn Electronics and Cable Corp.
 Superloop-----OVAL WINDOW AUDIO
 SVS-----Surveillance Video Systems
 Swemar-----Leader Instruments Corp.
 Tajimi-----Marshall Electronics Inc.
 Tapechek,RTI-----Research Technology Int'l
 Taperwire-----PORTLAND INSTRUMENT CORP.
 Tec Lab-----Kalamazoo Technical Furniture Inc.
 Technicart-----Leader Instruments Corp.
 Technics-----Oz Electronics, Inc.
 Tele-Imager-----Northern Information Technology Inc
 TeleVox-----MaxiVox
 Touchmaster Intercom-----Soundsmith, Inc.
 Transwave-----Schell Electronics, Inc.
 Uniprise-----Stanley Hirsch Associates Inc.
 Van-Guard-----LEE DAN COMMUNICATIONS, INC.
 Video Sentry PanTilt-----Alphone Corp.
 Video-Dex-----Gaslight Video
 Visual Pager-----Microframe Corporation

CONTRACTORS

SEPTEMBER							DECEMBER						
S	M	T	W	T	F	S	S	M	T	W	T	F	S
1	2	3	4	5	6	7	1	2	3	4	5	6	7
8	9	10	11	12	13	14	8	9	10	11	12	13	14
15	16	17	18	19	20	21	15	16	17	18	19	20	21
22	23	24	25	26	27	28	22	23	24	25	26	27	28
29	30						29	30	31				

OCTOBER							JANUARY						
S	M	T	W	T	F	S	S	M	T	W	T	F	S
		1	2	3	4	5				1	2	3	4
6	7	8	9	10	11	12	5	6	7	8	9	10	11
13	14	15	16	17	18	19	12	13	14	15	16	17	18
20	21	22	23	24	25	26	19	20	21	22	23	24	25
27	28	29	30	31			26	27	28	29	30	31	

NOVEMBER							FEBRUARY						
S	M	T	W	T	F	S	S	M	T	W	T	F	S
					1	2							1
3	4	5	6	7	8	9	2	3	4	5	6	7	8
10	11	12	13	14	15	16	9	10	11	12	13	14	15
17	18	19	20	21	22	23	16	17	18	19	20	21	22
24	25	26	27	28	29	30	23	24	25	26	27	28	29

ASSOCIATIONS

American Institute of Architects (AIA)

1735 New York Ave., NW
Washington D.C. 20006
(202) 626-7300

American National Standard Institute (ANSI)

11 West 42nd St.
New York, NY 10036
(212) 354-3300

Audio Engineering Society (AES)

60 East 42nd St., Suite 2520
New York, NY 10165
(212) 661-8528

Custom Electronic Design & Installation Association (CEDIA)

10400 South Roberts Rd., Suite D
Palos Hills, IL 60465
(800) CEDIA-30

Electronics Distribution (EDS)

222 South Riverside Plaza, Suite 2710
Chicago, IL 60606
(312) 648-1140

Electronics Industries Association (EIA)

2001 Pennsylvania Ave., NW
Washington D.C. 20006
(202) 457-4900

Electronics Technicians Associations (ETA)

602 North Jackson St.
Greencastle, IN 46135
(800) 359-6706

International Association of Auditorium Managers (IAAM)

325 Central Ave., Suite 225

White Plains, NY 10606
(914) 683-1000

International Business Music Association (IBMA)

280 Federal Ave.
NW Massillon, OH 44664
(216) 833-4164

International Communications Industries Association (ICIA)

3150 Spring St.
Fairfax, VA 22031
(703) 273-7200

International DJ Expo

25 Willowdale Ave.
Port Washington, NY 11050
(516) 767-2500

Institute of Electrical & Electronics Engineers (IEEE)

445 Hoes Lane
Piscataway, NJ 08855-1331
(212) 705-7900

International Security Conference

1350 East Touhy Ave.
Des Plaines, IL 60018
(708) 299-9311

International Society of Certified Electronics Technicians (ISCET)

2708 West Berry St.
Fort Worth, TX 76109
(817) 921-9101

International Teleproduction Society

990 6th Ave., Suite 21E
New York, NY 10018
(212) 629-3266

EVENTS

SEPTEMBER 1991

IBMA
9/11 — 9/14
Palm Springs, CA

NAB
9/11 — 9/14
San Francisco, CA

OCTOBER 1991

SBE
10/2 — 10/5
Houston, TX

AES
10/4 — 10/8
New York City

CEDIA
10/9 — 10/13
San Francisco, CA

DJ EXPO
10/14 — 10/16
Orlando, FL

NECA
10/19 — 10/22
San Francisco, CA

SMPTÉ
10/26 — 10/29
Los Angeles, CA

ETA Technicians Show
10/91
Grand Island, NE

NOVEMBER 1991

NCAC
11/1 — 11/4
Houston, TX

Intelix (IEEE)
11/5 — 11/8
Kyoto, Japan

ETA
Technicians Show
11/91
Indianapolis, IN

DECEMBER 1991

GlobeCom
(IEEE)
12/2 — 12/5
Phoenix, AZ

JANUARY 1992

CES (EIA)
1/9 — 1/12
Las Vegas, NV

NAMM
1/17 — 1/19
Anaheim, CA

NSPE
1/19 — 1/25
Charleston, SC

FEBRUARY 1992

Infocomm (ICIA)
2/6 — 2/8
Washington D.C.

EVENTS

SMPTE
2/7 — 2/8
Detroit, MI

ISC
2/11 — 2/13
Las Vegas, NV

MARCH 1992

AES
3/24 — 3/27
Vienna, Austria

APRIL 1992

NAB
4/13 — 4/16
Las Vegas, NV

NCSA
4/27 — 4/29
Anaheim, CA

MAY 1992

DJ EXPO
5/2 — 5/8
Los Angeles, CA

EDS
5/5 — 5/7
Las Vegas, NV

NABER
5/6 — 5/9
Washington D.C.

NFPA
5/18 — 5/21
New Orleans, LA

CES (EIA)
5/30-6/2
Chicago, IL

NCAC
5/92
Salt Lake City, UT

JUNE 1992

AIA
6/19 — 6/22
Boston, MA

ETA
6/92
Location TBA

JULY 1992

NFLCP
7/15 — 7/19
St. Paul, MN

NSPE
7/19 — 7/25
Oakbrook, IL

ITS
7/92
Los Angeles, CA

CALENDAR

MARCH							JUNE						
S	M	T	W	T	F	S	S	M	T	W	T	F	S
1	2	3	4	5	6	7	7	8	9	10	11	12	13
8	9	10	11	12	13	14	14	15	16	17	18	19	20
15	16	17	18	19	20	21	21	22	23	24	25	26	27
22	23	24	25	26	27	28	28	29	30				
29	30	31											

APRIL							JULY						
S	M	T	W	T	F	S	S	M	T	W	T	F	S
			1	2	3	4	5	6	7	8	9	10	11
5	6	7	8	9	10	11	12	13	14	15	16	17	18
12	13	14	15	16	17	18	19	20	21	22	23	24	25
19	20	21	22	23	24	25	26	27	28	29	30	31	
26	27	28	29	30									

MAY							AUGUST						
S	M	T	W	T	F	S	S	M	T	W	T	F	S
					1	2	2	3	4	5	6	7	8
3	4	5	6	7	8	9	9	10	11	12	13	14	15
10	11	12	13	14	15	16	16	17	18	19	20	21	22
17	18	19	20	21	22	23	23	24	25	26	27	28	29
24	25	26	27	28	29	30	30	31					
31													

ASSOCIATIONS

National Association of Broadcasters (NAB)
1771 N St., NW
Washington, D.C. 20036-2891
(202) 429-5300

National Association of Business & Educational Radio (NABER)
1501 Duke St.
Alexandria, VA 22314
(703) 739-0300

National Association of Music Merchants (NAMM)
5140 Avenida Encinas
Carlsbad, CA 92008
(619) 438-8001

National Association of Radio & Telecommunications Engineers (NARTE)
P.O. Box 678
Medway, MA 02053
(508) 533-8333

National Council of Acoustical Consultants (NCAC)
P.O. Box 359
Springfield, NJ 07081
(201) 379-1100

National Electronics Contractors Associations (NECA)
7315 Wisconsin Ave., Suite 1300W
Bethesda, MD 20814
(301) 657-3110

National Federation of Local Cable Programmers (NFLCP)
P.O. Box 27290
Washington, D.C. 20038
(202) 393-2650

National Fire Protection Association (NFPA)
Batterymarch Park
Quincy, MA 02269
(617) 770-3000

National Satellite Dealer Coalition
P.O. Box 973
Camden, AK 71701
(800) 765-8938

National Society of Professional Engineers (NSPE)
1420 King St.
Alexandria, VA 22314
(703) 684-2800

Society of Broadcast Engineers (SBE)
P.O. Box 20450
Indianapolis, IN 46220
(317) 842-0836

Society of Motion Picture & Television Engineers (SMPTE)
595 West Hartsdale Ave.
White Plains, NY 10607
(914) 761-1100



Aphex Systems

11068 Randall Street
Sun Valley, CA 91352
(818) 767-2929 FAX: (818) 767-2641
President: Marvin Caesar; Vice President:
Hugh Wilcox; Sales Manager: Paul
Freudenberg
Gould Marketing, Inc., Montreal, Quebec,
514-342-4441
Clueco Pro Division, Paris, France,
331-43596159
AKG Acoustics, Munich, Germany,
498-9 87 160
Otaritec Corporation, Tokyo, Japan,
813-392-7811
Sound Technology, Letchworth, UK
444-62480800
Nova Marketing, San Francisco, CA
415-952-0943
PRODUCTS: audio interfaces

ATI-Audio Technologies Inc.

328 W. Maple Avenue
Horsham, PA 19044
(215) 443-0330 FAX: (215) 443-0394
President: Samuel B. Wenzel; Vice President:
Edward M. Mullin
PRODUCTS: audio interfaces

Banner Magnetics - Toroids

P.O. Box 1803
Shelby, NC 28151
(704) 487-7012
General Manager: John Dellinger
Doug Warren, Newport News, VA 804-930-3217
PRODUCTS: transformers



Bauer Communications Inc.

6887 Farndale Ave., Bldg. 12
N. Hollywood, CA 91343
(818) 891-9983 (800) 627-7277
FAX: (818) 894-0715
President: Jim Bauer
Doug Warren, Newport News, VA 804-930-3217
PRODUCTS: direct boxes, audio interfaces,
transformers

Benchmark Media Systems, Inc.

5925 Court Street Rd.
Syracuse, NY 13206-1707
(315) 437-6300 (800) 262-4675
FAX: (315) 437-8119
President: Allen H. Burdick; Sales Manager: R.

Rory Rall; Operations Manager: Mark A.
Potterbaum
Nova Marketing, San Francisco, CA
415-952-0943
PRODUCTS: audio interfaces

Bourns Inc.

1200 Columbia Ave.
Riverside, CA 92507
(714) 781-5071 FAX: (714) 781-5174

Clarostat Mfg.

1 Washington St.
Dover, NH 03820
(603) 742-1120 FAX: (603) 742-0481

Communications Company, Inc.

3490 Noell St.
San Diego, CA 92110
(619) 297-3261 FAX: (619) 297-3279
Executive Vice President: Michael Jordan;
Engineering/Manufacturing: David Johnson;
Order Desk: Bobby Willis; Shipping: Rich Willis;
President: Peter Jordan
Audio Marketing Associates, Brecksville, OH
216-526-2426
Bencslk Associates, Ocala, FL 904-732-9775
Secom Systems, Dorrville, GA 800-241-9409
Peregrine SW Reps., Houston, TX
713-589-8481
Western Audio Sales, Glendale, CA 818-246-3806
Audio Etc., St. Peters, MO 314-278-4130

Comsec

3619 East 4th Ave.
Vancouver, BC V5M 1M2
(604) 298-4177 FAX: (604) 298-0951
Audio Etc., St. Peters, MO 314-278-4130

EDCOR ELECTRONICS

7130 National Parks Hwy
P.O. Box 5098
Carlsbad, NM 88220
(505) 887-6790 (800) 854-0259
FAX: (505) 887-6880
Sales: P. Weston; Engineering: Brian Weston
Greg Dzubay & Assoc., Glendale, AZ
800-999-0006
PRODUCTS: direct boxes, transformers

ESE

142 Sierra Street
El Segundo, CA 90245
(213) 322-2136 FAX: (213) 322-8127
President: Jerry Johnson; Vice President/Sales
Manager: Bob Mayers; Marketing Manager:
Brian Way; General Manager: Bill Kaiser
Cambridge Marketing, Westerville, OH
614-363-9191
PRODUCTS: audio interfaces

FSR Inc.

244 Bergen Boulevard
West Paterson, NJ 07424
(201) 785-4347 (800) 332-3771
FAX: (201) 785-3318
President: William G. Fitzsimmons; Vice
President: Janice Sandri; Engineering
Manager: Joseph Fischer; Special Projects
Manager: John Macaluso; Manager, Metal
Products: Joseph Amico
Sigmat Corporation, Valley Forge, PA
215-783-6666
Peregrine Southwest, Houston, TX
713-589-8481
Henry W. Phillips Inc., Roswell, GA 404-992-3070
Piper and Glvan Associates, Needham, MA
617-449-1144

Design Factors, Hacienda Hts., CA 213-697-7576
Cambridge Marketing, Westerville, OH
614-363-9191
PRODUCTS: audio interfaces, transformers

Heath

Hilltop Rd.
St. Joseph, MI 49085

Henry Engineering

503 Key Vista Drive
Sierra Madre, CA 91024
(818) 355-3656 FAX: (818) 355-0077
Owner: Hank Landsberg
Allied Broadcast Equip. Inc., Richmond, IN
800-622-0022
Broadcast Supply West, Tacoma, WA
800-426-8434
Bradley Broadcast Sales, Gaithersburg, MD
800-732-7665
Broadcasters General Store, Ocala, FL
904-622-9058
P.A.S., Ft. Worth, TX 817-483-7474
ADCOM, Toronto, ON 416-251-3355
PRODUCTS: audio interfaces

Impart

2225 4th Ave.
Seattle, WA 98121
(206) 728-0184

Industry West Electronics

270 N. Geneva Rd.
Orem, UT 84057
(801) 226-1000 FAX: (801) 226-3268
President: Darold Francis; Director of
Marketing: Jay Simmons; Engineer: Chris
Poulson
PRODUCTS: direct boxes

J.W. DAVIS AND CO.

3030 Canton Street
Dallas, TX 75226
(214) 651-7341 (800) 527-5705
FAX: (214) 939-0328
President: Harvey Earp; Vice President, Sales:
Jack W. Tucker; Chief Engineer: Eric Simonson
Multi-Technical Reps., Brainerd, MN
218-828-9483
PRODUCTS: transformers

JENSEN TRANSFORMERS INC.

10735 Burbank Blvd.
North Hollywood, CA 91601
(213) 876-0059 FAX: (818) 763-4574
President: Bill Whitlock; Vice President,
Engineering: Steve Hogan; Vice President,
Operations: Dave Hill
C.B. Electronic Marketing, Arvada, CO
303-422-0561
PRODUCTS: audio interfaces, transformers

Lightronics

789 Seahawk Circle
Virginia Beach, VA 23452
(804) 427-0852

Littlite/ CAE Inc.

10087 Industrial Drive
P.O. Box 430
Hamburg, MI 48139
(313) 231-9373 FAX: (313) 231-1631
President: James Fackert; General Manager:
Robert Bergman; Sales Manager: Fred
Mikeska; Sales and Marketing: Sharon Suffolk
J.B. Parent, Dublin, OH 614-764-0064
PRODUCTS: lights

Mag-Tags Inc.

2531 W. Tharpe
Tallahassee, FL 32303
(904) 386-5611 (800) 677-8247
FAX: (904) 385-5710
Owner: Alan Pippenger; CEO: Carolyn Pippenger;
National Sales Manager: Sondra Hoover
Multi-Technical Reps., Brainerd, MN
218-828-9483

Meridian Technologies, Inc.

80 Mott Avenue
Inwood, NY 11696
(516) 371-9300 FAX: (516) 371-9301
President: Robert Klein; Director of Engineering: Jack Krol
Doug Warren, Newport News, VA 804-930-3217
PRODUCTS: audio interfaces

MG Electronics

32 Ranick Road
Hauppauge, NY 11788
(516) 582-3400 FAX: (516) 582-3229
President: Elliott Maltz; National Sales Manager: Stan Grey; Asst. Sls. Mgr., Comm. Sound: Herb Woll; CEM Sales Manager: John Kibbitt; Credit Manager: Rita McIberger; Customer Service: Sue Novak
Loomis and Associates, Fremont, CA
415-683-0883
PRODUCTS: transformers

Niles Audio

P.O. Box 160818
Miami, FL 33116
(305) 238-4373 FAX: (305) 238-0185
President: Ivan Zuckerman; Vice President: Janice Zuckerman; National Sales Director: Paul Collins; Customer Service Manager: Connie Peters; Dir. Sls. Training/Tech Sup.: Gary Burke; Technical Support: David Aleilo
Camden Marketing, Pierre Fonds, QU
514-683-3377
PRODUCTS: direct boxes, audio interfaces, transformers

Parsons Mfg. Corp.

1055 O'Brien Dr.
Menlo Park, CA 94025
Sales Manager: Steve Wurzer
Camden Marketing, Pierre Fonds, QU
514-683-3377

Paso Sound Products, Inc.

14 First Street
Pelham, NY 10803
(914) 738-4800 (800) 231-3034
FAX: (914) 738-3954
Executive Vice President: Paul Mastrangelo;
Product Manager: Ken O'Brien; Credit Manager: Marilyn Beckerson; Operations Manager: Anthony Squeglla
Anderson Sales, Braintree, MA 617-848-9194
Jack Mesnick Sales, Liverpool, NY 315-622-3211
Palmer Associates, Fairfield, NJ 201-882-1266
Weller Electronic Sales, Inc., Worthington, OH 614-885-7819
Lienau Associates, Columbia, MD 301-621-4113
MJA Marketing, St. Charles, MO 314-447-7111
Northland Assoc., Moorehead, MN 218-233-4616
Allwest Sound & Communication, Camarillo, CA 805-388-7745
Dimension Pt. IX Marketing, Katy, TX 713-578-9277
Mountain Representatives, Denver, CO 303-333-7745
Miguel Lopez, Hialeah, FL 305-822-6853
Paco Electronics, Ltd., Markham, ON 416-475-0740
Robert Milsk Co., Southfield, MI 313-354-3310
Marketline Inc., Snellville, GA 404-972-9048
Hawkins-Fredrickson Assoc., Maitland, FL 407-831-2474
Lintern Associates, Naperville, IL 708-904-1225
Robert Milsk Co., Indianapolis, IN 317-842-3400
PRODUCTS: transformers

PEAVEY ELECTRONICS CORP.

711 A Street
P.O. Box 2898
Meridian, MS 39301
(601) 483-5365 FAX: (601) 484-4278
CEO: Hartley Peavey; President: Mella Peavey
Dimension/ Point IX, Lewisville, TX
214-436-3706
PRODUCTS: direct boxes, audio interfaces, transformers, lights

Penny & Giles, Inc.

2716 Ocean Park Blvd., #1005
Santa Monica, CA 90405-5209
(310) 393-0014 FAX: (310) 450-9860
Sales Office Supervisor: Neal Handly; Sales Assistant: Shaleen Melwani
Dimension/ Point IX, Lewisville, TX
214-436-3706

Protech Audio Corporation

Flowerfield Bldg. 1
St. James, NY 11780
(516) 584-5855 FAX: (516) 584-5904
Director of Marketing: Bill Murphy; Sales Engineering: Joseph Glambone
Peregrine Southwest Reps, Houston, TX 713-589-8481
First Choice Marketing, Seattle, WA 206-524-7344
Dimension/ Point IX, Lewisville, TX 214-436-3706
PRODUCTS: transformers

R.B. Annis Co, Inc.

1101 N. Delaware Street
Indianapolis, IN 46202
(317) 637-9282 FAX: (317) 637-9282
President: R.B. Annis; Production Manager: R.D. Hudson; Secretary: B. Hamdrick
Audio Etc., St. Peters, MO 314-278-4130

Rapco International Inc.

Route 1, Box 50
Jackson, MO 63755 (800) 467-2726
FAX: (314) 243-1384
Chief Executive Officer: Peter Marsac; National Sales Manager: Mike Torbet
J.B. Parent, Dublin, OH 614-764-0064
PRODUCTS: direct boxes, audio interfaces, transformers, lights

**Order More
Blue Books
Now!**

MATCH IT! IF YOU CAN

- Top Quality Specifications
- Bi-directional Interface
- Front Panel Gain Adjustments and Power Indicator
- Rugged, All Metal Enclosure
- Single or Dual Rackmount
- Internal Power Supply

\$179

Audio Level and
Impedance Interface

**ES-244****PRACTICAL SOLUTIONS FOR 19 YEARS**

142 SIERRA ST., EL SEGUNDO, CA 90245 • (213) 322-2136

Circle 284 on Reader Response Card

RCI Systems, Inc.

5615 Fishers Lane
Rockville, MD 20852
(301) 984-1800 (800) 765-4RCI
FAX: (301) 984-6175

President: Jay W. Klingery; East Coast Audio
Rep.: Brian K. Gross; Midwest Audio Rep.:
Gordon Jacobs; West Coast Audio Rep.: Doug
Macuch; Midwest Fact. Rep.: Total Mktg. David
Taylor; Mid-Atlantic Fact. Rep.: Taub: Steve
Taub

Sunrise Sales Company, LaMotte, IL
815-638-2660

PRODUCTS: audio interfaces

Video Link

12950 Bradley Avenue
Sylmar, CA 91342
(818) 362-0353 (800) 843-5465
FAX: (818) 362-9506

President: Herb Seymour;
V.P. Sales and Marketing: Bill Cawfield;
Sales Manager: Larry W. Schatz;
Asst. Sales Manager: Marguerita Kiser
J.B. Parent, Dublin, OH 614-764-0064
PRODUCTS: audio interfaces

**Acoustiflex**

1300 Division St.
Plainfield, IL 60544
(815) 436-8500 FAX: (815) 436-1912
J.B. Parent, Dublin, OH 614-764-0064

Acoustone Corp.

80 Wythe Ave.
Brooklyn, NY 11211
(718) 782-5560 FAX: (718) 782-7367
President: George Backer; Production
Manager: Larry Lubliner
Sigmat Corp., Freehold, NJ 201-362-1221
Gerald Horne Assoc., Stow, MA 508-897-1741
Adams & Assoc., Greensboro, NC 919-272-6838
Levy, Grams & Lassers, Northbrook, IL
708-272-8500

Meyer & Ross, Burlingame, CA 415-348-6800
J.B. Parent, Dublin, OH 614-764-0064

PRODUCTS: dampening material, grille cloth,
noise control panels and enclosures, wall
coverings

Alpha Audio Acoustics

P.O. Box 5403
Richmond, VA 23220
(804) 358-3852 (800) 782-5742
FAX: (804) 358-9496
President: Michael Binns
Nova Marketing, San Francisco, CA
415-952-0943
PRODUCTS: absorption, absorptive partitions,
ceiling panels, dampening material, noise
control panels and enclosures, wall coverings,
wall panels

American Acoustical Products

9 Cochituate St.
Natick, MA 01760
(508) 655-0870 FAX: (508) 651-1306
President: Richard Moody; Vice President:
Russel Moody; General Manager: Bill Statton
Ken Rodger, Golden, CO 303-431-0862
William Hibbard, Glenview, IL 708-729-9532
Preclde, Morbio Inferiore, Switzerland,
914-31734

Armstrong Cork

333 Liberty St.
Lancaster, PA 17603
(717) 397-0611 FAX: (717) 396-4426
J.B. Parent, Dublin, OH 614-764-0064

ASC/Tube Trap

245 Jackson
Eugene, OR 97401
(503) 343-9727 (800) 272-8823

**Subscribe to
Sound & Communications
Magazine**

RPG ANNOUNCES THE COMPLETE ACOUSTICAL CEILING SYSTEM

Tent Records, London

OMNIFFUSOR™

The new 2-D QRD® diffuser is based on 2-dimensional number theory sequences which provide identical performance in the horizontal and vertical planes, for truly omnidirectional coverage.



OMNIFFUSOR™



TERRACE™



Rhinosceros Recording, Sydney

NEW ACOUSTICAL CEILING

Now you can have the low installation cost of lay-in ceiling panels and the broadband sound diffusion and absorption only RPG can offer. Order the 1-D QRD® DIFFUSOR™ for controlled diffusion, the 2-D QRD® OMNIFFUSOR™ for hemispherical coverage and the ABSORBOR™ for uniform absorption, at all angles of incidence. Available in 2' x 2' and 2' x 4' standard ceiling grid sizes.



WQXR, New York

ABSORBOR™

RPG is now offering decorative upholstered single density fiberglass, SDF™, and graduated density fiberglass, GDF™, panels with resin-hardened edges in any size and fabric finish.



RPG Diffusor Systems, Inc. 12003 Wimbleton Street, Largo, Maryland 20772 Phone 301-249-5647 Fax 301-249-3912

FAX: (503) 343-9245

President, Chief Designer: Art Noxon
Adept (Mark McLean), Evansville, IN
812-424-6429
Nova Marketing, San Francisco, CA
415-952-0943

PRODUCTS: absorption, absorptive partitions, ceiling panels, dampening material, diffusion, noise control panels and enclosures, vibration isolation materials, systems, and devices, wall panels

AVL Systems, Inc.

5540 S.W. 6th Place
Ocala, FL 32674
(904) 854-1170 (800) 228-7842
FAX: (904) 854-1278

Nat. Sales Manager: Gary A. Thurston
Bencsik Associates, Ocala, FL 904-732-9775
Wilson Audio Sales, Nashville, TN 615-646-4477
Jones Audio Sales, Plano, TX 214-618-2600
C. B. Electronic Marketing, Arvada, CO
303-422-0561

John B. Anthony Company, Stamford, CT
203-322-9202

Nova Marketing, San Francisco, CA
415-952-0943

PRODUCTS: absorption, ceiling panels, diffusion, grille cloth, noise control panels and enclosures, wall coverings, wall panels

BLI

507 Canal St.
Stamford, CT 06902
(203) 325-3883

J.B. Parent, Dublin, OH 614-764-0064

Bostick

Boston St.
Middleton, MA 01949
(617) 777-0100 FAX: (508) 774-7376

Brejtus Business Environments

1329 E. University Dr.
Tempe, AZ 85281
(602) 968-1112 FAX: (602) 968-1173

President: Ron Brejtus; Sales Manager: Lisa Doughty

PRODUCTS: ceiling panels, noise control panels and enclosures, wall panels

Celotex

PO Box 31602
Tampa, FL 33631-3602
(813) 871-4811 FAX: (813) 871-4787

Controlled Acoustics Corp.

126 Kensington Oral
New Rochelle, NY 10805
(914) 576-5131 FAX: (914) 654-1869
Edwards Company, Inc., Livonia, MI
313-458-7777

Decoustics Limited

65 Disco Road
Etobicoke, ON M9W 1M2
(416) 675-3983 (800) 387-3809
FAX: (416) 675-5546
President: Claude Bagley; V.P. Sales (International): Steve Wilson; V.P. Sales (Canada): Dwight Robbins
Edwards Company, Inc., Livonia, MI
313-458-7777

Duracote Corp.

350 N. Diamond St.
P.O. Box 1209

Ravenna, OH 44266

(216) 296-9600 (800) 321-2252

FAX: (216) 296-5102

President: William R. Truog; Controller: Curtis R. Brown; Customer Service Manager: Calley E. Clause; Purchasing Agent: Allen J. Boros; Operations Manager: Richard A. Peters; Director of Research & Dev.: Robert J. Harmacek

Eckel Industries Inc.

155 Fawcett St.
Cambridge, MA 02138
(617) 491-3221 FAX: (617) 547-2171
Vice President: John W. Flood; Inside Sales: Joe McDonough

Hot House Marketing

275 Martin Ave.
Highland, NY 12528
(914) 691-6077 FAX: (914) 691-6822

President: Richard Rose
Chuck Olson Assoc., Renton, WA 206-271-5416
PRODUCTS: absorption, absorptive partitions, dampening material, grille cloth, noise control panels and enclosures, vibration isolation materials, systems, and devices, wall coverings, wall panels

Industrial Acoustics

1160 Commerce Ave.
Bronx, NY 10462
(212) 931-8000 FAX: (212) 863-1138

Korfund Dynamics

P.O. Box 235
Westbury, NY 11590
(516) 752-2453 FAX: (516) 694-6558

Leek Building Products, Inc.

507 Canal Street
Stamford, CT 06902
(203) 325-3883 FAX: (203) 359-8597
President: William A. Leek; Sales Manager: Buck Rosenfield
Audio Etc., St. Peters, MO 314-278-4130
PRODUCTS: noise control panels and enclosures

Mason Industries

350 Rabro Dr.
Hauppauge, NY 11788
(516) 348-0282 FAX: (516) 348-0279
Camden Marketing, Pierre Fonds, QU
514-683-3377

MBI Metal Building Interior Prod CO

5309 Hamilton Avenue
Cleveland, OH 44114
(216) 431-6400 FAX: (216) 431-9000
President: Bernard Zarnick; Administrative Vice Pres.: Andrew Ungar; Sales Manager: Charles Splain; Advertising Manager: Laura Zarnick
Audio Etc., St. Peters, MO 314-278-4130
PRODUCTS: absorption, absorptive partitions, ceiling panels, noise control panels and enclosures, wall coverings, wall panels

Mellotone

108 East Church Street
P.O. Box 145
Blacksburg, SC 29702
(803) 839-6341 FAX: (803) 839-2911
Vice President/ General Mgr.: Terry Bryant; Manager: DeeDee Wall

SRT Marketing, Tampa, FL 813-884-4805
Ricketts, San Leandro, CA 415-733-9250
David L. Brothers, Finksburg, MD 301-833-0920
Robert Misk and Company, Southfield, MI
313-354-5686
C.L. Pugh and Associates, Cleveland, OH
216-238-1777
Loomis and Associates, Fremont, CA
415-683-0883
PRODUCTS: grille cloth

O'Brien Partition

5301 E. 59th St.
Kansas City, MO 64130
(816) 361-2334
Camden Marketing, Pierre Fonds, QU
514-683-3377

Owens-Corning Fibrgis, Acous. Prod.

Fiberglass Tower
Toledo, OH 43659
(419) 248-8000
Camden Marketing, Pierre Fonds, QU
514-683-3377

Pittsburgh Corning

800 Presque Isle Dr.
Pittsburgh, PA 15239
(412) 327-6100 FAX: (412) 733-4815
Camden Marketing, Pierre Fonds, QU
514-683-3377

Pyrok Inc.

136 Prospect Park West
Brooklyn, NY 11215
(718) 788-1225 FAX: (718) 768-3980
Dir. Tech. Sales & Services: Howard Podolsky
Dimension/ Point IX, Lewisville, TX
214-436-3706
PRODUCTS: absorption, spray-on absorption materials, wall coverings



RPG Diffusor Systems, Inc.

12003 Wimbledon Street
Largo, MD 20772
(301) 249-5647 FAX: (301) 249-3912
President: Dr. Peter D'Antonio; Vice President: Dr. John Konnert; Marketing: Dr. Peter D'Antonio; Sales Manager: Cynthia Bonavito; Production Manager: Gene Leftwich; Advertising Manager: Veronica Coleman
RPG Europe, Surrey, England, 81-5496389
RPG Japan, Tokyo, Japan, 813-479-8878
Seabridge Audio, Huntington Bch., CA 714-374-0202
Northshore Marketing, Seattle, WA 206-284-9699
Audio Etc., St. Peters, MO 314-278-4130
PRODUCTS: absorption, absorptive partitions, ceiling panels, diffusion, noise control panels and enclosures, vibration isolation materials, systems, and devices, wall coverings, wall panels

Sims Vibration Dynamics

17724 15th Ave. N.E.
Seattle, WA 98155
(206) 362-0700
Camden Marketing, Pierre Fonds, QU
514-683-3377

Sonex Acoustical Prod./Illbruck Inc

3800 Washington Avenue, No.
Minneapolis, MN 55412
(612) 521-3555 (800) 662-0032
FAX: (612) 521-5639
Exec. Vice President: Frank L. Imkamp;
Division Manager: Russell Leighton; National
Sales Manager: Eric Johnson; Marketing
Manager: Jon Morris; Customer Service
Manager: Dolly Heckel
Cambridge Marketing, Westerville, OH
614-363-9191

Sound Absorbent Materials Co. Inc.

P.O. Box 837
Westwood, NJ 07675
(201) 742-7078
Sunrise Sales Company, LaMolle, IL
815-638-2660

Soundforms International

89 Noe St.
San Francisco, CA 94114
(415) 255-7758 FAX: (415) 986-1436
Owner: Spencer Nilsen; Owner: Phillip Neal
Comprehensive Video Supply, Northvale, NJ
201-767-7990
Coast Recording, Hollywood, CA 213-462-6058
Audio Services, Miami/Orlando, FL
800-486-6444
R.E. Snader & Assoc., Sausalito, CA 408-446-3735
Karp Communications, Tampa, FL 813-968-7098

The Aeroacoustic Corp.

169-193 Highland Parkway
Roselle, NJ 07203
(908) 241-6770 (800) 842-2376
FAX: (908) 241-9718
Vice President: Jerry Kallinger; Production
Manager: John LaMantia; Customer Service:
John Sorber
Aeroacoustic Corp., Jacksonville, FL
904-731-3577
Design Equip. Co., Audubon, PA 215-666-9770
R.C. Turner Co., Kirkland, WA 206-821-5166
R&C Air Sales, Willowbrook, IL 708-325-8540
Wilson Air Moving, Houston, TX 713-468-4383
Doug Warren, Newport News, VA 804-930-3217
PRODUCTS: noise control panels and
enclosures

The Proudfoot Co., Inc.

P.O. Box 338
Botsford, CT 06404
(203) 459-0031 (800) 445-0034
FAX: (203) 459-0033
Exec. Vice Pres./Gen. Mgr.: Michael J.
Thompson; Marketing Division Manager: Jim
Loeth; Manufacturing Division Mgr.: John
Carlillo
Camden Marketing, Pierre Fonds, QU
514-683-3377

The Soundcoat Company

1 Burt Drive
Deer Park, NY 11729
(516) 242-2200 FAX: (516) 242-2246
President: Hunter Cohen; V.P. Sales and

Marketing: Carl Wolaver; V.P. Strategic
Planning: Michel Charles; Comptroller: Lenny
Liebesman
The Soundcoat Company, Santa Ana, CA
714-979-9202
Sunrise Sales Company, LaMolle, IL
815-638-2660

Thermocon Products

2508 Marlin Hwy.
Waco, TX 76705
(817) 756-3713 FAX: (817) 753-5622
Camden Marketing, Pierre Fonds, QU
514-683-3377

United States Gypsum

101 S. Wacker Dr.
Chicago, IL 60606
(312) 606-3865 FAX: (312) 606-5864



ADI, a subsidiary of Pittway Corp.

180 Michael Drive
Syosset, NY 11791
(516) 921-6700 (800) 233-6261
FAX: (516) 921-3599
President: Steve Roth; Vice
President/Merchandising: Frank Owen;
Executive Vice President: John Bozza; Vice
President, Finance: Mike Cannatta; Vice
President, Sales: Joe Cappelletti; Director of
Marketing: Joe Moore
ADI, Los Angeles, CA 714-523-9011
ADI, Chicago, IL 312-439-9350
ADI, Clearwater, FL 813-573-1166
ADI, Philadelphia, PA 609-662-4550
ADI, Dallas, TX 214-247-5952
Cambridge Marketing, Westerville, OH
614-363-9191
PRODUCTS: access control, ancillary
components, announcement systems, audio
surveillance, burglar alarms, CCTV, door-lock
systems, duress, fire alarm, Intercom, intrusion
detection, signaling devices, sirens, smoke
detectors, strobes, vibration sensing, video
motion detection, video surveillance, wireless
systems

Adpro Pty.

P.O. Box 324
Chester, NJ 07930
(908) 879-4159
J.B. Parent, Dublin, OH 614-764-0064

Alphone Corp.

1700 130th Ave. NE
Bellevue, WA 98005
(206) 455-0510 FAX: (206) 455-0071
President: Jun Matsumoto; Vice President,
Marketing: Harry Quanz; Vice President, Sales:
Jim Morrison; Residential Sales Manager:
Stephen Birgh; Commercial Sales Manager:
John Mosebar
Alphone East Coast Reg. Office, Rochelle Park,
NJ 201-843-6115
Precide, Morbio Inferiore, Switzerland,

914-31734
PRODUCTS: access control, announcement
systems, audio surveillance, CCTV, door-lock
systems, Intercom, intrusion detection, video
surveillance

ALARM ACCESSORY LTD.

P.O. Box 212
Claymont, DE 19703
(302) 792-3620 (800) 441-7082
FAX: (302) 792-7713
President: William Holt; Operations Mgr.:
Angela Bopp
Sound Sales, Inc., Columbia, MD 301-964-1170
PRODUCTS: burglar alarms, vibration sensing

Alarm Controls Corp.

19 Brandywine Drive
P.O. Box 280
Deer Park, NY 11729
(516) 586-4220 (800) 645-5538
FAX: (516) 586-6500
Sales Manager: John Behedetto
PRODUCTS: access control, ancillary
components, announcement systems, burglar
alarms, signaling devices

Allsafe Company, Inc.

1105 Broadway
Buffalo, NY 14212
(716) 896-4515 (800) 828-7162
FAX: (716) 896-4241
President: Edwin L. Pokornowski; Vice
President: James Pokornowski; Dir. of
Engineering: Michael L. Davis
J.B. Parent, Dublin, OH 614-764-0064
PRODUCTS: access control, door-lock systems,
wireless systems

Alpha Communications

89-D Cabot Court
Hauppauge, NY 11788-3717
(516) 434-8080 (800) 666-4800
FAX: (516) 434-8334
President: Mark S. Goldberg; Vice President:
Madelyn R. Goldberg; Office Manager: Rose
Tassone
Sound Sales, Inc., Columbia, MD 301-964-1170
PRODUCTS: access control, ancillary
components, announcement systems, audio
surveillance, CCTV, door-lock systems,
Intercom, intrusion detection, signaling
devices, video surveillance

Ambeti

P.O. Box 593
Plymouth, MI 48170
(313) 455-1884
J.B. Parent, Dublin, OH 614-764-0064

Amseco

228 E. Star of India Ln.
Carson, CA 90746
(213) 538-4670 (800) 426-1096
FAX: (213) 538-9932
Vice President: Thomas R. Fessler
Amseco, Pine Brook, NJ 201-575-4433
J.B. Parent, Dublin, OH 614-764-0064

**Find Your Suppliers in the
Sound & Communications
Blue Book**

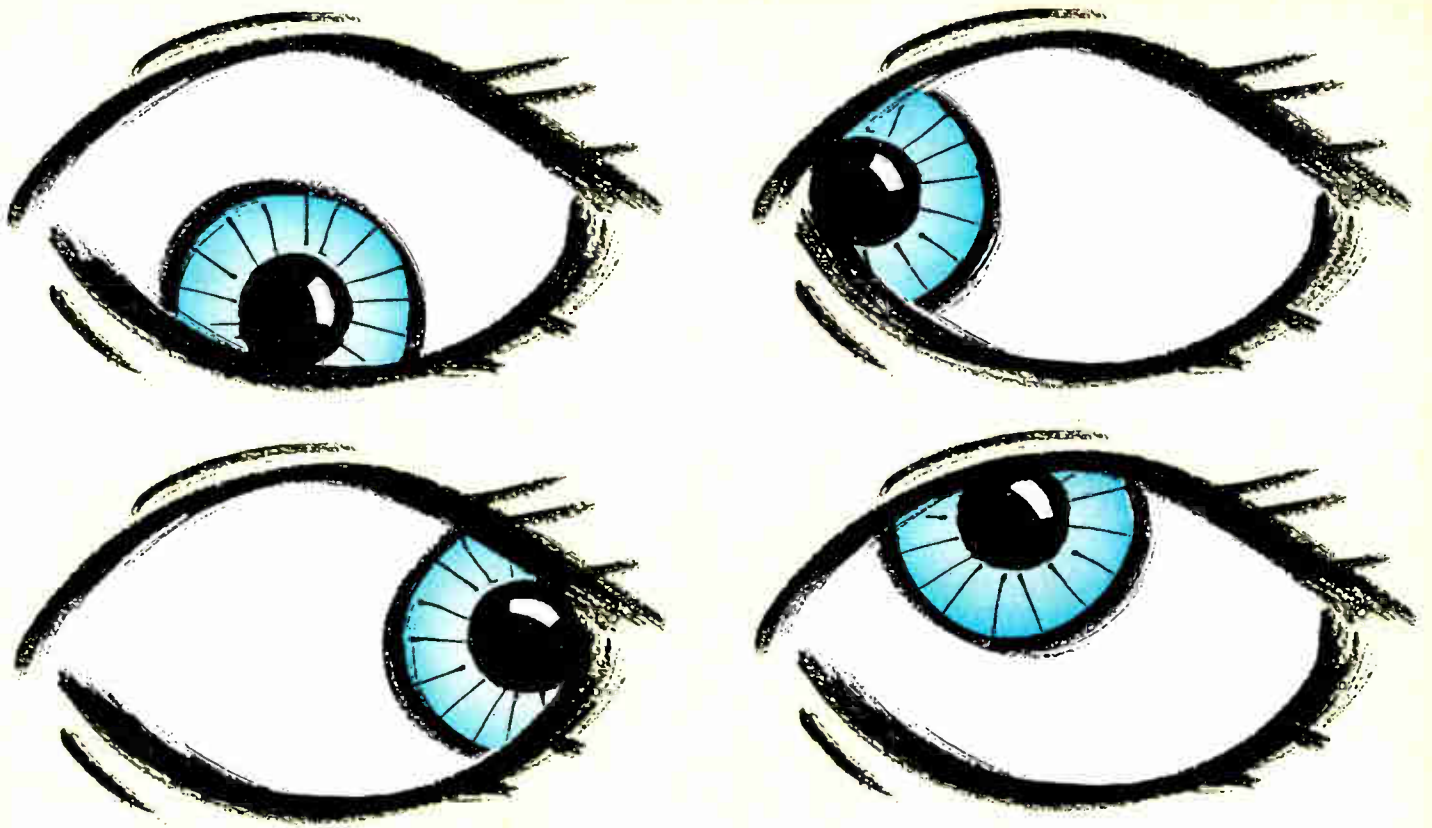

Now you've seen everything.

Aiphone introduces the world's first multi-directional video entry system.
The Video Sentry PanTilt.



Scans five times more viewing area than typical fixed systems. Without the distortion of extreme wide-angle cameras.

Aiphone does it again! Now with fingertip control, you can easily scan the entire entry space—left, right, up, down, all-around.

So no one can hide in

the shadows. And no one is too small, or too tall, to be greeted by the new Video Sentry PanTilt.

Everything off two wires.

PanTilt directional commands, picture, sound—all on two wires. It's ingenious. And with only two wires, installation's a snap.

Multi-directional control pad



Multi-directional door camera

The quality that is Aiphone

The Video Sentry PanTilt is made by Aiphone. So even with all its innovative technology, you know it's been proven reliable.

This year, give your customers a different point of view. With the new Video Sentry PanTilt. From Aiphone. Call us at (206) 455-0510.

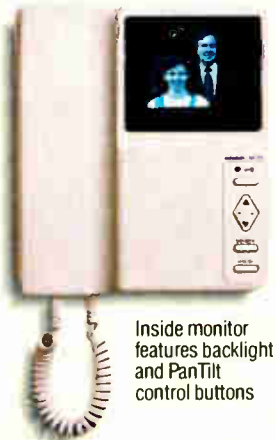

Inside monitor features backlight and PanTilt control buttons



AIPHONE®

Communication systems
for business, home & industry.
Sight • Sound • Security

APPLIED TECHNICAL SYSTEMS

815 King Pl.
Shreveport, LA 71115
(318) 868-7413 (800) 444-7161
FAX: (318) 631-7613
President: Jim Reccelli; Vice President:
Richard Davis
C.L. Pugh & Associates, Cleveland, OH
216-238-1777
Total Marketing, Fort Worth, TX 817-560-3970
Western Audio Sales, Burbank, CA 818-954-9300
PRODUCTS: access control, signaling devices

ATLAS/SOUNDOLIER

1859 Intertech Dr.
Fenton, MO 63026
(314) 349-3110 (800) 876-7337
FAX: (314) 349-1251
VP/Marketing & Sales: Charles Gushwa;
VP/Marketing Consultant: Herbert M. Jaffe;
National Sales Manager: Bud Waters; Eastern
Sales Manager: Tony Satariano; Western Sales
Manager: Jeff Garstick; OEM Sales Manager:
Larry Damato
Precide, Morbio Inferiore, Switzerland,
914-31734
PRODUCTS: access control, ancillary
components, audio surveillance, Intercom,
intrusion detection, signaling devices, sirens,
strobes

Autocall

P.O. Box 496
Shelby, OH 44875
(419) 347-2400 FAX: (419) 347-3070
J.B. Parent, Dublin, OH 614-764-0064

Bogen Communications, Inc.

50 Spring Street
P.O. Box 575
Ramsey, NJ 07446
(201) 934-8500 FAX: (201) 934-9832
President: John H. Ochtera; Vice President,
Sales & Mktg: David A. Chambers
Scott Whipple, Columbus, OH 614-272-1689
Sam Blasi, Ramsey, NJ 201-934-8500
Walter Spencer, Ramsey, NJ 201-934-8500
Fred Yosenick, Woodland, CA 916-668-6311
Edwards Company, Inc., Livonia, MI
313-458-7777
PRODUCTS: announcement systems, audio
surveillance, intercom

Burle Industries Inc.

1000 New Holland Avenue
Lancaster, PA 17601
(717) 295-6000 FAX: (717) 295-6097
Vice Pres. of Security Div.: Carlton Rintz; Vice
President of Marketing: George Brody
Nova Marketing, San Francisco, CA
415-952-0943
PRODUCTS: access control, audio surveillance,
burglar alarms, CCTV, door-lock systems,
intrusion detection, video motion detection,
video surveillance

C & K Systems, Inc.

107 Woodmere Road
Folsom, CA 95630
(916) 351-1131 (800) 227-8065
FAX: (916) 985-0352
President/CEO: Larry Tracy; Vice President,
Engineering: Richard Johnson; National Sales
Manager: Mike Wilcher
Edwards Company, Inc., Livonia, MI
313-458-7777
PRODUCTS: access control, burglar alarms,
duress, fire alarm, intrusion detection,
signaling devices, sirens, strobes

Coherent Communications

13756 Glenoaks Blvd.
Sylmar, CA 91342
(818) 362-9393 FAX: (818) 362-7045

Communications Products

4911 W. Good Hope Rd.
Milwaukee, WI 53223
(414) 351-4660

Continental Instruments

70 Hopper St.
Westbury, NY 11590
(516) 334-0900 FAX: (516) 334-0235

Cornell Electronic Products, Inc.

4911 W. Good Hope Road
P.O. Box 23411
Milwaukee, WI 53223-0411
(414) 351-4660 FAX: (414) 351-4657
President: Donald J. Glaubitz; Vice President:
Gary M. Butler; Sales Manager: Pauline A.
Haack; Accounting: Thelma M. Plunkett;
Production Manager: Joel Karls
Richard S. Pass Associates, Philadelphia, PA
215-757-6100
Dick Bellew Sales, Dallas, TX 214-644-7881
Winchester Electronic Sales, Atlanta, GA 404-
392-0200
Cartwright & Bean, Orlando, FL 407-889-9100
Rancillo Associates, St. Louis, MO 314-845-0202
Vector Corp., Seattle, WA 206-368-8400
Kingston Sales, Indianapolis, IN 317-876-2545
Bidwell-Schwartz Associates, Gardena, CA
213-770-0300
Yocum Marketing, Mesa, AZ 602-834-3334
Avcom, Inc., North Olmstead, OH 216-777-2060
Kodo Associates, Minneapolis, MN 612-881-1255
W.A. Hendrickson Co., North Scituate, MA
617-545-0652
LSM Associates, Phelps, NY 315-548-4891
R & S Sales, Rockville Ctr., NY 516-678-6887
PRODUCTS: access control, audio surveillance,
door-lock systems, duress, intercom, intrusion
detection, signaling devices

De-Tech Systems

3407 Rose Ave.
Ocean, NJ 07712
(201) 918-0800

Detection Systems

130 Perinton Pkwy.
Fairport, NY 14450
(716) 223-4060

DIA General

47 Kearney Rd.
Needham, MA 02192
(617) 449-1533

Doorguard Systems, Inc.

2601 Rolling Rd.
Baltimore, MD 21207
(301) 281-0022 (800) 442-MACS
FAX: (301) 281-0061
President/Owner/C.E.O.: C.T. Croson Jr.; Vice
President/General Mgr.: Paul O'Connell; Sales
Manager: Jerry Peck CPL; Technical
Applications/R&D: John Shipley CML
Langbaum Associates, Inc., New York, NY
914-634-1141
Garreau & Associates, Rosewell, CA
404-343-8036
King & Associates, Grosse Pointe Pk, MI
313-534-7313
Industrial Security Systems, Crofton, MD

301-721-0005
Carey & Associates, Houston, TX 713-460-1111
Camden Marketing, Pierre Fonds, OU
514-683-3377
PRODUCTS: door-lock systems

Dorado Systems Corp.

1842 Sabre St.
Hayward, CA 94545
(510) 783-2000 FAX: (510) 786-3028
Director of Marketing: Bill Ragsdale; National
Account Manager: Walt Mahoney
PRODUCTS: access control, signaling devices

Edwards Company, Inc.

195 Farmington Avenue
P.O. Box 1188
Farmington, CT 06034
(203) 678-0410 FAX: (203) 677-5881
President: Timothy Mellen; Vice Pres. Mktg.,
Sales Mgr.: Louis Riccio; Vice President
Finance: Paul DeFilippo; Vice President,
Engineering: Ed Miller; Vice Pres. Employee
Relations: Robert Maxwell
Edwards Company, Inc., Cherry Hill, NJ
609-482-5300
Edwards Company, Inc., Atlanta, GA
404-451-0362
Edwards Company, Inc., City Of Indus., CA
818-854-8670
Edwards Company, Inc., Pleasanton, CA
415-463-1788
Edwards Company, Inc., Downers Grove, IL
708-515-1900
Edwards Company, Inc., Livonia, MI
313-458-7777
Edwards Company, Inc., Dallas, TX 214-233-8998
Edwards Company, Inc., Miami, FL 305-592-0510
Edwards Company, Inc., Norwood, MA 617-762-
9115
Edwards Company, Inc., Norwalk, CT
203-847-1115
Edwards Company, Inc., Lorton, VA
703-550-7815
PRODUCTS: fire alarm, signaling devices,
smoke detectors, strobes

Electro-Vox

2626 Bates Rd.
Montreal, Qu H3S 1B2
(514) 731-3771 FAX: (514) 731-3193

Elkay Industries

2925 North Market St.
St. Louis, MO 63106
(314) 535-1333 FAX: (314) 535-4118
CEO/ENG: Richard Hahn; President: Paul
Grote; Vice President, Sales: Martin Hahn;
Engineering: Jack Scilligo
Edwards Company, Inc., Livonia, MI
313-458-7777

Eltrex Int'l

2 Columbia Dr.
Amherst, NH 03031
(603) 886-3500 FAX: (603) 886-3508

ENCOM PRODUCTS CO., INC.

502 Lower Hopewell Road
Oxford, PA 19363
(215) 932-9600 (800) 424-9066
FAX: (215) 932-9999
Greg Dzubay & Assoc., Glendale, AZ
800-999-0006
PRODUCTS: Intercom

EXI ELECTRONICS MANUFACTURING

803 Erin St.
Winnipeg, MB R3G 2W2
(204) 453-0573 FAX: (204) 775-1165
Sales Engineer: Mort Larsen; R & D Engineer:
Vladimir Federman; Marketing: Les Toutant
Doug Warren, Newport News, VA 804-930-3217
PRODUCTS: access control, door-lock systems,
intrusion detection, signaling devices

Faraday, Inc.

805 S. Maumee Street
Tecumseh, MI 49286
(517) 423-2111 FAX: (517) 423-2320
Senior Vice President: Ron Miller; Fire Alarm
Product Manager: Dave Hall; Clock Production
Manager: Bob Ewing; Intercom Production
Manager: Mike Marceau; Sales Manager - Fire
Alarm: Bill Hippert
Greg Dzubay & Assoc., Glendale, AZ
800-999-0006

Federal Signal Corp. Comm. Products

4974A Scioto Darby Road
Hilliard, OH 43026
(614) 876-6677 (800) 521-8219
FAX: (614) 876-6975
General Manager: Robert Rankin; Marketing
Manager: Gregory Davis; Eastern Regional

Manager: James Belshe; Western Regional
Manager: Hal Light
Greg Dzubay & Assoc., Glendale, AZ 800-999-
0006

Fiber Options

80 Orville Drive, Ste. 102
Bohemia, NY 11716
(516) 567-8320 (800) 342-3748 FAX: (516) 567-
8322
CEO: Bob De Lia; Vice President: Clyde Smith;
Vice President: Jack Fitzsimmons; Sales
Manager: Rita Edrich
F.M. Valenti, Nahant, MA 617-592-5300
Thaw Sales & Marketing, So. Plainfield, NJ 201-
757-8150
Intermountain Marketing, Castle Rock, CO 303-
688-5507
Marketing Specialists, Simi Valley, CA 805-582-
0666
Universal Technologies S.A., Waure, Belgium,
321-0-242520
PRODUCTS: CCTV

Fire Burglary Instruments

50 Engineers Rd.
Hauppauge, NY 11788
(516) 921-8666 FAX: (516) 921-0088

Fire Control Instruments, Inc.

269 Grove Street
Newton, MA 02166
(617) 965-2010 FAX: (617) 965-0659
President: Frank Carideo; Executive Vice
President: Art Appel; Director, Sales &

Marketing: Randy Edwards
Doug Warren, Newport News, VA 804-930-3217
PRODUCTS: fire alarm, signaling devices,
smoke detectors, strobes

Floyd Bell, Inc.

897 Higgs Ave.
Columbus, OH 43212
(614) 294-4000 FAX: (614) 291-0823
President: Donald C. Foukal; Vice President,
Marketing: Tom Shain; Vice President,
Development: Ely Zofan; Materials Manager:
Don Owens; Manufacturing Manager: John
Miller
J.B. Parent, Dublin, OH 614-764-0064
PRODUCTS: signaling devices

FSR Inc.

244 Bergen Boulevard
West Paterson, NJ 07424
(201) 785-4347 (800) 332-3771
FAX: (201) 785-3318
President: William G. Fitzsimmons; Vice
President: Janice Sandri; Engineering
Manager: Joseph Fischer; Special Projects
Manager: John Macaluso; Manager, Metal
Products: Joseph Amico
Sigmet Corporation, Valley Forge, PA
215-783-6666
Peregrine Southwest, Houston, TX
713-589-8481
Henry W. Phillips Inc., Roswell, GA 404-992-3070
Piper and Givan Associates, Needham, MA
617-449-1144
Design Factors, Hacienda Hts., CA 213-697-7576

RESEARCH

SOUND COMMUNICATIONS DOES IT LIKE NOBODY ELSE.

From our Annual Contractors
Survey to our Year End
Suppliers' Survey and Economic
Report, we keep the industry
informed by letting the industry
voice its view.

... And now with product check,
we're keeping you informed on
a monthly basis of what is being
used where and when.

**When it comes to research,
nothing compares to**

SOUND COMMUNICATIONS

TELE-GUARD™ NEVER SLEEPS!



Tele-Guard™ Telephone Entry System

- Plugs Into Standard RJ11C Phone Jack
- Vandal-Resistant Stainless Steel Panel
- Nonvolatile EEPROM Permanent Memory
- For 1 To 1,000 Resident Telephones

**FOR FREE BROCHURE
OR INFORMATION
CALL TOLL-FREE...
NY (800) 231-1414
USA (800) LEE DAN-1**

LEE DAN™
COMMUNICATIONS, INC.
155 Adams Avenue
Hauppauge NY 11788-3699

Circle 38 on Reader Response Card

Cambridge Marketing, Westerville, OH
614-363-9191
PRODUCTS: signaling devices

Galaxy Control Systems

3 N. Main Street
P.O. Box 158
Walkersville, MD 21793
(301) 694-9355 (800) 445-5560
FAX: (301) 898-3331
General Manager: Rick Fournier
Doug Warren, Newport News, VA 804-930-3217
PRODUCTS: access control, ancillary components, door-lock systems, duress

General Security Co., Inc.

16 Newtown Plaza
Plainville, NY 11803
(516) 753-0700 (800) 572-8989
FAX: (516) 753-0839
President: Charles Tanner; Director of Sales: Joseph N. Benjamin
Cambridge Marketing, Westerville, OH
614-363-9191
PRODUCTS: ancillary components

Gentex Corporation

10985 Chicago Drive
Zeeland, MI 49464
(616) 392-7195 FAX: (616) 392-4219
Director of Marketing: Scott R. Edwards
Peter Hilton, Regional Manager, Medford, MA
617-395-0245
John Morrow, Regional Manager, Jacksonville, FL
904-260-6157
Dennis Clair, Regional Manager, El Toro, CA
714-472-4744
John Anthony, Stamford, CT 203-322-9202
PRODUCTS: signaling devices, smoke detectors, strobes

GYRR, A DIVISION OF ODETICS

1515 South Manchester Avenue
Anahiem, CA 92802
(714) 772-1000 (800) 854-6853
FAX: (714) 776-6363
Director of Marketing & Sales: Thomas S. Pappageorge; Sales Manager: Domenic Isola;
Field Sales Manager: Jim Hawver; Field Sales Manager: Steve Wilber
John Anthony, Stamford, CT 203-322-9202

Home Safeguard Industries

29706 Baden Pl.
P.O. Box 4073
Mallbu, CA 90265
(213) 457-5813 FAX: (213) 457-4862
President: Leon Cooper; Vice President: Bill Halnes
Cambridge Marketing, Westerville, OH
614-363-9191

Identocard Technologies

1824 Colonial Village Lane
P.O. Box 10517
Lancaster, PA 17605-0517
(717) 299-3610 FAX: (717) 299-4122
PRODUCTS: access control

Intelligent Controls, Inc.

6825 216th St. SW
P.O. Box 1194
Lynnwood, WA 98036
(206) 771-8107 (800) 842-0221
FAX: (206) 775-1641
Vice President, Sales: Ron Katzlin; Product

Manager: Jeffrey Hovorka
Cord Lock Company, Prattville, AL 800-633-1464
PRODUCTS: access control, ancillary components, door-lock systems, duress, intrusion detection

International Components Corp.

105 Maxess Road
Melville, NY 11747
(516) 293-1500 (800) 645-9154
FAX: (516) 293-4983
President: Mort Grossman; Executive Vice President: Irwin Friedman; Vice President: Fred Grossman; Eastern Regional Sales Mgr.: Ken Reed; Vice President: Harvey Crossman
C.B. Electronic Marketing, Arvada, CO
303-422-0561
PRODUCTS: announcement systems, burglar alarms, Intercom, signaling devices, sirens, smoke detectors

International Logistics Systems Inc

295 Cortlandt Street
P.O. Box 25
Belleville, NJ 07109
(201) 759-0007 FAX: (201) 759-8989
President: Carmine O. Pellosie; Vice President: Dar Hyatt
ADCOM, Toronto, ON 416-251-3355
PRODUCTS: audio surveillance, CCTV, sirens, video motion detection, video surveillance, wireless systems

J.W. DAVIS AND CO.

3030 Canton Street
Dallas, TX 75226
(214) 651-7341 (800) 527-5705
FAX: (214) 939-0328
President: Harvey Earp; Vice President, Sales: Jack W. Tucker; Chief Engineer: Eric Simonson
Multi-Technical Reps., Brainerd, MN
218-828-9483
PRODUCTS: audio surveillance, CCTV, Intercom, video surveillance

Keltron Corp.

225 Crescent St.
Waltham, MA 02154
(617) 894-8700 FAX: (617) 899-9602
Sales and Applications Mgr.: Steven P. Sargent
Doug Warren, Newport News, VA 804-930-3217

Knox Security Engineering Corp.

335 Greenwich Ave.
Greenwich, CT 06830
(203) 622-7300 FAX: (203) 622-7418
Multi-Technical Reps., Brainerd, MN
218-828-9483

LEE DAN COMMUNICATIONS

155 Adams Avenue
Hauppauge, NY 11788-3699
(516) 231-1414 (800) 533-3261
FAX: (516) 231-1498
President: Leon Goldberg; Vice President Operations: Lawrence J. Goldberg; V.P. Finance & Administration: David H. Goldberg; Senior Technician: Sanford Hoffman; Office Manager: Rita Kaplan; Sr. Sales/Service Associate: Susan Leon
C.L. Pugh & Associates, Cleveland, OH
216-238-1777
PRODUCTS: access control, audio surveillance, CCTV, door-lock systems, Intercom, intrusion detection, signaling devices, sirens, video surveillance

LeFebure

308 29th St. NE
Cedar Rapids, IA 52406
(319) 366-2771

Lourea Electronics

6154 Lemona Avenue
Reseda, CA 91411
(818) 994-6498 FAX: (818) 994-6458
President: Louis F. Welss; Marketing/Systems Planning: George H. Barnes
Audio Etc., St. Peters, MO 314-278-4130
PRODUCTS: audio surveillance, duress, intrusion detection

MACKENZIE LABORATORIES, INC.

5507 Peck Road
Arcadia, CA 91006
(818) 579-0440 (800) 423-4147 FAX: (818) 448-7131
President: Sam Khoury; Sr. Vice President: Nagy Khattar; Manager, Sales: Joe Vitale
Audio Etc., St. Peters, MO 314-278-4130
PRODUCTS: announcement systems

MARLEE ELECTRONICS

2501 S. Front Street
Philadelphia, PA 19148
(215) 463-4842 (800) 874-8036
FAX: (215) 755-7877
President: B. Scott Holloway; Service Mgr./ Technical Eng.: Chas Tevis; Sales Coordinator: Kelly Lyman; Accounts Receivable/ Payable: Cookie Malandro
John Wilkins Assoc., Hillsboro, OH 513-826-8980
Associated Systems, Bedford, NH 603-472-2297
CSA/ Coaxial Systems Assoc., Tequesta, FL
407-746-6626
George Pettit Company, Berkely, IL
708-449-8000
Alby Currant Sales, Pittsford, NY 716-586-1110
Multi-Technical Reps., Brainerd, MN
218-828-9483
Rutherford Controls, Ontario, Canada,
519-621-7651

McGohan Electronics

1033 Fairway Dr.
Bensenville, IL 60106
(708) 595-2342 (800) 342-8853
FAX: (708) 595-2919
President: Jim McGohan; Vice President: Ronald Johnston; Secretary: Helen McGohan;
Director of Engineering: Robert Henderlong
Murphy & Cota Company, Atlanta, GA
404-875-2525
Austin and Associates, Willingboro, NJ
609-871-9290
Malsh Sales, Mulberry, IN 317-296-2322
J.W. Lerner Company, Stow, OH 216-686-1965
Rancillo and Associates, St. Louis, MO
314-845-0330
Sunrise Sales Company, LaMolle, IL
815-638-2660
PRODUCTS: signaling devices, sirens

Meridian Technologies, Inc.

80 Mott Avenue
Inwood, NY 11696
(516) 371-9300 FAX: (516) 371-9301
President: Robert Klein; Director of Engineering: Jack Krol
Doug Warren, Newport News, VA 804-930-3217
PRODUCTS: access control, audio surveillance, CCTV, signaling devices, video surveillance

MG Electronics

32 Ranick Road
Hauppauge, NY 11788
(516) 582-3400 FAX: (516) 582-3229
President: Elliott Maltz; National Sales
Manager: Stan Grey; Asst. Sls. Mgr., Comm.
Sound: Herb Woll; CEM Sales Manager: John
Kibbitt; Credit Manager: Rita McIberger;
Customer Service: Sue Novak
Loomis and Associates, Fremont, CA
415-683-0883
PRODUCTS: signaling devices, sirens

Napco Security System

333 Bayville Avenue
Amityville, NY 11701
(516) 842-9400 FAX: (516) 842-9137
Camden Marketing, Pierre Fonds, QU
514-683-3377

Navco Security Systems

16600 Aston St.
Irvine, CA 92714
(714) 250-4352
Camden Marketing, Pierre Fonds, QU
514-683-3377

Notifier

12 Clintonville Road
Northford, CT 06472
(203) 484-7161 (800) 289-3473
FAX: (203) 484-7118
President: Mark S. Levy; Vice President/Sales &
Mktg.: W. Allen Fritts; Vice
President/Engineering: Don Anderson; Vice
President/Manufacturing: Fabian Skretta;
Controller: Dave DeMeo
Paul Stone, Boston, MA 203-297-7041
Ken Plummer, Chicago, IL 203-297-7040
Todd Burgart, Dallas, TX 203-297-7037
Frank Tomberlin, Atlanta, GA 203-297-7038
Jim Arizini, Los Angeles, CA 203-297-7039
Jim Burger, Philadelphia, PA 203-297-7160
PRODUCTS: announcement systems, fire
alarm, signaling devices, sirens, smoke
detectors, strobes

Oregon Scientific Inc.

10950 S.W. 5th St., Suite 275
Beaverton, OR 97005
(503) 646-9806 (800) 869-7779
FAX: (503) 641-8015
Sunrise Sales Company, LaMolle, IL 815-638-
2660

PANASONIC CCVED

One Panasonic Way
Secaucus, NJ 07094
(201) 392-4429 FAX: (201) 348-7372
General Manager: Milton A. Landau; Assistant
General Manager: Ronald Harned
Panasonic CCVED/Northeast, Secaucus, NJ
201-348-7303
Panasonic CCVED/Southeast, Norcross, GA
404-717-6835
Panasonic CCVED/Midwest, Arlington Hts., IL
708-640-5168
Panasonic CCVED/Southwest, Ft. Worth, TX
817-685-1117
Panasonic CCVED/West, Cypress, CA
714-373-7265
Audio Biz, Mundellen, IL 708-949-0280
PRODUCTS: CCTV, video surveillance

Paso Sound Products, Inc.

14 First Street
Pelham, NY 10803
(914) 738-4800 (800) 231-3034

FAX: (914) 738-3954

Executive Vice President: Paul Mastrangelo;
Product Manager: Ken O'Brien; Credit
Manager: Marilyn Beckerson; Operations
Manager: Anthony Squegilla
Anderson Sales, Braintree, MA 617-848-9194
Jack Mesnick Sales, Liverpool, NY 315-622-3211
Palmer Associates, Fairfield, NJ 201-882-1266
Weller Electronic Sales, Inc., Worthington, OH
614-885-7819
Lienau Associates, Columbia, MD 301-621-4113
MJA Marketing, St. Charles, MO 314-447-7111
Northland Assoc., Moorehead, MN
218-233-4616
AllWest Sound & Communication, Camarillo, CA
805-388-7745
Dimension Pt. IX Marketing, Katy, TX
713-578-9277
Mountain Representatives, Denver, CO
303-333-7745
Miguel Lopez, Hialeah, FL 305-822-6853
Paco Electronics, Ltd., Markham, ON
416-475-0740
Robert Milk Co., Southfield, MI 313-354-3310
Marketline Inc., Snellville, GA 404-972-9048
Hawkins-Frederickson Assoc., Maitland, FL
407-831-2474
Lintern Associates, Naperville, IL 708-904-1225
Robert Milk Co., Indianapolis, IN 317-842-3400
PRODUCTS: announcement systems, Intercom

Perimeter Products, Inc.

1130 Terra Bella Ave.
Mountain View, CA 94043
(415) 966-8550 FAX: (415) 966-8517
President: M.E. Trimble; Marketing Specialist:
Paul Trouten; Criminal Justice Mktg. Spec.:
Martha Lee; Marketing Specialist: Elizabeth
Gerhold
Doug Warren, Newport News, VA 804-930-3217
PRODUCTS: duress, intrusion detection

Pinkerton Controls System

1123 E. Walnut St.
Carson, CA 90746
(213) 638-0400
Camden Marketing, Pierre Fonds, QU
514-683-3377

Powertronix

10623 Lawson River Ave.
Fountain Valley, CA 92708
(714) 963-5411
Camden Marketing, Pierre Fonds, QU
514-683-3377

Proprietary Controls Systems Corp.

18528 Dominguez Hills Drive
Rancho Dominguez, CA 90220-6415
(213) 638-0400 FAX: (213) 638-6204
President: Masami Kosaka; Vice President,
Operations: Hanan Rozner; Vice President &
C.F.O.: Robert Takahashi; Sales Manager: Craig
Rose
Keith Baird, LaGrange, KY
Roger Speyer, Westminster, CO
Tod Fitzpatrick, Redwood City, CA
Dimension/ Point IX, Lewisville, TX
214-436-3706

Protech Audio Corporation

Flowerfield Bldg. 1
St. James, NY 11780
(516) 584-5855 FAX: (516) 584-5904
Director of Marketing: Bill Murphy; Sales
Engineering: Joseph Giambone
Peregrine Southwest Reps, Houston, TX

713-589-8481

First Choice Marketing, Seattle, WA
206-524-7344
Dimension/ Point IX, Lewisville, TX
214-436-3706
PRODUCTS: Intercom

Pulnix America, Inc.

770 Lucerne Dr.
Sunnyvale, CA 94086
(408) 733-1560 (800) 445-5444
FAX: (408) 737-2966
President: Toshi Horii; Sales Manager, Vid.
Products: Richard Hofmeister; Sales Manager,
Sec. Products: Jeanne McGuire; Marketing
Comm. Manager: Janet Worthen
Pulnix, Fort Washington, MD 301-292-6906
Pulnix, Schaumburg, IL 312-929-9180
Pulnix, Carrollton, TX 214-416-4374
Dimension/ Point IX, Lewisville, TX
214-436-3706

Racom Products, Inc.

5504 State Rd.
Cleveland, OH 44134
(216) 351-1755 (800) 722-6664
FAX: (216) 351-0392
Sales Manager: Jerry Cahill; Production
Manager: Drew Miller; Sales Consultant: David
Williams
Design Factors, Hacienda Hgts., CA
213-697-7576
Sound Sales, Inc., Columbia, MD 301-964-1170
PRODUCTS: announcement systems

Racon, Inc.

12628 Interurban Avenue So.
Seattle, WA 98168
(206) 241-1110 (800) 426-5245
FAX: (206) 246-9306
President: Daniel Blattman; Director of Sales &
Mkt'g: Kris Drewry; Communication Sales:
Mark Thynes; Vice President: Bob Kirkaldie
Karp Communications, Tampa, FL 813-968-7098
PRODUCTS: access control, CCTV, intrusion
detection, vibration sensing, video
surveillance, wireless systems

Rauland-Borg Corp.

3450 W. Oakton St.
Skokie, IL 60076
(708) 679-0900 FAX: (708) 679-0625
President: William Krucks; Executive Vice
President: Kenneth James; National Sales
Manager: Harry Hahn; Marketing Manager:
Vince Novak
Jack Hollis, Geneva, IL 708-208-1488
Joe Clotti, Longwood, FL 407-767-2007
Frank Riha, Austin, TX 512-926-3646
Hank Plaisier, El Toro, CA 714-837-2626
Vince Ward, Vashon Island, WA 206-463-5582
Doug Warren, Newport News, VA 804-930-3217
Suzanne Graham, Kent, OH 216-678-7307
Mike Gulhan, E. Long Meadow, MA 413-525-6090

REVERE INDUSTRIES

1101 Blenville St.
New Orleans, LA 70112
(504) 523-3503 (800) 843-8321
FAX: (504) 525-6361
Vice President Mktg./Sales: Richard Harris
Camden Marketing, Pierre Fonds, QU
514-683-3377
PRODUCTS: access control, ancillary
components, announcement systems, audio
surveillance, burglar alarms, CCTV, door-lock
systems, fire alarm, Intercom, intrusion
detection, signaling devices, sirens, smoke
detectors, strobes, video motion detection,
video surveillance, wireless systems

Richardson Electronics Limited, SSD

3030 River Road
River Grove, IL 60171
(312) 625-2288 (800) 722-2288
FAX: (708) 452-5450
Vice President/ General Mgr.: Sal Rala;
National Sales Manager: Tom Brown; Director
of Operations: Charlene Woodward
Richardson Electronics Limited, Brooklyn, NY
718-692-5350
Richardson Electronics Limited,
Brampton, Canada,
Sunrise Sales Company, LaMolle, IL
815-638-2660
PRODUCTS: access control, ancillary
components, announcement systems, audio
surveillance, burglar alarms, CCTV, door-lock
systems, Intercom, intrusion detection,
signaling devices, video motion detection,
video surveillance, wireless systems

Rofu Int'l

5331G Hempstead Way
Springfield, VA 22151 (800) 255-7638
FAX: (805) 499-3154
Camden Marketing, Pierre Fonds, QU
514-683-3377

Securitron Magnalock Corporation

1815 W. 205th Street
Torrance, CA 90501
(213) 618-0204 (800) 624-5625
FAX: (213) 618-0144
President: Robert Cook; Vice President Sales:
Vince Fraillicardi; Sales Manager: Scott Baker;
Manager Customer Service: Norma Honek;
Sales and Marketing: Mark Henderson;
Technical Service: Aaron Gallegos
Karp Communications, Tampa, FL 813-968-7098
PRODUCTS: access control, door-lock systems

Security Intercom

1833 No. 15th
Seattle, WA 98133
(206) 523-6170 FAX: (206) 522-3920
Camden Marketing, Pierre Fonds, QU
514-683-3377

Select Engineered Systems

7991 W. 26th Ave.
Hialeah, FL 33016
(305) 823-5410 (800) 342-5737
FAX: (305) 823-5215
President: John Sheppard I; Executive V.P.,
Engineering: Carl "Rick" Muller; Vice
President, Sales: John Holloway; Sales
Administrator: Jay Vaz; Regional Sales
Manager: Felix Placer; Operations Manager:
John Sheppard II
Pass Associates, Philadelphia, PA 215-757-6100
G. Duvall Associates, Chicago, IL 312-774-5115
Rancillo Associates, St. Louis, MO 314-845-0202
Graham-Davis, Houston, TX 713-558-8662
Esro/D. Lentmeyer, Tampa, FL 813-968-3559
Camden Marketing, Pierre Fonds, QU
514-683-3377

Sensor Engineering Co.

2155 State St.
Hamden, CT 06517
(203) 777-7443 (800) 243-2563
FAX: (203) 877-6780
Sales & Marketing Manager: Leigh H. Hickcox
Camden Marketing, Pierre Fonds, QU
514-683-3377
PRODUCTS: access control

Sentex Systems, Inc.

20700 Lassen St.
Chatsworth, CA 91311
(818) 700-9800 FAX: (818) 407-5647
Inside Sales: Kitty Whitaker; Western Sales:
Greg Stone; Eastern Sales: Paul Colombo
Sentex/Paul Colombo, Columbia, MD
301-720-6318
Denning Electronics, Clarendon Hill, IL
708-920-1488
Security Access Ctrl., Inverness, FL
904-637-2121
Sound Sales, Inc., Columbia, MD 301-964-1170
PRODUCTS: access control, wireless systems

Shogyo International Corp.

287 Northern Boulevard
Great Neck, NY 11021
(516) 466-0911 FAX: (516) 466-0922
President: Mark A. Rubin; Vice President:
Howard Rubin
Karp Communications, Tampa, FL 813-968-7098
PRODUCTS: sirens

Silent Watchman

2461 McGaw Rd.
Columbus, OH 43207
(614) 491-5200 FAX: (614) 491-0015
Camden Marketing, Pierre Fonds, QU
514-683-3377

Sonitrol

424 N. Washington St.
Alexandria, VA 22314
(703) 549-3900 FAX: (703) 549-3900
Camden Marketing, Pierre Fonds, QU
514-683-3377

Sony Corp./Business & Professional Audio Group

3 Paragon Drive
Montvale, NJ 07645-1735
(201) 930-1000
President, Sales & Marketing: Mark Gray;
Senior VP Sales: C.F. Taylor; V.P. Product
Marketing: Anthony Gargano; Marketing
Manager, Pro Audio: Courtney Spencer; Sales
Manager, Pro Audio: Gary Rose; V.P. Audio
Products: Ron Remschel
Matt Robertson, Western Dist., 213-469-9084
Audio Etc., St. Peters, MO 314-278-4130
PRODUCTS: access control, CCTV, video
surveillance

Spectronics

4645 Hartley
Lincoln, NE 68504
(402) 467-3651 FAX: (402) 467-1908
Camden Marketing, Pierre Fonds, QU
514-683-3377

STENTOFON COMMUNICATIONS, INC.

6119 Connecticut Avenue
Kansas City, MO 64120
(816) 231-7200 (800) 654-3140
FAX: (816) 231-7203
President: Joe Green; Marketing Manager:
David E. Gill; National Sales Manager: Frederick
Hall
Dan Rothrock, Kansas City, MO 816-231-7200
Thomas J. Rellly, Elmsford, NY 914-592-1048
Kerry L. Orr, Atlanta, GA 404-973-0736
Michael A. Wilcock, Glendora, CA 818-335-0543
Cartwright & Bean, Inc., Norcross, GA
404-368-0160

Dimension/ Point IX, Lewisville, TX
214-436-3706
Humble & Associates, Anaheim, CA
714-750-2248
LCA Sales Company, Tuckahoe, NY 914-961-4700
Levy, Grams, & Lassers, North Brook, IL
708-272-8500
Pearson & Pearson, Englewood, CO
303-770-0797
Roger Ponto Assoc., Inc., Kirkland, WA
206-821-2996
R.W. Kunz & Assoc., Inc., Prairie Village, KS
913-648-3535
R.W. Sales, St. Paul, MN 612-646-2710
Brian Trankle & Assoc., Belmont, CA
415-595-4004
F.M. Valenti, Inc. & Assoc., Nahant, CA
617-592-5300
Yocum Marketing Co., Inc., Mesa, AZ
602-834-3334
Weller Electronic Sales, Inc., Worthington, OH
614-885-7819
PRODUCTS: announcement systems, audio
surveillance, intercom, intrusion detection,
signaling devices

Synergistics, Inc.

9 Tech Circle
Natick, MA 01760
(508) 655-1340 (800) 243-4669
FAX: (508) 651-2902
President: William M. Tetrick; Executive Vice
President: David Longworth; Treasurer:
Michael Kasuba; Sales Manager: Robert
Pogorelc; Manager, Dealer Sales: Norman Link;
V.P., Video Imaging: James Medford
Daniel Walsh, Logan, OH 614-385-1773
James Medford, Denver, CO 303-758-1014
Karp Communications, Tampa, FL 813-968-7098

T-S-K ELECTRONICS, INC.

564 Young St.
Tonawanda, NY 14150
(716) 693-3916 FAX: (716) 692-6433
President: Kevin Kedzierski; Marketing
Manager: Alan Gembola
JMS Marketing, Austin, TX 512-266-1113
PRODUCTS: audio surveillance, intercom

TALK-A-PHONE CO.

5013 N. Kedzie Ave.
Chicago, IL 60625
(312) 539-1100 FAX: (312) 539-1241
Vice President: Samuel Shanes; Sales Manager:
Dan F. Kagan; President: Z. Liberman
JMS Marketing, Austin, TX 512-266-1113
PRODUCTS: access control, announcement
systems, intercom, signaling devices

TELECALL AMERICA

14620 NE 95th Street
Redmond, WA 98052
(206) 881-2742 (800) 752-2860
FAX: (206) 881-3085
President: Hiko Shinoda; Vice President:
Nanci Brooks
Palmer Associates Inc., Fairfield, NJ
201-882-1266
Henry W. Phillips Co., Inc., Roswell, GA
404-992-3070
David H. Brothers Co., Inc., Finksburg, MD
301-833-0920
Leslie's, Elgin, IL 708-697-6677
Pacific Group, Pasadena, CA 818-577-0738
JMS Marketing, Austin, TX 512-266-1113
PRODUCTS: Intercom

TELEX COMMUNICATIONS, INC.

9600 Aldrich Avenue South
Minneapolis, MN 55420
(612) 884-4051 FAX: (612) 884-0043
President: Jeffrey Wetherell; Vice President
Marketing: John Schofield; Vice President
Sales: Dan Dantzler; Director of Marketing:
Don Mereen; Manager/Advertising & Mkt'g:
Ron Taylor
WestTech Marketing, Culver City, CA
213-870-9286
Bencsik Associates, Ocala, FL 904-732-9775
Burcaw Company & Associates, Warren, MI
313-573-4605
SACA, Oswego, NY 315-343-5739
Monfort Electronic Marketing, Indianapolis, IN
317-872-8877
Murphy & Cotta, Inc., Atlanta, GA 404-875-2525
Northland Associates, Moorhead, MN
218-233-4616
Rancillo Associates, Inc., St. Louis, MO
314-845-0202
J.Y. Schoonmaker Company, Dallas, TX
214-349-1650
Sigmat Corporation, Valley Forge, PA
215-783-6666
Weiler Electronic Sales, Worthington, OH
614-885-7819
Ziskind Associates, Rolling Meadows, IL
312-577-1624
White Radio Ltd., Burlington, ON 416-632-6894
Silver Peak Marketing, Denver, CO 303-467-9042
PacNor Marketing, Lynnwood, WA
206-771-6016
PRODUCTS: wireless systems

The Auth Company Inc.

505 Acorn St.
Deer Park, NY 11729
(516) 667-9000 FAX: (516) 667-9887
President: Michael Closeffi; Vice President:
John R. Charczuk
T.R. Brown, Manchester, CT 203-649-6686
Jim Dawson Company, Denver, CO
303-572-0962
The Helmer Co., Inc., Coon Rapids, MN
612-755-1900
Martin Friedman, Bala Cynwyd, PA
215-667-1838
AGC Enterprises, La Mirada, CA 714-522-6968
JMS Marketing, Austin, TX 512-266-1113

Thorn Automated Systems, Inc.

835 Sharon Dr.
Westlake, OH 44145
(216) 871-9900 FAX: (216) 871-8320
President: Casimer Kroll; Vice President,
Marketing: Michael Collins; Director of
Technical Svcs.: Steven Reed; Director of
Customer Svcs.: Linda Fedor
Thorn Automated Systems, Inc., Baltimore, MD
301-368-1400
Thorn Automated Systems, Inc., Northbrook, IL
708-272-8012
Thorn Automated Systems, Inc., Buena Park, CA
714-522-1107
Thorn Automated Systems, Inc., Rochester, MI
313-853-5050
Camden Marketing, Pierre Fonds, QU 514-683-3377
PRODUCTS: access control, announcement
systems, audio surveillance, burglar alarms,
CCTV, door-lock systems, duress, fire alarm,
intercom, intrusion detection, signaling
devices, sirens, smoke detectors, strobes,
video motion detection, video surveillance,
wireless systems

Time & Sound

14120 Live Oak Ave.
Baldwin Park, CA 91706
(818) 960-7781
Camden Marketing, Pierre Fonds, QU 514-683-3377

Transcience

633 Hope Street
Stamford, CT 06907
(203) 327-7810 (800) 243-3494 FAX: (203) 975-8902
President: Donald Bosak; Vice President:
Manfred Davis
JMS Marketing, Austin, TX 512-266-1113
PRODUCTS: burglar alarms, duress, fire alarm,
intrusion detection, signaling devices, wireless
systems

Trigon Electronics, Inc.

1220 N. Batavia St.
Orange, CA 92667
(714) 633-7442 FAX: (714) 633-7567
President: William J. Gagnon; Vice President:
Barbara Gagnon; Marketing: M.A. Williams;
Advertising: M.A. Williams; Purchasing:
Michael Wilger; Production: Johnnie Johnson
Amacom, Woodland Hills, CA 818-999-6556
Levy, Grams & Lassers, Northbrook, IL 708-272-8500
Omnitec, Livonia, MI 313-476-1434
Repworks, Chicopee, MA 413-533-0845
S.E. Dilsworth, Norcross, GA 404-491-7343
Camden Marketing, Pierre Fonds, QU 514-683-3377

Video Link

12950 Bradley Avenue
Sylmar, CA 91342
(818) 362-0353 (800) 843-5465 FAX: (818) 362-9506
President: Herb Seymour; V.P. Sales and
Marketing: Bill Cawfield; Sales Manager: Larry
W. Schatz; Asst. Sales Manager: Marguerita
Kiser
J.B. Parent, Dublin, OH 614-764-0064
PRODUCTS: video surveillance

Vikonics Inc.

210 Meadowland Parkway
Secaucus, NJ 07094
(201) 863-6868 FAX: (201) 863-0413
President: John L. Kaufman; V.P., General
Manager: Michael Pisano; V.P. Finance &
Administration: John J. Strong; V.P., Customer
Support: Adam Irving Jr.; Vice President,
Engineering: Robert Hoskinson; V.P. Business
Development: James J. Murphy
Cambridge Marketing, Westerville, OH 614-363-9191
PRODUCTS: access control, ancillary
components, audio surveillance, burglar
alarms, CCTV, door-lock systems, duress,
intrusion detection, signaling devices,
vibration sensing, video motion detection,
video surveillance, wireless systems

Visual Methods Inc.

35 Charles Street
Westwood, NJ 07675
(201) 666-3950 FAX: (201) 666-7931
President: W.T. Sandin; Vice President: H.
Kruegle
Larry Schirmer, Pontiac, MI 313-340-9588
PRODUCTS: access control, CCTV, video
surveillance, wireless systems

WHEELLOCK, INC.

273 Branchport Avenue
Long Branch, NJ 07740
(908) 222-6880 (800) 631-2148 FAX: (908) 222-8707
President: Peter W. Tarlton; V.P. Finance and
Admin.: Joseph P. Henry; Vice President
Operations: Douglas E. Phillips; Vice President
Sales/Mktg.: William L. Goldstein;
Telephone/Paging Mktg. Mgr.: Arthur Arlow;
Life Safety Mktg. Mgr.: Rein Haus
Joseph P. McCaffrey, Glen Ellyn, IL 708-790-2898
Edward P. Draney, Peachtree City, GA 404-631-3193
Peter Koehler, Los Angeles, CA 213-572-1347
Steve Goldberg, East Windsor, NJ 609-448-1457
Dave Jackowlak, Burbank, IL 708-599-4099
MJA Marketing, St. Charles, MO 314-447-7111
PRODUCTS: signaling devices, strobes

Wireless Technology, Inc.

3021 S. Valley View Blvd. #104
Las Vegas, NV 89102
(702) 362-8686 FAX: (702) 362-8191
President: William G. Horrell; Executive Vice
President: Daniel Fancher; Sr. Vice Pres.,
Marketing: Sanford H. Green
Protection Systems, Tinley Park, IL 708-614-8990
Valenti & Assoc., Nahant, MA 617-592-5300
Pacer Sales Co., Lenexa, KS 913-541-1411
Epic Marketing, San Mateo, CA 415-573-5881
Florida Electronic/Repco, N. Palm Beach, FL
407-622-7555
MJA Marketing, St. Charles, MO 314-447-7111
PRODUCTS: video surveillance, wireless
systems

Xetron Corp.

217 N. Highway 81
P.O. Box 448
Devine, TX 78016
(512) 663-3661 FAX: (512) 663-4838
General Manager: Robert Gardner; National
Sales Manager: Larry Kun; International Sales
Manager: Don Roberts
Xetron Corp., Barrie Ontario, CN 705-734-0300
MJA Marketing, St. Charles, MO 314-447-7111
PRODUCTS: access control

**AB INTERNATIONAL ELECTRONICS INC.**

1830-6 Vernon Street
P.O. Box 1105
Roseville, CA 95678
(916) 783-7800 FAX: (916) 784-1050
President: Robert Bird; Vice President,
Marketing: Irwin Laskey; Vice President,
Engineering: George Anderson; Sales/Credit
Manager: Victoria Bird; Chief Engineer: Jeff
Kuells; Order Manager: Kathy Foster
Hanoud and Associates, Rehoboth, MA
508-677-0701

Pro Audio Marketing, Melville, NY 516-367-8620
Yore Company, White Bear Lake, MN 612-770-9760
Metro Joe Marketing, Metairie, LA 504-887-1885
Image Marketing, Fountain Valley, CA 714-957-0641
Crescendo Associates, Hollywood, FL 305-922-9553
Griffith Audio Sales, Marietta, CA 404-924-2725
MBT Marketing, Pittsburgh, PA 412-344-1360
GBS Marketing, Raymore, MO 816-331-1703
Sherwood Associates, Windsor, NY 607-655-3413
Ludwig Marketing, Bannockburn, IL 708-295-1700
Rhythm Marketing, Lakeland, FL 813-667-0377
PRODUCTS: 70-volt amplifiers, bi-amp systems, dual-channel, low-frequency amplifiers, modular amplifiers, monitor amplifiers, signal processing amplifiers, single-channel, telephone paging amplifiers, tri-amp systems, zone-paging amplifiers

Aiphone Corp.

1700 130th Ave. NE
Bellevue, WA 98005
(206) 455-0510 FAX: (206) 455-0071
President: Jun Matsumoto; Vice President, Marketing: Harry Quanz; Vice President, Sales: Jim Morrison; Residential Sales Manager: Stephen Birgh; Commercial Sales Manager: John Mosebar
Aiphone East Coast Reg. Office, Rochelle Park, NJ 201-843-6115
Preclde, Morbio Inferiore, Switzerland, 914-31734
PRODUCTS: 70-volt amplifiers

Alesis

3630 Holdrege Avenue
Los Angeles, CA 90016
(213) 467-8000 (800) 5-ALESIS FAX: (213) 836-9192
President, COO: Russell Palmer; V.P. Sales and Marketing: Ralph Goldhelm; V.P. Advertising & Promotion: Allen Wald; Regional Sales Manager: Ted Keffalo; Regional Sales Manager: Doug White
Cambridge Marketing, Westerville, OH 614-363-9191
PRODUCTS: dual-channel

Altec Lansing Corp.

10500 W. Reno
Oklahoma City, OK 73128
(405) 324-5311 FAX: (405) 324-8981
President: Dave Merrey; Vice President, Sis. & Mktg: Chuck Lange; National Sales Manager: Jerry Spriggs; Manager Export Marketing: John Sexton; Technical Services Manager: Gary Jones; Customer Services Manager: Jim Brown
Dave Read, McKinney, TX 214-542-6328
Jim Faber, Shreveport, LA 318-631-1766
Paul Foula, Lombard, IL 708-268-1831
Alan Feckanin, Port St. Lucie, FL 407-879-1078
George Solti, Philadelphia, PA 215-637-3429
Larry Schirmer, Pontiac, MI 313-340-9588
Stu Moffit, Renton, WA 206-277-8851
PRODUCTS: 70-volt amplifiers, bi-amp systems, dual-channel, mixer amplifiers, modular amplifiers, telephone paging amplifiers, zone-paging amplifiers

Aphex Systems

11068 Randall Street
Sun Valley, CA 91352
(818) 767-2929 FAX: (818) 767-2641
President: Marvin Caesar; Vice President:

Hugh Wilcox; Sales Manager: Paul Freudenberg
Gould Marketing, Inc., Montreal, Quebec, 514-342-4441
Clueco Pro Division, Paris, France, 331-43596159
AKG Acoustics, Munich, Germany, 498-9 87 160
Otaritec Corporation, Tokyo, Japan, 813-392-7811
Sound Technology, Letchworth, UK 444-62480800
Nova Marketing, San Francisco, CA 415-952-0943
PRODUCTS: signal processing amplifiers

ASHLY

Ashly Audio, Inc.

100 Fernwood Ave.
Rochester, NY 14621
(716) 544-5191 (800) 828-6308 FAX: (716) 266-4584
President: Bill Thompson; Senior Vice President: Bob French; Vice President: Dave Malloy; Operations Manager: Ellen Price
ADCOM, Toronto, ON 416-251-3355
PRODUCTS: 70-volt amplifiers, dual-channel, low-frequency amplifiers, mixer amplifiers, modular amplifiers, monitor amplifiers, portable, signal processing amplifiers



ATI-Audio Technologies Inc.

328 W. Maple Avenue
Horsham, PA 19044
(215) 443-0330 FAX: (215) 443-0394
President: Samuel B. Wenzel; Vice President: Edward M. Mullin
PRODUCTS: dual-channel, mixer amplifiers, modular amplifiers, monitor amplifiers, signal processing amplifiers

Australian Monitor, U.S.A.

11845 Wakeman St.
Santa Fe Sprgs., CA 91745-0236
(213) 697-7576 FAX: (213) 691-9146
General Manager: Geoff Keleher; Consultant: Hymle Meyerson
Current Music Technology, Malvern, PA 215-647-9426
Nova Marketing, San Bruno, CA 415-952-0943
SRT Marketing, Tampa, FL 813-884-4805
RPM Sales, Carroiton, TX 214-446-3010
Sound Sales, Inc., Columbia, MD 301-964-1170
PRODUCTS: 70-volt amplifiers, bi-amp systems, low-frequency amplifiers, monitor amplifiers, tri-amp systems

Benchmark Media Systems, Inc.

5925 Court Street Rd.
Syracuse, NY 13206-1707
(315) 437-6300 (800) 262-4675 FAX: (315) 437-8119
President: Allen H. Burdick; Sales Manager: R. Rory Rail; Operations Manager: Mark A. Potterbaum
Nova Marketing, San Francisco, CA 415-952-0943
PRODUCTS: computer-controlled, mixer amplifiers, modular amplifiers

BGW Systems, Inc.

13130 Yukon Avenue
P.O. Box 5042
Hawthorne, CA 90250
(213) 973-8090 (800) 468-amps FAX: (213) 676-6713
President: Brian Gary Wachner; Vice President: Barbara Wachner; Controller: Don Carson; Credit Manager: Margaret Smith
Promusica Sales, Keene, NH 603-352-4831
Vector Corp., Seattle, WA 206-368-8400
Palmieri Assoc., Ridgfield, NJ 201-943-5888
C.B. Electronic Marketing, Arvada, CO 303-422-0561
Innovative Sales & Marketing, Irvine, CA 714-975-1130
Nova Marketing, San Francisco, CA 415-952-0943
PRODUCTS: 70-volt amplifiers, bi-amp systems, dual-channel, low-frequency amplifiers, monitor amplifiers, portable, signal processing amplifiers, single-channel, telephone paging amplifiers, tri-amp systems

Bogen Communications, Inc.

50 Spring Street
P.O. Box 575
Ramsey, NJ 07446
(201) 934-8500 FAX: (201) 934-9832
President: John H. Ochtera; Vice President, Sales & Mktg: David A. Chambers
Scott Whipple, Columbus, OH 614-272-1689
Sam Blasl, Ramsey, NJ 201-934-8500
Walter Spencer, Ramsey, NJ 201-934-8500
Fred Yosenick, Woodland, CA 916-668-6311
Edwards Company, Inc., Livonia, MI 313-458-7777
PRODUCTS: 70-volt amplifiers, mixer amplifiers, modular amplifiers, monitor amplifiers, telephone paging amplifiers, zone-paging amplifiers

Boulder Amplifiers, Inc.

4850 Sterling Drive
Boulder, CO 80301
(303) 449-8220 FAX: (303) 449-4806
President: Jeff Nelson; National Sales Manager: Marv Farley; Technical Support: Steve Rockwell
Pro Audio Limited, Barrington, IL 708-526-1660
Bach Sales, New York, NY 212-727-0404
Tobias and Co., Houston, TX 713-890-6277
Grizzly Marketing, Fairfield, CA 707-427-2779
Step Above Marketing, Spring Hill, FL 904-688-6985
Nova Marketing, San Francisco, CA 415-952-0943

Bryston/ Brystonvermont Limited

979 Franklin Lane
Maple Glen, PA 19002
(215) 628-4255 (800) 673-7899
FAX: (215) 628-2970
Vice President: Martin Bartelstone;

GUARANTEED EXCELLENCE.



With the first high quality, high powered, solid state amplifier manufactured by Crown in 1967, we began setting industry standards. Today, with a complete line of amplifiers, Crown is one of the most recognized names in sound amplification in the world.

Our success can be attributed to many people and to many

things. But encompassing all of them is our commitment to excellence... guaranteed excellence. It's found in the engineering details that go into every Crown amplifier from Power Base to our acclaimed Macro series. It's found in stringent manufacturing, precision assembly and a level of support unmatched in the industry.

Proof of Crown's guaranteed excellence is our unprecedented 3+3 No-Fault Extended Warranty... up to six years of transferable protection for all Crown amplifiers.

To experience Crown's tradition in our full line of high quality amplifiers, call us at 1-800-535-6289.

GUARANTEED EXCELLENCE

 **crown**®

Made in America

Exported as Amcron

Circle 218 on Reader Response Card
World Radio History

P.O. Box 1000 • Elkhart, Indiana 46515-1000

President: John Russel
J.B. Parent, Dublin, OH 614-764-0064
PRODUCTS: 70-volt amplifiers, computer-controlled, dual-channel, low-frequency amplifiers, modular amplifiers, monitor amplifiers, single-channel

Carver Corp.

P.O. Box 1237
Lynnwood, WA 98046
(206) 775-1202 (800) 443-2287
FAX: (206) 778-9453
Senior Vice President: Mark Friedman;
National Sales Manager: Steve Payne; Eastern
Regional Sales Mgr.: Charles Boornazian;
Midwest Regional Sales Mgr.: Pat Mountain;
Western Regional Sales Mgr.: Dean Standing;
National Credit Manager: Jo Wolfe
Peter Schmitt Company, Leonia, NJ 201-944-2806
World Wide Electronics, Davie, FL 305-584-7024
Sound Marketing, Palos Hills, IL 708-598-6888
Marketing Concepts, Irving, TX 214-869-0669
Derek Allen and Assoc., Toluca Lake, CA 818-840-8327
Edwards Company, Inc., Livonia, MI 313-458-7777
PRODUCTS: dual-channel

CLARITY

1111 Industry Avenue, S.E.
Roanoke, VA 24013
(703) 982-7003 (800) 962-6009 FAX: (703) 982-7032
President: John W. Mason; Sales Coordinator:

Linda T. Bishop; Product Manager: John D. Spencer
Featherstone Sales, Los Gatos, CA 408-356-3243
Unirep Inc., Vairico, FL 813-681-3477
M.I.N.K. Associates, Overland Park, KS 913-341-2112
Gerald Horne Associates, Stow, MA 508-897-1741
Forti Associates, Kensington, MD 301-949-1706
Holland Marketing, Bloomington, MN 612-881-8425
Adams & Associates, Greensboro, NC 919-272-6838
Reptronics Inc., New Madison, OH 800-888-0530
Dick Belew Sales, Dallas, TX 214-644-7881
PRODUCTS: 70-volt amplifiers, mixer amplifiers, telephone paging amplifiers

Comutronix, Inc.

18627 Brookhurst #305
Fountain Valley, CA 92708
(714) 963-7454 FAX: (714) 963-7815
Edwards Company, Inc., Livonia, MI 313-458-7777

Crest Audio Inc.

150 Florence Avenue
Hawthorne, NJ 07506
(201) 423-1300 FAX: (201) 423-2977
President: John Lee; Marketing Manager:
William Raventos; Gamble Division Manager:
Craig Hannabury; National Sales Manager: Paul Shiner
Edwards Company, Inc., Livonia, MI 313-458-

7777

PRODUCTS: 70-volt amplifiers, computer-controlled, dual-channel, modular amplifiers, monitor amplifiers, portable



Crown

P.O. Box 1000
Elkhart, IN 46515
(219) 294-8000 (800) 535-6289 FAX: (219) 294-8329
President: Clyde Moore; Sales Manager: Jim Beattie; Marketing/Advertising: Gerry Barclay;
Division Head: Gil Nichols
Dobbs-Stanford, Dallas, TX 214-358-0800
Seabridge Audio, Huntington Bch., CA 714-848-3697
Sigmat, Freehold, NJ 908-462-1221
PCM Marketing, San Francisco, CA 415-935-0900
Bencsik Assoc., Ocala, FL 904-732-9775
Cambridge Marketing, Westerville, OH 614-363-9191
PRODUCTS: 70-volt amplifiers

Maximum Audio.

Minimum Space and Hassle.

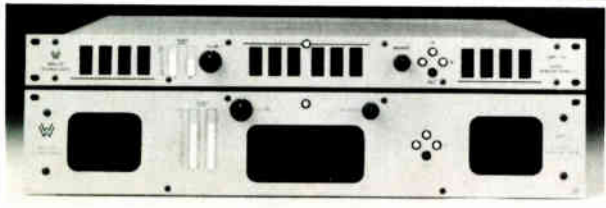

Top: AMP 1-A with phase indicator and level meter options. Bottom: AMP-2

Rack-mount powered stereo monitors from Wohler Technologies provide ample power, increased operational flexibility, and positive indication of out-of-phase stereo feeds. AMP-2 features include:

- ◆ Up to 104 dB SPL (@ 2 ft.)
- ◆ Frequency response 100 Hz - 18 kHz (± 5 dB)
- ◆ 40 segment LED bar graph level meter
- ◆ 3-way indicator for signal presence, absence, & overload
- ◆ Extensive magnetic shielding
- ◆ Variety of multi-input and switching options
- ◆ Quick and easy installation in 2 R.U. rack space

The slimmer AMP-1A fits in a single rack space and offers most of the same features and options. Ideal for VTR bays, both units are widely used by the major U.S. networks. Call today for full details.

 **Wohler Technologies**

Innovative Audio Monitoring Systems

1349 Kansas Street, San Francisco, CA 94107
Phone (415) 285-5462 FAX (415) 821-6414

Faster than the speed of sound.

More powerful than a computer-controlled amplifier.

Able to leap 120 db spl in a single bound (without clipping!)

Is it an amp? Is it a speaker?

No! It's

ANSWERMAN

Our fearless ANSWERMAN

will tackle everything from the most basic to the most difficult of questions relating to the Sound & Communications, industry. The all-knowing all-seeing audio guru is more than capable of answering ANY question that could possibly be on your minds.

Send your Questions to: The Answerman

SOUND
c/o **COMMUNICATIONS**

25 Willowdale Ave.

Port Washington, NY 11050

Call: (516) 767-2500 Fax: (516) 767-9335

Circle 266 on Reader Response Card
SOUND & COMMUNICATIONS BLUE BOOK 91/92

RAISING THE STANDARD FOR ENGINEERING SOPHISTICATION

EX SERIES

From the beginning we wanted it all: massive power, high efficiency and performance combined with unmatched flexibility and reliability. Together they represented the ultimate statement — amplifiers far more sophisticated than any available today. Our engineers accepted the challenge. **The result is the EX Series.**

MASSIVE OUTPUT POWER. The EX 4000 supplies 1,100 watts per channel at 4 ohms, enough power to drive today's most demanding speaker systems. No duty cycle lightweights, each model will deliver massive output power under high duty cycle conditions.

HIGH EFFICIENCY. QSC engineers developed an advanced high efficiency stepped linear output circuit to dramatically lower waste heat and AC current consumption. As a result, the EX 4000 can operate on a normal 15 amp AC plug. It's the only amplifier in its power class to do so!

CLOSED LOOP PROTECTION. A sophisticated closed loop thermal management and protection system measures actual operation and smoothly and progressively intervenes

only to the degree necessary. This eliminates harsh clipping, false triggering chatter, shut down, and other forms of protection distortion.

OPEN INPUT ARCHITECTURE.™

Open Input Architecture provides the ability to interface with computers, digital audio, and

fiber optic systems. It also allows you to incorporate signal processing capabilities within the amp. No matter what your needs will be, an EX Series amp has the flexibility to meet your requirements.

YOU CAN HAVE IT ALL. At QSC, our high standards of quality and value have remained the same for over two decades. We have also earned a legendary reputation for reliability. And we've done it the hard way, by performing flawlessly in the world's most demanding sound systems. Now, with the EX Series, we have raised the standard for engineering sophistication. It will change what you think a power amplifier should be.

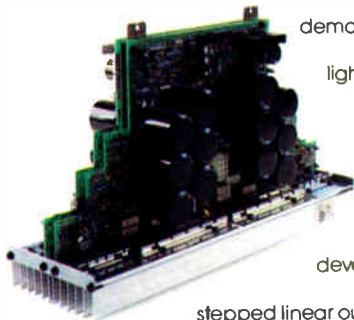
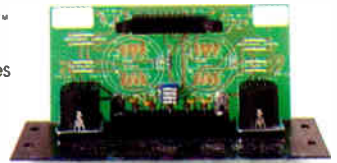

QSC
A U D I O



To learn more about the EX Series, contact an authorized QSC dealer for the EX Series White Paper.

QSC Audio Products, Inc., 1926 Placentia Avenue, Costa Mesa, CA 92627 (714) 645-2540

Circle 227 on Reader Response Card

DCS Audio Products

335 E 21st St.
New York, NY 10010
(212) 982-3654

Dukane Corp.

2900 Dukane Drive
St. Charles, IL 60174
(708) 584-2300 FAX: (708) 584-2370
President/C.E.O.: J. McWilliams Stone Jr.;
Pres./Comm. Systems Division: Steven L.
Deppe; National Sales Director: Warren T.
Anderson; Service Manager: Cliff Carlson
Wally Smutts, Toronto, ON 519-748-5352
Doug Fellabaum, Sycamore, IL 815-895-7573
Ken Lind, Boston, MA 617-235-6817
Pete Kendall, Jacksonville, FL 904-262-6025
Jim Lacey, Moreno Valley, CA 714-243-1160
Jack Brown, Dallas, TX 214-943-7528
Sanford Lange, Indianapolis, IN 317-251-3112
PRODUCTS: 70-volt amplifiers, low-frequency
amplifiers, mixer amplifiers, modular
amplifiers, single-channel, telephone paging
amplifiers, zone-paging amplifiers

Ecler/TEI Electronics

570 W. 18 Street
P.O. Box 246
Hialeah, FL 33010
(305) 888-3980 (800) 327-8811 FAX: (305) 885-
4950
President: Danny Alonso; Vice President:
Mireya A. Muniz; National Sales Manager:
Walter McNulty; Sales: Orlando Pineda; Sales:
Jose Hurcades; Customer Service: John

Tembras
Greg Dzubay & Assoc., Glendale, AZ 800-999-
0006
PRODUCTS: signal processing amplifiers

EDCOR ELECTRONICS

7130 National Parks Hwy
P.O. Box 5098
Carlsbad, NM 88220
(505) 887-6790 (800) 854-0259 FAX: (505) 887-
6880
Sales: P. Weston; Engineering: Brian Weston
Greg Dzubay & Assoc., Glendale, AZ 800-999-
0006
PRODUCTS: 70-volt amplifiers, dual-channel,
low-frequency amplifiers, mixer amplifiers,
modular amplifiers, monitor amplifiers, signal
processing amplifiers, single-channel,
telephone paging amplifiers, zone-paging
amplifiers

Electro Force Corporation

727 Oakstone Way
Anahelm, CA 92806
(714) 774-3666
President: Phillip Lindberg
Greg Dzubay & Assoc., Glendale, AZ 800-999-
0006
PRODUCTS: dual-channel, portable

Electro-Voice Inc.

600 Cecil Street
Buchanan, MI 49107
(616) 695-6831 (800) 827-6701 FAX: (616) 695-
1304

President: Paul McGuire; Director of
Marketing: Jim Long; Director of Sales: Garry
Templin; Sales & Distribution Mgr.: Janine
Masten; Director of Service/Repair: Frank
Spain; Public Relations Director: Keith Clark
Metropolis Audio Marketing Inc, New York, NY
908-225-0085

R.J. Marketing Ltd., Rockville, MD 301-251-0330
Ouzunoff & Associates, Yorktown Hts., NY 914-
248-7888

Ron Tunks Sales Inc., Tamarac, FL 305-722-2803
Wilson Audio Sales, Nashville, TN 615-646-4477
Audio Resources, Westmont, IL 708-655-1180
B.C. Electronic Sales Inc., Shawnee, KS
913-962-1990

Jones Audio Sales, Plano, TX 214-618-2600
Excellence Marketing, Eden Prairie, MN 612-
949-9011

C.L. Pugh and Associates Inc., Cleveland, OH
216-238-1777

Riley and Petchell Sales Inc., Detroit, MI 313-
937-3000

Lopfnow and Associates, Issaquah, WA 206-392-
3936

Radon and Associates Inc., Sacramento, CA
916-923-2524

The Torbett/ Kelsner Group Inc., Loveland, CO
303-669-1008

Western Audio, Burbank, CA 818-954-9300
Electro-Voice West, Visalia, CA 209-651-7777

PRODUCTS: dual-channel, mixer amplifiers,
portable

CARVER
PROFESSIONAL
P.O. BOX 1237, LYNNWOOD, WA 98046 - TOLL-FREE 1-800-443-CAVR, FAX (206) 778-9453

THE NEW LIGHT HEAVYWEIGHTS

CARVER
PROFESSIONAL
P.O. BOX 1237, LYNNWOOD, WA 98046 - TOLL-FREE 1-800-443-CAVR, FAX (206) 778-9453

Circle 263 on Reader Response Card

PM-120 (2x60 watts)
PM-300 (2x150 watts)
PM-600 (2x300 watts)
PM-900 (2x450 watts)
PM-1200 (2x600 watts)

EMS/Music

4204 Stone Way N.
Seattle, WA 98103
(206) 547-3010 (800) 666-6874 FAX: (206) 547-3004
President: R. Kilroy Hughes; Production Manager: Doug Sanders; National Sales Rep.: David Pearson; Customer Service Rep.: Lillian Forgette; AR Manager: Christina Mills
Cambridge Marketing, Westerville, OH 614-363-9191
PRODUCTS: dual-channel, modular amplifiers, single-channel, zone-paging amplifiers

FM Acoustics Ltd. of Switzerland

Tiefenhofstr. 17
Zuerich, Switz., CH-8820
(1) 780-6444 FAX: (1) 780-0488
President: Manuel Huber; 1st Vice President: Kurt Huber; Corporate Counsel: J.T. Borst; Office Manager: Shirley Huber; Production Manager: Alan Solomon; CEO, FM Acoustics USA: Gene Michalski
FM Acoustics USA, Benicia, CA 707-745-4444
Axiss Corporation, Tokyo, Japan, 813-32120591
Perspectives Audio P.A., Inc., Blaineville, PQ, CN 514-435-2925
KHS Trading Co. Ltd., Taipei, Taiwan, 886-27091266
Seoul Sound Tech. Group Ltd., Seoul, S. Korea, 822-584-4313
John Anthony, Stamford, CT 203-322-9202

Gemco Electronics, Inc.

550 Airport Rd.
P.O. Box 993
Gallatin, TN 37066
(615) 452-5960 (800) 624-3626 FAX: (615) 451-0026
General Manager: Jerry A. Graves; Order Entry: Linda McCullough; National Sales Manager: James F. Woodard
Gemco Electronics Jim Woodward, Gilmer, TX 903-762-2367
Audio Etc., St. Peters, MO 314-278-4130
PRODUCTS: 70-volt amplifiers, modular amplifiers, telephone paging amplifiers

Hacoustic Sound & Comm. of America

3963 Magnolia Lane
P.O. Box 542
Buford, GA 30518
(404) 945-3142 FAX: (404) 945-6174
President: Raleigh Perry
ADCOM, Toronto, ON 416-251-3355
PRODUCTS: 70-volt amplifiers, mixer amplifiers, modular amplifiers, signal processing amplifiers, telephone paging amplifiers, zone-paging amplifiers

Hafner Professional

613 So. Rockford Drive
Tempe, AZ 85281
(602) 967-3565 (800) 366-1619 FAX: (602) 894-1528
National MI: Jeff Snider; National Pro Amplifiers: Margie Williams
Western Sales, Newport Beach, CA 714-752-2131
Centurian Marketing, Glencoe, MO 314-227-7229
J.B. Marketing, Stamford, CT 203-322-9202
Starin Marketing, Chesterton, IN 219-929-4127
Northshore Marketing, Seattle, WA 206-284-9699
ADCOM, Toronto, ON 416-251-3355

Holophonics

1120 Ave. of the Americas, Ste.
New York, NY 10036
(212) 787-7767

Hot House Professional Audio

275 Martin Avenue
Highland, NY 12528
(914) 691-6077 FAX: (914) 691-6822
President: Richard Rose
Cambridge Marketing, Westerville, OH 614-363-9191
PRODUCTS: bi-amp systems, dual-channel, low-frequency amplifiers, monitor amplifiers, portable, single-channel, tri-amp systems

Industry West Electronics

270 N. Geneva Rd.
Orem, UT 84057
(801) 226-1000 FAX: (801) 226-3268
President: Darold Francis; Director of Marketing: Jay Simmons; Engineer: Chris Poulsen
PRODUCTS: 70-volt amplifiers

INNOVATIVE ELECTRONIC DESIGNS, INC.

9701 Taylorsville Rd., Louisville, KY 40299
(502) 267-7436 FAX: (502) 267-9070
President: Hardy Martin; Vice President. Mkt'g & Sales: Tom Roseberry; Sales Application Engineer: Mark Lewellyn; V.P. Research & Development: Bob Ponto; Vice President, Engineering: Ed Young; Vice President, Software: John Johnson
Yore Company, White Bear Lake, MN 612-770-9760
Steffey Marketing Assoc. Inc., Northbrook, IL 708-480-3575
WestTech Marketing, Culver City, CA 213-870-9286
Repworks, Chicopee, MA 413-533-0845
Darmstedter Associates, Baldwinsville, NY 315-638-1261
John Anthony, Stamford, CT 203-322-9202
Bencsik Associates, Ocala, FL 904-732-9775
C.L. Pugh, Cleveland, OH 216-238-1777
Monford Electronics Marketing, Indianapolis, IN 317-872-8877
C.M. Sales, Farmington Hill, MI 313-553-8070
B.C. Electronic Sales, Mission, KS 913-262-1720
Marketing Concepts, Irving, TX 214-869-0669
Torbett/Keiser Group, Loveland, CO 303-669-1008
Plus Four Marketing, Walnut Creek, CA 415-937-0650
North Shore Marketing, Seattle, WA 206-284-9699
Island Instruments, Kaneohe, HI 808-235-7544
PRODUCTS: 70-volt amplifiers, bi-amp systems, computer-controlled, dual-channel, modular amplifiers, monitor amplifiers, signal processing amplifiers, single-channel, telephone paging amplifiers, tri-amp systems, zone-paging amplifiers

IRP, A KNOWLES COMPANY

321 Bond Street
Eik Grove VII., IL 60007
(708) 439-3600 (800) 255-6993 FAX: (708) 640-9607
Vice President, General Mgr.: Brian Benn; Marketing Manager: Roger Carroll; Senior Sales Engineer: Gayle Campbell; Marketing Coordinator: Laura Valavcius; Applications Engineer: Norm Kinnaugh; Product Engineering Manager: Mitch Bentz
Piper and Givan Assoc., Needham, MA 617-449-

1144
Sigmnet Corp., Freehold, NJ 201-462-1221
Richard S. Pass Associates, Langhorne, PA 215-757-6100
Henry W. Phillips Co., Rosewell, GA 404-992-3070
Bencsik Associates, Ocala, FL 904-732-9775
C.B. Electronic Marketing, Arvada, CO 303-422-0561
Avwest Inc., Fountain Hills, AZ 602-946-1811
EESCO Systems Inc., Los Angeles, CA 213-666-9601
Pappas Consulting, Menlo Park, CA 415-324-4325
Chuck Olson Assoc., Renton, WA 206-271-5416
Kaltec Communications, North Vancouver, BC 604-987-1597
More Technologies Inc., Los Angeles, CA 213-474-4211
Audio Marketing Assoc., Brecksville, OH 216-526-2426
Starin Marketing, Chesterton, IN 219-929-4127
MJA Marketing, St. Charles, MO 314-447-7111
Graham Davis Inc., Dallas, TX 214-357-7677
PRODUCTS: 70-volt amplifiers, dual-channel, mixer amplifiers, signal processing amplifiers

Ivie Technologies Inc.

1366 West Center
Orem, UT 84057
(801) 224-1800 FAX: (801) 224-7526
President: Craig Berry; Vice President, Marketing: Glenn Meyer; Vice President, Product Mgt.: Larry Driskill; Sales Coordinator: Georgia Hall; Production Vice President: Bob Greene
Western Audio Sales, Burbank, CA 818-954-9300
Metropolis Audio Marketing, Edison, NJ 201-225-0085
Meyer Marketing, Deerfield Beach, FL 305-481-9250
Radon and Associates, Sacramento, CA 916-923-2524
Loppnow and Associates, Issaquam, WA 206-392-3936
Multi-Technical Reps., Brainerd, MN 218-828-9483

J.W. DAVIS AND CO.

3030 Canton Street
Dallas, TX 75226
(214) 651-7341 (800) 527-5705 FAX: (214) 939-0328
President: Harvey Earp; Vice President, Sales: Jack W. Tucker; Chief Engineer: Eric Simonson
Multi-Technical Reps., Brainerd, MN 218-828-9483
PRODUCTS: 70-volt amplifiers, mixer amplifiers, modular amplifiers, single-channel, telephone paging amplifiers

JBL Professional

8500 Balboa Boulevard
P.O. Box 2200
Northridge, CA 91329
(818) 893-8411 FAX: (818) 893-3639
President: Ronald Means; Vice President, Sales: Ken Lopez; Vice President, Marketing: Mark Gander; Market Manager: Hector Martinez; National Sales Manager: Neil Conley
Jim Chase, San Clemente, CA 714-492-6290
Bill Hamilton, Folsom, PA 215-543-4677
Bill Schuermann, Houston, TX 713-370-5553
Tom Walter, No. Barrington, IL 312-382-4925
ADCOM, Toronto, ON 416-251-3355
PRODUCTS: 70-volt amplifiers, dual-channel, low-frequency amplifiers, monitor amplifiers, portable, signal processing amplifiers

JENSEN TRANSFORMERS INC.

10735 Burbank Blvd.
North Hollywood, CA 91601
(213) 876-0059 FAX: (818) 763-4574
President: Bill Whitlock; Vice President,
Engineering: Steve Hogan; Vice President,
Operations: Dave Hill
C.B. Electronic Marketing, Arvada, CO 303-422-
0561
PRODUCTS: monitor amplifiers

Lectrosonics, Inc.

P.O. Box 15900
Rio Rancho, NM 87174
(505) 892-4501 (800) 821-1121 FAX: (505) 892-
6243
President: John Arasim; Vice President
Engineering: Larry Fisher; Vice President Mktg
& Sales: Bruce Jones
C.L. Pugh & Associates, Cleveland, OH 216-238-
1777
PRODUCTS: modular amplifiers, zone-paging
amplifiers

Leltch Inc.

825K Greenbrier Circle
Chesapeake, VA 23320
(804) 424-7920 (800) 231-9673 FAX: (804) 424-
0639
President: John Walter; Sales Manager: Gary
Stephens; Vice President, Marketing: Don
Thompson
Gold Coast, Canoga Park, CA 818-345-9550
Roscor, Chicago, IL 708-299-8080
DLE, Middleboro, MA 508-947-6801
Wiltronix, Wash. Grove, MD 301-258-7676
Advanced Marketing, Redwood City, CA 415-
365-3944
PRODUCTS: dual-channel, signal processing
amplifiers, single-channel

Len Finkler

80 Alexdon Rd.
Downsview, On M3J2B
(416) 630-9103

LWV Electronics

1540 Quail Lake Loop
Colo. Sps., CO 80906
(719) 540-8900 FAX: (719) 540-8933
President: John Borchert; Secretary: Rusty
Griffith
Audio Etc., St. Peters, MO 314-278-4130
PRODUCTS: computer-controlled, modular
amplifiers, signal processing amplifiers

Maxitron Corp.

13431 Pumice Street
Norwalk, CA 90650
(213) 802-9942 FAX: (213) 802-9945
President: Steve P.Y. Kim; Vice President:
Fred K.H. Kim; Natl Sales & Mktg. Manager: Irv
Welsman
Audio Resources Inc., Westmont, IL 708-665-
1180
Dimension Point IX, Lewisville, TX 214-436-3706
Elrep Sales Co., Tucker, GA 404-938-7108
Cordial/Riley Marketing, Sterling Hts., MI 616-
534-4204
Forti Associates, Kensington, MD 301-946-6129
Audio Etc., St. Peters, MO 314-278-4130
PRODUCTS: 70-volt amplifiers, mixer amplifiers,
portable, signal processing amplifiers, single-
channel, telephone paging amplifiers, zone-
paging amplifiers

McGohan Electronics

1033 Fairway Dr.
Bensenville, IL 60106
(708) 595-2342 (800) 342-8853 FAX: (708) 595-
2919
President: Jim McGohan; Vice President:
Ronald Johnston; Secretary: Helen McGohan;
Director of Engineering: Robert Henderlong
Murphy & Cota Company, Atlanta, GA 404-875-
2525
Austin and Associates, Willingboro, NJ 609-871-
9290
Malsh Sales, Mulberry, IN 317-296-2322
J.W. Lerner Company, Stow, OH 216-686-1965
Rancillo and Associates, St. Louis, MO 314-845-
0330
Sunrise Sales Company, LaMolle, IL 815-638-
2660
PRODUCTS: 70-volt amplifiers, mixer amplifiers,
monitor amplifiers, telephone paging
amplifiers, zone-paging amplifiers

Meyer Sound Laboratories Inc.

2832 San Pablo Ave.
Berkeley, CA 94702
(415) 486-1166 FAX: (415) 486-8356
Vice President, Sales & Mktg: Helen Meyer;
Marketing Manager: Ralph Jones; Director of
Technical Mkt'g: Mark Johnson; Customer
Service Manager: Scott Gledhill; National Sales
Manager: Cindy Ramos
Loomis and Associates, Fremont, CA 415-683-
0883
PRODUCTS: dual-channel

Morenz Development Corp.

2790 Loker Ave. W. Suite 105
Carlsbad, CA 92008
(619) 431-8077 (800) 878-PWMS FAX: (619) 431-
5077
Owner: Paul Morenz; Owner: Ken Morenz;
Owner: Mark Morenz
Doug Warren, Newport News, VA 804-930-3217
PRODUCTS: bi-amp systems, dual-channel,
monitor amplifiers

Opamp Labs Inc.

1033 North Sycamore Avenue
Los Angeles, CA 90038
(213) 934-3566 FAX: (213) 462-6490
Manager: B. Losmandy
Sunrise Sales Company, LaMolle, IL 815-638-
2660
PRODUCTS: low-frequency amplifiers, mixer
amplifiers, modular amplifiers, monitor
amplifiers, portable, signal processing
amplifiers, single-channel

Outline

Via L. DaVinci 56
25020 Fiero, Italy

(30) 358-1341 (800) 358-1351 FAX: (30) 358-
0431

President: Guido Noselli; Vice President, Sales:
Giorgio Biffi; Marketing Director: Marcello
Croce; R & D Director: Giancarlo Puzzi; Sales

Manager: Anna Guarenti; Purchasing Manager:
Angelo Ferraresi
Coemar Deutschland, ULM, Germany, 073-
160-1205
MBS, Lempdes, France, 073-910-630
Leibnitzer M. Bigler, Austria, 034-52-6515
Talsheng Trading, Taipei, Taiwan, 253-13802
Universal, Singapore, 534-5993
Precide, Morbio Inferiore, Switzerland, 914-
31734
PCP Electronics, Limassol, Cyprus, 53-39297
Metronome Muzik, Istanbul, Turkey, 7-345-
2457
Tropical Recording, Malindi, Kenya, 723-27700
Point Rouge, Mutuelueville, Tunis, 7-345-
2457
PRODUCTS: dual-channel

OXMOOR CORP.

2111 Parkway Office Circle
Birmingham, AL 35244
(205) 985-7040 FAX: (205) 985-9966
President: Lynn A. McCroskey; Vice President/
Manager: Gary L. West; National Sales
Manager: Richard C. Mitchell; Sales Associate:
Nick Alsmiller; Production Manager: Jim
Watson; Director of Engineering: Gene
Elghmy
John B. Anthony Company, Stamford, CT 212-
585-2027
ASR, Fallston, MD 301-893-0001
Audio Resources, Westmont, IL 708-655-1180
Dimension IX Marketing, Lewisville, TX 214-436-
3706
Evans Sales and Marketing, Nashville, TN 615-
297-7997
Loomis and Associates, Fremont, CA 415-683-
0883
Loppnow and Associates, Issaquah, WA 206-
392-3936
R.J. Throckmorton Sales Co., Ballwin, MO 314-
227-7222
Repworks, Chicopee, MA 413-553-0845
PRODUCTS: signal processing amplifiers, zone-
paging amplifiers

**Panasonic Professional Audio
Sys.**

6550 Katella Avenue
Cypress, CA 90630
(714) 373-7278 FAX: (714) 373-7242
Nat. Sales & Marketing Mgr.: Steve Woolley;
Marketing Manager: Chris Foreman; Western
Regional Sales Mgr.: James Murray; Midwest
Regional Sales Mgr.: Greg Braithwaite; Eastern
Regional Sales Mgr.: Carla Campbell;
Telemarketing Sales Mgr.: Lynn Thompson
James Murray, Cypress, CA 714-373-7389
Greg Braithwaite, Arlington, IL 708-981-7329
Carla Campbell, Norristown, PA 215-630-1651
Cambridge Marketing, Westerville, OH
614-363-9191
PRODUCTS: bi-amp systems, dual-channel,
monitor amplifiers

Paso Sound Products, Inc.

14 First Street
Pelham, NY 10803
(914) 738-4800 (800) 231-3034 FAX: (914) 738-
3954
Executive Vice President: Paul Mastrangelo;
Product Manager: Ken O'Brien; Credit
Manager: Marilyn Beckerson; Operations
Manager: Anthony Squeglla
Anderson Sales, Braintree, MA 617-848-9194
Jack Mesnick Sales, Liverpool, NY 315-622-3211
Palmeri Associates, Fairfield, NJ 201-882-1266
Weller Electronic Sales, Inc., Worthington, OH
614-885-7819

lenau Associates, Columbia, MD 301-621-4113
 AJA Marketing, St. Charles, MO 314-447-7111
 Northland Assoc., Moorehead, MN 218-233-1616
 Allwest Sound & Communication, Camarillo, CA 805-388-7745
 Dimension Pt. IX Marketing, Katy, TX 713-578-1277
 Mountain Representatives, Denver, CO 303-333-7745
 Miguel Lopez, Hialeah, FL 305-822-6853
 Paco Electronics, Ltd., Markham, ON 416-475-1740
 Robert Milsk Co., Southfield, MI 313-354-3310
 Marketline Inc., Snellville, GA 404-972-9048
 Lawkins-Frederickson Assoc., Maitland, FL 407-331-2474
 Intern Associates, Naperville, IL 708-904-1225
 Robert Milsk Co., Indianapolis, IN 317-842-3400
PRODUCTS: dual-channel, mixer amplifiers, modular amplifiers, portable, telephone paging amplifiers, zone-paging amplifiers

PEAVEY ELECTRONICS CORP.

11 A Street
 P.O. Box 2898
 Meridian, MS 39301
 (601) 483-5365 FAX: (601) 484-4278
CEO: Hartley Peavey; **President:** Mella Peavey
 Dimension/ Point IX, Lewisville, TX 214-436-1706
PRODUCTS: 70-volt amplifiers, bi-amp systems, computer-controlled, dual-channel, low-frequency amplifiers, mixer amplifiers, modular amplifiers, monitor amplifiers, portable, signal processing amplifiers, single-channel, telephone paging amplifiers, tri-amp systems, zone-paging amplifiers

Pignose Industries

47 E. Gardena Bl.
 Gardena, CA 90248
 (213) 770-4444 FAX: (213) 538-9560
 Chuck Olson Assoc., Renton, WA 206-271-5416

PORTLAND INSTRUMENT CORP.

1120 San Fernando Rd.
 Glendale, CA 91201
 (818) 500-0137 FAX: (818) 240-1828
President: Ronald Fuller; **Production Manager:** Dick Herbert; **Office Manager:** Marcia Fuller; **Controller:** Ken Thiele; **Service Department:** Bill Brungard
 Job White Associates, Solon, OH 216-248-1317
 Dimension/ Point IX, Lewisville, TX 214-436-3706
PRODUCTS: 70-volt amplifiers, mixer amplifiers, monitor amplifiers, portable

Precision Electronics, Inc.

101 King St.
 Franklin Park, IL 60131
 (708) 678-5350 (800) 323-0228 FAX: (708) 678-5111
President: William S. Crommes; **Vice President:** Joan Franzen; **Secretary:** Jean Deehan; **Chief Engineer:** A. A. Hart; **General Manager:** Jeffrey Franzen
 Mass Associates, Langhorne, PA 215-757-6100
 Leslie's Div of Iverco, Inc., Elgin, IL 708-697-5770
 W. Kunz & Associates, Prairie Village, KS 913-48-3535
 Phillips Co., Holland, MI 616-399-3689
 Raven Sales, Dallas, TX 214-490-8230
 Dimension/ Point IX, Lewisville, TX 214-436-706
PRODUCTS: 70-volt amplifiers, mixer amplifiers,

telephone paging amplifiers

Protech Audio Corporation

Flowerfield Bldg. 1
 St. James, NY 11780
 (516) 584-5855 FAX: (516) 584-5904
Director of Marketing: Bill Murphy; **Sales Engineering:** Joseph Glambone
 Peregrine Southwest Reps, Houston, TX 713-589-8481
 First Choice Marketing, Seattle, WA 206-524-7344
 Dimension/ Point IX, Lewisville, TX 214-436-3706
PRODUCTS: 70-volt amplifiers, bi-amp systems, dual-channel, modular amplifiers, monitor amplifiers, signal processing amplifiers, single-channel, telephone paging amplifiers, zone-paging amplifiers

QSC Audio Products, Inc.

1926 Placentia Ave.
 Costa Mesa, CA 92627
 (714) 645-2520 FAX: (714) 645-7927
Chief Executive Officer: Barry Andrews; **Director of Marketing:** Greg McVeigh; **National Sales Manager:** Peter Kalmen; **Vice President/Engineering:** Pat Quilter
 S.F. Marketing, St. Laurent, OU 514-733-5344
 Dimension/ Point IX, Lewisville, TX 214-436-3706

Radio Design Labs

5025 8th Street
 Carpinteria, CA 93013

(805) 684-5415 FAX: (805) 684-9316
Director of Engineering: Joel Bump; **Dir. of Sales & Marketing:** Jerry Clements
 Karp Communications, Tampa, FL 813-968-7098

Ramko Research

3501-4 Sunrise Boulevard
 Rancho Cordova, CA 95742
 (916) 635-3600 (800) 678-1357 FAX: (916) 635-0907
President: Ray Kohfeld; **Operations:** Anita Kohfeld; **Product Manager:** Frank Martinez; **Technical Assistance:** David Baldwin; **National Sales Coordinator:** Mike Pardee
 Sunrise Sales Company, LaMoille, IL 815-638-2660
PRODUCTS: computer-controlled, dual-channel, mixer amplifiers, modular amplifiers, monitor amplifiers, portable, signal processing amplifiers, telephone paging amplifiers, zone-paging amplifiers

**Subscribe to
 Sound &
 Communications
 Magazine**

The ROLLS RA2100 Reference Amplifier sets performance standards for 100 watt per channel power amplifiers. The voltage/current gain MOSFET design lets you run up to clipping without the harshness of transistors. It is ideal for studio and other critical applications. Besides having great s/n and damping ratios, at \$300 it has an unbeatable price/performance ratio.

POWER OUTPUT STEREO: 100 Watts RMS/ch 4 ohm; 70 Watts RMS/ch 8 ohm; bridged mono: 200 WRMS 8 ohm
THD: <.05% (1K Hz & 1 Watt)
IMD (SMPTE): <.005%
S/N RATIO: >95dB A weighted
DAMPING FACTOR: >150
POWER BANDWIDTH: 5Hz—30K Hz +/- 1dB
SLEW RATE: 100 V/ μ S
CONTROLS: 2 Input level power meters (4 ohm)
LIGHTS: Power LED & 4 LED
PHASE SHIFT: <10 DEG
20Hz—20K Hz
INPUT IMPEDANCE: 10K ohm balanced
INPUT CONNECTORS: RCA & 1/4" (mixed)
OUTPUT CONNECTORS: 5 way binding posts, 1/4" phone jacks

ROLLS CORPORATION
 7023 South 400 West
 Midvale, UT, 84047
 Phone 801-562-5628
 Fax 801-562-5655

ROLLS
 MADE IN U.S.A.

Circle 273 on Reader Response Card

Rane Corp.

10802 47th Avenue West
Mukilteo, WA 98275-5098
(206) 355-6000
President: Steve Brakken; CEO: Linda Arink;
V.P. of Manufacturing: Rick Bernard; V.P. of R
& D: Dennis Bohn; V.P. of Marketing: Larry
Winter; National Sales Manager: Ray Bloom
Larry Schirmer, Pontiac, MI 313-340-9588
PRODUCTS: 70-volt amplifiers, bi-amp systems,
zone-paging amplifiers

Rauland-Borg Corp.

3450 W. Oakton St.
Skokie, IL 60076
(708) 679-0900 FAX: (708) 679-0625
President: William Krucks; Executive Vice
President: Kenneth James; National Sales
Manager: Harry Hahn; Marketing Manager:
Vince Novak
Jack Hollis, Geneva, IL 708-208-1488
Joe Clotti, Longwood, FL 407-767-2007
Frank Riha, Austin, TX 512-926-3646
Hank Plaisler, El Toro, CA 714-837-2626
Vince Ward, Vashon Island, WA 206-463-5582
Doug Warren, Newport News, VA 804-930-3217
Suzanne Graham, Kent, OH 216-678-7307
Mike Gulhan, E. Long Meadow, MA 413-525-6090

REVERE INDUSTRIES

1101 Blenville St.
New Orleans, LA 70112
(504) 523-3503 (800) 843-8321 FAX: (504) 525-
6361
Vice President Mktg./Sales: Richard Harris
Camden Marketing, Pierre Fonds, QU 514-683-
3377
PRODUCTS: 70-volt amplifiers, mixer amplifiers,
monitor amplifiers, telephone paging
amplifiers, zone-paging amplifiers

RING COMMUNICATIONS INC.

57 Trade Zone Drive
Ronkonkoma, NY 11779
(516) 585-7464 FAX: (516) 585-7410
President: Peter McLean; Vice President:
Craig Krsanac; Vice President: Kjell (Ken)
Solem
Monfort Electronic Marketing, Indianapolis, IN
317-872-8877
EESCO Systems, Inc., Los Angeles, CA 213-666-
9601
Klumpp Sales Company, Jacksonville, FL 904-
287-5205
The TK Group, Inc., Loveland, CO 303-669-1008
Avwest, Inc., Fountain Hills, AZ 602-946-1811
Gustafson Sales Company, Red Wing, MN 612-
388-4277
Corrigan Agency, Covington, LA 504-893-7455
Pacnor Marketing, Lynnwood, WA 206-771-6016
Kaltex Communications, N. Vancouver, BC 604-
987-1597

Rolls Corp.

6995 South 400 West
Midvale, UT 84047
(801) 562-5628 (800) 736-ROLL FAX: (801) 562-
5655
President: Marilyn DiFrancesco; Vice
Pres./General Manager: David DiFrancesco
Karp Communications, Tampa, FL 813-968-7098
PRODUCTS: dual-channel, monitor amplifiers

**RTS Systems, A Telex Comm.
Company**

9600 Aldrich Avenue South
Minneapolis, MN 55420

(612) 884-4051 FAX: (612) 884-0043
President: Jeffrey Wetherell; Vice President,
Marketing: John Schofield; V.P. Engineering &
Tech.: Joe Winebarger; Sales Manager: Murray
Porteous; Director of Engineering: William
Dennison
Dave Brand, Burbank, CA
Mike Guthrie, Wyckoff, NJ
Rick Fisher, Union Lake, MI
Sunrise Sales Company, LaMolle, IL 815-638-
2660

S.E.M. Co.

#17-636 Clyde Ave.
W. Vancouver, BC V7T 1E1
(604) 922-0526 FAX: (604) 922-0526
President: Elk Ebert; Vice President: Anne
Moretti
Karp Communications, Tampa, FL 813-968-7098
PRODUCTS: 70-volt amplifiers, modular
amplifiers, signal processing amplifiers,
telephone paging amplifiers, zone-paging
amplifiers

SCS Sound Code Systems, Inc.

P.O. Box 2198
Garden Grove, CA 92642
(714) 554-0903 FAX: (714) 554-5643
Karp Communications, Tampa, FL 813-968-7098

SONANCE

961 Calle Negocio
San Clemente, CA 92672
(714) 492-7777 (800) 582-7777 FAX: (714) 361-
2705
President: Scott Struthers; Vice President:
Geoff Spencer; Sales Manager: Dave Donald;
International Sales Manager: Mark Cichowski;
Public Relations Director: Mitch Simon; Dir. Sls
Trn. & Mkt. Research: Kevin Leja
Morris Tait and Assoc., Los Angeles, CA 213-
877-4424
Bach Sales, New York, NY 212-727-0404
Tandem Marketing, Chicago, IL 708-605-1960
Dobbs Stanford, Dallas, TX 214-358-0800
Balaton Marketing, Washington DC, 202-471-
1764
MJA Marketing, St. Charles, MO 314-447-7111
PRODUCTS: bi-amp systems, dual-channel

Soundcraftsmen

2200 S. Ritchey Street
Santa Ana, CA 92705
(714) 556-6191 FAX: (714) 662-0750
Pro. Products Sales Manager: Roger
Hagemeyer
Sounds Distribution, Toronto, Ont., CN 416-
686-4263
Karp Communications, Tampa, FL 813-968-7098
PRODUCTS: 70-volt amplifiers, bi-amp systems,
dual-channel, low-frequency amplifiers,
monitor amplifiers, signal processing
amplifiers, single-channel, telephone paging
amplifiers, tri-amp systems, zone-paging
amplifiers

Soundstream Technologies

120 Blue Ravine Road
Folsom, CA 95630
(916) 351-1288 FAX: (916) 351-0414
President: Donna Haas; Managing Director:
Lee Adams; Director of Engineering: Wade
Stewart; Ntl. Sales Mgr., Home Audio: Scott
McAllister; Sales Engineer, Home Audio:
Andrew Murray
John W. Steinberg Company, Encino, CA 818-
705-7772
Moskau & Associates, Dallas, TX 214-821-4280

Creative Marketing Associates, Nashville, TN
615-831-9690
On Line Marketing, Wadsworth, OH 216-336-
7504
Sound Marketing, Palos Hills, IL 708-598-6888
Cambridge Marketing, Westerville, OH 614-363-
9191
PRODUCTS: dual-channel, signal processing
amplifiers

St. Louis Music

1400 Ferguson Ave.
St. Louis, MO 63133
(314) 727-4512 (800) 727-4512 FAX: (314) 727-
8929
President/Owner: Gene Kornblum; Vice
President, Finance: Don Collins; Operations:
Neal Busch; National Sales Manager: Rick
Breker; Director of Advertising: Suzanne
Wellbaum; Export/ Purchasing: Larry Linkul
Preclde, Morbio Inferiore, Switzerland, 914-
31734
PRODUCTS: 70-volt amplifiers, bi-amp systems,
dual-channel, low-frequency amplifiers, mixer
amplifiers, modular amplifiers, monitor
amplifiers, portable, signal processing
amplifiers, single-channel

Stewart Electronics

11460 Sunrise Gold Circle
Rancho Cordova, CA 95742
(916) 635-3011 FAX: (916) 635-1787
Owner/ President: Wade A. Stewart; Sales/
Marketing Manager: Christopher Dragon;
Sales/Marketing Admin.: Sally Ann Berry;
Director Tech. Services: Bob Hershonow
Dimension/ Point IX, Lewisville, TX 214-436-
3706
PRODUCTS: 70-volt amplifiers, computer-
controlled, dual-channel, low-frequency
amplifiers, monitor amplifiers

STUDIOMASTER INC.

3941 Miraloma Avenue
Anaheim, CA 91719
(714) 524-2227 FAX: (714) 524-5096
President: Paul Reeve; National Sales
Manager: Jim Giordano
J.B. Parent, Dublin, OH 614-764-0064
PRODUCTS: dual-channel, mixer amplifiers

TEI Electronics Inc.

570 W. 18 St.
P.O. Box 246
Hialeah, FL 33011
(305) 888-3980 (800) 327-8811 FAX: (305) 885-
4950
President: Danny Alonso; Vice President:
Mireya A. Muniz; National Sales Manager:
Walter McNulty; Customer Service: John
Tembras; Sales: Orlando Pineda; Sales: Jose
Hurcades
Audio Biz, Mundellin, IL 708-949-0280
PRODUCTS: 70-volt amplifiers, zone-paging
amplifiers

**Order More
Blue Books
Now!**



TOA ELECTRONICS, INC.

601 Gateway Blvd. Suite 300
P.O. Box 2047
S San Francisco, CA 94080
(415) 588-2538 (800) 733-4750 FAX: (415) 588-3349

President: Yoshiro Ishida; Director, Audio Products Div: Richard Krochmal; Director, Comm. Systems Div.: Al Burns; Mgr., Marketing Development: Jeff Pallin; Manager, Western Division: Bill Ford; Manager Engineering Services: Bob Sweet
Chuck McGregor- Product Const, Morris Plains, NJ 201-829-7047

John Murray-Eng.Snd. Mktg. Dev, Springfield, OH 513-324-1993
Bob Hager-Eastern Regional Mgr, Rosewell, GA 404-552-7624

Linda Wick-Central Reg. Mgr., Kansas City, MO 816-453-5775

Robert Slaughter-Cntrl Div Mgr, Houston, TX 713-460-3678

Pete Newmark-West Regional Mgr., Mesa, AZ 602-981-0050

Walter Best, Eastern Reg. Mgr., Sussex, NJ 201-702-0068

PRODUCTS: 70-volt amplifiers, dual-channel, mixer amplifiers, modular amplifiers, single-channel

U.S. Audio

P.O. Box 1075
Rochester, NY 14603
(716) 663-8820 (800) 733-9473 FAX: (716) 865-8930

President: Michael Lalacona; Vice President: Bonnie Gardner; Electrical Engineer: Jim Kelsey; Senior Design Engineer: Carl Cornell
Cambridge Marketing, Westerville, OH 614-363-9191

PRODUCTS: dual-channel, monitor amplifiers

UNIVERSITY SOUND INC.

13278 Rolston Avenue
Sylmar, CA 91342
(818) 362-9516 FAX: (818) 367-5292
President: Robert Sandell; Controller: Mary Coco; National Sales Manager: Greg McLagan;
Design Engineer: Ken Koceski
Jim Burger, Philadelphia, PA 203-297-7160

Subscribe to
**Sound &
Communications
Magazine**

UREI/JBL Professional

8500 Balboa Boulevard
P.O. Box 2200
Northridge, CA 91329
(818) 893-8411 FAX: (818) 893-3639
President: Ronald Means; Vice President, Sales: Ken Lopez; Vice President, Marketing: Mark Gander; Market Manager: Hector Martinez; National Sales Manager: Neil Conley
Jim Chase, San Clemente, CA 714-492-6290
Bill Hamilton, Folsom, PA 215-543-4677
Bill Schuermann, Houston, TX 713-370-5553
Tom Waiter, No. Barrington, IL 312-382-4925
Cambridge Marketing, Westerville, OH 614-363-9191
PRODUCTS: 70-volt amplifiers, dual-channel, low-frequency amplifiers, monitor amplifiers, portable, signal processing amplifiers

Van Etten Audio Labs

P.O. Drawer 667
Shelby, NC 28151-0667
(704) 434-9365
Camden Marketing, Pierre Fonds, QU 514-683-3377

Vibration Technology Ltd.

1950 Ellesmere Road
#12
Scarborough, ON M1H 2V8
(416) 438-9320 FAX: (416) 439-1937
Vice President: Harry Gandhi
Larry Schirmer, Pontiac, MI 313-340-9588
PRODUCTS: 70-volt amplifiers, bi-amp systems, mixer amplifiers, monitor amplifiers, portable, telephone paging amplifiers, zone-paging amplifiers

WHEELOCK, INC.

273 Branchport Avenue
Long Branch, NJ 07740
(908) 222-6880 (800) 631-2148 FAX: (908) 222-8707
President: Peter W. Tarlton; V.P. Finance and Admin.: Joseph P. Henry; Vice President Operations: Douglas E. Phillips; Vice President Sales/Mktg.: William L. Goldstein;
Telephone/Paging Mktg. Mgr.: Arthur Arlow;
Life Safety Mktg. Mgr.: Rein Haus
Joseph P. McCaffrey, Glen Ellyn, IL 708-790-2898
Edward P. Draney, Peachtree City, GA 404-631-3193
Peter Koehler, Los Angeles, CA 213-572-1347
Steve Goldberg, East Windsor, NJ 609-448-1457
Dave Jackowlak, Burbank, IL 708-599-4099
MJA Marketing, St. Charles, MO 314-447-7111
PRODUCTS: 70-volt amplifiers, mixer amplifiers, telephone paging amplifiers

YAMAHA CORP. OF AMERICA

6600 Orangethorpe Ave.
Buena Park, CA 90620
(714) 522-9011 FAX: (714) 739-2680
Sales & Marketing Manager: Gerald W. Tschetter; Pro Digital Sls & Mktg Mgr.: Peter Chalkin; Market Support Manager: Don Bowles
Precide, Morbio Inferiore, Switzerland, 914-31734
PRODUCTS: dual-channel

Your Professional Connection

For Quality Response Use the

MARKETPLACE

ACOUSTICAL / SOUND AND TELEVISION SYSTEMS ENGINEERS

Major audio-visual consulting engineering firm is seeking engineer to design acoustical

SOUND SYSTEM DESIGN AND SALES for expanding independent distributor for Michigan and seeking individual experienced in audio and bidding of commercial and nurse call systems and benefits. Please contact: Class

EQUITY/OWNERSHIP SITUATION WANTED

Two individuals with strong technical experience in software development seeking equity or total ownership in a business.

FOR SALE

Tel System 12 — upgraded with battery backup, extensive software including many programs. Mic. stand, printer, cables, manuals. Must sell. Call: 416-6600-1050

SITUATION WANTED

Experienced audio professional seeking related business opportunities in VA. Formal training in engineering and sound. pro sound hr

Sound & Communications
25 Willowdale Avenue
and significant in

WANTED

ELECTRONIC SERVICE TECH
Established Clientele ■ Excellent Opportunity
Contact: [redacted] rez; Music n, MS 39204

MANUFACTURER'S REPS

Leading manufacturer of Horn/Speaker Assemblies and Baffles seeks

Every Month in **Sound & Communications**

AUDIO SIGNAL PROCESSORS

AB INTERNATIONAL ELECTRONICS INC.

1830-6 Vernon Street
P.O. Box 1105
Roseville, CA 95678
(916) 783-7800 FAX: (916) 784-1050
President: Robert Bird; Vice President,
Marketing: Irwin Laskey; Vice President,
Engineering: George Anderson; Sales/Credit
Manager: Victoria Bird; Chief Engineer: Jeff
Kuells; Order Manager: Kathy Foster
Hanoud and Associates, Rehoboth, MA 508-
677-0701
Pro Audio Marketing, Melville, NY 516-367-8620
Yore Company, White Bear Lake, MN 612-770-
9760
Metro Joe Marketing, Metairie, LA 504-887-1885
Image Marketing, Fountain Valley, CA 714-957-
0641
Crescendo Associates, Hollywood, FL

305-922-9553
Griffith Audio Sales, Marietta, GA 404-924-2725
MBT Marketing, Pittsburgh, PA 412-344-1360
GBS Marketing, Raymore, MO 816-331-1703
Sherwood Associates, Windsor, NY 607-655-
3413
Ludwig Marketing, Bannockburn, IL 708-295-
1700
Rhythm Marketing, Lakeland, FL 813-667-0377
PRODUCTS: crossovers, equalizers, parametric
equatlons

ADA Amplification Systems

73030 Edgewater Dr.
Oakland, CA 94621
(415) 632-1323 (800) 241-8888 FAX: (415) 632-
9358
Eastern Sales Rep.: Eric Schulthels; Western
Sales Rep.: Chris Keller
Sound Sales, Inc., Columbia, MD 301-964-1170

Adams-Smith

34 Tower Street
Hudson, MA 01749
(508) 562-3801 FAX: (508) 568-0404
President: Andrew Simon; Sales Manager:
Allan Nichols; Chief Engineer: Gerald Lester;
Vice President Manufacturing: Gerald Magistri
Adams-Smith, New York, NY 212-490-2281
Adams-Smith, Burbank, CA 818-840-9588
Edwards Company, Inc., Livonia, MI 313-458-
7777

ADAMSON ACOUSTIC DESIGN

850 Brock Road, Suite One
Pickering, ON L1W 1Z8
(416) 420-6279 FAX: (416) 420-0813
President: Brock Adamson; Marketing/Sales
Manager: Jerry Placken; Office Manager:
Lorraine Zerafa
Innovative Sales & Marketing, Irvine, CA 714-
528-2005
Martin Wick, Minneapolis, MN 612-522-2234
Audio Blz, Mundelein, IL 708-949-0280
W3 Marketing, Stone Mountain, GA 404-981-
7021
Tenickl & Associates, Houston, TX 713-528-2005
PRODUCTS: crossovers, digital signal
processors

Advanced Music Systems

Billington Rd.
Burnley, Lancas, UK BB11 5ES
(0281) 2 57011

Order More
Blue Books
Now!

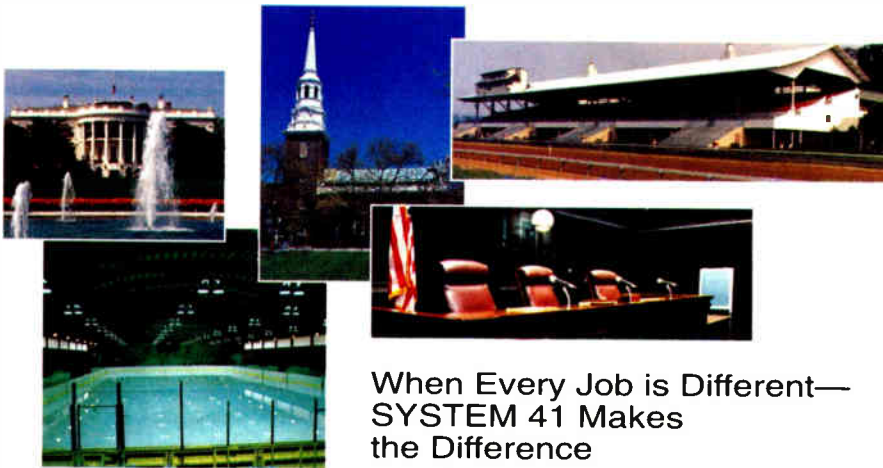

SYSTEM 41

modular signal processing



When Every Job is Different— SYSTEM 41 Makes the Difference

No two installations are alike. From outdoor arenas to reverberant ice rinks to intimate conference rooms, System 41 modular signal processing delivers a cost and space effective solution. Reduce fabrication time by configuring a system from an array of compatible modules. Modular design expands to any future needs. Discover the difference quality, modular signal processing can make in your next job. Call or write for more information.

WE MAKE GREAT SOUND EASY



IRP® professional
sound
products

A division of Knowles Electronics, Inc.

321 Bond Street, Elk Grove Village, IL 60007
Phone: 708-640-9553 or 1-800-255-6993
FAX: 708-640-9607 • TELEX: 701845

**STOP
THEFT!**
*Order a
BLUE BOOK
for everyone
who borrows
yours!*

Send \$12.00 plus
Postage & Handling

**ARTURO LIZARRAGA
Circulation Director**

THE BLUE BOOK
25 Willowdale Ave.
Port Washington
NY 11050

Circle 274 on Reader Response Card

World Radio History

LANDMARKS IN PERFORMANCE.



The AC 22 and AC 23
Electronic Crossovers.

P

Professionals look for those landmark designs that show complete attention to every detail with the most advanced technology available.

The AC 22 and AC 23 Linkwitz-Riley crossovers from Rane are just such achievements in crossover design, combining such innovative features as:



- 24dB/octave slopes.
- Built-in electronic phase alignment.
- Automatic internal configuration switching.
- 41-detent frequency selection, and more.

Capabilities like this can deliver cleaner, more consistent sound quality with less fussing.

As a professional you deserve nothing less than landmark performance. Advanced crossover technology from Rane.

RANE

10802-47th Ave. W.
Everett, WA 98204
(206)355-6000

AKG Acoustics, Inc.

1525 Alvarado Street
San Leandro, CA 94577
(510) 351-3500 FAX: (510) 351-0500
President (USA): S. Richard Ravich; Marketing
Manager: David Roudebush; Vice President
Operations: Derek Pilkington; Director of
National Sales: David Angress; Sales Manager
(C&S America): Jesse Maxenchs
Jeff Radke, Midwest Reg. Mgr., Appleton, WI
414-749-0044
Jim Burger, Philadelphia, PA 203-297-7160
PRODUCTS: digital effects, digital reverbs,
digital delays, digital signal processors

Alesis

3630 Holdrege Avenue
Los Angeles, CA 90016
(213) 467-8000 (800) 5-ALESIS FAX: (213) 836-
9192
President, COO: Russell Palmer; V.P. Sales and
Marketing: Ralph Goldhelm; V.P. Advertising &
Promotion: Allen Wald; Regional Sales
Manager: Ted Keffalo; Regional Sales Manager:
Doug White
Cambridge Marketing, Westerville, OH 614-363-
9191
PRODUCTS: 1/3 octave equalizers,
compressors, digital effects, digital reverbs,
digital delays, digital signal processors,
equalizers, graphic equalizers, limiters, noise
gates

Altec Lansing Corp.

10500 W. Reno
Oklahoma City, OK 73128
(405) 324-5311 FAX: (405) 324-8981
President: Dave Merrey; Vice President, Sis. &
Mktg: Chuck Lange; National Sales Manager:
Jerry Spriggs; Manager Export Marketing:
John Sexton; Technical Services Manager: Gary
Jones; Customer Services Manager: Jim
Brown
Dave Read, McKinney, TX 214-542-6328
Jim Faber, Shreveport, LA 318-631-1766
Paul Froula, Lombard, IL 708-268-1831
Alan Feckanin, Port St. Lucie, FL 407-879-1078
George Soti, Philadelphia, PA 215-637-3429
Larry Schirmer, Pontiac, MI 313-340-9588
Stu Moffit, Renton, WA 206-277-8851
PRODUCTS: 1/3 octave equalizers, ambient
noise level controllers, automatic/
programmable equalizers, compressors,
crossovers, equalizers, graphic equalizers,
interface units, limiters, octave equalizers

AMEK/TAC U.S. Operations

10815 Burbank Boulevard
N. Hollywood, CA 91601
(818) 508-9788 FAX: (818) 508-8619
Operations Manager: Sue Jones; National Sales
Manager: Steve Harvey; National Service
Manager: Ray Dillfield; Sales Manager: Ed
Bigger; Service Engineer: Dennis Goettsch;
Administrative Assistant: Lisa Kennedy
Bedford Audio Marketing, Atlanta, GA 404-636-
0070
The Henderson Company, Concord, MA 508-
287-0020
Marketing Concepts, Irving, TX 214-869-0069
Sigmnet, Freehold, NJ 201-462-1221
J.B. Parent, Dublin, OH 614-764-0064
Nova Marketing, San Francisco, CA 415-952-
0943
PRODUCTS: automatic/ programmable
equalizers, limiters, noise gates, parametric
equations

AMS Industries, Inc.

7 Parklawn Dr.
Bethel, CT 06801
(203) 792-4997 FAX: (203) 730-8549
President: John Gluck; Nat. Sales Mgr., Stand.
Prod: Adrian Weldmann
Gus Skinas, Hollywood, CA 213-957-2265
Michael Mueller-Sen. Sis. Eng., New York, NY
212-956-2907
Douglas Ordon-Sen. Sis. Eng., Chicago, IL 312-
645-9888
Tom Semmes-S.E. Reg. Sis. Mgr., Nashville, TN
615-329-9584
Soundings Inc., Seattle, WA 206-624-1317
ADCOM, Toronto, ON 416-251-3355
PRODUCTS: digital effects, digital reverbs,
digital delays

Ancha Electronics Inc.

5540 Meadowbrook Court
Rolling Meadows, IL 60008-3800
(708) 437-7712 FAX: (708) 437-0271
President: Robert F. Ancha; Vice President,
Finance: Margaret Broch; Vice President, Sales
& Mktg: Steve Youngson; Vice President,
Design: Richard Tollberg; Vice Pres.,
Administration: R.C. Ancha
Ancha Electronics Inc., Atlanta, GA 404-446-
5894
Ancha Electronics Inc., Tampa, FL 813-626-0350
Nova Marketing, San Francisco, CA 415-952-
0943

ANTEX ELECTRONICS CORP.

16100 S. Figueroa
Gardena, CA 90248
(213) 532-3092 (800) 338-4231 FAX: (213) 532-
8509
President: James P. Antrim; Vice President
Sales: Richard Gross; Product Sales Manager:
Robert Bird
Greg Dzubay & Assoc., Glendale, AZ 800-999-
0006
PRODUCTS: compressors, digital encoding,
digital signal processors, interface units

Aphex Systems

11068 Randall Street
Sun Valley, CA 91352
(818) 767-2929 FAX: (818) 767-2641
President: Marvin Caesar; Vice President:
Hugh Wilcox; Sales Manager: Paul
Freudenberg
Gould Marketing, Inc., Montreal, Quebec, 514-
342-4441
Clueco Pro Division, Paris, France, 331-
43596159
AKG Acoustics, Munich, Germany, 498-9 87
160
Otaritec Corporation, Tokyo, Japan, 813-392-
7811
Sound Technology, Letchworth, UK 444-
62480800
Nova Marketing, San Francisco, CA 415-952-
0943
PRODUCTS: compressors, equalizers, levelers,
limiters, noise gates, notch filters, parametric
equations, signal enhancers, VCA's

Apogee Electronics Corporation

2103 Main Street
Santa Monica, CA 90405
(213) 399-2991 FAX: (213) 399-7665
President: Bruce Jackson; Vice President
Sales: Betty Bennett; Chief Engineer: Sheldon
Lampson; Buyer/Planner: Steven R. Graves;
Marketing/PR Manager: Jon Wessien; Office
Manager: Sarah Villanueva

Holland Marketing, Bloomington, MN 612-881-
8425
PRODUCTS: digital effects, digital encoding,
digital delays, digital signal processors,
interface units, signal enhancers, signal
metering

**Applied Research and
Technology Inc**

215 Tremont Street
Rochester, NY 14608
(716) 436-2720 FAX: (716) 436-3942
President: Philip A. Betette
Karp Communications, Tampa, FL 813-960-7667
PRODUCTS: 1/3 octave equalizers, ambient
noise level controllers, automatic/
programmable equalizers, compressors, de-
essers, digital effects, digital reverbs, digital
delays, digital signal processors, equalizers,
graphic equalizers, limiters, noise gates,
octave equalizers

ARX

P.O. Box 842
Silverado, CA 92676
(714) 649-2346 FAX: (714) 649-3064
Director: Algis Renkus
Quad Tech, Shawnee Mission, KS 913-677-1013
SC Music, Cambridge, MA 617-876-9870
On Line Marketing, Wadsworth, OH 216-336-
7504
Evans Sales & Marketing, Nashville, TN 615-297-
7997
Syncopated, Silver Springs, MD 301-593-6610
Nova Marketing, San Francisco, CA 415-952-
0943
PRODUCTS: 1/3 octave equalizers,
compressors, crossovers, equalizers, graphic
equalizers, limiters, noise gates, parametric
equations, signal enhancers

Ashly Audio, Inc.

100 Fernwood Ave.
Rochester, NY 14621
(716) 544-5191 (800) 828-6308 FAX: (716) 266-
4584
President: Bill Thompson; Senior Vice
President: Bob French; Vice President: Dave
Malloy; Operations Manager: Ellen Price
ADCOM, Toronto, ON 416-251-3355
PRODUCTS: 1/3 octave equalizers,
compressors, crossovers, de-essers,
equalizers, graphic equalizers, limiters, noise
gates, notch filters, parametric equations

ATI-Audio Technologies Inc.

328 W. Maple Avenue
Horsham, PA 19044
(215) 443-0330 FAX: (215) 443-0394
President: Samuel B. Wenzel; Vice President:
Edward M. Mullin
PRODUCTS: de-essers, equalizers, levelers,
limiters, noise gates, parametric equations,
signal metering, transcription preamps



HOW TO LEVEL A HOTEL FOR UNDER \$350.

DOD graphic equalizers are veritable workhorses for improving public address sound quality in airports, shopping malls, hotels and public buildings.

That's because DOD makes more configurations of quality graphic EQs for more professional applications, than any other company in the world. For a lot less than you'd expect.

For a demonstration, see your professional audio dealer or sound contractor.

He'll recommend DOD with no reservations.

©1988 DOD Electronics Corporation. 5639 So. Riley Lane, Salt Lake City, Utah 84107. (801) 268-8400.



R-431 Graphic Equalizer (top) R-830 Graphic Equalizer (bottom)

Circle 217 on Reader Response Card

World Radio History

Audio Logic

5639 S. Riley Lane
Salt Lake City, UT 84107
(801) 268-8400 (800) 453-7484 FAX: (801) 262-4966

President: John Johnson; Vice President, Int'l Sales: Wayne Morris; Vice President, Domestic Sales: Scott Grow; Marketing Manager: Rick Bos J.B. Parent, Dublin, OH 614-764-0064
PRODUCTS: 1/3 octave equalizers, compressors, crossovers, de-essers, digital delays, graphic equalizers, limiters, noise gates, signal enhancers

Audio Systems Co.

1815 Michigan Ave.
Bismarck, ND 58504
(701) 223-3800 (800) 852-6522 FAX: (701) 222-8102

President: Lynn Mader; Vice President: Lyle Mader
Leslie Inc., Elgin, IL 708-697-6677
Doug Warren, Newport News, VA 804-930-3217
PRODUCTS: ambient noise level controllers, limiters, noise gates, VCA's

Audio Technology

P.O. Box 68487
Schaumburg, IL 60173
(708) 240-5113 FAX: (708) 240-5421
Vice President Sales: J. Hildebrandt
Nova Marketing, San Francisco, CA 415-952-0943
PRODUCTS: signal metering

Audio/Digital

8500 Balboa Blvd.
P.O. Box 2200
Northridge, CA 91329
(818) 893-8411 FAX: (818) 893-3639
President: Ronald Means; Vice President, Sales: Ken Lopez; Vice President, Marketing: Mark Gander; Market Manager: Hector Martinez; Sales Manager: Neil Conley
Jim Chase, San Clemente, CA 714-492-6290
Bill Hamilton, Folsom, PA 215-543-4677
Bill Schuermann, Houston, TX 713-370-4925
Tom Walter, No. Barrington, IL 708-382-4925
Preclde, Morbio Inferiore, Switzerland, 914-31734
PRODUCTS: crossovers, digital delays

Azden

147 New Hyde Pk Rd.
Franklin Square, NY 11010
(516) 328-7500
J.B. Parent, Dublin, OH 614-764-0064

BBE SOUND, INC.

5500 Bolsa Ave. Ste. #245
Huntington Bch., CA 92649
(714) 897-6766 (800) 233-8346 FAX: (714) 895-6728
Chairman: John C. McLaren; National Sales Manager: Rob Rizzuto; Director of Engineering: Paul Gagon
Marshank Sales Co., Los Angeles, CA 213-670-7071

StarIn Marketing, Chesterton, IN 219-929-4127
First Choice Marketing, Seattle, WA 206-365-4568
The Henderson Company, Concord, MA 508-287-0020
John B. Anthony Co., Stamford, CT 203-322-9202
Nova Marketing, San Francisco, CA 415-952-0943
PRODUCTS: signal enhancers

Brooks Electronic System Technology

4061 E. La Palma Ave., Ste. B
Anaheim, CA 92807
(714) 630-2383

Bryston/ Brystonvermont, Ltd.

979 Franklin Lane
Maple Glen, PA 19002
(215) 628-4255 (800) 673-7899 FAX: (215) 628-2970
Vice President: Martin Bartelstone; President: John Russel
J.B. Parent, Dublin, OH 614-764-0064
PRODUCTS: crossovers

BSS Audio/ Div. of AKG

1525 Alvarado St.
San Leandro, CA 94577
(415) 351-3500 (800) 243-7885 FAX: (415) 351-0500
National Sales Manager: Dave Talbot
Dave Talbot, Pleasant Valley, NY 914-635-9000
Nova Marketing, San Francisco, CA 415-952-0943
PRODUCTS: 1/3 octave equalizers, compressors, crossovers, de-essers, digital delays, equalizers, graphic equalizers, limiters, noise gates

Chandler Industries

590 19th Street
San Francisco, CA 94107
(415) 626-1742 (800) 776-4327
FAX: (415) 626-0671
President: Paul Chandler; Vice President: Adrian Chandler
Taub Sales, Silver Springs, MD 301-662-9100
PRODUCTS: digital delays, signal enhancers

CLARITY

1111 Industry Avenue, S.E.
Roanoke, VA 24013
(703) 982-7003 (800) 962-6009 FAX: (703) 982-7032
President: John W. Mason; Sales Coordinator: Linda T. Bishop; Product Manager: John D. Spencer
Featherstone Sales, Los Gatos, CA 408-356-3243
Unirep Inc., Valrico, FL 813-681-3477
M.I.N.K. Associates, Overland Park, KS 913-341-2112
Gerald Horne Associates, Stow, MA 508-897-1741
Fortl Associates, Kensington, MD 301-949-1706
Holland Marketing, Bloomington, MN 612-881-8425
Adams & Associates, Greensboro, NC 919-272-6838
Reptronics Inc., New Madison, OH 800-888-0530
Dick Belew Sales, Dallas, TX 214-644-7881
PRODUCTS: octave equalizers

Dan Dugan Sound Design

290 Napoleon St.
San Francisco, CA 94124
(415) 821-9776 FAX: (415) 826-7699
Proprietor: Dan Dugan
Doug Warren, Newport News, VA 804-930-3217

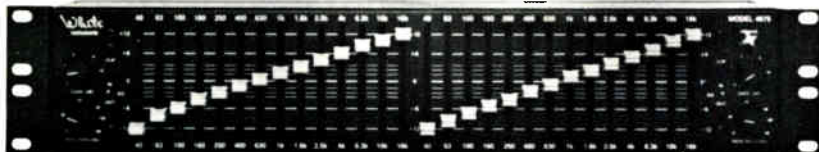
**THE MODEL
4675****LESS is MORE**

With half as many controls to deal with, this 2 channel, 2/3 octave equalizer is designed to offer "on-the-fly" equalization with greater operator control.

You will accomplish subjective equalization of a microphone or loudspeaker with broad and ripple-free responses.

The Model 4675 is another in White Instruments exceptional family of equalizers.

For information phone us today!

P.O. Box 698
Austin, Tx 78767



Phone 512/389-3800
FAX 512/389-1515

Circle 272 on Reader Response Card

dbx Professional Products-AKG

1525 Alvarado Street
San Leandro, CA 94577
(415) 351-3500 FAX: (415) 351-0500
President (U.S.A.): S.R. Ravich; Vice President (U.S.A.): Derek Pilkington; Marketing Manager (U.S.A.): David Roudébusch; Marketing Manager (Int'l): Howard Mullinack; Sales Manager (S. America): Jesse Maxenchs
Jeff Radke, Appleton, WI 414-749-0044
Edwards Company, Inc., Livonia, MI 313-458-7777
PRODUCTS: 1/3 octave equalizers, ambient noise level controllers, compressors, de-essers, levelers, limiters, noise gates, parametric equalizers, octave equalizers, signal enhancers

DigiTech

5639 South Riley Ln.
Salt Lake City, UT 84107
(801) 268-8400 (800) 453-7484 FAX: (801) 262-4966
President: John Johnson; Vice President, Int'l Sales: Wayne Morris; Vice President, Domestic Sls: Scott Grow; Marketing Manager: Rick Bos
PRODUCTS: 1/3 octave equalizers, automatic/programmable equalizers, digital effects, digital reverbs, digital delays, digital signal processors, graphic equalizers

DOD Electronics

5639 South Riley Lane
Salt Lake City, UT 84107
(801) 268-8400 (800) 453-7484

FAX: (801) 262-4966
President: John Johnson; Vice President, Int'l Sales: Wayne Morris; Vice President, Domestic Sls: Scott Grow; Marketing Manager: Rick Bos
Edwards Company, Inc., Livonia, MI 313-458-7777
PRODUCTS: 1/3 octave equalizers, compressors, crossovers, de-essers, digital effects, digital reverbs, digital delays, graphic equalizers, limiters, noise gates

Dolby Laboratories

100 Potero Ave.
San Francisco, CA 94113
(415) 558-0200 FAX: (415) 863-1373
Chairman: Ray Dolby; President: Bill Jasper; V.P., Marketing & Licensing: Ed Schummer; Director of Marketing: Bill Mead
Dolby Laboratories, Los Angeles, CA 213-464-4596
Dolby Laboratories, New York, NY 212-767-1700
Dolby Laboratories, London, England, 71-720-1111

Dorrough Electronics

5221 Collier Place
Woodland Hills, CA 91364
(818) 999-1132 FAX: (818) 998-1507
President: Michael Dorrough
Allied Broadcast Equipment, Richmond, IN 317-962-8596
Bradley Broadcast Sales, Gaithersburg, MD 301-948-0650
Midwest Communications, Highland Hts., KY 606-781-2200

Westlake Audio, Los Angeles, CA 213-851-9800
Winfield Scott & Assoc, Grapevine, TX 303-582-3433
Edwards Company, Inc., Livonia, MI 313-458-7777
PRODUCTS: compressors, digital signal processors, limiters, signal metering

Drawmer/QMI

15 Strathmore Road
Natick, MA 01760
(508) 650-9444 FAX: (508) 651-9476
President: Scott Berdell
Edwards Company, Inc., Livonia, MI 313-458-7777

Dukane Corp.

2900 Dukane Drive
St. Charles, IL 60174
(708) 584-2300 FAX: (708) 584-2370
President/C.E.O.: J. McWilliams Stone Jr.; Pres./Comm. Systems Division: Steven L. Deppe; National Sales Director: Warren T. Anderson; Service Manager: Cliff Carlson
Wally Smutts, Toronto, ON 519-748-5352
Doug Fellabaum, Sycamore, IL 815-895-7573
Ken Lind, Boston, MA 617-235-6817
Pete Kendall, Jacksonville, FL 904-262-6025
Jim Lacey, Moreno Valley, CA 714-243-1160
Jack Brown, Dallas, TX 214-943-7528
Sanford Lange, Indianapolis, IN 317-251-3112
PRODUCTS: 1/3 octave equalizers, compressors, crossovers, noise gates, notch filters, octave equalizers

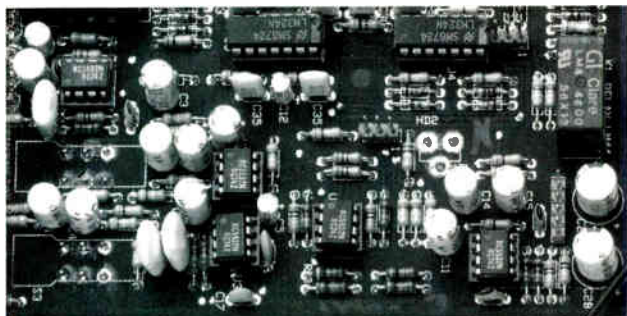

Timed audio turn on during power up.

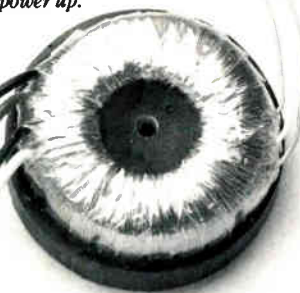

Torroidal transformer for greatly reduced AC hum.

1% polypropylene capacitors and 1% metal film resistors for accuracy and stability; 5532 opamps used for low noise and high slew rate.

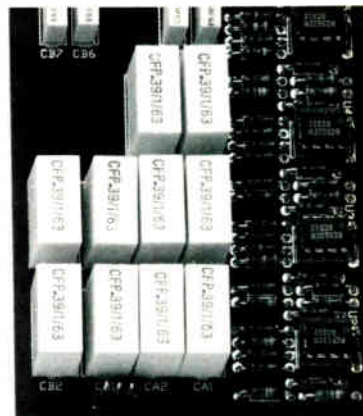

NO GUTS. NO GLORY.

It takes guts to compare yourself to the best names in the industry.

The Audio Logic SC31 is a powerful EQ designed for professional use. It offers 31 1/3 octave centered bands with selectable 6 dB or 12 dB of boost and cut.

Look at the chart* In every category the SC31 delivers better specs plus incomparable sound quality.



	Audio Logic SC31	RANE GE 30	JBL/Urei 5547A	Klark Teknik DN 300
Noise	Less than -90 dBm	Less than -90 dBm	Less than -90 dBm	Less than -90 dBm
Maximum Output	+27 dBm	+24 dBm	+22 dBm	+22 dBm
Dynamic Range	+117 dBm	+114 dBm	+112 dBm	+112 dBm
Frequency Response	18 Hz to 30 kHz +/-0.5 dB	10 Hz to 40 kHz +/-0.3 dB	20 Hz to 20 kHz +/-2 dB	20 Hz to 20 kHz +/-0.5 dB
Number of Bands	31	30	30	30
THD plus noise	Less than .005% @ +22 dBm @ 1 kHz	Less than .01% @ +4 dBm	Less than .5% @ +22 dBm	Less than .01% @ +4 @ 1 kHz
Suggested Retail Price	\$550.00	\$749.00	\$849.00	\$1,050.00

With this much quality and technology, why shouldn't we display more than a little intestinal fortitude?

Manufactured in the U.S.A. For more information, contact Audio Logic, 5639 So. Riley Lane, Salt Lake City, Utah 84107. (801) 268-8400.

*All specs taken from manufacturers' published literature.



Circle 236 on Reader Response Card

World Radio History

Dynacord

200 Sea Lane
 Farmingdale, NY 11735
 (516) 249-3660 FAX: (516) 420-1863
 President: Jack Kelly; Sales Manager: Sam Spennacchio
 C.L. Pugh & Associates, Cleveland, OH 216-238-1777

Ecler/TEI Electronics

570 W. 18 Street
 P.O. Box 246
 Hialeah, FL 33010
 (305) 888-3980 (800) 327-8811 FAX: (305) 885-4950
 President: Danny Alonso; Vice President: Mireya A. Muniz; National Sales Manager: Walter McNulty; Sales: Orlando Pineda; Sales: Jose Hircades; Customer Service: John Tembras
 Greg Dzuby & Assoc., Glendale, AZ 800-999-0006
 PRODUCTS: crossovers, equalizers, signal enhancers

EDCOR ELECTRONICS

7130 National Parks Hwy
 P.O. Box 5098
 Carlsbad, NM 88220
 (505) 887-6790 (800) 854-0259 FAX: (505) 887-6880
 Sales: P. Weston; Engineering: Brian Weston
 Greg Dzuby & Assoc., Glendale, AZ 800-999-0006

"With the BBE® system, it sounded cleaner, crisper, brighter, & simply put... BETTER!"

DJ Times Magazine



"BBE is the most inexpensive way to stand out from the competition. BBE is easy to use and will make your music so exciting, you'll be booked solid!"

DJ Times Magazine

BBE Sound Inc. Huntington Beach, CA
 (714) 897-6766

ASK YOUR DEALER FOR A DEMO TODAY

Circle 292 on Reader Response Card

ESE

142 Sierra Street
 El Segundo, CA 90245
 (213) 322-2136 FAX: (213) 322-8127
 President: Jerry Johnson; Vice President/Sales Manager: Bob Mayers; Marketing Manager: Brian Way; General Manager: Bill Kaiser
 Cambridge Marketing, Westerville, OH 614-363-9191
 PRODUCTS: Interface units, signal metering

Esoteric Sound

4813 Wallbank Avenue
 Downers Grove, IL 60515
 (708) 960-9137
 Owner: Mike Stosich
 Greg Dzuby & Assoc., Glendale, AZ 800-999-0006

Eventide Inc.

One Alsan Way
 Little Ferry, NJ 07643
 (201) 641-1200
 President: R. Factor; Sales Manager: G. Griffith

FGS Intergalactic Cartel & Holding Co

P.O. Box 619
 Topanga, CA 90290-0619
 (213) 455-2802
 President: Boris D. Gato; Vice President: Betsy L. Perro; Senior Scientist: Dennis Fink; Senior Marketer: Mark Gander; Senior Engineering: Neil Shaw
 Greg Dzuby & Assoc., Glendale, AZ 800-999-0006

FOSTEX CORPORATION OF AMERICA

15431 Blackburn Ave.
 Norwalk, CA 90650
 (213) 921-1112 (800) 7-FOSTEX FAX: (213) 802-1964
 V.P. Marketing/ General Mgr.: Robert Verl; V.P. Sales: Mark Cohen
 J.B. Parent, Dublin, OH 614-764-0064
 PRODUCTS: audio/video synchronizers

Furman Sound, Incorporated

30 Rich Street
 Greenbrae, CA 94904
 (415) 927-1225 FAX: (415) 927-4548
 President: Jim Furman; Vice President: Susan Furman; Sales Manager: Joe Desmond; Chief Engineer: Gary Kephart
 Metropolis Audio Marketing, New York, NY 908-225-0085
 Pacific Audio Group, Gardena, CA 213-719-1383
 SF Marketing, St. Laurent, QU 514-733-5344
 New Horizons, Bannockburn, IL 708-234-6500
 Secom Systems, Atlanta, GA 404-455-0672
 Greg Dzuby & Assoc., Glendale, AZ 800-999-0006
 PRODUCTS: 1/3 octave equalizers, compressors, crossovers, de-essers, equalizers, graphic equalizers, limiters, noise gates, parametric equations, signal metering

Gliderfluke & Co.

820 Thompson Avenue #35
 Glendale, CA 91201
 (818) 546-1618 FAX: (818) 546-1619
 Owner: Doug Mobley; Marketing: Denise Dougherty
 Greg Dzuby & Assoc., Glendale, AZ 800-999-0006
 PRODUCTS: equalizers, VCA's

INNOVATIVE ELECTRONIC DESIGNS, INC.

9701 Taylorsville Rd.
 Louisville, KY 40299
 (502) 267-7436 FAX: (502) 267-9070
 President: Hardy Martin; Vice President, Mkt'g & Sales: Tom Roseberry; Sales Application Engineer: Mark Lewellyn; V.P. Research & Development: Bob Ponto; Vice President, Engineering: Ed Young; Vice President, Software: John Johnson
 Yore Company, White Bear Lake, MN 612-770-9760
 Steffey Marketing Assoc. Inc., Northbrook, IL 708-480-3575
 WesTech Marketing, Culver City, CA 213-870-9286
 Repworks, Chicopee, MA 413-533-0845
 Darmstedter Associates, Baldwinsville, NY 315-638-1261
 John Anthony, Stamford, CT 203-322-9202
 Bencsik Associates, Ocala, FL 904-732-9775
 C.L. Pugh, Cleveland, OH 216-238-1777
 Monford Electronic Marketing, Indianapolis, IN 317-872-8877
 C.M. Sales, Farmington Hill, MI 313-553-8070
 B.C. Electronic Sales, Mission, KS 913-262-1720
 Marketing Concepts, Irving, TX 214-869-0669
 Torbett/Kelser Group, Loveland, CO 303-669-1008
 Pius Four Marketing, Walnut Creek, CA 415-937-0650
 North Shore Marketing, Seattle, WA 206-284-9699
 Island Instruments, Kaneohe, HI 808-235-7544
 PRODUCTS: ambient noise level controllers, digital effects, digital encoding, interface units, noise gates, signal enhancers, VCA's

Inovonics

1305 Fair Ave.
 Santa Cruz, CA 95060
 (408) 458-0552

IRP, A KNOWLES COMPANY

321 Bond Street
 Elk Grove VII., IL 60007
 (708) 439-3600 (800) 255-6993 FAX: (708) 640-9607
 Vice President, General Mgr.: Brian Benn; Marketing Manager: Roger Carroll; Senior Sales Engineer: Gayle Campbell; Marketing Coordinator: Laura Valavclus; Applications Engineer: Norm Kinnaugh; Product Engineering Manager: Mitch Bentz
 Piper and Civan Assoc., Needham, MA 617-449-1144
 Sigmot Corp., Freehold, NJ 201-462-1221
 Richard S. Pass Associates, Langhorne, PA 215-757-6100
 Henry W. Phillips Co., Rosewell, GA 404-992-3070
 Bencsik Associates, Ocala, FL 904-732-9775
 C.B. Electronic Marketing, Arvada, CO 303-422-0561
 AWwest Inc., Fountain Hills, AZ 602-946-1811
 EESCO Systems Inc., Los Angeles, CA 213-666-9601
 Pappas Consulting, Menlo Park, CA 415-324-4325
 Chuck Olson Assoc., Renton, WA 206-271-5416
 Kaltec Communications, North Vancouver, BC 604-987-1597
 More Technologies Inc., Los Angeles, CA 213-474-4211
 Audio Marketing Assoc., Brecksville, OH 216-526-2426
 StarIn Marketing, Chesterton, IN 219-929-4127

Is There A Point When Out Of Control Becomes Complete Control?



Yes. The Moment You Plug In The New CEX-4L

*From Peavey
Architectural Acoustics®*

When we say complete control, we mean it. The CEX-4L from Peavey Architectural Acoustics is a totally programmable, all digital audio processor that redefines the role of a multi-way sound system controller. The CEX-4L provides ultimate control of even the most difficult rooms, with surprising options you never thought available in a crossover at this price — or any price, for that matter.

The versatility of the CEX-4L will amaze the most discriminating sound engineer. For example, the CEX-4L may be configured as a crossover — four-way, two-way stereo, three-way with a fourth full range (or band limited) delayed output — or it can become a one or two input multi-tap delay. In either application, each of the four outputs can be delayed, equalized, peak limited, and /or bandwidth limited with a choice of six filter selections, including eighth order Linkwitz-Riley filters with 48 dB per octave slopes. An adjustable horn EQ, a one band parametric EQ, or low and high frequency shelving filters can be selected for each output. Precise peak limiters provide driver protection while maintaining musicality to system performance. The selective “linking” feature allows the limiters to track, preserving the spectral balance. Set-up and functionality come quickly and intuitively. The control panel is simple and straightforward with labeled buttons for the various features and a 20 x 2 backlit LCD display. A “data entry wheel” has been included for rapid system calibration, plus a built-in security lock, selective polarity reversal, and muting on each of the four outputs. The totally software-based CEX-4L also allows for essentially effortless field upgradeability, meaning that the CEX-4L will never become obsolete. Yet, we saved the very best for last...audio integrity comparable to high performance DAT recorders. The new CEX-4L all digital audio processor from Peavey Architectural Acoustics. The technology is here. The time is now. Experience the feeling of control...COMPLETE control!

Circle 213 on Reader Response Card

PEAVEY
ARCHITECTURAL ACOUSTICS®

MJA Marketing, St. Charles, MO 314-447-7111
Graham Davls Inc., Dallas, TX 214-357-7677
PRODUCTS: 1/3 octave equalizers, automatic/
 programmable equalizers, compressors,
 crossovers, digital effects, digital delays, digital
 signal processors, equalizers, graphic
 equalizers, interface units, levelers, limiters,
 noise gates, parametric equations, octave
 equalizers, VCA's

lvie Technologies Inc.

1366 West Center
 Orem, UT 84057
 (801) 224-1800 FAX: (801) 224-7526
President: Craig Berry; **Vice President,**
Marketing: Glenn Meyer; **Vice President,**
Product Mgt.: Larry Driskill; **Sales Coordinator:**
 Georgla Hall; **Production Vice President:** Bob
 Greene
Western Audio Sales, Burbank, CA 818-954-9300
Metropolis Audio Marketing, Edison, NJ
 201-225-0085
Meyer Marketing, Deerfield Beach, FL
 305-481-9250
Radon and Associates, Sacramento, CA
 916-923-2524
Loppnow and Associates, Issaquam, WA
 206-392-3936
Multi-Technical Reps., Brainerd, MN
 218-828-9483

JBL Professional

8500 Balboa Boulevard
 P.O. Box 2200
 Northridge, CA 91329
 (818) 893-8411 FAX: (818) 893-3639
President: Ronald Means; **Vice President,**
Sales: Ken Lopez; **Vice President, Marketing:**
 Mark Gander; **Market Manager:** Hector
 Martinez; **National Sales Manager:** Nell Conley
 Jim Chase, San Clemente, CA 714-492-6290
 Bill Hamilton, Folsom, PA 215-543-4677
 Bill Schuermann, Houston, TX 713-370-5553
 Tom Walter, No. Barrington, IL 312-382-4925
 ADCOM, Toronto, ON 416-251-3355
PRODUCTS: 1/3 octave equalizers, ambient
 noise level controllers, crossovers, equalizers,
 graphic equalizers, limiters, parametric
 equations, octave equalizers

Klark-Teknik Electronics Inc.

200 Sea Lane
 Farmingdale, NY 11735
 (516) 249-3660 FAX: (516) 420-1863
President: Jack Kelly; **Sales Manager:** Sam
 Spennacchio
Multi-Technical Reps., Brainerd, MN 218-828-
9483

Lectrosomics, Inc.

P.O. Box 15900
 Rio Rancho, NM 87174
 (505) 892-4501 (800) 821-1121 FAX: (505) 892-
 6243
President: John Arasim; **Vice President**
Engineering: Larry Fisher; **Vice President Mktg**
& Sales: Bruce Jones
 C.L. Pugh & Associates, Cleveland, OH 216-238-
 1777
PRODUCTS: 1/3 octave equalizers, automatic/
 programmable equalizers, compressors,
 crossovers, equalizers, levelers, limiters, notch
 filters, VCA's

Lexicon Inc.

100 Beaver Street
 Waltham, MA 02154
 (617) 891-6790 FAX: (617) 891-0340
President: Ron Noonan; **Vice Pres. Sales &**
Marketing: Daniel D. Roberts; **Vice President**

Finance: Harvey Schein; **Vice President**
Engineering: Chuck Bagnaschl
Audio Etc., St. Peters, MO 314-278-4130

LynTec

7030 Grandview
 Merriam, KS 66204
 (913) 722-4047 FAX: (913) 432-4157
Owner: Lynn Potter
Audio Etc., St. Peters, MO 314-278-4130
PRODUCTS: ambient noise level controllers

Marshall Electronic

P.O. Box 438
 Brooklandville, MD 21022
 (301) 484-2220 FAX: (301) 486-0280
President: Stephen St. Croix; **Managing**
Director: Pirkko Polso
 Loomis and Associates, Fremont, CA 415-683-
 0883

Marshall Long Acoustics

13636 Riverside Dr. Sherman Oaks, CA 91423
 (818) 981-8005 FAX: (818) 981-9418
President: Marshall Long;
Chief Engineer: Bill Isenberg
 Precide, Morbio Inferiore, Switzerland,
 914-31734

Meyer Sound Laboratories Inc.

2832 San Pablo Ave, Berkeley, CA 94702
 (415) 486-1166 FAX: (415) 486-8356
Vice President, Sales & Mktg: Helen Meyer;
Marketing Manager: Ralph Jones; **Director of**
Technical Mkt'g: Mark Johnson; **Customer**
Service Manager: Scott Giedhill;
National Sales Manager: Cindy Ramos
 Loomis and Associates, Fremont, CA
 415-683-0883
PRODUCTS: equalizers, parametric equations

MicroAudio Inc.

3025 SW Canby St. Portland, OR 97219-2470
 (503) 293-1782 (800) 445-1248
 FAX: (503) 293-0562
President: Eugene Rimkelt; **Director of**
Marketing: H.C. "Bud" Garrison; **Director of**
Engineering: Richard Schomburg; **Sales**
Manager: Greg Johnson
 Derek Allen, Los Angeles, CA 818-840-8327
 Powerlines, Evanston, IL 708-864-1147
 Sigmat, Valley Forge, PA 215-783-6666
 Worldwide, Ft. Lauderdale, FL 305-584-7024
 Online, Wadsworth, CA 216-336-7504
 Sound Sales, Inc., Columbia, MD 301-964-1170
PRODUCTS: 1/3 octave equalizers, automatic/
 programmable equalizers, equalizers, octave
 equalizers

OptoDigital Design Inc.

8920 Business Park Drive #435, Austin, TX 78759
 (512) 338-4707 FAX: (512) 794-9997
CEO: Rodney Herman; **V.P., Sales and**
Marketing: Barry Thornton
Audio Etc., St. Peters, MO 314-278-4130
PRODUCTS: digital encoding

Orban Associates, div. AKG

1525 Alvarado Street
 San Leandro, CA 94577
 (415) 351-3500 FAX: (415) 351-0500
President: S.R. Ravich; **Vice President:** Derek
 Plikington; **Marketing Manager (U.S.A.):** David
 Roudebush; **Marketing Manager (Int'l):**
 Howard Mullinack; **Product Manager:** Scott
 Helneman
 Jeff Radke, Appleton, WI 414-749-0044
 Sunrise Sales Company, LaMollie, IL 815-638-
 2660
PRODUCTS: ambient noise level controllers,
 automatic/ programmable equalizers,

compressors, de-essers, equalizers, graphic
 equalizers, levelers, limiters, noise gates, notch
 filters, parametric equations, octave
 equalizers, transcription preamps

Outline

Via L. DavInci 56
 25020 Fiero, Italy
 (30) 358-1341 (800) 358-1351, FAX: (30) 358-0431
President: Guido Noselli; **Vice President, Sales:**
 Giorgio Biffi; **Marketing Director:** Marcello
 Croce; **R & D Director:** Giancarlo Puzzi; **Sales**
Manager: Anna Guarenti; **Purchasing Manager:**
 Angelo Ferraresi
 Coemar Deutschland, ULM, Germany,
 073-160-1205
 MBS, Lempdes, France, 073-910-630
 Leibnitz M. Bigler, Austria, 034-52-6515
 Taisheng Trading, Taipei, Taiwan, 253-13802
 Universal, Singapore, 534-5993
 Precide, Morbio Inferiore, Switzerland,
 914-31734
 PCP Electronics, Limassol, Cyprus, 53-39297
 Metronome Muzik, Istanbul, Turkey, 7-345-2457
 Tropical Recording, Malindi, Kenya, 723-27700
 Point Rouge, Mutuelueville, Tunis, 7-345-2457
PRODUCTS: 1/3 octave equalizers

OXMOOR CORP.

2111 Parkway Office Circle.
 Birmingham, AL 35244
 (205) 985-7040 FAX: (205) 985-9966
President: Lynn A. McCroskey; **Vice President/
 Manager:** Gary L. West; **National Sales**
Manager: Richard C. Mitchell; **Sales Associate:**
 Nick Alsmiller; **Production Manager:** Jim
 Watson; **Director of Engineering:** Gene
 Elghmy
 John B. Anthony Company, Stamford, CT
 212-585-2027
 ASR, Fallston, MD 301-893-0001
 Audio Resources, Westmont, IL 708-655-1180
 Dimension IX Marketing, Lewisville, TX
 214-436-3706
 Evans Sales and Marketing, Nashville, TN
 615-297-7997
 Loomis and Associates, Fremont, CA
 415-683-0883
 Loppnow and Associates, Issaquah, WA
 206-392-3936
 R.J. Throckmorton Sales Co., Ballwin, MO
 314-227-7222
 Repworks, Chicopee, MA 413-553-0845
PRODUCTS: automatic/ programmable
 equalizers, interface units

Paso Sound Products, Inc.

14 First Street, Pelham, NY 10803
 (914) 738-4800 (800) 231-3034
 FAX: (914) 738-3954
Executive Vice President: Paul Mastrangelo;
Product Manager: Ken O'Brien; **Credit**
Manager: Marilyn Beckerson; **Operations**
Manager: Anthony Squeglla
 Anderson Sales, Braintree, MA 617-848-9194
 Jack Mesnick Sales, Liverpool, NY 315-622-3211
 Palmieri Associates, Fairfield, NJ 201-882-1266
 Weller Electronic Sales, Inc., Worthington, OH
 614-885-7819
 Llenau Associates, Columbia, MD 301-621-4113
 MJA Marketing, St. Charles, MO 314-447-7111
 Northland Assoc., Moorehead, MN
 218-233-4616
 Allwest Sound & Communication, Camarillo, CA
 805-388-7745
 Dimension Pt. IX Marketing, Katy, TX
 713-578-9277
 Mountain Representatives, Denver, CO
 303-333-7745
 Miguel Lopez, Hialeah, FL 305-822-6853
 Paco Electronics, Ltd., Markham, ON

416-475-0740

Robert Misk Co., Southfield, MI 313-354-3310
 Marketline Inc., Snellville, GA 404-972-9048
 Hawkins-Frederickson Assoc., Maitland, FL 407-831-2474

Lintern Associates, Naperville, IL 708-904-1225
 Robert Misk Co., Indianapolis, IN 317-842-3400
PRODUCTS: 1/3 octave equalizers, compressors, equalizers, graphic equalizers, octave equalizers

PEAVEY ELECTRONICS CORP.

711 A Street
 P.O. Box 2898

Meridian, MS 39301

(601) 483-5365 FAX: (601) 484-4278

CEO: Hartley Peavey; President: Mella Peavey
 Dimension/ Point IX, Lewisville, TX 214-436-3706

PRODUCTS: 1/3 octave equalizers, ambient noise level controllers, audio/video synchronizers, automatic/programmable equalizers, compressors, crossovers, digital effects, digital encoding, digital reverbs, digital delays, digital signal processors, equalizers, graphic equalizers, interface units, levelers, limiters, noise gates, notch filters, noise gates, parametric equations, octave equalizers, signal enhancers, signal metering

Protech Audio Corporation

Flowerfield Bldg. 1, St. James, NY 11780

(516) 584-5855 FAX: (516) 584-5904

Director of Marketing: Bill Murphy; Sales
 Engineering: Joseph Giambone

Peregrine Southwest Reps, Houston, TX 713-589-8481

First Choice Marketing, Seattle, WA 206-524-7344

Dimension/ Point IX, Lewisville, TX 214-436-3706

PRODUCTS: ambient noise level controllers, compressors, interface units, levelers, limiters, noise gates, notch filters, signal metering, transcription preamps, VCA's

Radio Design Labs

5025 8th Street, Carpinteria, CA 93013

(805) 684-5415 FAX: (805) 684-9316

Director of Engineering: Joel Bump; Dir. of
 Sales & Marketing: Jerry Clements

Karp Communications, Tampa, FL 813-968-7098

Rane Corp.

10802 47th Avenue West

Mukilteo, WA 98275-5098

(206) 355-6000

President: Steve Brakken; CEO: Linda Arlink;
 V.P. of Manufacturing: Rick Bernard; V.P. of R
 & D: Dennis Bohn; V.P. of Marketing: Larry
 Winter; National Sales Manager: Ray Bloom
 Larry Schirmer, Pontiac, MI 313-340-9588

PRODUCTS: 1/3 octave equalizers, automatic/programmable equalizers, compressors, crossovers, equalizers, graphic equalizers, limiters, noise gates, parametric equations

Rauland-Borg Corp.

3450 W. Oakton St.

Skokie, IL 60076

(708) 679-0900 FAX: (708) 679-0625

President: William Krucks; Executive Vice
 President: Kenneth James; National Sales
 Manager: Harry Hahn; Marketing Manager:
 Vince Novak

Jack Hoills, Geneva, IL 708-208-1488

Joe Clotti, Longwood, FL 407-767-2007

Frank Riha, Austin, TX 512-926-3646

Hank Plalsler, El Toro, CA 714-837-2626

Vince Ward, Vashon Island, WA 206-463-5582

Doug Warren, Newport News, VA 804-930-3217

Suzanne Graham, Kent, OH 216-678-7307

Mike Gulhan, E. Long Meadow, MA 413-525-6090

Rocktron/RSP Tech.

2870 Technology Drive

Rochester Hills, MI 48309

(313) 853-3055 FAX: (313) 853-5937

National Sales: James Chowning; Export Sales:
 Bob Waller; Product Specialist: Jeff Sorna

Karp Communications, Tampa, FL 813-968-7098

S.E.M. Co.

#17-636 Clyde Ave.

W. Vancouver, BC V7T 1E1

(604) 922-0526 FAX: (604) 922-0526

President: Elk Ebert; Vice President: Anne
 Moretti

Karp Communications, Tampa, FL 813-968-7098

PRODUCTS: 1/3 octave equalizers, automatic/programmable equalizers, compressors, crossovers, digital delays, equalizers, graphic equalizers, limiters, notch filters, parametric equations, octave equalizers, VCA's

Sabine Musical Mfg. Co., Inc.

4637 N.W. 6th Street

Gainesville, FL 32609

(904) 371-3829 (800) 626-7394 FAX: (904) 371-

7441

President/C.E.O.: Doran Oster; Sales &
 Marketing Director: John M. Annin; Sales &
 Customer Service: Nell Rapaport

Sound Sales, Inc., Columbia, MD 301-964-1170

PRODUCTS: digital signal processors,
 equalizers, notch filters, parametric equations,
 signal enhancers

Scantek, Inc.

916 Gist Avenue

Silver Springs, MD 20910

(301) 495-7738 FAX: (301) 495-7739

President: Richard J. Peppin; Sales Manager:
 Fred M. Hirsh; Service Engineer: Yogesh Patel;

Administration: Debrah Meyers

Abitec, Cleveland, OH 216-531-9122

JMS Marketing, Austin, TX 512-266-1113

PRODUCTS: digital signal processors,
 equalizers, notch filters, parametric equations,
 signal enhancers

SCV Audio/QMI

15 Strathmore Rd.

Natick, MA 01760

(508) 650-9444 FAX: (508) 650-9476

President: Scott Berdell

Camden Marketing, Pierre Fonds, QU 514-683-

3377

SONANCE

961 Calle Negocio

San Clemente, CA 92672

(714) 492-7777 (800) 582-7777 FAX: (714) 361-

2705

President: Scott Struthers; Vice President:
 Geoff Spencer; Sales Manager: Dave Donald;

International Sales Manager: Mark Cichowski;

Public Relations Director: Mitch Simon; Dir. Sls
 Trn. & Mkt. Research: Kevin Leja

Morris Tait and Assoc., Los Angeles, CA 213-

877-4424

Bach Sales, New York, NY 212-727-0404

Tandem Marketing, Chicago, IL 708-605-1960

Dobbs Stanford, Dallas, TX 214-358-0800

Balaton Marketing, Washington DC, 202-471-

1764

MJA Marketing, St. Charles, MO 314-447-7111

PRODUCTS: parametric equations

Sonic Research Assoc.

P.O. Box 13744

Arlington, TX 76094-0744

(817) 792-2061

Soundings Electrotec, Inc.

P.O. Box 10004

Winslow, WA 98110

(206) 842-7128 FAX: (206) 842-5026

Cambridge Marketing, Westerville, OH 614-363-

9191

Soundstream Technologies

120 Blue Ravine Road

Folsom, CA 95630

(916) 351-1288 FAX: (916) 351-0414

President: Donna Haas; Managing Director:
 Lee Adams; Director of Engineering: Wade
 Stewart; Ntl. Sales Mgr., Home Audio: Scott
 McAllister; Sales Engineer, Home Audio:
 Andrew Murray

John W. Steinberg Company, Encino, CA 818-

705-7772

Moskau & Associates, Dallas, TX 214-821-4280

Creative Marketing Associates, Nashville, TN

615-831-9690

On Line Marketing, Wadsworth, OH 216-336-

7504

Sound Marketing, Palos Hills, IL 708-598-6888

Cambridge Marketing, Westerville, OH 614-363-

9191

PRODUCTS: crossovers

Spatial Sound, Inc.

743 Center Boulevard

Fairfax, CA 94930

(415) 457-8114 FAX: (415) 457-6250

Sales Manager: Paul Devias; Chief Engineer:
 Alain Martel

Karp Communications, Tampa, FL 813-968-7098

PRODUCTS: VCA's

Spectra Sonics

3750 Airport Rd., Ogden, UT 84405

(801) 392-7531 FAX: (801) 392-7531

President: William D. Dilley; Eng. Sales:
 Gregory D. Dilley

Camden Marketing, Pierre Fonds, QU 514-683-

3377

Stewart Electronics

11460 Sunrise Gold Circle

Rancho Cordova, CA 95742

(916) 635-3011 FAX: (916) 635-1787

Owner/ President: Wade A. Stewart; Sales/
 Marketing Manager: Christopher Dragon;

Sales/Marketing Admin.: Sally Ann Berry;

Director Tech. Services: Bob Hershenow

Dimension/ Point IX, Lewisville, TX 214-436-

3706

PRODUCTS: Interface units

Studio Technologies, Inc.

5520 W. Touhy Ave.

Skokie, IL 60077

(708) 676-9177 FAX: (708) 982-0747

President: Gordon Kapes; Communications
 Manager: Barbara Govednik

Camden Marketing, Pierre Fonds, QU 514-683-

3377

PRODUCTS: signal enhancers

STUDIOMASTER INC.

3941 Miraloma Avenue

Anaheim, CA 91719

(714) 524-2227 FAX: (714) 524-5096

President: Paul Reeve; National Sales
 Manager: Jim Giordano

J.B. Parent, Dublin, OH 614-764-0064

PRODUCTS: compressors, crossovers, de-

essers, digital effects, digital reverbs, digital

delays, digital signal processors, limiters, noise

gates, parametric equations

Symetrix Inc.

4211 24th Avenue W., Seattle, WA 98199
 (206) 282-2555 (800) 288-8855 FAX: (206) 283-5504
 President: Dane Butcher; National Sales
 Manager: Jon Bosaw; Publications Manager:
 Gordon Doucette
 Karp Communications, Tampa, FL 813-968-7098
 PRODUCTS: ambient noise level controllers,
 compressors, crossovers, de-essers, equalizers,
 levelers, limiters, noise gates, notch filters,
 parametric equations, signal metering

Systems Design Associates

411 Lakeshore Rd.
 Denton, TX 76205
 (817) 497-6185

T.C. Electronic of Denmark

171 Lakefield Road Suite C.,
 Westlake Vil., CA 91361
 (805) 373-1828 FAX: (805) 379-2648
 Exclusive U.S. Distributor: Edward C. Simeone
 JMS Marketing, Austin, TX 512-266-1113
 PRODUCTS: 1/3 octave equalizers, automatic/
 programmable equalizers, digital effects, digital
 reverbs, digital delays, equalizers, parametric
 equations

TDM Design Inc.

12800 NW Bishop Rd., Hillsboro, OR 97124
 (503) 647-5957 FAX: (503) 647-5953
 President: Tim Miller
 AMH Sales, Torrance, CA 213-373-2034
 Marlin Marketing Concepts, Irving, TX
 214-869-0669
 JMS Marketing, Austin, TX 512-266-1113
 PRODUCTS: 1/3 octave equalizers, crossovers

TEI Electronics Inc.

570 W. 18 St., P.O. Box 246
 Hialeah, FL 33011
 (305) 888-3980 (800) 327-8811 FAX: (305) 885-4950
 President: Danny Alonso; Vice President: Mireya
 A. Muniz; National Sales Manager: Walter
 McNulty; Customer Service: John Tembras;
 Sales: Orlando Pineda; Sales: Jose Hurcades
 Audio Biz, Mundellen, IL 708-949-0280
 PRODUCTS: 1/3 octave equalizers, crossovers,
 graphic equalizers

**TOA ELECTRONICS, INC.**

601 Gateway Blvd. Suite 300
 P.O. Box 2047
 S San Francisco, CA 94080
 (415) 588-2538 (800) 733-4750 FAX: (415) 588-3349
 President: Yoshiro Ishida; Director, Audio
 Products Div: Richard Krochmal; Director,
 Comm. Systems Div.: Al Burns; Mgr., Marketing
 Development: Jeff Pallin; Manager, Western
 Division: Bill Ford; Manager Engineering
 Services: Bob Sweet
 Chuck McGregor- Product Consit, Morris Plains,
 NJ 201-829-7047
 John Murray-Eng.Snd. Mktg. Dev, Springfield, OH
 513-324-1993
 Bob Hager-Eastern Regional Mgr, Rosewell, CA
 404-552-7624

Linda Wick-Central Reg. Mgr., Kansas City, MO
 816-453-5775
 Robert Slaughter-Cntrl Div Mgr, Houston, TX 713-
 460-3678
 Pete Newmark-West Regional Mgr., Mesa, AZ
 602-981-0050
 Walter Best, Eastern Reg. Mgr., Sussex, NJ 201-
 702-0068
 PRODUCTS: 1/3 octave equalizers, automatic/
 programmable equalizers, crossovers, digital
 delays, digital signal processors, equalizers,
 graphic equalizers, parametric equations, octave
 equalizers

UREI/JBL Professional

8500 Balboa Boulevard
 P.O. Box 2200
 Northridge, CA 91329
 (818) 893-8411 FAX: (818) 893-3639
 President: Ronald Means; Vice President, Sales:
 Ken Lopez; Vice President, Marketing: Mark
 Gander; Market Manager: Hector Martinez;
 National Sales Manager: Neil Conley
 Jim Chase, San Clemente, CA 714-492-6290
 Bill Hamilton, Folsom, PA 215-543-4677
 Bill Schuermann, Houston, TX 713-370-5553
 Tom Walter, No. Barrington, IL 312-382-4925
 Cambridge Marketing, Westerville, OH
 614-363-9191
 PRODUCTS: 1/3 octave equalizers, ambient noise
 level controllers, crossovers, equalizers, graphic
 equalizers, limiters, parametric equations, octave
 equalizers

Wadia Digital Corp.

624 Troy Street, River Falls, WI 54022
 (715) 426-5900 FAX: (715) 426-5665
 Vice President, Sales & Mktg: Jim McCullough
 Cambridge Marketing, Westerville, OH
 614-363-9191
 PRODUCTS: digital encoding, digital signal
 processors

White Instruments, div. C Van R Inc

1514 Ed Bluestein Blvd., Ste 108
 Austin, TX 78721
 (512) 389-3800 FAX: (512) 389-1515
 President: Carl Van Ryswyk; Vice President:
 Shirley Van Ryswyk; Director of Engineering:
 Rick Bocock; Sales Manager: Jeff Van Ryswyk;
 Order Department: Beverly Kimbell; Credit
 Manager: Steve Bolles
 Westech Marketing, Culver City, CA 213-870-9286
 Wilson Audio Sales, Nashville, TN 615-646-4477
 Jones Audio Sales, Plano, TX 214-618-2600
 Sigmet Corporation, Freehold, NJ 908-462-1221
 Bencsik Associates, Ocala, FL 904-732-9775
 MJA Marketing, St. Charles, MO 314-447-7111
 PRODUCTS: 1/3 octave equalizers, automatic/
 programmable equalizers, crossovers, digital
 delays, digital signal processors, equalizers,
 graphic equalizers, notch filters, parametric
 equations, octave equalizers

YAMAHA CORP. OF AMERICA

6600 Orangethorpe Ave.
 Buena Park, CA 90620
 (714) 522-9011 FAX: (714) 739-2680
 Sales & Marketing Manager: Gerald W. Tschetter;
 Pro Digital Sis & Mktg Mgr.: Peter Chalkin;
 Market Support Manager: Don Bowles
 Precide, Morbio Inferiore, Switzerland,
 914-31734
 PRODUCTS: 1/3 octave equalizers, automatic/
 programmable equalizers, compressors,
 crossovers, digital effects, digital reverbs, digital
 delays, digital signal processors, equalizers,
 graphic equalizers, limiters

Zeta Music Systems

2230 Livingston St.
 Oakland, CA 94606
 (415) 261-1702 FAX: (415) 261-1708

Zoom Corp.

385 Oyster Point Boulevard #7
 South S.F., CA 94080
 (415) 873-5885 FAX: (415) 873-5887
 National Sales and Mktg.: Peter Rodgers;
 Assistant Promo Manager: Tai-Li Wang;
 President: Hiroshi Matsuo; Director of
 Marketing: Yoshi Komlya; Director of
 Engineering: Michi Nozokido; Tech. Service:
 Pierre Archain
 Josh Blacker Sales, Venice, CA 818-785-3257
 Blackhawk Mktg., Pac. Pallsades, CA 213-454-8196
 R.S. Enterprises, Redmond, WA 206-883-1482
 GAP Sales & Mktg., Glendale, AZ 602-934-6614
 Marketing Concept, Irving, TX 214-869-0669
 MJA Marketing, St. Charles, MO 314-447-7111

**Adaptive Micro Systems, Inc.**

7840 N.86 St.
 Milwaukee, WI 53224
 (414) 357-2020 FAX: (414) 357-2029
 Sales Supervisor: Karen McCarthy; Sales
 Coordinator: Dan Newlin; Sales Coordinator:
 Russ Hodach
 Nova Marketing, San Francisco, CA 415-952-0943
 PRODUCTS: electronic displays

Alphone Corp.

1700 130th Ave. NE
 Bellevue, WA 98005
 (206) 455-0510 FAX: (206) 455-0071
 President: Jun Matsumoto; Vice President,
 Marketing: Harry Quanz; Vice President, Sales:
 Jim Morrison; Residential Sales Manager:
 Stephen Birgh; Commercial Sales Manager: John
 Mosebar
 Alphone East Coast Reg. Office, Rochelle Park, NJ
 201-843-6115
 Precide, Morbio Inferiore, Switzerland, 914-
 31734
 PRODUCTS: Intercom

AmPro Corporation

5 Wheeling Avenue
 Woburn, MA 01801
 (617) 932-4800 (800) 556-7733 FAX: (617) 932-8756
 Chairman: Charles W. Trippe; Vice President,
 Operations: Eric M. Geller
 Dave Maniscalco, St. Louis, MO 314-997-3868
 Richard Sanford, Salem, NH 603-898-5137
 John Stewart, Rockville, MD 301-294-0185
 Charles Collins, Tucson, AZ 602-792-1829
 Charles Pintard, Atlanta, GA 404-434-3649
 Vector Corp., Seattle, WA 206-368-8400
 PRODUCTS: image projectors

Sharp presents two new LCD Color Video Projectors.

They're both brighter and lighter.



XG-1500 ceiling mount



XG-1100 portable

LCD PROJECTION SYSTEMS

SHARP VISION

Now you can brighten up your presentations with two new convergence-free professional LCD video projectors from Sharp.

Both the XG-1100 (portable model) and XG-1500 (ceiling-mount model) are brighter, lighter and more compact. And, because they are Solid State LCD, they also set up in seconds*.

The XG-1100, with its top-mounted carry handle and optional carrying case, is a smooth traveler. And the XG-1500, with its back-lit wireless remote and space-efficient design, is a natural for any ceiling, wall or even shelf-mount installation.

Both models incorporate industrial-type BNC video inputs as well as an S-Video terminal, so they connect easily to a wide variety of sources—including many PCs. Plus, for improved compatibility, the XG-1500 also features built-in RGB.

With both XG-1100 and XG-1500, you also get a 20"-100" zoom lens, a convenient scan reversal switch (for rear-projection use), as well as 3-wire (grounded) power cord. And, with a readily available long-throw lens, VGA or Mac II™ graphics interface, these projectors are all set for almost any special multimedia application.

*Sharp's Twin-TFT Solid State LCD technology means absolutely no technical set-up

Contact your local authorized Sharp Professional Products dealer for a demonstration. Or call (201) 529-8731 or FAX: (201) 529-9636. Once you do, you'll see why Sharp Solid State LCD color video projectors leave CRT 'tube' projectors in the dark.

Simulated screen image



SHARP
FROM SHARP MINDS
COME SHARP PRODUCTS™

© 1991 Sharp Electronics Corporation, Professional Products Division, Sharp Plaza, Mahwah, NJ 07430-2135

Circle 221 on Reader Response Card

World Radio History

AMX Corporation

12056 Forestgate Drive, Dallas, TX 75243
(214) 644-3048 (800) 222-0193 FAX: (214) 907-2053
President: Scott Miller; Vice President of Sales:
William V. Anderson; Executive Vice President:
Art Chace; International Sales Manager: Ken
Slater; Director of Marketing: Eric Johansen
Franklin Communications, Maple Glen, PA
215-643-3031
Visitech Marketing Assoc., Elburn, IL 708-365-9600
KBZ Communications, Furlong, PA 215-348-9481
Westech Marketing, Culver City, CA 213-870-9286
Total Marketing, Ft. Worth, TX 817-560-3970
Karp Communications, Tampa, FL 813-960-7667
Richard Krudop, Andalusia, AL 205-222-8950
Pancor Marketing, Lynnwood, WA 206-771-6016
PRODUCTS: computer control, wireless control

Ancha Electronics Inc.

5540 Meadowbrook Court
Rolling Meadows, IL 60008-3800
(708) 437-7712 FAX: (708) 437-0271
President: Robert F. Ancha; Vice President,
Finance: Margaret Broch; Vice President, Sales &
Mktg: Steve Youngson; Vice President, Design:
Richard Tollberg; Vice Pres., Administration: R.C.
Ancha
Ancha Electronics Inc., Atlanta, GA 404-446-5894
Ancha Electronics Inc., Tampa, FL 813-626-0350
Nova Marketing, San Francisco, CA 415-952-0943

Apollo Audio Visual/Apollo Lighting

60 Trade Zone Court
Ronkonkoma, NY 11779
(516) 467-8033 (800) 777-3750 FAX: (516) 467-8996
President: Harry Charlston; Vice President —
Sales: Eric Milburn; Vice President: John
Castallano; Marketing Manager: Becky Greco
Audio Etc., St. Peters, MO 314-278-4130

APPLIED TECHNICAL SYSTEMS

815 King Pl., Shreveport, LA 71115
(318) 868-7413 (800) 444-7161
FAX: (318) 631-7613
President: Jim Reccelli; Vice President: Richard
Davis
C.L. Pugh & Associates, Cleveland, OH
216-238-1777
Total Marketing, Fort Worth, TX 817-560-3970
Western Audio Sales, Burbank, CA 818-954-9300
PRODUCTS: computer control, electronic
displays

Arion Corp.

701 South 7th St.
Delano, MN 55328
(612) 972-3351 FAX: (612) 972-3524
Director of Sales & Mkt'g: Robert Seliski
Marketline, Inc., Atlanta, GA 404-972-9048
Marketline, Inc., Ocala, FL 904-622-1501
Marketline, Inc., Fort Meyers, FL 813-939-4748
Total Marketing, Fort Worth, TX 817-560-3970
Visitec Marketing, Elburn, IL 708-365-9600
Precide, Morbio Inferiore, Switzerland,
914-31734
PRODUCTS: A/V speakers, audio for A/V,
computer control, multi-media controls, wireless
control

Audio Design Associates, Inc.

602-610 Mamaroneck Avenue
White Plains, NY 10605
(914) 946-9595 FAX: (914) 723-4642
President: Peter T. McKean; Vice President
Engineering: Albert Langella; Vice President
Operations: Ronald Senkirk; National Sales
Manager: Richard D. Stoerger
Greg Dzubay & Assoc., Glendale, AZ 800-999-0006
PRODUCTS: audio for A/V, multi-media controls

Audio Engineering Associates

1029 N. Allen Ave.
Pasadena, CA 91104
(818) 798-9127 FAX: (818) 798-2378
President: Wes Dooley; Sales: Steve Trunnell;
Operations Manager: Jawxlillon Loeb
Vector Corp., Seattle, WA 206-368-8400

Audioease

15350 East Hinsdale Dr.
Englewood, CO 80112
(303) 766-9300 FAX: (303) 766-9400
Audio Etc., St. Peters, MO 314-278-4130

Audiovisual Inc.

6253 Bury Drive
Eden Prairie, MN 55346
(612) 949-3700 FAX: (612) 949-6000
President & Marketing Dir.: Joe M. Stoebner;
Sales Manager: Steve Tunell
Eldon Kreln, Omaha, NE 402-593-6500
Tom Madsen, Sloux Falls, SD 605-336-0689
Steve Gassmann, Des Moines, IA 515-282-4800
Chuck Bohn, Bismarck, ND 701-258-6360
Precide, Morbio Inferiore, Switzerland,
914-31734

AV Systems Engineering Pty. Ltd.

28 Doonan Road, P.O. Box 192
Nedlands
W. AUSTRALIA, 6009
(619) 389-8105 FAX: (619) 389-8149
Managing Director: Phillip Jenkins
RCS, New Milford, NJ 201-261-5560
Total Marketing, Fort Worth, TX 817-560-3970
Winchester, Atlanta, GA 404-392-0200
Loomis & Associates, Riverside, CA 714-780-9477
Sound Sales, Inc., Columbia, MD 301-964-1170
PRODUCTS: audio for A/V, boardroom sound
systems

AVL Audio Visual Laboratories Inc.

123 White Oak Lane
Old Bridge, NJ 08857
(908) 679-5500 FAX: (908) 679-1317
PRODUCTS: computer control, image projectors,
interface units, multi-media controls

Barco, Incorporated

1000 Cobb Place Boulevard
Kennesaw, GA 30144
(404) 590-7900 FAX: (404) 590-8836
Nova Marketing, San Francisco, CA 415-952-0943

BOSE CORP.

The Mountain
Framlingham, MA 01701-9168
(508) 879-7330 FAX: (508) 872-6640
National Sales Manager: Timothy Dorwart;
Eastern Reg. Sales Manager: Bruce Hurst;
Western Reg. Sales Manager: Tim Landwehr; Sr.
Applications/Des. Spec.: Bruce Myers; Sr. Sales
Representative: Reed Strutzenberg; Sales
Representative: Phil Nelson
HC Garrison Co., Tualatin, OR 503-638-4906
Westech Marketing, Culver City, CA 213-870-9286
Silver Peak Marketing, Wheat Ridge, CO
303-467-9042
Rancillo Assoc., St. Louis, MO 314-845-0202
CR Marketing, Clarkston, MI 313-625-2420
J.B. Parent, Dublin, OH 614-764-0064
Secom Systems, Atlanta, GA 404-455-0672
Bencsik Assoc., Ocala, FL 904-732-9775
Sigmet Corp., Valley Forge, PA 215-783-6666
Joseph P. Mazzeo Assoc., Inc., Rochester, NY
716-458-7851
Peter E. Schmitt Co., Inc., Leonia, NJ 201-944-2806
PRODUCTS: A/V speakers, audio for A/V,
boardroom sound systems, lecterns

Callfone Int'l

21300 Superior St.
Chatsworth, CA 91311
(818) 407-2438 FAX: (818) 407-2405

Communications Co.

3490 Noell St.
San Diego, CA 92110
(619) 297-3261 FAX: (619) 297-3279

Crestron Electronics, Inc.

101 Broadway
Cresskill, NJ 07626
(201) 894-0660 (800) 237-2041 FAX: (201) 894-1192
Sales & Marketing Manager: Randy Klein
Robert Christopher Sales, New Milford, NJ 201-
261-5560
Robert Christopher Sales, Whitefish Bay, WI 414-
332-6555
RSI, Irving, TX 214-256-4551
Loomis & Associates, Fremont, CA 415-683-0883
Presentation Resources, Inc., Mauldin, SC 803-
288-8840
Taub Sales, Silver Springs, MD 301-662-9100
PRODUCTS: Interface units, multi-media
controls, wireless control

Current Designs Corporation

115 West 23rd Street
New York, NY 10011
(212) 463-0795 FAX: (212) 463-9280
President: Dick Demenus; Vice President: Mike
Edl; S.T.: David Lerner; Director of Marketing:
David Rapkin
Edwards Company, Inc., Livonia, MI
313-458-7777

D.O. Industries

317 East Chestnut St.
E. Rochester, NY 14445
(716) 385-4920

Da-Lite Screen Co., Inc.

P.O. Box 137
Warsaw, IN 46581
(219) 267-8101 FAX: (219) 267-7804
Vice President Sales & Mkt'g.: Judith Loughran;
President: Richard Lundin; National Sales
Manager: Gary Sage

**Draper Shade and Screen
Company Inc**

411 South Pearl Street
P.O. Box 425
Spiceland, IN 47385
(317) 987-7999 FAX: (317) 987-7142
Cambridge Marketing, Westerville, OH 614-363-
9191
PRODUCTS: lecterns, screens

Dukane Corp.

2900 Dukane Drive
St. Charles, IL 60174
(708) 584-2300 FAX: (708) 584-2370
President/C.E.O.: J. McWilliams Stone Jr.;
Pres./Comm. Systems Division: Steven L. Deppe;
National Sales Director: Warren T. Anderson;
Service Manager: Cliff Carlson
Wally Smutts, Toronto, ON 519-748-5352
Doug Fellabamu, Sycamore, IL 815-895-7573
Ken Lind, Boston, MA 617-235-6817
Pete Kendall, Jacksonville, FL 904-262-6025
Jim Lacey, Moreno Valley, CA 714-243-1160
Jack Brown, Dallas, TX 214-943-7528
Sanford Lange, Indianapolis, IN 317-251-3112

Electrohome Limited

809 Wellington Street N., Kitchener, ON N2G 4J6
 (519) 744-7111 FAX: (519) 749-3131
 Chairman, Pres. & C.E.O.: J.A. Pollock; Group Vice
 Pres., Electronics: W.M. Nobbs; Sector G.M.,
 Projection Sys.: Kenneth Mitchell; Sector G.M.,
 Display Systems: David Lowater; Sector G.M.,
 Jazz Systems: Donald Harrold
 Greg Dzubay & Assoc., Glendale, AZ 800-999-0006

Electrosonic Systems, Inc.

6505 City West Parkway, Minneapolis, MN 55344
 (612) 941-3236 (800) 328-6202 FAX: (612) 941-8155
 President: Kevin Curry; Gen. Mgr., Commercial
 Prods.: Vic Hobbs
 Doug Warren, Newport News, VA 804-930-3217

Elmo Manufacturing Corporation

70 New Hyde Park Road, New Hyde Park, NY 11040
 (516) 775-3200 (800) 654-7628 FAX: (516) 775-3297
 Sales Manager: Vincent J. Glovinco; Sales
 Engineer: Keith Isogal; President: Y. Amemlya;
 Executive Vice President: Vincent G. Marotti
 Elmo Manufacturing Corp., Chatsworth, CA
 818-346-4500
 Greg Dzubay & Assoc., Glendale, AZ 800-999-0006
 PRODUCTS: Image projectors

ENVIRONMENTAL SOUND

31220 La Baya Dr., Bld. #110, Westlake Vlg., CA 91362
 (818) 706-0228 FAX: (818) 889-5605
 President: Pascal Delbuck; Marketing: Ron
 Glatzhoffer; Plant Manager: Bill Ward
 Cambridge Marketing, Westerville, OH 614-363-9191
 PRODUCTS: A/V speakers, boardroom sound
 systems

ESE

142 Sierra Street
 El Segundo, CA 90245
 (213) 322-2136 FAX: (213) 322-8127
 President: Jerry Johnson; Vice President/Sales
 Manager: Bob Mayers; Marketing Manager:
 Brian Way; General Manager: Bill Kalser
 Cambridge Marketing, Westerville, OH
 614-363-9191
 PRODUCTS: electronic displays, interface units

Extron Electronics

13554 Larwin Circle
 Santa Fe Springs, CA 90670
 (213) 802-8804 (800) 633-9876 FAX: (213) 802-2741
 Sales Manager: Gary V. Kayye; President:
 Andrew Edwards; Vice President Engineering:
 Steve Somers; System Engineer: Dave Pinck
 Doug Warren, Newport News, VA 804-930-3217
 PRODUCTS: boardroom sound systems,
 computer control, interface units, multi-media
 controls

FSR Inc.

244 Bergen Boulevard, West Paterson, NJ 07424
 (201) 785-4347 (800) 332-3771
 FAX: (201) 785-3318
 President: William G. Fitzsimmons; Vice
 President: Janice Sandri; Engineering Manager:
 Joseph Fischer; Special Projects Manager: John
 Macaluso; Manager, Metal Products: Joseph
 Amico
 Sigmet Corporation, Valley Forge, PA
 215-783-6666
 Peregrine Southwest, Houston, TX

713-589-8481

Henry W. Phillips Inc., Roswell, GA 404-992-3070
 Piper and Givan Associates, Needham, MA
 617-449-1144
 Design Factors, Hacienda Hts., CA 213-697-7576
 Cambridge Marketing, Westerville, OH
 614-363-9191
 PRODUCTS: Interface units, multi-media
 controls, wireless control

GBE Group

5664 Kingswood Dr.
 Citrus Heights, CA 95610
 (916) 967-5946

Gold Ribbon Sound Cinema

103 Commercial Drive
 Iowa City, IA 52246
 (319) 351-9114 FAX: (319) 354-0701
 President & C.E.O.: Kenneth Leavitt; Director of
 Engineering: Alan Hulsebus; Vice President of
 Mfg.: Dennis Spencer
 Jamm Distributing, Flossmoor, IL 708-799-0550
 KBZ Communications, Furlong, PA 215-348-9481
 Total Marketing, Forth Worth, TX 817-560-3970
 Franklin Communications, Maple Glen, PA
 215-643-3031
 Yencer Associates, Fisher, IN 317-842-3992
 Preclde, Morbio Inferiore, Switzerland,
 914-31734

Hudson Photographic Industries

Irvnht-On-Huden, NY 10533
 (914) 591-8700

INDEPENDENCE

That's the
SOUND
COMMUNICATIONS
 CREDO

Sound & Communications is the
 magazine by journalists with
 an independent bent —
 Journalists who report and
 who don't sell advertising.

*It's the trade magazine
 with a mind
 of its own.*

Linkage.

LED signs that network.

From high-traffic retail settings to industrial
 communication, LaBelle offers a network
 that can work alone or with existing audio
 systems to help any business broadcast
 information better, faster and to larger
 audiences than ever before.

**Find out how selling LED networks
 will increase your profits.**

Call 1-800-558-9526.

 Display Sciences Group

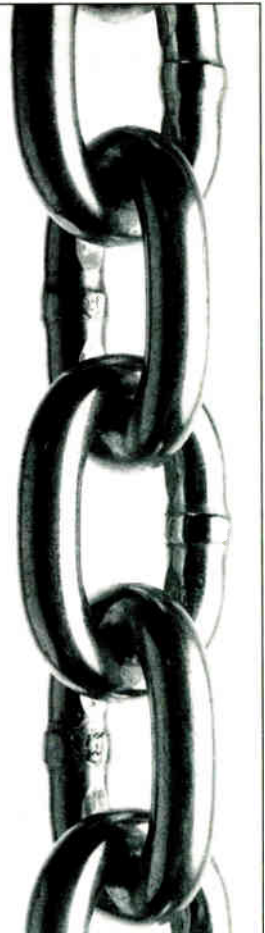

Circle 286 on Reader Response Card

Play it again, Sam!

WITH THE ULTIMATE MEETING ROOM CONTROLLER PROGRAMMING AND PLAYBACK IN THE PALM OF YOUR HAND

MRC.....designed to simplify operation of any room using a variety of AV facilities. MRC reduces all controls to the absolute minimum. You make the room do what you want it to, when you want it to. And you program MRC to your requirements either on its central control unit, or with its cordless remote controller — no computers needed!

Ordering and installing is simplicity itself. Choose from a range of Interface cards designed to match projectors, videotapes, slide controllers, cassettes, video projectors. Plug In. Hook up. Program. And Go.

MRC combines in one compact unit the functions of:

- A MICROPHONE PRE-AMPLIFIER
- A PROGRAMMABLE 4 WAY STEREO AUDIO MIXER
- A REMOTE PUSH-BUTTON STEREO VOLUME CONTROL
- A 2 × 20W STEREO POWER AMPLIFIER
- A 4 WAY COMPOSITE VIDEO SWITCHER
- A VIDEO SYNC GENERATOR WITH AUTOMATIC BLACK LEVEL
- A CONTROLLER FOR LIGHTING, CURTAINS, SCREENS, ETC
- A CONTROLLER FOR VIDEO AND AUDIO SOURCES
- A SLIDE AND OHP CONTROLLER
- AN INFRA-RED CORDLESS CONTROLLER
- A SIMPLE PROGRAMMABLE LOGIC CONTROLLER
- A PROGRAMMABLE CONTROLLER FOR COMPLEX SEQUENCES

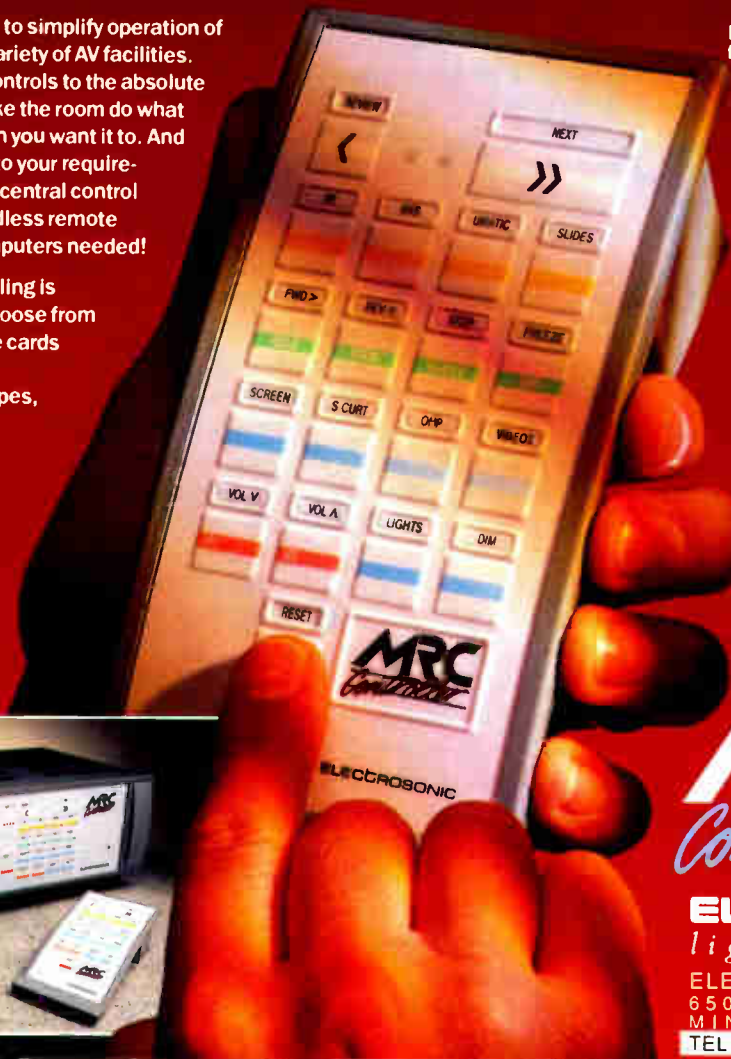

MRC
Controller

ELECTROSONIC
light · sound · image
ELECTROSONIC SYSTEMS, INC.
6505 CITY WEST PARKWAY
MINNEAPOLIS, MN 55344
TEL (612) 941-3236 FAX (612) 941-8155



Circle 234 on Reader Response Card

World Radio History

Industry West Electronics

270 N. Geneva Rd.
Orem, UT 84057
(801) 226-1000 FAX: (801) 226-3268
President: Darold Francis; Director of Marketing:
Jay Simmons; Engineer: Chris Poulsen
PRODUCTS: A/V speakers, audio for A/V,
boardroom sound systems

Infonics, Inc.

2302 E. Michigan Blvd.
P.O. Box 1111
Michigan City, IN 46360
(219) 879-3381 FAX: (219) 879-3383
President, Sales: Carol Lant; Vice President,
Engineering: David Smith
Larkin Associates, Billerica, MA 617-643-1410
PRODUCTS: closed-loop audio systems

Intelix

10500 West Reno - P.O. Box 24031
Oklahoma City, OK 73124-4031
(800) 553-8252 FAX: (405) 324-5217
President: Dave Merrey; Marketing Manager:
Todd Rockwell; Hardware Technical Support:
Tracy Cranton; Software Technical Support: Jack
Vig
ADCOM, Toronto, ON 416-251-3355
PRODUCTS: computer control

IRP, A KNOWLES COMPANY

321 Bond Street
Elk Grove VII., IL 60007
(708) 439-3600 (800) 255-6993
FAX: (708) 640-9607
Vice President, General Mgr.: Brian Benn;
Marketing Manager: Roger Carroll; Senior Sales
Engineer: Gayle Campbell; Marketing
Coordinator: Laura Valavicius; Applications
Engineer: Norm Kinnough; Product Engineering
Manager: Mitch Bentz
Piper and Glvan Assoc., Needham, MA
617-449-1144
Sigmet Corp., Freehold, NJ 201-462-1221
Richard S. Pass Associates, Langhorne, PA
215-757-6100
Henry W. Phillips Co., Rosewell, GA
404-992-3070
Bencsik Associates, Ocala, FL 904-732-9775
C.B. Electronic Marketing, Arvada, CO
303-422-0561
Avwest Inc., Fountain Hills, AZ 602-946-1811
EESCO Systems Inc., Los Angeles, CA 213-666-9601
Pappas Consulting, Menlo Park, CA 415-324-4325
Chuck Olson Assoc., Renton, WA 206-271-5416
Kaltec Communications, North Vancouver, BC
604-987-1597
More Technologies Inc., Los Angeles, CA 213-474-
4211
Audio Marketing Assoc., Brecksville, OH 216-526-
2426
StarIn Marketing, Chesterton, IN 219-929-4127
MJA Marketing, St. Charles, MO 314-447-7111
Graham Davis Inc., Dallas, TX 214-357-7677
PRODUCTS: audio for A/V, boardroom sound
systems, computer control

J.W. DAVIS AND CO.

3030 Canton Street
Dallas, TX 75226
(214) 651-7341 (800) 527-5705 FAX: (214) 939-0328
President: Harvey Earp; Vice President, Sales:
Jack W. Tucker; Chief Engineer: Eric Simonson
Multi-Technical Reps., Brainerd, MN 218-828-9483
PRODUCTS: A/V speakers, audio for A/V,
boardroom sound systems, Intercom, lecterns,
wireless control

KARIBU SOUND INDUSTRIES INC.

3500 Parkdale Avenue
Baltimore, MD 21211
(301) 383-2167 FAX: (301) 383-7573
President: Larry Kirchner
Taub Sales Inc., Silver Spring, MD 301-622-9100
Leslie's, Chicago, IL 708-697-6677
Kodo Associates Inc., Minneapolis, MN 612-881-
1255
Vector Corp., Seattle, WA 206-368-1255
Multi-Technical Reps., Brainerd, MN 218-828-9483
PRODUCTS: A/V speakers, audio for A/V,
boardroom sound systems, lecterns

LEE DAN COMMUNICATIONS, INC.

155 Adams Avenue
Hauppauge, NY 11788-3699
(516) 231-1414 (800) 533-3261 FAX: (516) 231-1498
President: Leon Goldberg; Vice President
Operations: Lawrence J. Goldberg; V.P. Finance &
Administration: David H. Goldberg; Senior
Technician: Sanford Hoffman; Office Manager:
Rita Kaplan; Sr. Sales/Service Associate: Susan
Leon
C.L. Pugh & Associates, Cleveland, OH
216-238-1777
PRODUCTS: Intercom, lecterns

Mitsubishi Electronics America, Inc

5665 Plaza Drive
P.O. Box 6007
Cypress, CA 90630
(714) 220-2500 FAX: (714) 229-3814
President - CEO: Terry O'Flynn; General Mgr.-
Systems Div.: Scott Sakume; National Sales
Manager: Len Robichaud
Chuck Olson Assoc., Renton, WA 206-271-5416

MPO Videotronics

2580 Turquoise Circle
Newbury Park, CA 91320
(805) 499-8513 FAX: (805) 499-8206
President: Larry Kaiser; National Sales Manager:
Mark Barker; Executive V.P. Finance: Julius
Barron; Division Controller: Sharon Glickman
MPO Videotronics, Addison, IL 708-629-1099
MPO Videotronics, New York, NY 212-708-0550
P-O-P TV (Div MPO Videotronic), Portland, OR
503-659-9868
Pan Canada Magnetics -PCM, Scarborough, ON
416-299-4666
Camden Marketing, Pierre Fonds, QU
514-683-3377

Navitar AV

200 Commerce Dr.
Rochester, NY 14623
(716) 359-4000 (800) 828-6778 FAX: (716) 359-4999
President: Julian Goldstein; Vice President:
Colleen Williams
Audio Biz, Mundellen, IL 708-949-0280

Network A-V Innovations

11931 72nd St.
Edmonton, CA T5B 1Y4
(403) 479-1443
Camden Marketing, Pierre Fonds, QU
514-683-3377

Omni Q Inc.

8 12th Street
Blaine, WA 98230
(206) 384-1750 FAX: (604) 664-6347
President: HH von Tiesenhausen; Purchasing:
W. Adam; Comptroller: Susanne Adam
Sunrise Sales Company, LaMoille, IL 815-638-2660
PRODUCTS: computer control, multi-media
controls

OptoDigital Design Inc.

8920 Business Park Drive #435
Austin, TX 78759
(512) 338-4707 FAX: (512) 794-9997
CEO: Rodney Herman; V.P., Sales and Marketing:
Barry Thornton
Audio Etc., St. Peters, MO 314-278-4130
PRODUCTS: closed-loop audio systems, multi-
media controls

OXMOOR CORP.

2111 Parkway Office Circle,
Birmingham, AL 35244
(205) 985-7040 FAX: (205) 985-9966
President: Lynn A. McCroskey; Vice President/
Manager: Gary L. West; National Sales Manager:
Richard C. Mitchell; Sales Associate: Nick
Alsmiller; Production Manager: Jim Watson;
Director of Engineering: Gene Elghmy
John B. Anthony Company, Stamford, CT
212-585-2027
ASR, Fallston, MD 301-893-0001
Audio Resources, Westmont, IL 708-655-1180
Dimension IX Marketing, Lewisville, TX
214-436-3706
Evans Sales and Marketing, Nashville, TN
615-297-7997
Loomis and Associates, Fremont, CA
415-683-0883
Loppnow and Associates, Issaquah, WA
206-392-3936
R.J. Throckmorton Sales Co., Ballwin, MO
314-227-7222
Repworks, Chicopee, MA 413-553-0845
PRODUCTS: boardroom sound systems,
computer control, interface units

Oz Electronics, Inc.

2624 Wilshire Blvd., Santa Monica, CA 90403
(213) 829-3362 FAX: (213) 828-8757
Wizard: Doug Schwartz; Vice Wizard: Bill
Goldman
Oz Electronics, Denver, CO 303-371-3446
Doug Warren, Newport News, VA 804-930-3217

P/H Electronics, Inc.

117 E. Helena St., Dayton, OH 45404
(513) 461-5898 (800) 336-2219
FAX: (513) 223-4858
General Manager: Noel Anderson; Chief
Engineer: V. M. Pantelli; Sales Director: D. C.
Martin; Manufacturing Manager: W. H. Riehe
Camden Marketing, Pierre Fonds, QU
514-683-3377

Panasonic Professional Audio Sys.

6550 Katella Avenue, Cypress, CA 90630
(714) 373-7278 FAX: (714) 373-7242
Nat. Sales & Marketing Mgr.: Steve Woolley;
Marketing Manager: Chris Foreman; Western
Regional Sales Mgr.: James Murray; Midwest
Regional Sales Mgr.: Greg Braithwaite; Eastern
Regional Sales Mgr.: Carla Campbell;
Telemarketing Sales Mgr.: Lynn Thompson
James Murray, Cypress, CA 714-373-7389
Greg Braithwaite, Arlington, IL 708-981-7329
Carla Campbell, Norristown, PA 215-630-1651
Cambridge Marketing, Westerville, OH
614-363-9191 PRODUCTS: A/V speakers

**Find Your Suppliers in the
Sound & Communications
Blue Book**

Paso Sound Products, Inc.

14 First Street, Pelham, NY 10803
(914) 738-4800 (800) 231-3034
FAX: (914) 738-3954
Executive Vice President: Paul Mastrangelo;
Product Manager: Ken O'Brien; Credit
Manager: Marilyn Squegla; Operations
Manager: Anthony Squegla
Anderson Sales, Braintree, MA 617-848-9194
Jack Mesnick Sales, Liverpool, NY 315-622-3211
Palmer Associates, Fairfield, NJ 201-882-1266
Weller Electronic Sales, Inc., Worthington, OH
614-885-7819
Lienau Associates, Columbia, MD 301-621-4113
MJA Marketing, St. Charles, MO 314-447-7111
Northland Assoc., Moorehead, MN 218-233-4616
Allwest Sound & Communication, Camarillo, CA
805-388-7745
Dimension Pt. IX Marketing, Katy, TX
713-578-9277
Mountain Representatives, Denver, CO
303-333-7745
Miguel Lopez, Hialeah, FL 305-822-6853
Paco Electronics, Ltd., Markham, ON 416-475-0740
Robert Milsk Co., Southfield, MI 313-354-3310
Marketline Inc., Snellville, GA 404-972-9048
Hawkins-Frederickson Assoc., Maitland, FL
407-831-2474
Lintern Associates, Naperville, IL 708-904-1225
Robert Milsk Co., Indianapolis, IN 317-842-3400
PRODUCTS: boardroom sound systems,
Intercom, lecterns

Precise Manufacturing Co. Inc.

2143 E. 5th St., Tempe, AZ 85281
(602) 967-0030 (800) 821-0862
FAX: (602) 967-0030
Vice President: Harold Wedell;
Training/Development: Ralph Ferguson
Dimension/ Point IX, Lewisville, TX 214-436-3706
PRODUCTS: A/V speakers, audio for A/V,
computer control, electronic displays, image
projectors, intercom, interface units, multi-
media controls

Protech Audio Corporation

Flowerfield Bldg. 1, St. James, NY 11780
(516) 584-5855 FAX: (516) 584-5904
Director of Marketing: Bill Murphy; Sales
Engineering: Joseph Ciambone
Peregrine Southwest Reps, Houston, TX
713-589-8481
First Choice Marketing, Seattle, WA
206-524-7344
Dimension/ Point IX, Lewisville, TX
214-436-3706
PRODUCTS: audio for A/V, boardroom sound
systems, intercom, interface units

R.A. Gray, Inc.

9181 Chesapeake Drive, San Diego, CA 92123
(619) 560-4162 FAX: (619) 560-1923
Applications Engineer: Kevin Cutter;
Applications Engineer: Robert Harvey;
President: Richard Gray
R.A. Gray Inc., Glendale, CA 818-500-9698
Karp Communications, Tampa, FL 813-968-7098

Runco International

26203 Production #8, Hayward, CA 94545
(415) 293-9154 (800) 23-RUNCO
FAX: (415) 293-0201
President: Lori Bergamaschi
JDS Marketing, Irvine, CA 714-854-0910
Ustow Marketing, Mequon, WI 414-242-1405
Sight & Sound, Saginaw, MI 517-781-4014
St. Peters Marketing, Indiana, KY 317-547-3671
Advanced A/V, Tampa, FL 813-879-0958
Precide, Morbio Inferiore, Switzerland,
914-31734
PRODUCTS: Image projectors

Sandy Enterprises Inc.

P.O. Box 1, E. Northport, NY 11731-0001
(516) 266-5767 FAX: (516) 266-5767
President: Sandy Tannenbaum
Sound Sales, Inc., Columbia, MD 301-964-1170

Sharp Electronics Corp./Pro. Prod.

Sharp Plaza- Mall Stop 35, Mahwah, NJ 07430
(201) 529-8662 FAX: (201) 512-2015
Marketing Manager: Robert Soucy; General
Manager: Sherman Langer; Vice President:
Perry Clay; Service Manager: John Burek
Sound Sales, Inc., Columbia, MD 301-964-1170

**SONY CORP. OF AMERICA,
A/V PRODUCTS**

10833 Valley View Street, Cypress, CA 90630
(714) 229-4318 (800) 326-7669
FAX: (714) 229-4298
Vertical Markets Manager: T. Park; AV Product
Manager: A. Nitta; AV Sales Manager: K. Carr;
AV Product Support Spvr.: A. Ruppe;
Management Associate: D. Williams; Product
Support Coordinator: P. Penell
Cambridge Marketing, Westerville, OH
614-363-9191
PRODUCTS: Image projectors, multi-media
controls

Sony Corp./Business & Pro. Aud. Grp

3 Paragon Drive, Montvale, NJ 07645-1735
(201) 930-1000
President, Sales & Marketing: Mark Gray;
Senior VP Sales: C.F. Taylor; V.P. Product
Marketing: Anthony Gargano; Marketing
Manager, Pro Audio: Courtney Spencer; Sales
Manager, Pro Audio: Gary Rose; V.P. Audio
Products: Ron Remschel
Matt Robertson, Western Dist., 213-469-9084
Audio Etc., St. Peters, MO 314-278-4130
PRODUCTS: electronic displays, image
projectors, wireless control

Sound Control Technologies, Inc.

28 Knight St., Norwalk, CT 06851
(203) 854-5701 FAX: (203) 854-5702
President: Adolph Neaderland;
Sales/Marketing: David Neaderland
Powerlines Marketing, Chicago, IL 708-864-1147
Franklin Communications, Philadelphia, PA
215-643-2808
KBZ Communications, New York, NY
215-348-9481
Visitec Marketing, Minneapolis, MN
612-925-2691
Total Marketing, Fort Worth, TX 817-560-3970
Karp Communications, Tampa, FL 813-968-7098
Richard Krupop, Andalusia, AL 205-222-8950
PRODUCTS: boardroom sound systems

Sound-Craft Systems, Inc.

Route 3, Box 319, Morrilton, AR 72110
(501) 727-5476 (800) 643-8747
FAX: (501) 727-5402
V.P., Administration: Katherine Foust; V.P.,
Mfg. & Engineering: Hugh Donnel; V.P., Sales &
Marketing: Hank Shaw; Secretary/Treasurer:
Katherine Foust; Sales & Marketing: Bruce
McCullough; Sales/Service: Cindy Hurley
Jack Shaffer & Associates, Bayside, NY
718-352-8838
Sunrise Sales Company, LaMolle, IL
815-638-2660 PRODUCTS: lecterns

Soundstream Technologies

120 Blue Ravine Road, Folsom, CA 95630
(916) 351-1288 FAX: (916) 351-0414
President: Donna Haas; Managing Director:
Lee Adams; Director of Engineering: Wade

Stewart; Ntl. Sales Mgr., Home Audio: Scott
McAllister; Sales Engineer, Home Audio:
Andrew Murray
John W. Steinberg Company, Encino, CA
818-705-7772
Moskau & Associates, Dallas, TX 214-821-4280
Creative Marketing Associates, Nashville, TN
615-831-9690
On Line Marketing, Wadsworth, OH
216-336-7504
Sound Marketing, Palos Hills, IL 708-598-6888
Cambridge Marketing, Westerville, OH
614-363-9191

PRODUCTS: audio for A/V, boardroom sound
systems, wireless control
Soundwall Corp.

103 Commercial Drive, Iowa City, IA 52246
(319) 351-9144 (800) 772-1661
FAX: (319) 354-0701
President & C.E.O.: Ken Leavitt
Franklin Communications, Philadelphia, PA
215-643-3031
Jamm Distributing, Chicago, IL 708-799-0550
KBZ Communications, New York/N.E.,
215-348-9481
Total Marketing, Ft. Worth, TX 817-560-3970
Karp Communications, Tampa, FL 813-920-7667
Sound Sales, Inc., Columbia, MD 301-964-1170

Stewart Filmscreen Corporation

1161 West Sepulveda, Torrance, CA 90502
(213) 326-1422 (800) 762-4999
FAX: (213) 326-6870
Vice President Marketing: Don Stewart;
National Sales Manager: Joe Morgan; General
Manager: Grant Stewart; Inside Sales Manager:
Steve Goss; Product Specialist: John Higgins;
Customer Service Rep.: Diana Ha
Karp Communications, Tampa, FL 813-968-7098
PRODUCTS: screens

TARGET TECHNOLOGY, INC.

P.O. Box 609, Penn Valley, CA 95946
(916) 639-2102 FAX: (916) 639-2212
President: Peter F. Hughes
Crescendo Associates, Hollywood, FL 305-922-
9553
PRODUCTS: audio for A/V

Technical Acoustics, Inc.

3027 Plymouth Street, Jacksonville, FL 32205
(904) 384-8884 FAX: (904) 384-8906
President: Donald Bowers; Vice President:
Sheldon Gilck; Office Manager: Maria
Hammarlund
R.C.S., New Milford, NJ 201-261-5560
R.C.S., Whitefish Bay, WI 414-332-6555
William Ray & Associates, Charlotte, NC 704-
537-4990
R.S.I., Irving, TX 214-256-4551
Loomis & Associates, Fremont, CA 415-683-0883
JMS Marketing, Austin, TX 512-266-1113

Telephone Components

3180 Expressway Dr. S., Central Islip, NY 11722
(516) 582-4745
Camden Marketing, Pierre Fonds, QU 514-683-
3377

TELEX COMMUNICATIONS, INC.

9600 Aldrich Avenue South,
Minneapolis, MN 55420
(612) 884-4051 FAX: (612) 884-0043
President: Jeffrey Wetherell; Vice President
Marketing: John Schofield; Vice President
Sales: Dan Dantzler; Director of Marketing:
Don Meehan; Manager/Advertising & Mkt'g:
Ron Taylor
WesTech Marketing, Culver City, CA 213-870-

9286
 Bencsik Associates, Ocala, FL 904-732-9775
 Burcaw Company & Associates, Warren, MI 313-573-4605
 SAGA, Oswego, NY 315-343-5739
 Monfort Electronic Marketing, Indianapolis, IN 317-872-8877
 Murphy & Cotta, Inc., Atlanta, GA 404-875-2525
 Northland Associates, Moorhead, MN 218-233-4616
 Rancilio Associates, Inc., St. Louis, MO 314-845-0202
 J.Y. Schoonmaker Company, Dallas, TX 214-349-1650
 Sigmat Corporation, Valley Forge, PA 215-783-6666
 Weller Electronic Sales, Worthington, OH 614-885-7819
 Ziskind Associates, Rolling Meadows, IL 312-577-1624
 White Radio Ltd., Burlington, ON 416-632-6894
 Silver Peak Marketing, Denver, CO 303-467-9042
 PacNor Marketing, Lynnwood, WA 206-771-6016
 PRODUCTS: audio for A/V, image projectors, Intercom



TOA ELECTRONICS, INC.

601 Gateway Blvd. Suite 300
 P.O. Box 2047
 S San Francisco, CA 94080
 (415) 588-2538 (800) 733-4750
 FAX: (415) 588-3349
 President: Yoshiro Ishida; Director, Audio Products Div: Richard Krochmal; Director, Comm. Systems Div.: Al Burns; Mgr., Marketing Development: Jeff Pallin; Manager, Western Division: Bill Ford; Manager Engineering Services: Bob Sweet
 Chuck McGregor- Product Const, Morris Plains, NJ 201-829-7047
 John Murray-Eng.Snd. Mktg. Dev, Springfield, OH 513-324-1993
 Bob Hager-Eastern Regional Mgr, Rosewell, GA 404-552-7624
 Linda Wick-Central Reg. Mgr., Kansas City, MO 816-453-5775
 Robert Slaughter-Cntri Div Mgr, Houston, TX 713-460-3678
 Pete Newmark-West Regional Mgr., Mesa, AZ

602-981-0050
 Walter Best, Eastern Reg. Mgr., Sussex, NJ 201-702-0068
 PRODUCTS: A/V speakers, audio for A/V, boardroom sound systems

TSI (Tamco Systems Inc.)

393 Jericho Turnpike, Mineola, NY 11501
 (516) 294-5390 (800) 628-2084
 FAX: (516) 294-5008
 CEO: Mario Maitese; President: Ganai Srinivasan; President (Spec. Prod. Div.): Richard Stillwell; Sales Coordinator: Denise Matejka; Marketing Manager: Karen Pepe
 JMS Marketing, Austin, TX 512-266-1113
 PRODUCTS: audio for A/V, multi-media controls

Uni-Screen, Inc.

263 Kansas Street, Horicon, WI 53032
 (414) 485-3123 FAX: (414) 485-2696
 President: Wayne R. Davidson; Plant/Project Manager: Thomas A. Fritche; Office/Credit Manager: Jean A. Kuechler; Sales Manager: John DeSilva
 JDS Marketing, Irvine, CA 714-854-0910
 Bach Sales Corp., New York, NY 212-727-0404
 New Resource, Hanover, MA 203-238-3027
 Interiect Marketing, Kennesaw, GA 404-439-6414
 Advanced Audio/Video, Tampa, FL 813-879-0958
 Sound Sales, Inc., Columbia, MD 301-964-1170
 St. Peters Sales Agency, Indianapolis, IN 317-547-3671
 Gary Listau, Mequon, WI 414-242-1405
 PRODUCTS: screens

**Order More
 Blue Books
 Now!**

AB International • A/DA • Adams-Smith • AKG • Altman • American DJ • Ampex • Anchor • Anvil • Aphex • Apollo • Aris • ART • Ashly • ATI • Atlas/Soundolier • Audio Controls • Audio Technica • Audix • Aurelone • BASF • Beckman • Belden • BEST • Beyer/Dynamic • BGW • Blackbourn • Bogen • Boss • Brefford • Buhl Industries • C-Ducar • Calzone • Canaro • Casio • Clear-Com • Clone-Tone • Cole Flex • Comprehensive • Connectronics • Conquest • Courier • Countryman • Crest • Cutting Wedge • Da Lite Screen • DIC • EdKall-Xedit • Electro-Voice Mics • ETA • FUJI • Furman • GE Lamps • Gemini • Geneva(Nortronics) • GEPCO • Gerriets International • Goldline • Hafler • Henry Engineering • HME • Hosa • Intelix • AutoCue • ITC-Cart • JSC • Kendall Gaffer Tape • Leader Instruments • Leprecon • Lightwave • Littlita (CAE) • Loft • Lowell-Light • Lowell Gaffer Tape • LTM • Luxo • Mackenzie • Magnetic Reference Lab • Marantz • Maxon • Middle Atlantic • Mogami • Nady • Ness • Neutrik • NSI • Numark • Omnicraft • Omnimount • Panasonic CCTV • Panasonic Consumer • Panasonic Industrial Video • Peico • Philmora • Porta-Brace • ProCo • R & R Case • Radio Design Labs • Ramko • Raxcess • Rocktron • Rockustics • Rosco • Samson • Scotch/3M • Sennheiser • Sencorn • Shure • Signal Cable/Colman • Sony • Sound Craft Systems • Soundtech • Standard Tape Labs • Standtastic • Stanton • Star Case • Stewart • Strong • Studiomaster • Switchcraft • Symetris • TDK • Tannoy • TEAC • Telex/RTS • Tram • Tiffen • Totevision • Tripp-Lite • Ultimate Support • Union Connector • Unitech • University Sound • US Audio • Ushio • Valley People • Varta • VDO • Vidicraft • West Penn • Whirlwind • White • Wilko • Williams Sound • Winstead

**WHOLESALE
 PRICES
 CALL!**

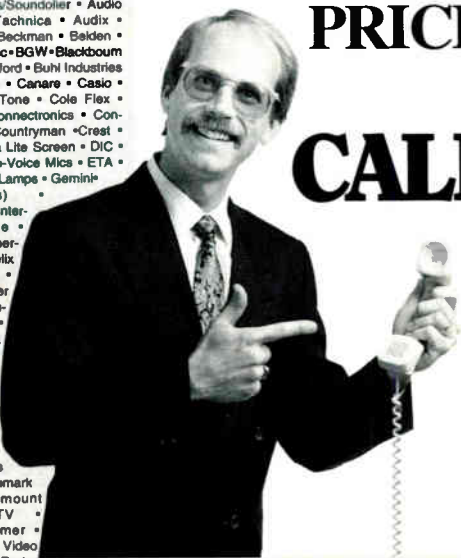

1-800-828-0509

**FULL DISCOUNT
 WHOLESALERS**

AUDIO • VIDEO • LIGHTS

Local Phone: (608) 273-5488 Madison, WI

**FREE
 INFORMATION**

Use the Reader Response Cards in this issue to find out more about companies that interest you.

Circle 264 on Reader Response Card

Valley International Inc.

616 Bradley Court, Franklin, TN 37064
 (615) 370-5901 (800) 800-4345 FAX: (615) 370-5907
 President: Norman Baker; V.P. Finance & Admin.:
 Tammy Webb; V.P. Engineering & Mktg.: Jason
 Dunaway; V.P. Sales & Operations: Jay Nelson
 Cambridge Marketing, Westerville, OH 614-363-9191

Vansan Corp.

16735 East Johnson Drive, Industry, CA 91745
 (818) 961-7211 (800) 423-1829 FAX: (818) 369-9510
 President: Mark Vanlandingham; Vice President,
 Sales: Chris Forbes; Vice President, Production:
 Ron Dain
 Alan Sarfaty and Associates, New York, NY 516-466-
 6770

Loomis and Associates, Alameda, CA 415-797-3500
 Lex Lawson and Associates, Garland, TX
 214-272-8482

Visitec Marketing, Elburn, IL 708-365-9600
 Presentation Resources, Mauldin, SC 803-288-8840
 Cambridge Marketing, Westerville, OH 614-363-9191
 PRODUCTS: lecterns, screens

Video Accessory Corp.

2450 Central Ave. Suite H
 Boulder, CO 80301
 (303) 443-4950 (800) 821-0426 FAX: (303) 440-8878
 CEO: N. Baer; President & Chief Engineer: J.
 Baird; CFO: M. Baer; VP Sales and Marketing: D.
 Dykstra; Purchasing & Prod.: C. Tremmer
 Omnivue, New York, NY 212-532-5576
 Vica Associates, Decatur, GA 404-292-7506
 GO Video Sales, Lake Forest, IL 708-295-6726
 RL Graham Associates, Leawood, KS 913-383-3475
 Techreps, San Jose, CA 408-441-6700
 PRODUCTS: audio for A/V

Video Link

12950 Bradley Avenue
 Sylmar, CA 91342
 (818) 362-0353 (800) 843-5465 FAX: (818) 362-9506
 President: Herb Seymour; V.P. Sales and
 Marketing: Bill Cawfield; Sales Manager: Larry
 W. Schatz; Asst. Sales Manager: Marguerita Kiser
 J.B. Parent, Dublin, OH 614-764-0064
 PRODUCTS: Interface units, multi-media
 controls, wireless control

Vidikron of America

150 Bay St.
 Jersey City, NJ 07302
 (201) 420-6666
 Vice President: Giovanni Cozzi; Director of Sales:
 James Wellnitz
 Chuck Olson Assoc., Renton, WA 206-271-5416

**Weircliffe Degaussers/div of
Paltex**

2752 Walnut Avenue
 Fustin, CA 92680
 (714) 838-8833 FAX: (714) 838-8833
 Director of Sales, US: Gene Tollini; Product
 Specialist: A. James "Jim" Owen; Marketing
 Manager: Earl M. Jamgochian
 WJA Marketing, St. Charles, MO 314-447-7111

Kedit Corp.

218-31 97th Avenue
 Queens Village, NY 11429
 (718) 464-9400 FAX: (718) 464-9435
 Cambridge Marketing, Westerville, OH
 614-363-9191

BACK/ FOREGROUND SYSTEMS & LIBRARIES

3M SOUND PRODUCTS

Bldg. 551-1W-01
 St. Paul, MN 55144
 (612) 736-0843 FAX: (612) 736-7614
 National Sales Manager: Don Sluder
 JMS Marketing, Austin, TX 512-266-1113
 PRODUCTS: cassette players and changers, music
 libraries, stock and custom, music services, SCA
 equipment, tape systems

AEI Music Network, Inc.

900 E. Pine, Seattle, WA 98122
 (206) 329-1400 (800) 831-8001 FAX: (206) 329-9952
 President/C.E.O.: Michael Malone; Vice
 President/Dealer Sales: Lon Troxel
 Cambridge Marketing, Westerville, OH
 614-363-9191
 PRODUCTS: cassette players and changers, music
 libraries, stock and custom, music services, tape
 systems

**Amplex Recording Media
Corporation**

401 Broadway
 Redwood City, CA 94063-3199
 (415) 367-2011 FAX: (415) 367-4132
 President: Tom Wheeler; V.P./U.S. Sales & Cust.
 Serv: Richard Antonio; V.P./Audio & Video Tape
 Prod: Phil Ritti; V.P. of Engineering: Dave Davies
 Jerry Dubbs, Rolling Meadows, IL 708-590-5100
 Bob Smith, Allendale, NJ 201-825-9600
 Jack James, Tucker, GA 404-491-7112
 Jerry Nevill, Carrollton, TX 214-960-1162
 Bruce Thorkelson, San Fernando, CA 818-365-
 8627
 Nova Marketing, San Francisco, CA 415-952-0943

Audico Chicago, Inc.

7206 W. Grand Ave.
 Elmwood Park, IL 60635
 (708) 456-0003 FAX: (708) 456-0418
 Cambridge Marketing, Westerville, OH 614-363-
 9191

Audicom, Inc.

8100 Oak Lane #401
 Miami Lakes, FL 33016
 (305) 825-4653 (800) 272-0555 FAX: (305) 558-8799
 President: Ron DeBlinger; Vice President of
 Operations: Art Hecht; Director of Marketing:
 Stu Ginsberg
 Edwards Company, Inc., Livonia, MI 313-458-7777

GEFEN SYSTEMS INTRODUCES:

THE NSM CD2101-AC CD CHANGER

"THE MOST AMAZING CD CHANGER IN THE WORLD"

(Only 4 Seconds Inbetween Discs - Holds 100 Compact Discs)

together with

"THE MOST ADVANCED BACKGROUND MUSIC SOFTWARE"

(Ideal for Hotels, Restaurants, Night Clubs, Cable Systems, Automated Radio Stations & Homes)

- DIGITAL AUDIO output.(SPDIF)
- 4-5 seconds access time between discs
- RS-232 Interface
- 16 CD Changers on a single COM port
- 100 CDs ONLINE

NSM CD2100

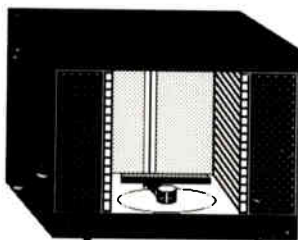

The NSM CD2101-AC works with:

- CD.J. CLASSICS MUSIC SYSTEM
- CD.J. MacJukeBox MUSIC SYSTEM
- CD-SOUND MUSIC SYSTEM
- SOUNDTOUCH MUSIC SYSTEM

For more information contact:



GEFEN SYSTEMS

6261 VARIEL AVE. SUITE C
 WOODLAND HILLS, CA 91367
 PHONE: 818-884-6294 or 1-800-545-6900
 FAX: 818-884-3108

Circle 271 on Reader Response Card

Audiolab Electronics Inc.

5831 Rosebud Lane, Building C
Sacramento, CA 95841
(916) 348-0200 FAX: (916) 348-1512
President: Robert E. Stofan; V.P. Marketing and
Sales: Ronald A. Stofan; Production Manager:
Marc A. Moore
Cambridge Marketing, Westerville, OH
614-363-9191
PRODUCTS: tape systems

Benjamin International, Inc.

16 Newtown Plaza, Plainville, NY 11803
(516) 753-0700 (800) 572-8989 FAX: (516) 753-0839
President: Joseph N. Benjamin; Vice President:
Charles Tanner; Office Manager: Anne Lawson
Larry Schirmer, Pontiac, MI 313-340-9588
PRODUCTS: tape systems

BGM International

1601 N. Pace Boulevard
P.O. Box 8057
Pensacola, FL 32505
(904) 434-1953 FAX: (904) 433-7932
Owner: F.T.C. Brewer; National Sales Director:
Fritz Brewer
Greg Dzubay & Assoc., Glendale, AZ 800-999-0006

Casco Background Sound, Inc.

50 Terminal Street
P.O. Box 115
Charlestown, MA 02129
(617) 242-2983 FAX: (617) 242-5209
President: Samuel J. Blengs
Edwards Company, Inc., Livonia, MI 313-458-7777
PRODUCTS: music libraries, stock and custom,
tape systems

Dayton Industrial Corporation

4411 Bee Ridge Road
Sarasota, FL 34232
(813) 378-5425 FAX: (813) 378-3394
Edwards Company, Inc., Livonia, MI 313-458-7777

EMS/Music

4204 Stone Way N., Seattle, WA 98103
(206) 547-3010 (800) 666-6874 FAX: (206) 547-3004
President: R. Kilroy Hughes; Production
Manager: Doug Sanders; National Sales Rep.:
David Pearson; Customer Service Rep.: Lillian
Forgette; AR Manager: Christina Mills
Cambridge Marketing, Westerville, OH
614-363-9191
PRODUCTS: automatic mixers, CD changers,
music services, tape systems

Fidelipac Corp.

97 Foster Road
P.O. Box 808
Moorestown, NJ 08057
(609) 235-3900 FAX: (609) 235-7779
President: Roger Thanhauser; Vice Pres. &
General Manager: Dan McCloskey; Director of
Sales: Scott Martin; Director of Engineering: Bill
Franklin; Customer Service Manager: Fred
Buehler
Greg Dzubay & Assoc., Glendale, AZ 800-999-0006
PRODUCTS: tape systems

Gefen Systems

6261 Variel Avenue #C
Woodland Hills, CA 91367
(818) 884-6294 (800) 545-6900 FAX: (818) 884-3108
President: Hagal Gefen; Vice President,
Marketing: Jill Shuken; Sales Director: Doug
Perkins
Greg Dzubay & Assoc., Glendale, AZ 800-999-0006

**INNOVATIVE ELECTRONIC
DESIGNS, INC.**

9701 Taylorsville Rd.
Louisville, KY 40299
(502) 267-7436 FAX: (502) 267-9070
President: Hardy Martin; Vice President, Mkt'g &
Sales: Tom Roseberry; Sales Application
Engineer: Mark Lewellyn; V.P. Research &
Development: Bob Ponto; Vice President,
Engineering: Ed Young; Vice President,
Software: John Johnson
Yore Company, White Bear Lake, MN
612-770-9760
Steffey Marketing Assoc. Inc., Northbrook, IL
708-480-3575
WestTech Marketing, Culver City, CA 213-870-9286
Repworks, Chicopee, MA 413-533-0845
Darmstedter Associates, Baldwinsville, NY
315-638-1261
John Anthony, Stamford, CT 203-322-9202
Bencsik Associates, Ocala, FL 904-732-9775
C.L. Pugh, Cleveland, OH 216-238-1777
Monford Electronics Marketing, Indianapolis, IN
317-872-8877
C.M. Sales, Farmington Hill, MI 313-553-8070
B.C. Electronic Sales, Mission, KS 913-262-1720
Marketing Concepts, Irving, TX 214-869-0669
Torbett/Kelser Group, Loveland, CO 303-669-1008
Plus Four Marketing, Walnut Creek, CA
415-937-0650
North Shore Marketing, Seattle, WA 206-284-9699
Island Instruments, Kaneohe, HI 808-235-7544
PRODUCTS: automatic mixers

International Electro-Magnetics Inc

350 N. Eric Drive
Palatine, IL 60067
(708) 358-4622 FAX: (708) 358-4623
President: Tony Pretto
Greg Dzubay & Assoc., Glendale, AZ 800-999-0006
PRODUCTS: cassette players and changers,
cassette recorders

IRP, A KNOWLES COMPANY

321 Bond Street
Elk Grove VII., IL 60007
(708) 439-3600 (800) 255-6993 FAX: (708) 640-9607
Vice President, General Mgr.: Brian Benn;
Marketing Manager: Roger Carroll; Senior Sales
Engineer: Gayle Campbell; Marketing
Coordinator: Laura Valavcius; Applications
Engineer: Norm Kinnaugh; Product Engineering
Manager: Mitch Bentz
Piper and Givan Assoc., Needham, MA
617-449-1144
Sigmet Corp., Freehold, NJ 201-462-1221
Richard S. Pass Associates, Langhorne, PA
215-757-6100
Henry W. Phillips Co., Rosewell, GA 404-992-3070
Bencsik Associates, Ocala, FL 904-732-9775
C.B. Electronic Marketing, Arvada, CO
303-422-0561
Awwest Inc., Fountain Hills, AZ 602-946-1811
EESCO Systems Inc., Los Angeles, CA 213-666-9601
Pappas Consulting, Menlo Park, CA 415-324-4325
Chuck Olson Assoc., Renton, WA 206-271-5416
Kaltec Communications, North Vancouver, BC
604-987-1597
More Technologies Inc., Los Angeles, CA
213-474-4211
Audio Marketing Assoc., Brecksville, OH
216-526-2426
Starin Marketing, Chesterton, IN 219-929-4127
MJA Marketing, St. Charles, MO 314-447-7111
Graham Davis Inc., Dallas, TX 214-357-7677
PRODUCTS: automatic mixers

Magnefax International Inc.

Rt. 1 Box 764
Rogers, AR 72756
(501) 925-1818 FAX: (501) 925-1841
President: Dennis Tallakson
Doug Warren, Newport News, VA 804-930-3217
PRODUCTS: tape systems

Marantz Professional Audio

700 N. Commerce St.
Aurora, IL 60504
(708) 820-4800 FAX: (708) 820-8103
Vice President, Mkt'g & Sis.: Jack Hopkins;
Business Development Manager: Steve Kish
Doug Warren, Newport News, VA 804-930-3217

Music Programming Inc.

265 Concord St.
Framingham, MA 01701
(508) 875-3530 FAX: (508) 653-5898
President: Raymond J. Regis; Vice President:
Dutch Blue

Music Springs, Inc.

93 Broad Street
P.O. Box 128
Matawan, NJ 07747
(201) 566-9600 FAX: (201) 566-0451
President: Gloria A. Bolendz; Vice President:
John H. Bolendz
Audio Etc., St. Peters, MO 314-278-4130
PRODUCTS: cassette players and changers, music
libraries, stock and custom, music services, tape
systems

Musikos, Inc.

741 Kenilworth Ave. Suite 100
Charlotte, NC 28204
(704) 375-2666
Audio Etc., St. Peters, MO 314-278-4130

Muzak

400 N. 34th Street, Suite 200
Seattle, WA 98103
(206) 633-3000 (800) 331-3340 FAX: (206) 633-6210
President: John R. Jester; Sr. V.P. Sales and
Marketing: Jim Harrison; V.P., Affiliate Sales &
Dev.: Jack D. Craig; Vice President,
Programming: Bruce Funkhouser; V.P., National
Sales: John Neal
Loomis and Associates, Fremont, CA 415-683-
0883

Nakamichi America

19701 S. Vermont
Torrance, CA 91042
(213) 538-8150 (800) 421-2313 FAX: (213) 324-7614
National Sales Coordinator: Kim Wilson; Senior
Director, Sis & Mkt'g: Len Provost
Audio Resources, Westmont, IL 708-655-1188
Sigmet Corp., Valley Forge, PA 215-783-6666
Tenickl & Associates, Houston, TX 713-528-2005
Western Audio Sales, Burbank, CA 818-954-9300
Bencsik & Associates, Ocala, FL 904-732-9775
Camden Marketing, Pierre Fonds, QU 514-683-
3377

Nortronics Company, Inc.

6750 Shady Oak Road
Eden Prairie, MN 55344
(612) 545-0401 (800) 328-5640 FAX: (612) 540-8671
Sales Manager: Karen Nickolauson
Dimension/ Point IX, Lewisville, TX 214-436-3706

Paso Sound Products, Inc.

14 First Street, Pelham, NY 10803
 (914) 738-4800 (800) 231-3034 FAX: (914) 738-3954
 Executive Vice President: Paul Mastrangelo;
 Product Manager: Ken O'Brien; Credit Manager:
 Marilyn Beckerson; Operations Manager:
 Anthony Squeglla
 Anderson Sales, Braintree, MA 617-848-9194
 Jack Mesnick Sales, Liverpool, NY 315-622-3211
 Palmieri Associates, Fairfield, NJ 201-882-1266
 Weller Electronic Sales, Inc., Worthington, OH
 614-885-7819
 Llenau Associates, Columbia, MD 301-621-4113
 MJA Marketing, St. Charles, MO 314-447-7111
 Northland Assoc., Moorehead, MN 218-233-4616
 Allwest Sound & Communication, Camarillo, CA
 805-388-7745
 Dimension Pt. IX Marketing, Katy, TX 713-578-9277
 Mountain Representatives, Denver, CO
 303-333-7745
 Miguel Lopez, Hialeah, FL 305-822-6853
 Paco Electronics, Ltd., Markham, ON 416-475-0740
 Robert Milk Co., Southfield, MI 313-354-3310
 Marketline Inc., Snellville, GA 404-972-9048
 Hawkins-Frederickson Assoc., Maitland, FL
 407-831-2474
 Intern Associates, Naperville, IL 708-904-1225
 Robert Milk Co., Indianapolis, IN 317-842-3400
 PRODUCTS: tape systems

Pentagon Industries, Inc.

5115 N. Sheridan Rd., Chicago, IL 60640
 (312) 271-8300 (800) 621-3867 FAX: (312) 271-0027
 Owner/President: Lateef Khan; Vice
 President/Sales: John Vinci
 Dimension/Point IX, Lewisville, TX 214-436-3706

Rowe International Inc.

75 Troy Hills Road, Whippany, NJ 07981
 (201) 887-0400 (800) 553-8054 FAX: (201) 887-2851
 Sales Manager: Beverly LaForte
 Sunrise Sales Company, LaMoille, IL 815-638-2660
 PRODUCTS: music libraries, stock and custom,
 music services, tape systems

S.E.M. Co.

#17-636 Clyde Ave., W. Vancouver, BC V7T 1E1
 (604) 922-0526 FAX: (604) 922-0526
 President: Elk Ebert; Vice President: Anne Moretti
 Karp Communications, Tampa, FL 813-968-7098
 PRODUCTS: automatic mixers

SCA Data Systems, Inc.

225 Arizona Avenue, Suite 350
 Santa Monica, CA 90401
 (213) 576-0655 FAX: (213) 576-0566
 Chairman: Lawrence J. Karr; President: Steven J.
 Davis; Operations Manager: Corinne D. Weber;
 Service Manager: Mark Medow
 Karp Communications, Tampa, FL 813-968-7098

Seven Systems, Inc.

4315 Spartacus Drive, Huntsville, AL 35805
 (205) 881-2193
 President: Clay Durrett
 Camden Marketing, Pierre Fonds, QU 514-683-3377
 PRODUCTS: SCA equipment

SMC International, Inc.

2505 N. 24th Street
 Omaha, NE 68110
 (402) 453-0332 (800) 456-9107 FAX: (402) 453-2314
 President: Jay B. McMartin; Vice President/Sales:
 Lawrence Y. Wiedman; Inside Sales Manager:
 Cynthia J. Marsh; Chief Engineer: Richard
 Diercks
 Karp Communications, Tampa, FL 813-968-7098
 PRODUCTS: music services, SCA equipment

Sony Corp./Business & Pro. Aud. Grp

3 Paragon Drive
 Montvale, NJ 07645-1735
 (201) 930-1000
 President, Sales & Marketing: Mark Gray; Senior
 VP Sales: C.F. Taylor; V.P. Product Marketing:
 Anthony Gargano; Marketing Manager, Pro
 Audio: Courtney Spencer; Sales Manager, Pro
 Audio: Gary Rose; V.P. Audio Products: Ron
 Remschel
 Matt Robertson, Western Dist., 213-469-9084
 Audio Etc., St. Peters, MO 314-278-4130
 PRODUCTS: automatic mixers, CD Changers

Studer Revox America, Inc.

1425 Elm Hill Pike
 Nashville, TN 37210
 (615) 254-5651 FAX: (615) 256-7619
 President: Tore Nordahl; Executive Vice
 President: Bill Muggler; Director, Professional
 Prods: David Bowman; Director of Tech.
 Operations: Jim Kurowski; Dir. of Tech. and
 Mktg. Srvs: Doug Beard
 Studer Revox America, New York, NY 212-255-
 4462
 Studer Revox America, Los Angeles, CA 818-780-
 4234
 Studer Revox Canada Ltd., Toronto, CA 416-510-
 1347
 Jim Burger, Philadelphia, PA 203-297-7160
 PRODUCTS: cassette recorders

Tape-Athon

13633 Crenshaw Blvd.
 P.O. Box 5023
 Hawthorne, CA 90250
 (213) 676-6752 FAX: (213) 676-9532
 Audio Biz, Mundellen, IL 708-949-0280

Uher of America

7067 Vineland Avenue
 North Hollywood, CA 91605
 (818) 764-1120 FAX: (818) 764-1129
 President: John Belgiorno
 Cambridge Marketing, Westerville, OH
 614-363-9191
 PRODUCTS: cassette recorders

VIF International

P.O. Box 1555
 Mountain View, CA 94042
 (408) 739-9740 (800) 848-4428 FAX: (408) 739-0809
 President: Nancy Mackechnie; Advisor of Int'l
 Operations: Gordon Mackechnie; Office
 Manager: Celia Quanz
 Cambridge Marketing, Westerville, OH 614-363-
 9191
 PRODUCTS: tape systems

**Subscribe to
 Sound &
 Communications
 Magazine**

**A & S Case Company**

1111 N. Gordon St.
 Hollywood, CA 90038
 (213) 466-6181 FAX: (213) 466-4068
 President: William B. Berry; Secretary: Ken
 Berry; Treasurer: Dolph Rempp
 Doug Warren, Newport News, VA 804-930-3217
 PRODUCTS: ATA cases and racks, enclosure
 systems, custom cabinets and consoles,
 equipment cabinets and enclosures, flight cases,
 hardware, instrumental cabinets, modular boxes,
 rack hardware, shelves, rack-mounts, shock-
 mount racks and cases, slides, specialty cases,
 storage racks and cases, tool cases

Accurate Sound Corp.

3515 Edison Way
 Menlo Park, CA 94025
 (415) 365-2843 FAX: (415) 365-3057
 Audio Etc., St. Peters, MO 314-278-4130

Amco Engineering Co.

3801 Rose St.
 Schiller Park, IL 60176
 (708) 671-6670 (800) 833-3156 FAX: (708) 671-9463
 President: Edwin V. Anderson; Vice President:
 Joseph Mack; National Sales Manager: Floyd A.
 Johnson; Director of Marketing: James R.
 Walenda
 Knight Company, Los Angeles, CA 213-670-2833
 F & F Metro, Great Neck, NY 516-482-4080
 Enclosure Solutions Inc., Bensenville, IL 708-766-
 3667

Instrument Dynamics Inc., Wakefield, MA 617-
 245-5100
 Kemp Instruments, Addison, TX 214-931-7100
 Doug Warren, Newport News, VA 804-930-3217
 PRODUCTS: computer consoles, consoles,
 electronic racks, enclosure systems, custom
 cabinets and consoles, equipment cabinets and
 enclosures, furniture systems, instrumental
 cabinets, panels, rack fans, shelves, rack-mounts,
 slides

Anvil Cases (subsidi. of Zero Corp.)

15650 Salt Lake Avenue
 City of Indust., CA 91745-1114
 (818) 968-4100 (800) 359-2684 FAX: (818) 968-1703
 General Manager: Lou Leto; Group Vice
 President: Dan Molloy; Marketing Manager:
 Gabe Nakash; Sales Manager: Whit Adams
 Nova Marketing, San Francisco, CA 415-952-0943
 PRODUCTS: ATA cases and racks, flight cases,
 shock-mount racks and cases, storage racks and
 cases, tool cases

ATLAS/SOUNDOLIER

1859 Intertech Dr.
 Fenton, MO 63026
 (314) 349-3110 (800) 876-7337 FAX: (314) 349-1251
 VP/Marketing & Sales: Charles Cushman;
 VP/Marketing Consultant: Herbert M. Jaffe;
 National Sales Manager: Bud Waters; Eastern
 Sales Manager: Tony Satariano; Western Sales

Manager: Jeff Garstick; OEM Sales Manager: Larry Damato
 Precide, Morbio Inferiore, Switzerland, 914-31734
 PRODUCTS: accessories, consoles, electronic racks, enclosure systems, custom cabinets and consoles, equipment cabinets and enclosures, hardware, panels, rack AC power, rack fans, rack hardware, shelves, rack-mounts, stands, storage racks and cases

BJM Electronics Ltd.

2589 Richmond Terrace
 Staten Island, NY 10303
 (718) 442-0223 FAX: (718) 442-1451
 President: Robert Manzo; Sales Manager: Jeff Salitel; Purchasing: Jason Manzo
 Precide, Morbio Inferiore, Switzerland, 914-31734
 PRODUCTS: accessories, ATA cases and racks, chassis, computer consoles, electronic racks, equipment cabinets and enclosures, flight cases, hardware, panels, rack AC power, rack fans, rack hardware, tool cases

Black Audio Devices

P.O. Box 106
 Ventura, CA 93002
 (805) 653-5557
 President: Bruce Black
 Nova Marketing, San Francisco, CA 415-952-0943
 PRODUCTS: hardware, panels, rack hardware

Bobadilla Cases

2302 E. 38th St.
 Los Angeles, CA 90058-9990
 (213) 589-5214 FAX: (213) 589-5268
 J.B. Parent, Dublin, OH 614-764-0064

Bretford Manufacturing

9715 Soreng Avenue
 Schiller Park, IL 60176
 (708) 678-2545 FAX: (800) 343-1779
 President: Ed Petrick; Vice President: Dave Petrick; Director of Sales & Mkt'g: Bob Redding
 Nova Marketing, San Francisco, CA 415-952-0943

Bud Industries, Inc.

4605 E. 355th St.
 Willoughby, OH 44094
 (216) 946-3200 FAX: (216) 951-4015
 President/ C.E.O: A.N. Haas; Vice President Marketing: Blair Haas; National Sales Manager: Bill DeRoche; Inside Tech/Adm Manager, East: Ed Cunningham; Inside Tech/Adm Manager, West: Jenene Koegele
 Nova Marketing, San Francisco, CA 415-952-0943
 PRODUCTS: accessories, chassis, computer consoles, consoles, electronic racks, enclosure systems, custom cabinets and consoles, equipment cabinets and enclosures, hardware, instrumental cabinets, modular boxes, molded racks and cases, panels, rack fans, rack hardware, shelves, rack-mounts, slides

Cabtron Systems

200 Anets Dr.
 Northbrook, IL 60062
 (708) 498-6090 FAX: (708) 272-1095

Calzone Case

225 Black Rock Ave.
 Bridgeport, CT 06605
 (203) 367-5766 FAX: (203) 336-4406

Caseworks of Chicago

3050 N. Western Ave.
 Chicago, IL 60618
 (312) 472-8111

CBM Metal

908 Niagara Falls Blvd.
 North Tonawanda, NY 14120-2060 (800) 387-4834
 FAX: (800) 565-2266
 Marketing Manager: Les Houle
 CBM Metal, Mississauga, ON 416-670-7471
 Taub Sales, Silver Springs, MD 301-662-9100

Chief Manufacturing Inc.

14310 Ewing Ave. S.
 Burnsville, MN 55337
 (612) 894-6280 FAX: (612) 894-6918
 Doug Warren, Newport News, VA 804-930-3217

Diversified Case Company, Inc

Ellis Avenue
 Whitesboro, NY 13492
 (315) 736-3028 FAX: (315) 736-2049
 President: John Fitzsimmons Sr.; Vice President/Treasurer: Michael Fitzsimmons;
 Sales Engineer: Robert Card

**Order More
 Blue Books
 Now!**

HOLD EVERYTHING!

Introducing the new
Series L50 Sectional Wall Mount Cabinet



Patents pending

- Concealed quick release slip-joint hinging system between front and back sections
- Concealed quick release spring loaded hinged front door for optional right or left hand mounting
- Structurally reinforced for maximum loading without cabinet distortion
- Deep recessed panel mounting space
- Universal EIA tapped hole spacing
- Five vertical panel heights
- Textured black enamel finish



3030 Laclede Station Road ■ St. Louis, Missouri 63143 USA
 (314) 781-9058 ■ (800) 325-9660 ■ FAX: (314) 645-4852

Factory representatives serving the USA and Canada

Circle 257 on Reader Response Card

Dukane Corp.

2900 Dukane Drive
St. Charles, IL 60174
(708) 584-2300 FAX: (708) 584-2370
President/C.E.O.: J. McWilliams Stone Jr.;
Pres./Comm. Systems Division: Steven L. Deppe;
National Sales Director: Warren T. Anderson;
Service Manager: Cliff Carlson
Wally Smutts, Toronto, ON 519-748-5352
Doug Fellabaum, Sycamore, IL 815-895-7573
Ken Lind, Boston, MA 617-235-6817
Pete Kendall, Jacksonville, FL 904-262-6025
Jim Lacey, Moreno Valley, CA 714-243-1160
Jack Brown, Dallas, TX 214-943-7528
Sanford Lange, Indianapolis, IN 317-251-3112
PRODUCTS: accessories, chassis, equipment
cabinets and enclosures

Electro Space Fabricators

P.O. Box 67
Topton, PA 19562-0067
(215) 682-7181 FAX: (215) 682-2133

Electrorack Products Co., Inc.

1443 S. Sunkist St.
Anahelm, CA 92806
(714) 776-5420 (800) 433-6745 FAX: (714) 776-9683
CEO: Wayne Rumbles; President: Yvonne
Rumbles; General Manager: Mike Deming;
Customer Service Manager: Bill Lenoir; Vice
President: Al Benson
Greg Dzuby & Assoc., Glendale, AZ 800-999-0006

Elkay Industries

2925 North Market St., St. Louis, MO 63106
(314) 535-1333 FAX: (314) 535-4118
CEO/ENG: Richard Hahn; President: Paul Grote;
Vice President, Sales: Martin Hahn; Engineering:
Jack Scilligo
Edwards Company, Inc., Livonia, MI 313-458-7777

Elma Electronic, Inc.

41440 Christy Street, San Jose, CA 95120
(415) 656-3400 FAX: (415) 656-3783
President: Fred Ruegg; Vice President, Sales:
Kris Holla; Product Manager: Troy Lauritsen
Elma, Plano, TX 214-964-1700
Elma, Ontario, CA 714-986-3753
Larry Schirmer, Pontiac, MI 313-340-9588
PRODUCTS: accessories, chassis, consoles,
electronic racks, enclosure systems, custom
cabinets and consoles, equipment cabinets and
enclosures, instrumental cabinets, modular
boxes, panels, rack fans, rack hardware, shelves,
rack-mounts, shock-mount racks and cases,
slides, specialty cases, stands, storage racks and
cases

Emcor Products/Crenio, Inc.

1600 Fourth Ave. NW, Rochester, MN 55901
(507) 289-3371 FAX: (507) 287-3405
Sales Manager: Dan Estes
PRODUCTS: accessories, computer consoles,
consoles, electronic racks, enclosure systems,
custom cabinets and consoles, equipment
cabinets and enclosures, hardware, instrumental
cabinets, panels, rack fans, rack hardware,
shelves, rack-mounts, slides

Equipot Electronics Corp.

351 Woodlawn Ave.
Aurora, IL 60506
(708) 897-4691 FAX: (708) 897-5314
Director of Sales & Mkt'g: Kent Jarnig
PRODUCTS: ATA cases and racks, chassis,
computer enclosures, consoles, electronic racks,
enclosure systems, custom cabinets and
consoles, furniture systems, instrumental
cabinets, rack fans, rack hardware, shelves, rack-
mounts, shock-mount racks and cases, slides

Flight Form Cases Inc.

5950 192nd St. NE
Arlington, WA 98223
(206) 435-6688 (800) 657-1199 FAX: (206) 435-5144
President: Dale J. Lorang; Vice President: Glenn
Stenson; Sales and Design: Don Cole;
Production Manager: Stefan Olsson
Bob Bryan Enterprises, Lake Worth, TX 817-237-
6039
Terry Ward, Tacoma, WA 206-759-9995
Frank Garlock, El Cajon, CA 800-748-5555
Rick Kylan, San Jose, CA 408-365-7374
Maurice Weinstein, Greensboro, NC 919-855-9117
PRODUCTS: ATA cases and racks, electronic racks,
flight cases, shock-mount racks and cases, soft
cases and bags, specialty cases, storage racks
and cases, tool cases

FOSTEX CORPORATION OF AMERICA

15431 Blackburn Ave.
Norwalk, CA 90650
(213) 921-1112 (800) 7-FOSTEX FAX: (213) 802-
1964
V.P. Marketing/ General Mgr.: Robert Veri; V.P.
Sales: Mark Cohen
J.B. Parent, Dublin, OH 614-764-0064
PRODUCTS: stands

Four Designs

6531 Gross Ave.
Canoga Park, CA 91307
(818) 882-2878

Gemini Inc.

103 Mensing Way
Cannon Falls, MN 55009
(507) 263-3957 (800) 533-3631 FAX: (507) 263-4887
Gemini Inc., Lenexa, KS 913-492-8267
Gemini Texas- Jim Brown, Taylor, TX 512-352-5207
Gemini Inc.- Dick Devellin, Plymouth Meeting, PA
215-825-6736
Gemini Inc.- Doug Pfau, Cannon Falls, MN 507-
263-3957
Gemini Inc.- Karen Watkins, Clarkston, GA 404-
299-3330
Greg Dzuby & Assoc., Glendale, AZ 800-999-0006
PRODUCTS: ATA cases and racks, equipment
cabinets and enclosures, flight cases,
instrumental cabinets, shock-mount racks and
cases, tool cases

General Devices Co., Inc.

1410 S. Post Road
P.O. Box 39100
Indianapolis, IN 46239-0100 (800) 626-9484 FAX:
(317) 898-2917
President: Maxwell S. Fall; Sales Manager: Jack
R. Bradford; Director of Marketing: Thomas A.
Clark
Greg Dzuby & Assoc., Glendale, AZ 800-999-0006

**TSI's Special Products Division will
design, machine, and engrave top quality
panels and wallplates in a fast and
efficient manner...**

**and you'll get all the credit and be able to
sleep nights too.**

Why not FINISH your systems?

Special Products Division is committed to the very finest custom panel and wallplate services for all audio, video and security needs.

TSI is responsive and our quality can't be beat! It's more than our CAD-driven computerized engraving. It's the keen, demanding craftsman's eye that makes the product what it is. Your result is shorter project duration, which equates to more projects completed in less time. As long as your orders are being booked, your PROFITABILITY is assured!

We work hard at making you look good!

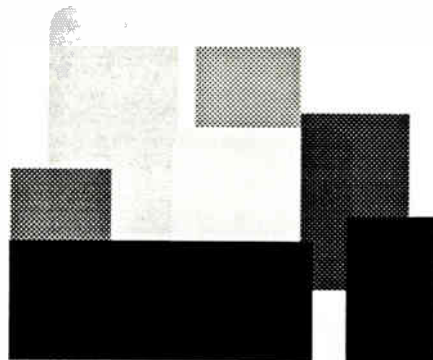

**For Fastest Service
1-800-628-2084**



Special Products Division
393 Jericho Turnpike, Mineola, NY 11501
(516) 294-5390 Fax (516) 294-5008

Circle 269 on Reader Response Card

GEPCO INTERNATIONAL INC.

2225 West Hubbard, Chicago, IL 60612
 (312) 733-9555 (800) 966-0069 FAX: (312) 733-6416
 President: Gary R. Geppert; Chief Financial
 Officer: David B. Mecklenburger; Assistant to the
 President: Larry Smith, Sr.; Sales Manager: Larry
 Smith, Jr.
 Gepco International Inc., Ocala, FL 904-368-1032
 John Anthony, Stamford, CT 203-322-9202
 PRODUCTS: accessories, equipment cabinets and
 enclosures

Grant Products d/b/a Pivotelli/USA

25 Commercial St, P.O. Box 560
 Medford, MA 02155
 (617) 391-4097 (800) 548-5040 FAX: (617) 391-7819
 Vice President: Robert G. Brennan, Jr.;
 Operations Mgr.: Sandra M. Lappin
 Dimension/ Point IX, Lewisville, TX 214-436-3706

H.O.M.E. Inc.

500 W. 9th Street, Hermann, MO 65041
 (314) 486-3111 FAX: (314) 486-5737
 President: Arthur P. Brigham; General Manager:
 Millard Cundiff; Inside Sales Coordinator:
 Carolyn LaBoube
 Multi-Technical Reps., Brainerd, MN 218-828-9483

Hammond Mfg.

1690 Walden Ave., Buffalo, NY 14225
 (716) 894-5710

Harnel Company

1600 Marshall S.E.
 Grand Rapids, MI 49507
 (616) 452-4522 FAX: (616) 452-5514
 ADCOM, Toronto, ON 416-251-3355

Heather Sound Amplification-HSA

121 Lincoln Way West
 Mishawaka, IN 46544
 (219) 255-6100 FAX: (219) 255-8131
 Owner: Richard Johnson; Sales Manager: Alan
 Oglesby
 Doug Warren, Newport News, VA 804-930-3217
 PRODUCTS: ATA cases and racks, consoles,
 enclosure systems, custom cabinets and
 consoles, furniture systems, specialty cases

HI Lo Fabrication & Manufacturing

P.O. Box 509 / CR 1105
 Rio Vista, TX 76093
 (817) 373-2247
 President: Cecil Caro; Production Engineer:
 Cecil Caro; Vice President, Sales: Bridget Caro
 ADCOM, Toronto, ON 416-251-3355
 PRODUCTS: accessories, enclosure systems,
 custom cabinets and consoles, equipment
 cabinets and enclosures, instrumental cabinets,
 molded racks and cases, panels, stands

House of Metal Enclosures

500 W. Ninth St.
 Hermann, MO 65041
 (314) 486-3111

Hybrid Cases

1121-20 Lincoln Avenue
 Holbrook, NY 11741
 (516) 563-1181 (800) 645-1707 FAX: (516) 563-1390
 Sales Manager: Bruce Papa; Marketing Manager:
 Charles Northington
 ADCOM, Toronto, ON 416-251-3355
 PRODUCTS: accessories, ATA cases and racks,
 electronic racks, flight cases, rack hardware,
 shock-mount racks and cases, soft cases and
 bags, specialty cases, storage racks and cases

**WE CAN SOLVE
 YOUR
 RACK MOUNTING
 PROBLEMS**

CUSTOM RACK SHELF



This system is a unique method that allows
 all consumer equipment to be rack-
 mounted in a unified fashion. Each face is
 custom cut to the individual equipment, for
 a perfect fit. Advanced manufacturing
 processes allow these custom mounts to be
 shipped within 48 hours.

- Brings unit up to standard rack size
- No unit modification needed
- Precise fit eliminates unsightly gaps
- Choice of finishes
- Cost effective

RACK STORAGE DRAWERS



Our family of storage drawers has features
 that nobody else offers:

- Fully enclosed top
- Full extension slides
- Attractive flush latch
- Smooth operation
- Brushed & anodized finish

**UNIVERSAL
 RACK SHELF**

Inexpensive method of rack mounting
 anything not rack mountable.
 One piece construction.



THE FINEST ACCESSORIES AVAILABLE

We specialize in accessories and we can deliver.
 Our line of rack mount accessories also includes: blank panels, vent panels, security
 covers, filter kits, rack rails, hardware and other items to dress up your installations.

middle atlantic products

P.O. Box 96 Haskell, NJ 07420 201-839-1011 FAX: 201-839-1976

Circle 242 on Reader Response Card



IGM Communications

4041 Home Rd.
Bellingham, WA 98226
(206) 733-4567 FAX: (206) 734-7939

Int'l Satellite Systems

104 Constitution Dr. #4
Menlo Park, CA 94025
(415) 853-0833 FAX: (415) 853-0908

J.W. DAVIS AND CO.

3030 Canton Street, Dallas, TX 75226
(214) 651-7341 (800) 527-5705 FAX: (214) 939-0328
President: Harvey Earp; Vice President, Sales:
Jack W. Tucker; Chief Engineer: Eric Simonson
Multi-Technical Reps., Brainerd, MN 218-828-9483
PRODUCTS: electronic racks

Jan-AI Cases

3339 Union Pacific Ave., Los Angeles, CA 90023
(213) 260-7212 (800) 73JAN AL FAX: (213) 260-4696
Director: Marketing & Design: Todd Morgan

Kalamazoo Technical Furniture Inc.

P.O. Box 1165
Kalamazoo, MI 49005 (800) 832-5227
President: Lawrence Draves; Sales Manager:
Bruce Smith; Systems Engineer: John Sweezy
Multi-Technical Reps., Brainerd, MN 218-828-9483
PRODUCTS: technical workbenches

KARIBU SOUND INDUSTRIES INC.

3500 Parkdale Avenue
Baltimore, MD 21211
(301) 383-2167 FAX: (301) 383-7573
President: Larry Kirchner
Taub Sales Inc., Silver Spring, MD 301-622-9100
Leslie's, Chicago, IL 708-697-6677
Kodo Associates Inc., Minneapolis, MN 612-881-1255
Vector Corp., Seattle, WA 206-368-1255
Multi-Technical Reps., Brainerd, MN 218-828-9483
PRODUCTS: ATA cases and racks, electronic racks, enclosure systems, custom cabinets and consoles, equipment cabinets and enclosures, furniture systems, shelves, rack-mounts

Knight Industries

90 Junius St.
Brooklyn, NY 11212
(718) 342-6400 FAX: (718) 485-8551

LM Engineering

660 W. Evergreen St.
Youngstown, OH 44511 (800) 874-8326

Magne-Tronics

93 Broad St.
Matawan, NJ 07747
(908) 566-9600 FAX: (908) 566-4304

PAR Metal Products/PAR Industrial

1220 Atlantic Ave.
Brooklyn, NY 11216
(718) 774-5900 FAX: (718) 774-0583
General Manager: Henry Fink
Camden Marketing, Pierre Fonds, QU 514-683-3377

Parsons Mfg. Corp.

1055 O'Brien Dr.
Menlo Park, CA 94025
Sales Manager: Steve Wurzer
Camden Marketing, Pierre Fonds, QU 514-683-3377
PRODUCTS: ATA cases and racks, molded racks and cases

PARTS EXPRESS INT'L INC.

340 E. First St.
Dayton, OH 45402
(513) 222-0173 (800) 338-0531 FAX: (513) 222-4644
President: Jeffrey Stahl; Sales Manager: Linda O'Brien; Purchasing Manager: Greg Herting; Advertising Manager: Larry Potter
Chuck Olson Assoc., Renton, WA 206-271-5416
PRODUCTS: accessories

PEAVEY ELECTRONICS CORP.

711 A Street
P.O. Box 2898
Meridian, MS 39301
(601) 483-5365 FAX: (601) 484-4278
CEO: Hartley Peavey; President: Mella Peavey
Dimension/ Point IX, Lewisville, TX 214-436-3706
PRODUCTS: accessories, consoles, electronic racks, enclosure systems, custom cabinets and consoles, equipment cabinets and enclosures, flight cases, hardware, Instrumental cabinets, modular boxes, molded racks and cases, portable tables, shelves, rack-mounts, soft cases and bags, specialty cases, stands, storage racks and cases

Peerless Sales Company

1980 Hawthorne
Melrose Park, IL 60160
(708) 865-8870 (800) 729-0307 FAX: (708) 865-2941
President: Walt Snodell; Director of Marketing:
Frank Briggs; Director of Sales: Bill Brock
Crescendo Associates, Hollywood, FL 305-922-9553
PRODUCTS: accessories, stands

Precision Fabrication Technologies

State Road 16
P.O. Box 716
Monon, IN 47959
(219) 253-6666 (800) 558-7297 FAX: (219) 253-6570
President: Joseph Rogers; Sales: Duane Nagel;
Engineering: Roger Hollar
Teqni-Rep, Sun Valley, CA 818-768-4223
Bob Burns Assoc., Cary, IL 708-516-3322
Rep One, Coigate, WI 414-628-4016
S.W. Marketing, Dallas, TX 214-341-8631
Ed King Assoc., Saratoga, CA 408-867-6350
Doug Warren, Newport News, VA 804-930-3217

Premier Metal Products Co.

381 Canal Place
Bronx, NY 10451
(212) 993-9200 FAX: (212) 993-9211
Division President: Stanley F. Kwasnicki; Sales
Manager: Anthony E. Bozza
Premier Metal Products Co., Fontana, CA 714-829-3089
Dimension/ Point IX, Lewisville, TX 214-436-3706

MAXIMUM STORAGE

SDR



RKV

Raxxess**The ultimate in storage . . .**

sturdy, fully enclosed sliding drawers in two or three space versions (lock optional), and the RAK-VAULT, 3 or 4 space units for secured storage of otherwise loose items (lock standard). More rack solutions from RAXXESS. CALL, FAX or WRITE for our full-line brochure.

P.O. Box 417, Riverside Station
Paterson, NJ 07544-0417
(201) 523-1425 • FAX (201) 523-1658

Circle 291 on Reader Response Card

**Middle Atlantic Products**

8 North Corporate Dr.
P.O. Box 29
Riverdale, NJ 07457
(201) 839-1011 FAX: (201) 839-1976
President: Bob Schluter; National Sales Mgr.:
Eric Demarest; National Director Operations:
Scott Mathews; Office Manager: Rosemarie
Curti; West Coast Operations Mgr.: Sean Felda
Middle Atlantic Rack Distr., Haskell, NJ 201-839-2714
Middle Atlantic Western Distr., Moorepark, CA
805-529-6104
Audio Etc., St. Peters, MO 314-278-4130
PRODUCTS: accessories, chassis, electronic racks,
enclosure systems, custom cabinets and
consoles, hardware, panels, rack hardware,
shelves, rack-mounts, storage racks and cases

Modulock Inc.

3960 Laurel Cyn. Blvd. #321
Studio City, CA 91614
(818) 905-9136 FAX: (818) 783-1578
President: Steven S. Leonard; Vice President of
Sales: George S. Tanous
Lineau Co., Columbia, MD 301-621-4113
Henry W. Phillips Co., Roswell, GA 404-992-3070
Reflex Marketing Co., Hempstead, NY 516-565-2323
Dick Bellow Sales Co., Dallas, TX 214-644-7881
Powerlines, Evanston, IL 708-864-1147
T.C. Marketing, Reseda, CA 818-776-8120
S-R Marketing, Mt. Liberty, OH 614-393-3868
Mike Thorpe, Lyons, CO 303-823-5101

Racware (Rackmounted Computers)

13773 N. Central Expressway, St
Dallas, TX 75243
(214) 690-8480 FAX: (214) 690-8503
Camden Marketing, Pierre Fonds, QU
514-683-3377

Rampart Cases, Inc.

Pine Run Industrial Park
4 Harmon Dr.
Chews Landing, NJ 08012
(609) 228-6550 FAX: (609) 228-4616
Audio Etc., St. Peters, MO 314-278-4130

Raxxess Metalsmiths

178 6th Avenue, Paterson, NJ 07524
(201) 523-1425
Owner: Hyman Peller; Sales Manager: Doug
Brown; Customer Service: George Goodwin;
Accounting: Joy Jezewic
On Line Marketing, Wadsworth, OH 216-336-7504
Ron Tunks Sales, Tamarack, FL 305-722-2803
JMS Marketing, Austin, TX 512-266-1113
StarIn Marketing, Chesterton, IN 219-929-4127
REM Products, Thousand Oaks, CA 805-379-4252
Doug Warren, Newport News, VA 804-930-3217
PRODUCTS: accessories, electronic racks,
equipment cabinets and enclosures, hardware,
panels, rack hardware, shelves, rack-mounts,
storage racks and cases

RCI Systems, Inc.

5615 Fishers Lane, Rockville, MD 20852
(301) 984-1800 (800) 765-4RCI FAX: (301) 984-6175
President: Jay W. Kingery; East Coast Audio Rep.:
Brian K. Gross; Midwest Audio Rep.: Gordon
Jacobs; West Coast Audio Rep.: Doug Macuch;
Midwest Fact. Rep.: Total Mktg: David Taylor; Mid-
Atlantic Fact. Rep.: Taub: Steve Taub
Sunrise Sales Company, LaMolle, IL 815-638-2660
PRODUCTS: furniture systems, shelves, rack-
mounts

Roadrunner Cases Inc.

447 E. Gardena Blvd., Gardena, CA 90249
(213) 770-4444 FAX: (213) 538-9560
President: Howard Chatt; Vice President:
Carolyn Nieto
Camden Marketing, Pierre Fonds, QU 514-683-
3377

Schroff Inc.

170 Commerce Drive
Warwick, RI 02886
(401) 732-3770 FAX: (401) 738-7988
Vice Pres./Managing Director: Udo Schroff,
Director of Mktg./Sales: Fred Duquette; National
Sales Manager: Bill Bottis; Technical Manager:
Elke Waitz
Schroff Inc., Anaheim, CA 714-777-5795
Sunrise Sales Company, LaMolle, IL 815-638-2660

Seeburg Music Satellite Network

5706 New Chapel Hill Rd.
Raleigh, NC 27607
(919) 851-5823
Camden Marketing, Pierre Fonds, QU 514-683-
3377

SESCOM, INC.

2100 Ward Drive
Henderson, NV 89015
(702) 565-3400 (800) 634-3457 FAX: (702) 565-4828
President: Franklin J. Miller; Vice President:
Brenda Miller
Cambridge Marketing, Westerville, OH 614-363-
9191
PRODUCTS: chassis, equipment cabinets and
enclosures

Sight & Sound Entertainment

1751 Dexter Ave. N
Seattle, WA 98019
(206) 775-9888 FAX: (206) 286-1961
Camden Marketing, Pierre Fonds, QU
514-683-3377

Sound Designers Studio

424 West 45th Street
New York, NY 10036-3565
(212) 759-5679 FAX: (212) 265-1250
President: Richard Fitzgerald; Vice President:
Peter Fitzgerald; Designer: Bernard Fox;
Manager: Gene Perla
Western Audio Sales, Burbank, CA 818-954-9300
Metropolis Audio Marketing, Edison, NJ 201-225-
0085
R.J. Marketing Ltd., Rockville, MD 301-251-0330
S.C. Music, Cambridge, MA 617-876-9870
Audio Resources, Westmont, IL 708-655-1180
Preclde, Morbio Inferiore, Switzerland, 914-31734
PRODUCTS: accessories, ATA cases and racks,
chassis, computer consoles, consoles, electronic
racks, enclosure systems, custom cabinets and
consoles, equipment cabinets and enclosures,
flight cases, furniture systems, hardware,
instrumental cabinets, modular boxes, molded
racks and cases, panels, portable tables, rack AC
power, rack fans, rack hardware, shelves, rack-
mounts, shock-mount racks and cases, slides,
soft cases and bags, specialty cases, stands,
storage racks and cases, tables, technical
workbenches, tool cases

Star Case Manufacturing Co., Inc.

648 Superior Ave.
Munster, IN 46321
(219) 922-4440 (800) 822-STAR FAX: (219) 922-
4442
President: Dennis R. Toma; Vice Pres. Sales &
Marketing: Ralph G. Hoopes
Star Case Mfg. Co. Sis & Mktg., Long Beach, CA
213-426-1286
Camden Marketing, Pierre Fonds, QU 514-683-3377
PRODUCTS: accessories, ATA cases and racks,
electronic racks, enclosure systems, custom
cabinets and consoles, equipment cabinets and
enclosures, flight cases, furniture systems,
hardware, modular boxes, molded racks and
cases, panels, portable tables, rack AC power,
rack fans, shock-mount racks and cases, storage
racks and cases, tables, technical workbenches,
tool cases

TA Instrument Case

4625 Alger St., Dept. EE
Los Angeles, CA 90039
(818) 242-8855 FAX: (818) 841-5618
Camden Marketing, Pierre Fonds, QU 514-683-
3377

Teclab

310 Perkstok Rd.
Kalamazoo, MI 49001 (800) 832-5227 FAX: (616)
372-6116
Camden Marketing, Pierre Fonds, QU 514-683-
3377

Thermodyne International Ltd.

20850 S. Alameda St.
Long Beach, CA 90810
(213) 603-1976 FAX: (213) 603-1929
Vice President: Gary S. Ackerman
JMS Marketing, Austin, TX 512-266-1113
PRODUCTS: ATA cases and racks, flight cases,
molded racks and cases, shock-mount racks and
cases, slides, storage racks and cases, tool cases

Ultimate Support Systems, Inc.

2406 Zurich Drive
Fort Collins, CO 80524
(303) 493-4488 FAX: (303) 221-2274
President: James A. Dismore; Domestic Sales
Manager: Daniel S. Tancik; International Sales
Manager: Buck Hammond; OEM/Retail Sales
Manager: Mel Blankenship; Marketing Services
Manager: Joanne Monath
Cambridge Marketing, Westerville, OH 614-363-
9191
PRODUCTS: accessories, stands

Underwater Kinetics

1020 Linda Vista Dr.
San Marcos, CA 92069
(619) 744-7560 (800) 852-7483 FAX: (619) 744-7320
Sales Manager: Greg Sipple; Industrial
Marketing: Bryan Pruett
Sound Sales, Inc., Columbia, MD 301-964-1170
PRODUCTS: ATA cases and racks, equipment
cabinets and enclosures, instrumental cabinets,
modular boxes, molded racks and cases, panels,
shock-mount racks and cases, soft cases and
bags, specialty cases, storage racks and cases,
tool cases

Vaco Products

7200 McCormick Blvd.
Chicago, IL 60645
(312) 588-6821 FAX: (312) 677-4476
Camden Marketing, Pierre Fonds, QU 514-683-
3377

Viking Cases

10480 Oak St. NE
St. Petersburg, FL 33716
(813) 577-1216 (800) 237-8560 FAX: (813) 577-2082
President: Arthur W. Stemler; Vice President:
Bruce S. Stemler; Vice President: William W.
Strickland; Sales: Joe loco
PRODUCTS: ATA cases and racks, flight cases,
shock-mount racks and cases, tool cases

Wenger Corp.

555 Park Drive
Owatonna, MN 55060
(507) 455-4100 FAX: (507) 455-1011
Advertising/Convention Coord.: Dianne Sorenson
Audio Etc., St. Peters, MO 314-278-4130

William Bal Corp.

947 Newark Ave.
P.O. Box 875
Elizabeth, NJ 07208
(908) 354-9625 FAX: (908) 354-4961
President: Greg Wilson; Sales Manager: Scott
Trupp
J.B. Parent, Dublin, OH 614-764-0064
PRODUCTS: ATA cases and racks, molded racks
and cases, specialty cases, tool cases

Winsted Corp.

10901 Hampshire Avenue S.
Minneapolis, MN 55438
(612) 944-8556 (800) 447-2257 FAX: (612) 944-1544
Sales: Randy Smith; Sales: Judy Ruzek
MJA Marketing, St. Charles, MO 314-447-7111
PRODUCTS: consoles, electronic racks, enclosure
systems, custom cabinets and consoles,
equipment cabinets and enclosures

Wyle-Electronic Enclosures

6995 Airport Highway Lane
Pennsauken, NJ 08109
(609) 665-6810 FAX: (609) 665-7261
MJA Marketing, St. Charles, MO 314-447-7111

Zero Stantron

777 Front St., Burbank, CA 91502
 (818) 841-1825 (800) 821-0019 FAX: (818) 841-8892
 Sales Administrator: Monica Crowder; Sales
 Administrator: Chrissy Thede; Product Sales
 Manager: Jose Gomez; National Sales Manager:
 Brenda Sablin; Vice President, Sales: Guy A.
 Tessler; Advertising Coordinator: Martha
 Pistone
 Brenda Sablin, Deerfield, IL 708-215-1500
 Chuck Olson Assoc., Renton, WA 206-271-5416
 PRODUCTS: accessories, ATA cases and racks,
 chassis, computer consoles, consoles, electronic
 racks, enclosure systems, custom cabinets and
 consoles, equipment cabinets and enclosures,
 furniture systems, hardware, instrumental
 cabinets, panels, rack fans, shelves, rack-mounts,
 slides, tables, technical workbenches

**Advanced Video Assoc.**

400 Walnut St., Ste. 101
 Redwood City, CA 94063
 (415) 792-8684 FAX: (415) 791-0271
 J.B. Parent, Dublin, OH 614-764-0064

Alphone Corp.

1700 130th Ave. NE
 Bellevue, WA 98005
 (206) 455-0510 FAX: (206) 455-0071
 President: Jun Matsumoto; Vice President,
 Marketing: Harry Quanz; Vice President, Sales:
 Jim Morrison; Residential Sales Manager:
 Stephen Birgh; Commercial Sales Manager: John
 Mosebar
 Alphone East Coast Reg. Office, Rochelle Park, NJ
 201-843-6115
 Precide, Morbio Inferiore, Switzerland, 914-
 31734
 PRODUCTS: cameras, monitors, pan/tilts,
 surveillance

Alaun Engineering

2305 Florencita Drive
 Montrose, CA 91020
 (818) 957-0618 FAX: (818) 957-0618
 Owner/Manager: Al Braun; Marketing: M.E.
 Antonlak; Sales: Sharon Charles
 Edwards Company, Inc., Livonia, MI 313-458-7777

American Dynamics

10 Corporate Drive
 Orangeburg, NY 10962
 (914) 365-1000
 Vice President, Marketing: Vic Houk; Sales
 Manager: Joe McDevitt; Vice President,
 Engineering: Tom Ray; Manager, Applications:
 Tom Dorrill; C.E.O.: Rudy Schwerdt
 Seevid Inc., Huntington Bch., CA 714-898-6100
 Thomas Corr & Assoc., Hauppauge, NY 516-265-
 1330
 Keith Parker & Assoc., Northbrook, IL 708-498-
 0353
 Cartwright & Bean, Atlanta, GA 404-368-0160
 LMS Marketing, Reynoldsburg, OH 614-575-2000
 Greg Dzubay & Assoc., Glendale, AZ 800-999-0006
 PRODUCTS: accessories, computer interfaces,
 effects generators, message generators,
 multiplexers, remote controls, signal
 distribution, specialty cameras

American Laser Systems, Inc.

P.O. Box 6944
 Santa Barbara, CA 93160
 (805) 967-0423 FAX: (805) 683-4382
 President: Jackie Parker; Technician: Jim
 Lewison
 RAM Broadcast Systems, Barrington, IL 800-779-
 7575
 Video Media, Sunnyvale, CA 408-745-1700
 Winchester Electronic Sales, Atlanta, GA 404-392-
 0200
 Master Marketing Assoc., Woodbridge, VA 703-
 590-5678
 Quad-Tech Inc., Mission, KS 913-677-1013

American Lightwave Systems

999 Research Parkway, Meriden, CT 06450
 (203) 630-5770
 President & CEO: Dr. F.M. Mesliya; VP, Sales &
 Marketing: John Holobinko
 Nova Marketing, San Francisco, CA 415-952-0943
 PRODUCTS: fiber optics, transmission systems

AMX Corporation

12056 Forestgate Drive, Dallas, TX 75243
 (214) 644-3048 (800) 222-0193 FAX: (214) 907-2053
 President: Scott Miller; Vice President of Sales:
 William V. Anderson; Executive Vice President:
 Art Chace; International Sales Manager: Ken
 Sclater; Director of Marketing: Eric Johansen
 Franklin Communications, Maple Glen, PA 215-
 643-3031
 Visitech Marketing Assoc., Elburn, IL 708-365-9600
 KBZ Communications, Furlong, PA 215-348-9481
 Westech Marketing, Culver City, CA 213-870-9286
 Total Marketing, Ft. Worth, TX 817-560-3970
 Karp Communications, Tampa, FL 813-960-7667
 Richard Krudop, Andalusia, AL 205-222-8950
 Pancor Marketing, Lynnwood, WA 206-771-6016
 PRODUCTS: remote controls

Audio/Video Supply, Inc.

4575 Ruffner Street, San Diego, CA 92111
 (619) 565-1101 (800) 284-2288 FAX: (619) 565-7845
 President: R.T. Moore, Jr.
 J.B. Parent, Dublin, OH 614-764-0064
 PRODUCTS: cameras, dummy cameras,
 enclosures, lenses, monitors, pan/tilts, specialty
 cameras, surveillance, switchers, time-lapse
 recorders, transmission systems, video
 projectors, VTR's

Blonder-Tongue Laboratories, Inc.

1 Jake Brown Rd., Old Bridge, NJ 08857
 (908) 679-4000 FAX: (908) 679-4353
 President: James A. Luksch; Senior V.P.
 Marketing: Robert J. Palle; Senior Vice
 President: Daniel J. Altieri; Controller: Peter
 Puglilelli; Manager, Systems Engineering: Fred
 Canzano; Manager, Engineering: Kant Mistry
 Ed Currier, Cincinnati, OH 513-931-0324
 Chuck Fitzer, Fair Oaks, CA 916-863-0452
 LCA Sales, Tuckahoe, NY 914-961-4700
 Adams Assoc., Greensboro, NC 919-272-6838
 Shamrock Electronics, Dayton, OH 513-258-1227
 J.B. Parent, Dublin, OH 614-764-0064

C-Cor/Comlux, Inc.

453 Ravendale Drive, Suite F
 Mountain View, CA 94043
 (415) 964-9628 FAX: (415) 964-0968
 President: Robert F. Farris; Director, Marketing
 & Sales: H. Kenneth Regnier; Director,
 Engineering: Joseph D. Hawkins; Manufacturing
 Manager: Arthur J. Beatty
 M.S.C. Electronics Ltd., Richmond Hill, ON
 416-731-9500
 C-COR Electronics Inc., State College, PA
 814-238-2461
 Edwards Company, Inc., Livonia, MI 313-458-7777
 PRODUCTS: fiber optics, transmission systems

Carol Products Co. Inc.

1750 Brielle Avenue, Ocean, NJ 07712
 (201) 918-0800 (800) 922-2765 FAX: (201) 918-9051
 President: David Hersh; Vice President: Carol Hersh
 Taub Sales, Silver Springs, MD 301-662-9100
 PRODUCTS: accessories, cameras, computer
 interfaces, dummy cameras, enclosures, fiber
 optics, hardware, lenses, monitors, multiplexers,
 pan/tilts, remote controls, specialty cameras,
 surveillance, switchers, time-lapse recorders,
 transmission systems, video projectors, VTR's

**Gilderfluke & Co.**

820 Thompson Avenue #35
 Glendale, CA 91201
 (818) 546-1618 FAX: (818) 546-1619
 Owner: Doug Mobley; Marketing: Denise
 Dougherty
 Greg Dzubay & Assoc., Glendale, AZ 800-999-0006
 PRODUCTS: analog & digital tones for time and
 signaling, music playback-type

Maas-Rowe Carillons, Inc.

2255 Meyers Avenue
 Escondido, CA 92029
 (619) 743-1311 (800) 854-2025 FAX: (619) 747-2677
 President: Paul W. Rowe; Vice President: Elaine
 C. Rowe; Sales Manager: Craig Johnson;
 Customer Service: Pamela Jones; Plant Manager:
 Tony DeOliver
 Cambridge Marketing, Westerville, OH 614-363-
 9191

Schulmerich Carillons, Inc.

Carillon Hill
 Sellersville, PA 18960
 (215) 257-2771 FAX: (215) 257-1910
 Sales Contract Manager: Bill Wilson
 Cambridge Marketing, Westerville, OH 614-363-
 9191

**Subscribe to
 Sound &
 Communications
 Magazine**

Panasonic Gives You More Time To Play.

Panasonic® incorporates technological advances and a unique combination of feature benefits in every Time Lapse Recorder. They exemplify Panasonic's leadership role in providing the market with product excellence. After all, the longer you can count on your Time Lapse Recorder, the more time you'll have to play.

With a unique IQ Mechanism that features direct drive brushless motors for each reel and a direct drive cylinder motor. The number of moving parts is reduced by over 40% from previous models. The result is higher reliability and serviceability. A built-in head cleaner guarantees optimum operation and longevity of your tape

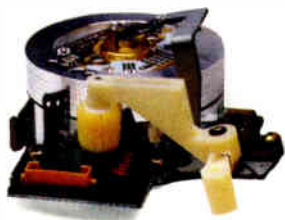
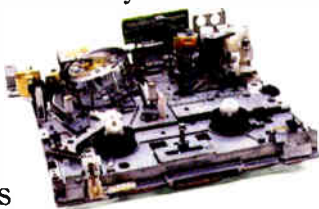

heads and maximizes tape performance. Panasonic Time Lapse Recorders incorporate special GT4W video heads that play back every adjacent field. So you can play back all the information that has been recorded.



For more demanding security applications, the Panasonic AG-6750 incorporates an RS-232C computer interface. So your Time Lapse Recorder can be controlled by computer. You can interface single or multiple units with your security system's master controller.



The Panasonic AG-6750 and AG-6720A feature the high resolution SVHS format to achieve maximum picture detail. There's also the VHS format AG-6030 which is quickly earning the reputation as the mainstay of the industry.

There's no time to play when it comes to your security system. Panasonic gives you outstanding quality built into every product.



For more information and your nearest dealer, call: NE (201) 348-7303, MW (708) 640-5168, SE (404) 717-6835, SW (817) 685-1117, W (714) 373-7265.

Panasonic
Closed Circuit Video Equipment

Catel Telecommunications, Inc.

4050 Technology Place, Fremont, CA 94537
 (415) 659-8988 (800) 827-2722 FAX: (415) 651-8437
 President & C.E.O.: Robert Montgomery; Vice
 President, Sis. & Mkt'g: James F. Caldwell;
 Regional Sales Manager: Albert Zopp; Regional
 Sales Manager: Larry Lindner
 Greg Dzubay & Assoc., Glendale, AZ 800-999-0006
 PRODUCTS: fiber optics, modulators, signal
 distribution, transmission systems

CCTV Corporation

315 Hudson Street, New York, NY 10013
 (212) 989-4433 (800) 221-2240 FAX: (212) 463-9758
 President: Steve Lefkowitz; Sales Manager: Gary
 Perlin; Export Manager: Syd Ranzman
 Loomis and Associates, Fremont, CA 415-683-0883

Channel Master, Div. of Avnet

Industrial Pk Dr.
 Smithville, NC 27577
 (919) 934-9711

Channelmatic, Inc.

821 Tavern Road, Alpine, CA 91901
 (619) 445-2691 (800) 766-7171 FAX: (619) 445-3293
 President: Dave Castellini; Executive Vice
 President: Rick Rager; Vice President of Sales:
 Michael Watson; V.P. of Business Development:
 Thomas Walsh; Controller: Paul Blevins
 Kent Liday, Ontario, CA 714-395-8540
 Roger Heidenreich, Merrimac, WI 608-643-2445
 Rick DuBapau, Austin, TX 512-343-0533
 Dan Viles, Red Hook, NY 914-758-2680
 Edwards Company, Inc., Livonia, MI 313-458-7777

Cohu Inc. Electronics Division

5755 Kearny Villa Road, San Diego, CA 92123
 (619) 277-6700 FAX: (619) 277-0221
 President: James M. Brown; Marketing Manager:
 John R. Foster; National Sales Manager:
 R. Jeffrey Tyler; International Sales Manager:
 Vijay Rana; Marketing Communications Mgr:
 Frederick Holmshaw
 Cohu - Northern California, Danville, CA
 415-743-1456
 Cohu - Northeast, Binghamton, NY 607-775-4437
 Cohu - Southeast, Duluth, GA 404-279-1190
 Cohu - Los Angeles, Laguna Hills, CA 714-768-8585
 Edwards Company, Inc., Livonia, MI 313-458-7777

Compression Labs, Inc. (CLI)

2860 Junction Ave., San Jose, CA 95134
 (408) 435-3000 (800) 538-7542 FAX: (408) 922-5429
 President: John Tyson; Executive V.P., Sis. &
 Mkt'g: John Walsh; Vice President,
 Sales: Ted Augustine
 Gary Kemp, San Jose, CA 408-435-3000
 Ed Scott, Liberty Corner, NJ 908-580-0818
 Jim Padalino, Dallas, TX 214-746-4888
 Ed Somerville, Reston, VA 703-438-8260

Conquest Sound, Inc.

26113 S. Ridgeland Ave.
 P.O. Box 268, Monee, IL 60449
 (708) 534-0390 (800) 323-7671 FAX: (708) 534-0398
 President: Bob Jares Jr.; Vice President: Larry
 Spalla; General Manager: Janet Jares;
 Operations Manager: Deborah Hawtree; Sales:
 Ed Knecht; Sales: Sally Artman
 Gary Castelluccio & Assoc., Clifton, NJ 800-888-1899
 AMH Sales, Inc., Torrance, CA 213-373-2034
 RS Enterprises, Redmond, WA 206-883-1482
 Midwest Audio Marketing, Crete, IL 708-672-3056
 AMH Sales, Northglenn, CO 303-465-5967
 C.L. Pugh & Associates, Cleveland, OH 216-238-
 1777
 PRODUCTS: accessories

Crest Electronics Inc.

4921 Exposition Boulevard, Los Angeles, CA 90016
 (213) 731-1105 (800) 234-0119 FAX: (213) 731-1417
 Chairman and C.E.O.: Irv Rossman; President:
 Dennis Castell; Senior Vice President: Hope
 Borows; Secretary: Valerie Castell; Comptroller:
 David Castell
 Crest East, Greensboro, NC 800-873-2121
 Irv Brown, Brooklyn, NY 718-493-1379
 Henry Phillips, Atlanta, GA 404-992-3070
 Pacnor Rep, Seattle, WA 206-771-6016
 Meyer Ross & Fleming, San Francisco, CA
 415-348-6800
 Taub Sales, Silver Springs, MD 301-662-9100

Diamond Electronics

P.O. Box 200
 Lancaster, OH 43130
 (614) 756-9222 FAX: (614) 756-4237

Ecler/TEI Electronics

570 W. 18 Street
 P.O. Box 246, Hialeah, FL 33010
 (305) 888-3980 (800) 327-8811 FAX: (305) 885-4950
 President: Danny Alonso; Vice President: Mireya
 A. Muniz; National Sales Manager: Walter
 McNulty; Sales: Orlando Pineda; Sales: Jose
 Hurcades; Customer Service: John Tembras
 Greg Dzubay & Assoc., Glendale, AZ 800-999-0006
 PRODUCTS: signal distribution, video mixers

Elbex America (NY) Inc.

300 Corporate Drive, Suffern, NY 10913
 (914) 353-0600 (800) 343-5239 FAX: (914) 353-0657
 President: David Elberbaum; Sales Manager:
 Christopher LoCascio; General Manager: Lorraine
 Furcayg; Technical Support: Jose Padilla
 Elbex CA, Carson, CA 800-421-5206
 Professional Electric Sales, Yonkers, NY 914-779-
 6118
 Marty Hanson Associates, Baltimore, MD 301-665-
 0330
 Frank Associates, Sudbury, MA 508-443-5131
 Edwards Company, Inc., Livonia, MI 313-458-7777

Elmo Manufacturing Corporation

70 New Hyde Park Road
 New Hyde Park, NY 11040
 (516) 775-3200 (800) 654-7628 FAX: (516) 775-3297
 Sales Manager: Vincent J. Giovinco; Sales
 Engineer: Keith Isogal; President: Y. Amemiya;
 Executive Vice President: Vincent G. Marotti
 Elmo Manufacturing Corp., Chatsworth, CA 818-
 346-4500
 Greg Dzubay & Assoc., Glendale, AZ 800-999-0006
 PRODUCTS: cameras, lenses, monitors, specialty
 cameras, surveillance

EMI

13327 Paxton St, Pacolma, CA 91331
 (818) 896-6700 (800) 628-5858 FAX: (818) 899-1599
 President: Gary Rutberg; Vice President, Sales:
 Michael Moli; Director of Marketing: Jeffrey
 Shifman; Sales Manager: Ted Lewis; Sales
 Administration: Pat Torres
 Sound Sales, Inc., Columbia, MD 301-964-1170
 PRODUCTS: enclosures

ESE

142 Sierra Street
 El Segundo, CA 90245
 (213) 322-2136 FAX: (213) 322-8127
 President: Jerry Johnson; Vice President/Sales
 Manager: Bob Mayers; Marketing Manager:
 Brian Way; General Manager: Bill Kaiser
 Cambridge Marketing, Westerville, OH 614-363-9191
 PRODUCTS: accessories, signal distribution,
 switchers

Fiber Options

80 Orville Drive, Ste. 102
 Bohemia, NY 11716
 (516) 567-8320 (800) 342-3748 FAX: (516) 567-8322
 CEO: Bob De Lla; Vice President: Clyde Smith;
 Vice President: Jack Fitzsimmons; Sales
 Manager: Rita Edrich
 F.M. Valenti, Nahant, MA 617-592-5300
 Thaw Sales & Marketing, So. Plainfield, NJ 201-
 757-8150
 Intermountain Marketing, Castle Rock, CO 303-
 688-5507
 Marketing Specialists, Simi Valley, CA 805-582-
 0666
 Universal Technologies S.A., Waure, Belgium,
 321-0-242520
 PRODUCTS: fiber optics

Gaslight Video

630 N. Tustin St., Suite 1516
 Orange, CA 92667
 (714) 744-4190 FAX: (714) 744-1729
 President: Jim Fletcher
 Save On Video, No. Hollywood, CA 818-982-2108
 Scott Agency, Kalspell, MT 406-755-0099
 Interactive Media, Vero Beach, FL 305-567-0831
 Silc Communications, Park Forest, IL 312-748-
 5195
 William Howze, Houston, TX 713-521-3214
 Greg Dzubay & Assoc., Glendale, AZ 800-999-0006

GYR, A DIVISION OF ODETICS

1515 South Manchester Avenue
 Anahiem, CA 92802
 (714) 772-1000 (800) 854-6853 FAX: (714) 776-6363
 Director of Marketing & Sales: Thomas S.
 Pappageorge; Sales Manager: Domenic Isola;
 Field Sales Manager: Jim Hawver; Field Sales
 Manager: Steve Wilber
 John Anthony, Stamford, CT 203-322-9202

Harman Elec. Inc./JBL Video Products

8400 Balboa Boulevard
 Northridge, CA 91325
 (818) 895-8734 FAX: (818) 891-5475
 Vice Pres Market Development: Michael Heiss;
 Marketing Manager: John Wilson; Manager,
 Product Development: Walter Henry; Service
 Manager: Ed Turner
 ADCOM, Toronto, ON 416-251-3355
 PRODUCTS: video projectors

Hirschmann of America

Industrial Row
 Riverdale, NJ 07457
 (201) 835-5002

Hitachi Denshi America, Ltd.

150 Crossways Park Drive
 Woodbury, NY 11797
 (516) 921-7200 FAX: (516) 921-0993
 President: A. Kobayashi; Vice President: B.
 Munzelle; General Manager: M. Matsuhashi;
 National Sales Manager: F. Posner
 Hitachi, Atlanta, GA 404-451-9453
 Hitachi, Chicago, IL 708-250-8050
 Hitachi, Dallas, TX 214-891-6381
 Hitachi, Los Angeles, CA 213-328-6116
 ADCOM, Toronto, ON 416-251-3355

Ikegami Electronics (USA), Inc.

37 Brook Ave.
 Maywood, NJ 07607
 (201) 368-9171 FAX: (201) 569-1626
 National Sales/Marketing Mgr: Aaron Chesler;
 National Accounts Manager: Kyle Robinson;

Sales Representative: Charles McCready
Ikegami Electronics, Elmhurst, IL 708-834-9774
Ikegami Electronics, Torrance, CA 213-534-0500
PRODUCTS: accessories, cameras, enclosures, hardware, lenses, monitors, pan/tilts, remote controls, signal distribution, specialty cameras

Intec Video Systems

23301 Vista Grande
Laguna Hills, CA 92653
(714) 859-3800

International Logistics Systems Inc

295 Cortlandt Street
P.O. Box 25
Belleville, NJ 07109
(201) 759-0007 FAX: (201) 759-8989
President: Carmine O. Pellosie; **Vice President:** Dar Hyatt
ADCOM, Toronto, ON 416-251-3355
PRODUCTS: dummy cameras, lenses, monitors, pan/tilts, remote controls, signal distribution

J.W. DAVIS AND CO.

3030 Canton Street
Dallas, TX 75226
(214) 651-7341 (800) 527-5705 FAX: (214) 939-0328
President: Harvey Earp; **Vice President, Sales:** Jack W. Tucker; **Chief Engineer:** Eric Simonson
Multi-Technical Reps., Brainerd, MN 218-828-9483
PRODUCTS: accessories, cameras, lenses, monitors, pan/tilts, remote controls, surveillance, switchers, time-lapse recorders

Javelin Electronics div. Atapco

19831 Magellan Dr.
Torrance, CA 90502
(213) 327-7440 (800) 421-2716 FAX: (213) 327-5405
President: Graham Wallis; **Vice President, Engineering:** Ray Payne; **Controller:** Terry Muldowney; **Operations Management:** Mike Burton; **Marketing Services Manager:** Mary Perry
C.B. Electronic Marketing, Arvada, CO 303-422-0561

JVC Professional Products Co.

41 Slater Dr.
Elmwood Park, NJ 07407
(201) 794-3900 (800) 526-5308 FAX: (201) 523-2077
National Sales Manager: Lee Manning; **Western Regional Manager:** Eric Mac Rae
JVC Professional Products Co., Pine Brook, NJ 201-882-0900
JVC Professional Products Co., Elk Grove VII., IL 708-364-9300
JVC Professional Products Co., Cypress, CA 714-527-7500
PRODUCTS: cameras, monitors, surveillance, switchers, time-lapse recorders, VTR's

Koyo Int'l of America

325 Marcus Blvd.
Hauppauge, NY 11788
(516) 434-8484 (800) 645-9818 FAX: (516) 434-8484
President: Tom Wada; **Nat'l Sales Manager:** Ruben Fursalg; **Manager:** Klm Mizuno

Lake Inc.

7009 West Belt Dr.
Nashville, TN 37209
(615) 350-8181 (800) 366-5253 FAX: (800) 726-3291
Vice-President: Howard Kohnstamm;
Purchasing/Systems: Steve Houston; **Systems Consultant:** Ruth Jose; **Systems Consultant:** Imran Rahman
Doug Warren, Newport News, VA 804-930-3217
PRODUCTS: accessories, cameras, channel convertors, computer interfaces, connectors,

dummy cameras, effects generators, enclosures, fiber optics, hardware, lenses, message generators, modulators, monitors, multiplexers, pan/tilts, remote controls, signal distribution, specialty cameras, surveillance, switchers, time-lapse recorders, transmission systems, video mixers, video projectors, VTR's

Lightwave Communications

650 Danbury Rd.
Ridgefield, CT 06877
(203) 438-3591 FAX: (203) 431-3001

Markertek Video Supply

145 Ulster Ave., Saugerties, NY 12477
(914) 246-3036 FAX: (914) 246-1757
Camden Marketing, Pierre Fonds, QU 514-683-3377

Math Associates, Inc.

2200 Shames Drive, Westbury, NY 11590
(516) 334-6800 FAX: (516) 334-6473
President: Ellen Math; **Chairman of Board/Tech. Dir.:** Irwin Math; **Vice President:** Martin Rein; **Director of Mktg. and Sales:** James Treuhart
Sel-Tronics, Inc. - Gary Brown, Landover, MD 301-341-2700
Light Brigade - Larry Johnson, Renton, WA 206-277-1240
Al Barshop, Inc., Davie, FL 305-680-8366
Seevid, Inc., Huntington Beach, CA 714-898-6100
Crockett Sales Co., Dallas, TX 214-250-3377
Jim Burger, Philadelphia, PA 203-297-7160
PRODUCTS: fiber optics

Meridian Technologies, Inc.

80 Mott Avenue, Inwood, NY 11696
(516) 371-9300 FAX: (516) 371-9301
President: Robert Klein; **Director of Engineering:** Jack Krol
Doug Warren, Newport News, VA 804-930-3217
PRODUCTS: accessories, fiber optics, modulators, multiplexers, remote controls, surveillance, transmission systems

MFJ Enterprises, Inc.

921 Louisville Road, Starkville, MS 39759
(601) 323-5869 (800) 647-1800 FAX: (601) 323-6551
Audio Etc., St. Peters, MO 314-278-4130
PRODUCTS: effects generators, message generators, modulators, signal distribution

Mikrolab Video

4121 Redwood Ave., Ste. 215
Los Angeles, CA 90066
(213) 306-0120 FAX: (213) 821-1012
Camden Marketing, Pierre Fonds, QU 514-683-3377

Mitsubishi Electronics America, Inc

5757 Plaza Dr.
P.O. Box 6007
Cypress, CA 90630-0007
(714) 229-6516 FAX: (714) 229-3814
National Sales Manager: Greg Stoner; **Sales Manager:** Tod Gooch
Camden Marketing, Pierre Fonds, QU 514-683-3377

Multiplex Technology Inc.

3200 East Birch Street
Brea, CA 92621
(714) 996-4100 (800) 999-5225 FAX: (714) 996-4900
President: Phillip Strauss; **Vice President, Sales:** Frank White; **Product Specialist:** John David; **Office Manager:** Karin DeRisner
David Raudabaugh, Marietta, GA 404-509-8722
Howard Greenberg, Cherry Hill, NJ 609-667-5278
Loomis and Associates, Fremont, CA 415-683-0883

Northern Information Technology

5410 Newport Drive S-23
Rolling Meadows, IL 60008
(708) 670-0345 (800) 528-4343 FAX: (708) 670-9638
President: Edward L. Polanek; **Operations Manager:** James P. Hertrich;
Sales Manager: Roy D. Herbert
PRODUCTS: transmission systems

OptoDigital Design Inc.

8920 Business Park Drive #435, Austin, TX 78759
(512) 338-4707 FAX: (512) 794-9997
CEO: Rodney Herman; **V.P., Sales and Marketing:** Barry Thornton
Audio Etc., St. Peters, MO 314-278-4130
PRODUCTS: fiber optics

Orchard Communications

101 N. Plains Industrial Road
Wallingford, CT 06492
(203) 284-1680 (800) 523-7893 FAX: (203) 269-2964
President: John M. Iles; **Dir. of Systems Engineering:** Dean H. Bogert; **Vice President of Sales:** Ronald F. Jones
Loomis and Associates, Fremont, CA 415-683-0883
PRODUCTS: fiber optics, modulators, remote controls, signal distribution

PANASONIC CCVED

One Panasonic Way, Secaucus, NJ 07094
(201) 392-4429 FAX: (201) 348-7372
General Manager: Milton A. Landau; **Assistant General Manager:** Ronald Harned
Panasonic CCVED/Northeast, Secaucus, NJ 201-348-7303
Panasonic CCVED/Southeast, Norcross, GA 404-717-6835
Panasonic CCVED/Midwest, Arlington Hts., IL 708-640-5168
Panasonic CCVED/Southwest, Ft. Worth, TX 817-685-1117
Panasonic CCVED/West, Cypress, CA 714-373-7265
Audio Biz, Mundellen, IL 708-949-0280
PRODUCTS: accessories, cameras, connectors, dummy cameras, effects generators, monitors, multiplexers, pan/tilts, remote controls, signal distribution, specialty cameras, surveillance, switchers, time-lapse recorders, VTR's

Peerless Sales Company

1980 Hawthorne
Melrose Park, IL 60160
(708) 865-8870 (800) 729-0307 FAX: (708) 865-2941
President: Walt Snodell; **Director of Marketing:** Frank Brigg; **Director of Sales:** Bill Brock
Crescendo Associates, Hollywood, FL 305-922-9553
PRODUCTS: accessories

Pelco

300 W. Pontiac Way
Clovis, CA 93612
(209) 292-1981 (800) 289-9100 FAX: (800) 289-9150
President: David McDonald; **Sr. VP Sales & Marketing:** Thomas Grogan; **Western Sales Manager:** Alan Jorn; **Eastern Sales Manager:** Ed White; **Inside Sales Manager:** Bill Reece;
Marketing Manager: Craig Thomas
Dimension/ Point IX, Lewisville, TX 214-436-3706

Portac, Inc.

108 Aero Camino
Goleta, CA 93117
(805) 685-2960 (800) 262-2960 FAX: (805) 968-2120
President: Brian E. Hooper
Camden Marketing, Pierre Fonds, QU 514-683-3377
PRODUCTS: computer interfaces, message generators, surveillance

Quickset International, Inc.

3650 Woodhead Dr.
Northbrook, IL 60062-1895
(708) 498-0700 FAX: (708) 498-1258
V.P., Sales & Marketing: Rudy L. Merz; Eastern
Account Manager: Jack Farrell; Western Account
Manager: Jim Lachenberg
Camden Marketing, Pierre Fonds, QU 514-683-
3377
PRODUCTS: accessories, cameras, enclosures,
hardware, pan/tilts, remote controls,
surveillance

REVERE INDUSTRIES

1101 Blenville St.
New Orleans, LA 70112
(504) 523-3503 (800) 843-8321 FAX: (504) 525-6361
Vice President Mktg./Sales: Richard Harris
Camden Marketing, Pierre Fonds, QU 514-683-
3377
PRODUCTS: accessories, cameras, connectors,
dummy cameras, enclosures, fiber optics,
hardware, lenses, message generators,
modulators, monitors, multiplexers, pan/tilts,
remote controls, signal distribution, specialty
cameras

**Richardson Electronics Limited,
SSD**

3030 River Road
River Grove, IL 60171
(312) 625-2288 (800) 722-2288 FAX: (708) 452-5450
Vice President/ General Mgr.: Sal Rala; National
Sales Manager: Tom Brown; Director of
Operations: Charlene Woodward
Richardson Electronics Limited, Brooklyn, NY
718-692-5350
Richardson Electronics Limited,
Brampton, Canada,
Sunrise Sales Company, LaMolle, IL 815-638-2660
PRODUCTS: accessories, cameras, channel
convertors, computer interfaces, connectors,
dummy cameras, enclosures, fiber optics,
hardware, lenses, message generators,
modulators, monitors, multiplexers, pan/tilts,
remote controls, signal distribution, specialty
cameras, surveillance

Robot Research, Inc.

5636 Ruffin Rd.
San Diego, CA 92123
(619) 279-9430 FAX: (619) 279-7931
V.P., Sales & Marketing: Russ Mayworm
PRODUCTS: computer interfaces, modulators,
remote controls, signal distribution,
transmission systems, video mixers

RTI-Research Technology Int'l

4700 Chase Avenue
Lincolnwood, IL 60646
(708) 677-3000 (800) 323-7520 FAX: (708) 677-1311
President: Ray Short; Vice President: Tom
Boyle; Vice President- Marketing: Tom Tisch;
Vice President- Sales: Bill Whauka
Karp Communications, Tampa, FL 813-968-7098

Sanyo-Industrial Video Division

1200 W. Artesia Blvd.
Compton, CA 90220
(213) 605-6528 FAX: (213) 605-6529
National Sales Manager: Wayne Kennedy;
Western Regional Sales Mgr.: Tom Thompson;
Eastern Regional Sales Mgr.: Tom Cunningham
Sound Sales, Inc., Columbia, MD 301-964-1170
PRODUCTS: cameras, dummy cameras, lenses,
monitors, multiplexers, time-lapse recorders,
video mixers, video projectors, VTR's

Security Resources

21 Castle Avenue
Fairfield, CT 06430
(203) 334-3233 (800) 243-2878 FAX: (203) 332-7093
Karp Communications, Tampa, FL 813-968-7098

Sharp Electronics Corp. LCD Prods.

Sharp Plaza, Mall Stop One
P.O. Box 650
Mahwah, NJ 07430
(201) 529-8731 FAX: (201) 529-9636
General Manager: Ron Colgan; National
Marketing Manager: Bruce Pollack; Product
Marketing Manager: Joe Gillio; Product Manager:
Frank Romeo; Vice President: Bob Carbutt;
National Service Manager: John Burek
Sunrise Sales Company, LaMolle, IL 815-638-2660
PRODUCTS: video projectors

**SONY CORP. OF AMERICA, A/V
PRODUCTS**

10833 Valley View Street
Cypress, CA 90630
(714) 229-4318 (800) 326-7669 FAX: (714) 229-4298
Vertical Markets Manager: T. Park; AV Product
Manager: A. Nitta; AV Sales Manager: K. Carr; AV
Product Support Spvr.: A. Ruppe; Management
Associate: D. Williams; Product Support
Coordinator: P. Penell
Cambridge Marketing, Westerville, OH 614-363-
9191
PRODUCTS: monitors

Sony Corp./Business & Pro. Aud. Grp

3 Paragon Drive, Montvale, NJ 07645-1735
(201) 930-1000
President, Sales & Marketing: Mark Gray; Senior
VP Sales: C.F. Taylor; V.P. Product Marketing:
Anthony Gargano; Marketing Manager, Pro
Audio: Courtney Spencer; Sales Manager, Pro
Audio: Gary Rose; V.P. Audio Products: Ron
Remschel
Matt Robertson, Western Dist., 213-469-9084
Audio Etc., St. Peters, MO 314-278-4130
PRODUCTS: cameras, effects generators,
monitors, surveillance

Sony Security Systems

3 Paragon Drive, Montvale, NJ 07645
(201) 358-4954 FAX: (201) 358-4927
President: John Garrison; Director of Sales: Ken
LaMarca
Sony Security Systems, Teaneck, NJ 201-833-5749
Sony Security Systems, Lanham, MD 301-577-4850
Sony Security Systems, Itasca, IL 708-773-6014
Sony Security Systems, Cypress, CA 714-229-4424
Sony Security Systems, San Jose, CA 408-432-9191
Sound Sales, Inc., Columbia, MD 301-964-1170
PRODUCTS: accessories, cameras, enclosures,
lenses, monitors, signal distribution, specialty
cameras, surveillance, switchers, time-lapse
recorders, transmission systems, VTR's

Southwest Microwave, Inc.

2922 South Roosevelt
Tempe, AZ 85282
(602) 968-5995 FAX: (602) 894-1731
MJA Marketing, St. Charles, MO 314-447-7111

STA - Sky-Tracker of America

28007 Front St.
Temcula, CA 92390
(800) 551-8881 FAX: (714) 694-0012
Manager, Sales & Marketing: Mark Ashley
Precide, Morbio Inferiore, Switzerland, 914-
31734
PRODUCTS: enclosures

Surveillance Video Systems

258 A Street
P.O. Box 1349
Ashland, OR 97520
(503) 482-4500 (800) 431-5400 FAX: (503) 482-4426
President: Bud Wilkey; Vice President: John
Minor
Karp Communications, Tampa, FL 813-968-7098

Symco

29 Poplar Dr.
Stirling, NJ 07980
(908) 647-6262 FAX: (908) 647-4904
Camden Marketing, Pierre Fonds, QU 514-683-
3377

TEI Electronics Inc.

570 W. 18 St.
P.O. Box 246
Hialeah, FL 33011
(305) 888-3980 (800) 327-8811 FAX: (305) 885-4950
President: Danny Alonso; Vice President: Mireya
A. Muniz; National Sales Manager: Walter
McNulty; Customer Service: John Tembras;
Sales: Orlando Pineda; Sales: Jose Hurcades
Audio Blz, Mundellien, IL 708-949-0280
PRODUCTS: accessories, effects generators,
signal distribution, switchers, video mixers

Tel-E-Tel Corp.

1011 High Ridge Rd.
Stamford, CT 06905
(203) 322-4871 FAX: (203) 329-7428
Sound Sales, Inc., Columbia, MD 301-964-1170
PRODUCTS: transmission systems

Telemetrics Inc.

7 Valley St.
Hawthorne, NJ 07506
(201) 423-0347 FAX: (201) 423-5635
President: Anthony C. Cuomo; Manager:
Anthony E. Cuomo
Camden Marketing, Pierre Fonds, QU 514-683-
3377

UHF Associates

5625 State Farm Dr. #4
Rohnert Park, CA 94928
(707) 584-7844
GO Video Sales, Lake Forest, IL 708-295-6726
Langbaum Associates, New City, NY 914-634-1141
Crockett Sales Co., Dallas, TX 214-350-3377
FM Valenti, Nahant, MA 617-592-5300
RW Kunz & Assoc., Prairie Village, KS 913-648-3535
Cambridge Marketing, Westerville, OH 614-363-
9191
PRODUCTS: accessories, channel convertors,
modulators, multiplexers, remote controls,
signal distribution, surveillance, switchers,
transmission systems

Usatco (Universal Satellite Corp.)

300 E. 59th St.
New York, NY 10022
(718) 786-1510
Camden Marketing, Pierre Fonds, QU 514-683-
3377

VCS

262 Carlton Dr.
Carol Stream, IL 60188
(708) 690-1400 FAX: (619) 455-7324
Camden Marketing, Pierre Fonds, QU 514-683-
3377

Ventronic, Inc.

94 Gallil Dr., Novato, CA 94949
 (415) 382-9480 (800) 544-0640 FAX: (415) 382-0414
 President: Allen Coddington; Director of
 Operations: Irene Fay; Sales Engineering: Bob
 Redmond
 Camden Marketing, Pierre Fonds, QU
 514-683-3377
 PRODUCTS: fiber optics

Vicon Industries Inc.

525 Broad Hollow Road
 P.O. Box 5315, Melville, NY 11747-0112
 (516) 293-2200 (800) 645-9116 FAX: (516) 293-2627
 President/CEO/Chm. Bd.: Donald Horn; Exec.
 Vice Pres./COO: Kenneth Darby; Sr. VP New Prod
 & Tech. Sup.: Peter Horn; VP of Operations:
 Richard Perna; VP of Engineering: Yacov
 Pshtilssky; VP Corp. Systems: Lawrence Russo
 Vicon Industries Inc., Norcross, GA 404-449-0499
 Vicon Industries Inc., Long Beach, CA
 213-595-9776
 Vicon Industries Inc., Newcastle, OK 405-392-2550
 Cambridge Marketing, Westerville, OH 614-363-9191
 PRODUCTS: accessories, cameras, computer
 interfaces, enclosures, fiber optics, hardware,
 lenses, message generators, modulators,
 monitors, multiplexers, pan/tilts, remote
 controls, signal distribution, specialty cameras,
 surveillance, switchers, time-lapse recorders,
 transmission systems, VTR's

Video Link

12950 Bradley Avenue
 Sylmar, CA 91342
 (818) 362-0353 (800) 843-5465 FAX: (818) 362-9506
 President: Herb Seymour; V.P. Sales and
 Marketing: Bill Cawfield; Sales Manager: Larry
 W. Schatz; Asst. Sales Manager: Marguerita Kiser
 J.B. Parent, Dublin, OH 614-764-0064
 PRODUCTS: accessories, cameras, channel
 converters, effects generators, modulators,
 signal distribution, specialty cameras

Video Resources

21 Castle Ave.
 Fairfield, CT 06430
 (203) 334-3233 FAX: (203) 332-7093

Videolarm, Inc.

2675 Lithonia Industrial
 P.O. Box 802
 Lithonia, GA 30058
 (404) 482-1313 (800) 554-1124 FAX: (404) 482-1963
 President: Raymond V. Pagano; National Sales
 Manager: Nathan Schroeder; Director of
 Engineering: Peter Schneider; Director of
 Manufacturing: Richard Harris
 Repworks, Chocopee, MA 413-533-0845
 Security Solutions, Gainesville, GA 800-333-2844
 Monfort Electronics, Indianapolis, IN 317-872-8877
 CMC, Ltd., Chestnut Ridge, NY 914-356-5300
 D. Acker & Assoc., New Orleans, LA 504-865-7714
 Camden Marketing, Pierre Fonds, QU
 514-683-3377
 Seevid, Huntington Bch., CA 213-594-4444
 Protection Systems, Tinley Park, IL 708-614-8990
 Multi-Tech, Brainerd, MN 218-828-9483
 Miller Ferree & Assoc., Bellevue, WA 206-462-1771
 Robert St. John, Middletown, MD 301-371-4965

Videoplex, Inc.

100 Cralg Road
 Freehold, NJ 07728
 (908) 462-8555 FAX: (908) 780-8394
 President: Martin Horak
 T.C. Marketing, Reseda, CA 818-776-8120
 PRODUCTS: multiplexers

Visual Methods Inc.

35 Charles Street
 Westwood, NJ 07675
 (201) 666-3950 FAX: (201) 666-7931
 President: W.T. Sandlin; Vice President: H.
 Kruegle
 Larry Schirmer, Pontiac, MI 313-340-9588
 PRODUCTS: accessories, lenses, specialty
 cameras, surveillance

Wireless Technology, Inc.

3021 S. Valley View Blvd. #104
 Las Vegas, NV 89102
 (702) 362-8686 FAX: (702) 362-8191
 President: William G. Horrell; Executive Vice
 President: Daniel Fancher; Sr. Vice Pres.,
 Marketing: Sanford H. Green
 Protection Systems, Tinley Park, IL 708-614-8990
 Valenti & Assoc., Nahant, MA 617-592-5300
 Pacer Sales Co., Lenexa, KS 913-541-1411
 Epic Marketing, San Mateo, CA 415-573-5881
 Florida Electronic/Repco, N. Palm Beach, FL 407-
 622-7555
 MJA Marketing, St. Charles, MO 314-447-7111
 PRODUCTS: remote controls, surveillance,
 transmission systems

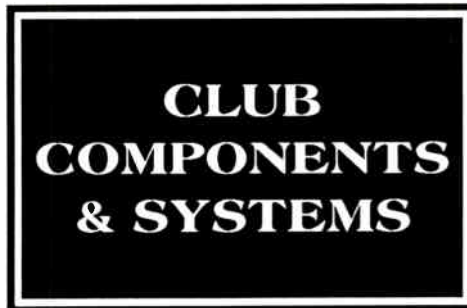
**American DJ Supply, Inc.**

5051 E. Slauson Ave.
 Los Angeles, CA 90040
 (213) 773-3333 (800) 333-0644 FAX: (213) 773-1956
 General Manager: Scott Davies; Sales Manager:
 Toby E. Velazquez; National Account Executive:
 Eric J. Loader
 Market Insights, Glenview, IL 708-729-2047
 Professional Sound & Lighting, Lakewood, CO
 303-986-5999
 Watt Marketing, Allentown, PA 215-820-7586
 Doug Warren, Newport News, VA 804-930-3217
 PRODUCTS: lighting controls

BBE SOUND, INC.

5500 Bolsa Ave. Ste. #245
 Huntington Bch., CA 92649
 (714) 897-6766 (800) 233-8346 FAX: (714) 895-6728
 Chairman: John C. McLaren; National Sales
 Manager: Rob Rizzuto; Director of Engineering:
 Paul Gagon
 Marshank Sales Co., Los Angeles, CA 213-670-7071
 Starlin Marketing, Chesterton, IN 219-929-4127
 First Choice Marketing, Seattle, WA 206-365-4568
 The Henderson Company, Concord, MA 508-287-
 0020
 John B. Anthony Co., Stamford, CT 203-322-9202
 Nova Marketing, San Francisco, CA 415-952-0943
 PRODUCTS: processors

Denon America, Inc.

222 New Road
 Parsippany, NJ 07054
 (201) 575-7810 FAX: (201) 808-1608
 Sales Mgr. Broadcast Prods.: Laura Tyson
 Edwards Company, Inc., Livonia, MI 313-458-7777

Digital Designs International

125 West Main
 El Centro, CA 92243
 (619) 353-1290 FAX: (619) 353-4751
 Engineer: Jassa Langford; Engineer: John
 Thorp; Sales and Marketing: Alice Sandhu; Sales
 and Marketing: Diane Franke; Office Manager:
 Vicki Langford
 Doug Warren, Newport News, VA 804-930-3217
 PRODUCTS: sub-woofers

Eden Electronics, Inc.

310 1st St.
 Montrose, MN 55368
 P.O. Box 338
 (612) 675-3650 FAX: (612) 675-3651
 President: David Nordschow
 Jim Burger, Philadelphia, PA 203-297-7160
 PRODUCTS: sub-woofers

Electro-Voice Inc.

600 Cecil Street
 Buchanan, MI 49107
 (616) 695-6831 (800) 827-6701 FAX: (616) 695-1304
 President: Paul McGuire; Director of Marketing:
 Jim Long; Director of Sales: Garry Templin; Sales
 & Distribution Mgr.: Janine Masten; Director of
 Service/Rapair: Frank Spain; Public Relations
 Director: Keth Clark
 Metropolis Audio Marketing Inc, New York, NY
 908-225-0085
 R.J. Marketing Ltd., Rockville, MD 301-251-0330
 Ouzunoff & Associates, Yorktown Hts., NY 914-
 248-7888
 Ron Tunks Sales Inc., Tamarac, FL 305-722-2803
 Wilson Audio Sales, Nashville, TN 615-646-4477
 Audio Resources, Westmont, IL 708-655-1180
 B.C. Electronic Sales Inc., Shawnee, KS 913-962-
 1990
 Jones Audio Sales, Plano, TX 214-618-2600
 Excellence Marketing, Eden Prairie, MN 612-949-
 9011
 C.L. Pugh and Associates Inc., Cleveland, OH 216-
 238-1777
 Riley and Petchell Sales Inc., Detroit, MI 313-937-
 3000
 Loppnow and Associates, Issaquah, WA 206-392-
 3936
 Radon and Associates Inc., Sacramento, CA 916-
 923-2524
 The Torbett/ Keiser Group Inc., Loveland, CO 303-
 669-1008
 Western Audio, Burbank, CA 818-954-9300
 Electro-Voice West, Visalia, CA 209-651-7777
 PRODUCTS: sub-woofers

ENVIRONMENTAL SOUND

31220 La Baya Dr., Bld. #110
 Westlake Vlg., CA 91362
 (818) 706-0228 FAX: (818) 889-5605
 President: Pascal Delbuck; Marketing: Ron
 Glatzhoffer; Plant Manager: Bill Ward
 Cambridge Marketing, Westerville, OH 614-363-
 9191
 PRODUCTS: sub-woofers

Gefen Systems

6261 Varlei Avenue #C
 Woodland Hills, CA 91367
 (818) 884-6294 (800) 545-6900 FAX: (818) 884-3108
 President: Hagal Gefen; Vice President,
 Marketing: Jill Shuken; Sales Director: Doug
 Perkins
 Greg Dzubay & Assoc., Glendale, AZ 800-999-0006

IRP, A KNOWLES COMPANY

321 Bond Street, Elk Grove VII., IL 60007
 (708) 439-3600 (800) 255-6993 FAX: (708) 640-9607
 Vice President, General Mgr.: Brian Benn;
 Marketing Manager: Roger Carroll; Senior Sales
 Engineer: Gayle Campbell; Marketing
 Coordinator: Laura Valavclus; Applications
 Engineer: Norm Kinnaugh; Product Engineering
 Manager: Mitch Bentz
 Piper and Givan Assoc., Needham, MA 617-449-1144
 Sigmec Corp., Freehold, NJ 201-462-1221
 Richard S. Pass Associates, Langhorne, PA 215-
 757-6100

Henry W. Phillips Co., Rosewell, GA 404-992-3070
 Bencsik Associates, Ocala, FL 904-732-9775
 C.B. Electronic Marketing, Arvada, CO 303-422-0561
 Avwest Inc., Fountain Hills, AZ 602-946-1811
 EESCO Systems Inc., Los Angeles, CA 213-666-9601
 Pappas Consulting, Menlo Park, CA 415-324-4325
 Chuck Olson Assoc., Renton, WA 206-271-5416
 Kaltec Communications, North Vancouver, BC
 604-987-1597
 More Technologies Inc., Los Angeles, CA 213-474-
 4211

Audio Marketing Assoc., Brecksville, OH
 216-526-2426

StarIn Marketing, Chesterton, IN 219-929-4127

MJA Marketing, St. Charles, MO 314-447-7111

Graham Davis Inc., Dallas, TX 214-357-7677

PRODUCTS: processors

Leprecon/ CAE Inc.

10087 Industrial Drive

P.O. Box 430

Hamburg, MI 48139

(313) 231-9373 FAX: (313) 231-1631

President: James Fackert; General Manager:

Robert Bergman; Sales Manager: Fred Milkeska

J.B. Parent, Dublin, OH 614-764-0064

Ness

111 South State St.

Hackensack, NJ 07601

(201) 646-9522 FAX: (201) 646-1922

President: Nanum Melir; Vice President: Israel

Sirnlch; Ntl. Account Representative: Andy

Broitman; Sales Engineer: Eric Leskin

Camden Marketing, Pierre Fonds, QU 514-683-3377

PRODUCTS: lighting controls

NSI Corporation

9126 SW Ridder Road

P.O. Box 635

Wilsonville, OR 97070

(503) 682-1941 (800) 736-6682 FAX: (503) 682-5784

President: Larry J. Lynn; Vice

President/Marketing: Terry R. White; Vice

President/Engineering: Robert L. Hick

Jim Burger, Philadelphia, PA 203-297-7160

Numark Electronics

503 Newfield Avenue Raritan Ctr

P.O. Box 493, Edison, NJ 08837

(908) 225-3222 FAX: (908) 287-2155

President: Harry Kotovsky; Vice President:

Robert Kotovsky; Midwest Regional Manager:

Bernie Fryman; West Coast Regional Manager:

Jim Cowser; International Sales Manager: Steve

Schiffman; East Coast Regional Manager: Barry

Selden

Crescendo, Hollywood, FL 305-922-9553

StarIn Marketing, Chesterton, IN 219-929-4127

Summit Sales, Houston, TX 713-890-5333

Image Marketing, Sunnyvale, CA 408-732-8025

MI, Avon, MA 508-588-8043

Jim Burger, Philadelphia, PA 203-297-7160

PRODUCTS: CD players, DJ mixers, headphones,

turntable cartridges and accessories, turntables

O-Ryan Industries

9400-A NE 130th Ave.

Vancouver, WA 98682

(206) 892-0447 FAX: (206) 892-6742

Camden Marketing, Pierre Fonds, QU 514-683-3377

**Outline**

Via L. DaVinci 56, 25020 Fiero, Italy

(30) 358-1341 (800) 358-1351 FAX: (30) 358-0431

President: Guido Noselli; Vice President, Sales:

Giorgio Biffi; Marketing Director: Marcello Croce;

R & D Director: Giancarlo Puzzi; Sales Manager:

Anna Guarenti; Purchasing Manager: Angelo

Ferraresi

Coemar Deutschland, ULM, Germany, 073-160-1205

MBS, Lempdes, France, 073-910-630

Leibnitzer M. Bigler, Austria, 034-52-6515

Talsheng Trading, Taipei, Taiwan, 253-13802

Universal, Singapore, 534-5993

Preclde, Morbio Inferiore, Switzerland, 914-31734

PCP Electronics, Limassol, Cyprus, 53-39297

Metronome Muzik, Istanbul, Turkey, 7-345-2457

Tropical Recording, Malindi, Kenya, 723-27700

Point Rouge, Mutuelueville, Tunis, 7-345-2457

PRODUCTS: DJ mixers, sub-woofers

Paso Sound Products, Inc.

14 First Street

Pelham, NY 10803

(914) 738-4800 (800) 231-3034 FAX: (914) 738-3954

Executive Vice President: Paul Mastrangelo;

Product Manager: Ken O'Brien; Credit Manager:

Marilyn Beckerson; Operations Manager:

Anthony Squeglla

Anderson Sales, Braintree, MA 617-848-9194

Jack Mesnick Sales, Liverpool, NY 315-622-3211

Palmieri Associates, Fairfield, NJ 201-882-1266

Weller Electronic Sales, Inc., Worthington, OH

614-885-7819

Lienau Associates, Columbia, MD 301-621-4113

MJA Marketing, St. Charles, MO 314-447-7111

Northland Assoc., Moorehead, MN 218-233-4616

Allwest Sound & Communication, Camarillo, CA

805-388-7745

Dimension Pt. IX Marketing, Katy, TX 713-578-9277

Mountain Representatives, Denver, CO 303-333-
7745

Miguel Lopez, Hialeah, FL 305-822-6853

Paco Electronics, Ltd., Markham, ON 416-475-0740

Robert Milk Co., Southfield, MI 313-354-3310

Marketline Inc., Snellville, GA 404-972-9048

Hawkins-Frederickson Assoc., Maitland, FL 407-
831-2474

Lintern Associates, Naperville, IL 708-904-1225

Robert Milk Co., Indianapolis, IN 317-842-3400

PRODUCTS: turntable cartridges and accessories,

turntables

PEAVEY ELECTRONICS CORP.

711 A Street

P.O. Box 2898

Meridian, MS 39301

(601) 483-5365 FAX: (601) 484-4278

CEO: Hartley Peavey; President: Mella Peavey

Dimension/ Point IX, Lewisville, TX 214-436-3706

PRODUCTS: DJ mixers, karaoke, lighting controls,

processors

Pioneer Laser Entertainment

2265 E. 220th Street

Long Beach, CA 90810

(213) 816-5111 FAX: (213) 816-5990

President: Ted Karasawa; Senior Vice President:

Mark Makabe

Pioneer Laser Entertainment, San Ramon, CA

415-866-2240

Pioneer Laser Entertainment, Irving, TX 214-580-
0200

Pioneer Laser Entertainment, Fort Lee, NJ 201-
461-3355

Pioneer Laser Entertainment, Itasca, IL 708-285-
4500

Pioneer Laser Entertainment, Roswell, GA 404-
475-4317

Dimension/ Point IX, Lewisville, TX 214-436-3706

PRODUCTS: CD players, DJ mixers, karaoke,

processors

Rane Corp.

10802 47th Avenue West

Mukilteo, WA 98275-5098

(206) 355-6000

President: Steve Brakken; CEO: Linda Arlink; V.P.

of Manufacturing: Rick Bernard; V.P. of R & D:

Dennis Bohn; V.P. of Marketing: Larry Winter;

National Sales Manager: Ray Bloom

Larry Schirmer, Pontiac, MI 313-340-9588

PRODUCTS: DJ mixers, processors

Sabine Musical Mfg. Co., Inc.

4637 N.W. 6th Street

Gainesville, FL 32609

(904) 371-3829 (800) 626-7394 FAX: (904) 371-7441

President/C.E.O.: Doran Oster; Sales & Marketing

Director: John M. Annin; Sales & Customer

Service: Neil Rapaport

Sound Sales, Inc., Columbia, MD 301-964-1170

PRODUCTS: processors

Sony Corp./Business & Pro. Aud. Grp

3 Paragon Drive

Montvale, NJ 07645-1735

(201) 930-1000

President, Sales & Marketing: Mark Gray; Senior

VP Sales: C.F. Taylor; V.P. Product Marketing:

Anthony Gargano; Marketing Manager, Pro

Audio: Courtney Spencer; Sales Manager, Pro

Audio: Gary Rose; V.P. Audio Products: Ron

Remschei

Matt Robertson, Western Dist., 213-469-9084

Audio Etc., St. Peters, MO 314-278-4130

PRODUCTS: CD players, headphones

Stagecraft Lighting

Rt 1 Box 50

P.O. Box 566

Jackson, MO 63755 (800) 234-5789 FAX: (314) 243-
1384

Chief Executive Officer: Peter Marsac; Vice

President of Marketing: Brad Graham

J.B. Parent, Dublin, OH 614-764-0064

PRODUCTS: lighting controls

Stanton Elec. div. Stanton**Magnetic**

101 Sunnyside Boulevard

Plainville, NY 11803

(516) 349-0235 FAX: (516) 349-0230

President: Walter O. Stanton; Vice President

Sales & Mkt'g: Jack O'Donnell; VP-International

Mkt'g & Sls: Frank Conlon; Mgr. Advertising &

Promotion: Jean Kapen

Karp Communications, Tampa, FL 813-968-7098

Summa Technologies

2179 Stone Ave., Ste. 23
San Jose, CA 95125
(408) 293-3657 FAX: (408) 293-3660
Camden Marketing, Pierre Fonds, QU 514-683-3377

Technics Audio Products

1C-7 One Panasonic Way
Secaucus, NJ 07094
(201) 348-7690 FAX: (201) 348-7954
VP & General Manager: Michael Aguilar; Assistant
General Manager: Andrew Nelkin; National
Marketing Manager: Mark Hutchinson; Planning
Manager: Oscar Seo; Public Relations Manager:
Martha Whiteley; Marketing Administrator:
Mildred Garcia
Burt Desmond, Secaucus, NJ 201-348-4327
Roger West, Baltimore, MD 301-761-1900
Tom Grant, Arlington Hts., IL 708-981-4330
Bob Elefante, Norcross, GA 404-925-6715
Dave Smith, Cypress, CA 714-373-7243
Audio Blz, Mundellen, IL 708-949-0280
PRODUCTS: CD players

TEI Electronics Inc.

570 W. 18 St.
P.O. Box 246, Hialeah, FL 33011
(305) 888-3980 (800) 327-8811 FAX: (305) 885-4950
President: Danny Alonso; Vice President: Mireya
A. Muniz; National Sales Manager: Walter
McNulty; Customer Service: John Tembras;
Sales: Orlando Plineda; Sales: Jose Hurcades
Audio Blz, Mundellen, IL 708-949-0280
PRODUCTS: DJ mixers, headphones, lighting
controls, processors, turntable cartridges and
accessories

TELEX COMMUNICATIONS, INC.

9600 Aldrich Avenue South
Minneapolis, MN 55420
(612) 884-4051 FAX: (612) 884-0043
President: Jeffrey Wetherell; Vice President
Marketing: John Schofield; Vice President Sales:
Dan Dantzier; Director of Marketing: Don
Mereen; Manager/Advertising & Mkt'g: Ron Taylor
Westech Marketing, Culver City, CA 213-870-9286
Bencsik Associates, Ocala, FL 904-732-9775
Burcaw Company & Associates, Warren, MI
313-573-4605
SAGA, Oswego, NY 315-343-5739
Monfort Electronic Marketing, Indianapolis, IN
317-872-8877
Murphy & Cotta, Inc., Atlanta, GA 404-875-2525
Northland Associates, Moorhead, MN 218-233-4616
Rancillo Associates, Inc., St. Louis, MO 314-845-0202
J.Y. Schoonmaker Company, Dallas, TX 214-349-1650
Sigmet Corporation, Valley Forge, PA
215-783-6666
Weller Electronic Sales, Worthington, OH
614-885-7819
Ziskind Associates, Rolling Meadows, IL
312-577-1624
White Radio Ltd., Burlington, ON 416-632-6894
Silver Peak Marketing, Denver, CO 303-467-9042
PacNor Marketing, Lynnwood, WA 206-771-6016
PRODUCTS: headphones

The Music People, Inc.

2074 Park St.
Hartford, CT 06106
(203) 236-7134 (800) 289-8889 FAX: (203) 233-6888
President: James R. Hennessey; Controller:
John Gutowski; Import/Export Manager: Kelly
Heintz; Purchasing Manager: Paul Thaxton
West Coast Warehouse Facility, Los Angeles, CA
PRODUCTS: CD players, DJ mixers, headphones,
turntable cartridges and accessories, turntables

THE RUGGEDNESS OF OUR CD PLAYERS ISN'T A RETROFIT.

From the get-go, we designed our Industrial Strength CD players to stand up to the kind of heavy-duty use that typical consumer CD players can't handle.

That's why every TASCAM CD player is rack-mountable. And why both the CD-301 and CD-401 feature balanced XLR and unbalanced RCA outputs for added flexibility.

The economy-minded CD-301 (\$549,* including hardwired remote) offers the high reliability required for heavy-use applications, plus precision playback capability. The CD-301 also features a single-play function to automatically stop playback at the end of a song, allowing DJs to concentrate on voice-overs or to make a clean start for the next track. And a link function to permit hookup of multiple CD-301s for automatic back-and-forth sequential play.

The high-performance CD-401 (\$799*) incorporates TASCAM's award-winning ZD circuit to eliminate low level distortion and ensure sound quality that meets the most demanding standards.

The CD-401's fader-start feature allows play to start automatically on fade-in and stop at the completion of a fade-out. The CD-401 is available with optional hardwired or wireless remote.

For more information, call or write TASCAM, the company whose Industrial Strength product line also includes cassette decks and mixers.

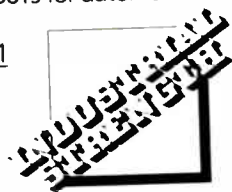

TASCAM



©1991 TEAC America, Inc., 7733 Telegraph Road, Montebello, CA 90640. 213/726-0303. *Suggested retail price.

Circle 240 on Reader Response Card



TOA ELECTRONICS, INC.

601 Gateway Blvd. Suite 300
 P.O. Box 2047, S San Francisco, CA 94080
 (415) 588-2538 (800) 733-4750 FAX: (415) 588-3349
 President: Yoshiro Ishida; Director, Audio Products
 Div: Richard Krochmal; Director, Comm. Systems
 Div.: Al Burns; Mgr., Marketing Development: Jeff
 Pallin; Manager, Western Division: Bill Ford;
 Manager Engineering Services: Bob Sweet
 Chuck McGregor- Product Constt, Morris Plains,
 NJ 201-829-7047
 John Murray-Eng.Snd. Mktg. Dev, Springfield, OH
 513-324-1993
 Bob Hager-Eastern Regional Mgr, Rosewell, GA
 404-552-7624
 Linda Wick-Central Reg. Mgr., Kansas City, MO
 816-453-5775
 Robert Slaughter-Cntrl Div Mgr, Houston, TX 713-
 460-3678
 Pete Newmark-West Regional Mgr., Mesa, AZ
 602-981-0050
 Walter Best, Eastern Reg. Mgr., Sussex, NJ 201-
 702-0068
 PRODUCTS: processors, sub-woofers

Tracom

2533 NW 74th Ave.
 Miami, FL 32244
 (305) 591-5991 FAX: (305) 591-5990
 Audio Etc., St. Peters, MO 314-278-4130

Vestax Pro Audio

908 W. Layette Ave.
 Effingham, IL 62401
 (217) 342-9211 FAX: (217) 347-0316
 Audio Etc., St. Peters, MO 314-278-4130

YAMAHA CORP. OF AMERICA

6600 Orangethorpe Ave.
 Buena Park, CA 90620
 (714) 522-9011 FAX: (714) 739-2680
 Sales & Marketing Manager: Gerald W. Tschetter;
 Pro Digital Sis & Mktg Mgr.: Peter Chalkin;
 Market Support Manager: Don Bowles
 Precide, Morbio Inferiore, Switzerland, 914-31734
 PRODUCTS: DJ mixers, headphones, sub-woofers

**Subscribe to
 Sound &
 Communications
 Magazine**

CONTRACTORS:

T IRED of looking for cassette decks and compact disc players that rack mount? Tired of dealing with salespeople who don't know what they're selling? Then call the professionals at Oz Electronics.

O Z Electronics, Inc. stocks the complete line of Technics Audio Products and has been servicing the contractor and audio professional for almost five years.

G IVE us a call today and see how easy it is to get the answers and the right product.



OZ ELECTRONICS, INC.
 4895 Joliet Street
 Denver, CO 80239
 (303) 371-3446
 2624 Wilshire Blvd.
 Santa Monica, CA 90403
 (213) 829-3362

ELECTRONICS, INC.

**EVERY
 MAJOR
 TRADE
 SHOW
 ON
 VIDEO**

CES-TV NEWS

**NAB
 TV NEWS**

**AES-TV
 NEWS
 INCLUDING:
 CROSSTALK SYMPOSIUM**

TV NEWS

NAMM TV NEWS

NSCA-TV NEWS
 AES-TV NEWS/CROSSTALK
 CES-TV NEWS
 NAMM-TV NEWS
 NAB-TV NEWS

**CALL FOR
 INFORMATION**

**516
 767-2500**

Television news
 programs covering
 the conventions
 that are of import.

**ORDER THEM
 NOW!**

TESTA COMMUNICATIONS
 25 Willowdale Avenue
 Port Washington, NY 11050

"People love to sing and Pioneer Laser Karaoke offers the ideal venue."

*Trent Esperti, Barwinkles
Long Beach, CA*



"Pioneer has the best and most reliable equipment."

*Susan Apple Manegold
Apple Entertainment
Seattle, WA*



"Pioneer Laser Karaoke has increased our business 100%."

*Jon Spradlin, Car's Meow
New Orleans, LA*



INSTALL LASER KARAOKE AND CLIENTS WILL SING YOUR PRAISES.

It's not often that an installation leaves bar owners and hotel managers singing.

But then again, it's not often that they see a crowd-drawing money-maker like Pioneer Laser Karaoke.

Now it's your turn. Install Laser Karaoke and let their praises be music to your ears. And put an extra ring in your cash register.



For more information, call (800) 421-1404 and ask for Laser Karaoke. And be one step ahead of your clients when they call to ask what's new and different.

LaserKaraoke[®]

PIONEER[®]
The Art of Entertainment

© 1991 Pioneer Laser Entertainment, Inc.
2265 East 220th St., Long Beach, CA 90810
World Radio History

Circle 203 on Reader Response Card

HARDWARE & TOOLS

AVA Electronics

4000 Bridge St.
Drexel Hill, PA 19026
(215) 284-2500
J.B. Parent, Dublin, OH 614-764-0064

BI-Tronics, Inc.

76 Main Street
P.O. Box 125
Tuckahoe, NY 10707
(914) 961-2004 (800) 666-0996 FAX: (914) 961-4244
President: J. Schwartz; Engineering Sales
Manager: Ron Huppert; Sales Administrator: C.
Viafore
J.B. Parent, Dublin, OH 614-764-0064
PRODUCTS: cabinet hardware, cable clamps,
connectors, panels, tool kits, wire terminators

BJM Electronics Ltd.

2589 Richmond Terrace
Staten Island, NY 10303
(718) 442-0223 FAX: (718) 442-1451
President: Robert Manzo; Sales Manager: Jeff
Salitell; Purchasing: Jason Manzo
Precide, Morbio Inferiore, Switzerland, 914-
31734
PRODUCTS: cable testers, cleaning chemicals,
connectors, lamps, lineman's test sets, panels,
tool kits, wire terminators

Black Audio Devices

P.O. Box 106
Ventura, CA 93002
(805) 653-5557
President: Bruce Black
Nova Marketing, San Francisco, CA 415-952-0943
PRODUCTS: cable clamps, knobs, panels

Brim Electronics

P.O. Box 336 S
Fair Lawn, NJ 07410
(201) 796-2886 FAX: (201) 778-2792
President: B. Danziger; Sales Manager: B. Brown
C H Assoc., Stow, MA 508-897-3534
Boerger Assoc., Mpls., MN 612-560-3435
Mactronix, Phoenix, AZ 602-998-1848
Roburn Agencies, Yonkers, NY 914-968-1016
Nova Marketing, San Francisco, CA 415-952-0943
PRODUCTS: cable clamps, markers

Case Component Network

P.O. Box 41185
Chicago, IL 60641 (800) 722-3027 FAX: (312) 772-
6586
MDS, Chicago, IL 312-282-8171
Umbra USA, Lackawanna, NY 416-299-0088
El-Com, Santa Ana, CA 714-432-6630
Doug Warren, Newport News, VA 804-930-3217

Cliff Electronics Inc.

9821 Whithorn
Houston, TX 77095
(713) 855-6685 FAX: (713) 855-6684
General Manager: Robert Tupper
Sunrise Sales Company, LaMolle, IL 815-638-2660
PRODUCTS: cabinet hardware, cable clamps,
connectors, knobs, speaker hardware

D.J. Associates, Inc.

8411 South Zero Street
Fort Smith, AR 72903
(501) 452-3987 FAX: (501) 452-7752
Sales Manager: Michael P. Beck; Customer
Service: Mindy Cardwell
Edwards Company, Inc., Livonia, MI 313-458-7777

Freeform R & D

1539 Monrovia Ave., # 23
Newport Beach, CA 92663
(714) 646-3217 FAX: (714) 646-3218
President: Stephen B. Wheeler; Vice President
Marketing: Nova S. Wheeler
Doug Warren, Newport News, VA 804-930-3217
PRODUCTS: wire pulling devices

WE DO THE WORK YOU GET THE BENEFIT

THE SOUND COMMUNICATIONS

editorial staff researches the industry. . .

- THE PRODUCTS
- THE TECHNIQUES
- THE TECHNOLOGY
- THE VENUES
- THE PEOPLE. . .

and reports back to you, the reader.

EVERY MONTH

**SOUND
&
COMMUNICATIONS,
THE INDUSTRY COMMUNICATOR**

Freeform

Bite?
This bit is no pussycat!

**FREEFORM
FLEXBIT
Ask For It.**

**Check Our
Prices!**

**35 ft. Stainless Steel
Carpet Snake
Available.**

**NEW!
TRY THIS!!
New High Speed
Steel Product with
Hole in Bit End!**

Call or write for additional information
Freeform R&D, 1539 Monrovia Ave., #23
Newport Beach, CA 92663 714/646-3217

Circle 285 on Reader Response Card

GEPCO INTERNATIONAL INC.

2225 West Hubbard
Chicago, IL 60612
(312) 733-9555 (800) 966-0069 FAX: (312) 733-6416
President: Gary R. Geppert; Chief Financial Officer: David B. Mecklenburger; Assistant to the President: Larry Smith, Sr.; Sales Manager: Larry Smith, Jr.
Gepco International Inc., Ocala, FL 904-368-1032
John Anthony, Stamford, CT 203-322-9202
PRODUCTS: cabinet hardware, cable clamps, cleaning chemicals, connectors, lamps, markers, panels, tool kits, wire terminators

J.H. Sessions & Son

273 Riverside Ave.
Bristol, CT 06010
Camden Marketing, Pierre Fonds, QU 514-683-3377

J.W. DAVIS AND CO.

3030 Canton Street
Dallas, TX 75226
(214) 651-7341 (800) 527-5705 FAX: (214) 939-0328
President: Harvey Earp; Vice President, Sales: Jack W. Tucker; Chief Engineer: Eric Simonson
Multi-Technical Reps., Brainerd, MN 218-828-9483
PRODUCTS: wire pulling devices

Lemo USA, Inc.

P.O. Box 11488
Santa Rosa, CA 95406
(707) 578-8811 (800) 444-5366 FAX: (707) 578-0869
General Manager: Sam Sokolik; Adv. Supervisor: Karen Beehler; Customer Service Supervisor: Debra Ward; Controller: Cheryl Powers;

Engineering Manager: Bill Lee; Cable Assembly Manager: John Connolly
Audio Etc., St. Peters, MO 314-278-4130
PRODUCTS: connectors

Meridian Technologies, Inc.

80 Mott Avenue
Inwood, NY 11696
(516) 371-9300 FAX: (516) 371-9301
President: Robert Klein; Director of Engineering: Jack Krol
Doug Warren, Newport News, VA 804-930-3217
PRODUCTS: cable testers, tool kits

Middle Atlantic Products

8 North Corporate Dr.
P.O. Box 29
Riverdale, NJ 07457
(201) 839-1011 FAX: (201) 839-1976
President: Bob Schluter; National Sales Mgr.: Eric Demarest; National Director Operations: Scott Mathews; Office Manager: Rosemarie Curti; West Coast Operations Mgr.: Sean Freida
Middle Atlantic Rack Distr., Haskell, NJ 201-839-2714
Middle Atlantic Western Distr., Moorepark, CA 805-529-6104
Audio Etc., St. Peters, MO 314-278-4130
PRODUCTS: cabinet hardware, panels

Miller-Stephenson Chemical

55 Backus Ave.
Danbury, CT 06810
(203) 743-4447 FAX: (203) 791-8702

Music Supply Company, Inc.

809 N. Madison
Dallas, TX 75208
(214) 946-8450 (800) 527-1522 FAX: (214) 946-9155
President: W.E. Brown; Sales: Betty Brown
Audio Etc., St. Peters, MO 314-278-4130
PRODUCTS: speaker hardware, wire pulling devices

Neutrik USA, Inc.

195-s3 Lehigh Ave.
Lakewood, NJ 08701
(908) 901-9488 FAX: (908) 901-9608
General Manager: James E. Cowan; Product Manager: Kenneth W. Smalley; Product Manager: William J. Dorman
Dimension/ Point IX, Lewisville, TX 214-436-3706
PRODUCTS: connectors, speaker hardware

Paladin Corp.

3543 Old Conejo Rd.
#101-102
Newbury Park, CA 91320
(805) 499-0318 (800) 272-8665 FAX: (805) 499-4006
Vice President & General Mgr: Phil Spillane; National Distribution Mgr.: Scott Allen; Product Line Marketing Mgr.: Laurence Danter
Dimension/ Point IX, Lewisville, TX 214-436-3706
PRODUCTS: cable testers, connectors, tool kits, wire terminators

COMPARE SPECS AND PRICES

Easy Comparison

Speakers

Company	Model	Specs	Price
Altec Lansing Corporation			
Celestion Industries, Inc.			
Celtec Cevas			
Electro-Voice			
EAW Eastern Acoustic Works			
Intersynics Servotronics			

The 1992 Music & Sound Buyer's Guide
It's the handiest reference you will find for model numbers, specs and list prices.

- Speakers
- Power Amps
- Microphones
- Signal Processors
- Mixing Consoles
- Sound Projection

... and musical instruments, too!

YES. I want the 1992 MUSIC & SOUND BUYER'S GUIDE for \$7.95, plus \$2.00 for postage and handling.

Payment enclosed

Bill my credit card Visa MC AmEx

Card # _____ Exp. Date _____

Name _____

Address _____

City _____ State _____ Zip _____

Signature _____

ORDER TODAY!

Mail to:
MUSIC & SOUND BUYER'S GUIDE
25 Willowdale Avenue
Port Washington, NY 11050
Att: Arturo Lizarraga

PEAVEY ELECTRONICS CORP.

711 A Street
P.O. Box 2898, Meridian, MS 39301
(601) 483-5365 FAX: (601) 484-4278
CEO: Hartley Peavey; President: Mella Peavey
Dimension/ Point IX, Lewisville, TX 214-436-3706
PRODUCTS: cabinet hardware, cable testers,
cleaning chemicals, connectors, fabrication
supplies, hanging systems, knobs, lamps, speaker
hardware

Penn Fabrication

2669 Guorn St.
Detroit, MI 48207
(313) 961-9111 FAX: (313) 567-1352
Dimension/ Point IX, Lewisville, TX 214-436-3706

R.B. Annis Co., Inc.

1101 N. Delaware Street
Indianapolis, IN 46202
(317) 637-9282 FAX: (317) 637-9282
President: R.B. Annis; Production Manager: R.D.
Hudson; Secretary: B. Hamdrick
Audio Etc., St. Peters, MO 314-278-4130

Seal-O-Matic Co.

900 Passaic Avenue
East Newark, NJ 07029
(201) 481-6500 (800) 631-2072 FAX: (201) 485-7818
President: Sam Ortnier; Vice President: Lee Chesin
Karp Communications, Tampa, FL 813-968-7098

Selco Products Company

7580 Stage Rd.
Buena Park, CA 90621
(213) 921-0681 FAX: (714) 739-1507
Sunrise Sales Company, LaMolle, IL 815-638-2660

SONANCE

961 Calle Negocio
San Clemente, CA 92672
(714) 492-7777 (800) 582-7777 FAX: (714) 361-2705
President: Scott Struthers; Vice President:
Geoff Spencer; Sales Manager: Dave Donald;
International Sales Manager: Mark Cichowski;
Public Relations Director: Mitch Simon; Dir. Sls
Trn. & Mkt. Research: Kevin Leja
Morris Tait and Assoc., Los Angeles, CA 213-877-4424
Bach Sales, New York, NY 212-727-0404
Tandem Marketing, Chicago, IL 708-605-1960
Dobbs Stanford, Dallas, TX 214-358-0800
Balaton Marketing, Washington DC, 202-471-
1764
MJA Marketing, St. Charles, MO 314-447-7111
PRODUCTS: connectors, wire terminators

**Find Your Suppliers in the
Sound & Communications
Blue Book**

SonIn Inc.

672 White Plains Road
Scarsdale, NY 10583
(914) 725-0202 (800) 223-7511 FAX: (914) 725-1158
President: Bob Pape; Director U.S. Sales: Al C.
Muto; Director International Sales: Farhad
Akhavi; Marketing Manager: Sharon Cadden;
Customer Service: Jean Fortunato
Bob Creeden & Assoc., Ltd., Winnetka, IL 708-441-
8815
T. Pressman & Assoc., Redmond, WA 206-883-
9444
Morem/Mudra Associates, Minneapolis, MN 612-
540-0762
Innovative Sakes & Marketing, Annapolis, MD 301-
757-9069
Karp Communications, Tampa, FL 813-968-7098

TEI Electronics Inc.

570 W. 18 St.
P.O. Box 246
Hialeah, FL 33011
(305) 888-3980 (800) 327-8811 FAX: (305) 885-4950
President: Danny Alonso; Vice President: Mireya
A. Muniz; National Sales Manager: Walter
McNulty; Customer Service: John Tembras;
Sales: Orlando Pineda; Sales: Jose Hurcades
Audio Blz, Mundellen, IL 708-949-0280
PRODUCTS: cabinet hardware, cleaning
chemicals, connectors, fabrication supplies,
hanging systems, lamps, speaker hardware, tool
kits, wire terminators

Texwipe

650 E. Crescent Ave.
Up. Saddle Riv., NJ 07458
(201) 327-9100 FAX: (201) 327-5945
Camden Marketing, Pierre Fonds, QU 514-683-
3377

T HE PERFECT MATCH.

**YOUR
RADIO
AND
OUR
NOISE ATTENUATING HEADSET.**

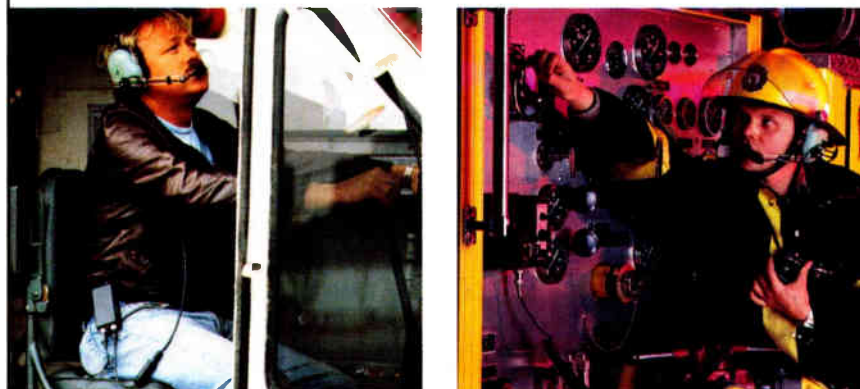

High noise can make two-way radio communication difficult, if not impossible. Combine your two-way radio with one of our Noise Attenuating Headsets to solve this problem.

David Clark Company Headsets combine maximum hearing protection, with comfort and perfect reception. Superior noise-canceling microphones deliver clear transmissions at normal voice levels.

NO RADIO MODIFICATIONS ARE NEEDED.

Choose between hands-free VOX (voice activated) or Push-To-Talk operation.

For more information, call or write.

 **David Clark COMPANY**
INCORPORATED

360 Franklin St., Box 15054, Worcester, MA 01615-0054 • (508) 756-6216 • Telex: 920482 • FAX: (508) 753-5827

Circle 252 on Reader Response Card

HEADPHONES & HEADSETS

ACS Communications

250 Technology Circle
Scotts Valley, CA 95066
(408) 438-3883 FAX: (408) 438-7730

AKG Acoustics, Inc.

1525 Alvarado Street
San Leandro, CA 94577
(510) 351-3500 FAX: (510) 351-0500
President (USA): S. Richard Ravich; Marketing
Manager: David Roubush; Vice President
Operations: Derek Pilkington; Director of
National Sales: David Angress; Sales Manager
(C&S America): Jesse Maxench
Jeff Radke, Midwest Reg. Mgr., Appleton, WI 414-
749-0044
Jim Burger, Philadelphia, PA 203-297-7160
PRODUCTS: boom-mic headsets,
communications headsets, personal/ stereo
headphones

Anixter Bros.

4711 Golf Rd.
One Concourse Plaza
Skokie, IL 60076
(708) 677-2600
J.B. Parent, Dublin, OH 614-764-0064

AUDIO-TECHNICA U.S., INC.

1221 Commerce Drive
Stow, OH 44224
(216) 686-2600 FAX: (216) 688-0719
Vice President, Marketing: Ken Reichel; National
Marketing Manager: Earl "Buzz" Goodwin;
National Sales Manager: Garry Elliott; Inside
Sales: Tony O'Keefe; Sales Coordinator: Kim
Wallace
Nova Marketing, San Francisco, CA 415-952-0943
PRODUCTS: boom-mic headsets, personal/
stereo headphones

Audlosears Corp.

2 South St.
Stamford, NY 12167
(607) 652-7305 (800) 533-7863 FAX: (607) 652-3653
Sales Manager: Fred Rosscoe; President & C.E.O.:
David E. Hartwell
J.B. Parent, Dublin, OH 614-764-0064
PRODUCTS: boom-mic headsets,
communications headsets, intercommunications
headsets, telecommunications headsets

beyerdynamic)))

5-05 Burns Ave., Hicksville, NY 11801
(516) 935-8000 FAX: (516) 935-8018
Vice President/ General Mgr.: Paul Murphy;
Marketing Manager: Michael Solomon; Service
Manager: Jim Hassel
Henderson Company, Concord, MA 508-287-0020
Applied Audio Marketing, Asheville, NC 704-252-9313
New Horizons, Bannockburn, IL 708-234-6500
Marcon, Irving, TX 214-869-0669
Derek Allen Associates, Burbank, CA 818-840-8327
Cambridge Marketing, Westerville, OH 614-363-9191
PRODUCTS: boom-mic headsets,
communications headsets, intercommunications
headsets, isolation headsets, personal/ stereo
headphones, telecommunications headsets

Danavox/Telecommunications Div.

6400 Flying Cloud Dr.
Minneapolis, MN 55344
(612) 941-0690

David Clark Company, Inc.

P.O. Box 15054, Worcester, MA 01615-0054
(508) 756-6216 FAX: (508) 753-5827
President: John E. Flagg; Sales Manager: Robert
J. Murphy; Assistant Sales Manager: George R.
Conlon
Donald D. Lister, Furlong, PA 215-343-5334
Barry Tennihan, Fayetteville, GA 404-461-2946
Raymond T. Gavin, Glenview, IL 708-657-7575
Ralph O. Chance, San Antonio, TX 512-654-7568
Mark C. Barrett, Redmond, WA 206-885-7431
Edwards Company, Inc., Livonia, MI 313-458-7777

BEAT IT!

Headsets and Belt-Packs take a
beating. It's in their job description.
Production Intercom Headsets
and Belt-Packs
are 'survivors'.
Ask us to
prove it.



**Production
Intercom**

Technical Projects, Inc.
P.O. Box 3247 Barrington, IL 60010
(708) 381-5350 Fax: (708) 381-4360

This magazine's got your name, your rank and your number.

The better we know you, the better our chances of writing articles you'll find relevant and useful. The same holds true for our advertisers.

Knowing who you are (your name, job title, company and industry) enables them to more easily develop messages which meet your informational requirements.

Circulation information helps advertisers determine who you are, what to say and where to say it. And since advertisers support our publication and allow us to keep bringing you high quality editorial, we think they deserve the most reliable and current circulation facts and figures available.

BPA (Business Publications Audit of Circulation, Inc.) helps us provide it. An independent, not-for-profit organization, BPA audits our circulation list once a year to verify that it's accurate and up to date.

The BPA audit makes sure our advertisers get the readers they pay for. And when advertisers get the readers they pay for, chances are they get the results they pay for, too.

BPA. For readers it stands for meaningful information. For advertisers it stands for meaningful readers. Business Publications Audit of Circulation, Inc.

360 Park Ave. So., New York, NY 10010.



We make sure you get what you pay for.

Circle 281 on Reader Response Card

FOSTEX CORPORATION OF AMERICA

15431 Blackburn Ave., Norwalk, CA 90650
(213) 921-1112 (800) 7-FOSTEX
FAX: (213) 802-1964

V.P. Marketing/ General Mgr.: Robert Veri; V.P. Sales: Mark Cohen
J.B. Parent, Dublin, OH 614-764-0064
PRODUCTS: boom-mic headsets, personal/ stereo headphones

HM ELECTRONICS, INC.

6675 Mesa Ridge Road, San Diego, CA 92121
(619) 535-6060 FAX: (619) 552-0139

General Sales Manager: Bruce Slemmer; Western Regional Sales Mgr.: David VanEpps; Midwest Regional Sales Mgr.: John Debrock; Eastern Regional Sales Mgr.: Mike Cerveny
Derek Allen Associates, Toluca Lake, CA 818-840-8327
A/V Marketing, Carmel, IN 317-846-1034
John B. Anthony Company, Stamford, CT 203-322-9202
ADCOM, Toronto, ON 416-251-3355

International Components Corp.

105 Maxess Road, Melville, NY 11747
(516) 293-1500 (800) 645-9154 FAX: (516) 293-4983
President: Mort Grossman; Executive Vice President: Irwin Friedman; Vice President: Fred Grossman; Eastern Regional Sales Mgr.: Ken Reed; Vice President: Harvey Grossman
C.B. Electronic Marketing, Arvada, CO 303-422-0561
PRODUCTS: personal/ stereo headphones

Koss Corporation

4129 N. Port Washington, Milwaukee, WI 53217
(414) 964-5000 (800) 872-5677 FAX: (414) 964-8615
Chairman of the Board: John C. Koss; President: Michael J. Koss; Vice President: Michael F. Moore; Vice President of Sales: John Koss Jr.; National Sales Manager: Paul Barragry
Koss Ltd., Ontario, CN 416-336-5224
Koss Europe, Stablo, SW 91-473822
PRODUCTS: personal/ stereo headphones

LIGHTSPEED TECHNOLOGIES, INC.

10101 S.W. Barbur Blvd. # 207
P.O. Box 19479
Portland, OR 97219
(503) 244-0608 (800) 732-8999 FAX: (503) 244-8527
President: Jerry Ramey; National Sales Manager: Mark Sheperd
Chuck Olson Assoc., Renton, WA 206-271-5416
PRODUCTS: personal/ stereo headphones

Metragen Ltd.

3701 Chesswood, #309, Downsview, ON M3J 2P6
(416) 635-9212 FAX: (416) 635-8266
Manager: Edward Wigdor
Cambridge Co., Niles, IL 708-647-8100
Audio Etc., St. Peters, MO 314-278-4130
PRODUCTS: Intercommunications headsets

Plantronics

345 Encinal Street
P.O. Box 635
Santa Cruz, CA 95061-0635
(408) 426-5858 (800) 544-4660 FAX: (408) 425-8654
CEO: Neil J. Hynes; President, General Manager: Robert Richardson; V.P., Sales and Marketing: Richard Sivertson
Cambridge Marketing, Westerville, OH 614-363-9191
PRODUCTS: boom-mic headsets, communications headsets, intercommunications headsets, telecommunications headsets

R-Columbia Products Co.

2008 St. Johns Ave.
Highland Park, IL 60035
(708) 432-7915 FAX: (708) 432-9181
President: Irving Rozak
Ed Hill & Assoc., Dataw Island, SC 803-838-3475
Zeeco Sales, Colleyville, TX 817-581-8179
Chas. Michel & Co, Encino, CA 818-788-3531
Camden Marketing, Pierre Fonds, QU 514-683-3377
PRODUCTS: boom-mic headsets, communications headsets, intercommunications headsets, isolation headsets, personal/ stereo headphones, telecommunications headsets

Roanwell Corp.

180 Varick St., New York, NY 10014
(212) 989-1090 FAX: (212) 989-3285
President: Kenneth R. Dobbins; Sales Manager: Ray F. LeFebvre
Camden Marketing, Pierre Fonds, QU 514-683-3377

RTS Systems, A Telex Comm. Company

9600 Aldrich Avenue South
Minneapolis, MN 55420
(612) 884-4051 FAX: (612) 884-0043
President: Jeffrey Wetherell; Vice President, Marketing: John Schofield; V.P. Engineering & Tech.: Joe Winebarger; Sales Manager: Murray Porteous; Director of Engineering: William Dennison
Dave Brand, Burbank, CA
Mike Guthrie, Wyckoff, NJ
Rick Fisher, Union Lake, MI
Sunrise Sales Company, LaMoille, IL 815-638-2660

Sennheiser Electronic Corp.

6 Vista Drive
P.O. Box 987, Old Lyme, CT 06371
(203) 434-9190 FAX: (203) 434-1759
President: Andrew Brakhan; Pro Products Manager: Albert C. Zang Jr.
MJA Marketing, St. Charles, MO 314-447-7111
PRODUCTS: boom-mic headsets, communications headsets, intercommunications headsets, isolation headsets, personal/ stereo headphones

Setcom Corporation

1400 No. Shoreline Boulevard
Mountain View, CA 94043
(415) 965-8020 FAX: (415) 965-1193
Sales Manager: Steve Kliczewski
Karp Communications, Tampa, FL 813-968-7098
PRODUCTS: boom-mic headsets, communications headsets, intercommunications headsets, telecommunications headsets

Sony Corp./Business & Pro. Aud. Grp

3 Paragon Drive
Montvale, NJ 07645-1735
(201) 930-1000
President, Sales & Marketing: Mark Gray; Senior VP Sales: C.F. Taylor; V.P. Product Marketing: Anthony Gargano; Marketing Manager, Pro Audio: Courtney Spencer; Sales Manager, Pro Audio: Gary Rose; V.P. Audio Products: Ron Remschel
Matt Robertson, Western Dist., 213-469-9084
Audio Etc., St. Peters, MO 314-278-4130

Sound Powered Communications

335 Robbins Ave.
Trenton, NJ 08638
(609) 883-1180 FAX: (609) 883-1181

Starkey Labs & Telecommunications

P.O. Box 9457
Minneapolis, MN 55440
(612) 941-6401 FAX: (612) 828-9173
Karp Communications, Tampa, FL 813-968-7098

Systems Wireless, Ltd.

465 Herndon Parkway
Herndon, VA 22070
(703) 471-7887 (800) 542-3332 FAX: (703) 437-1107
President: Theodore Bennett; Vice President: William Sien; Sales Engineer- Wireless: John Kowalski; Sales Engineer- Intercom: Pat Hamp; Rental Manager: Tom Conner; Service Manager: Jim Cohlil
Sound Sales, Inc., Columbia, MD 301-964-1170
PRODUCTS: boom-mic headsets, communications headsets, intercommunications headsets, telecommunications headsets

Technical Projects, Inc.

P.O. Box 3247
Barrington, IL 60010
(708) 381-5350 (800) 562-5872 FAX: (708) 381-4360
President: Glenn Mullis; Secretary/Treasurer: Sibbellina Mullis; Tech.: Mike Barrett
Watt Marketing, Allentown, PA 215-820-7586
Professional Audio Marketing, Melville, NY 516-367-8620
Audio Marketing Associates, Brecksville, OH 216-526-2426
Professional Sound & Lighting, Lakewood, CO 303-986-5999
JMS Marketing, Austin, TX 512-266-1113
PRODUCTS: boom-mic headsets, communications headsets, intercommunications headsets, personal/ stereo headphones, telecommunications headsets

Television Equipment Assoc., Inc.

P.O. Box 393
S. Salem, NY 10590
(914) 763-8893 FAX: (914) 763-9158
President: Bill Pegler; Manager: Steve Tocldowski
JMS Marketing, Austin, TX 512-266-1113
PRODUCTS: boom-mic headsets, communications headsets, intercommunications headsets, isolation headsets, telecommunications headsets

**Subscribe to
Sound &
Communications
Magazine**

TELEX COMMUNICATIONS, INC.

9600 Aldrich Avenue South
 Minneapolis, MN 55420
 (612) 884-4051 FAX: (612) 884-0043
 President: Jeffrey Wetherell; Vice President
 Marketing: John Schofield; Vice President Sales:
 Dan Dantzler;
 Director of Marketing: Don Merein;
 Manager/Advertising & Mkt'g: Ron Taylor
 WesTech Marketing, Culver City, CA 213-870-9286
 Bencsik Associates, Ocala, FL 904-732-9775
 Burcaw Company & Associates, Warren, MI
 313-573-4605
 SAGA, Oswego, NY 315-343-5739
 Monfort Electronic Marketing, Indianapolis, IN
 317-872-8877
 Murphy & Cotta, Inc., Atlanta, GA
 404-875-2525
 Northland Associates, Moorhead, MN
 218-233-4616
 Rancillo Associates, Inc., St. Louis, MO
 314-845-0202
 J.Y. Schoonmaker Company, Dallas, TX
 214-349-1650
 Sigmnet Corporation, Valley Forge, PA
 215-783-6666
 Weller Electronic Sales, Worthington, OH 614-
 885-7819
 Ziskind Associates, Rolling Meadows, IL
 312-577-1624
 White Radio Ltd., Burlington, ON 416-632-6894
 Silver Peak Marketing, Denver, CO 303-467-9042
 PacNor Marketing, Lynnwood, WA 206-771-6016
 PRODUCTS: boom-mic headsets,
 communications headsets, intercommunications
 headsets, isolation headsets, personal/ stereo
 headphones, telecommunications headsets

The Music People, Inc.

2074 Park St.
 Hartford, CT 06106
 (203) 236-7134 (800) 289-8889 FAX: (203) 233-6888
 President: James R. Hennessey; Controller:
 John Gutowski; Import/Export Manager: Kelly
 Heintz; Purchasing Manager: Paul Thaxton
 West Coast Warehouse Facility, Los Angeles, CA

PRODUCTS: boom-mic headsets,
 communications headsets, intercommunications
 headsets, isolation headsets, personal/ stereo
 headphones, telecommunications headsets

The Sandell Company

24808 Aden Ave.
 Newhall, CA 91321
 (805) 259-0108 FAX: (805) 259-0108
 President: Robert W. Sandell; Executive Vice
 President: Cynthia P. Sandell; Vice President,
 Operations: Lillian R. Cory
 Camden Marketing, Pierre Fonds, QU 514-683-
 3377

Want more information on **SOUND** COMMUNICATIONS Advertisers?

JUST FILL OUT THE

FAST ACTION CARD



**Circle the reader service number
 you'll find on the ad and
 mail by 12/1/91**

— OR —

**Call the Company today...
 And when you call, say
 you saw it in the
 BLUE BOOK!**

Subscribe to
Sound & Communications
 Magazine

TOA ELECTRONICS, INC.

601 Gateway Blvd. Suite 300
P.O. Box 2047
S San Francisco, CA 94080
(415) 588-2538 (800) 733-4750 FAX: (415) 588-3349
President: Yoshiro Ishida; Director, Audio Products Div: Richard Krochmal; Director, Comm. Systems Div.: Al Burns; Mgr., Marketing Development: Jeff Pallin; Manager, Western Division: Bill Ford; Manager Engineering Services: Bob Sweet
Chuck McGregor- Product Constt, Morris Plains, NJ 201-829-7047
John Murray-Eng.Snd. Mktg. Dev, Springfield, OH 513-324-1993
Bob Hager-Eastern Regional Mgr, Rosewell, GA 404-552-7624
Linda Wick-Central Reg. Mgr., Kansas City, MO 816-453-5775
Robert Slaughter-Cntrl DIV Mgr, Houston, TX 713-460-3678
Pete Newmark-West Regional Mgr., Mesa, AZ 602-981-0050
Walter Best, Eastern Reg. Mgr., Sussex, NJ 201-702-0068
PRODUCTS: boom-mic headsets

Unex Corp.

27 Industrial Avenue, Chelmsford, MA 01824
(508) 256-8222 (800) 345-8639 FAX: (508) 250-9055
President: John Ela; Vice Pres. Mktg & Sales: Peter McHugh
Unex Corporation, Chicago, IL 708-382-5522
Unex, Atlanta, GA 404-928-0057
Camden Marketing, Pierre Fonds, QU 514-683-3377

Vidicraft

0704 SW Bancroft St.
Portland, OR 97201 (800) 547-1491 FAX: (503) 243-1995

YAMAHA CORP. OF AMERICA

6600 Orangethorpe Ave.
Buena Park, CA 90620
(714) 522-9011 FAX: (714) 739-2680
Sales & Marketing Manager: Gerald W. Tschetter;
Pro Digital Sls & Mktg Mgr.: Peter Chalkin;
Market Support Manager: Don Bowles
Precide, Morbio Inferiore, Switzerland, 914-31734
PRODUCTS: personal/ stereo headphones

**Brahler**

12073 Tech Rd.
Silver Spring, MD 20904
(301) 680-9658 (800) 635-7515 FAX: (301) 680-9245
President: Jack Cassell; Vice President: Michael Bler

**Comtek**

357 West 2700 South, Salt Lake City, UT 84115
(801) 466-3463 FAX: (801) 484-6906
President: Ralph Belgique; Applications Engineering: Steve Kartchner; Applications Engineering: Steve Dupalx; Service Manager: Laurel Robertson; Credit Manager: Dana Pelletier
Edwards Company, Inc., Livonia, MI 313-458-7777
PRODUCTS: wireless systems AM/FM

J.W. DAVIS AND CO.

3030 Canton Street, Dallas, TX 75226
(214) 651-7341 (800) 527-5705 FAX: (214) 939-0328
President: Harvey Earp; Vice President, Sales: Jack W. Tucker; Chief Engineer: Eric Simonson
Multi-Technical Reps., Brainerd, MN 218-828-9483
PRODUCTS: wireless systems AM/FM

OVAL WINDOW AUDIO

78 Main Street, Yarmouth, ME 04096
(207) 846-6250 FAX: (207) 846-6250
Director: Norman Lederman; Educational Director: Paula Hendricks
Loomis and Associates, Fremont, CA 415-683-0883
PRODUCTS: closed loops inductive

**Phonic Ear Inc.**

3880 Cypress Drive
Petaluma, CA 95954-7600
(707) 769-1110 (800) 227-0735 FAX: (707) 769-9624
President & CEO: James C. Mulford; V.P., Sales & Marketing: Richard G. Pimentel; Director of Business Dev.: Richard L. Steighner; V.P., Technical Operations: Gene Strohallen; Project Engineer: Lee Henderson
Phonic Ear Eastern Region, Columbia, MD 301-725-8883
Phonic Ear Ltd., Mississauga, ON 416-677-3231
Dimension/ Point IX, Lewisville, TX 214-436-3706
PRODUCTS: closed loops inductive, infrared systems, multi-channel processors, programmable, wireless systems AM/FM

RTS Systems, A Telex Comm. Company

9600 Aldrich Avenue South
Minneapolis, MN 55420
(612) 884-4051 FAX: (612) 884-0043
President: Jeffrey Wetherell; Vice President, Marketing: John Schofield; V.P. Engineering & Tech.: Joe Winebarger; Sales Manager: Murray Porteous; Director of Engineering: William Dennison
Dave Brand, Burbank, CA
Mike Guthrie, Wyckoff, NJ
Rick Fisher, Union Lake, MI
Sunrise Sales Company, LaMoille, IL 815-638-2660

Schell Electronics, Inc.

120 N. Lincoln
Chanute, KS 66720
(316) 431-2350 FAX: (316) 431-2365
President: Jerry Schell; Secretary/Treasurer (Sales): Janice Schell
Cambridge Marketing, Westerville, OH 614-363-9191
PRODUCTS: wireless systems AM/FM

Sennhelsler Electronic Corp.

6 Vista Drive
P.O. Box 987
Old Lyme, CT 06371
(203) 434-9190 FAX: (203) 434-1759
President: Andrew Brakhan; Pro Products Manager: Albert C. Zang Jr.
MJA Marketing, St. Charles, MO 314-447-7111
PRODUCTS: closed loops inductive, infrared systems, multi-channel processors, wireless systems AM/FM

Siemens Hearing Instruments

10 Corporate Place S.
Piscataway, NJ 08854
(201) 562-6600 FAX: (201) 562-6696
Camden Marketing, Pierre Fonds, QU 514-683-3377

Sell Front Row Tickets to Every Seat!



This new inexpensive hearing assistance system is easy to install, operate and maintain.



Call Now!

800/227-0735 US
800/772-3374 CA

Phonics Ear

Circle 290 on Reader Response Card



Sennheiser Infrared Quality · Fidelity · Reliability

The sophisticated solution for as-
sistive listening and multilingual
wireless transmission. Simple to
install, simple to operate, very ele-
gant – and free from the inter-
ference that plagues other
systems. From Broadway
to the living room,
Sennheiser infrared
is the mark of
excellence.



SENNHEISER ELECTRONIC CORPORATION

6 Vista Drive, P.O. Box 987, Old Lyme, CT 06371
(203) 434-9190 FAX# (203) 434-1759
Manufacturing Plant: D-3002 Wedemark,
Federal Republic of Germany

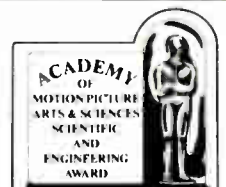

TELEX COMMUNICATIONS, INC.

9600 Aldrich Avenue South
 Minneapolis, MN 55420
 (612) 884-4051 FAX: (612) 884-0043
 President: Jeffrey Wetherell; Vice President
 Marketing: John Schofield; Vice President Sales:
 Dan Dantzler; Director of Marketing: Don
 Meeen; Manager/Advertising & Mkt'g: Ron
 Taylor
 WesTech Marketing, Culver City, CA 213-870-9286
 Bencsik Associates, Ocala, FL 904-732-9775
 Burcaw Company & Associates, Warren, MI 313-
 573-4605
 SAGA, Oswego, NY 315-343-5739
 Monfort Electronic Marketing, Indianapolis, IN
 317-872-8877
 Murphy & Cotta, Inc., Atlanta, GA 404-875-2525
 Northland Associates, Moorhead, MN 218-233-
 4616
 Rancillo Associates, Inc., St. Louis, MO 314-845-
 0202
 J.Y. Schoonmaker Company, Dallas, TX 214-349-
 1650
 Sigmnet Corporation, Valley Forge, PA 215-783-
 6666
 Weller Electronic Sales, Worthington, OH 614-
 885-7819
 Ziskind Associates, Rolling Meadows, IL 312-577-
 1624
 White Radio Ltd., Burlington, ON 416-632-6894
 Silver Peak Marketing, Denver, CO 303-467-9042
 PacNor Marketing, Lynnwood, WA 206-771-6016
 PRODUCTS: multi-channel processors, wireless
 systems AM/FM

Vista Group International Inc.

10 Corbin Dr.
 P.O. Box 1622
 Darien, CT 06820
 (203) 656-1818 FAX: (203) 655-2113
 President: Noel A. Yaney
 Precide, Morbio Inferiore, Switzerland, 914-
 31734
 PRODUCTS: closed loops inductive, infrared
 systems, multi-channel processors

Williams Sound Corp.

10399 W. 70th St.
 Eden Prairie, MN 55344
 (612) 943-2252 (800) 328-6190 FAX: (612) 943-2174
 President: James M. Broz; Vice President of
 Marketing: Paul Ingebrigtsen; National Sales
 Manager: Todd Bergum; Customer Service
 Manager: Barb Gudnecht; Vice President,
 Engineering: Jay Kershaw
 J.B. Parent, Dublin, OH 614-764-0064
 PRODUCTS: Infrared systems, multi-channel
 processors, programmable, wireless systems
 AM/FM

**Order the 1992
 Music & Sound Buyer's
 Guide now!**



Alphone Corp.

1700 130th Ave. NE
 Bellevue, WA 98005
 (206) 455-0510 FAX: (206) 455-0071
 President: Jun Matsumoto; Vice President,
 Marketing: Harry Quanz; Vice President, Sales:
 Jim Morrison; Residential Sales Manager:
 Stephen Birgh; Commercial Sales Manager: John
 Mosebar
 Alphone East Coast Reg. Office, Rochelle Park, NJ
 201-843-6115
 Precide, Morbio Inferiore, Switzerland, 914-
 31734
 PRODUCTS: telephone reporting

Audio Systems Co.

1815 Michigan Ave.
 Bismarck, ND 58504
 (701) 223-3800 (800) 852-6522 FAX: (701) 222-8102
 President: Lynn Mader; Vice President: Lyle
 Mader
 Leslie Inc., Elgin, IL 708-697-6677
 Doug Warren, Newport News, VA 804-930-3217
 PRODUCTS: manual personnel, visual

Com-Tec Inc.

3000 N. Pointe Rd.
 Appleton, WI 54915
 (414) 749-2840 FAX: (414) 749-2848
 Co-Owner — President: Ken McLellan; Co-Owner
 — Vice-President: Tony Leslie
 Vector Corp., Seattle, WA 206-368-8400
 PRODUCTS: PC-based

Cornell Electronic Products, Inc.

4911 W. Good Hope Road
 P.O. Box 23411
 Milwaukee, WI 53223-0411
 (414) 351-4660 FAX: (414) 351-4657
 President: Donald J. Glaubitz; Vice President:
 Gary M. Butler; Sales Manager: Pauline A. Haack;
 Accounting: Thelma M. Plunkett; Production
 Manager: Joel Karls
 Richard S. Pass Associates, Philadelphia, PA 215-
 757-6100
 Dick Bellew Sales, Dallas, TX 214-644-7881
 Winchester Electronic Sales, Atlanta, GA 404-392-
 0200
 Cartwright & Bean, Orlando, FL 407-889-9100
 Rancillo Associates, St. Louis, MO 314-845-0202
 Vector Corp., Seattle, WA 206-368-8400
 Kingston Sales, Indianapolis, IN 317-876-2545
 Bidwell-Schwartz Associates, Gardena, CA 213-
 770-0300
 Yocum Marketing, Mesa, AZ 602-834-3334
 Avcom, Inc., North Olmstead, OH 216-777-2060
 Kodo Associates, Minneapolis, MN 612-881-1255
 W.A. Hendrickson Co., North Scituate, MA 617-
 545-0652
 LSM Associates, Phelps, NY 315-548-4891
 R & S Sales, Rockville Ctr., NY 516-678-6887
 PRODUCTS: access control, manual personnel

Edstan, Inc.

14120 Live Oak Ave.
 Baldwin Pk., CA 91706 (800) 423-4765 FAX: (818)
 337-3796
 President: David Verner
 PRODUCTS: medical, PC-based, telephone
 reporting

**EXI ELECTRONICS
 MANUFACTURING**

803 Erin St.
 Winnipeg, MB R3G 2W2
 (204) 453-0573 FAX: (204) 775-1165
 Sales Engineer: Mort Larsen; R & D Engineer:
 Vladimir Federman; Marketing: Les Toutant
 Doug Warren, Newport News, VA 804-930-3217
 PRODUCTS: manual personnel, medical, monitor
 reporting

Fisher Berkeley Corporation

955 Third St.
 Oakland, CA 94607
 (415) 835-7575 FAX: (415) 271-8297
 President: Robert S. Fisher; Sr. Vice President:
 Wood H. Wymond; Vice President-Engineering:
 Robert T. Shipley; Sales Coordination Manager:
 Richard V. Flanagan; Sales Engineer: Michael D.
 Lagrimas; Sales Engineer: Michael J. Mack
 Arthur E. Tilley, Jr., Fayetteville, PA 717-352-8432
 John D. Larounis, Barrington, IL 708-382-8233
 John Corrigan, Corrigan Agency, Covington, LA
 504-893-7455
 Greg Dzubay & Assoc., Glendale, AZ 800-999-0006

Jeron Electronic Systems, Inc.

1743 W. Rosehill Drive
 Chicago, IL 60660
 (312) 275-1900 (800) 621-1903 FAX: (312) 275-0283
 President: Jerome Chesnul; Vice President:
 Matthew Chesnul; Secretary: Elizabeth Chesnul
 ADCOM, Toronto, ON 416-251-3355
 PRODUCTS: manual personnel, medical, monitor
 reporting, visual

LEE DAN COMMUNICATIONS, INC.

155 Adams Avenue
 Hauppauge, NY 11788-3699
 (516) 231-1414 (800) 533-3261 FAX: (516) 231-1498
 President: Leon Goldberg; Vice President
 Operations: Lawrence J. Goldberg; V.P. Finance &
 Administration: David H. Goldberg; Senior
 Technician: Sanford Hoffman; Office Manager:
 Rita Kaplan; Sr. Sales/Service Associate: Susan
 Leon
 C.L. Pugh & Associates, Cleveland, OH 216-238-
 1777
 PRODUCTS: access control, intercom, manual
 personnel, medical, visual

Marsh Products

336 McKee St.
 Batavia, IL 60510
 (708) 879-8008 (800) 833-7219 FAX: (708) 879-8072
 Vice President, Mktg & Sales: Paul Anderson
 Doug Warren, Newport News, VA 804-930-3217
 PRODUCTS: access control, manual personnel,
 medical, monitor reporting, PC-based, telephone
 reporting, terminal reporting, visual

RING COMMUNICATIONS INC.

57 Trade Zone Drive
Ronkonkoma, NY 11779
(516) 585-7464 FAX: (516) 585-7410
President: Peter McLean; Vice President: Craig Krsanac; Vice President: Kjell (Ken) Solem
Monfort Electronic Marketing, Indianapolis, IN
317-872-8877
EESCO Systems, Inc., Los Angeles, CA 213-666-9601
Klumpp Sales Company, Jacksonville, FL 904-287-5205
The TK Group, Inc., Loveland, CO 303-669-1008
Awrest, Inc., Fountain Hills, AZ 602-946-1811
Gustafson Sales Company, Red Wing, MN 612-388-4277
Corrigan Agency, Covington, LA 504-893-7455
Pacnor Marketing, Lynnwood, WA 206-771-6016
Kaltec Communications, N. Vancouver, BC 604-987-1597

TALK-A-PHONE CO.

5013 N. Kedzie Ave.
Chicago, IL 60625
(312) 539-1100 FAX: (312) 539-1241
Vice President: Samuel Shanes; Sales Manager: Dan F. Kagan; President: Z. Liberman
JMS Marketing, Austin, TX 512-266-1113
PRODUCTS: access control, Intercom

TOA ELECTRONICS, INC.

601 Gateway Blvd. Suite 300
P.O. Box 2047
San Francisco, CA 94080
(415) 588-2538 (800) 733-4750 FAX: (415) 588-3349
President: Yoshiro Ishida; Director, Audio Products Div: Richard Krochmal; Director, Comm. Systems Div.: Al Burns; Mgr., Marketing Development: Jeff Pallin; Manager, Western Division: Bill Ford; Manager Engineering Services: Bob Sweet
Chuck McGregor- Product Const, Morris Plains, NJ 201-829-7047
John Murray-Eng.Snd. Mktg. Dev, Springfield, OH 513-324-1993
Bob Hager-Eastern Regional Mgr, Rosewell, GA 404-552-7624
Linda Wick-Central Reg. Mgr., Kansas City, MO 816-453-5775
Robert Slaughter-Cntrl Div Mgr, Houston, TX 713-460-3678
Pete Newmark-West Regional Mgr., Mesa, AZ 602-981-0050
Walter Best, Eastern Reg. Mgr., Sussex, NJ 201-702-0068
PRODUCTS: access control, Intercom, manual personnel, PC-based

**Subscribe to
Sound & Communications
Magazine**

**Alphone Corp.**

1700 130th Ave. NE, Bellevue, WA 98005
(206) 455-0510 FAX: (206) 455-0071
President: Jun Matsumoto; Vice President, Marketing: Harry Quanz; Vice President, Sales: Jim Morrison; Residential Sales Manager: Stephen Birgh; Commercial Sales Manager: John Mosebar
Alphone East Coast Reg. Office, Rochelle Park, NJ 201-843-6115
Precide, Morbio Inferiore, Switzerland, 914-31734
PRODUCTS: access control, apartment station, custom, duplex, lobby, mailbox panels, microprocessor, panel/ entrance, simplex, talk-back, telephone, video

Alpha Communications

89-D Cabot Court, Hauppauge, NY 11788-3717
(516) 434-8080 (800) 666-4800 FAX: (516) 434-8334
President: Mark S. Goldberg; Vice President: Madelyn R. Goldberg; Office Manager: Rose Tassone
Sound Sales, Inc., Columbia, MD 301-964-1170
PRODUCTS: access control, apartment station, custom, duplex, lobby, mailbox panels, microprocessor, panel/ entrance, simplex, talk-back, telephone, video

Bogen Communications, Inc.

50 Spring Street
P.O. Box 575, Ramsey, NJ 07446
(201) 934-8500 FAX: (201) 934-9832
President: John H. Ochtera; Vice President, Sales & Mktg: David A. Chambers
Scott Whipple, Columbus, OH 614-272-1689
Sam Blasl, Ramsey, NJ 201-934-8500
Walter Spencer, Ramsey, NJ 201-934-8500
Fred Yosenick, Woodland, CA 916-668-6311
Edwards Company, Inc., Livonia, MI 313-458-7777
PRODUCTS: apartment station, duplex, talk-back, telephone

Cornell Electronic Products, Inc.

4911 W. Good Hope Road
P.O. Box 2341, Milwaukee, WI 53223-0411
(414) 351-4660 FAX: (414) 351-4657
President: Donald J. Glaubitz; Vice President: Gary M. Butler; Sales Manager: Pauline A. Haack; Accounting: Thelma M. Plunkett; Production Manager: Joel Karis
Richard S. Pass Associates, Philadelphia, PA 215-757-6100
Dick Bellew Sales, Dallas, TX 214-644-7881
Winchester Electronic Sales, Atlanta, GA 404-392-0200
Cartwright & Bean, Orlando, FL 407-889-9100
Rancillio Associates, St. Louis, MO 314-845-0202
Vector Corp., Seattle, WA 206-368-8400
Kingston Sales, Indianapolis, IN 317-876-2545
Bidwell-Schwartz Associates, Gardena, CA 213-770-0300
Yocum Marketing, Mesa, AZ 602-834-3334
Avcorn, Inc., North Olmstead, OH 216-777-2060
Kodo Associates, Minneapolis, MN 612-881-1255
W.A. Hendrickson Co., North Scituate, MA 617-545-0652

LSM Associates, Phelps, NY 315-548-4891
R & S Sales, Rockville Ctr., NY 516-678-6887
PRODUCTS: access control, apartment station, custom, lobby, panel/ entrance, talk-back

Doorking, Inc.

120 Glasgow Avenue
Inglewood, CA 90301
(213) 645-0023 (800) 826-7493 FAX: (213) 645-7431
President: M.K. Richmond; Vice President: Tom Richmond; Chief Engineer: Patrick Kochle; Sales Director: Dusty Beeding; Marketing Director: Scott Holmes; Chief Electronics Programmer: Suzle Richmond
Mike Bevan/ Doorking East, Moorestown, NJ 609-273-9206
Garreau & Associates, Atlanta, GA 404-343-8036
Edwards Company, Inc., Livonia, MI 313-458-7777
PRODUCTS: access control, apartment station, lobby, mailbox panels, panel/ entrance, telephone

ERL Electronic Products, Inc.

65-50 Austin Street
Rego Park, NY 11374
(718) 275-7700 FAX: (718) 997-7645
Vice President: Steve Faulhaber; Director of Sales: Martin Saltiel
Doug Warren, Newport News, VA 804-930-3217

Fanon Courier

14811 Myford Road
Tustin, CA 92680
(714) 669-9890 (800) 345-1354 FAX: (714) 669-1081
President: Frank Blaha; Director Sales & Marketing: Murray Trotiner; Director of Engineering: Miguel Santana
Greg Dzubay & Assoc., Glendale, AZ 800-999-0006

Fisher Berkeley Corporation

955 Third St.
Oakland, CA 94607
(415) 835-7575 FAX: (415) 271-8297
President: Robert S. Fisher; Sr. Vice President: Wood H. Wymond; Vice President-Engineering: Robert T. Shipley; Sales Coordination Manager: Richard V. Flanagan; Sales Engineer: Michael D. Lagrimas; Sales Engineer: Michael J. Mack
Arthur E. Tilley, Jr., Fayetteville, PA 717-352-8432
John D. Larounis, Barrington, IL 708-382-8233
John Corrigan, Corrigan Agency, Covington, LA 504-893-7455
Greg Dzubay & Assoc., Glendale, AZ 800-999-0006

Florence Manufacturing Co.

2101 N. Elston Avenue
Chicago, IL 60614
(312) 384-3310 FAX: (312) 384-3460
Chairman: Lloyd A. Schooley; President: Michael Gloseff, Sr.; Vice President/General Mgr.: Michael Gloseff, Jr.; Manager of Elec. Development: Raymond Cozzens; Controller: James Glerek
Beaver Technical Sales, Washington DC, 202-362-6185
Current Sales Assoc., Dedham, MA 617-320-0444
LGL Associates, Northbrook, IL 708-272-8500
Vector Corporation, Seattle, WA 206-368-8400
Multi-Technical Reps, Brainerd, MN 218-828-9483
Greg Dzubay & Assoc., Glendale, AZ 800-999-0006

Housing Devices Inc.

407 R. Mystic Avenue
Medford, MA 02155
(617) 395-5200 FAX: (617) 395-3793
ADCOM, Toronto, ON 416-251-3355

HOME . . .

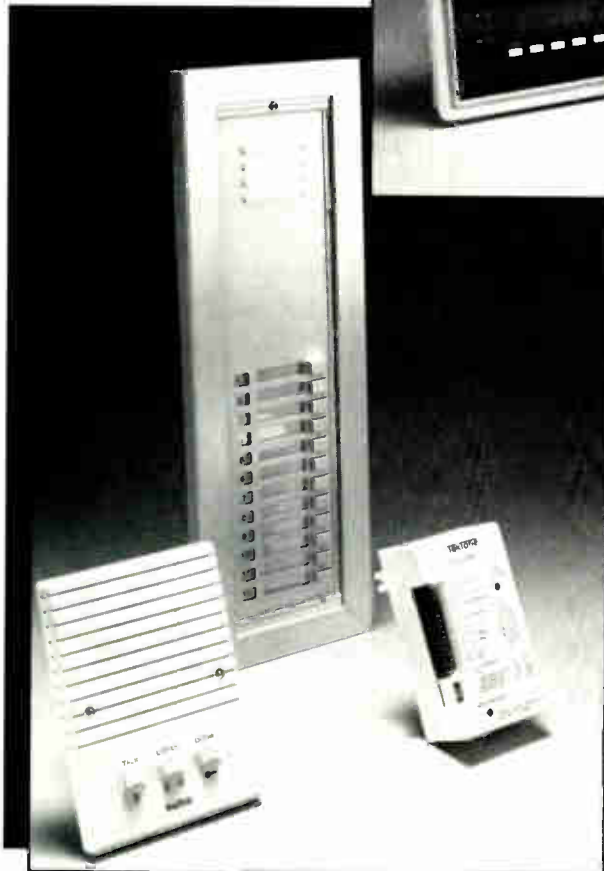

APARTMENT . . .



OFFICE . . .



...clearly the best.

. . . TekTone® has it all!

1331 South Killian Drive
Lake Park, Florida 33403-0427
Phone: (407) 844-2383
Fax: (407) 845-1587
Toll Free Order Desk: (800) 327-8466

27 Industrial Park Drive
Franklin, North Carolina 28734
Phone: (704) 524-9967
Fax: (704) 524-9968
Toll Free Oder Desk: (800) 448-1811

J.W. DAVIS AND CO.

3030 Canton Street
 Dallas, TX 75226
 (214) 651-7341 (800) 527-5705 FAX: (214) 939-0328
 President: Harvey Earp; Vice President, Sales:
 Jack W. Tucker; Chief Engineer: Eric Simonson
 Multi-Technical Reps., Brainerd, MN 218-828-9483
 PRODUCTS: access control, apartment station,
 panel/ entrance, talk-back, video

**Jeron Electronic Systems, Inc.**

1743 W. Rosehill Drive
 Chicago, IL 60660
 (312) 275-1900 (800) 621-1903 FAX: (312) 275-0283
 President: Jerome Chesnul; Vice President:
 Matthew Chesnul; Secretary: Elizabeth Chesnul
 ADCOM, Toronto, ON 416-251-3355
 PRODUCTS: access control, apartment station,
 custom, duplex, lobby, microprocessor, panel/
 entrance, simplex, talk-back

**LEE DAN COMMUNICATIONS, INC.**

155 Adams Avenue
 Hauppauge, NY 11788-3699
 (516) 231-1414 (800) 533-3261 FAX: (516) 231-1498
 President: Leon Goldberg; Vice President
 Operations: Lawrence J. Goldberg; V.P. Finance &
 Administration: David H. Goldberg; Senior
 Technician: Sanford Hoffman; Office Manager:
 Rita Kaplan; Sr. Sales/Service Associate: Susan
 Leon
 C.L. Pugh & Associates, Cleveland, OH 216-238-
 1777
 PRODUCTS: access control, apartment station,
 custom, duplex, lobby, mailbox panels,
 microprocessor, music combination, panel/
 entrance, simplex, talk-back, telephone, video

M & S Systems, Inc.

2861 Congressman Lane
 Dallas, TX 75220
 (214) 358-3196 (800) 877-6631 FAX: (214) 350-1913
 Vice President: Steven C. Pickert; President:
 Richard Denman; Manager, Customer Service:
 Scott Mattingly; Manager, Quality Control: Rusty
 Cone
 Gary Lakey, Los Angeles, CA 619-438-7000
 Mike Malec, San Francisco, CA 619-438-7000
 Bob McNellis, Chicago, IL 708-460-6907
 Paul Dorschell, Detroit, MI 313-533-2124
 Don Downing, Tampa, FL 813-862-8308
 Audio Etc., St. Peters, MO 314-278-4130
 PRODUCTS: music combination

Mircom Communication & Security Inc

429 Alness Street
 Downsview, On M3J 2H4
 (416) 665-4301 FAX: (416) 665-2825
 President: Larry Letofsky; National Sales
 Manager: Art Petrilli
 Mircom Communications, Van Nuys, CA 818-902-
 0554
 Designed Products Group, Clinton, NJ 201-730-
 7360
 Gustafson Sales, Redwing, MN 612-388-4277
 Corrigan Agency, Covington, LA 504-893-7453
 Pacnor Marketing Inc., Lynwood, WA 206-771-
 6016
 Audio Etc., St. Peters, MO 314-278-4130

Paso Sound Products, Inc.

14 First Street
 Pelham, NY 10803
 (914) 738-4800 (800) 231-3034 FAX: (914) 738-3954
 Executive Vice President: Paul Mastrangelo;
 Product Manager: Ken O'Brien; Credit Manager:
 Marilyn Beckerson; Operations Manager:
 Anthony Squegila
 Anderson Sales, Braintree, MA 617-848-9194
 Jack Mesnick Sales, Liverpool, NY 315-622-3211
 Palmieri Associates, Fairfield, NJ 201-882-1266
 Weller Electronic Sales, Inc., Worthington, OH
 614-885-7819
 Llenau Associates, Columbia, MD 301-621-4113
 MJA Marketing, St. Charles, MO 314-447-7111
 Northland Assoc., Moorehead, MN 218-233-4616
 Allwest Sound & Communication, Camarillo, CA
 805-388-7745
 Dimension Pt. IX Marketing, Katy, TX 713-578-9277
 Mountain Representatives, Denver, CO 303-333-
 7745
 Miguel Lopez, Hialeah, FL 305-822-6853
 Paco Electronics, Ltd., Markham, ON 416-475-0740
 Robert Milsk Co., Southfield, MI 313-354-3310
 Marketline Inc., Snellville, GA 404-972-9048
 Hawkins-Frederickson Assoc., Maitland, FL 407-
 831-2474
 Lintern Associates, Naperville, IL 708-904-1225
 Robert Milsk Co., Indianapolis, IN 317-842-3400
 PRODUCTS: apartment station, lobby, panel/
 entrance, telephone, video

Select Engineered Systems

7991 W. 26th Ave.
 Hialeah, FL 33016
 (305) 823-5410 (800) 342-5737 FAX: (305) 823-5215
 President: John Sheppard I; Executive V.P.,
 Engineering: Carl "Rick" Muller; Vice President,
 Sales: John Holloway; Sales Administrator: Jay
 Vaz; Regional Sales Manager: Felix Placer;
 Operations Manager: John Sheppard II
 Pass Associates, Philadelphia, PA 215-757-6100
 G. Duvall Associates, Chicago, IL 312-774-5115
 Rancillo Associates, St. Louis, MO 314-845-0202
 Graham-Davis, Houston, TX 713-558-8662
 Esro/D. Lentmeyer, Tampa, FL 813-968-3559
 Camden Marketing, Pierre Fonds, OU 514-683-
 3377

Siedle Communication Sys of America

780 Parkway
 Broomall, PA 19008
 (215) 353-9595 FAX: (215) 353-9716
 Karp Communications, Tampa, FL 813-968-7098
 PRODUCTS: access control, mailbox panels,
 microprocessor, music combination, panel/
 entrance, simplex, video

Soundsmith, Inc.

13510 Vargon Street
 Dallas, TX 75243
 (214) 437-3534
 President: Berkley Smith; Vice President: Mark
 Smith
 MJA Marketing, St. Charles, MO 314-447-7111
 PRODUCTS: access control, custom,
 microprocessor, talk-back

STENTOFON COMMUNICATIONS, INC.

6119 Connecticut Avenue
 Kansas City, MO 64120
 (816) 231-7200 (800) 654-3140 FAX: (816) 231-7203
 President: Joe Green; Marketing Manager: David
 E. Gill; National Sales Manager: Frederick Hall
 Dan Rothrock, Kansas City, MO 816-231-7200
 Tomas J. Reilly, Elmsford, NY 914-592-1048
 Kerry L. Orr, Atlanta, GA 404-973-0736
 Michael A. Wilcock, Glendora, CA 818-335-0543
 Cartwright & Bean, Inc., Norcross, GA 404-368-
 0160
 Dimension/ Point IX, Lewisville, TX 214-436-3706
 Humble & Associates, Anaheim, CA 714-750-2248
 LCA Sales Company, Tuckahoe, NY 914-961-4700
 Levy, Grams, & Lassers, North Brook, IL 708-272-
 8500
 Pearson & Pearson, Englewood, CO 303-770-0797
 Roger Ponto Assoc., Inc., Kirkland, WA 206-821-
 2996
 R.W. Kunz & Assoc., Inc., Prairie Village, KS 913-
 648-3535
 R.W. Sales, St. Paul, MN 612-646-2710
 Brian Trankle & Assoc., Belmont, CA 415-595-4004
 F.M. Valenti, Inc. & Assoc., Nahant, CA 617-592-
 5300
 Yocum Marketing Co., Inc., Mesa, AZ 602-834-3334
 Weller Electronic Sales, Inc., Worthington, OH
 614-885-7819
 PRODUCTS: access control, custom, duplex,
 lobby, microprocessor, music combination,
 panel/ entrance, simplex, talk-back

TALK-A-PHONE CO.

5013 N. Kedzie Ave.
 Chicago, IL 60625
 (312) 539-1100 FAX: (312) 539-1241
 Vice President: Samuel Shanes; Sales Manager:
 Dan F. Kagan; President: Z. Liberman
 JMS Marketing, Austin, TX 512-266-1113

**STOP
 THEFT!**
*Order a
 BLUE BOOK
 for everyone
 who borrows
 yours!*

Send \$12.00 plus
 Postage & Handling

ARTURO LIZARRAGA
Circulation Director
THE BLUE BOOK
 25 Willowdale Ave.
 Port Washington
 NY 11050

TekTone®

TEKTONE SOUND & SIGNAL MFG.

1331 South Killian Dr.
P.O. Box 12427
Lake Park, FL 33403-0427
(407) 844-2383 (800) 327-8466 FAX: (407) 845-1587
General Manager: Carlos Mira; President:
Manuel Mira; Customer Service Manager: David
Duelfer; Engineer: Kevin McClarnon; Design
Engineer: Jim Switzer; Project Manager: David
Medeiros
TekTone FBA Systems, Burlington, ON 416-333-
0051
Dardon Assoc., Olmsted Twp., OH 216-267-9778
RW Sales, St. Paul, MN 612-646-2710
Klumpp sales Co., Jacksonville, FL 904-268-1529
Westech Marketing, Culver City, CA 213-870-9286
Chuck Olson Assoc., Renton, WA 206-271-5416
Ziskind Assoc., Arlington Hts., IL 708-577-1624
Mountain Reps., Denver, CO 303-623-0972
B&B Sales, Oakland, CA 415-534-1725
Aphiha Communications, Happaage, NY 516-434-
8080
Fairfax Electronics, Los Angeles, CA 213-731-2561
Gress Corporation, Chicago, IL 312-581-6400
Lee Dan Communications, Happaage, NY 516-
231-1414
Midtekom, Olmsted Twp., OH 216-267-1149
Wm. B. Allen Supply, New Orleans, LA 504-525-
8222
Radio Sound Corp., Riverdale, IL 800-835-8663
Unicom Supply, Los Angeles, CA 213-204-6211
PRODUCTS: access control, apartment station,
custom, duplex, lobby, mailbox panels,
microprocessor, music combination, panel/
entrance, simplex, talk-back, telephone, video

TELECALL AMERICA

14620 NE 95th Street
Redmond, WA 98052
(206) 881-2742 (800) 752-2860 FAX: (206) 881-3085
President: Hiko Shinoda; Vice President: Nanci
Brooks
Palmieri Associates Inc., Fairfield, NJ 201-882-
1266
Henry W. Phillips Co., Inc., Roswell, GA 404-992-
3070
David H. Brothers Co., Inc., Flinckburg, MD 301-
833-0920
Leslie's, Elgin, IL 708-697-6677
Pacific Group, Pasadena, CA 818-577-0738
JMS Marketing, Austin, TX 512-266-1113
PRODUCTS: microprocessor, simplex, talk-back,
telephone, video

TOA ELECTRONICS, INC.

601 Gateway Blvd. Suite 300
P.O. Box 2047
S San Francisco, CA 94080
(415) 588-2538 (800) 733-4750 FAX: (415) 588-3349
President: Yoshiro Ishida; Director, Audio
Products Div: Richard Krochmal; Director,
Comm. Systems Div.: Al Burns; Mgr., Marketing
Development: Jeff Pallin; Manager, Western
Division: Bill Ford; Manager Engineering
Services: Bob Sweet
Chuck McGregor - Product Consit, Morris Plains,

NJ 201-829-7047
John Murray-Eng.Snd. Mktg. Dev, Springfield, OH
513-324-1993
Bob Hager-Eastern Regional Mgr, Rosewell, GA
404-552-7624
Linda Wick-Central Reg. Mgr., Kansas City, MO
816-453-5775
Robert Slaughter-Cntrl Div Mgr, Houston, TX 713-
460-3678
Pete Newmark-West Regional Mgr., Mesa, AZ
602-981-0050
Walter Best, Eastern Reg. Mgr., Sussex, NJ 201-
702-0068
PRODUCTS: access control, duplex,
microprocessor, music combination, talk-back,
telephone



Alphone Corp.

1700 130th Ave. NE
Bellevue, WA 98005
(206) 455-0510 FAX: (206) 455-0071
President: Jun Matsumoto; Vice President,
Marketing: Harry Quanz; Vice President, Sales:
Jim Morrison; Residential Sales Manager:
Stephen Birgh; Commercial Sales Manager: John
Mosebar
Alphone East Coast Reg. Office, Rochelle Park, NJ
201-843-6115
Precide, Morbio Inferiore, Switzerland, 914-
31734
PRODUCTS: closed-circuit, custom, drive-thru,
loudspeaking, microprocessor, multi-channel,
programmable, telephone, video/audio, VOX

Alpha Communications

89-D Cabot Court
Happaage, NY 11788-3717
(516) 434-8080 (800) 666-4800 FAX: (516) 434-8334
President: Mark S. Goldberg; Vice President:
Madelyn R. Goldberg; Office Manager: Rose
Tassone
Sound Sales, Inc., Columbia, MD 301-964-1170
PRODUCTS: custom, digital, loudspeaking,
microprocessor, telephone, video/audio, VOX

ATC Supply

106 Hobart St.
Hackensack, NJ 07601
(201) 488-0776 FAX: (201) 488-6975
Audio Etc., St. Peters, MO 314-278-4130

Bogen Communications, Inc.

50 Spring Street
P.O. Box 575
Ramsey, NJ 07446
(201) 934-8500 FAX: (201) 934-9832
President: John H. Ochtera; Vice President, Sales
& Mktg: David A. Chambers
Scott Whipple, Columbus, OH 614-272-1689
Sam Blasl, Ramsey, NJ 201-934-8500
Walter Spencer, Ramsey, NJ 201-934-8500
Fred Yosenick, Woodland, CA 916-668-6311
Edwards Company, Inc., Livonia, MI 313-458-7777
PRODUCTS: multi-channel, telephone

Cambridge Electronics Laboratories

20 Chester Street
Somerville, MA 02144
(617) 629-2805
Edwards Company, Inc., Livonia, MI 313-458-7777
PRODUCTS: telephone

Columbia Scientific Industries Corp

11950 Jollyville Rd.
P.O. Box 203190
Austin, TX 78720
(512) 258-5191 (800) 531-5003 FAX: (512) 258-5004
President: Gerald Phillips; Marketing Director:
James M. Cotton
Sunrise Sales Company, LaMolle, IL 815-638-2660
PRODUCTS: multi-channel, VOX

Communications Equipment

6443 Western Ave., Box 700
Glen Arbor, MI 49636
(616) 334-3081 FAX: (616) 334-3661



Comtek

357 West 2700 South, Salt Lake City, UT 84115
(801) 466-3463 FAX: (801) 484-6906
President: Ralph Belgique; Applications
Engineering: Steve Kartchner; Applications
Engineering: Steve Dupak; Service Manager:
Laurel Robertson; Credit Manager: Dana
Pelletier
Edwards Company, Inc., Livonia, MI 313-458-7777
PRODUCTS: wireless

Dukane Corp.

2900 Dukane Drive, St. Charles, IL 60174
(708) 584-2300 FAX: (708) 584-2370
President/C.E.O.: J. McWilliams Stone Jr.;
Pres./Comm. Systems Division: Steven L. Deppe;
National Sales Director: Warren T. Anderson;
Service Manager: Cliff Carlson
Wally Smutts, Toronto, ON 519-748-5352
Doug Fellabaum, Sycamore, IL 815-895-7573
Ken Lind, Boston, MA 617-235-6817
Pete Kendall, Jacksonville, FL 904-262-6025
Jim Lacey, Moreno Valley, CA 714-243-1160
Jack Brown, Dallas, TX 214-943-7528
Sanford Lange, Indianapolis, IN 317-251-3112
PRODUCTS: loudspeaking, multi-channel

Fisher Berkeley Corporation

955 Thirld S. Oakland, CA 94607
(415) 835-7575 FAX: (415) 271-8297
President: Robert S. Fisher; Sr. Vice President:
Wood H. Wymond; Vice President-Engineering:
Robert T. Shipley; Sales Coordination Manager:
Richard V. Flanagan; Sales Engineer: Michael D.
Lagrimas; Sales Engineer: Michael J. Mack
Arthur E. Tilley, Jr., Fayetteville, PA 717-352-8432
John D. Larounis, Barrington, IL 708-382-8233
John Corrigan, Corrigan Agency, Covington, LA
504-893-7455
Greg Dzuby & Assoc., Glendale, AZ 800-999-0006

HM ELECTRONICS, INC.

6675 Mesa Ridge Road
 San Diego, CA 92121
 (619) 535-6060 FAX: (619) 552-0139
 General Sales Manager: Bruce Siemmer; Western
 Regional Sales Mgr.: David VanEpps; Midwest
 Regional Sales Mgr.: John Debrocke; Eastern
 Regional Sales Mgr.: Mike Cerveny
 Derek Allen Associates, Toluca Lake, CA 818-840-
 8327
 A/V Marketing, Carmel, IN 317-846-1034
 John B. Anthony Company, Stamford, CT 203-
 322-9202
 ADCOM, Toronto, ON 416-251-3355
 PRODUCTS: drive-thru, wireless

International Logistics Systems Inc

295 Cortlandt Street
 P.O. Box 25
 Belleville, NJ 07109
 (201) 759-0007 FAX: (201) 759-8989
 President: Carmine O. Pellosie; Vice President:
 Dar Hyatt
 ADCOM, Toronto, ON 416-251-3355
 PRODUCTS: closed-circuit, video/audio



LEE DAN COMMUNICATIONS, INC.

155 Adams Avenue
 Hauppauge, NY 11788-3699
 (516) 231-1414 (800) 533-3261 FAX: (516) 231-1498
 President: Leon Goldberg; Vice President
 Operations: Lawrence J. Goldberg; V.P Finance &
 Administration: David H. Goldberg; Senior
 Technician: Sanford Hoffman; Office Manager:
 Rita Kaplan; Sr. Sales/Service Associate: Susan
 Leon
 C.L. Pugh & Associates, Cleveland, OH
 216-238-1777
 PRODUCTS: closed-circuit, custom, digital, drive-
 thru, loudspeaking, microprocessor, multi-
 channel, programmable, telephone, video/audio

Norcon Electronics, Inc.

1260 Ralph Ave.
 Brooklyn, NY 11236
 (718) 451-1112 FAX: (718) 451-0606
 President: Norman Schiaff; Vice President:
 Steven Schiaff; Vice President: Gerry Scheer
 Camden Marketing, Pierre Fonds, QU
 514-683-3377

Paso Sound Products, Inc.

14 First Street
 Pelham, NY 10803
 (914) 738-4800 (800) 231-3034 FAX: (914) 738-3954
 Executive Vice President: Paul Mastrangelo;
 Product Manager: Ken O'Brien; Credit Manager:
 Marilyn Beckerson; Operations Manager:
 Anthony Squeglia
 Anderson Sales, Braintree, MA 617-848-9194
 Jack Mesnick Sales, Liverpool, NY 315-622-3211
 Palmieri Associates, Fairfield, NJ 201-882-1266
 Weller Electronic Sales, Inc., Worthington, OH
 614-885-7819
 Ilenau Associates, Columbia, MD 301-621-4113

MJA Marketing, St. Charles, MO 314-447-7111
 Northland Assoc., Moorehead, MN 218-233-4616
 Allwest Sound & Communication, Camarillo, CA
 805-388-7745
 Dimension Pt. IX Marketing, Katy, TX 713-578-9277
 Mountain Representatives, Denver, CO 303-333-
 7745
 Miguel Lopez, Hialeah, FL 305-822-6853
 Paco Electronics, Ltd., Markham, ON 416-475-0740
 Robert Misk Co., Southfield, MI 313-354-3310
 Marketline Inc., Snellville, GA 404-972-9048
 Hawkins-Frederickson Assoc., Maitland, FL 407-
 831-2474
 LIntern Associates, Naperville, IL 708-904-1225
 Robert Misk Co., Indianapolis, IN 317-842-3400
 PRODUCTS: microprocessor, telephone

PORTLAND INSTRUMENT CORP.

6120 San Fernando Rd.
 Glendale, CA 91201
 (818) 500-0137 FAX: (818) 240-1828
 President: Ronald Fuller; Production Manager:
 Dick Herbert; Office Manager: Marcla Fuller;
 Controller: Ken Thiele; Service Department: Bill
 Brungard
 Bob White Associates, Solon, OH 216-248-1317
 Dimension/ Point IX, Lewisville, TX 214-436-3706
 PRODUCTS: custom, loudspeaking



Every member of our staff
 comes equipped with
 one very special feature.

At Stentofon, our communications specialists are always ready to lend an ear. They know that listening carefully to your input is the most important research they can do when it comes to developing the best solutions for improving communications within your customers' organizations.

By listening, they'll be able to come up with the internal communication system that performs most efficiently for every operation.

The intercom that best suits each specific requirement. Or the custom solution you can present with confidence.

So, when you're ready to start improving internal communications for your customers, give our specialists a call at 1-800-654-3140. They're all ears.



6119 Connecticut Avenue, Kansas City, MO 64120 • 1-800-654-3140

Circle 238 on Reader Response Card

Rauland-Borg Corp.

3450 W. Oakton St.
Skokie, IL 60076
(708) 679-0900 FAX: (708) 679-0625
President: William Krucks; Executive Vice
President: Kenneth James; National Sales
Manager: Harry Hahn; Marketing Manager:
Vince Novak
Jack Hollis, Geneva, IL 708-208-1488
Joe Clotti, Longwood, FL 407-767-2007
Frank Riha, Austin, TX 512-926-3646
Hank Plaisler, El Toro, CA 714-837-2626
Vince Ward, Vashon Island, WA 206-463-5582
Doug Warren, Newport News, VA 804-930-3217
Suzanne Graham, Kent, OH 216-678-7307
Mike Gulhan, E. Long Meadow, MA 413-525-6090

RING COMMUNICATIONS INC.

57 Trade Zone Drive
Ronkonkoma, NY 11779
(516) 585-7464 FAX: (516) 585-7410
President: Peter McLean; Vice President: Craig
Krsanac; Vice President: Kjell (Ken) Solem
Monfort Electronic Marketing, Indianapolis, IN
317-872-8877
EESCO Systems, Inc., Los Angeles, CA 213-666-
9601
Klumpp Sales Company, Jacksonville, FL 904-287-
5205
The TK Group, Inc., Loveland, CO 303-669-1008
Avwest, Inc., Fountain Hills, AZ 602-946-1811
Gustafson Sales Company, Red Wing, MN 612-
388-4277
Corrigan Agency, Covington, LA 504-893-7455
Pacnor Marketing, Lynnwood, WA 206-771-6016
Kaltec Communications, N. Vancouver, BC 604-
987-1597

**RTS Systems, A Telex Comm.
Company**

9600 Aldrich Avenue South
Minneapolis, MN 55420
(612) 884-4051 FAX: (612) 884-0043
President: Jeffrey Wetherell; Vice President,
Marketing: John Schofield; V.P. Engineering &
Tech.: Joe Winebarger; Sales Manager: Murray
Porteous; Director of Engineering: William
Dennison
Dave Brand, Burbank, CA
Mike Cuthrie, Wyckoff, NJ
Rick Fisher, Union Lake, MI
Sunrise Sales Company, LaMolle, IL 815-638-2660

**STENTOFON
COMMUNICATIONS, INC.**

6119 Connecticut Avenue
Kansas City, MO 64120
(816) 231-7200 (800) 654-3140 FAX: (816) 231-7203
President: Joe Green; Marketing Manager: David
E. Gill; National Sales Manager: Frederick Hall
Dan Rothrock, Kansas City, MO 816-231-7200
Tomas J. Reilly, Elmsford, NY 914-961-4700
Kerry L. Orr, Atlanta, GA 404-973-0736
Michael A. Wilcock, Glendora, CA 818-335-0543
Cartwright & Bean, Inc., Norcross, GA 404-368-
0160
Dimension/ Point IX, Lewisville, TX 214-436-3706
Humble & Associates, Anaheim, CA 714-750-2248
LCA Sales Company, Tuckahoe, NY 914-961-4700
Levy, Grams, & Lassers, North Brook, IL 708-272-
8500
Pearson & Pearson, Englewood, CO 303-770-0797
Roger Ponto Assoc., Inc., Kirkland, WA 206-821-
2996
R.W. Kunz & Assoc., Inc., Prairie Village, KS 913-
648-3535
R.W. Sales, St. Paul, MN 612-646-2710

Brian Trankle & Assoc., Belmont, CA 415-595-4004
F.M. Valenti, Inc. & Assoc., Nahant, CA 617-592-
5300

Yocum Marketing Co., Inc., Mesa, AZ 602-834-3334
Weller Electronic Sales, Inc., Worthington, OH
614-885-7819
PRODUCTS: closed-circuit, custom,
loudspeaking, microprocessor, multi-channel,
programmable, telephone, VOX

Swintek Enterprises, Inc.

956 Shulman Ave.
Santa Clara, CA 95050
(408) 727-4889 FAX: (408) 727-3025
President: Bill Swintek; Vice President: Les
Underwood; Director of Marketing: John
Hernandez; Controller: Joan Underwood;
Director of Engineering: Van Do
Audissey Sound, Honolulu, HI 808-521-6791
Film/Video Equipment, Denver, CO 303-778-8616
Kinney/Hanncock, Las Vegas, NV 702-731-1770
Montero International, Downey, CA 213-862-0116
Alan Gordon Ent., Hollywood, CA 213-466-3561
Karp Communications, Tampa, FL 813-968-7098

Systems Wireless, Ltd.

465 Herndon Parkway
Herndon, VA 22070
(703) 471-7887 (800) 542-3332 FAX: (703) 437-1107
President: Theodore Bennett; Vice President:
William Slen; Sales Engineer- Wireless: John
Kowalski; Sales Engineer- Intercom: Pat Hamp;
Rental Manager: Tom Conner; Service Manager:
Jim Cahill
Sound Sales, Inc., Columbia, MD 301-964-1170
PRODUCTS: drive-thru, multi-channel,
programmable, wireless

TALK-A-PHONE CO.

5013 N. Kedzie Ave.
Chicago, IL 60625
(312) 539-1100 FAX: (312) 539-1241
Vice President: Samuel Shanes; Sales Manager:
Dan F. Kagan; President: Z. Liberman
JMS Marketing, Austin, TX 512-266-1113
PRODUCTS: drive-thru, loudspeaking, multi-
channel, VOX

Teknicom Sales Co., Inc.

470 Commercial Ave.
Pallades Park, NJ 07650
(201) 947-7010 FAX: (201) 947-7069
President: Donald Duthaler
JMS Marketing, Austin, TX 512-266-1113

TELECALL AMERICA

14620 NE 95th Street
Redmond, WA 98052
(206) 881-2742 (800) 752-2860 FAX: (206) 881-3085
President: Hiko Shinoda; Vice President: Nanci
Brooks
Palmer Associates Inc., Fairfield, NJ 201-882-
1266
Henry W. Phillips Co., Inc., Roswell, GA 404-992-
3070
David H. Brothers Co., Inc., Flunksburg, MD 301-
833-0920
Leslie's, Elgin, IL 708-697-6677
Pacific Group, Pasadena, CA 818-577-0738
JMS Marketing, Austin, TX 512-266-1113
PRODUCTS: digital, loudspeaking,
microprocessor, multi-channel

TELEX COMMUNICATIONS, INC.

9600 Aldrich Avenue South
Minneapolis, MN 55420
(612) 884-4051 FAX: (612) 884-0043
President: Jeffrey Wetherell; Vice President
Marketing: John Schofield; Vice President Sales:
Dan Dantzler; Director of Marketing: Don
Mereen; Manager/Advertising & Mkt'g: Ron
Taylor
WestTech Marketing, Culver City, CA 213-870-9286
Bencsik Associates, Ocala, FL 904-732-9775
Burcaw Company & Associates, Warren, MI
313-573-4605
SAGA, Oswego, NY 315-343-5739
Monfort Electronic Marketing, Indianapolis, IN
317-872-8877
Murphy & Cotta, Inc., Atlanta, GA 404-875-2525
Northland Associates, Moorhead, MN
218-233-4616
Ranclllo Associates, Inc., St. Louis, MO
314-845-0202
J.Y. Schoonmaker Company, Dallas, TX
214-349-1650
Sigmet Corporation, Valley Forge, PA
215-783-6666
Weller Electronic Sales, Worthington, OH
614-885-7819
Ziskind Associates, Rolling Meadows, IL
312-577-1624
White Radio Ltd., Burlington, ON 416-632-6894
Silver Peak Marketing, Denver, CO 303-467-9042
PacNor Marketing, Lynnwood, WA 206-771-6016
PRODUCTS: closed-circuit, loudspeaking,
microprocessor, multi-channel, programmable,
VOX, wireless

TOA ELECTRONICS, INC.

601 Gateway Blvd. Suite 300
P.O. Box 2047
San Francisco, CA 94080
(415) 588-2538 (800) 733-4750 FAX: (415) 588-3349
President: Yoshiro Ishida; Director, Audio
Products Div: Richard Krochmal; Director,
Comm. Systems Div.: Al Burns; Mgr., Marketing
Development: Jeff Pallin; Manager, Western
Division: Bill Ford; Manager Engineering
Services: Bob Sweet
Chuck McGregor- Product Constt, Morris Plains,
NJ 201-829-7047
John Murray-Eng.Snd. Mktg. Dev, Springfield, OH
513-324-1993
Bob Hager-Eastern Regional Mgr, Rosewell, GA
404-552-7624
Linda Wick-Central Reg. Mgr., Kansas City, MO
816-453-5775
Robert Slaughter-Cntrl Div Mgr, Houston, TX 713-
460-3678
Pete Newmark-West Regional Mgr., Mesa, AZ
602-981-0050
Walter Best, Eastern Reg. Mgr., Sussex, NJ 201-
702-0068
PRODUCTS: digital, loudspeaking,
microprocessor, multi-channel, programmable,
telephone, VOX

**Order More
Blue Books
Now!**

OPPORTUNITY RINGS!

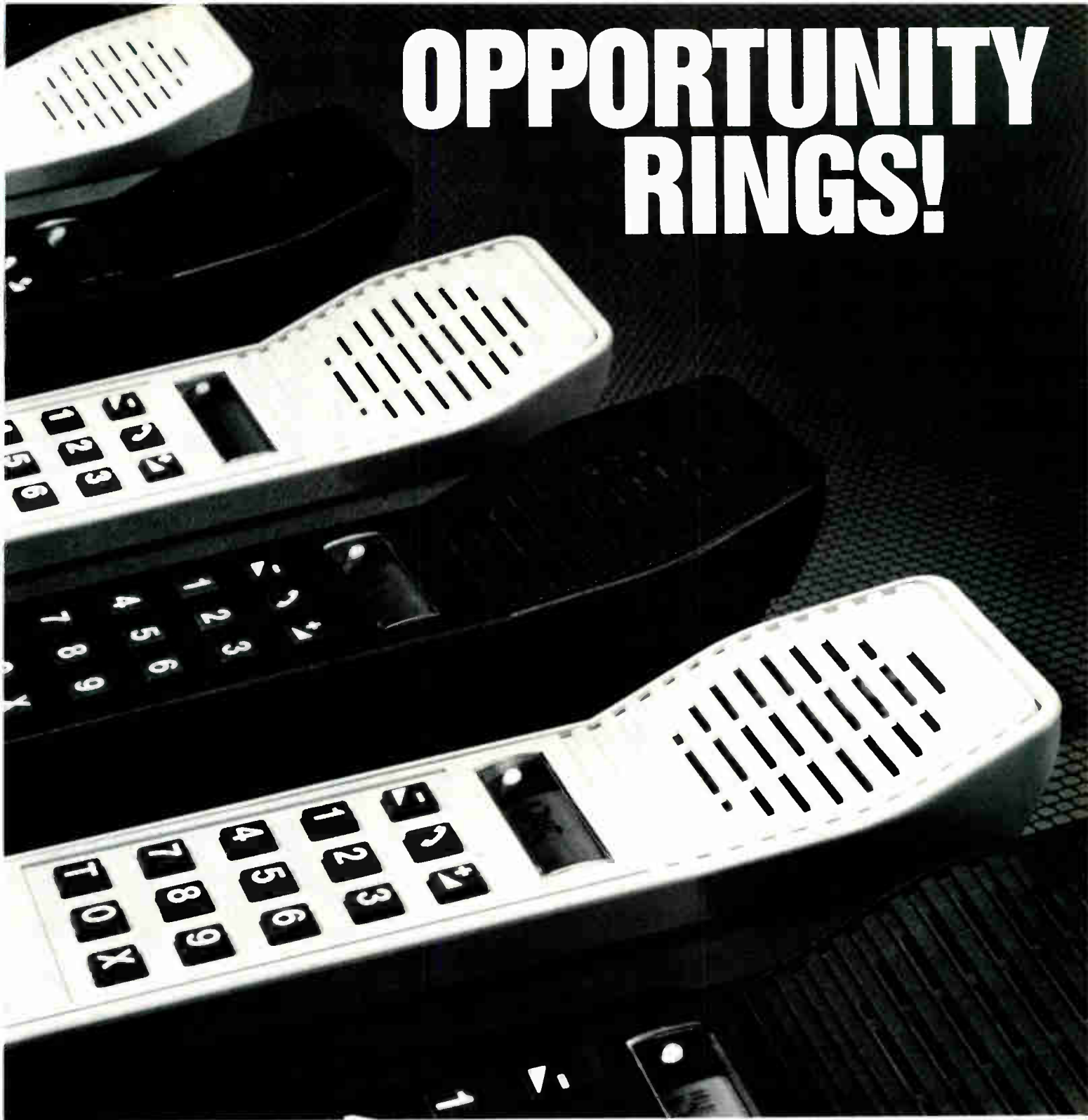

Ring Communications is proud to present a great opportunity — the new Ring-Master CB 600 Intercom System. The most advanced features for internal communications have been designed into the CB 600, and it's priced to give top value to you and your customers. The CB 600 is a fully electronic direct speech system for high quality, high speed internal communications linking as many as forty users. Master stations and substations contain individual micro-processors, allowing for a remarkable range of standard and programmable features. For

instance, just press a button to change a hands-free loud-speaker conversation to a softspoken private one. . .or find a party instantly. . .or simply leave a message on the easy-to-read liquid crystal display.

State-of-the-art engineering makes operation of the CB 600 a breeze. Flexible wiring makes installation a snap. So take advantage of the opportunity while it's still ringing.

Call Ring at (516) 585-RING, or write Ring Communications, Inc., 57 Trade Zone Drive, Ronkonkoma, NY 11779. 
Fax: (516) 585-7410.

RING

COMMUNICATIONS INC.

World Radio History
Circle 212 on Reader Response Card

INTERCOM HOSPITAL HEALTH CARE

Alphone Corp.

1700 130th Ave. NE
Bellevue, WA 98005
(206) 455-0510 FAX: (206) 455-0071
President: Jun Matsumoto; Vice President,
Marketing: Harry Quanz; Vice President, Sales:
Jim Morrison; Residential Sales Manager:
Stephen Blrgh; Commercial Sales Manager: John
Mosebar
Alphone East Coast Reg. Office, Rochelle Park, NJ
201-843-6115
Precide, Morbio Inferiore, Switzerland, 914-31734
PRODUCTS: annunciators, direct select,
emergency call, microprocessor, nurse-call,
visual, voice paging

Alpha Communications

89-D Cabot Court
Hauppauge, NY 11788-3717
(516) 434-8080 (800) 666-4800 FAX: (516) 434-8334
President: Mark S. Goldberg; Vice President:
Madelyn R. Goldberg; Office Manager: Rose
Tassone
Sound Sales, Inc., Columbia, MD 301-964-1170
PRODUCTS: A/V, annunciators, direct select,
emergency call, microprocessor, nurse-call,
pillow speakers, visual, voice paging

American Zettler, Inc.

75 Columbia
Allso Viejo, CA 92656
(714) 831-5000 FAX: (714) 831-8548
ADCOM, Toronto, ON 416-251-3355

CMX

1111 Industry Ave.
Roanoke, VA 24013
(703) 982-3900 FAX: (408) 986-0452

Rancillio Associates, St. Louis, MO 314-845-0202
Vector Corp., Seattle, WA 206-368-8400
Kingston Sales, Indianapolis, IN 317-876-2545
Bidwell-Schwartz Associates, Gardena, CA 213-
770-0300
Yocum Marketing, Mesa, AZ 602-834-3334
Avcom, Inc., North Olmstead, OH 216-777-2060
Kodo Associates, Minneapolis, MN 612-881-1255
W.A. Hendrickson Co., North Scituate, MA 617-
545-0652
LSM Associates, Phelps, NY 315-548-4891
R & S Sales, Rockville Ctr., NY 516-678-6887

Dukane Corp.

2900 Dukane Drive, St. Charles, IL 60174
(708) 584-2300 FAX: (708) 584-2370
President/C.E.O.: J. McWilliams Stone Jr.;
Pres./Comm. Systems Division: Steven L. Deppe;
National Sales Director: Warren T. Anderson;
Service Manager: Cliff Carlson
Wally Smutts, Toronto, ON 519-748-5352
Doug Fellabaum, Sycamore, IL 815-895-7573
Ken Lind, Boston, MA 617-235-6817
Pete Kendall, Jacksonville, FL 904-262-6025
Jim Lacey, Moreno Valley, CA 714-243-1160
Jack Brown, Dallas, TX 214-943-7528
Sanford Lange, Indianapolis, IN 317-251-3112
PRODUCTS: A/V, annunciators, direct select,
emergency call, microprocessor, nurse-call,
pillow speakers, visual, voice paging

Edwards Company, Inc.

195 Farmington Avenue
P.O. Box 1188
Farmington, CT 06034
(203) 678-0410 FAX: (203) 677-5881
President: Timothy Mellen; Vice Pres. Mktg.,
Sales Mgr.: Louis Riccio; Vice President Finance:
Paul DeFillippo; Vice President, Engineering: Ed
Miller; Vice Pres. Employee Relations: Robert
Maxwell
Edwards Company, Inc., Cherry Hill, NJ
609-482-5300
Edwards Company, Inc., Atlanta, GA 404-451-0362
Edwards Company, Inc., City Of Indus., CA
818-854-8670
Edwards Company, Inc., Pleasanton, CA
415-463-1788
Edwards Company, Inc., Downers Grove, IL 708-
515-1900
Edwards Company, Inc., Livonia, MI 313-458-7777
Edwards Company, Inc., Dallas, TX 214-233-8998
Edwards Company, Inc., Miami, FL 305-592-0510
Edwards Company, Inc., Norwood, MA
617-762-9115
Edwards Company, Inc., Norwalk, CT
203-847-1115
Edwards Company, Inc., Lorton, VA 703-550-7815
PRODUCTS: annunciators, direct select,
emergency call, nurse-call

Engineered Electronics Inc.

4301 Industrial Access Road
Douglasville, GA 30134
(404) 949-3290 (800) 331-3541 FAX: (404) 489-8905
President: Roy J. Caviness; Vice-President:
Anthony W. Bunch
Greg Dzubay & Assoc., Glendale, AZ 800-999-0006

EXI ELECTRONICS MANUFACTURING

803 Erin St.
Winnipeg, MB R3G 2W2
(204) 453-0573 FAX: (204) 775-1165
Sales Engineer: Mort Larsen; R & D Engineer:
Vladimir Federman; Marketing: Les Toutant
Doug Warren, Newport News, VA 804-930-3217
PRODUCTS: annunciators, emergency call,
microprocessor, visual

Fisher Berkeley Corporation

955 Third St.
Oakland, CA 94607
(415) 835-7575 FAX: (415) 271-8297
President: Robert S. Fisher; Sr. Vice President:
Wood H. Wymond; Vice President-Engineering:
Robert T. Shipley; Sales Coordination Manager:
Richard V. Flanagan; Sales Engineer: Michael D.
Lagrlmas; Sales Engineer: Michael J. Mack
Arthur E. Tilley, Jr., Fayetteville, PA 717-352-8432
John D. Larounis, Barrington, IL 708-382-8233
John Corrigan, Corrigan Agency, Covington, LA
504-893-7455
Greg Dzubay & Assoc., Glendale, AZ 800-999-0006

Intercall Systems, Inc.

167 Nassau Blvd.
Garden City S., NY 11530
(516) 538-6660 FAX: (516) 481-0877
General Manager: Gene Manganaro; Marketing
Manager: JoAnn Jahncke; Advertising Manager:
Therese Dessauce; Director of Engineering: Ken
Martin; Credit Manager: Mary Green; Sales
Engineering: Eli Gurman
PRODUCTS: A/V, annunciators, direct select,
emergency call, microprocessor, nurse-call,
pillow speakers, visual, voice paging



Jeron Electronic Systems, Inc.

1743 W. Rosehill Drive
Chicago, IL 60660
(312) 275-1900 (800) 621-1903 FAX: (312) 275-0283
President: Jerome Chesnut; Vice President:
Matthew Chesnut; Secretary: Elizabeth Chesnut
ADCOM, Toronto, ON 416-251-3355
PRODUCTS: A/V, annunciators, direct select,
emergency call, microprocessor, nurse-call,
pillow speakers, visual, voice paging

Komtek Communications

11 White Lakes Rd.
Stanley, NM 87056
(505) 832-6236

CORNELL
ELECTRONIC PRODUCTS, INC.

Cornell Electronic Products, Inc.

4911 W. Good Hope Road
P.O. Box 23411, Milwaukee, WI 53223-0411
(414) 351-4660 FAX: (414) 351-4657
President: Donald J. Glaubitz; Vice President:
Gary M. Butler; Sales Manager: Pauline A. Haack;
Accounting: Thelma M. Plunkett; Production
Manager: Joel Karls
Richard S. Pass Associates, Philadelphia, PA 215-
757-6100
Dick Bellew Sales, Dallas, TX 214-644-7881
Winchester Electronic Sales, Atlanta, GA 404-392-0200
Cartwright & Bean, Orlando, FL 407-889-9100

**Order More
Blue Books
Now!**

Innovations In Communications™

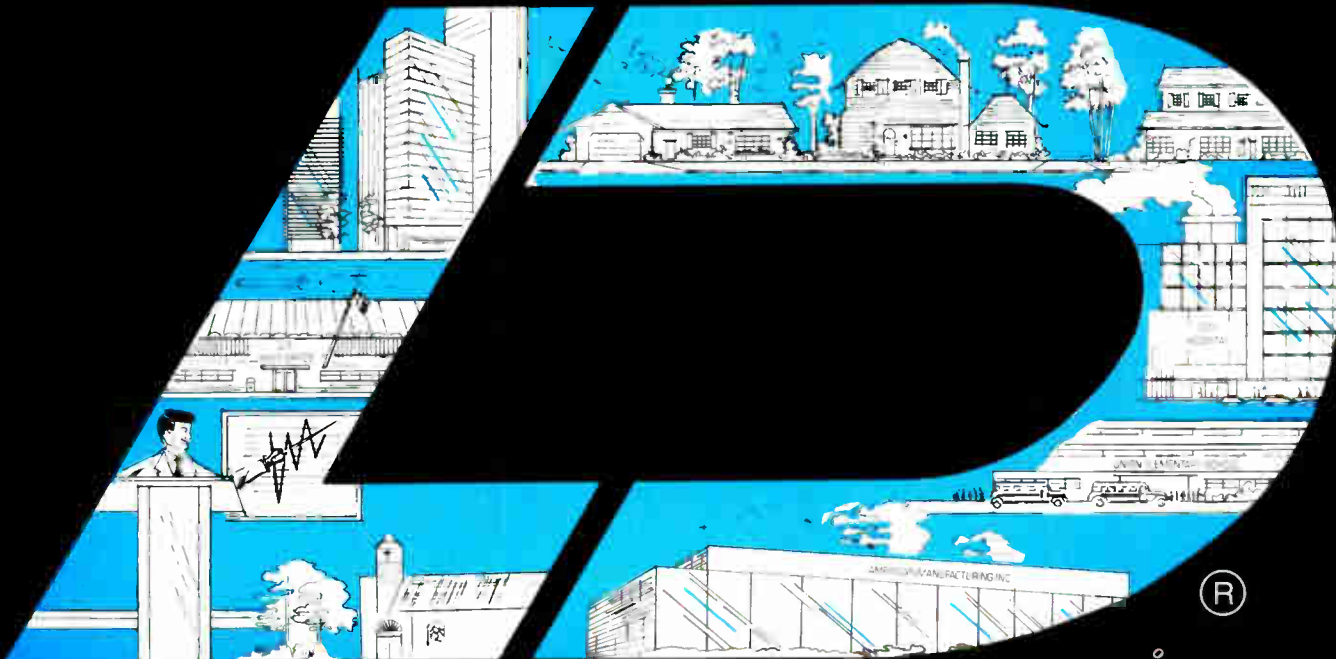

Since 1955

Wherever people have the need for better communications, safety and convenience, you'll find a **LEE DAN®** intercom system hard at work.

For over 34 years, we've been manufacturing intercoms for homes, apartments, townhouses, offices, factories, schools and hospitals. Our experience can help you turn a complicated specification into a simple, profitable solution.

Our large product line, teamed with our quick, affordable, customizing abilities, can help you meet your equipment needs, schedules, and profit margins.

Next time you need an intercom, call **LEE DAN®**. Our sales staff will assist you in equipment selection. We'll provide a detailed written quotation (not a lump sum price) with literature, spec sheets, wiring information, and anything else you need to put together a great system and a winning proposal.

ENTERCOM®
Multi-Unit Intercoms



VAN-GUARD®
Custom Lobby Panels



ENTERLOK™
Door Answering Intercoms



INTERVIEW™
Audio/Visual Intercoms



We're here to help. Call us toll-free.

N.Y. (800) 231-1414
U.S.A. (800) LEE DAN-1

(516) 231-1414
FAX (516) 231-1498

155 Adams Avenue, Hauppauge, New York 11788-3699

INTERCOMS • NURSE-CALL • MAILBOXES • DIRECTORIES • ANNUNCIATORS • WIRE & CABLE • CCTV

Circle 228 on Reader Response Card

LD
LEE DAN
COMMUNICATIONS INC.

IMPORTANT!!

1 9 1
INTERNATIONAL

DJ expo

We are pleased to offer a special hotel discount rate of \$130.00 per night (single/double) **EXCLUSIVELY** for DJ EXPO attendees, available from Friday, October 11 through Saturday, October 19. **You MUST identify yourself as affiliated with the INTERNATIONAL DJ EXPO in order to qualify for this special discount room rate.**

*Regular room rates are \$200.00 & up

CALL NOW!!

For Reservations, please call the Walt Disney World Dolphin toll free at:
(800) 227-1500.

Reserve now. Limited rooms are available.

LAKE BUENA VISTA, FLORIDA

Monday — Wednesday, October 14, 15, & 16, 1991
Walt Disney World Dolphin

Discount airline information will be sent to you within 10 days of receipt of your show registration.

I am a . . .

- Club DJ
- Mobile DJ
- Radio DJ
- Radio PD/MD
- Sound Contractor/Installer
- Lighting Installer/Designer
- Club Owner/Manager
- Architect/Designer
- Audio Equipment Dealer/Distributor
- Lighting Equipment Dealer/Distributor
- Record Tape, CD Retailer/Distributor
- Record Company
- Independent Promoter/Manager Agent
- Artist
- Media
- Manufacturers Rep
- Other

YES! Register me now for the International DJ Expo (October 14, 15, 16, 1991)

<input type="checkbox"/> EXHIBITS ONLY	Before August 30 Free	XXX
	(All 3 days) After August 30 \$25.00	
<input type="checkbox"/> DAILY PASS	Tuesday \$85.00	
	(Includes workshops and exhibits) Wednesday \$90.00	
	Thursday \$60.00	
<input type="checkbox"/> FULL EXPO	(Register by August 30) \$115.00	
	(Show up to all workshops, exhibits, and special events) (Register by September 30) \$155.00	
On-Site Registration (\$215.00)	TOTAL	\$ _____

Make Check Payable to: 1991 International DJ Expo
25 Willowdale, Ave., Port Washington, NY 11050
(516) 767-2500 Fax: (516) 767-9335

or Call for more information

Please photocopy for your files or if you need additional forms.

- Check or money order enclosed. US funds only, please.
- Charge my MasterCard/VISA account

_____	_____
Card Number	Expires Day

Signature — required for charge orders

NAME _____

TITLE _____

COMPANY _____

ADDRESS _____

CITY _____ STATE _____

COUNTRY _____ POSTAL ZIP _____

Daytime telephone _____ (include country and city code if outside the USA)

FAX number _____ (include country and city code if outside the USA)



LEE DAN COMMUNICATIONS, INC.

155 Adams Avenue
Hauppauge, NY 11788-3699
(516) 231-1414 (800) 533-3261 FAX: (516) 231-1498
President: Leon Goldberg; Vice President
Operations: Lawrence J. Goldberg; V.P. Finance &
Administration: David H. Goldberg; Senior
Technician: Sanford Hoffman; Office Manager:
Rita Kaplan; Sr. Sales/Service Associate: Susan
Leon
C.L. Pugh & Associates, Cleveland, OH 216-238-
1777
PRODUCTS: A/V, annunciators, direct select,
emergency call, microprocessor, nurse-call,
pillow speakers, visual, voice paging

Find Your Suppliers in the
Sound & Communications
Blue Book

MED-TEK HEALTHCARE PRODUCTS

1335 S. Claudina St.
Anaheim, CA 92805
(714) 774-8484 (800) 955-9540 FAX: (714) 774-7388
Distributor & Dealer Acct's: John Sykora; V.P.,
Marketing & Sales: William A. Haines; President:
William K. Haines; Operations: Daniel Haines;
Technical Director: Tom Ludden
Camden Marketing, Pierre Fonds, QU 514-683-
3377
PRODUCTS: pillow speakers

Medi-Signal Systems Co.

12321 Magnolia Ave.
Riverside, CA 92503
(714) 371-4321 (800) 828-8483 FAX: (714) 371-4320
President: J. A. Huebner
PRODUCTS: emergency call, microprocessor,
nurse-call

Mehlich Electronics, Inc.

3533-A Nell Street
Raleigh, NC 27607
(919) 832-4292 FAX: (919) 832-4755
Chief Engineer: Karl R. Mehlich; Sales/Marketing:
A. Leonhard Mehlich; Credit Manager: Beth A.
Dixon
Audio Etc., St. Peters, MO 314-278-4130
PRODUCTS: nurse-call

Rauland-Borg Corp.

3450 W. Oakton St., Skokie, IL 60076
(708) 679-0900 FAX: (708) 679-0625
President: William Krucks; Executive Vice
President: Kenneth James; National Sales
Manager: Harry Hahn; Marketing Manager:
Vince Novak
Jack Hoills, Geneva, IL 708-208-1488
Joe Clottl, Longwood, FL 407-767-2007
Frank Riha, Austin, TX 512-926-3646
Hank Plalsler, El Toro, CA 714-837-2626
Vince Ward, Vashon Island, WA 206-463-5582
Doug Warren, Newport News, VA 804-930-3217
Suzanne Graham, Kent, OH 216-678-7307
Mike Gulnan, E. Long Meadow, MA 413-525-6090

RING COMMUNICATIONS INC.

57 Trade Zone Drive, Ronkonkoma, NY 11779
(516) 585-7464 FAX: (516) 585-7410
President: Peter McLean; Vice President: Craig
Krsanac; Vice President: Kjell (Ken) Solem
Monfort Electronic Marketing, Indianapolis, IN
317-872-8877
EESCO Systems, Inc., Los Angeles, CA 213-666-
9601
Klumpp Sales Company, Jacksonville, FL 904-287-
5205
The TK Group, Inc., Loveland, CO 303-669-1008
Awest, Inc., Fountain Hills, AZ 602-946-1811
Gustafson Sales Company, Red Wing, MN 612-
388-4277
Corrigan Agency, Covington, LA 504-893-7455
Pacnor Marketing, Lynnwood, WA 206-771-6016
Kaltec Communications, N. Vancouver, BC 604-
987-1597

NO HOME RUN WIRING

Introducing the

5000 Audio/Visual Nurse Call System

By MEHLICH
("Maylick")

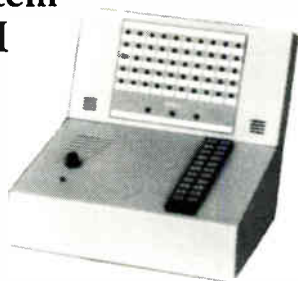

The master and all remote stations (up to 100
plus 10 door monitors) can be connected
to a 16 conductor cable.

- Fewer cable requirements
- Fewer & simpler connections
- Simple system design
- Easy future expansion
- No wire labeling necessary

See the 5000 system at the NSCA convention
Booth #821 / May 20-22 - Cincinnati, Ohio

German Engineering
Made in the USA

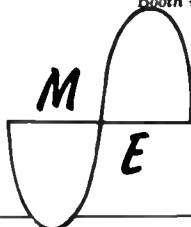

Mehlich Electronics, Inc.

P.O. Box 33276
Raleigh, North Carolina 27636-3276
Tel (919) 832-4292

FREE INFORMATION

Use the
Reader Response
Cards in this
issue to find
out more about
companies that
interest you.

Circle 39 on Reader Response Card

Scantronic USA Inc.

490 Oberlin Avenue South
Lakewood, NJ 08701
(201) 364-7200 FAX: (201) 364-7918

**STENTOFON
COMMUNICATIONS, INC.**

6119 Connecticut Avenue, Kansas City, MO 64120
(816) 231-7200 (800) 654-3140 FAX: (816) 231-7203
President: Joe Green; Marketing Manager: David
E. Gill; National Sales Manager: Frederick Hall
Dan Rothrock, Kansas City, MO 816-231-7200
Thomas J. Reilly, Elmsford, NY 914-592-1048
Kerry L. Orr, Atlanta, GA 404-973-0736
Michael A. Wilcock, Glendora, CA 818-335-0543
Cartwright & Bean, Inc., Norcross, GA 404-368-0160
Dimension/Point IX, Lewisville, TX 214-436-3706
Humble & Associates, Anaheim, CA 714-750-2248
LCA Sales Company, Tuckahoe, NY 914-961-4700
Levy, Grams, & Lassers, North Brook, IL 708-272-
8500
Pearson & Pearson, Englewood, CO 303-770-0797
Roger Ponto Assoc., Inc., Kirkland, WA 206-821-2996
R.W. Kunz & Assoc., Inc., Prairie Village, KS 913-
648-3535
R.W. Sales, St. Paul, MN 612-646-2710
Brian Trankle & Assoc., Belmont, CA 415-595-4004
F.M. Valenti, Inc. & Assoc., Nahant, CA 617-592-
5300
Yocum Marketing Co., Inc., Mesa, AZ 602-834-3334
Weller Electronic Sales, Inc., Worthington, OH
614-885-7819
PRODUCTS: annunciators, direct select,
emergency call, microprocessor, voice paging

TALK-A-PHONE CO.

5013 N. Kedzie Ave.
Chicago, IL 60625
(312) 539-1100 FAX: (312) 539-1241
Vice President: Samuel Shanes; Sales Manager:
Dan F. Kagan; President: Z. Liberman
JMS Marketing, Austin, TX 512-266-1113
PRODUCTS: annunciators, direct select, voice
paging

**TEKTONE SOUND & SIGNAL
MFG.**

1331 South Killian Dr.
P.O. Box 12427
Lake Park, FL 33403-0427
(407) 844-2383 (800) 327-8466 FAX: (407) 845-1587
General Manager: Carlos Mira; President:
Manuel Mira; Customer Service Manager: David
Duelfer; Engineer: Kevin McClarnon; Design
Engineer: Jim Switzer; Project Manager: David
Medeiros

TekTone FBA Systems, Burlington, ON 416-333-
0051
Dardon Assoc., Olmsted Twp., OH 216-267-9778
RW Sales, St. Paul, MN 612-646-2710
Klumpp sales Co., Jacksonville, FL 904-268-1529
Westech Marketing, Culver City, CA 213-870-9286
Chuck Olson Assoc., Renton, WA 206-271-5416
Ziskind Assoc., Arlington Hts., IL 708-577-1624
Mountain Reps., Denver, CO 303-623-0972
B&B Sales, Oakland, CA 415-534-1725
Aphi Communications, Happaugue, NY 516-434-
8080
Fairfax Electronics, Los Angeles, CA 213-731-2561
Gress Corporation, Chicago, IL 312-581-6400
Lee Dan Communications, Hauppauge, NY 516-
231-1414
Midtekcom, Olmsted Twp., OH 216-267-1149
Wm. B. Allen Supply, New Orleans, LA 504-525-
8222
Radio Sound Corp., Riverdale, IL 800-835-8663
Unicom Supply, Los Angeles, CA 213-204-6211
PRODUCTS: A/V, annunciators, direct select,
emergency call, microprocessor, nurse-call,
pillow speakers, visual, voice paging

TELECALL AMERICA

14620 NE 95th Street
Redmond, WA 98052
(206) 881-2742 (800) 752-2860 FAX: (206) 881-3085
President: Hiko Shinoda; Vice President: Nanci
Brooks
Palmieri Associates Inc., Fairfield, NJ 201-882-
1266
Henry W. Phillips Co., Inc., Roswell, GA 404-992-
3070

WHAT'S ON YOUR MIND?

Contractors Speak...

Every month in Sound & Communications, contractors have the opportunity to sound off—and communicate—on sound and communications issues.

- BUSINESS RELATIONSHIPS
- TECHNOLOGY TODAY
- APPLICATIONS THAT WORK

WHATEVER'S ON YOUR MIND IS ON OURS.

READ SOUND & COMMUNICATIONS
THE INDUSTRY COMMUNICATOR

David H. Brothers Co., Inc., Finksburg, MD 301-333-0920
 eslle's, Elgin, IL 708-697-6677
 Pacific Group, Pasadena, CA 818-577-0738
 IMS Marketing, Austin, TX 512-266-1113
 PRODUCTS: annunciators, microprocessor

FOA ELECTRONICS, INC.

301 Gateway Blvd. Suite 300
 P.O. Box 2047
 San Francisco, CA 94080
 (415) 588-2538 (800) 733-4750 FAX: (415) 588-3349
 President: Yoshiro Ishida; Director, Audio Products Div: Richard Krochmal; Director, Comm. Systems Div.: Al Burns; Mgr., Marketing Development: Jeff Paillin; Manager, Western Division: Bill Ford; Manager Engineering Services: Bob Sweet
 Chuck McGregor - Product Conslt, Morris Plains, NJ 201-829-7047
 John Murray - Eng. Snd. Mktg. Dev, Springfield, OH 513-324-1993
 Bob Hager - Eastern Regional Mgr, Rosewell, GA 404-552-7624
 Linda Wick - Central Reg. Mgr., Kansas City, MO 316-453-5775
 Robert Slaughter - Cntrl Div Mgr, Houston, TX 713-360-3678
 Pete Newmark - West Regional Mgr., Mesa, AZ 502-981-0050
 Walter Best, Eastern Reg. Mgr., Sussex, NJ 201-702-0068
 PRODUCTS: A/V, annunciators, emergency call, microprocessor, voice paging

Visplex Communications

1161C Lake Cook Rd.
 Deerfield, IL 60015
 (708) 405-0771 FAX: (708) 405-0776
 Audio Etc., St. Peters, MO 314-278-4130

Wescom

4800 Dellwood Ave.
 Jacksonville, FL 32205
 (904) 384-0712 FAX: (904) 384-0758



3M SOUND PRODUCTS

Bldg. 551-1W-01
 St. Paul, MN 55144
 (612) 736-0843 FAX: (612) 736-7614
 National Sales Manager: Don Sluder
 JMS Marketing, Austin, TX 512-266-1113
 PRODUCTS: drive-thru, environmentally protected, headset/ handset, loudspeaking

Alphone Corp.

1700 130th Ave. NE
 Bellevue, WA 98005
 (206) 455-0510 FAX: (206) 455-0071
 President: Jun Matsumoto; Vice President, Marketing: Harry Quanz; Vice President, Sales: Jim Morrison; Residential Sales Manager: Stephen Birgh; Commercial Sales Manager: John

Mosebar
 Alphone East Coast Reg. Office, Rochelle Park, NJ 201-843-6115
 Precide, Morbio Inferiore, Switzerland, 914-31734
 PRODUCTS: drive-thru, loudspeaking, telephone

Alpha Communications

89-D Cabot Court
 Hauppauge, NY 11788-3717
 (516) 434-8080 (800) 666-4800 FAX: (516) 434-8334
 President: Mark S. Goldberg; Vice President: Madelyn R. Goldberg; Office Manager: Rose Tassone
 Sound Sales, Inc., Columbia, MD 301-964-1170
 PRODUCTS: headset/ handset, loudspeaking, telephone

Atkinson Dynamics

10 W. Orange Ave.
 S. San Francisco, CA 94080
 (415) 583-9845 FAX: (415) 876-1111
 J.B. Parent, Dublin, OH 614-764-0064

Bogen Communications, Inc.

50 Spring Street
 P.O. Box 575
 Ramsey, NJ 07446
 (201) 934-8500 FAX: (201) 934-9832
 President: John H. Ochtera; Vice President, Sales & Mktg: David A. Chambers
 Scott Whipple, Columbus, OH 614-272-1689
 Sam Blasl, Ramsey, NJ 201-934-8500
 Walter Spencer, Ramsey, NJ 201-934-8500
 Fred Yosenick, Woodland, CA 916-668-6311
 Edwards Company, Inc., Livonia, MI 313-458-7777
 PRODUCTS: loudspeaking, telephone

Columbia Scientific Industries Corp

11950 Jollyville Rd.
 P.O. Box 203190
 Austin, TX 78720
 (512) 258-5191 (800) 531-5003 FAX: (512) 258-5004
 President: Gerald Phillips; Marketing Director: James M. Cotton
 Sunrise Sales Company, LaMoille, IL 815-638-2660
 PRODUCTS: drive-thru

Com-Tec Inc.

3000 N. Pointer Rd.
 Appleton, WI 54915
 (414) 749-2840 FAX: (414) 749-2848
 Co-Owner — President: Ken McLellan; Co-Owner — Vice-President: Tony Leslie
 Vector Corp., Seattle, WA 206-368-8400
 PRODUCTS: environmentally protected

Detector Systems Inc.

11650 Seabord Circle
 Stanton, CA 90680
 (714) 895-6366 FAX: (714) 895-6145
 Audio Etc., St. Peters, MO 314-278-4130

Drive-Thru Intercoms

2500 Hwy. 287
 P.O. Box 777
 Mansfield, TX 76063
 (817) 572-3177 FAX: (817) 478-2506
 Vice President: Larry Norris; Vice President: Frank Kaska

Dukane Corp.

2900 Dukane Drive
 St. Charles, IL 60174
 (708) 584-2300 FAX: (708) 584-2370
 President/C.E.O.: J. McWilliams Stone Jr.;

Pres./Comm. Systems Division: Steven L. Deppe;
 National Sales Director: Warren T. Anderson;
 Service Manager: Cliff Carlson
 Wally Smutts, Toronto, ON 519-748-5352
 Doug Fellabaum, Sycamore, IL 815-895-7573
 Ken Lind, Boston, MA 617-235-6817
 Pete Kendall, Jacksonville, FL 904-262-6025
 Jim Lacey, Moreno Valley, CA 714-243-1160
 Jack Brown, Dallas, TX 214-943-7528
 Sanford Lange, Indianapolis, IN 317-251-3112
 PRODUCTS: loudspeaking

Elenex, Inc.

7 Wayland Street
 N. Cohocton, NY 14868
 (716) 534-5280 (800) 356-8433 FAX: (716) 534-5950
 President: Sten Persson; Product Manager: David J. Arseneau; Sales: Peggy Peters; Sales: David J. Arseneau
 Miller, Ferree & Assoc., Bellevue, WA 206-462-1771
 Cano Enterprises, Warrenville, IL 708-393-1299
 Admiral Sales, Dallas, TX 214-357-9212
 Greg Dzubay & Assoc., Glendale, AZ 800-999-0006
 PRODUCTS: drive-thru, headset/ handset, loudspeaking, telephone

Elkay Industries

2925 North Market St.
 St. Louis, MO 63106
 (314) 535-1333 FAX: (314) 535-4118
 CEO/ENG: Richard Hahn; President: Paul Grote;
 Vice President, Sales: Martin Hahn; Engineering: Jack Scilligo
 Edwards Company, Inc., Livonia, MI 313-458-7777

ENCOM PRODUCTS CO., INC.

502 Lower Hopewell Road
 Oxford, PA 19363
 (215) 932-9600 (800) 424-9066 FAX: (215) 932-9999
 Greg Dzubay & Assoc., Glendale, AZ 800-999-0006
 PRODUCTS: environmentally protected, headset/ handset, telephone

Fisher Berkeley Corporation

955 Third St.
 Oakland, CA 94607
 (415) 835-7575 FAX: (415) 271-8297
 President: Robert S. Fisher; Sr. Vice President: Wood H. Wymond; Vice President-Engineering: Robert T. Shipley; Sales Coordination Manager: Richard V. Flanagan; Sales Engineer: Michael D. Lagrimas; Sales Engineer: Michael J. Mack
 Arthur E. Tilley, Jr., Fayetteville, PA 717-352-8432
 John D. Larounis, Barrington, IL 708-382-8233
 John Corrigan, Corrigan Agency, Covington, LA 504-893-7455
 Greg Dzubay & Assoc., Glendale, AZ 800-999-0006

HM ELECTRONICS, INC.

6675 Mesa Ridge Road
 San Diego, CA 92121
 (619) 535-6060 FAX: (619) 552-0139
 General Sales Manager: Bruce Slemmer; Western Regional Sales Mgr.: David VanEpps; Midwest Regional Sales Mgr.: John Debrocke; Eastern Regional Sales Mgr.: Mike Cerveny
 Derek Allen Associates, Toluca Lake, CA 818-840-8327
 A/V Marketing, Carmel, IN 317-846-1034
 John B. Anthony Company, Stamford, CT 203-322-9202
 ADCOM, Toronto, ON 416-251-3355
 PRODUCTS: drive-thru, environmentally protected, headset/ handset, loudspeaking, telephone

J.W. DAVIS AND CO.

3030 Canton Street
Dallas, TX 75226
(214) 651-7341 (800) 527-5705 FAX: (214) 939-0328
President: Harvey Earp; Vice President, Sales:
Jack W. Tucker; Chief Engineer: Eric Simonson
Multi-Technical Reps., Brainerd, MN 218-828-9483
PRODUCTS: drive-thru, headset/ handset,
loudspeaking, telephone

LEE DAN COMMUNICATIONS, INC.

155 Adams Avenue, Hauppauge, NY 11788-3699
(516) 231-1414 (800) 533-3261 FAX: (516) 231-1498
President: Leon Goldberg; Vice President
Operations: Lawrence J. Goldberg; V.P. Finance &
Administration: David H. Goldberg; Senior
Technician: Sanford Hoffman; Office Manager:
Rita Kaplan; Sr. Sales/Service Associate: Susan
Leon
C.L. Pugh & Associates, Cleveland, OH 216-238-1777
PRODUCTS: drive-thru, environmentally
protected, headset/ handset, loudspeaking,
telephone

Protech Audio Corporation

Flowerfield Bldg., St. James, NY 11780
(516) 584-5855 FAX: (516) 584-5904
Director of Marketing: Bill Murphy; Sales
Engineering: Joseph Giambone
Peregrine Southwest Reps, Houston, TX 713-589-
8481
First Choice Marketing, Seattle, WA 206-524-7344
Dimension/ Point IX, Lewisville, TX 214-436-3706
PRODUCTS: loudspeaking

RING COMMUNICATIONS INC.

57 Trade Zone Drive
Ronkonkoma, NY 11779
(516) 585-7464 FAX: (516) 585-7410
President: Peter McLean; Vice President: Craig
Krsanac; Vice President: Kjell (Ken) Solem
Monfort Electronic Marketing, Indianapolis, IN
317-872-8877
EESCO Systems, Inc., Los Angeles, CA 213-666-9601
Klumpp Sales Company, Jacksonville, FL
904-287-5205
The TK Group, Inc., Loveland, CO 303-669-1008
Avwest, Inc., Fountain Hills, AZ 602-946-1811
Gustafson Sales Company, Red Wing, MN 612-
388-4277
Corrigan Agency, Covington, LA 504-893-7455
Pacnor Marketing, Lynnwood, WA 206-771-6016
Kaitec Communications, N. Vancouver, BC
604-987-1597

**RTS Systems, A Telex Comm.
Company**

9600 Aldrich Avenue South
Minneapolis, MN 55420
(612) 884-4051 FAX: (612) 884-0043
President: Jeffrey Wetherell; Vice President,
Marketing: John Schofield; V.P. Engineering &
Tech.: Joe Winebarger; Sales Manager: Murray
Porteous; Director of Engineering: William
Dennison
Dave Brand, Burbank, CA
Mike Guthrie, Wyckoff, NJ
Rick Fisher, Union Lake, MI
Sunrise Sales Company, LaMolle, IL 815-638-2660

**STENTOFON
COMMUNICATIONS, INC.**

6119 Connecticut Avenue, Kansas City, MO 64120
(816) 231-7200 (800) 654-3140 FAX: (816) 231-7203
President: Joe Green; Marketing Manager: David
E. Gill; National Sales Manager: Frederick Hall
Dan Rothrock, Kansas City, MO 816-231-7200
Tomas J. Reilly, Elmsford, NY 914-592-1048
Kerry L. Orr, Atlanta, GA 404-973-0736
Michael A. Wilcock, Glendora, CA 818-335-0543
Cartwright & Bean, Inc., Norcross, GA
404-368-0160
Dimension/ Point IX, Lewisville, TX 214-436-3706
Humble & Associates, Anaheim, CA 714-750-2248
LCA Sales Company, Tuckahoe, NY 914-961-4700
Levy, Grams, & Lassers, North Brook, IL
708-272-8500
Pearson & Pearson, Englewood, CO 303-770-0797
Roger Ponto Assoc., Inc., Kirkland, WA
206-821-2996
R.W. Kunz & Assoc., Inc., Prairie Village, KS
913-648-3535
R.W. Sales, St. Paul, MN 612-646-2710
Brian Trankle & Assoc., Belmont, CA 415-595-4004
F.M. Valenti, Inc. & Assoc., Nahant, CA
617-592-5300
Yocum Marketing Co., Inc., Mesa, AZ 602-834-3334
Weller Electronic Sales, Inc., Worthington, OH
614-885-7819
PRODUCTS: environmentally protected, headset/
handset, loudspeaking, telephone

Systems Wireless, Ltd.

465 Herndon Parkway, Herndon, VA 22070
(703) 471-7887 (800) 542-3332 FAX: (703) 437-1107
President: Theodore Bennett; Vice President:
William Sien; Sales Engineer - Wireless: John
Kowalski; Sales Engineer - Intercom: Pat Hamp;
Rental Manager: Tom Conner; Service Manager:
Jim Cahill
Sound Sales, Inc., Columbia, MD 301-964-1170
PRODUCTS: drive-thru

T-S-K ELECTRONICS, INC.

564 Young St, Tonawanda, NY 14150
(716) 693-3916 FAX: (716) 692-6433
President: Kevin Kedzierski; Marketing Manager:
Alan Gembola
JMS Marketing, Austin, TX 512-266-1113
PRODUCTS: environmentally protected, headset/
handset, loudspeaking, telephone

TALK-A-PHONE CO.

5013 N. Kedzie Ave., Chicago, IL 60625
(312) 539-1100 FAX: (312) 539-1241
Vice President: Samuel Shanes; Sales Manager:
Dan F. Kagan; President: Z. Liberman
JMS Marketing, Austin, TX 512-266-1113
PRODUCTS: drive-thru, environmentally
protected, headset/ handset, loudspeaking

TELECALL AMERICA

14620 NE 95th Street
Redmond, WA 98052
(206) 881-2742 (800) 752-2860 FAX: (206) 881-3085
President: Hiko Shinoda; Vice President: Nanci
Brooks
Palmieri Associates Inc., Fairfield, NJ 201-882-
1266
Henry W. Phillips Co., Inc., Roswell, GA 404-992-
3070
David H. Brothers Co., Inc., Finksburg, MD 301-
833-0920
Leslie's, Elgin, IL 708-697-6677
Pacific Group, Pasadena, CA 818-577-0738
JMS Marketing, Austin, TX 512-266-1113
PRODUCTS: loudspeaking, telephone

THE NEW STANDARD in INTERCOM SPEAKER STATIONS!

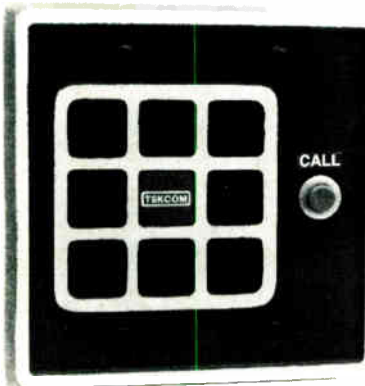

T-S-K's SERIES 100

*"a unique and preferable
alternative to the same
old stainless steel plates"*

F. HAAKE • CSI - CHICAGO, IL

- CAST ALUMINUM CONSTRUCTION
- STYLISH APPEARANCE
- SUPERB SOUND QUALITY
- STANDARD TWO GANG SIZE

CALL OR WRITE
FOR MORE INFORMATION

T-S-K ELECTRONICS, INC.
564 YOUNG ST. • P.O. BOX 190
TONAWANDA, NY 14151
716-693-3916 • FAX: 716-692-6433

SPONSOR



Circle 278 on Reader Response Card

SOUND & COMMUNICATIONS BLUE BOOK 91/92

TELEX COMMUNICATIONS, INC.

9600 Aldrich Avenue South
Minneapolis, MN 55420
(612) 884-4051 FAX: (612) 884-0043
President: Jeffrey Wetherell; Vice President
Marketing: John Schofield; Vice President Sales:
Dan Dantzler; Director of Marketing: Don
Mereen; Manager/Advertising & Mkt'g: Ron
Taylor
WesTech Marketing, Culver City, CA 213-870-9286
Bencsik Associates, Ocala, FL 904-732-9775
Burcaw Company & Associates, Warren, MI 313-
573-4605
SAGA, Oswego, NY 315-343-5739
Monfort Electronic Marketing, Indianapolis, IN
317-872-8877
Murphy & Cotta, Inc., Atlanta, GA 404-875-2525
Northland Associates, Moorhead, MN 218-233-
4616
Rancilio Associates, Inc., St. Louis, MO 314-845-
0202
J.Y. Schoonmaker Company, Dallas, TX 214-349-
1650
Sigmet Corporation, Valley Forge, PA 215-783-
6666
Weller Electronic Sales, Worthington, OH 614-
895-7819
Ziskind Associates, Rolling Meadows, IL 312-577-
1624
White Radio Ltd., Burlington, ON 416-632-6894
Silver Peak Marketing, Denver, CO 303-467-9042
PacNor Marketing, Lynnwood, WA 206-771-6016
PRODUCTS: drive-thru, environmentally
protected, headset/ handset, loudspeaking

TOA ELECTRONICS, INC.

601 Gateway Blvd. Suite 300
P.O. Box 2047
San Francisco, CA 94080
(415) 588-2538 (800) 733-4750 FAX: (415) 588-3349
President: Yoshiro Ishida; Director, Audio
Products Div.: Richard Krochmal; Director,
Comm. Systems Div.: Al Burns; Mgr., Marketing
Development: Jeff Pallin; Manager, Western
Division: Bill Ford; Manager Engineering
Services: Bob Sweet
Chuck McGregor - Product Consit, Morris Plains,
NJ 201-829-7047
John Murray-Eng.Snd. Mktg. Dev, Springfield, OH
513-324-1993
Bob Hager-Eastern Regional Mgr, Rosewell, GA
404-552-7624
Linda Wick-Central Reg. Mgr., Kansas City, MO
816-453-5775
Robert Slaughter-Cntrl Div Mgr, Houston, TX 713-
460-3678
Pete Newmark-West Regional Mgr., Mesa, AZ
602-981-0050
Waiter Best, Eastern Reg. Mgr., Sussex, NJ 201-
702-0068
PRODUCTS: environmentally protected, headset/
handset, loudspeaking, telephone

**Order More
Blue Books
Now!**

**Alphone Corp.**

1700 130th Ave. NE, Bellevue, WA 98005
(206) 455-0510 FAX: (206) 455-0071
President: Jun Matsumoto; Vice President,
Marketing: Harry Quanz; Vice President, Sales:
Jim Morrison; Residential Sales Manager:
Stephen Birgh; Commercial Sales Manager: John
Mosebar
Alphone East Coast Reg. Office, Rochelle Park, NJ
201-343-6115
Precide, Morbio Inferiore, Switzerland, 914-31734
PRODUCTS: console, microprocessor, multi-
channel, paging, talkback, telephone, video

Alpha Communications

89-D Cabot Court, Hauppauge, NY 11788-3717
(516) 434-8080 (800) 666-4800 FAX: (516) 434-8334
President: Mark S. Goldberg; Vice President:
Madelyn R. Goldberg; Office Manager: Rose
Tassone
Sound Sales, Inc., Columbia, MD 301-964-1170
PRODUCTS: microprocessor, paging, talkback,
telephone, video

APPLIED TECHNICAL SYSTEMS

815 King Pl., Shreveport, LA 71115
(318) 868-7413 (800) 444-7161 FAX: (318) 631-7613
President: Jim Reccelli; Vice President: Richard
Davis
C.L. Pugh & Associates, Cleveland, OH 216-238-
1777
Total Marketing, Fort Worth, TX 817-560-3970
Western Audio Sales, Burbank, CA 818-954-9300
PRODUCTS: clock, microprocessor, paging

Cornell Electronic Products, Inc.

4911 W. Good Hope Road
P.O. Box 23411
Milwaukee, WI 53223-0411
(414) 351-4660 FAX: (414) 351-4657
President: Donald J. Glaubitz; Vice President:
Gary M. Butler; Sales Manager: Pauline A. Haack;
Accounting: Thelma M. Plunkett; Production
Manager: Joel Karls
Richard S. Pass Associates, Philadelphia, PA 215-
757-6100
Dick Bellew Sales, Dallas, TX 214-644-7881
Winchester Electronic Sales, Atlanta, GA 404-392-
0200
Cartwright & Bean, Orlando, FL 407-889-9100
Rancilio Associates, St. Louis, MO 314-845-0202
Vector Corp., Seattle, WA 206-368-8400
Kingston Sales, Indianapolis, IN 317-876-2545
Bidwell-Schwartz Associates, Gardena, CA 213-
770-0300
Yocum Marketing, Mesa, AZ 602-834-3334
Avcom, Inc., North Olmstead, OH 216-777-2060
Kodo Associates, Minneapolis, MN 612-881-1255
W.A. Hendrickson Co., North Scituate, MA 617-
545-0652
LSM Associates, Phelps, NY 315-548-4891
R & S Sales, Rockville Ctr., NY 516-678-6887
PRODUCTS: paging, talkback

Delta Communications Co.

P.O. Box 99281
Tacoma, WA 99499
(206) 582-2201
Pres. Owner: Sid. C. Flothe
Edwards Company, Inc., Livonia, MI 313-458-7777
PRODUCTS: console, multi-channel, paging,
talkback, telephone

Door Alarm Devices Corp.

20 Lucon Drive
Deer Park, NY 11729
(516) 586-2400 (800) DADCO-NY FAX: (516) 242-
0611
President: B.B. Harman; Chief Engineer: Z.
Nadeem
Edwards Company, Inc., Livonia, MI 313-458-7777
PRODUCTS: paging

Dukane Corp.

2900 Dukane Drive, St. Charles, IL 60174
(708) 584-2300 FAX: (708) 584-2370
President/C.E.O.: J. McWilliams Stone Jr.;
Pres./Comm. Systems Division: Steven L. Deppe;
National Sales Director: Warren T. Anderson;
Service Manager: Cliff Carlson
Wally Smutts, Toronto, ON 519-748-5352
Doug Fellabaum, Sycamore, IL 815-895-7573
Ken Lind, Boston, MA 617-235-6817
Pete Kendall, Jacksonville, FL 904-262-6025
Jim Lacey, Moreno Valley, CA 714-243-1160
Jack Brown, Dallas, TX 214-943-7528
Sanford Lange, Indianapolis, IN 317-251-3112
PRODUCTS: clock, console, microprocessor,
multi-channel, paging, talkback, telephone

DELTA COM 2600

School & Institutional Intercom Systems



- Solid State/Modular Design
- Dual-Channel Capability
- Two-Channel Telecom Option
- Selective Time-Tone Option
- Includes AM-FM Cassette
- Lightweight — Small Size
- No Hidden Extras—Completely
Factory-Assembled

U.L. LISTED

DELTA COMMUNICATIONS, INC.
7852 78th Avenue SW
Tacoma, WA 98498
(206) 582-2201

Dealer Inquiries Welcome

Circle 289 on Reader Response Card

Elkay Industries

2925 North Market St.
St. Louis, MO 63106
(314) 535-1333 FAX: (314) 535-4118
CEO/ENG: Richard Hahn; President: Paul Grote;
Vice President, Sales: Martin Hahn; Engineering:
Jack Scilligo
Edwards Company, Inc., Livonia, MI 313-458-7777

Franklin Instrument/Time Systems

233 Railroad Drive
P.O. Box 2949
Warminster, PA 18974 (800) 321-2353 FAX: (215)
322-1022
Vice President-Time Systems: John W. Moyer;
Vice President-Engineering: Rick J. Fischer
ADCOM, Toronto, ON 416-251-3355

J.W. DAVIS AND CO.

3030 Canton Street
Dallas, TX 75226
(214) 651-7341 (800) 527-5705 FAX: (214) 939-0328
President: Harvey Earp; Vice President, Sales:
Jack W. Tucker; Chief Engineer: Eric Simonson
Multi-Technical Reps., Brainerd, MN 218-828-9483
PRODUCTS: console, paging, talkback, telephone

Jeron Electronic Systems, Inc.

1743 W. Rosehill Drive, Chicago, IL 60660
(312) 275-1900 (800) 621-1903 FAX: (312) 275-0283
President: Jerome Chesnut; Vice President:
Matthew Chesnut; Secretary: Elizabeth Chesnut
ADCOM, Toronto, ON 416-251-3355
PRODUCTS: console, paging

LEE DAN COMMUNICATIONS, INC.

155 Adams Avenue
Hauppauge, NY 11788-3699
(516) 231-1414 (800) 533-3261 FAX: (516) 231-1498
President: Leon Goldberg; Vice President
Operations: Lawrence J. Goldberg; V.P Finance &
Administration: David H. Goldberg; Senior
Technician: Sanford Hoffman; Office Manager:
Rita Kaplan; Sr. Sales/Service Associate: Susan
Leon
C.L. Pugh & Associates, Cleveland, OH 216-238-
1777
PRODUCTS: microprocessor, multi-channel,
paging, talkback, video

MaxIVOX

438 Papin
Ste-Foy, QU G1P 3T9
(418) 657-2220 FAX: (418) 657-7977
General Manager: Denis Paquet; Director of
Production: Gilles Corriveau; Director of R & D:
Christian Guay; Comptroller: Richard Plourde;
Director/ St. Leonard Branch: Norman Pelletier;
Market Manager/ Distribution: Alain Turcot
MaxIVox Inc., Montreal, QU 514-321-3131
Audio Industrial Saguenay, Jonquiere, QU 418-
547-4716
Frechette Communication, Sherbrooke, QU 819-
562-1297
Capello Audio Electronics, Ottawa, ON 613-739-
7939
Telesound Systems Limited, Saskatoon, SK 306-
933-4990
Loomis and Associates, Fremont, CA 415-683-
0883

Paso Sound Products, Inc.

14 First Street
Pelham, NY 10803
(914) 738-4800 (800) 231-3034 FAX: (914) 738-3954
Executive Vice President: Paul Mastrangelo;
Product Manager: Ken O'Brien; Credit Manager:
Marilyn Beckerson; Operations Manager:
Anthony Squeglla
Anderson Sales, Braintree, MA 617-848-9194
Jack Mesnick Sales, Liverpool, NY 315-622-3211
Palmer Associates, Fairfield, NJ 201-882-1266
Weller Electronic Sales, Inc., Worthington, OH
614-885-7819
Lienau Associates, Columbia, MD 301-621-4113
MJA Marketing, St. Charles, MO 314-447-7111
Northland Assoc., Moorehead, MN 218-233-4616
Allwest Sound & Communication, Camarillo, CA
805-388-7745
Dimension Pt. IX Marketing, Katy, TX 713-578-9277
Mountain Representatives, Denver, CO 303-333-
7745
Miguel Lopez, Hialeah, FL 305-822-6853
Paco Electronics, Ltd., Markham, ON 416-475-0740
Robert Milsk Co., Southfield, MI 313-354-3310
Marketline Inc., Snelville, GA 404-972-9048
Hawkins-Frederickson Assoc., Maitland, FL 407-
831-2474
Lintern Associates, Naperville, IL 708-904-1225
Robert Milsk Co., Indianapolis, IN 317-842-3400
PRODUCTS: multi-channel, paging

**Find Your Suppliers in the
Sound & Communications
Blue Book**

MORE THAN JUST TALK!

CSI voice activated intercom systems offer high reliability, fast delivery, service support and more.

If you need high quality voice communications without the annoyance of push button operation, CSI intercoms may be the solution. CSI offers three systems with one to four control consoles and up to eight remote locations with all channels functioning with voice switching. The unique, relay-free, patented (U.S.A. patent #3-291-911) electronics system uses cool running, solid-state components with associated high reliability. The design has been proved in more than 100,000 installations in all types of environments, even in relatively noisy conditions.

For hands-on experience in hands-off voice switching intercoms, write us today.

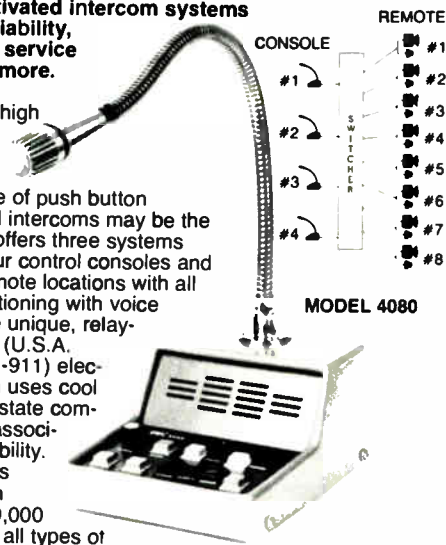

CSI COLUMBIA SCIENTIFIC INDUSTRIES CORPORATION

P.O. Box 203190 Austin, Texas 78720 Phone (512) 258-5191
FAX (512) 258-5004 WATS (800) 531-5003

Circle 41 on Reader Response Card

RESEARCH

SOUND COMMUNICATIONS

DOES IT LIKE NOBODY ELSE.
From our Annual Contractors Survey to our Year End Suppliers' Survey and Economic Report, we keep the industry informed by letting the industry voice its view.

... And now with product check, we're keeping you informed on a monthly basis of what is being used where and when.

When it comes to research, nothing compares to

SOUND COMMUNICATIONS

Protech Audio Corporation

Flowerfield Bldg. 1
St. James, NY 11780
(516) 584-5855 FAX: (516) 584-5904
Director of Marketing: Bill Murphy; Sales
Engineering: Joseph Giambone
Peregrine Southwest Reps, Houston, TX 713-589-
8481
First Choice Marketing, Seattle, WA 206-524-7344
Dimension/ Point IX, Lewisville, TX 214-436-3706
PRODUCTS: paging

Rauland-Borg Corp.

3450 W. Oakton St.
Skokie, IL 60076
(708) 679-0900 FAX: (708) 679-0625
President: William Krucks; Executive Vice
President: Kenneth James; National Sales
Manager: Harry Hahn; Marketing Manager:
Vince Novak
Jack Hollis, Geneva, IL 708-208-1488
Joe Clottl, Longwood, FL 407-767-2007
Frank Riha, Austin, TX 512-926-3646
Hank Plaisler, El Toro, CA 714-837-2626
Vince Ward, Vashon Island, WA 206-463-5582
Doug Warren, Newport News, VA 804-930-3217
Suzanne Graham, Kent, OH 216-678-7307
Mike Gulhan, E. Long Meadow, MA 413-525-6090

SONY CORP. OF AMERICA, A/V PRODUCTS

10833 Valley View Street
Cypress, CA 90630
(714) 229-4318 (800) 326-7669 FAX: (714) 229-4298
Vertical Markets Manager: T. Park; AV Product
Manager: A. Nitta; AV Sales Manager: K. Carr; AV
Product Support Spvr.: A. Ruppe; Management
Associate: D. Williams; Product Support
Coordinator: P. Penell
Cambridge Marketing, Westerville, OH 614-363-
9191
PRODUCTS: microprocessor, multi-channel,
paging, talkback

Stor-Com Inc.

5031 Linden Avenue
Dayton, OH 45432
(513) 252-8500 (800) 356-0368
President: Robert McDougall; Vice President
Engineering: Kurt Farmer
Karp Communications, Tampa, FL 813-968-7098
PRODUCTS: paging

T-S-K ELECTRONICS, INC.

564 Young St.
Tonawanda, NY 14150
(716) 693-3916 FAX: (716) 692-6433
President: Kevin Kedzierski; Marketing Manager:
Alan Gembola
JMS Marketing, Austin, TX 512-266-1113
PRODUCTS: console, multi-channel, paging,
talkback, telephone

TALK-A-PHONE CO.

5013 N. Kedzie Ave.
Chicago, IL 60625
(312) 539-1100 FAX: (312) 539-1241
Vice President: Samuel Shanes; Sales Manager:
Dan F. Kagan; President: Z. Liberman
JMS Marketing, Austin, TX 512-266-1113
PRODUCTS: multi-channel, paging, talkback

if your market is **schools**
the communications system should be:



Rauland TELECENTER®

if your market is **hospitals**
the nurse call system should be:



Rauland RESPONDER®

if your market is **correctional facilities**
the security communications should be:

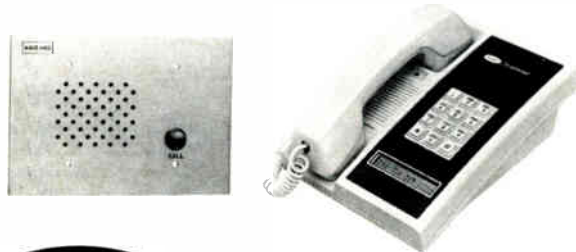

Rauland TELECENTER® TCS

let us show you why...call toll-free:

1-800-752-7725

OR USE THE READER SERVICE CARD

Rauland

RAULAND-BORG CORPORATION

3450 W. Oakton St., Skokie, IL 60076 • (708) 679-0900

In Canada: Rauland-Borg (Canada) Inc. • 6535 Millcreek Drive, Unit 5, Mississauga, Ont., Can. L5N 2M2

Circle 241 on Reader Response Card

World Radio History

TELECALL AMERICA

14620 NE 95th Street, Redmond, WA 98052
 (206) 881-2742 (800) 752-2860 FAX: (206) 881-3085
 President: Hiko Shinoda; Vice President: Nanci Brooks
 Palmieri Associates Inc., Fairfield, NJ
 201-882-1266
 Henry W. Phillips Co., Inc., Roswell, GA 404-992-3070
 David H. Brothers Co., Inc., Finksburg, MD 301-833-0920
 Leslie's, Elgin, IL 708-697-6677
 Pacific Group, Pasadena, CA 818-577-0738
 JMS Marketing, Austin, TX 512-266-1113
 PRODUCTS: microprocessor, multi-channel, paging, talkback, telephone, video

Telecor Inc.

1114 Westport Cr., Mississauga, ON L5T 1G1
 (416) 564-0801 FAX: (416) 564-0806
 Cambridge Marketing, Westerville, OH 614-363-9191

TELEX COMMUNICATIONS, INC.

9600 Aldrich Avenue South,
 Minneapolis, MN 55420
 (612) 884-4051 FAX: (612) 884-0043
 President: Jeffrey Wetherell; Vice President
 Marketing: John Schofield; Vice President Sales:
 Dan Dantzler; Director of Marketing: Don
 Meehen; Manager/Advertising & Mkt'g: Ron
 Taylor
 WesTech Marketing, Culver City, CA 213-870-9286
 Bencsik Associates, Ocala, FL 904-732-9775
 Burcaw Company & Associates, Warren, MI 313-573-4605
 SAGA, Oswego, NY 315-343-5739
 Monfort Electronic Marketing, Indianapolis, IN
 317-872-8877
 Murphy & Cotta, Inc., Atlanta, GA 404-875-2525
 Northland Associates, Moorhead, MN
 218-233-4616
 Rancillo Associates, Inc., St. Louis, MO
 314-845-0202
 J.Y. Schoonmaker Company, Dallas, TX
 214-349-1650
 Sigmat Corporation, Valley Forge, PA
 215-783-6666
 Weller Electronic Sales, Worthington, OH 614-885-7819
 Ziskind Associates, Rolling Meadows, IL 312-577-1624
 White Radio Ltd., Burlington, ON 416-632-6894
 Silver Peak Marketing, Denver, CO 303-467-9042
 PacNor Marketing, Lynnwood, WA 206-771-6016
 PRODUCTS: microprocessor, multi-channel, talkback

**TOA ELECTRONICS, INC.**

601 Gateway Blvd. Suite 300
 P.O. Box 2047
 S San Francisco, CA 94080
 (415) 588-2538 (800) 733-4750 FAX: (415) 588-3349
 President: Yoshiro Ishida; Director, Audio
 Products Div: Richard Krochmal; Director,
 Comm. Systems Div.: Al Burns; Mgr., Marketing
 Development: Jeff Pallin; Manager, Western

Division: Bill Ford; Manager Engineering
 Services: Bob Sweet
 Chuck McGregor- Product Constt, Morris Plains,
 NJ 201-829-7047
 John Murray-Eng.Snd. Mktg. Dev, Springfield, OH
 513-324-1993
 Bob Hager-Eastern Regional Mgr, Rosewell, GA
 404-552-7624
 Linda Wick-Central Reg. Mgr., Kansas City, MO
 816-453-5775
 Robert Slaughter-Cntrl Div Mgr, Houston, TX 713-460-3678
 Pete Newmark-West Regional Mgr., Mesa, AZ
 602-981-0050
 Walter Best, Eastern Reg. Mgr., Sussex, NJ 201-702-0068
 PRODUCTS: clock, microprocessor, multi-channel, paging, talkback, telephone

**Alphone Corp.**

1700 130th Ave. NE
 Bellevue, WA 98005
 (206) 455-0510 FAX: (206) 455-0071
 President: Jun Matsumoto; Vice President,
 Marketing: Harry Quanz; Vice President, Sales:
 Jim Morrison; Residential Sales Manager:
 Stephen Birgh; Commercial Sales Manager: John
 Mosebar
 Alphone East Coast Reg. Office, Rochelle Park, NJ
 201-843-6115
 Precide, Morbio Inferiore, Switzerland, 914-31734

BBE SOUND, INC.

5500 Bolsa Ave. Ste. #245
 Huntington Bch., CA 92649
 (714) 897-6766 (800) 233-8346 FAX: (714) 895-6728
 Chairman: John C. McLaren; National Sales
 Manager: Rob Rizzuto; Director of Engineering:
 Paul Gagon
 Marshank Sales Co., Los Angeles, CA 213-670-7071
 StarIn Marketing, Chesterton, IN 219-929-4127
 First Choice Marketing, Seattle, WA 206-365-4568
 The Henderson Company, Concord, MA 508-287-0020
 John B. Anthony Co., Stamford, CT 203-322-9202
 Nova Marketing, San Francisco, CA 415-952-0943
 PRODUCTS: processors

Clear-Com Intercom Systems

945 Camella St.
 Berkeley, CA 94710
 (415) 527-6666 FAX: (415) 527-6699
 President: Bob Cohen; National Sales Manager:
 Michael Goddard
 Clear-Com International, 415-932-8134
 John Anthony, Stamford, CT 203-322-9202
 PRODUCTS: handset, headset, loudspeaker,
 microprocessor, multi-channel, processors, radio
 interface, wireless

**Comtek**

357 West 2700 South
 Salt Lake City, UT 84115
 (801) 466-3463 FAX: (801) 484-6906
 President: Ralph Belgique; Applications
 Engineering: Steve Kartchner; Applications
 Engineering: Steve Dupalx; Service Manager:
 Laurel Robertson; Credit Manager: Dana
 Pelletier
 Edwards Company, Inc., Livonia, MI 313-458-7777
 PRODUCTS: IFB, wireless

ENVIRONMENTAL SOUND

31220 La Baya Dr., Bid. #110
 Westlake Vlg., CA 91362
 (818) 706-0228 FAX: (818) 889-5605
 President: Pascal Delbuck; Marketing: Ron
 Glatzhoffer; Plant Manager: Bill Ward
 Cambridge Marketing, Westerville, OH 614-363-9191
 PRODUCTS: loudspeaker

HM ELECTRONICS, INC.

6675 Mesa Ridge Road
 San Diego, CA 92121
 (619) 535-6060 FAX: (619) 552-0139
 General Sales Manager: Bruce Slammer; Western
 Regional Sales Mgr.: David VanEpps; Midwest
 Regional Sales Mgr.: John Debrocke; Eastern
 Regional Sales Mgr.: Mike Cerveny
 Derek Allen Associates, Toluca Lake, CA 818-840-8327
 A/V Marketing, Carmel, IN 317-846-1034
 John B. Anthony Company, Stamford, CT 203-322-9202
 ADCOM, Toronto, ON 416-251-3355
 PRODUCTS: handset, headset, IFB, loudspeaker,
 multi-channel, wireless

J.W. DAVIS AND CO.

3030 Canton Street
 Dallas, TX 75226
 (214) 651-7341 (800) 527-5705 FAX: (214) 939-0328
 President: Harvey Earp; Vice President, Sales:
 Jack W. Tucker; Chief Engineer: Eric Simonson
 Multi-Technical Reps., Brainerd, MN 218-828-9483
 PRODUCTS: loudspeaker

PORTLAND INSTRUMENT CORP.

6120 San Fernando Rd.
 Glendale, CA 91201
 (818) 500-0137 FAX: (818) 240-1828
 President: Ronald Fuller; Production Manager:
 Dick Herbert; Office Manager: Marcia Fuller;
 Controller: Ken Thiele; Service Department: Bill
 Brungard
 Bob White Associates, Solon, OH 216-248-1317
 Dimension/ Point IX, Lewisville, TX 214-436-3706
 PRODUCTS: handset, headset, IFB, loudspeaker,
 multi-channel, radio interface, wireless

Richardson Electronics Limited, SSD
3030 River Road
River Grove, IL 60171
(312) 625-2288 (800) 722-2288 FAX: (708) 452-5450
Vice President/ General Mgr.: Sal Rala; National
Sales Manager: Tom Brown; Director of
Operations: Charlene Woodward
Richardson Electronics Limited, Brooklyn, NY
718-692-5350
Richardson Electronics Limited,
Brampton, Canada,
Sunrise Sales Company, LaMoille, IL 815-638-2660
PRODUCTS: handset, headset, multi-channel,
processors, radio interface, VOX, wireless

ROH Products

6120 San Fernando Road
Glendale, CA 91201
(818) 500-0137 FAX: (818) 240-1828
General Manager: Richard F. Herbert;
Engineering Manager: Ronald Fuller
Atlantic Video Corp., Birmingham, AL
205-879-2555
A.F. Associates, Northvale, NJ 201-767-1200
Professional Products, Bethesda, MD
301-657-2141
Hoffman Video Systems, Los Angeles, CA
213-749-3311
Broadcasters Gen Store, Arlington, TX
817-795-3441
Karp Communications, Tampa, FL 813-968-7098

RTS Systems, A Telex Comm. Company

9600 Aldrich Avenue South
Minneapolis, MN 55420
(612) 884-4051 FAX: (612) 884-0043
President: Jeffrey Wetherell; Vice President,
Marketing: John Schofield; V.P. Engineering &
Tech.: Joe Winebarger; Sales Manager: Murray
Porteous; Director of Engineering: William
Dennison
Dave Brand, Burbank, CA
Mike Guthrie, Wyckoff, NJ
Rick Fisher, Union Lake, MI
Sunrise Sales Company, LaMoille, IL 815-638-2660

STENTOFON COMMUNICATIONS, INC.

6119 Connecticut Avenue
Kansas City, MO 64120
(816) 231-7200 (800) 654-3140 FAX: (816) 231-7203
President: Joe Green; Marketing Manager: David
E. Gill; National Sales Manager: Frederick Hall
Dan Rothrock, Kansas City, MO 816-231-7200
Thomas J. Reilly, Elmsford, NY 914-592-1048
Kerry L. Orr, Atlanta, GA 404-973-0736
Michael A. Wilcock, Glendora, CA 818-335-0543
Cartwright & Bean, Inc., Norcross, GA 404-368-
0160
Dimension/ Point IX, Lewisville, TX 214-436-3706
Humble & Associates, Anaheim, CA 714-750-2248
LCA Sales Company, Tuckahoe, NY 914-961-4700
Levy, Grams, & Lassers, North Brook, IL 708-272-
8500
Pearson & Pearson, Englewood, CO 303-770-0797
Roger Ponto Assoc., Inc., Kirkland, WA 206-821-
2996
R.W. Kunz & Assoc., Inc., Prairie Village, KS 913-
648-3535
R.W. Sales, St. Paul, MN 612-646-2710
Brian Trankle & Assoc., Belmont, CA 415-595-4004
F.M. Valenti, Inc. & Assoc., Nahant, CA 617-592-
5300
Yocum Marketing Co., Inc., Mesa, AZ 602-834-3334
Weller Electronic Sales, Inc., Worthington, OH
614-885-7819
PRODUCTS: microprocessor, multi-channel, radio
interface, VOX

Systems Wireless, Ltd.

465 Herndon Parkway, Herndon, VA 22070
(703) 471-7887 (800) 542-3332 FAX: (703) 437-1107
President: Theodore Bennett; Vice President:
William Sien; Sales Engineer- Wireless: John
Kowalski; Sales Engineer- Intercom: Pat Hamp;
Rental Manager: Tom Conner; Service Manager:
Jim Cahill
Sound Sales, Inc., Columbia, MD 301-964-1170
PRODUCTS: handset, headset, multi-channel,
processors, radio interface, wireless

Technical Projects, Inc.

P.O. Box 3247, Barrington, IL 60010
(708) 381-5350 (800) 562-5872 FAX: (708) 381-4360
President: Glenn Mullis; Secretary/Treasurer:
Sibbellina Mullis; Tech.: Mike Barrett
Watt Marketing, Allentown, PA 215-820-7586
Professional Audio Marketing, Melville, NY 516-
367-8620
Audio Marketing Associates, Brecksville, OH 216-
526-2426
Professional Sound & Lighting, Lakewood, CO
303-986-5999
JMS Marketing, Austin, TX 512-266-1113
PRODUCTS: handset, headset, loudspeaker,
multi-channel, radio interface

TELECALL AMERICA

14620 NE 95th Street, Redmond, WA 98052
(206) 881-2742 (800) 752-2860 FAX: (206) 881-3085
President: Hiko Shinoda; Vice President: Nanci
Brooks
Palmieri Associates Inc., Fairfield, NJ 201-882-
1266
Henry W. Phillips Co., Inc., Roswell, GA 404-992-
3070
David H. Brothers Co., Inc., Finksburg, MD 301-
833-0920
Leslie's, Elgin, IL 708-697-6677
Pacific Group, Pasadena, CA 818-577-0738
JMS Marketing, Austin, TX 512-266-1113
PRODUCTS: headset, loudspeaker,
microprocessor, multi-channel

TELEX COMMUNICATIONS, INC.

9600 Aldrich Avenue South
Minneapolis, MN 55420
(612) 884-4051 FAX: (612) 884-0043
President: Jeffrey Wetherell; Vice President
Marketing: John Schofield; Vice President Sales:
Dan Dantzier; Director of Marketing: Don
Mereen; Manager/Advertising & Mkt'g: Ron
Taylor
Westech Marketing, Culver City, CA 213-870-9286
Bencsik Associates, Ocala, FL 904-732-9775
Burcaw Company & Associates, Warren, MI 313-
573-4605
SAGA, Oswego, NY 315-343-5739
Monfort Electronic Marketing, Indianapolis, IN
317-872-8877
Murphy & Cotta, Inc., Atlanta, GA 404-875-2525
Northland Associates, Moorhead, MN 218-233-
4616
Rancilio Associates, Inc., St. Louis, MO 314-845-
0202
J.Y. Schoonmaker Company, Dallas, TX 214-349-
1650
Sigmert Corporation, Valley Forge, PA 215-783-
6666
Weller Electronic Sales, Worthington, OH 614-
885-7819
Ziskind Associates, Rolling Meadows, IL 312-577-
1624
White Radio Ltd., Burlington, ON 416-632-6894
Silver Peak Marketing, Denver, CO 303-467-9042
PacNor Marketing, Lynnwood, WA 206-771-6016
PRODUCTS: handset, headset, IFB, loudspeaker,
microprocessor, multi-channel, VOX, wireless

TOA ELECTRONICS, INC.

601 Gateway Blvd. Suite 300
P.O. Box 2047
S San Francisco, CA 94080
(415) 588-2538 (800) 733-4750 FAX: (415) 588-3349
President: Yoshiro Ishida; Director, Audio
Products Div: Richard Krochmal; Director,
Comm. Systems Div.: Al Burns; Mgr., Marketing
Development: Jeff Pallin; Manager, Western
Division: Bill Ford; Manager Engineering
Services: Bob Sweet
Chuck McGregor- Product Const, Morris Plains,
NJ 201-829-7047
John Murray-Eng.Snd. Mktg. Dev, Springfield, OH
513-324-1993
Bob Hager-Eastern Regional Mgr, Rosewell, GA
404-552-7624
Linda Wick-Central Reg. Mgr., Kansas City, MO
816-453-5775
Robert Slaughter-Cntrl Div Mgr, Houston, TX 713-
460-3678
Pete Newmark-West Regional Mgr., Mesa, AZ
602-981-0050
Walter Best, Eastern Reg. Mgr., Sussex, NJ 201-
702-0068
PRODUCTS: handset, headset, loudspeaker,
microprocessor, multi-channel, processors, radio
interface, VOX



Alphone Corp.

1700 130th Ave. NE, Bellevue, WA 98005
(206) 455-0510 FAX: (206) 455-0071
President: Jun Matsumoto; Vice President,
Marketing: Harry Quanz; Vice President, Sales:
Jim Morrison; Residential Sales Manager:
Stephen Birgh; Commercial Sales Manager: John
Mosebar
Alphone East Coast Reg. Office, Rochelle Park, NJ
201-843-6115
Precide, Morbio Inferiore, Switzerland, 914-31734
PRODUCTS: loudspeaking, telephone, video/
audio

Alpha Communications

89-D Cabot Court, Hauppauge, NY 11788-3717
(516) 434-8080 (800) 666-4800 FAX: (516) 434-8334
President: Mark S. Goldberg; Vice President:
Madelyn R. Goldberg; Office Manager: Rose
Tassone
Sound Sales, Inc., Columbia, MD 301-964-1170
PRODUCTS: custom, digital, loudspeaking,
microprocessor, telephone, video/ audio, VOX

ATLAS/SOUNDOLIER

1859 Intertech Dr., Fenton, MO 63026
(314) 349-3110 (800) 876-7337 FAX: (314) 349-1251
VP/Marketing & Sales: Charles Gushwa;
VP/Marketing Consultant: Herbert M. Jaffe;
National Sales Manager: Bud Waters; Eastern
Sales Manager: Tony Satarlano; Western Sales
Manager: Jeff Garstick; OEM Sales Manager:
Larry Damato
Precide, Morbio Inferiore, Switzerland, 914-31734
PRODUCTS: loudspeaking, telephone

SPLIT PERSONALITY.

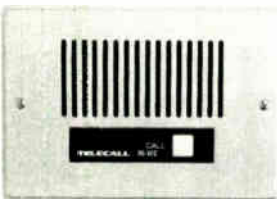
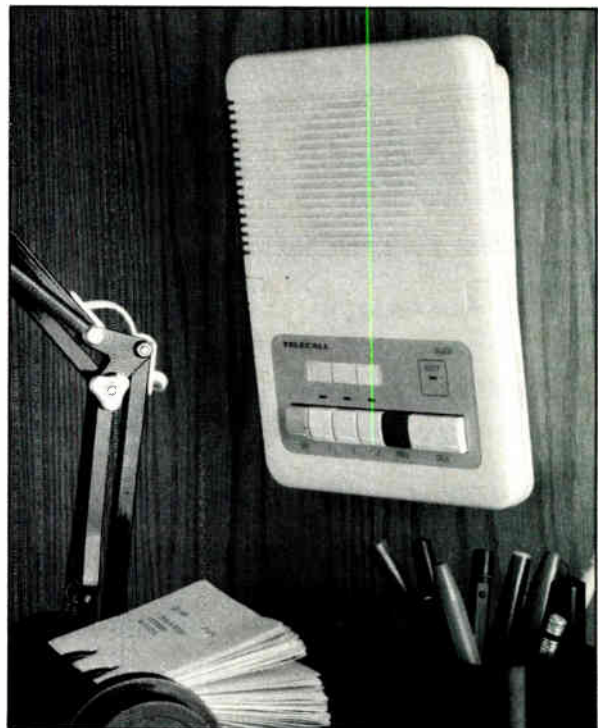
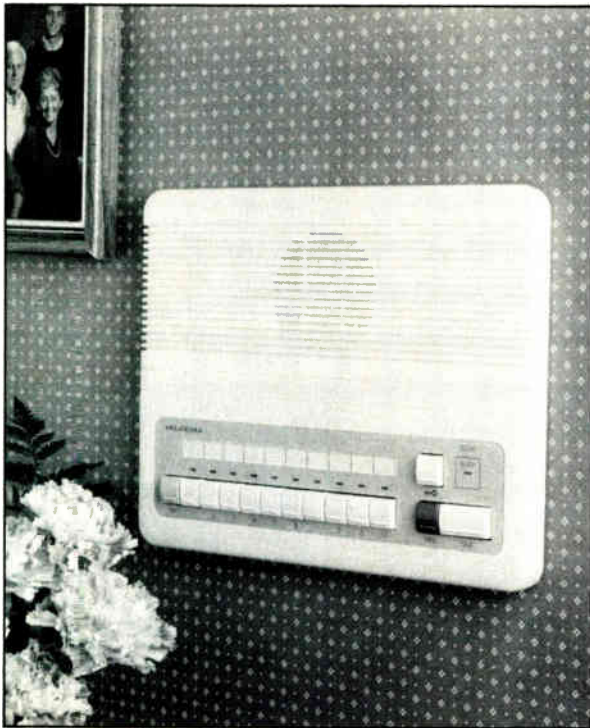

Whether your customers' intercom needs are commercial or residential, the 95 Series intercom from Telecall is one flexible system.

Available in 3, 6 and 10-call masters, communication is possible between master to master and master to sub station. With 3 weather resistant outdoor and 4 different indoor subs,

we've got your customers covered. When flush mounted, all indoor stations are very unobtrusive—only $\frac{3}{4}$ " deep.

To save both time and money, you can tie the master stations directly to an existing PA system without an adaptor.

For more information on the 95 Series, including many optional features, please call us toll-free at 1-800-752-2860.



Circle 207 on Reader Response Card

Bogen Communications, Inc.

50 Spring Street
P.O. Box 575, Ramsey, NJ 07446
(201) 934-8500 FAX: (201) 934-9832
President: John H. Ochtera; Vice President, Sales & Mktg: David A. Chambers
Scott Whipple, Columbus, OH 614-272-1689
Sam Blasl, Ramsey, NJ 201-934-8500
Walter Spencer, Ramsey, NJ 201-934-8500
Fred Yosenick, Woodland, CA 916-668-6311
Edwards Company, Inc., Livonia, MI 313-458-7777
PRODUCTS: loudspeaking, multi-channel, telephone

Columbia Scientific Industries Corp

11950 Jollyville Rd.
P.O. Box 203190, Austin, TX 78720
(512) 258-5191 (800) 531-5003 FAX: (512) 258-5004
President: Gerald Phillips; Marketing Director: James M. Cotton
Sunrise Sales Company, LaMolle, IL 815-638-2660
PRODUCTS: multi-channel, VOX

Dukane Corp.

2900 Dukane Drive, St. Charles, IL 60174
(708) 584-2300 FAX: (708) 584-2370
President/C.E.O.: J. McWilliams Stone Jr.; Pres./Comm. Systems Division: Steven L. Deppe; National Sales Director: Warren T. Anderson; Service Manager: Cliff Carlson
Wally Smutts, Toronto, ON 519-748-5352
Doug Fellabaum, Sycamore, IL 815-895-7573
Ken Lind, Boston, MA 617-235-6817
Pete Kendall, Jacksonville, FL 904-262-6025
Jim Lacey, Moreno Valley, CA 714-243-1160
Jack Brown, Dallas, TX 214-943-7528
Sanford Lange, Indianapolis, IN 317-251-3112
PRODUCTS: loudspeaking, VOX

Fisher Berkeley Corporation

955 Third St, Oakland, CA 94607
(415) 835-7575 FAX: (415) 271-8297
President: Robert S. Fisher; Sr. Vice President: Wood H. Wymond; Vice President-Engineering: Robert T. Shipley; Sales Coordination Manager: Richard V. Flanagan; Sales Engineer: Michael D. Lagrimas; Sales Engineer: Michael J. Mack
Arthur E. Tilley, Jr., Fayetteville, PA 717-352-8432
John D. Larounis, Barrington, IL 708-382-8233
John Corrigan, Corrigan Agency, Covington, LA 504-893-7455
Greg Dzubay & Assoc., Glendale, AZ 800-999-0006

Gilderfluke & Co.

820 Thompson Avenue #35
Glendale, CA 91201
(818) 546-1618 FAX: (818) 546-1619
Owner: Doug Mobley; Marketing: Denise Dougherty
Greg Dzubay & Assoc., Glendale, AZ 800-999-0006
PRODUCTS: custom, digital, microprocessor, multi-channel, programmable

HM ELECTRONICS, INC.

6675 Mesa Ridge Road, San Diego, CA 92121
(619) 535-6060 FAX: (619) 552-0139
General Sales Manager: Bruce Slemmer; Western Regional Sales Mgr.: David VanEpps; Midwest Regional Sales Mgr.: John Debrocke; Eastern Regional Sales Mgr.: Mike Cerveney
Derek Allen Associates, Toluca Lake, CA 818-840-8327
A/V Marketing, Carmel, IN 317-846-1034
John B. Anthony Company, Stamford, CT 203-322-9202
ADCOM, Toronto, ON 416-251-3355
PRODUCTS: telephone, wireless

J.W. DAVIS AND CO.

3030 Canton Street
Dallas, TX 75226
(214) 651-7341 (800) 527-5705 FAX: (214) 939-0328
President: Harvey Earp; Vice President, Sales: Jack W. Tucker; Chief Engineer: Eric Simonson
Multi-Technical Reps., Brainerd, MN 218-828-9483
PRODUCTS: closed-circuit, loudspeaking, multi-channel, telephone

Jeron Electronic Systems, Inc.

1743 W. Rosehill Drive
Chicago, IL 60660
(312) 275-1900 (800) 621-1903 FAX: (312) 275-0283
President: Jerome Chesnul; Vice President: Matthew Chesnul; Secretary: Elizabeth Chesnul
ADCOM, Toronto, ON 416-251-3355
PRODUCTS: custom, digital, loudspeaking, telephone, video/ audio, VOX

**LEE DAN COMMUNICATIONS, INC.**

155 Adams Avenue
Hauppauge, NY 11788-3699
(516) 231-1414 (800) 533-3261 FAX: (516) 231-1498
President: Leon Goldberg; Vice President Operations: Lawrence J. Goldberg; V.P. Finance & Administration: David H. Goldberg; Senior Technician: Sanford Hoffman; Office Manager: Rita Kaplan; Sr. Sales/Service Associate: Susan Leon
C.L. Pugh & Associates, Cleveland, OH 216-238-1777
PRODUCTS: closed-circuit, custom, digital, loudspeaking, microprocessor, multi-channel, video/ audio, wireless

Petcom

461 Manitou Dr.
Kitchener, ON N2C 1L5
(519) 748-5352 FAX: (519) 748-9221
Camden Marketing, Pierre Fonds, QU 514-683-3377

PORTLAND INSTRUMENT CORP.

6120 San Fernando Rd.
Glendale, CA 91201
(818) 500-0137 FAX: (818) 240-1828
President: Ronald Fuller; Production Manager: Dick Herbert; Office Manager: Marcia Fuller; Controller: Ken Thiele; Service Department: Bill Brungard
Bob White Associates, Solon, OH 216-248-1317
Dimension/ Point IX, Lewisville, TX 214-436-3706
PRODUCTS: custom, IFB, loudspeaking, multi-channel

**Order the 1992
Music & Sound Buyer's
Guide now!**

RING COMMUNICATIONS INC.

57 Trade Zone Drive
Ronkonkoma, NY 11779
(516) 585-7464 FAX: (516) 585-7410
President: Peter McLean; Vice President: Craig Krsanac; Vice President: Kjell (Ken) Solem
Monfort Electronic Marketing, Indianapolis, IN 317-872-8877
EESCO Systems, Inc., Los Angeles, CA 213-666-9601
Klumpp Sales Company, Jacksonville, FL 904-287-9605
The TK Group, Inc., Loveland, CO 303-669-1008
Awwest, Inc., Fountain Hills, AZ 602-946-1811
Gustafson Sales Company, Red Wing, MN 612-388-4277
Corrigan Agency, Covington, LA 504-893-7455
Pacnor Marketing, Lynnwood, WA 206-771-6016
Kaltec Communications, N. Vancouver, BC 604-987-1597

RTS Systems, A Telex Comm. Company

9600 Aldrich Avenue South
Minneapolis, MN 55420
(612) 884-4051 FAX: (612) 884-0043
President: Jeffrey Wetherell; Vice President, Marketing: John Schofield; V.P. Engineering & Tech.: Joe Winebarger; Sales Manager: Murray Porteous; Director of Engineering: William Dennison
Dave Brand, Burbank, CA
Mike Guthrie, Wyckoff, NJ
Rick Fisher, Union Lake, MI
Sunrise Sales Company, LaMolle, IL 815-638-2660

STENTOFON COMMUNICATIONS, INC.

6119 Connecticut Avenue, Kansas City, MO 64120
(816) 231-7200 (800) 654-3140 FAX: (816) 231-7203
President: Joe Green; Marketing Manager: David E. Gill; National Sales Manager: Frederick Hall
Dan Rothrock, Kansas City, MO 816-231-7200
Tomas J. Reilly, Elmsford, NY 914-592-1048
Kerry L. Orr, Atlanta, GA 404-973-0736
Michael A. Wilcock, Glendora, CA 818-335-0543
Cartwright & Bean, Inc., Norcross, GA 404-368-0160
Dimension/ Point IX, Lewisville, TX 214-436-3706
Humble & Associates, Anaheim, CA 714-750-2248
LCA Sales Company, Tuckahoe, NY 914-961-4700
Levy, Grams, & Lassers, North Brook, IL 708-272-8500
Pearson & Pearson, Englewood, CO 303-770-0797
Roger Ponto Assoc., Inc., Kirkland, WA 206-821-2996
R.W. Kunz & Assoc., Inc., Prairie Village, KS 913-648-3535
R.W. Sales, St. Paul, MN 612-646-2710
Brian Trankle & Assoc., Belmont, CA 415-595-4004
F.M. Valenti, Inc. & Assoc., Nahant, CA 617-592-5300
Yocum Marketing Co., Inc., Mesa, AZ 602-834-3334
Weller Electronic Sales, Inc., Worthington, OH 614-885-7819
PRODUCTS: custom, loudspeaking, microprocessor, multi-channel, programmable, VOX

Studio Technologies, Inc.

5520 W. Touhy Ave, Skokie, IL 60077
(708) 676-9177 FAX: (708) 982-0747
President: Gordon Kapes; Communications Manager: Barbara Govednik
Camden Marketing, Pierre Fonds, QU 514-683-3377
PRODUCTS: IFB

Systems Wireless, Ltd.

465 Herndon Parkway, Herndon, VA 22070
 (703) 471-7887 (800) 542-3332 FAX: (703) 437-1107
 President: Theodore Bennett; Vice President:
 William Sien; Sales Engineer- Wireless: John
 Kowalski; Sales Engineer- Intercom: Pat Hamp;
 Rental Manager: Tom Conner; Service Manager:
 Jim Cohill
 Sound Sales, Inc., Columbia, MD 301-964-1170
 PRODUCTS: IFB, wireless

T-S-K ELECTRONICS, INC.

564 Young St., Tonawanda, NY 14150
 (716) 693-3916 FAX: (716) 692-6433
 President: Kevin Kedzlerski; Marketing Manager:
 Alan Gembola
 JMS Marketing, Austin, TX 512-266-1113
 PRODUCTS: closed-circuit, custom,
 loudspeaking, multi-channel, VOX

TALK-A-PHONE CO.

5013 N. Kedzie Ave., Chicago, IL 60625
 (312) 539-1100 FAX: (312) 539-1241
 Vice President: Samuel Shanes; Sales Manager:
 Dan F. Kagan; President: Z. Liberman
 JMS Marketing, Austin, TX 512-266-1113
 PRODUCTS: loudspeaking, multi-channel, VOX

TELECALL AMERICA

14620 NE 95th Street
 Redmond, WA 98052
 (206) 881-2742 (800) 752-2860 FAX: (206) 881-3085
 President: Hiko Shinoda; Vice President: Nanci
 Brooks
 Palmieri Associates Inc., Fairfield, NJ 201-882-1266
 Henry W. Phillips Co., Inc., Roswell, GA 404-992-3070
 David H. Brothers Co., Inc., Finksburg, MD
 301-833-0920
 Leslie's, Elgin, IL 708-697-6677
 Pacific Group, Pasadena, CA 818-577-0738
 JMS Marketing, Austin, TX 512-266-1113
 PRODUCTS: custom, digital, loudspeaking,
 microprocessor, multi-channel, telephone,
 video/ audio

TELEX COMMUNICATIONS, INC.

9600 Aldrich Avenue South
 Minneapolis, MN 55420
 (612) 884-4051 FAX: (612) 884-0043
 President: Jeffrey Wetherell; Vice President
 Marketing: John Schofield; Vice President Sales:
 Dan Dantzier; Director of Marketing: Don
 Merene; Manager/Advertising & Mkt'g: Ron
 Taylor
 WesTech Marketing, Culver City, CA 213-870-9286
 Bencsik Associates, Ocala, FL 904-732-9775
 Burcaw Company & Associates, Warren, MI 313-
 573-4605
 SAGA, Oswego, NY 315-343-5739
 Monfort Electronic Marketing, Indianapolis, IN
 317-872-8877
 Murphy & Cotta, Inc., Atlanta, GA 404-875-2525
 Northland Associates, Moorhead, MN
 218-233-4616
 Rancillo Associates, Inc., St. Louis, MO 314-845-0202
 J.Y. Schoonmaker Company, Dallas, TX 214-349-1650
 Sigmnet Corporation, Valley Forge, PA 215-783-6666
 Weller Electronic Sales, Worthington, OH 614-885-
 7819
 Ziskind Associates, Rolling Meadows, IL 312-577-
 1624
 White Radio Ltd., Burlington, ON 416-632-6894
 Silver Peak Marketing, Denver, CO 303-467-9042
 PacNor Marketing, Lynnwood, WA 206-771-6016
 PRODUCTS: closed-circuit, custom, IFB,
 loudspeaking, microprocessor, multi-channel,
 programmable, telephone, VOX

Ultrak

660 Compton St., Broomfield, CO 80020
 (303) 466-7333 FAX: (303) 469-8336
 Camden Marketing, Pierre Fonds, QU 514-683-3377

**ATLAS/SOUNDOLIER**

1859 Intertech Dr.
 Fenton, MO 63026
 (314) 349-3110 (800) 876-7337 FAX: (314) 349-1251
 VP/Marketing & Sales: Charles Gushwa;
 VP/Marketing Consultant: Herbert M. Jaffe;
 National Sales Manager: Bud Waters; Eastern
 Sales Manager: Tony Satariano; Western Sales
 Manager: Jeff Garstick; OEM Sales Manager:
 Larry Damato
 Precede, Morbio Inferiore, Switzerland, 914-
 31734
 PRODUCTS: audio, emergency intercom,
 handset, tone, visual

Dukane Corp.

2900 Dukane Drive
 St. Charles, IL 60174
 (708) 584-2300 FAX: (708) 584-2370
 President/C.E.O.: J. McWilliams Stone Jr.;
 Pres./Comm. Systems Division: Steven L. Deppe;
 National Sales Director: Warren T. Anderson;
 Service Manager: Cliff Carlson
 Wally Smutts, Toronto, ON 519-748-5352
 Doug Fellabaum, Sycamore, IL 815-895-7573
 Ken Lind, Boston, MA 617-235-6817
 Pete Kendall, Jacksonville, FL 904-262-6025
 Jim Lacey, Moreno Valley, CA 714-243-1160
 Jack Brown, Dallas, TX 214-943-7528
 Sanford Lange, Indianapolis, IN 317-251-3112
 PRODUCTS: audio, emergency intercom,
 handset, message announce, tone

ENCOM PRODUCTS CO., INC.

502 Lower Hopewell Road
 Oxford, PA 19363
 (215) 932-9600 (800) 424-9066 FAX: (215) 932-9999
 Greg DZubay & Assoc., Glendale, AZ 800-999-0006
 PRODUCTS: emergency intercom, handset

Eneractive Group Inc.

25416 C.R. #6, Suite 313
 Elkhart, IN 46514
 (219) 264-1393 FAX: (219) 262-9107
 John Anthony, Stamford, CT 203-322-9202
 PRODUCTS: DC battery supply, emergency
 intercom

Fire Control Instruments, Inc.

269 Grove Street
 Newton, MA 02166
 (617) 965-2010 FAX: (617) 965-0659
 President: Frank Carideo; Executive Vice
 President: Art Appel; Director, Sales &
 Marketing: Randy Edwards
 Doug Warren, Newport News, VA 804-930-3217
 PRODUCTS: audio, DC battery supply, emergency
 intercom, message announce, tone

**INNOVATIVE ELECTRONIC
DESIGNS, INC.**

9701 Taylorsville Rd.
 Louisville, KY 40299
 (502) 267-7436 FAX: (502) 267-9070
 President: Hardy Martin; Vice President, Mkt'g &
 Sales: Tom Roseberry; Sales Application
 Engineer: Mark Lewellyn; V.P. Research &
 Development: Bob Ponto; Vice President,
 Engineering: Ed Young; Vice President,
 Software: John Johnson
 Yore Company, White Bear Lake, MN 612-770-
 9760
 Steffey Marketing Assoc. Inc., Northbrook, IL 708-
 480-3575
 WesTech Marketing, Culver City, CA 213-870-9286
 Repworks, Chicopee, MA 413-533-0845
 Darmstedter Associates, Baldwinsville, NY 315-
 638-1261
 John Anthony, Stamford, CT 203-322-9202
 Bencsik Associates, Ocala, FL 904-732-9775
 C.L. Pugh, Cleveland, OH 216-238-1777
 Monford Electronics Marketing, Indianapolis, IN
 317-872-8877
 C.M. Sales, Farmington Hill, MI 313-553-8070
 B.C. Electronic Sales, Missoula, KS 913-262-1720
 Marketing Concepts, Irving, TX 214-869-0669
 Torbett/Kelser Group, Loveland, CO 303-669-1008
 Plus Four Marketing, Walnut Creek, CA 415-937-
 0650
 North Shore Marketing, Seattle, WA 206-284-9699
 Island Instruments, Kaneohe, HI 808-235-7544
 PRODUCTS: audio, handset, message announce,
 tone

MACKENZIE LABORATORIES, INC.

5507 Peck Road
 Arcadia, CA 91006
 (818) 579-0440 (800) 423-4147 FAX: (818) 448-7131
 President: Sam Khoury; Sr. Vice President: Nagy
 Khattar; Manager, Sales: Joe Vitale
 Audio Etc., St. Peters, MO 314-278-4130
 PRODUCTS: audio, message announce

Rauland-Borg Corp.

3450 W. Oakton St.
 Skokie, IL 60076
 (708) 679-0900 FAX: (708) 679-0625
 President: William Krucks; Executive Vice
 President: Kenneth James; National Sales
 Manager: Harry Hahn; Marketing Manager:
 Vince Novak
 Jack Hollis, Geneva, IL 708-208-1488
 Joe Clotti, Longwood, FL 407-767-2007
 Frank Riha, Austin, TX 512-926-3646
 Hank Plaisler, El Toro, CA 714-837-2626
 Vince Ward, Vashon Island, WA 206-463-5582
 Doug Warren, Newport News, VA 804-930-3217
 Suzanne Graham, Kent, OH 216-678-7307
 Mike Gulhan, E. Long Meadow, MA 413-525-6090

**STENTOFON
COMMUNICATIONS, INC.**

6119 Connecticut Avenue
 Kansas City, MO 64120
 (816) 231-7200 (800) 654-3140 FAX: (816) 231-7203
 President: Joe Green; Marketing Manager: David
 E. Gill; National Sales Manager: Frederick Hall
 Dan Rothrock, Kansas City, MO 816-231-7200
 Tomas J. Reilly, Elmsford, NY 914-592-1048
 Kerry L. Orr, Atlanta, GA 404-973-0736
 Michael A. Wilcock, Glendora, CA 818-335-0543
 Cartwright & Bean, Inc., Norcross, GA 404-368-
 0160
 Dimension/ Point IX, Lewisville, TX 214-436-3706
 Humble & Associates, Anaheim, CA 714-750-2248
 LCA Sales Company, Tuckahoe, NY 914-961-4700

Levy, Grams, & Lassers, North Brook, IL 708-272-8500
 Pearson & Pearson, Englewood, CO 303-770-0797
 Roger Ponto Assoc., Inc., Kirkland, WA 206-821-2996
 R.W. Kunz & Assoc., Inc., Prairie Village, KS 913-648-3535
 R.W. Sales, St. Paul, MN 612-646-2710
 Brian Frankle & Assoc., Belmont, CA 415-595-4004
 F.M. Valenti, Inc. & Assoc., Nahant, CA 617-592-5300

Yocum Marketing Co., Inc., Mesa, AZ 602-834-3334
 Weller Electronic Sales, Inc., Worthington, OH 614-885-7819
 PRODUCTS: audio, DC battery supply, emergency intercom, message announce, tone

T-S-K ELECTRONICS, INC.

564 Young St.
 Tonawanda, NY 14150
 (716) 693-3916 FAX: (716) 692-6433
 President: Kevin Kedzierski; Marketing Manager: Alan Gembola
 JMS Marketing, Austin, TX 512-266-1113
 PRODUCTS: emergency intercom

TALK-A-PHONE CO.

5013 N. Kedzie Ave.
 Chicago, IL 60625
 (312) 539-1100 FAX: (312) 539-1241
 Vice President: Samuel Shanes; Sales Manager: Dan F. Kagan; President: Z. Liberman
 JMS Marketing, Austin, TX 512-266-1113
 PRODUCTS: emergency intercom

Tel-Tron

220 Fentress Blvd.
 Daytona Beach, FL 32114
 (904) 255-1921 (800) 874-5622 FAX: (904) 258-3782
 President: Rick Dawson
 Camden Marketing, Pierre Fonds, QU 514-683-3377
 PRODUCTS: emergency intercom, message announce

WHELOCK, INC.

273 Branchport Avenue
 Long Branch, NJ 07740
 (908) 222-6880 (800) 631-2148 FAX: (908) 222-8707
 President: Peter W. Tariton; V.P. Finance and Admin.: Joseph P. Henry; Vice President Operations: Douglas E. Phillips; Vice President Sales/Mktg.: William L. Goldstein; Telephone/Paging Mktg. Mgr.: Arthur Arlow; Life Safety Mktg. Mgr.: Rein Haus
 Joseph P. McCaffrey, Glen Ellyn, IL 708-790-2898
 Edward P. Draney, Peachtree City, GA 404-631-3193
 Peter Koehler, Los Angeles, CA 213-572-1347
 Steve Goldberg, East Windsor, NJ 609-448-1457
 Dave Jackowiak, Burbank, IL 708-599-4099
 MJA Marketing, St. Charles, MO 314-447-7111
 PRODUCTS: message announce, tone, visual

LOUDSPEAKER ACCESSORIES

Alphone Corp.

1700 130th Ave. NE
 Bellevue, WA 98005
 (206) 455-0510 FAX: (206) 455-0071
 President: Jun Matsumoto; Vice President, Marketing: Harry Quanz; Vice President, Sales: Jim Morrison; Residential Sales Manager: Stephen Birgh; Commercial Sales Manager: John Mosebar
 Alphone East Coast Reg. Office, Rochelle Park, NJ 201-843-6115
 Precide, Morbio Inferiore, Switzerland, 914-31734

Find Your Suppliers in the
 Sound & Communications
 Blue Book

New from MacKenzie Laboratories, the leader in digital message repeaters

Random Access Digital Audio

MacKenzie's Random Access Digital Audio (RADA) is an audio message repeater system with multiple-message capability. It is designed to serve as the voice playback section of alarm systems in applications such as:

- Life-safety announcements
- Fire evacuation
- "Code Blue" messages
- Security warnings

Messages are digitized, stored in removable EPROM memory chips and controlled by the system's built-in microprocessors. The voice is entirely natural, just like a tape recording.

RADA provides the various levels of supervision required in life-safety systems, as well as continuous digital self-check and voice-check. Message prioritization and FIFO are standard features. Power interruptions won't affect the system's memory. The highly reliable, all-solid-state RADA system has *no moving parts*, so it requires *no maintenance*.

RADA is furnished in standard 19-inch equipment rack configuration. The basic unit provides up to 80 messages. Building-block expansion via sub-chassis



RADA unit shown with front cover removed.

provides capacities of more than 500 messages. Message lengths can be as short as 7.5 seconds or as long as 30 seconds. For more information about the versatile new RADA system, call MacKenzie Laboratories toll-free:

800-423-4147

MACKENZIE MacKenzie Laboratories, Inc.

5507 Peck Road □ Arcadia, California 91006 USA □ (818) 579-0440

ATLAS/SOUNDOLIER

1859 Intertech Dr., Fenton, MO 63026
 (314) 349-3110 (800) 876-7337 FAX: (314) 349-1251
 VP/Marketing & Sales: Charles Gushwa;
 VP/Marketing Consultant: Herbert M. Jaffe;
 National Sales Manager: Bud Waters; Eastern
 Sales Manager: Tony Satariano; Western Sales
 Manager: Jeff Garstick; OEM Sales Manager:
 Larry Damato
 Precide, Morbio Inferiore, Switzerland, 914-
 31734

PRODUCTS: attenuators, baffles, enclosure
 hardware, enclosure, grille cloth, grilles,
 mounting devices, mounting hardware,
 protection, stands, transformers

ATM Fly-Ware

20960 Brant Avenue, Carson, CA 90810
 (213) 639-8282 FAX: (213) 639-8284
 President: Andrew Martin; Project Mgr. - Fly-
 Ware: Kerry Bullis
 Doug Warren, Newport News, VA 804-930-3217
 PRODUCTS: mounting hardware

Bogen Communications, Inc.

50 Spring Street
 P.O. Box 575, Ramsey, NJ 07446
 (201) 934-8500 FAX: (201) 934-9832
 President: John H. Ochtera; Vice President, Sales
 & Mktg: David A. Chambers
 Scott Whipple, Columbus, OH 614-272-1689
 Sam Blasl, Ramsey, NJ 201-934-8500
 Walter Spencer, Ramsey, NJ 201-934-8500
 Fred Yosenick, Woodland, CA 916-668-6311
 Edwards Company, Inc., Livonia, MI 313-458-7777
 PRODUCTS: attenuators, baffles, grilles,
 transformers

Calrad Electronics

819 N. Highland Avenue, Los Angeles, CA 90038
 (213) 465-2131 FAX: (213) 465-3504
 President: Joseph Shupper; Vice President:
 Robert Shupper; Director of Sales & Mkt'g:
 Robert Feldman
 Shamrock Sales, Dayton, OH 513-258-1227
 RMP McBride, Wheaton, IL 708-462-2500
 Bidwell-Schwartz Assoc., Gardena, CA 213-770-
 0300
 B & R Electronic Sales, Plano, TX 214-985-0028
 Pancor Marketing, Lynwood, WA 206-771-5576
 Greg Dzubay & Assoc., Glendale, AZ 800-999-0006

CLARITY

1111 Industry Avenue, S.E.
 Roanoke, VA 24013
 (703) 982-7003 (800) 962-6009 FAX: (703) 982-7032
 President: John W. Mason; Sales Coordinator:
 Linda T. Bishop; Product Manager: John D.
 Spencer
 Featherstone Sales, Los Gatos, CA 408-356-3243
 Unirep Inc., Valrico, FL 813-681-3477
 M.I.N.K. Associates, Overland Park, KS 913-341-
 2112
 Gerald Horne Associates, Stow, MA 508-897-1741
 Forti Associates, Kensington, MD 301-949-1706
 Holland Marketing, Bloomington, MN 612-881-
 8425
 Adams & Associates, Greensboro, NC 919-272-
 6838
 Reptronics Inc., New Madison, OH 800-888-0530
 Dick Belew Sales, Dallas, TX 214-644-7881
 PRODUCTS: attenuators, baffles, enclosure,
 mounting devices, transformers

Dukane Corp.

2900 Dukane Drive
 St. Charles, IL 60174
 (708) 584-2300 FAX: (708) 584-2370
 President/C.E.O.: J. McWilliams Stone Jr.;
 Pres./Comm. Systems Division: Steven L. Deppe;
 National Sales Director: Warren T. Anderson;
 Service Manager: Cliff Carlson
 Wally Smutts, Toronto, ON 519-748-5352
 Doug Fellabaum, Sycamore, IL 815-895-7573
 Ken Lind, Boston, MA 617-235-6817
 Pete Kendall, Jacksonville, FL 904-262-6025
 Jim Lacey, Moreno Valley, CA 714-243-1160
 Jack Brown, Dallas, TX 214-943-7528
 Sanford Lange, Indianapolis, IN 317-251-3112
 PRODUCTS: attenuators, baffles, grilles,
 mounting devices, mounting hardware, stands,
 transformers

Eikay Industries

2925 North Market St.
 St. Louis, MO 63106
 (314) 535-1333 FAX: (314) 535-4118
 CEO/ENG: Richard Hahn; President: Paul Grote;
 Vice President, Sales: Martin Hahn; Engineering:
 Jack Schilligo
 Edwards Company, Inc., Livonia, MI 313-458-7777

ENVIRONMENTAL SOUND

31220 La Baya Dr., Bld. #110
 Westlake Vlg., CA 91362
 (818) 706-0228 FAX: (818) 889-5605
 President: Pascal Delbuck; Marketing: Ron
 Glatzhoffer; Plant Manager: Bill Ward

else
**LOOK WHAT QUAM
 HAS FOR YOU!**

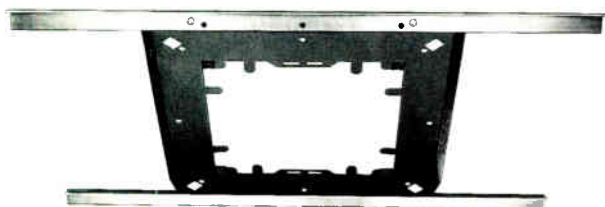
**UNIVERSAL SPEAKER MOUNTING
 SUPPORT BRIDGES**

Part No. SSB-2

- For mounting 4" and 8" loudspeakers and baffles
- Eliminate tile sag
- Reduce required installation time
- Mount square or round baffles: eliminate need for stocking
 different mounting devices
- Speaker Support Channel permits installations in
 spaces too small to accommodate bridges

Ask for FREE Tech Spec TS-25

Quam-Nichols Company

234 East Marquette Road, Chicago, Illinois 60637
 Phone: 1 312 488-5800 • FAX: 312 488-6944

Circle 283 on Reader Response Card

*Faster than the speed of sound.
 More powerful than a computer-controlled amplifier.
 Able to leap 120 db spl in a single bound (without clipping!)
 Is it an amp? Is it a speaker?*

No! It's

ANSWERMEN

Our fearless ANSWERMAN
 will tackle everything from the most basic to the
 most difficult of questions relating to the
 Sound & Communications, industry. The all-
 knowing all-seeing audio guru is more than
 capable of answering ANY question that could
 possibly be on your minds.

Send your Questions to: The Answerman

c/o **SOUND
 COMMUNICATIONS**

25 Willowdale Ave.

Port Washington, NY 11050

Call: (516) 767-2500 Fax: (516) 767-9335

Cambridge Marketing, Westerville, OH 614-363-9191
 PRODUCTS: baffles, enclosure hardware, enclosure, grille cloth, grilles, mounting devices, mounting hardware

FOSTEX CORPORATION OF AMERICA

15431 Blackburn Ave.
 Norwalk, CA 90650
 (213) 921-1112 (800) 7-FOSTEX FAX: (213) 802-1964
 V.P. Marketing/ General Mgr.: Robert Veri; V.P. Sales: Mark Cohen
 J.B. Parent, Dublin, OH 614-764-0064
 PRODUCTS: stands

Fourjay Industries Inc.

3400 Stop Eight Road
 P.O. Box 14617
 Dayton, OH 45413
 (513) 890-6444 FAX: (513) 890-1692
 President: J.M. (Jay) Fulkerson; Director/Sales: M.W. (Bud) Frawley; Chief Engineer: John Henry Greg Dzubay & Assoc., Glendale, AZ 800-999-0006

FSR Inc.

244 Bergen Boulevard
 West Paterson, NJ 07424
 (201) 785-4347 (800) 332-3771 FAX: (201) 785-3318
 President: William G. Fitzsimmons; Vice President: Janice Sandri; Engineering Manager: Joseph Fischer; Special Projects Manager: John Macaluso; Manager,

Metal Products: Joseph Amico
 Sigmat Corporation, Valley Forge, PA 215-783-6666
 Peregrine Southwest, Houston, TX 713-589-8481
 Henry W. Phillips Inc., Roswell, GA 404-992-3070
 Piper and Givan Associates, Needham, MA 617-449-1144
 Design Factors, Hacienda Hts., CA 213-697-7576
 Cambridge Marketing, Westerville, OH 614-363-9191
 PRODUCTS: enclosure, grilles, mounting devices, mounting hardware

Gemco Electronics, Inc.

550 Airport Rd.
 P.O. Box 993
 Gallatin, TN 37066
 (615) 452-5960 (800) 624-3626 FAX: (615) 451-0026
 General Manager: Jerry A. Graves; Order Entry: Linda McCullough; National Sales Manager: James F. Woodard
 Gemco Electronics Jim Woodward, Gilmer, TX 903-762-2367
 Audio Etc., St. Peters, MO 314-278-4130
 PRODUCTS: attenuators, baffles, enclosure, grilles, transformers

Hi Lo Fabrication & Manufacturing

P.O. Box 509 / CR 1105
 Rio Vista, TX 76093
 (817) 373-2247
 President: Cecil Caro; Production Engineer: Cecil Caro; Vice President, Sales: Bridget Caro
 ADCOM, Toronto, ON 416-251-3355
 PRODUCTS: baffles, crossovers, enclosure, stands

International Components Corp.

105 Maxess Road, Melville, NY 11747
 (516) 293-1500 (800) 645-9154 FAX: (516) 293-4983
 President: Mort Crossman; Executive Vice President: Irwin Friedman; Vice President: Fred Crossman; Eastern Regional Sales Mgr.: Ken Reed; Vice President: Harvey Crossman
 C.B. Electronic Marketing, Arvada, CO 303-422-0561
 PRODUCTS: attenuators, baffles, connectors, crossovers, enclosure, grille cloth, grille cloth, fire resistant, grilles, mounting devices, mounting hardware

J.W. DAVIS AND CO.

3030 Canton Street, Dallas, TX 75226
 (214) 651-7341 (800) 527-5705 FAX: (214) 939-0328
 President: Harvey Earp; Vice President, Sales: Jack W. Tucker; Chief Engineer: Eric Simonson
 Multi-Technical Reps., Brainerd, MN 218-828-9483
 PRODUCTS: attenuators, baffles, connectors, enclosure hardware, enclosure, grille cloth, grilles, mounting devices, mounting hardware, protection, stands, transformers

KARIBU SOUND INDUSTRIES INC.

3500 Parkdale Avenue, Baltimore, MD 21211
 (301) 383-2167 FAX: (301) 383-7573
 President: Larry Kirchner
 Taub Sales Inc., Silver Spring, MD 301-622-9100
 Leslie's, Chicago, IL 708-697-6677
 Kodo Associates Inc., Minneapolis, MN 612-881-1255
 Vector Corp., Seattle, WA 206-368-1255
 Multi-Technical Reps., Brainerd, MN 218-828-9483
 PRODUCTS: baffles, connectors, crossovers, enclosure hardware, enclosure, grille cloth, grille cloth, fire resistant, grilles, transformers

One System Fits All Suspended Acoustical Ceilings... "Plenum Connection"

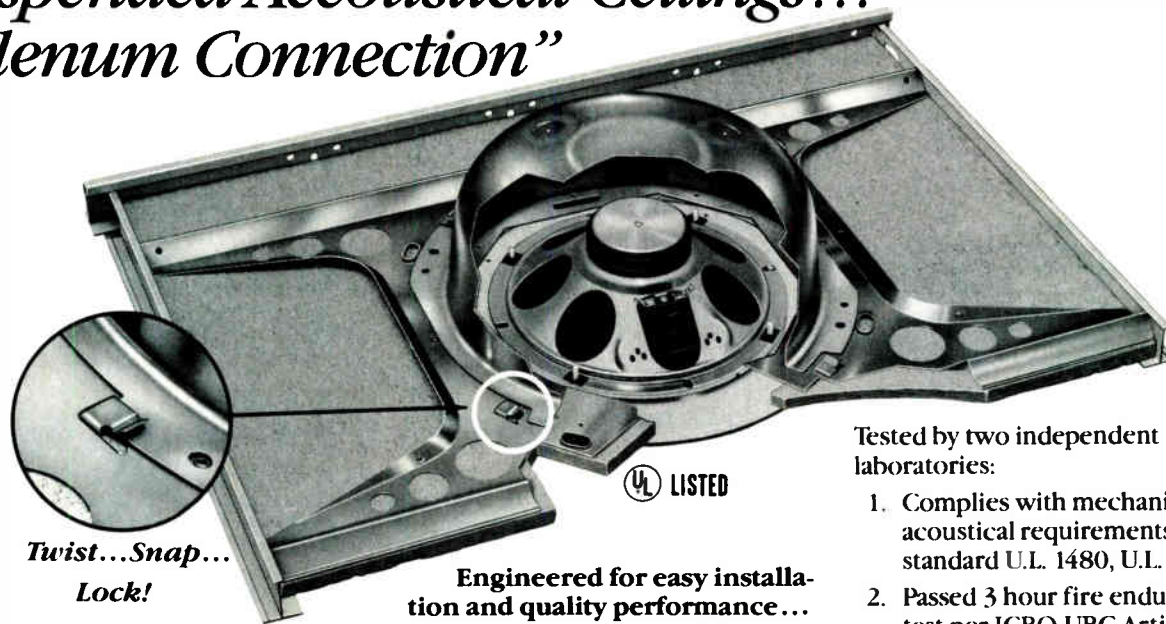

Twist...Snap...
 Lock!

UL LISTED

Engineered for easy installation and quality performance...
 Designed to get building inspector approval and maintain the integrity of air-return acoustical ceilings...

Tested by two independent laboratories:

1. Complies with mechanical and acoustical requirements of safety standard U.L. 1480, U.L. listed.
2. Passed 3 hour fire endurance test per ICBO-UBC Article 43-7.

The "plenum connection" enclosure/bridge system is in stock and ready for immediate shipment.

For Details Call or write.



FOURJAY
 INDUSTRIES, INC.

3400 STOP EIGHT ROAD • P.O. BOX 14617 • DAYTON, OH 45413-0617
 TELEPHONE (513) 890-6444 • FAX (513) 890-1692

Fourjay Quality—American Made

Circle 36 on Reader Response Card

LEE DAN COMMUNICATIONS, INC.

155 Adams Avenue, Hauppauge, NY 11788-3699
(516) 231-1414 (800) 533-3261 FAX: (516) 231-1498
President: Leon Goldberg; Vice President
Operations: Lawrence J. Goldberg; V.P. Finance &
Administration: David H. Goldberg; Senior
Technician: Sanford Hoffman; Office Manager:
Rita Kaplan; Sr. Sales/Service Associate: Susan Leon
C.L. Pugh & Associates, Cleveland, OH 216-238-1777
PRODUCTS: attenuators, baffles, enclosure,
grilles, protection, transformers

Lowell Manufacturing Company

3030 Laclede Station Road, St. Louis, MO 63143
(314) 781-9058 (800) 325-9660 FAX: (314) 645-4852
Sales Manager: John J. Lowell; Operations
Manager: Wilhelm R. Lowell;
Engineering: Karl F. Schneider
Radon, Sacramento, CA 916-923-2524
Leslie's, Elgin, IL 708-697-6677
Meyer Marketing, Deersfield Bch., FL 305-481-9250
H.W. Phillips Co., Roswell, GA 404-992-3070
Pusecker Sales, Lincoln Park, NJ 201-305-8331
Audio Etc., St. Peters, MO 314-278-4130

LynTec

7030 Grandview, Merriam, KS 66204
(913) 722-4047 FAX: (913) 432-4157
Owner: Lynn Potter
Audio Etc., St. Peters, MO 314-278-4130
PRODUCTS: protection

McCauley Sound, Inc.

13608 94th Avenue East
Puyallup, WA 98373
(206) 848-0363 FAX: (206) 841-3050
President/Design Engineer: Tom McCauley; Vice
President/Production: Pete McCauley; Sales (In-
House): Bruce Anderson; Marketing: Susahn
London
Taub Sales, Silver Springs, MD 301-622-9100
Line Level Marketing, Minneapolis, MN 612-522-2234
Innovative Sales & Marketing, Irvine, CA 714-975-
1130
Pro Musica Sales, Keene, NH 603-352-4831
Audio Etc., St. Peters, MO 314-278-4130
PRODUCTS: crossovers, grilles, mounting
devices, mounting hardware

MG Electronics

32 Ranick Road
Hauppauge, NY 11788
(516) 582-3400 FAX: (516) 582-3229
President: Elliott Maltz; National Sales Manager:
Stan Grey; Asst. Sis. Mgr., Comm. Sound: Herb
Woll; CEM Sales Manager: John Kibbitt; Credit
Manager: Rita McIberger; Customer Service:
Sue Novak
Loomis and Associates, Fremont, CA
415-683-0883
PRODUCTS: attenuators, baffles, crossovers,
grilles, transformers

Middle Atlantic Products

8 North Corporate Dr.
P.O. Box 29
Riverdale, NJ 07457
(201) 839-1011 FAX: (201) 839-1976
President: Bob Schluter; National Sales Mgr.:
Eric Demarest; National Director Operations:
Scott Mathews; Office Manager: Rosemarie
Curti; West Coast Operations Mgr.: Sean Freida
Middle Atlantic Rack Distr., Haskell, NJ
201-839-2714
Middle Atlantic Western Distr., Moorepark, CA
805-529-6104
Audio Etc., St. Peters, MO 314-278-4130
PRODUCTS: grilles

Mortronics

520 27th Street
Oakland, CA 94612 (800) 962-1962
Owner: Kenneth A. Floyd
Cambridge Marketing, Westerville, OH 614-363-
9191
PRODUCTS: attenuators

Music Supply Company, Inc.

809 N. Madison
Dallas, TX 75208
(214) 946-8450 (800) 527-1522 FAX: (214) 946-9155
President: W.E. Brown; Sales: Betty Brown
Audio Etc., St. Peters, MO 314-278-4130
PRODUCTS: mounting devices, mounting
hardware

Neutrik USA, Inc.

195-s3 Lehigh Ave.
Lakewood, NJ 08701
(908) 901-9488 FAX: (908) 901-9608
General Manager: James E. Cowan; Product
Manager: Kenneth W. Smalley; Product
Manager: William J. Dorman
Dimension/ Point IX, Lewisville, TX 214-436-3706
PRODUCTS: connectors

Omnimount Systems

10840 Vanowen Street
North Hollywood, CA 91605
(818) 766-9000 FAX: (818) 766-9437
President: Alex Cyrell; CEO: Garret E. Weyand;
Sales Coordinator: Stacy L. Ward
Sigmat Corporation, Freehold, NJ 201-462-1221
New Age Marketing, Dallas, TX 713-561-9870
Secom Systems, Atlanta, GA 404-455-0672
Brian Trinkle & Assoc., Belmont, CA 415-595-4004
Green Wissler Sales, Carmel, IN 317-843-5785
Loomis and Associates, Fremont, CA 415-683-
0883
PRODUCTS: mounting devices

OWI INC.

1160 Mahalo Place
Compton, CA 90220
(213) 638-4732 (800) 638-1694 FAX: (213) 638-8347
President: Ned Morioka; Vice President: Hiro
Okayama; Director of Sales: Kristin Jo Morioka;
Credit Manager: June Morioka
Loomis and Associates, Fremont, CA 415-683-
0883
PRODUCTS: attenuators, connectors,
transformers

Pacific Transformer Corp.

4750 E. Wesley Dr.
Anaheim, CA 92807 (800) 325-0501 FAX: (714)
779-0718
Dimension/ Point IX, Lewisville, TX 214-436-3706

PARTS EXPRESS INT'L INC.

340 E. First St.
Dayton, OH 45402
(513) 222-0173 (800) 338-0531 FAX: (513) 222-4644
President: Jeffrey Stahl; Sales Manager: Linda
O'Brien; Purchasing Manager: Greg Herting;
Advertising Manager: Larry Potter
Chuck Olson Assoc., Renton, WA 206-271-5416
PRODUCTS: attenuators, baffles, connectors,
crossovers, enclosure hardware, enclosure, grille
cloth, grille cloth, fire resistant, grilles, mounting
devices, mounting hardware, protection, stands,
transformers

Paso Sound Products, Inc.

14 First Street, Pelham, NY 10803
(914) 738-4800 (800) 231-3034 FAX: (914) 738-3954
Executive Vice President: Paul Mastrangelo;
Product Manager: Ken O'Brien; Credit Manager:
Marilyn Beckerson; Operations Manager:
Anthony Squegilla
Anderson Sales, Braintree, MA 617-848-9194
Jack Mesnick Sales, Liverpool, NY 315-622-3211
Paimler Associates, Fairfield, NJ 201-882-1266
Weller Electronic Sales, Inc., Worthington, OH
614-885-7819
Lienau Associates, Columbia, MD 301-621-4113
MJA Marketing, St. Charles, MO 314-447-7111
Northland Assoc., Moorehead, MN 218-233-4616
Allwest Sound & Communication, Camarillo, CA
805-388-7745
Dimension Pt. IX Marketing, Katy, TX 713-578-9277
Mountain Representatives, Denver, CO
303-333-7745
Miguel Lopez, Hialeah, FL 305-822-6853
Paco Electronics, Ltd., Markham, ON 416-475-0740
Robert Milsk Co., Southfield, MI 313-354-3310
Marketline Inc., Snellville, GA 404-972-9048
Hawkins-Frederickson Assoc., Maitland, FL
407-831-2474
Lintern Associates, Naperville, IL 708-904-1225
Robert Milsk Co., Indianapolis, IN 317-842-3400
PRODUCTS: baffles, grilles, mounting devices,
mounting hardware, stands, transformers

PEAVEY ELECTRONICS CORP.

711 A Street
P.O. Box 2898, Meridian, MS 39301
(601) 483-5365 FAX: (601) 484-4278
CEO: Hartley Peavey; President: Mella Peavey
Dimension/ Point IX, Lewisville, TX 214-436-3706
PRODUCTS: attenuators, baffles, connectors,
crossovers, enclosure hardware, enclosure, grille
cloth, grille cloth, fire resistant, grilles, mounting
devices, mounting hardware, stands,
transformers

Peerless Sales Company

1980 Hawthorne, Melrose Park, IL 60160
(708) 865-8870 (800) 729-0307 FAX: (708) 865-2941
President: Walt Snodell; Director of Marketing:
Frank Briggs; Director of Sales: Bill Brock
Crescendo Associates, Hollywood, FL 305-922-9553
PRODUCTS: mounting devices

REVERE INDUSTRIES

1101 Bienville St., New Orleans, LA 70112
(504) 523-3503 (800) 843-8321 FAX: (504) 525-6361
Vice President Mktg./Sales: Richard Harris
Camden Marketing, Pierre Fonds, QU 514-683-
3377
PRODUCTS: attenuators, baffles, connectors,
crossovers, enclosure hardware, enclosure, grille
cloth, grille cloth, fire resistant, grilles, mounting
devices, mounting hardware, protection, stands,
transformers

SONANCE

961 Calle Negocio, San Clemente, CA 92672
(714) 492-7777 (800) 582-7777 FAX: (714) 361-2705
President: Scott Struthers; Vice President:
Geoff Spencer; Sales Manager: Dave Donald;
International Sales Manager: Mark Cichowski;
Public Relations Director: Mitch Simon; Dir. Sis
Trn. & Mkt. Research: Kevin Leja
Morris Tait and Assoc., Los Angeles, CA 213-877-
4424
Bach Sales, New York, NY 212-727-0404
Tandem Marketing, Chicago, IL 708-605-1960
Dobbs Stanford, Dallas, TX 214-358-0800
Balaton Marketing, Washington DC, 202-471-
1764
MJA Marketing, St. Charles, MO 314-447-7111
PRODUCTS: attenuators, connectors, grille cloth,
grilles, mounting devices, mounting hardware

TEI Electronics Inc.

570 W. 18 St.
P.O. Box 246, Hialeah, FL 33011
(305) 888-3980 (800) 327-8811 FAX: (305) 885-4950
President: Danny Alonso; Vice President: Mireya A. Muniz; National Sales Manager: Walter McNulty; Customer Service: John Tembras; Sales: Orlando Pineda; Sales: Jose Hurcades
Audio Biz, Mundellen, IL 708-949-0280
PRODUCTS: attenuators, connectors, crossovers, grille cloth, fire resistant, grilles, mounting hardware, stands

The Q Line Corporation

2808 Lakeside Drive
P.O. Box 20037, Oklahoma City, OK 73156
(405) 751-3294 (800) 359-4604
President/Owner: John W. Quade
Dimension/ Point IX, Lewisville, TX 214-436-3706
PRODUCTS: enclosure

TOA ELECTRONICS, INC.

601 Gateway Blvd. Suite 300
P.O. Box 2047, S San Francisco, CA 94080
(415) 588-2538 (800) 733-4750 FAX: (415) 588-3349
President: Yoshiro Ishida; Director, Audio Products Div: Richard Krochmal; Director, Comm. Systems Div.: Al Burns; Mgr., Marketing Development: Jeff Pailin; Manager, Western Division: Bill Ford; Manager Engineering Services: Bob Sweet
Chuck McGregor- Product Consit, Morris Plains, NJ 201-829-7047
John Murray-Eng.Snd. Mktg. Dev, Springfield, OH 513-324-1993
Bob Hager-Eastern Regional Mgr, Rosewell, GA 404-552-7624
Linda Wick-Central Reg. Mgr., Kansas City, MO 816-453-5775
Robert Slaughter-Cntrl Div Mgr, Houston, TX 713-460-3678
Pete Newmark-West Regional Mgr., Mesa, AZ 602-981-0050
Walter Best, Eastern Reg. Mgr., Sussex, NJ 201-702-0068
PRODUCTS: crossovers, stands, transformers

UNIVERSITY SOUND INC.

13278 Rolston Avenue, Sylmar, CA 91342
(818) 362-9516 FAX: (818) 367-5292
President: Robert Sandell; Controller: Mary Coco; National Sales Manager: Greg McLagan; Design Engineer: Ken Kocesk
Jim Burger, Philadelphia, PA 203-297-7160
PRODUCTS: crossovers, transformers

Waldom Electronics

4301 West 69th Street, Chicago, IL 60629
(312) 585-1212 (800) 552-1639 FAX: (312) 585-7847
President: Roger G. Engle; Sound Products Manager: Mark A. Baumann
Cambridge Marketing, Westerville, OH 614-363-9191
PRODUCTS: connectors, crossovers, enclosure hardware, grille cloth, mounting hardware, stands

WHEELOCK, INC.

273 Branchport Avenue
Long Branch, NJ 07740
(908) 222-6880 (800) 631-2148 FAX: (908) 222-8707
President: Peter W. Tarlton; V.P. Finance and Admin.: Joseph P. Henry; Vice President Operations: Douglas E. Phillips; Vice President Sales/Mktg.: William L. Goldstein; Telephone/Paging Mktg. Mgr.: Arthur Arlow; Life Safety Mktg. Mgr.: Rein Haus
Joseph P. McCaffrey, Glen Ellyn, IL 708-790-2898
Edward P. Draney, Peachtree City, GA 404-631-3193
Peter Koehler, Los Angeles, CA 213-572-1347
Steve Goldberg, East Windsor, NJ 609-448-1457
Dave Jackowlak, Burbank, IL 708-599-4099
MJA Marketing, St. Charles, MO 314-447-7111
PRODUCTS: enclosure, mounting devices

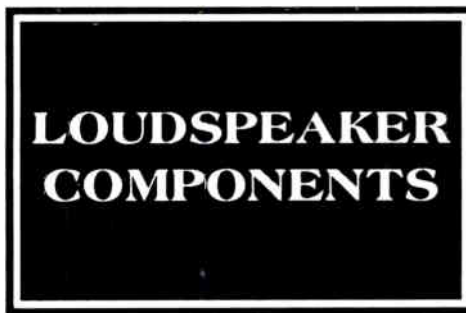
**Accusonics Systems**

2101 Jericho Turnpike
P.O. Box 5416
New Hyde Park, NY 11040
(516) 328-3300 FAX: (516) 326-8827
General Manager: Michael D'Agostino
J.B. Parent, Dublin, OH 614-764-0064
PRODUCTS: custom, environment protected, outdoor

Acoustical Supply International

100 Cherokee Blvd., Suite 211
Chattanooga, TN 37405
(615) 752-1720 (800) 879-1992 FAX: (615) 752-1725
President-Owner: Terry Taylor; VP-Sales: Montez Hardegen
Cambridge Marketing, Westerville, OH 614-363-9191

ADAMSON ACOUSTIC DESIGN CORP.

850 Brock Road, Suite One
Pickering, ON L1W 1Z8
(416) 420-6279 FAX: (416) 420-0813
President: Brock Adamson; Marketing/Sales Manager: Jerry Placken; Office Manager: Lorraine Zerafa
Innovative Sales & Marketing, Irvine, CA 714-528-2005
Martin Wick, Minneapolis, MN 612-522-2234
Audio Biz, Mundelein, IL 708-949-0280
W3 Marketing, Stone Mountain, GA 404-981-7021
Tenickl & Associates, Houston, TX 713-528-2005
PRODUCTS: drivers

Alphone Corp.

1700 130th Ave. NE
Bellevue, WA 98005
(206) 455-0510 FAX: (206) 455-0071
President: Jun Matsumoto; Vice President, Marketing: Harry Quanz; Vice President, Sales: Jim Morrison; Residential Sales Manager: Stephen Birgh; Commercial Sales Manager: John Mosebar
Alphone East Coast Reg. Office, Rochelle Park, NJ 201-843-6115
Precide, Morbio Inferiore, Switzerland, 914-31734
PRODUCTS: full range, horns

Altec Lansing Corp.

10500 W. Reno
Oklahoma City, OK 73128
(405) 324-5311 FAX: (405) 324-8981
President: Dave Merrey; Vice President, Sis. & Mktg: Chuck Lange; National Sales Manager: Jerry Spriggs; Manager Export Marketing: John Sexton; Technical Services Manager: Gary Jones; Customer Services Manager: Jim Brown
Dave Read, McKinney, TX 214-542-6328
Jim Faber, Shreveport, LA 318-631-1766
Paul Froula, Lombard, IL 708-268-1831
Alan Feckanin, Port St. Lucie, FL 407-879-1078

George Solti, Philadelphia, PA 215-637-3429
Larry Schirmer, Pontiac, MI 313-340-9588
Stu Moffitt, Renton, WA 206-277-8851
PRODUCTS: coax, drivers, full range, high-frequency drivers, high power, horns, low-frequency drivers, mid-bass, tweeters, woofers

ATLAS/SOUNDOLIER

1859 Intertech Dr.
Fenton, MO 63026
(314) 349-3110 (800) 876-7337 FAX: (314) 349-1251
VP/Marketing & Sales: Charles Gushwa; VP/Marketing Consultant: Herbert M. Jaffe; National Sales Manager: Bud Waters; Eastern Sales Manager: Tony Satariano; Western Sales Manager: Jeff Garstick; OEM Sales Manager: Larry Damato
Precide, Morbio Inferiore, Switzerland, 914-31734
PRODUCTS: coax, custom, drivers, environment protected, full range, high-frequency drivers, high power, horns, low-frequency drivers, mid-bass, omnidirectional, outdoor, tweeters, woofers

Audlotech

410 S. Cedar
Lansing, MI 48912
(517) 371-4148
J.B. Parent, Dublin, OH 614-764-0064

Audra Int'l

P.O. Box 38
Silverado, CA 92676
(714) 649-2207 FAX: (714) 649-3064
Director: Aigis Renkus
J.B. Parent, Dublin, OH 614-764-0064
PRODUCTS: drivers, high-frequency drivers

Bogen Communications, Inc.

50 Spring Street
P.O. Box 575
Ramsey, NJ 07446
(201) 934-8500 FAX: (201) 934-9832
President: John H. Ochtera; Vice President, Sales & Mktg: David A. Chambers
Scott Whipple, Columbus, OH 614-272-1689
Sam Blasl, Ramsey, NJ 201-934-8500
Walter Spencer, Ramsey, NJ 201-934-8500
Fred Yosenick, Woodland, CA 916-668-6311
Edwards Company, Inc., Livonia, MI 313-458-7777
PRODUCTS: drivers, environment protected, full range, horns, omnidirectional, outdoor

CELESTION INDUSTRIES, INC.

89 Doug Brown Way, Holliston, MA 01746
(508) 429-6706 FAX: (508) 429-2426
President: Peter Weillkoff; Controller: Meredith Nunes; Sales Manager -Pro Products: Brian Covello; Sales Manager-Consumer Prods: Jim Price; Operations Manager: Steve King; Credit Manager: Marty Michaelson
Reflex Marketing, Hempstead, NY 516-565-2323
Pacific Audio Group, Gardena, CA 213-719-1383
New Horizon Marketing, Bannockburn, IL 708-234-6500
R.W. Fuday Associates, Sebastopol, CA 707-874-3101
Marketing Concepts, Irving, TX 214-869-9870
Taub Sales, Silver Springs, MD 301-662-9100
William Ray Associates, Smyrna, GA 404-436-7233
Future Sales, Redmond, WA 206-861-9100
On Line Marketing, Wadsworth, OH 216-336-7504
KM Ltd., Cambridge, MA 617-876-9870
GMS Marketing, Burnsville, MN 612-895-8088
Dzubay & Associates, Glendale, AZ 602-934-6614
PRODUCTS: custom, drivers, full range, high-frequency drivers, high power, horns, low-frequency drivers, mid-bass, tweeters, woofers

Cerwin-Vega

555 E. Easy St.
 Simi Valley, CA 93065
 (805) 584-9332 FAX: (805) 583-0865
 V.P. Pro Sales and Marketing: Rich Mandella;
 Tech/ Sales & Marketing: John Davies; Inside
 Sales: Gayle De Matoff
 Southwest Marketing, TX, AZ, NM, OK, CO 818-
 848-7512
 MJA Sales, NY, NJ 201-467-9898
 Image Marketing, CA, NV 714-957-0630
 Crescendo, FL 305-922-9553
 Audio Biz, IL 708-949-0280

Cliff Electronics Inc.

9821 Whithorn
 Houston, TX 77095
 (713) 855-6685 FAX: (713) 855-6684
 General Manager: Robert Tupper
 Sunrise Sales Company, LaMolle, IL 815-638-2660
 PRODUCTS: drivers, high-frequency drivers, high
 power, horns, low-frequency drivers, mid-bass,
 tweeters, woofers

CSI-Components Specialties, Inc.

1172 Route 109
 P.O. Box 624
 Lindenhurst, NY 11757
 (516) 957-8700 (800) 645-5516 FAX: (516) 957-9142
 President: Louis W. Keller; Vice President:
 James J. Ganci; Vice President of Sales: Mel
 Hulkower; Sales Manager: Eric Forman; Sales
 Associate: Angela Carolan; Sales/Expediting:
 Bernice Zachman
 L.W. Keller and Associates, Lindenhurst, NY 516-
 226-7733
 Crown Associates, Charlottesville, VA 804-293-
 6373
 Jonel Sales Associates, Milford, MA 508-478-4650
 Reptronics, New Madison, OH 513-996-0530
 Hawkins-Frederickson Assoc., Ft. Lauderdale, FL
 305-321-6702
 Doug Warren, Newport News, VA 804-930-3217

D.A.S. Audio, S.A.

C/Isias Baleares 24
 P.I. Fuente del Jarro
 PaternaValencia, SP 46988
 (346) 138-7843 FAX: (346) 138-7806
 President: Juan Alberola; Sales Director: Jack
 Palacio
 TEI Electronics, Hialeah, FL 305-888-3980
 Doug Warren, Newport News, VA 804-930-3217

Design Direct Sound Inc.

9320 15th Avenue South
 Seattle, WA 98108
 (206) 527-4371 FAX: (206) 762-8682
 President: Bob Rice; Vice President: Marc Hall
 Cambridge Marketing, Westerville, OH 614-363-
 9191
 PRODUCTS: full range, horns

Dukane Corp.

2900 Dukane Drive, St. Charles, IL 60174
 (708) 584-2300 FAX: (708) 584-2370
 President/C.E.O.: J. McWilliams Stone Jr.;
 Pres./Comm. Systems Division: Steven L. Deppe;
 National Sales Director: Warren T. Anderson;
 Service Manager: Cliff Carlson
 Wally Smutts, Toronto, ON 519-748-5352
 Doug Fellabaum, Sycamore, IL 815-895-7573
 Ken Lind, Boston, MA 617-235-6817
 Pete Kendall, Jacksonville, FL 904-262-6025
 Jim Lacey, Moreno Valley, CA 714-243-1160
 Jack Brown, Dallas, TX 214-943-7528
 Sanford Lange, Indianapolis, IN 317-251-3112
 PRODUCTS: coax, full range, outdoor

E3MC

1620 N. Missile Way
 Anaheim, CA 92801
 (714) 449-7779 (800) 421-7071 FAX: (714) 449-0507
 President: Norman Collins; Vice President,
 Sales/Mkt'g: Marcla Cardenas; Vice President,
 Operations: Michael Goddard; Sales: Tiffany
 Adams
 John Anthony, Stamford, CT 203-322-9202
 PRODUCTS: coax, drivers, high-frequency drivers,
 high power, horns, low-frequency drivers, mid-
 bass, woofers

Eden Electronics, Inc.

310 1st St.
 P.O. Box 338
 Montrose, MN 55363
 (612) 675-3650 FAX: (612) 675-3651
 President: David Nordschow
 Jim Burger, Philadelphia, PA 203-297-7160
 PRODUCTS: coax, custom, drivers, full range,
 high-frequency drivers, high power, horns, low-
 frequency drivers, mid-bass, tweeters, woofers

ENVIRONMENTAL SOUND

31220 La Baya Dr., Bld. #110
 Westlake Vlg., CA 91362
 (818) 706-0228 FAX: (818) 889-5605
 President: Pascal Delbuck; Marketing: Ron
 Glatzhoffer; Plant Manager: Bill Ward
 Cambridge Marketing, Westerville, OH 614-363-
 9191
 PRODUCTS: custom, drivers, environment
 protected, full range, high-frequency drivers,
 high power, low-frequency drivers, mid-bass,
 tweeters, woofers

Gauss

9130 Glenoaks Boulevard
 Sun Valley, CA 91352
 (213) 875-1900 FAX: (818) 767-4479
 Customer Service: Bonnie Armstrong; Director
 of Sales & Mkt'g: Paul V. Hugo; President: Jim
 Williams
 Bob White Assoc., Solon, OH 216-248-1317
 World Wide Electronics, Davie, FL 305-584-7024
 Taub Sales, Silver Spring, MD 301-622-9100
 Dimension IX Corp., Lewisville, TX 214-436-3706
 Elrep Sales Co., Tucker, GA 404-938-7108
 Greg Dzubay & Assoc., Glendale, AZ 800-999-0006
 PRODUCTS: coax, drivers, high-frequency drivers,
 high power, horns, low-frequency drivers, mid-
 bass

International Components Corp.

105 Maxess Road
 Melville, NY 11747
 (516) 293-1500 (800) 645-9154 FAX: (516) 293-4983
 President: Mort Grossman; Executive Vice
 President: Irwin Friedman; Vice President: Fred
 Grossman; Eastern Regional Sales Mgr.: Ken
 Reed; Vice President: Harvey Grossman
 C.B. Electronic Marketing, Arvada, CO 303-422-
 0561
 PRODUCTS: coax, horns

J.W. DAVIS AND CO.

3030 Canton Street
 Dallas, TX 75226
 (214) 651-7341 (800) 527-5705 FAX: (214) 939-0328
 President: Harvey Earp; Vice President, Sales:
 Jack W. Tucker; Chief Engineer: Eric Simonson
 Multi-Technical Reps., Brainerd, MN 218-828-9483
 PRODUCTS: coax, drivers, environment
 protected, horns, outdoor

JBL Professional

8500 Balboa Boulevard
 P.O. Box 2200
 Northridge, CA 91329
 (818) 893-8411 FAX: (818) 893-3639
 President: Ronald Means; Vice President, Sales:
 Ken Lopez; Vice President, Marketing: Mark
 Gander; Market Manager: Hector Martinez;
 National Sales Manager: Neil Conley
 Jim Chase, San Clemente, CA 714-492-6290
 Bill Hamilton, Folsom, PA 215-543-4677
 Bill Schuermann, Houston, TX 713-370-5553
 Tom Walter, No. Barrington, IL 312-382-4925
 ADCOM, Toronto, ON 416-251-3355
 PRODUCTS: coax, drivers, environment
 protected, full range, high-frequency drivers,
 high power, horns, low-frequency drivers, mid-
 bass, outdoor, tweeters, woofers

KARIBU SOUND INDUSTRIES INC.

3500 Parkdale Avenue
 Baltimore, MD 21211
 (301) 383-2167 FAX: (301) 383-7573
 President: Larry Kirchner
 Taub Sales Inc., Silver Spring, MD 301-622-9100
 Leslie's, Chicago, IL 708-697-6677
 Kodo Associates Inc., Minneapolis, MN
 612-881-1255
 Vector Corp., Seattle, WA 206-368-1255
 Multi-Technical Reps., Brainerd, MN 218-828-9483
 PRODUCTS: coax, custom, drivers, high-
 frequency drivers, horns, low-frequency drivers,
 mid-bass, outdoor, tweeters

LEE DAN COMMUNICATIONS, INC.

155 Adams Avenue
 Hauppauge, NY 11788-3699
 (516) 231-1414 (800) 533-3261 FAX: (516) 231-1498
 President: Leon Goldberg; Vice President
 Operations: Lawrence J. Goldberg; V.P. Finance &
 Administration: David H. Goldberg; Senior
 Technician: Sanford Hoffman; Office Manager:
 Rita Kaplan; Sr. Sales/Service Associate: Susan
 Leon
 C.L. Pugh & Associates, Cleveland, OH 216-238-1777
 PRODUCTS: custom, environment protected,
 horns, outdoor

McCauley Sound, Inc.

13608 94th Avenue East
 Puyallup, WA 98373
 (206) 848-0363 FAX: (206) 841-3050
 President/Design Engineer: Tom McCauley; Vice
 President/Production: Pete McCauley; Sales (In-
 House): Bruce Anderson; Marketing: Susahn
 London
 Taub Sales, Silver Springs, MD 301-622-9100
 Une Level Marketing, Minneapolis, MN 612-522-2234
 Innovative Sales & Marketing, Irvine, CA
 714-975-1130
 Pro Musica Sales, Keene, NH 603-352-4831
 Audio Etc., St. Peters, MO 314-278-4130
 PRODUCTS: coax, custom, drivers, full range,
 high-frequency drivers, high power, horns

MG Electronics

32 Ranick Road
 Hauppauge, NY 11788
 (516) 582-3400 FAX: (516) 582-3229
 President: Elliott Maltz; National Sales Manager:
 Stan Grey; Asst. Sls. Mgr., Comm. Sound: Herb
 Wolf; CEM Sales Manager: John Kibbitt; Credit
 Manager: Rita McBerger; Customer Service:
 Sue Novak
 Loomis and Associates, Fremont, CA 415-683-
 0883
 PRODUCTS: coax, custom, drivers, full range,
 high-frequency drivers, high power, horns, low-
 frequency drivers, mid-bass, outdoor, tweeters,
 woofers

Don't Lose That Big Bid... Switch To MG

For 31 years, MG has been providing the perfect match of high quality sound products at prices that will give you the competitive edge. Find out how. Call or write for our new 1991 Commercial Sound, Security, and Professional Sound Products Catalog.

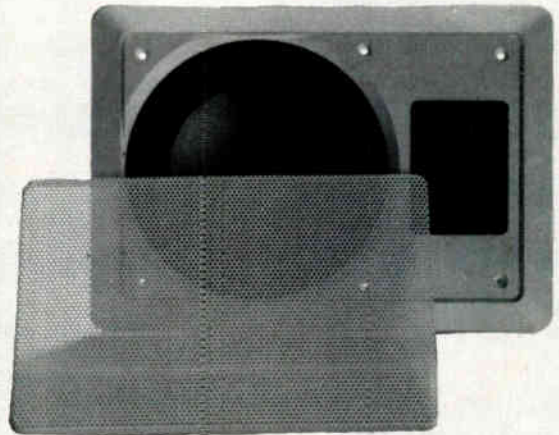

Public Address Speakers

Full Range Speakers

Ceiling and Wall Grills

Commercial Sound Accessories

Foreground and Background Mini

Speaker Systems

In-wall Architectural Speakers

**Multi Purpose Horns for Security
and Paging**

Self Contained Electronic Sirens

Security Product Accessories

Professional Sound Products



ELECTRONICS

"THE COMPETITIVE EDGE"

32 Ranick Road, Hauppauge, N.Y. 11788 516-582-3400

COMMERCIAL SOUND DIVISION

FAX # 516-582-3229

Circle 219 on Reader Response Card

World Radio History



MISCO/Minneapolis Speaker Co., Inc.

3806 Grand Avenue
Minneapolis, MN 55409
(612) 825-1010 FAX: (612) 825-7010
President: Dan Digre; Sales Manager: Don Ringham; Vice President: Cliff Digre;
Production Manager: Tad Thompson
Audio Marketing Assoc., Brecksville, OH 216-526-2426
Austin Associates, Willingsboro, NJ 609-871-9290
Miller Associates, Stamford, CT 203-329-9174
Pacnor Marketing, Lynnwood, WA 206-771-6016
Audio Etc., St. Peters, MO 314-278-4130
PRODUCTS: coax, custom, drivers, environment protected, full range, high-frequency drivers, high power, horns, low-frequency drivers, mid-bass, omnidirectional, horns, outdoor, tweeters, underwater, woofers

Motorola Inc. Ceramic Products

4800 Alameda Blvd. NE
Albuquerque, NM 87113
(505) 822-8801 FAX: (505) 822-8812
Manager, Market Planning: Tony Cristanelli;
Manager, International Sls.: Tom Gilder;
Manager, Eastern Sales: Chery Iverson; Manager, RF Sales: Al Lowenstein; Manager, Western Sales: Roger Milewski
Audio Etc., St. Peters, MO 314-278-4130

MTX

555 W. Lamm Road
Freeport, IL 61032
(815) 232-2000 FAX: (815) 233-2124
President/CEO: Loyd Ivey; Executive V.P./General Mgr.: Rod Boyer; National Sales Manager: Rob Landsberg; Central Reg. Sales Manager: Marco Bregenzer; Eastern Reg. Sales Manager: Rob Kopler; Western Reg. Sales Manager: Griff Lechner
Loomis and Associates, Fremont, CA 415-683-0883
PRODUCTS: coax, drivers, full range, high-frequency drivers, high power, horns, low-frequency drivers, mid-bass, tweeters, woofers

NEAR - New England Audio**Resource**

679 Lisbon Road
Lisbon Falls, ME 04252
(207) 353-7307 FAX: (207) 353-7309
President: William J. Kleitka; Vice President Manufacturing: Robert Adams; V.P. Research & Development: Lewis Athanas; Director of Mktg & Sales: Lee Lareau
Larry Schirmer, Pontiac, MI 313-340-9588
PRODUCTS: coax, custom, drivers, environment protected, full range, high-frequency drivers, low-frequency drivers, mid-bass, outdoor, tweeters, woofers

Outline

Via L. Davinci 56, 25020 Flero, Italy
(30) 358-1341 (800) 358-1351 FAX: (30) 358-0431
President: Guido Noselli; Vice President, Sales: Giorgio Biffi; Marketing Director: Marcello Croce; R & D Director: Giancarlo Puzzi; Sales Manager: Anna Guarenti; Purchasing Manager: Angelo Ferraresi
Coemar Deutschland, ULM, Germany, 073-160-1205
MBS, Lempdes, France, 073-910-630
Leibnitzer M. Bigler, Austria, 034-52-6515
Talsheng Trading, Taipei, Taiwan, 253-13802
Universal, Singapore, 534-5993
Precide, Morbio Inferiore, Switzerland, 914-31734
PCP Electronics, Limassol, Cyprus, 53-39297
Metronome Muzik, Istanbul, Turkey, 7-345-2457
Tropical Recording, Malindi, Kenya, 723-27700
Point Rouge, Mutuelueville, Tunis, 7-345-2457
PRODUCTS: drivers, high-frequency drivers, horns, low-frequency drivers, woofers

PARTS EXPRESS INT'L INC.

340 E. First St.
Dayton, OH 45402
(513) 222-0173 (800) 338-0531 FAX: (513) 222-4644
President: Jeffrey Stahl; Sales Manager: Linda O'Brien; Purchasing Manager: Greg Herting; Advertising Manager: Larry Potter
Chuck Olson Assoc., Renton, WA 206-271-5416
PRODUCTS: coax, drivers, full range, high-frequency drivers, high power, horns, low-frequency drivers, mid-bass, omnidirectional, outdoor, tweeters, woofers

Paso Sound Products, Inc.

14 First Street
Pelham, NY 10803
(914) 738-4800 (800) 231-3034 FAX: (914) 738-3954
Executive Vice President: Paul Mastrangelo;
Product Manager: Ken O'Brien; Credit Manager: Marilyn Beckerson; Operations Manager: Anthony Squegilla
Anderson Sales, Braintree, MA 617-848-9194
Jack Mesnick Sales, Liverpool, NY 315-622-3211
Palmieri Associates, Fairfield, NJ 201-882-1266
Weller Electronic Sales, Inc., Worthington, OH 614-885-7819
Llenau Associates, Columbia, MD 301-621-4113
MJA Marketing, St. Charles, MO 314-447-7111
Northland Assoc., Moorehead, MN 218-233-4616
Allwest Sound & Communication, Camarillo, CA 805-388-7745
Dimension Pt. IX Marketing, Katy, TX 713-578-9277
Mountain Representatives, Denver, CO 303-333-7745
Miguel Lopez, Haleah, FL 305-822-6853
Paco Electronics, Ltd., Markham, ON 416-475-0740
Robert Milsk Co., Southfield, MI 313-354-3310
Marketline Inc., Snellville, GA 404-972-9048
Hawkins-Frederickson Assoc., Maitland, FL 407-831-2474
Lintern Associates, Naperville, IL 708-904-1225
Robert Milsk Co., Indianapolis, IN 317-842-3400
PRODUCTS: drivers, environment protected, full range, horns

PEAVEY ELECTRONICS CORP.

711 A Street
P.O. Box 2898
Meridian, MS 39301
(601) 483-5365 FAX: (601) 484-4278
CEO: Hartley Peavey; President: Mella Peavey
Dimension/Point IX, Lewisville, TX 214-436-3706
PRODUCTS: custom, drivers, environment protected, full range, high-frequency drivers, high power, horns, low-frequency drivers, mid-bass, omnidirectional, outdoor, tweeters, underwater, woofers

Professional Audio Systems

660 N. Twin Oaks Valley Rd.
San Marcos, CA 92069
(619) 591-0360 FAX: (619) 591-3602
President: Larry Doran; Financial Controller: Marilyn Doran; Sales & Mktg. Director: Dan Abelson; Head of Engineering: Allan Sohl
On The Road Marketing, Patterson, NJ 201-523-1425
AMH Sales, Torrance, CA 213-373-2034
Furday and Assoc., Sebastopol, CA 707-874-3101
Mike Chafee Assoc., Sarasota, FL 813-921-4294
Marketing Concepts, Irving, TX 214-869-0669
Audio Biz, Mundellen, IL 708-949-0280
Pro Tech, Midvale, UT 801-561-8844
Online Marketing, Wadsworth, OH 216-336-7504
Future Sales, Redmond, WA 206-861-9100
Appled Audio Marketing, Asheville, NC 704-252-9313
PRODUCTS: coax, drivers, full range, high power, low-frequency drivers, mid-bass, woofers

Progressive Marketing Group, Inc.

224 Route 109
E. Farmingdale, NY 11735
(516) 756-7160 FAX: (516) 756-7165
Audio Etc., St. Peters, MO 314-278-4130

Projected Sound Co., Inc.

469 Avon Ave.
Plainfield, IN 46168
(317) 839-4111 FAX: (317) 839-2476
President: Thomas Hilligoss; Vice President: Dick Hilligoss; Secretary/Treasurer: J. Hilligoss
Camden Marketing, Pierre Fonds, QU 514-683-3377
PRODUCTS: coax, custom, environment protected, full range, outdoor

Pyle Industries, Inc.

501 Center St.
P.O. Box 620
Huntington, IN 46750
(219) 356-1200 FAX: (219) 356-2830
President: Frank Pyle, Jr.; National Sales Manager: Mark Pyle; Internal Sales Manager: Stephanie Pyle; Vice President/Operations: Kent Pyle; Vice President/Finance: Jim Ehrhart;
Engineering Manager: Dennis Crosson
Adams & Associates, Greensboro, NC 919-272-6838
Steve Fisher Sales Corp., Teaneck, NJ 201-837-1200
Don Forth Associates, City of Indus., CA 818-333-8009
McKinney Sales Co., Dallas, TX 214-631-9450
Mark Petty Associates, Schaumburg, IL 708-884-9096
Dimension/Point IX, Lewisville, TX 214-436-3706

Radian Audio Engineering

4520 Eisenhower Circle
Anaheim, CA 92807
(714) 693-9277 FAX: (714) 692-9278
President: Richard Kontrimas; Director of Sales & Mktg.: Jeff Phillips; Order Desk: Mary Wells;
Engineering Manager: Robert Ash; Controller: Judy Truett; Traffic: Carmen Rivera
Seabridge Audio Marketing, Huntington Bch., CA 714-374-0202
Pappas Consulting, Menlo Park, CA 415-324-4325
Creative Audio Marketing, Atlanta, GA 404-642-7827
Lowery Assoc., Broomall, PA 215-356-5300
Professional Sound & Light, Lakewood, CO 303-986-5999
Cambridge Marketing, Westerville, OH 614-363-9191
Neal Hunter & Assoc., Syracuse, OH 315-437-2992
SRT Marketing, Tampa, FL 813-884-4805
Don Ludwig Assoc., Lindenhurst, IL 708-265-0090
PRODUCTS: coax, custom, drivers, full range, high-frequency drivers, high power, horns, low-frequency drivers, mid-bass, tweeters, woofers

Ramsdell Audio

P.O. Box 76186
St. Petersburg, FL 33734
(813) 823-8037
Owner: Richard Ramsdell; Engineer: Michael Conklin
Karp Communications, Tampa, FL 813-968-7098

Renkus-Heinz, Inc.

17191 Armstrong Ave., Irvine, CA 92714
(714) 250-0160 FAX: (714) 250-1035
President: Harro K. Heinz; National Sales & Mktg. Mgr.: Carl C. Dorwaldt; Chief Engineer: Frank Ostrander; Product Manager: Mark Duncan
Karp Communications, Tampa, FL 813-968-7098

REVERE INDUSTRIES

1101 Bienville St.
 New Orleans, LA 70112
 (504) 523-3503 (800) 843-8321 FAX: (504) 525-6361
 Vice President Mktg./Sales: Richard Harris
 Camden Marketing, Pierre Fonds, QU 514-683-3377
 PRODUCTS: coax, drivers, environment protected, full range, high-frequency drivers, high power, horns, low-frequency drivers, mid-bass, omnidirectional, outdoor, tweeters, underwater, woofers

Shogyo International Corp.

287 Northern Boulevard
 Great Neck, NY 11021
 (516) 466-0911 FAX: (516) 466-0922
 President: Mark A. Rubin; Vice President: Howard Rubin
 Karp Communications, Tampa, FL 813-968-7098
 PRODUCTS: coax, custom, drivers, environment protected, full range, high-frequency drivers, high power, horns, low-frequency drivers, mid-bass, omnidirectional, outdoor, tweeters, underwater, woofers

SoundScape Speakers, Inc.

P.O. Box 1653
 Windermere, FL 34786
 (407) 876-6884
 Sales Manager: Susan Collins
 Karp Communications, Tampa, FL 813-968-7098
 PRODUCTS: outdoor

Soundstream Technologies

120 Blue Ravine Road, Folsom, CA 95630
 (916) 351-1288 FAX: (916) 351-0414
 President: Donna Haas; Managing Director: Lee Adams; Director of Engineering: Wade Stewart; Ntl. Sales Mgr., Home Audio: Scott McAllister; Sales Engineer, Home Audio: Andrew Murray
 John W. Steinberg Company, Encino, CA 818-705-7772
 Moskau & Associates, Dallas, TX 214-821-4280
 Creative Marketing Associates, Nashville, TN 615-831-9690
 On Line Marketing, Wadsworth, OH 216-336-7504
 Sound Marketing, Palos Hills, IL 708-598-6888
 Cambridge Marketing, Westerville, OH 614-363-9191
 PRODUCTS: woofers

Speco

1172 Route 109
 P.O. Box 624, Lindenhurst, NY 11757
 (516) 957-8700 (800) 645-5516 FAX: (516) 957-9142
 President: Louis W. Keller; Vice President: James J. Ganci; Vice President of Sales: Mel Hulkower; Sales Manager: Eric Forman; Sales Associate: Angela Carolan; Sales/Expediting: Bernice Zachman
 L.W. Keller and Associates, Lindenhurst, NY 516-226-7733
 Crown Associates, Charlottesville, VA 804-293-6373
 Jonei Sales Associates, Milford, MA 508-478-4650
 Hawkins-Frederickson, Ft. Lauderdale, FL 305-321-6702
 Reptronics, New Madison, OH 513-996-0530
 Karp Communications, Tampa, FL 813-968-7098
 PRODUCTS: coax, custom, drivers, full range, horns, low-frequency drivers, tweeters, woofers

Stanford Acoustics(Sammi Snd. Tech)

470 Stanford Avenue
 Danville, KY 40422
 (606) 236-4050 FAX: (606) 236-7476
 President: Joel C. Iacono
 ELREP Sales, Tucker, GA 404-938-7108
 HC Enterprises, Longmont, CO 303-776-5256
 Professional Audio Marketing, Melville, NY 516-367-8620
 Karp Communications, Tampa, FL 813-968-7098
 PRODUCTS: coax, custom, drivers, full range, high-frequency drivers, high power, horns, low-frequency drivers, mid-bass, tweeters, woofers

TEI Electronics Inc.

570 W. 18 St.
 P.O. Box 246, Hialeah, FL 33011
 (305) 888-3980 (800) 327-8811 FAX: (305) 885-4950
 President: Danny Alonso; Vice President: Mireya A. Muniz; National Sales Manager: Walter McNulty; Customer Service: John Tembras; Sales: Orlando Pineda; Sales: Jose Hurcades
 Audio Biz, Mundellen, IL 708-949-0280
 PRODUCTS: full range, high power, outdoor

The Music People, Inc.

2074 Park St.
 Hartford, CT 06106
 (203) 236-7134 (800) 289-8889 FAX: (203) 233-6888
 President: James R. Hennessey; Controller: John Gutowski; Import/Export Manager: Kelly Helntz; Purchasing Manager: Paul Thaxton
 West Coast Warehouse Facility, Los Angeles, CA



Your One Source for a World of Sound Ideas.

Our worldwide manufacturing facilities can fill virtually any requirement for high quality products at competitive prices: **Voice, Hi-Fi Music, P.A. and Full Range Speakers; Wall and Ceiling Grilles; Paging &**

Security Horns; Speaker Systems; Background/Foreground Minis; Commercial Sound & Security Product Accessories; Professional Sound Products; Buzzers and more. Write or call today for full details.

International © International Components Corporation

105 Maxess Road, Melville, NY 11747 • Toll Free 800-645-9154 • In NY State 516-293-1500 • TELEX 221576 • FAX 516-293-4983

Circle 239 on Reader Response Card



TOA ELECTRONICS, INC.

601 Gateway Blvd. Suite 300
P.O. Box 2047
S San Francisco, CA 94080
(415) 588-2538 (800) 733-4750 FAX: (415) 588-3349
President: Yoshiro Ishida; Director, Audio Products Div: Richard Krochmal; Director, Comm. Systems Div.: Al Burns; Mgr., Marketing Development: Jeff Pailin; Manager, Western Division: Bill Ford; Manager Engineering Services: Bob Sweet
Chuck McGregor - Product Consit, Morris Plains, NJ 201-829-7047
John Murray-Eng. Snd. Mktg. Dev, Springfield, OH 513-324-1993
Bob Hager-Eastern Regional Mgr, Rosewell, GA 404-552-7624
Linda Wick-Central Reg. Mgr., Kansas City, MO 816-453-5775
Robert Slaughter-Cntrl Div Mgr, Houston, TX 713-460-3678
Pete Newmark-West Regional Mgr., Mesa, AZ 602-981-0050
Walter Best, Eastern Reg. Mgr., Sussex, NJ 201-702-0068
PRODUCTS: drivers, full range, high-frequency drivers, high power, horns, low-frequency drivers, outdoor, woofers

Universal Electronics Inc.

The Universal Building
8100 North Central Park
Skokie, IL 60076
(708) 673-5885 FAX: (708) 673-8239
President: Ed Slavin
Cambridge Marketing, Westerville, OH 614-363-9191
PRODUCTS: drivers, full range, high-frequency drivers, high power, horns, low-frequency drivers, mid-bass, tweeters, woofers

UNIVERSITY SOUND INC.

13278 Rolston Avenue
Sylmar, CA 91342
(818) 362-9516 FAX: (818) 367-5292
President: Robert Sandelli; Controller: Mary Cocco; National Sales Manager: Greg McLagan; Design Engineer: Ken Kocesi
Jim Burger, Philadelphia, PA 203-297-7160
PRODUCTS: outdoor, tweeters, underwater, woofers

Waldom Electronics

4301 West 69th Street
Chicago, IL 60629
(312) 585-1212 (800) 552-1639 FAX: (312) 585-7847
President: Roger C. Engle; Sound Products Manager: Mark A. Baumann
Cambridge Marketing, Westerville, OH 614-363-9191
PRODUCTS: drivers, full range, high-frequency drivers, high power, horns, low-frequency drivers

Wexler Music Co. (David Wexler&Co.)

3553 W. Peterson Ave.
Chicago, IL 60659
(312) 478-9800 FAX: (312) 478-9095
President: Mr. B.R. Wexler; Executive Secretary: Ms. Joan Morris
John Anthony, Stamford, CT 203-322-9202

WHEELOCK, INC.

273 Branchport Avenue
Long Branch, NJ 07740
(908) 222-6880 (800) 631-2148 FAX: (908) 222-8707
President: Peter W. Tarlton; V.P. Finance and Admin.: Joseph P. Henry; Vice President Operations: Douglas E. Phillips; Vice President Sales/Mktg.: William L. Goldstein; Telephone/Paging Mktg. Mgr.: Arthur Arlow; Life Safety Mktg. Mgr.: Rein Haus
Joseph P. McCaffrey, Glen Ellyn, IL 708-790-2898
Edward P. Draney, Peachtree City, GA 404-631-3193
Peter Koehler, Los Angeles, CA 213-572-1347
Steve Goldberg, East Windsor, NJ 609-448-1457
Dave Jackowlak, Burbank, IL 708-599-4099
MJA Marketing, St. Charles, MO 314-447-7111
PRODUCTS: horns, outdoor



ADAMSON ACOUSTIC DESIGN CORP.

850 Brock Road, Suite One
Pickering, ON L1W 1Z8
(416) 420-6279 FAX: (416) 420-0813
President: Brock Adamson; Marketing/Sales Manager: Jerry Placken; Office Manager: Lorraine Zerafa
Innovative Sales & Marketing, Irvine, CA 714-528-2005
Martin Wick, Minneapolis, MN 612-522-2234
Audio Blz, Mundelein, IL 708-949-0280
W3 Marketing, Stone Mountain, GA 404-981-7021
Tenickl & Associates, Houston, TX 713-528-2005
PRODUCTS: components, high power, multi-way/ high powered, music system speakers, outdoor, portable, processor-controlled, stage monitors, sub-woofers

Altec Lansing Corp.

10500 W. Reno, Oklahoma City, OK 73128
(405) 324-5311 FAX: (405) 324-8981
President: Dave Merrey; Vice President, Sis. & Mktg: Chuck Lange; National Sales Manager: Jerry Spriggs; Manager Export Marketing: John Sexton; Technical Services Manager: Gary Jones; Customer Services Manager: Jim Brown
Dave Read, McKinney, TX 214-542-6328
Jim Faber, Shreveport, LA 318-631-1766
Paul Froula, Lombard, IL 708-268-1831
Alan Feckanin, Port St. Lucie, FL 407-879-1078
George Soitl, Philadelphia, PA 215-637-3429
Larry Schirmer, Pontiac, MI 313-340-9588
Stu Moffit, Renton, WA 206-277-8851
PRODUCTS: compact, components, full-range, high power, monitor panels, near-field monitors, outdoor, portable, sub-woofers

Apogee Sound Inc.

1150 Industrial Avenue
Petaluma, CA 94952
(707) 778-8887 FAX: (707) 778-6923
President, Dir. Engineering: Ken DeLoria; Vice Pres. Sales & Marketing: Joe Manning; National Sales Manager: Mark Ockenfels; Mktg. & Tech. Training Mgr.: Barry Luz
The H.C. Garrison Co., Tualatin, OR 503-638-4906
Centurian Marketing, Glencoe, MO 314-227-7222
New Horizons, Bannockburn, IL 708-234-6500
Richard Dean Assoc. Inc., Newburyport, MA 508-462-1150
Peter E. Schmitt Co., Leonia, NJ 201-944-2806
Greg Dzubay & Assoc., Glendale, AZ 800-999-0006
Bruce Wismer Sales, Atlanta, GA 404-523-6876
Audio Associates, Fulton, MD 301-604-7300
Eaton Sales & Marketing, Binghamton, NY 607-723-7626
Joe Martin Sales, Austin, TX 512-266-1113
Sherman Rowland Assoc., Fairborn, OH 513-879-1500
PRODUCTS: compact, full-range, high power, music system speakers, portable, processor-controlled, stage monitors, sub-woofers

Argos Products Co.

600 S. Sycamore Street
Genoa, IL 60135
(815) 784-5118
President: D.C. Mac Laughlin; Vice President: Ron Evers; Credit Manager: Rosella Johnson; Chief Engineer: Loren Shrader; Purchasing Agent: Ray Melton
Nevco Inc., Crestwood, MO 314-843-7406
W.A. Hendrickson, N. Scituate, MA 617-545-0652
Meyer & Ross, Burlingame, CA 415-348-6800
Murphy & Cota, Atlanta, GA 404-875-2525
Packnor Marketing, Lynnwood, WA 206-771-6016
Edwards Company, Inc., Livonia, MI 313-458-7777

ATLAS/SOUNDOLIER

1859 Intertech Dr.
Fenton, MO 63026
(314) 349-3110 (800) 876-7337 FAX: (314) 349-1251
VP/Marketing & Sales: Charles Gushwa; VP/Marketing Consultant: Herbert M. Jaffe; National Sales Manager: Bud Waters; Eastern Sales Manager: Tony Satariano; Western Sales Manager: Jeff Garstick; OEM Sales Manager: Larry Damato
Preclide, Morbio Inferiore, Switzerland, 914-31734
PRODUCTS: compact, components, custom, decorative, environment protected, foreground, full-range, high power, monitor panels, multi-way/ high powered, omnidirectional, outdoor, powered

AUDIO-TECHNICA U.S., INC.

1221 Commerce Drive
Stow, OH 44224
(216) 686-2600 FAX: (216) 688-0719
Vice President, Marketing: Ken Reichel; National Marketing Manager: Earl "Buzz" Goodwin; National Sales Manager: Garry Elliott; Inside Sales: Tony O'Keefe; Sales Coordinator: Kim Wallace
Nova Marketing, San Francisco, CA 415-952-0943
PRODUCTS: compact, full-range, music system speakers, omnidirectional, outdoor, sub-woofers

Auernheimer Laboratories and Co.

4561 E. Florence Ave.
Fresno, CA 93725
(209) 442-1048
Owner: Curly Auernheimer

Solve Your Customers' Hearing Problems.

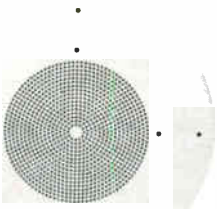
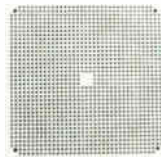
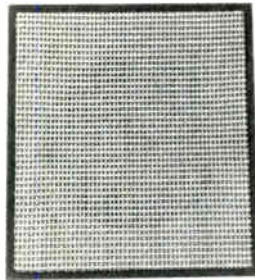

Most customers would rather listen to good sound than a good sales pitch. Because all they really want to hear is that your speakers and system components offer both quality construction and true audio reproduction. And do so at a price that fits their budget.

So, the way we figure it, you've got two choices. You can either recommend another brand and hope they don't give you an earful later. Or you can carry the Gemco line. And the only ringing in your ears will be from making the sale.

For a complete listing of available products and features, ask your electronics distributor or contact GEMCO today.

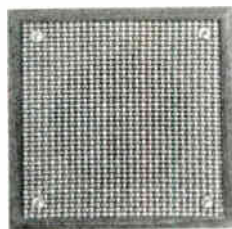
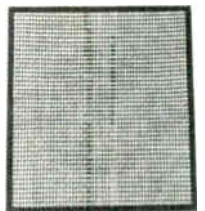

GEMCO

GEMCO Electronics, Inc. P.O. Box 993 Gallatin, TN 37066 (615) 452-5960

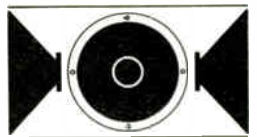

Aural Corporation

4724 Apple Street
Charleston Hts., SC 29405-6704
(803) 747-4782

Product Manager: Chuck King
Nova Marketing, San Francisco, CA 415-952-0943
PRODUCTS: compact, high power, portable, sub-woofers

Auratone Corporation

P.O. Box 180698
Coronado, CA 92178-0698
(619) 297-2820 FAX: (619) 296-8734
President: Jack Wilson
PRODUCTS: studio/reference monitors

Bag End Loudspeaker Systems

22272 Pepper Rd. Unit D, Barrington, IL 60010
(708) 382-4550 FAX: (708) 382-4551
President: James P. Wischmeyer; Director of Engineering: Henry W. Heine; Controller: Deborah Robinson; Production Manager: James J. Schwingel; Sales Manager: John Vitale
Audio Biz, Inc., Mundelein, IL 708-949-0280
Innovative Sales, Irvine, CA 714-975-1130
William Ray & Associates, Smyrna, GA 404-436-7233
Quad Tech, Shawnee Mission, KS 913-677-1013
Irwin Ensemble, Hamilton, OH 513-868-9382
Nova Marketing, San Francisco, CA 415-952-0943
PRODUCTS: components, custom, environment protected, foreground, full-range, high power, music system speakers, portable, processor-controlled, stage monitors, studio/reference monitors, sub-woofers

Bogen Communications, Inc.

50 Spring Street
P.O. Box 575
Ramsay, NJ 07446
(201) 934-8500 FAX: (201) 934-9832
President: John H. Ochtera; Vice President, Sales & Mktg: David A. Chambers
Scott Whipple, Columbus, OH 614-272-1689
Sam Biasi, Ramsay, NJ 201-934-8500
Walter Spencer, Ramsay, NJ 201-934-8500
Fred Yosensick, Woodland, CA 916-668-6311
Edwards Company, Inc., Livonia, MI 313-458-7777
PRODUCTS: compact, components, full-range, high power, near-field monitors, outdoor, portable

BOSE CORP.

The Mountain
Framlingham, MA 01701-9168
(508) 879-7330 FAX: (508) 872-6640
National Sales Manager: Timothy Dorwart;
Eastern Reg. Sales Manager: Bruce Hurst;
Western Reg. Sales Manager: Tim Landwehr; Sr. Applications/Des. Spec.: Bruce Myers; Sr. Sales Representative: Reed Strutzenberg; Sales Representative: Phil Nelson
HC Garrison Co., Tualatin, OR 503-638-4906
Westech Marketing, Culver City, CA 213-870-9286
Silver Peak Marketing, Wheat Ridge, CO 303-467-9042
Rancillo Assoc., St. Louis, MO 314-845-0202
CR Marketing, Clarkston, MI 313-625-2420
J.B. Parent, Dublin, OH 614-764-0064
Secom Systems, Atlanta, GA 404-455-0672
Bencsik Assoc., Ocala, FL 904-732-9775
Sigmet Corp., Valley Forge, PA 215-783-6666
Joseph P. Mazzeo Assoc., Inc., Rochester, NY 716-458-7851
Peter E. Schmitt Co., Inc., Leonia, NJ 201-944-2806
PRODUCTS: compact, environment protected, foreground, full-range, music system speakers, near-field monitors, omnidirectional, outdoor, portable, powered, stage monitors, sub-woofers

Boston Acoustics

70 Broadway
Lynnfield, MA 01940
(617) 592-9000
CEO: Frank Reed; President: Andrew Petite;
Vice President-Engineering: Moses Gabbay; Vice President-Manufacturing: John Swenson; Vice President-Marketing: Ira Friedman; Vice President-Int'l Sales: George Jenkins
ADCOM, Toronto, ON 416-251-3355

Callibration Standard Instruments

P.O. Box 2727
Oakland, CA 94602
(415) 531-8725
President: Edward M. Long; Sales Manager: Allison M. Long
Edwards Company, Inc., Livonia, MI 313-458-7777
PRODUCTS: compact, components, custom, full-range, high power, multi-way/ high powered, near-field monitors, studio/reference monitors, sub-woofers

Caraway Audio

1775 Old County Road #19
Belmont, CA 94002
(415) 594-1790 FAX: (415) 594-0658
Owner: Doug Caraway
Doug Warren, Newport News, VA 804-930-3217

CELESTION INDUSTRIES, INC.

89 Doug Brown Way
Holliston, MA 01746
(508) 429-6706 FAX: (508) 429-2426
President: Peter Wellikoff; Controller: Meredith Nunes; Sales Manager -Pro Products: Brian Coviello; Sales Manager-Consumer Prods: Jim Price; Operations Manager: Steve King; Credit Manager: Marty Michaelson
Reflex Marketing, Hempstead, NY 516-565-2323
Pacific Audio Group, Gardena, CA 213-719-1383
New Horizon Marketing, Bannockburn, IL 708-234-6500
R.W. Fuday Associates, Sebastopol, CA 707-874-3101
Marketing Concepts, Irving, TX 214-869-9870
Taub Sales, Silver Springs, MD 301-662-9100
William Ray Associates, Smyrna, GA 404-436-7233
Future Sales, Redmond, WA 206-861-9100
On Line Marketing, Wadsworth, OH 216-336-7504
KM Ltd., Cambridge, MA 617-876-9870
GMS Marketing, Burnsville, MN 612-895-8088
Dzubay & Associates, Glendale, AZ 602-934-6614
PRODUCTS: compact, components, custom, foreground, full-range, high power, monitor panels, multi-way/ high powered, music system speakers, near-field monitors, processor-controlled, stage monitors, studio/reference monitors, sub-woofers

Cerwin-Vega

555 E. Easy St.
Simi Valley, CA 93065
(805) 584-9332 FAX: (805) 583-0865
V.P. Pro Sales and Marketing: Rich Mandella;
Tech/ Sales & Marketing: John Davies; Inside Sales: Gayle De Matoff
Southwest Marketing, TX, AZ, NM, OK, CO 818-848-7512
MJA Sales, NY, NJ 201-467-9898
Image Marketing, CA, NV 714-957-0630
Crescendo, FL 305-922-9553
Audio Biz, IL 708-949-0280

Clair Brothers Audio Systems Inc

Ditz Drive
Manheim, PA 17545
(717) 665-4000 (800) 356-5080 FAX: (717) 665-2564
Vice President, General Mgr.: Gene Pelland;
President: Roy B. Clair; Treasurer: R. Barry Clair;
Secretary: Troy Clair; Vice President: Gene Clair;
Operations Manager: Jim Bant
Sound Sales, Inc., Columbia, MD 301-964-1170
PRODUCTS: compact, components, custom, foreground, full-range, high power, monitor panels, multi-way/ high powered, music system speakers, outdoor, portable, processor-controlled, stage monitors, sub-woofers

**Community Professional Sound Sysys.**

333 East Fifth Street
Chester, PA 19013
(215) 876-3400 (800) 523-4934 FAX: (215) 874-0190
President: Bruce Howze; Vice President, Export Sales: Christine Howze; Vice President, Sales & Mkt.: John T. Wiggins; General Manager: Charles Moore; Product Specialist: Greg J. Helm; Sales & Marketing Assistant: Grace Paoli
Taub Sales, Silver Springs, MD 301-662-9100
PRODUCTS: compact, components, environment protected, foreground, full-range, high power, monitor panels, multi-way/ high powered, music system speakers, outdoor, processor-controlled, stage monitors, sub-woofers

Compact Monitor Systems

P.O. Box 1965
Studio City, CA 91604
(818) 763-8000

Dawn Speaker Systems

908 W. Fayette Ave.
P.O. Box 748
Effingham, IL 62401
(217) 342-9211 FAX: (217) 347-0316
Product Manager: Don Friedman; National Sales Manager: Don Mitchell
Sound Sales, Inc., Columbia, MD 301-964-1170
PRODUCTS: full-range, music system speakers, near-field monitors, omnidirectional, portable, stage monitors, studio/reference monitors, sub-woofers

DCL

6340 S.W. 145th St.
Miami, FL 33158
(305) 232-2199

Digital Designs International

125 West Main
El Centro, CA 92243
(619) 353-1290 FAX: (619) 353-4751
Engineer: Jassa Langford; Engineer: John Thorp; Sales and Marketing: Alice Sandhu; Sales and Marketing: Diane Franke; Office Manager: Vicki Langford
Doug Warren, Newport News, VA 804-930-3217
PRODUCTS: near-field monitors, sub-woofers

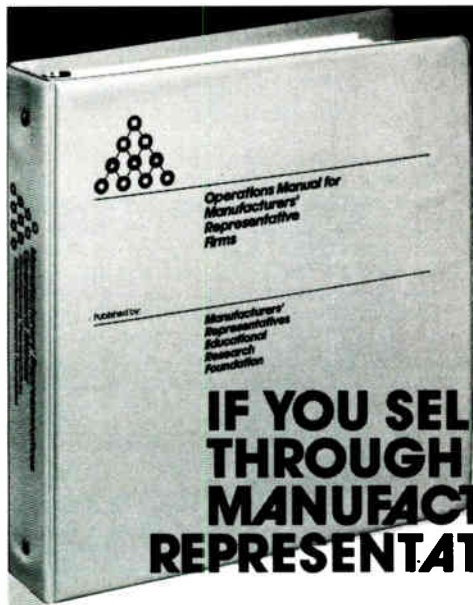

IF YOU SELL THROUGH MANUFACTURERS' REPRESENTATIVES

YOU NEED THIS BOOK!

OPERATIONS MANUAL FOR MANUFACTURERS' REPRESENTATIVE FIRMS

Understand the operating dynamics of the rep companies you rely on to bring your goods to market. Review the guidebook they rely on — their How-To book on operating a sales representative firm.

- "Hands-on" advice, dozens of valuable forms, work-sheets, checklists, from 25 successful reps, plus consultants and academics who know the rep business inside-out.
- Covers
 - Organization and General Procedures
 - Administration and Operations
 - The People in Your Business
 - Sales Management



IF YOU ARE THINKING ABOUT SELLING THROUGH MANUFACTURERS' REPRESENTATIVES

YOU NEED THIS TAPE!

"THE UNIQUE ADVANTAGE"

A new video cassette explaining the Manufacturers' Representative system and the benefits it provides to marketers and buyers.

IDEAL FOR:

- Sales managers pondering how to achieve market coverage
- Sales managers seeking to improve the operations of their rep Sales forces
- Manufacturers' Representatives for recruiting — orienting — training new personnel
- Buyers and purchasing managers who want to work more effectively with the sales people who call on them

This unique 12-minute videotape features live interviews with prominent Lockheed purchasing executive Elaine Whittington, past president of the NAPM, as well as with a sales manager whose company switched away from reps and soon came back. It provides a comprehensive overview of multiple-line selling and the advantages it provides to buyers as well as sellers.

The content of the videotape is not industry-specific; the videotape can be effectively used in any environment or industry where multiple-line selling is practiced — or could be.

ORDER ONE OR BOTH — RISK FREE

SAVE \$15⁰⁰ WHEN YOU BUY BOTH!



If not satisfied, you can return in 15 days for a full refund. Send back the coupon, or order by phone (708) 208-1466, for same-day shipment.

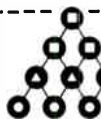

Manufacturers' Representative Educational Research Foundation
P.O. Box 247
Geneva, Illinois 60134

- Please send me a copy of the Operations Manual for Manufacturers' Representative Firms. Price is \$149.95, including postage and handling.
- Please rush me a videotape of The Unique Advantage. Price is \$29.95, including postage and mailing.
- Send both at the special combination price of \$164.95 . . . a \$14.95 saving
- I enclose my check for \$ _____ payable to Manufacturers' Representatives Educational Research Foundation. (Sorry . . . at this low price we cannot bill you.)
- Charge to my Visa Mastercard

Account No. _____ Expires _____

Name: _____

Company: _____

Address: _____

City: _____ State: _____ Zip _____

Rep Association Affiliation (if any) _____

Dukane Corp.

2900 Dukane Drive
St. Charles, IL 60174
(708) 584-2300 FAX: (708) 584-2370
President/C.E.O.: J. McWilliams Stone Jr.;
Pres./Comm. Systems Division: Steven L. Deppe;
National Sales Director: Warren T. Anderson;
Service Manager: Cliff Carlson
Wally Smutts, Toronto, ON 519-748-5352
Doug Fellabaum, Sycamore, IL 815-895-7573
Ken Lind, Boston, MA 617-235-6817
Pete Kendall, Jacksonville, FL 904-262-6025
Jim Lacey, Moreno Valley, CA 714-243-1160
Jack Brown, Dallas, TX 214-943-7528
Sanford Lange, Indianapolis, IN 317-251-3112
PRODUCTS: compact, custom, full-range, high
power, monitor panels

E.A.W.

One Main St.
Whitinsville, MA 01588
(508) 234-6158 (800) 992-5013 FAX: (508) 234-8251
President: Ken Berger; Sales Manager: Frank
Loyko; International Sales Manager: Sandy
MacDonald; Vice President, Engineering: Kenton
Forsythe; C.F.O.: Mark O'Conner; Service
Manager: Steve Davis
Marketing Concepts, Irving, TX 214-869-0669
Secom Systems, Atlanta, GA 404-455-0672
Sigmet Corp., New York, NY 908-462-1221
Ludwig Marketing, Chicago, IL 708-265-0090
Bencsik Assoc., Ocala, FL 904-732-9775
John Anthony, Stamford, CT 203-322-9202
PRODUCTS: components, foreground, full-range,
high power, multi-way/high powered, music
system speakers, near-field monitors, outdoor,
portable, processor-controlled, stage monitors,
sub-woofers

E.M. Long Associates

4107 Oakmore Road
Oakland, CA 94602
(415) 531-8725
Owner: Edward M. Long
Greg Dzubay & Assoc., Glendale, AZ 800-999-0006
PRODUCTS: custom, near-field monitors,
studio/reference monitors, sub-woofers

Eden Electronics, Inc.

310 1st St.
P.O. Box 338
Montrose, MN 55363
(612) 675-3650 FAX: (612) 675-3651
President: David Nordchow
Jim Burger, Philadelphia, PA 203-297-7160
PRODUCTS: compact, components, foreground,
full-range, high power, multi-way/high
powered, stage monitors, sub-woofers

Electro-Voice Inc.

600 Cecil Street
Buchanan, MI 49107
(616) 695-6831 (800) 827-6701 FAX: (616) 695-1304
President: Paul McGuire; Director of Marketing:
Jim Long; Director of Sales: Garry Templin; Sales
& Distribution Mgr.: Janine Masten; Director of
Service/Rapair: Frank Spain; Public Relations
Director: Keith Clark
Metropolis Audio Marketing Inc, New York, NY
908-225-0085
R.J. Marketing Ltd., Rockville, MD 301-251-0330
Ouzunoff & Associates, Yorktown Hts., NY
914-248-7888
Ron Tunks Sales Inc., Tamarac, FL 305-722-2803
Wilson Audio Sales, Nashville, TN 615-646-4477
Audio Resources, Westmont, IL 708-655-1180
B.C. Electronic Sales Inc., Shawnee, KS
913-962-1990
Jones Audio Sales, Plano, TX 214-618-2600

Excellence Marketing, Eden Prairie, MN 612-949-
9011
C.L. Pugh and Associates Inc., Cleveland, OH 216-
238-1777
Riley and Petchell Sales Inc., Detroit, MI 313-937-
3000
Loppnow and Associates, Issaquah, WA 206-392-
3936
Radon and Associates Inc., Sacramento, CA 916-
923-2524
The Torbett/ Keiser Group Inc., Loveland, CO 303-
669-1008
Western Audio, Burbank, CA 818-954-9300
Electro-Voice West, Visalia, CA 209-651-7777
PRODUCTS: compact, components, decorative,
environment protected, foreground, full-range,
high power, monitor panels, multi-way/high
powered, music system speakers, near-field
monitors, omnidirectional, outdoor, portable,
powered, processor-controlled, stage monitors,
studio/reference monitors, sub-woofers

ENVIRONMENTAL SOUND

31220 La Baya Dr., Bld. #110
Westlake Vlg., CA 91362
(818) 706-0228 FAX: (818) 889-5605
President: Pascal Delbuck; Marketing: Ron
Glatzoffer; Plant Manager: Bill Ward
Cambridge Marketing, Westerville, OH
614-363-9191
PRODUCTS: custom, decorative, environment
protected, foreground, full-range, high power,
music system speakers, near-field monitors,
stage monitors, studio/reference monitors, sub-
woofers

Equity Sound Investments

629 Eastern Ave. Unit 2
Toronto, ON M4M 1E4
(416) 465-4888 FAX: (416) 465-3919
Preclde, Morbio Inferiore, Switzerland,
914-31734

Fender Musical Instruments/Sunn

1130 Columbia Street, Brea, CA 92621
(714) 990-0909 FAX: (714) 990-3986
President/CEO: William C. Schultiz; Vice
President, Marketing: Steve Grom; National
Sales Manager: Larry Moudy
Keith Brawley, Southern, CA
Jerry Arena, Northern, CA
Terry Rudonlah, North West,
Howie Frelman, TX
Layne Kurr, Chicago, IL
Karp Communications, Tampa, FL 813-968-7098
PRODUCTS: full-range, high power, music system
speakers, stage monitors

Formula Audio, Incorporated

Rt.5
Box 440-3
Zebulan, NC 27597
(919) 269-6441
President: Jeffrey A. Forsburg
Greg Dzubay & Assoc., Glendale, AZ 800-999-0006

FOSTEX CORPORATION OF AMERICA

15431 Blackburn Ave., Norwalk, CA 90650
(213) 921-1112 (800) 7-FOSTEX
FAX: (213) 802-1964
V.P. Marketing/ General Mgr.: Robert Veri; V.P.
Sales: Mark Cohen
J.B. Parent, Dublin, OH 614-764-0064
PRODUCTS: compact, near-field monitors,
portable, powered, studio/reference monitors,
underwater

Frazier/DIV of SoundCraft Sys. Inc.

Pettit Jean Mountain, Rt. 3
Box 319
Morrilton, AR 72110-9532
(501) 727-5543 FAX: (501) 727-5402
Vice Pres. Sales & Marketing: James R. Truelsen
Dick Bellew Sales, Dallas, TX 214-644-7881
Design Factors, La Habra, CA 213-697-7576
White Radio, Ltd., Burlington, Ont, CN
416-632-6894
Lowery Associates, Broomall, PA 215-356-5300
Henry W. Phillips Co., Inc., Roswell, GA
404-992-3070
Greg Dzubay & Assoc., Glendale, AZ 800-999-0006

Galaxy Audio

625 East Pawnee
Wichita, KS 67211
(316) 263-2852 (800) 369-7768 FAX: (316) 263-0642
Greg Dzubay & Assoc., Glendale, AZ 800-999-0006
PRODUCTS: compact, full-range, multi-way/high
powered, portable, powered, stage monitors

Genelec/QMI

15 Strathmore Road
Natick, MA 01760
(508) 650-9444 FAX: (508) 650-9476
President: Scott Berdell
Greg Dzubay & Assoc., Glendale, AZ 800-999-0006

GERR Electro Acoustics Ltd.

363 Adelaide Street East
Toronto, ON M5A 1N3
(416) 868-0528 FAX: (416) 868-6419
President: Bob Snelgrove; Vice President: Frank
Plimiskern
GERRWEST, Vancouver, BC 604-688-2444
Andrew Hope, Montreal, PQ 514-524-2228
Andy Cox, Toronto, 416-868-0528
John Anthony, Stamford, CT 203-322-9202

Headwater USA

2669 Guolin Street
Detroit, MI 48207
(313) 961-3196 FAX: (313) 567-1352
Sales Representative: Tim Jarrold; President:
Gary Taylor; Sales Representative: Barry Rumball
Headwater Industries, Windsor, Ont., CN
519-256-5665
John Anthony, Stamford, CT 203-322-9202
PRODUCTS: compact, custom, decorative,
foreground, full-range, high power, multi-way/
high powered, music system speakers,
omnidirectional, outdoor, portable, powered,
processor-controlled, stage monitors, sub-
woofers

HI Lo Fabrication & Manufacturing

P.O. Box 509 / CR 1105
Rio Vista, TX 76093
(817) 373-2247
President: Cecil Caro; Production Engineer:
Cecil Caro; Vice President, Sales: Bridget Caro
ADCOM, Toronto, ON 416-251-3355
PRODUCTS: custom, decorative, environment
protected, monitor panels, outdoor, portable,
stage monitors

Infinity Systems, Inc.

9409 Owensmouth Ave.
Chatsworth, CA 91311
(818) 407-0228 FAX: (818) 709-9486
President: Cary Christie; Sr. Vice Pres. Sales &
Mktg.: Rich Bacchaluppi; Vice Pres. Int'l Sales:
Derek Whiteman
Doug Warren, Newport News, VA 804-930-3217

True to the Source



Since 1979, Meyer Sound Laboratories has built loudspeaker systems for consultants, producers, engineers and performers. Our goal has been to design systems that support the artistry of your work.

Guided by uncompromising standards of performance, Meyer has pioneered in the areas of control electronics, arrayability and room equalization (SIM®). As a result, Meyer Sound remains the system of choice for clients as diverse as Grateful Dead, Les Miserables, Lily Tomlin and Carnegie Hall.

Our motivation is simple: to reproduce sound accurately and coherently, true to the source.

**Sound
engineering
for the art
and science
of sound.**

©1990 Meyer Sound



Meyer Sound Laboratories, Inc.
2832 San Pablo Avenue
Berkeley, CA 94702
(415) 486-1166
FAX (415) 486-8356

M
E
Y
E
R
S
O
U
N
D

International Components Corp.

105 Maxess Road
 Meville, NY 11747
 (516) 293-1500 (800) 645-9154 FAX: (516) 293-4983
 President: Mort Grossman; Executive Vice
 President: Irwin Friedman; Vice President: Fred
 Grossman; Eastern Regional Sales Mgr.: Ken
 Reed; Vice President: Harvey Grossman
 C.B. Electronic Marketing, Arvada, CO 303-422-
 0561

Intersonics, Inc.

3453 Commercial Avenue
 Northbrook, IL 60062-1818
 (708) 272-1772 FAX: (708) 272-9324
 Director of Sales & Mktg.: Barry Bozeman;
 General Mgr. Speaker Div.: Thomas Danley;
 Design Engineer: Dan Mapes-Riordan; Design
 Engineer: Greg Botlmer; Production Manager:
 Peter Bruno
 Audio Marketing Assoc., Brecksville, OH 216-526-
 2426
 ASR Enterprises, Fallston, MD 301-893-0001
 New England Technical Assoc., New Haven, CT
 203-467-8010
 World Wide Electronics, Davie, FL 305-584-7024
 Innovative Sales & Mktg., Irvine, CA 714-975-1130
 ADCOM, Toronto, ON 416-251-3355

J.W. DAVIS AND CO.

3030 Canton Street
 Dallas, TX 75226
 (214) 651-7341 (800) 527-5705 FAX: (214) 939-0328
 President: Harvey Earp; Vice President, Sales:

Jack W. Tucker; Chief Engineer: Eric Simonson
 Multi-Technical Reps., Brainerd, MN 218-828-9483
 PRODUCTS: compact, components, decorative,
 environment protected, foreground, full-range,
 high power, music system speakers,
 omnidirectional, outdoor, portable

JBL Professional

8500 Balboa Boulevard
 P.O. Box 2200
 Northridge, CA 91329
 (818) 893-8411 FAX: (818) 893-3639
 President: Ronald Means; Vice President, Sales:
 Ken Lopez; Vice President, Marketing: Mark
 Gander; Market Manager: Hector Martinez;
 National Sales Manager: Nell Conley
 Jim Chase, San Clemente, CA 714-492-6290
 Bill Hamilton, Folsom, PA 215-543-4677
 Bill Schuermann, Houston, TX 713-370-5553
 Tom Walter, No. Barrington, IL 312-382-4925
 ADCOM, Toronto, ON 416-251-3355
 PRODUCTS: compact, components, decorative,
 environment protected, foreground, full-range,
 high power, monitor panels, multi-way/ high
 powered, music system speakers, near-field
 monitors, outdoor, portable, stage monitors,
 studio/reference monitors, sub-woofers

KARIBU SOUND INDUSTRIES INC.

3500 Parkdale Avenue
 Baltimore, MD 21211
 (301) 383-2167 FAX: (301) 383-7573
 President: Larry Kirchner
 Taub Sales Inc., Silver Spring, MD 301-622-9100
 Leslie's, Chicago, IL 708-697-6677

Kodo Associates Inc., Minneapolis, MN
 612-881-1255

Vector Corp., Seattle, WA 206-368-1255
 Multi-Technical Reps., Brainerd, MN 218-828-9483
 PRODUCTS: compact, components, custom,
 foreground, full-range, high power, monitor
 panels, multi-way/ high powered, music system
 speakers, near-field monitors, portable,
 studio/reference monitors, sub-woofers

KDM Electronics Inc.

705 Progress Avenue Unit #59
 Scarborough, ON M1H 2X1
 (416) 439-7158 FAX: (416) 439-7232
 President: Ron Bull
 Admiral Sales Company, Dallas, TX 214-357-9212
 Henry W. Phillips Co., Inc., Roswell, GA 404-992-
 3070
 Reptronics Inc., New Madison, OH 513-996-0530
 Coaxial Systems Associates, Tequesta, FL 407-
 746-6626
 Multi-Technical Reps., Brainerd, MN 218-828-9483
 PRODUCTS: foreground, full-range, high power,
 multi-way/ high powered, music system
 speakers, omnidirectional, outdoor

Klipsch and Associates, Inc.

Route 4 Oakhaven Rd.
 P.O. Box 688, Hope, AR 71801
 (501) 777-6751 (800) 274-5547 FAX: (501) 777-6753
 President: P. Woody Jackson; Vice President
 International: Jack Fountain; Mkt'g Specialist,
 Pro. Prod.: Tom Gallagher
 New England Technical Assoc., New Haven, CT
 203-467-8010
 Audio Associates Corp., Verona, NJ 201-239-3727
 PCM Marketing, Walnut Creek, CA 415-935-0900
 RPM, Carrollton, TX 214-446-3010
 Starir Marketing, Chesterton, IN 219-929-4127
 Multi-Technical Reps., Brainerd, MN 218-828-9483

Knoll Systems

717 Simondson Dr.
 Ste. 206, Point Roberts, WA 98281
 (604) 272-4555 FAX: (604) 272-5595
 President: Kevin Knoll; Sales Mgr.: Roy Mett;
 Accounts: Darcy Knoll; Service Mgr.: Don
 Stewart
 Design Factors, La Habra Hts., CA 213-697-7576
 Symte, Silver Springs, MD 301-593-6610
 Roy Kennedy, Chesterfield, MO 314-576-5440
 Vector Marketing, Seattle, WA 206-368-8400
 B. Rich Co., Penfield, NY 716-377-3401
 Audio Etc., St. Peters, MO 314-278-4130

LAR Electronics Corporation

718 Ninth Street, Niagara Falls, NY 14301
 (716) 282-2442 FAX: (716) 284-8013
 Owner: Larry Kutner
 Audio Etc., St. Peters, MO 314-278-4130

McCauley Sound, Inc.

13608 94th Avenue East
 Puyallup, WA 98373
 (206) 848-0363 FAX: (206) 841-3050
 President/Design Engineer: Tom McCauley; Vice
 President/Production: Pete McCauley; Sales (In-
 House): Bruce Anderson; Marketing: Susann
 London
 Taub Sales, Silver Springs, MD 301-622-9100
 Line Level Marketing, Minneapolis, MN
 612-522-2234
 Innovative Sales & Marketing, Irvine, CA
 714-975-1130
 Pro Musica Sales, Keene, NH 603-352-4831
 Audio Etc., St. Peters, MO 314-278-4130
 PRODUCTS: compact, components, custom, high
 power, multi-way/ high powered, music system
 speakers, near-field monitors, portable, stage
 monitors, sub-woofers

The paradox of commercial
 sound installation is the
 discovery that audio
 components rugged enough for
 commercial applications are not
 necessarily true high fidelity.
 Finding the precise ratio of
 durability and high end
 performance is key to successful
 installations.

Introducing the SR-6
 subwoofer by Celestion. Shown
 here with the popular Studio-3
 and Studio-5 Monitors. This
 system is right on target when
 specifications require true high
 fidelity, cased inside small,
 sturdy cabinetry. Celestion
 monitor systems are capable of
 providing the full spectrum of
 audio requirements, from
 aggressive to subtle in-fill.

Contact your local
 dealer, or Celestion for technical
 information and the name of
 your nearest Celestion retailer.

Concise.



SR-6 Subwoofer with Studio 3 & 5 Monitors

CELESTION

CELESTION INDUSTRIES, INC.
 89 DOUG BROWN WAY • HOLLISTON, MA 01746
 VOICE (508) 429-6706 • FAX (508) 429-2426

Celestion International Ltd • Foxhall Rd • Ipswich, UK

Circle 270 on Reader Response Card

SOUND & COMMUNICATIONS BLUE BOOK 91/92

Here it is in Black and White . . .



- PRO™ circuit independent high-frequency and low-frequency speaker protection
- Threaded inserts for mounting ease
- Rugged, weather-resistant, paintable, polystyrene cabinet
- 4-ohm version and built-in 70-volt transformer version with screwdriver-selectable taps

Electro-Voice S-40 compact speakers handle 160 watts of long-term power per EIA standard RS-426A. Both high-frequency and low-frequency driver protection is provided by EV's exclusive PRO™ circuits. The S-40T incorporates a 70/100-volt, built-in transformer that handles 30 watts. It also has a weather-resistant, covered barrier-strip connector with a grommetted cable exit.

The cabinet, available in both black and white, offers mounting ease with optional mounting bracket or Omni-Mount™ Systems Series 25. Low magnetic leakage makes the S-40 ideal for use near video monitors without interference.



Screwdriver selectable taps on 70-volt version

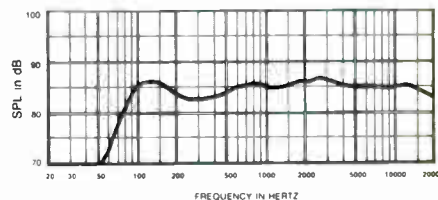

- The smoothest response in the industry

The Electro-Voice S-40 Speaker — the industry's best value in terms of size, versatility and performance.



Electro-Voice®
a MARK IV company

Install the Very Best...Specify Frazier CAT™ 40

- Dual horn, Point Source Alignment
- Coherent phase & time domains
- Smooth 90°X90° Speech pattern
- Full band width 65Hz - 17KHz

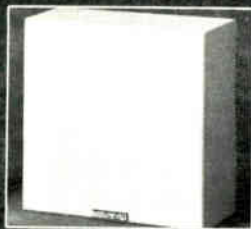

New Decorator white

Coincident Aligned Transducers



State of the art 2'X2' alternate to ceiling Co-Axes

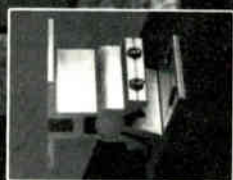

Mounting Bracket

When you specify and install FRAZIER CAT™ 40's you've done your *very best!* Our CAT™ design establishes point source accuracy and signal alignment. Smooth, controlled energy ... excellent gain before feedback ... for reverberent spaces ... That's the CAT™ 40.

FRAZIER

Route 3, Box 319 • Morrilton, Arkansas 72110
(501)727-5543
Toll Free 1-800-422-7757
FAX (501)727-5402



LOUDSPEAKERS - SYSTEMS

Meyer Sound Laboratories Inc.

2832 San Pablo Ave.
Berkeley, CA 94702
(415) 486-1166 FAX: (415) 486-8356
Vice President, Sales & Mktg: Helen Meyer;
Marketing Manager: Ralph Jones; Director of
Technical Mkt'g: Mark Johnson; Customer
Service Manager: Scott Gledhill; National Sales
Manager: Cindy Ramos
Loomis and Associates, Fremont, CA
415-683-0883

PRODUCTS: full-range, high power, near-field
monitors, processor-controlled, stage monitors,
studio/reference monitors, sub-woofers

MG Electronics

32 Ranick Road
Hauppauge, NY 11788
(516) 582-3400 FAX: (516) 582-3229
President: Elliott Maltz; National Sales Manager:
Stan Grey; Asst. Sis. Mgr., Comm. Sound: Herb
Woll; CEM Sales Manager: John Kibbitt; Credit
Manager: Rita Mciberger; Customer Service:
Sue Novak

Loomis and Associates, Fremont, CA
415-683-0883
PRODUCTS: compact, components, foreground,
full-range, high power, music system speakers

MISCO/Minneapolis Speaker Co., Inc.

3806 Grand Avenue
Minneapolis, MN 55409
(612) 825-1010 FAX: (612) 825-7010
President: Dan Digre; Sales Manager: Don
Ringham; Vice President: Cliff Digre;
Production Manager: Tad Thompson
Audio Marketing Assoc., Brecksville, OH
216-526-2426
Austin Associates, Willingsboro, NJ 609-871-9290
Miller Associates, Stamford, CT 203-329-9174
Pacnor Marketing, Lynnwood, WA 206-771-6016
Audio Etc., St. Peters, MO 314-278-4130
PRODUCTS: components, custom, environment
protected, full-range, outdoor, underwater

Modular Sound Systems, Inc.

22272 Pepper Rd, Unit D
Barrington, IL 60010
(708) 382-4550 FAX: (708) 382-4551
President: James P. Wischmeyer; Director of
Engineering: Henry W. Heine; Controller:
Deborah Robinson; Production Manager: James
J. Schwingel; Sales Manager: John Vitale
Multi-Technical Reps., Brainerd, MN 218-828-9483
PRODUCTS: compact, components, custom,
decorative, full-range, high power, multi-way/
high powered, music system speakers, outdoor,
portable, processor-controlled, stage monitors,
studio/reference monitors, sub-woofers

NEAR - New England Audio Resource

679 Lisbon Road
Lisbon Falls, ME 04252
(207) 353-7307 FAX: (207) 353-7309
President: William J. Kleityka; Vice President
Manufacturing: Robert Adams; V.P. Research &
Development: Lewis Athanas; Director of Mktg &
Sales: Lee Lareau
Larry Schirmer, Pontiac, MI 313-340-9588
PRODUCTS: compact, components, custom,
environment protected, full-range, music system
speakers, outdoor, sub-woofers

OAP Audio Products

310 Peachtree Industrial Blvd.
Buford, GA 30518
(404) 945-1028 FAX: (404) 945-1843
President: Michael O'Rourke; Business Manager:
Dana Hunter; Production Manager: Doyle
Henderson
Elrep Sales, Tucker, GA 404-938-7108
ASR, Fallston, MD 301-893-0001
GMS, Burnsville, MN 612-895-8088
MIPA Sales, Lyons, CO 303-823-5101
Midwest Audio Marketing, Crete, IL 708-672-3056
Nova Marketing, San Francisco, CA 415-952-0943
R.S. Enterprises, Redmond, WA 206-883-1482
Tim Edwards Marketing, Garden Grove, CA
714-539-6401
Worldwide Electronics, Ft. Lauderdale, FL
305-584-7024
BVC International, Corpus Christi, TX
512-857-6661
PRODUCTS: full-range, high power, multi-way/
high powered, music system speakers, near-field
monitors, portable, stage monitors

Olson Acoustics

920 Grayson St.
Berkeley, CA 94710
(415) 644-2500
Camden Marketing, Pierre Fonds, QU 514-683-3377

outline®

Outline

Via L. DaVinci 56, 25020 Fiero, Italy
(30) 358-1341 (800) 358-1351 FAX: (30) 358-0431
President: Guido Noseili; Vice President, Sales:
Giorgio Biffi; Marketing Director: Marcello Croce;
R & D Director: Giancarlo Puzzi; Sales Manager:
Anna Guarenti; Purchasing Manager: Angelo
Ferraresi
Coemar Deutschland, ULM, Germany,
073-160-1205
MBS, Lempdes, France, 073-910-630
Leibnitzer M. Bigler, Austria, 034-52-6515
Taisheng Trading, Taipei, Taiwan, 253-13802
Universal, Singapore, 534-5993
Precide, Morbio Inferiore, Switzerland,
914-31734
PCP Electronics, Limassol, Cyprus, 53-39297
Metronome Muzik, Istanbul, Turkey, 7-345-2457
Tropical Recording, Malindi, Kenya, 723-27700
Point Rouge, Mutuelueville, Tunis, 7-345-2457
PRODUCTS: high power, multi-way/ high
powered, processor-controlled, stage monitors,
sub-woofers

OWI INC.

1160 Mahalo Place, Compton, CA 90220
(213) 638-4732 (800) 638-1694 FAX: (213) 638-8347
President: Ned Morloka; Vice President: Hiro
Okayama; Director of Sales: Kristin Jo Morloka;
Credit Manager: June Morloka
Loomis and Associates, Fremont, CA 415-683-0883
PRODUCTS: compact, custom, decorative,
foreground, music system speakers,
omnidirectional, outdoor, portable, sub-woofers

Circle 277 on Reader Response Card

Panasonic Professional Audio Sys.

6550 Katella Avenue, Cypress, CA 90630
 (714) 373-7278 FAX: (714) 373-7242
 Nat. Sales & Marketing Mgr.: Steve Woolley;
 Marketing Manager: Chris Foreman; Western
 Regional Sales Mgr.: James Murray; Midwest
 Regional Sales Mgr.: Greg Braithwaite; Eastern
 Regional Sales Mgr.: Carla Campbell;
 Telemarketing Sales Mgr.: Lynn Thompson
 James Murray, Cypress, CA 714-373-7389
 Greg Braithwaite, Arlington, IL 708-981-7329
 Carla Campbell, Norristown, PA 215-630-1651
 Cambridge Marketing, Westerville, OH 614-363-9191
 PRODUCTS: compact, full-range, near-field
 monitors, stage monitors, sub-woofers

Paramount Picts. Home Theater Prods

1950 E. Orangethorpe, Fullerton, CA 92631
 (714) 526-0711 FAX: (714) 526-0715
 General Manager: Rick Strickland; Accounts
 Sales Manager: Al Hernandez
 California Sales & Marketing, San Juan Capis., CA
 714-489-8559
 J. R. Morgan, Phoenix, AZ 602-268-3464
 Meyer Marketing, Deerfield Beach, FL 305-481-9250
 Jamm Distributing, Flossmoor, IL 708-799-0550
 Henry Phillips, Roswell, GA 404-992-3070
 Audio Etc., St. Peters, MO 314-278-4130
 PRODUCTS: full-range, multi-way/ high powered,
 omnidirectional, outdoor, sub-woofers

Parasound Products Inc.

950 Battery Street, San Francisco, CA 94111
 (415) 397-7100 (800) 822-8802 FAX: (415) 397-0144
 President: Richard Schram; Account Manager:
 Karen Richardson; Technical Services: Richard
 Rodgers; Accounting Manager: Pamela Miller
 Marshank Sales Company, Los Angeles, CA
 213-670-7071
 Harry Rosenblum Company, White Plains, NY
 914-428-0811
 Total Electronix, Ft. Lauderdale, FL 612-881-1255
 Charles Lucas Sales, Dallas, TX 214-330-8181
 Summit Sales & Marketing, Des Moines, IA
 515-253-0738
 Cambridge Marketing, Westerville, OH 614-363-9191

Paso Sound Products, Inc.

14 First Street
 Pelham, NY 10803
 (914) 738-4800 (800) 231-3034 FAX: (914) 738-3954
 Executive Vice President: Paul Mastrangelo;
 Product Manager: Ken O'Brien; Credit Manager:
 Marilyn Beckerson; Operations Manager:
 Anthony Squeglla
 Anderson Sales, Braintree, MA 617-848-9194
 Jack Mesnick Sales, Liverpool, NY 315-622-3211
 Palmieri Associates, Fairfield, NJ 201-882-1266
 Weller Electronic Sales, Inc., Worthington, OH
 614-885-7819
 Lienau Associates, Columbia, MD 301-621-4113
 MJA Marketing, St. Charles, MO 314-447-7111
 Northland Assoc., Moorehead, MN 218-233-4616
 Allwest Sound & Communication, Camarillo, CA
 805-388-7745
 Dimension Pt. IX Marketing, Katy, TX 713-578-9277
 Mountain Representatives, Denver, CO 303-333-7745
 Miguel Lopez, Hialeah, FL 305-822-6853
 Paco Electronics, Ltd., Markham, ON 416-475-0740
 Robert Milsk Co., Southfield, MI 313-354-3310
 Marketline Inc., Snellville, GA 404-972-9048
 Hawkins-Frederickson Assoc., Maitland, FL 407-831-2474
 Lintern Associates, Naperville, IL 708-904-1225
 Robert Milsk Co., Indianapolis, IN 317-842-3400
 PRODUCTS: compact, components, decorative,
 environment protected, foreground, full-range,
 high power, music system speakers, portable

PEAVEY ELECTRONICS CORP.

711 A Street
 P.O. Box 2898, Meridian, MS 39301
 (601) 483-5365 FAX: (601) 484-4278
 CEO: Hartley Peavey; President: Mella Peavey
 Dimension/ Point IX, Lewisville, TX 214-436-3706
 PRODUCTS: compact, components, custom, full-
 range, high power, multi-way/ high powered,
 near-field monitors, omnidirectional, outdoor,
 portable, powered, processor-controlled, stage
 monitors, studio/reference monitors, sub-
 woofers
Professional Audio Systems
 660 N. Twin Oaks Valley Rd., San Marcos, CA 92069
 (619) 591-0360 FAX: (619) 591-3602
 President: Larry Doran; Financial Controller:
 Marilyn Doran; Sales & Mktg. Director: Dan

Abelson; Head of Engineering: Allan Sohi
 On The Road Marketing, Patterson, NJ 201-523-1425
 AMH Sales, Torrance, CA 213-373-2034
 Furdard and Assoc., Sebastopol, CA 707-874-3101
 Mike Chafee Assoc., Sarasota, FL 813-921-4294
 Marketing Concepts, Irving, TX 214-869-0669
 Audio Biz, Mundellin, IL 708-949-0280
 Pro Tech, Midvale, UT 801-561-8844
 Online Marketing, Wadsworth, OH 216-336-7504
 Future Sales, Redmond, WA 206-861-9100
 Applied Audio Marketing, Asheville, NC
 704-252-9313
 PRODUCTS: compact, components, environment
 protected, full-range, high power, multi-way/
 high powered, near-field monitors, portable,
 processor-controlled, stage monitors,
 studio/reference monitors, sub-woofers

The shape of pure sound...

Community's design philosophy has always been a little unconventional.

When everyone else was insisting on metal, we promoted the precise shapes achievable through fiberglass. When others built walls of direct radiators, we built efficiency. When most of professional sound was divided at 800 Hz, we concentrated on midrange.

For those prepared to listen, the rewards of good design are clear.

In the RS220 Wavefront Coherent™ Loudspeaker system we have created the true culmination of Community design—precise fiberglass curves flowing into matched components—a system designed for effortless performance with maximum efficiency, power and clarity.

Community's RS220
The shape of pure sound...

Community
 PROFESSIONAL SOUND SYSTEMS

333 East Fifth Street
 Chester, PA 19013
 (215) 876-3400
 FAX (215) 874-0190

Radlan Audio Engineering

4520 Eisenhower Circle, Anaheim, CA 92807

(714) 693-9277 FAX: (714) 692-9278

President: Richard Kontrimas; Director of Sales & Mktg.: Jeff Phillips; Order Desk: Mary Wells; Engineering Manager: Robert Ash; Controller: Judy Truett; Traffic: Carmen Rivera
Seabridge Audio Marketing, Huntington Bch., CA 714-374-0202

Pappas Consulting, Menlo Park, CA 415-324-4325

Creative Audio Marketing, Atlanta, GA 404-642-7827

Lowery Assoc., Broomall, PA 215-356-5300

Professional Sound & Light, Lakewood, CO 303-986-5999

Cambridge Marketing, Westerville, OH 614-363-9191

Neal Hunter & Assoc., Syracuse, OH 315-437-2992

SRT Marketing, Tampa, FL 813-884-4805

Don Ludwig Assoc., Lindenhurst, IL 708-265-0090

PRODUCTS: compact, components

Rainbow Sound and Lighting

2322 So. 64th Avenue

Omaha, NE 68106

(402) 554-0123

President: Nils Anders Erickson; Manager: J.E. Van Horne

Karp Communications, Tampa, FL 813-968-7098

Renkus-Heinz, Inc.

17191 Armstrong Ave.

Irvine, CA 92714

(714) 250-0160 FAX: (714) 250-1035

President: Harro K. Heinz; National Sales & Mktg.

Mgr.: Carl C. Dorwaldt; Chief Engineer: Frank

Ostrander; Product Manager: Mark Duncan

Karp Communications, Tampa, FL 813-968-7098

REVERE INDUSTRIES

1101 Blenville St., New Orleans, LA 70112

(504) 523-3503 (800) 843-8321 FAX: (504) 525-6361

Vice President Mktg./Sales: Richard Harris

Camden Marketing, Pierre Fonds, QU 514-683-3377

PRODUCTS: components, environment protected, foreground, full-range, high power, monitor panels, music system speakers, omnidirectional, outdoor, sub-woofers

Rockustics, Inc.

15400 E. Batavia Dr., Aurora, CO 80011

(303) 363-6161 FAX: (303) 363-0011

President: Anthony F. Mule; Vice President:

Bruce Marcel; Sec. Treas.: Tom Maxey

Sigmat Corp., Freehold, NJ 908-462-1221

Bencsik Ass., Ocala, FL 904-732-9775

New Resource, Hanover, MA 617-871-2020

Darmstedter & Assoc., Baldwinville, NY

315-638-1261

Pro-Audio, Barrington, IL 708-526-1660

Audio Etc., St. Peters, MO 314-278-4130

Dobbs-Stanford, Dallas, TX 214-358-0800

Evans Sales & Marketing, Nashville, TN 615-256-4675

McFadden Sales & Mktg., Columbus, OH

614-761-3177

Network Marketing, Los Angeles, CA 213-836-6650

Gibco, Edina, MN 612-831-4591

Northmar, Seattle, WA 206-524-5170

The King Co., Tracey, CA 209-832-8800

Frank Lombardo & Assoc., Elmont, NY 516-352-4448

PRODUCTS: custom, decorative, environment protected, foreground, full-range, high power, music system speakers, outdoor, sub-woofers

SONANCE

961 Calle Negocio, San Clemente, CA 92672

(714) 492-7777 (800) 582-7777 FAX: (714) 361-2705

President: Scott Struthers; Vice President:

Geoff Spencer; Sales Manager: Dave Donald;

International Sales Manager: Mark Cichowski;

Public Relations Director: Mitch Simon; Dir. Sis

Trn. & Mkt. Research: Kevin Leja

Morris Tait and Assoc., Los Angeles, CA

213-877-4424

Bach Sales, New York, NY 212-727-0404

Tandem Marketing, Chicago, IL 708-605-1960

Dobbs Stanford, Dallas, TX 214-358-0800

Balaton Marketing, Washington DC,

202-471-1764

MJA Marketing, St. Charles, MO 314-447-7111

PRODUCTS: compact, decorative, environment protected, full-range, high power, music system speakers, outdoor, sub-woofers

YOU ASKED FOR IT!

- 60" x 30" horn for farfield coverage
- L-Pad for nearfield horn
- Fully adjustable 90" x 40" horn for nearfield coverage
- Trapezoid shape for easy arraying
- Integral hardware for easy rigging
- Choice of side panels to match decor
- Choice of grill colors to match decor
- Can be used in single or multiple configuration

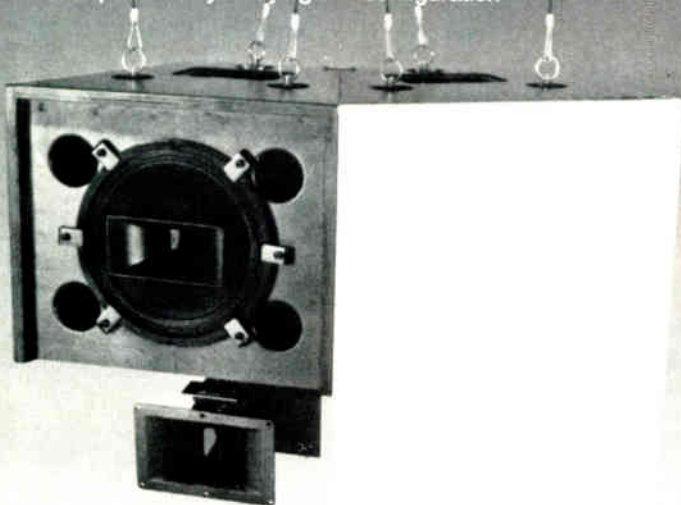
**C-1**

OAP Audio, Inc.
310 Peachtree
Industrial Boulevard

Buford, GA 30518
Phone: 404/945-1028
FAX: 404/945-1843

Circle 237 on Reader Response Card



SOUNDSPHERE

Sonic Systems Inc.

737 Canal Street

Stamford, CT 06902

(203) 356-1136 FAX: (203) 324-0893

President: Peter Hamilton; Vice President

Marketing: John J. Karamon

Karp Communications, Tampa, FL 813-968-7098

Circle 237 on Reader Response Card

SOUND DEVELOPMENT INDUSTRIES

1342 S.E. 46th Lane, Cape Coral, FL 33904
(813) 549-6010
Owner: Uolevi L. Lahti; Marketing: Anita P. Zuefle; Field Service: U. Lahti, Jr.; Security: K. Lahti
AKU Lahti Industries, Whitmore Lake, MI 313-426-4292
JTL Industries, Pleasanton, CA 415-462-4230
SDI Industries, Pleasanton, CA 415-426-5537
JMS Marketing, Austin, TX 512-266-1113
PRODUCTS: foreground, full-range, music system speakers, near-field monitors, omnidirectional, outdoor

Soundhour Electronics

N. 3808 Sullivan Road
Spokane, WA 99216
(509) 924-6631 FAX: (509) 928-2832
Cambridge Marketing, Westerville, OH 614-363-9191

SoundTech

230 Lexington Drive
Buffalo Grove, IL 60089
(708) 541-3520 (800) US-SOUND FAX: (708) 541-3616
President: Rudy Schlacher; Director of Marketing: Greg Bennett; National Sales Manager: Mark Llerly; Vice Pres.: Export Sales: Bill Robinson; Inside Sales: Andy Barys; Inside Sales: John Roy
MJA Marketing, St. Charles, MO 314-447-7111

SpeakerCraft

3615 Presley Ave.
Riverside, CA 92507
(714) 787-0543
Camden Marketing, Pierre Fonds, QU 514-683-3377

Studer Revox America, Inc.

1425 Elm Hill Pike
Nashville, TN 37210
(615) 254-5651 FAX: (615) 256-7619
President: Tore Nordahl; Executive Vice President: Bill Muggler; Director, Professional Prods: David Bowman; Director of Tech. Operations: Jim Kurowski; Dir. of Tech. and Mktg. Svcs: Doug Beard
Studer Revox America, New York, NY 212-255-4462
Studer Revox America, Los Angeles, CA 818-780-4234
Studer Revox Canada Ltd., Toronto, CA 416-510-1347
Jim Burger, Philadelphia, PA 203-297-7160
PRODUCTS: multi-way/ high powered, portable, powered, studio/reference monitors, sub-woofers

TANNOY®

Tannoy - TGI North America Inc.

300 Gage Ave. Unit 1, Kitchener, ON N2M 2C8
(519) 745-1158 FAX: (519) 745-2364
Sales and Marketing Director: Bill Calma;
Customer Service/Order Desk: Rob Hofcamp;
Technical Support: Mark Kinzle; Service Manager: Ivan Frivarski; Credit Manager: Kathy Kent
ProTech Marketing, San Clemente, CA 714-361-3454
PCM Marketing, Walnut Creek, CA 415-935-0900
Pro Musica Sales, Keene, NH 603-352-4831
Audio Associates, Columbia, MD 301-604-7300
Ron Tunk Sales, Tamarac, FL 305-722-2803
JMS Marketing, Austin, TX 512-266-1113
Powerlines Marketing, Evanston, IL 708-864-1147
World Wide Electronics, Davie, FL 305-584-7024
Blackhawk Marketing, Pacific Pal., CA 213-454-8196
Greg Dzubay & Associates, Glendale, AZ 602-934-6614
Bob White & Associates, Solon, OH 216-248-1317
Burhans/Burhans, Crystal City, MO 314-937-2743
Eaton Sales, Binghamton, NY 607-723-7626

Subscribe to
Sound & Communications
Magazine

SOUND STRATEGY

Cluster Modules... A Totally New Concept

Unique Multi-angled cabinets are ideal for close coupled arrays; simplify installation; provide full size performance in a space saving, cost effective design; offer you a choice...

Choose Between The:

Sub compact CM 61 (only 9.25" X 18" X 7") 80 to 20 kHz, 111dB output SPL performance.

Compact CM 81 (only 11.5" X 21.6" X 9.75") 70 to 17 kHz, 116 dB output SPL performance

Choose Horn Orientation:

for wide angle vertical or horizontal coverage (the horns rotate 90°)

Choose The Finish:

Black Carpet, Paint, Natural (unfinished) or Weather Resistant

Choose Connector Type:

Terminal Strip or Neutrik Connector

Choose Mounting Method:

Tripod Stand, Omnimount Hardware or Custom Arrays.



rh RENKUS-HEINZ

For Full Technical Details, or Further Information - Contact:

17191 Armstrong Avenue Tel 714/ 250-0166
Irvine, California 92714 Fax 714/ 250-1035

Circle 250 on Reader Response Card

The Music People, Inc.

2074 Park St.
Hartford, CT 06106
(203) 236-7134 (800) 289-8889 FAX: (203) 233-6888
President: James R. Hennessey; Controller:
John Gutowski; Import/Export Manager: Kelly
Helntz; Purchasing Manager: Paul Thaxton
West Coast Warehouse Facility, Los Angeles, CA
PRODUCTS: compact, custom, decorative,
environment protected, foreground, full-range,
high power, monitor panels, multi-way/ high
powered, music system speakers, near-field
monitors, omnidirectional, outdoor, portable

**TOA ELECTRONICS, INC.**

601 Gateway Blvd. Suite 300
P.O. Box 2047, S San Francisco, CA 94080
(415) 588-2538 (800) 733-4750 FAX: (415) 588-3349
President: Yoshiro Ishida; Director, Audio
Products Div: Richard Krochmal; Director,
Comm. Systems Div.: Al Burns; Mgr., Marketing
Development: Jeff Pallin; Manager, Western

Division: Bill Ford; Manager Engineering
Services: Bob Sweet
Chuck McGregor- Product Const, Morris Plains,
NJ 201-829-7047
John Murray-Eng.Snd. Mktg. Dev, Springfield, OH
513-324-1993
Bob Hager-Eastern Regional Mgr, Rosewell, GA
404-552-7624
Linda Wick-Central Reg. Mgr., Kansas City, MO
816-453-5775
Robert Slaughter-Cntrl Div Mgr, Houston, TX
713-460-3678
Pete Newmark-West Regional Mgr., Mesa, AZ
602-981-0050
Walter Best, Eastern Reg. Mgr., Sussex, NJ
201-702-0068

PRODUCTS: compact components, decorative,
environment protected, foreground, full-range,
high power, monitor panels, multi-way/ high
powered, music system speakers, near-field
monitors, outdoor, portable, powered, stage
monitors, studio/reference monitors, sub-
woofers

Turbosound/ div. of AKG Acoustics

1525 Alvarado St.
San Leandro, CA 94577
(415) 351-3500 (800) 243-7885 FAX: (415) 351-0500
Dave Talbot, Pleasant Valley, NY 914-635-9000
Audio Biz, Mundellen, IL 708-949-0280
PRODUCTS: components, full-range, high power,
multi-way/ high powered, outdoor, portable,
stage monitors, sub-woofers

UREI/JBL Professional

8500 Balboa Boulevard
P.O. Box 2200
Northridge, CA 91329
(818) 893-8411 FAX: (818) 893-3639
President: Ronald Means; Vice President, Sales:
Ken Lopez; Vice President, Marketing: Mark
Gander; Market Manager: Hector Martinez;
National Sales Manager: Neil Conley
Jim Chase, San Clemente, CA 714-492-6290
Bill Hamilton, Folsom, PA 215-543-4677
Bill Schuermann, Houston, TX 713-370-5553
Tom Walter, No. Barrington, IL 312-382-4925
Cambridge Marketing, Westerville, OH 614-363-
9191
PRODUCTS: studio/reference monitors

Westlake Audio

2696 Lavery Court, # 18
Newbury Park, CA 91320
(805) 499-3686 FAX: (805) 492-8641
President: Glenn R. Phoenix; Dealer
Administrator: Kay Finster; Manufacturing
Manager: Matt Dalgler
Westlake Pro. Audio Sis Group, Los Angeles, CA
213-851-9800
Redwood Marketing, Nashville, TN 615-254-7400
Harris Audio, Miami, FL 305-944-4448
Studio Consultants, New York, NY 212-586-7376
Audio Images, Seattle, WA 206-285-9680
MJA Marketing, St. Charles, MO 314-447-7111
PRODUCTS: studio/reference monitors

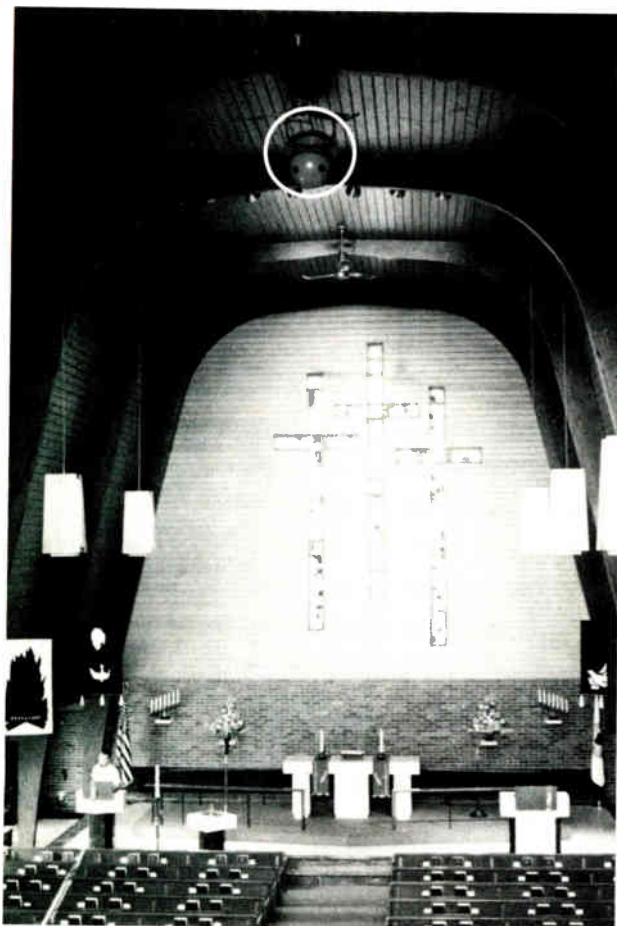

**"...excellent voice clarity and
beautiful music reproduction."**

Pastor Don F. Thomas

The Prince of Peace Lutheran Church, Ida, MI, has used a Sand colored Soundsphere #2212-1 loudspeaker for a few years. Pastor Don F. Thomas has been delighted with the improvements. He stated "there is no comparison between the former system and what we have now. The single Soundsphere loudspeaker produces excellent voice clarity and beautiful music reproduction. It also achieves very even sound distribution in my church. With it, we now do a lot more speaking by church members with wireless mikes from various areas of the church with good results. Even special programs done with children are now clearly heard in the church."

This Soundsphere installation was done by Monroe Sound in Monroe, MI. They have also installed Soundsphere loudspeakers in many other local churches, gyms, and auditoriums. A representative of Monroe Sound stated that, "Soundsphere speakers are a quick and easy installation. My employees can finish more jobs in a shorter time period resulting in improved cost efficiency for the church and for the company."

Write or call direct for further information.

SOUNDSPHERE A PRODUCT OF
SONIC SYSTEMS, INC.

737 Canal Street • Bldg 23B • Stamford, CT 06902 • USA • Tel (203) 356-1136

Circle 255 on Reader Response Card

Wharfedale Loudspeakers Ltd.

Sandleas Way, Crossgates
Leeds, Yorkshire
LS15 8AL
(532) 601-222 FAX: (532) 600-267
Audio Etc., St. Peters, MO 314-278-4130
PRODUCTS: environment protected, music system speakers, powered, sub-woofers

Wohler Technologies

1349 Kansas Street
San Francisco, CA 94107
(415) 285-5462 FAX: (415) 821-6414
Larry Schirmer, Pontiac, MI 313-340-9588
PRODUCTS: compact, monitor panels, powered

Workman Electronic Products

75 Packinghouse Rd.
Sarasota, FL 33578
(813) 371-4242

YAMAHA CORP. OF AMERICA

6600 Orangethorpe Ave.
Buena Park, CA 90620
(714) 522-9011 FAX: (714) 739-2680
Sales & Marketing Manager: Gerald W. Tschetter;
Pro Digital Sls & Mktg Mgr.: Peter Chalkin;
Market Support Manager: Don Bowles
Precide, Morbio Inferiore, Switzerland, 914-31734
PRODUCTS: compact, foreground, full-range, high power, multi-way/ high powered, music system speakers, near-field monitors, powered, processor-controlled, stage monitors, studio/reference monitors, sub-woofers



A.E.S.

22 Parsons Dr.
Swamscott, MA 01907
(617) 592-4966 FAX: (617) 581-2164
President: Jeff Myers
Eirep, Atlanta, GA 404-938-7108
P.D. Lazarus, Marblehead, MA 617-639-0387
Joncas Sales Co., Seattle, WA 206-363-9200
LMS Marketing, Columbus, OH 614-575-2000
On-Mark Sales, Denver, CO 303-371-3550
Doug Warren, Newport News, VA 804-930-3217

Accusonics Systems

2101 Jericho Turnpike
P.O. Box 5416, New Hyde Park, NY 11040
(516) 328-3300 FAX: (516) 326-8827
General Manager: Michael D'Agostino
J.B. Parent, Dublin, OH 614-764-0064
PRODUCTS: custom, environment protected, flush mount, outdoor

Alphone Corp.

1700 130th Ave. NE
Bellevue, WA 98005
(206) 455-0510 FAX: (206) 455-0071
President: Jun Matsumoto; Vice President, Marketing: Harry Quanz; Vice President, Sales: Jim Morrison; Residential Sales Manager: Stephen Birgh; Commercial Sales Manager: John Mosebar
Alphone East Coast Reg. Office, Rochelle Park, NJ 201-843-6115
Precide, Morbio Inferiore, Switzerland, 914-31734
PRODUCTS: decorative, flush mount, foreground, full range, music system speakers

ATLAS/SOUNDOLIER

1859 Intertech Dr.
Fenton, MO 63026
(314) 349-3110 (800) 876-7337 FAX: (314) 349-1251
VP/Marketing & Sales: Charles Gushwa;
VP/Marketing Consultant: Herbert M. Jaffe;
National Sales Manager: Bud Waters; Eastern Sales Manager: Tony Satariano; Western Sales Manager: Jeff Garstick; OEM Sales Manager: Larry Damato
Precide, Morbio Inferiore, Switzerland, 914-31734
PRODUCTS: components, custom, decorative, environment protected, flush mount, foreground, full range, high power, music system speakers, omni-directional, outdoor

else
LOOK WHAT QUAM HAS FOR YOU

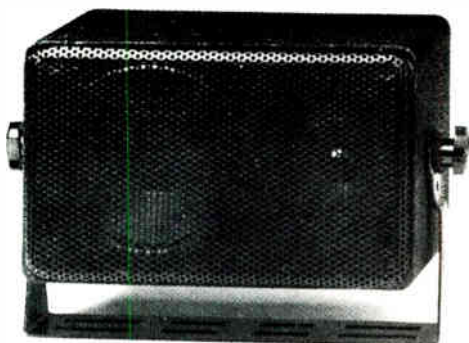

SURFACE MOUNTED FOREGROUND MUSIC LOUDSPEAKER SYSTEM
Part No. FM4x2/70

- Two-way speaker system with integral transformer
- Available in black or white
- 4" air suspension woofer
- 2" tweeter
- Power handling 10 watts
- 70.7 volt line matching transformer

Ask for FREE Tech Spec TS-24A

Quam-Nichols Company

234 East Marquette Road, Chicago, Illinois 60637
Phone: 1 312 488-5800 • FAX: 312 488-6944

Circle 282 on Reader Response Card

THE HIGH QUALITY, ALL-TERRAIN, WEATHER-RESISTANT, OUTDOOR SPEAKER SYSTEM.

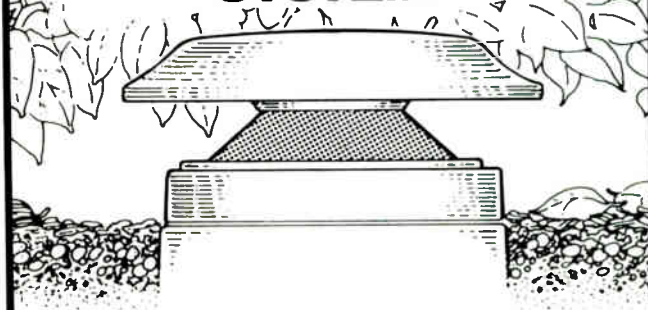

SoundScape®

P.O. Box 1563
Windermere, Florida, 34786

407-876-6884



Circle 280 on Reader Response Card

L.A. RockerTM Speaker System

LOUDSPEAKERS - WALL & CEILING

Audio Electronics Systems

6400 Youngerman Circle, Jacksonville, FL 32244
(904) 777-0700 FAX: (904) 771-7793
President: William Hecht; Executive Vice
President: Kenneth Hecht
J & J Myers Co., Swampscott, MA 617-592-4966
Doug Warren, Newport News, VA 804-930-3217
PRODUCTS: custom, decorative, environment
protected, flush mount, foreground, full range,
music system speakers

B.E.S.T.

3202 S. Shannon Street, Santa Ana, CA 92704
(714) 556-2378 (800) 592-4644 FAX: (714) 556-5425
Director of Marketing: Gary Rilling; Marketing
Coordinator: Nina Bablarz; National Sales
Manager: Bob Allen; Western Regional Manager:
Susan Schnelder
Cambridge Marketing, Westerville, OH 614-
363-9191

Bogen Communications, Inc.

50 Spring Street
P.O. Box 575
Ramsey, NJ 07446
(201) 934-8500 FAX: (201) 934-9832
President: John H. Ochtera; Vice President, Sales
& Mktg: David A. Chambers
Scott Whipple, Columbus, OH 614-272-1689
Sam Blasl, Ramsey, NJ 201-934-8500
Walter Spencer, Ramsey, NJ 201-934-8500
Fred Yosenick, Woodland, CA 916-668-6311
Edwards Company, Inc., Livonia, MI 313-458-7777
PRODUCTS: components, environment
protected, flush mount, foreground, full range,
music system speakers, omni-directional,
outdoor

BOSE CORP.

The Mountain
Framingham, MA 01701-9168
(508) 879-7330 FAX: (508) 872-6640
National Sales Manager: Timothy Dorwart;
Eastern Reg. Sales Manager: Bruce Hurst;
Western Reg. Sales Manager: Tim Landwehr; Sr.
Applications/Des. Spec.: Bruce Myers; Sr. Sales
Representative: Reed Strutzenberg; Sales
Representative: Phil Nelson
HC Garrison Co., Tualatin, OR 503-638-4906
Westech Marketing, Culver City, CA 213-870-9286
Silver Peak Marketing, Wheat Ridge, CO
303-467-9042
Rancillo Assoc., St. Louis, MO 314-845-0202
CR Marketing, Clarkston, MI 313-625-2420
J.B. Parent, Dublin, OH 614-764-0064
Secom Systems, Atlanta, GA 404-455-0672
Bencsik Assoc., Ocala, FL 904-732-9775
Sigmat Corp., Valley Forge, PA 215-783-6666
Joseph P. Mazzeo Assoc., Inc., Rochester, NY
716-458-7851
Peter E. Schmitt Co., Inc., Leonia, NJ 201-944-2806
PRODUCTS: environment protected, flush
mount, foreground, full range, music system
speakers, omni-directional, outdoor

Cerwin-Vega

555 E. Easy St.
Simi Valley, CA 93065
(805) 584-9332 FAX: (805) 583-0865
V.P. Pro Sales and Marketing: Rich Mandella;
Tech/ Sales & Marketing: John Davies; Inside
Sales: Gayle De Matoff
Southwest Marketing, TX, AZ, NM, OK, CO 818-
848-7512
MJA Sales, NY, NJ 201-467-9898
Image Marketing, CA, NV 714-957-0630
Crescendo, FL 305-922-9553
Audio Biz, IL 708-949-0280

CLARITY

1111 Industry Avenue, S.E.
Roanoke, VA 24013
(703) 982-7003 (800) 962-6009 FAX: (703) 982-7032
President: John W. Mason; Sales Coordinator:
Linda T. Bishop; Product Manager: John D.
Spencer
Featherstone Sales, Los Gatos, CA 408-356-3243
Unirep Inc., Valrico, FL 813-681-3477
M.I.N.K. Associates, Overland Park, KS 913-341-
2112
Gerald Horne Associates, Stow, MA 508-897-1741
Forti Associates, Kensington, MD 301-949-1706
Holland Marketing, Bloomington, MN
612-881-8425
Adams & Associates, Greensboro, NC
919-272-6838
Reptronics Inc., New Madison, OH 800-888-0530
Dick Belew Sales, Dallas, TX 214-644-7881
PRODUCTS: flush mount

Creative Acoustics, Inc.

197-09 Jamaica Ave.
P.O. Box 300
Hollis, NY 11423
(718) 464-6444 FAX: (718) 217-0076
President: Michael P. Farella
Advanced Audio/Video, Tampa, FL 813-879-0958
Doug Warren, Newport News, VA 804-930-3217
PRODUCTS: custom, decorative, environment
protected, flush mount, full range

Dukane Corp.

2900 Dukane Drive
St. Charles, IL 60174
(708) 584-2300 FAX: (708) 584-2370
President/C.E.O.: J. McWilliams Stone Jr.;
Pres./Comm. Systems Division: Steven L. Deppe;
National Sales Director: Warren T. Anderson;
Service Manager: Cliff Carlson
Wally Smutts, Toronto, ON 519-748-5352
Doug Fellabaum, Sycamore, IL 815-895-7573
Ken Lind, Boston, MA 617-235-6817
Pete Kendall, Jacksonville, FL 904-262-6025
Jim Lacey, Moreno Valley, CA 714-243-1160
Jack Brown, Dallas, TX 214-943-7528
Sanford Lange, Indianapolis, IN 317-251-3112
PRODUCTS: components, environment
protected, flush mount, full range, high power,
music system speakers, outdoor

Dynaco

125 Cabot Ct.
Hauppauge, NY 11788
(516) 434-1200 FAX: (516) 434-1457
President: Charles Sassoon; Vice President: Bob
Rapoport
TMC Sales, New York, NY 201-944-8340
Jack Carter Assoc., No. Hollywood, CA 818-980-
3450
Edwards Company, Inc., Livonia, MI 313-458-7777

Eden Electronics, Inc.

310 1st St.
P.O. Box 338
Montrose, MN 55363
(612) 675-3650 FAX: (612) 675-3651
President: David Nordschow
Jim Burger, Philadelphia, PA 203-297-7160
PRODUCTS: full range, high power, music system
speakers, omni-directional

Elkay Industries

2925 North Market St., St. Louis, MO 63106
(314) 535-1333 FAX: (314) 535-4118
CEO/ENG: Richard Hahn; President: Paul Grote;
Vice President, Sales: Martin Hahn; Engineering:
Jack Schilligo
Edwards Company, Inc., Livonia, MI 313-458-7777

Malibu
Dark Color /
Small
SMA

Palos Verdes
Light Color / Large
LPV

Ideal in gardens, hotels,
malls, courtyards, lawns,
spa or pool landscapes.

Environmentally and
structurally safe.

3-year limited warranty.

U.V.-resistant.

Lawnmower and puppy-
proof.

Detailed and realistic
"rock" speaker housings.

Comfortable carrying
weight and easy to handle.

Two models available in
two sizes.

Compatible with a variety
of OWI's quality speakers—
2-way, 3-way; low or high
impedance.

Blend into customized
landscape designs.

Malibu
Dark Color / Large
LMA

Palos Verdes
Light Color / Small
SPV

OWI Incorporated
1160 Mahalo Place
Compton, California 90220
213 . 638 . 4732
800 . 638 . 1694
FAX: 213 . 638 . 8347

Circle 268 on Reader Response Card

ENVIRONMENTAL SOUND

31220 La Baya Dr., Bld. #110
Westlake Vlg., CA 91362
(818) 706-0228 FAX: (818) 889-5605
President: Pascal Delbuck; Marketing: Ron
Glatzoffer; Plant Manager: Bill Ward
Cambridge Marketing, Westerville, OH 614-363-
9191
PRODUCTS: custom, decorative, environment
protected, flush mount, foreground, full range,
high power, music system speakers, outdoor

FOSTEX CORPORATION OF AMERICA

15431 Blackburn Ave., Norwalk, CA 90650
(213) 921-1112 (800) 7-FOSTEX FAX: (213) 802-
1964
V.P. Marketing/ General Mgr.: Robert Veri; V.P.
Sales: Mark Cohen
J.B. Parent, Dublin, OH 614-764-0064
PRODUCTS: components, full range

Gemco Electronics, Inc.

550 Airport Rd.
P.O. Box 993, Gallatin, TN 37066
(615) 452-5960 (800) 624-3626 FAX: (615) 451-0026
General Manager: Jerry A. Graves; Order Entry:
Linda McCullough; National Sales Manager:
James F. Woodard
Gemco Electronics Jim Woodward, Gilmer, TX
903-762-2367
Audio Etc., St. Peters, MO 314-278-4130
PRODUCTS: components, flush mount, full
range, music system speakers, omni-directional

International Components Corp.

105 Maxess Road
Melville, NY 11747
(516) 293-1500 (800) 645-9154 FAX: (516) 293-4983
President: Mort Crossman; Executive Vice
President: Irwin Friedman; Vice President: Fred
Crossman; Eastern Regional Sales Mgr.: Ken
Reed; Vice President: Harvey Crossman
C.B. Electronic Marketing, Arvada, CO 303-422-
0561
PRODUCTS: components, flush mount, full
range, music system speakers

J.W. DAVIS AND CO.

3030 Canton Street
Dallas, TX 75226
(214) 651-7341 (800) 527-5705 FAX: (214) 939-0328
President: Harvey Earp; Vice President, Sales:
Jack W. Tucker; Chief Engineer: Eric Simonson
Multi-Technical Reps., Brainerd, MN 218-828-9483
PRODUCTS: components, decorative,
environment protected, flush mount,
foreground, full range, high power, music
system speakers, omni-directional, outdoor

JBL Professional

8500 Balboa Boulevard
P.O. Box 2200
Northridge, CA 91329
(818) 893-8411 FAX: (818) 893-3639
President: Ronald Means; Vice President, Sales:
Ken Lopez; Vice President, Marketing: Mark
Gander; Market Manager: Hector Martinez;
National Sales Manager: Neil Conley
Jim Chase, San Clemente, CA 714-492-6290
Bill Hamilton, Folsom, PA 215-543-4677
Bill Schuermann, Houston, TX 713-370-5553
Tom Walter, No. Barrington, IL 312-382-4925
ADCOM, Toronto, ON 416-251-3355
PRODUCTS: components, decorative, flush
mount, foreground, full range, high power,
music system speakers

KARIBU SOUND INDUSTRIES INC.

3500 Parkdale Avenue
Baltimore, MD 21211
(301) 383-2167 FAX: (301) 383-7573
President: Larry Kirchner
Taub Sales Inc., Silver Spring, MD 301-622-9100
Leslie's, Chicago, IL 708-697-6677
Kodo Associates Inc., Minneapolis, MN 612-881-
1255
Vector Corp., Seattle, WA 206-368-1255
Multi-Technical Reps., Brainerd, MN 218-828-9483
PRODUCTS: components, custom, decorative,
flush mount, foreground, full range, high power,
music system speakers

LA East, Inc.

127 Union Street
Hatfield, PA 19440
(215) 362-2890 (800) 366-4223 FAX: (215) 368-7272
President: Eileen Schembrl; V.P. Sales and
Marketing: Stephen M. Devlin; V.P.
Operations/Engineering: Emery Kertesz III;
Service Technician: Joseph Mikios; Accounting:
Melissa Kelly; Secretary: Dawn Tyclak
Bob Bauman, Ridgewood, NJ 201-445-1055
Richard Pass, Huntington Val., PA 215-757-6100
Wayne Hrabak, Westmont, IL 708-655-1180
Jerry Heaton, Oceanside, CA 619-967-0502
Bill Bencsik, Margate, FL 904-732-9775
Precide, Morbio Inferiore, Switzerland, 914-
31734
PRODUCTS: custom

**FOUL WEATHER GEAR.**

Perfectly suited to their environment, TOA's lineup of weather-resistant speakers takes the worry out of damp, humid and temperature-extreme installations. With ABS or polypropylene shells, zinc-coated brackets and stainless hardware, their sturdy constitution doesn't sacrifice sonic performance — woofers, CD horns and high efficiency drivers deliver uniform dispersion patterns and smooth frequency response. There are five models with 20-120 WRMS input power so that you can take on the elements like a duck takes to water.

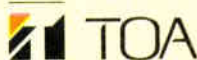

TOA ELECTRONICS, INC., 601 GATEWAY BLVD.,
SOUTH SAN FRANCISCO, CA 94080
415/588-2538 • 800/733-7088



Circle 229 on Reader Response Card

MG Electronics

32 Ranlick Road
Hauppauge, NY 11788
(516) 582-3400 FAX: (516) 582-3229
President: Elliott Maltz; National Sales Manager:
Stan Grey; Asst. Sis. Mgr., Comm. Sound: Herb
Woll; CEM Sales Manager: John Kibbitt; Credit
Manager: Rita McIberger; Customer Service:
Sue Novak
Loomis and Associates, Fremont, CA
415-683-0883
PRODUCTS: components, custom, decorative,
environment protected, flush mount,
foreground, full range, high power, music
system speakers, outdoor

MISCO/Minneapolis Speaker Co., Inc.

3806 Grand Avenue
Minneapolis, MN 55409
(612) 825-1010 FAX: (612) 825-7010
President: Dan Digre; Sales Manager: Don
Ringham; Vice President: Cliff Digre;
Production Manager: Tad Thompson
Audio Marketing Assoc., Brecksville, OH
216-526-2426
Austin Associates, Willingsboro, NJ 609-871-9290
Miller Associates, Stamford, CT 203-329-9174
Pacnor Marketing, Lynnwood, WA 206-771-6016
Audio Etc., St. Peters, MO 314-278-4130
PRODUCTS: components, custom, decorative,
environment protected, flush mount,
foreground, full range, high power, music
system speakers, omni-directional, outdoor

MTX Oaktron

704 30th Street
Monroe, WI 53566
(608) 328-5560 FAX: (608) 328-5575
President: Loyd Ivey; Exec. Vice Pres./Gen. Mgr.:
Rod Boyer; Sales Manager: Jerry Disch
Loomis and Associates, Fremont, CA
415-683-0883

NEAR - New England Audio Resource

679 Lisbon Road
Lisbon Falls, ME 04252
(207) 353-7307 FAX: (207) 353-7309
President: William J. Kleityka; Vice President
Manufacturing: Robert Adams; V.P. Research &
Development: Lewis Athanas; Director of Mktg &
Sales: Lee Lareau
Larry Schlrmer, Pontiac, MI 313-340-9588
PRODUCTS: components, custom, environment
protected, flush mount, full range, music system
speakers, outdoor

OWI INC.

1160 Mahalo Place, Compton, CA 90220
(213) 638-4732 (800) 638-1694 FAX: (213) 638-8347
President: Ned Morloka; Vice President: Hiro
Okayama; Director of Sales: Kristin Jo Morloka;
Credit Manager: June Morloka
Loomis and Associates, Fremont, CA
415-683-0883
PRODUCTS: custom, decorative, flush mount,
foreground, full range, music system speakers,
omni-directional, outdoor

Paramount Picts. Home Theater Prods

1950 E. Orangethorpe
Fullerton, CA 92631
(714) 526-0711 FAX: (714) 526-0715
General Manager: Rick Strickland; Accounts
Sales Manager: Al Hernandez
California Sales & Marketing, San Juan Capis., CA
714-489-8559
J. R. Morgan, Phoenix, AZ 602-268-3464
Meyer Marketing, Deerfield Beach, FL 305-481-
9250
Jamm Distributing, Flossmoor, IL 708-799-0550
Henry Phillips, Roswell, GA 404-992-3070
Audio Etc., St. Peters, MO 314-278-4130
PRODUCTS: decorative, flush mount, full range,
music system speakers, outdoor

PARTS EXPRESS INT'L INC.

340 E. First St.
Dayton, OH 45402
(513) 222-0173 (800) 338-0531 FAX: (513) 222-4644
President: Jeffrey Stahl; Sales Manager: Linda
O'Brien; Purchasing Manager: Greg Herting;
Advertising Manager: Larry Potter
Chuck Olson Assoc., Renton, WA 206-271-5416
PRODUCTS: components, custom, flush mount,
full range, music system speakers, outdoor

**Order the 1992
Music & Sound Buyer's
Guide now!**

SOUNDSPHERE LOUDSPEAKER HITS HOME RUN IN CINCINNATI ...

If you didn't register for The NSCA Trade Show at the Hyatt Regency Cincinnati, you missed hearing a single Soundsphere #168 loudspeaker providing background music to four levels of the large atrium. This includes the lounge bar where music in the evening, emitting from the speaker, provides piano-bar type ambience.

Richard Carlson, the Hyatt general manager stated, "The Soundsphere speaker in the four-story atrium lobby of the Hyatt Regency Cincinnati has really enhanced the hotel's atmosphere. The system is clean and crisp in quality, and is a pleasant addition to our Sun-garden Lounge, our restaurant Findlay's and all the public areas into which it reaches."

The baseball theme of banners and the large Cincinnati Reds cap is continued in the permanent "Home run," a floating White #168 Soundsphere loudspeaker. Allen Volz of Industrial Communications and Sound, the contractor, mentioned that "it was a very easy and simple installation."

Many other hotel, mall and office building atriums have Soundsphere loudspeakers to solve the problem of even distribution of voice page and background music in these highly reverberant environments. In many instances they are color coordinated to the design scheme of the location.

There are 5 different models of Soundsphere loudspeakers to help you solve problems in difficult environments. Call us to assist with your next challenging situation.



SOUNDSPHERE A PRODUCT OF
SONIC SYSTEMS, INC.
737 Canal Street • Bldg 23B • Stamford, CT 06902 • USA • Tel (203) 356-1136

SLIM STYLE, SUPERB SOUND.

Model SH2020 is a two-way system featuring a 20cm woofer and a new high fidelity dome tweeter with wide dispersion characteristics. Model SH2510 is a super low reproducing woofer system with a new double voice coil design--space saving without any sonic compromise.

The combination is a stunning example of modern transducer technology from Fostex--one of the world's leading manufacturers of primary speaker components and systems.

The wide dispersion dome tweeter in the SH2020 gives you much more flexibility of placement than that offered by conventional wall-mount or ceiling-mount units. When used in tandem with Model SH2510 Sub-woofer, true fidelity is reproduced across the entire sonic spectrum.

In fact, the music reproduction is so good, these Fostex systems, unlike typical wall-mounts, can be installed in homes as the primary music system--so they're ideal for surround sound entertainment centers.

Fostex In-Wall speaker systems are also perfect for offices, restaurants, hotel lobbies and other commercial applications for background music sources. Their outstanding clarity makes them ideal as public address speakers for halls and meeting rooms. Their thin profile, designed for recessed mounting in walls and ceilings, plus a unique "cam action" mounting method requiring no external screws, make them the easiest to install in standard 2 x 4 stud construction.

Space is already provided for in-line transformers when multiple SH2020 units are used in larger systems. When two SH2020s are wired to the SH2510 you have a full response stereo system which rivals that of many high end (and often visually unappealing) speaker systems. You can take advantage of the human ear's low directional sensitivity to bass response and position the SH2510 with a great degree of freedom--it does not need to be contiguous to the SH2020s.

Call or write for more information on these remarkable speaker systems--you'll want to specify them for your very next job. We'll include data on our Model US 300--an omnidirectional underwater speaker system. It can be used for temporary or permanent sound reinforcement. It's safe, won't corrode, and most important of all, it sounds great.

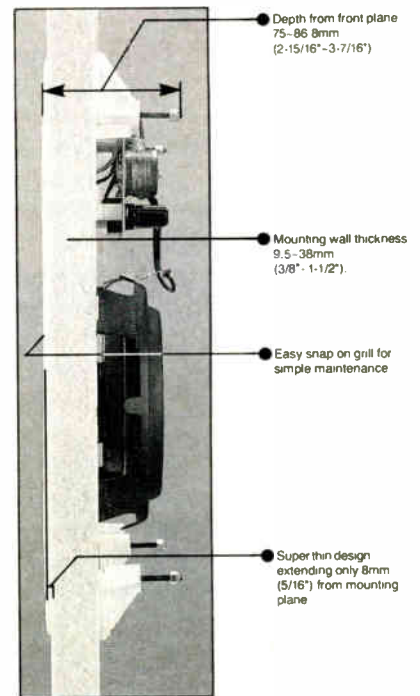

Photo: SH2020

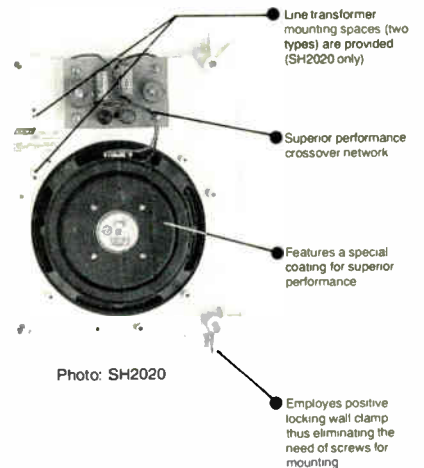
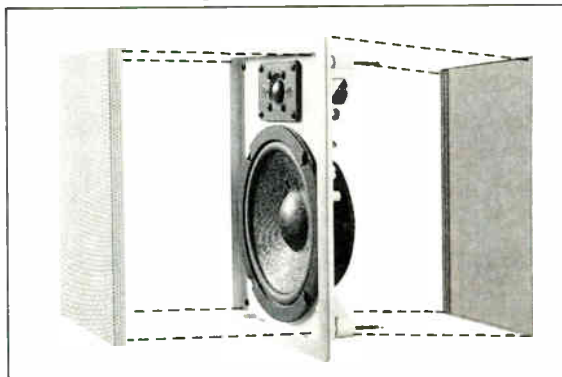
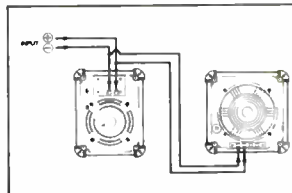

Photo: SH2020

Method of mounting



Model SH2020 and SH2510



Model SH2020 x 2 and SH2510

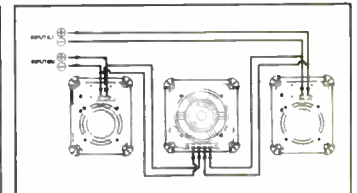

Fostex®

FOSTEX CORPORATION OF AMERICA 15431 BLACKBURN AVE., NORWALK, CA 90650 TEL: 213-921-1112 FAX: 213-802-1964

Circle 202 on Reader Response Card
World Radio History

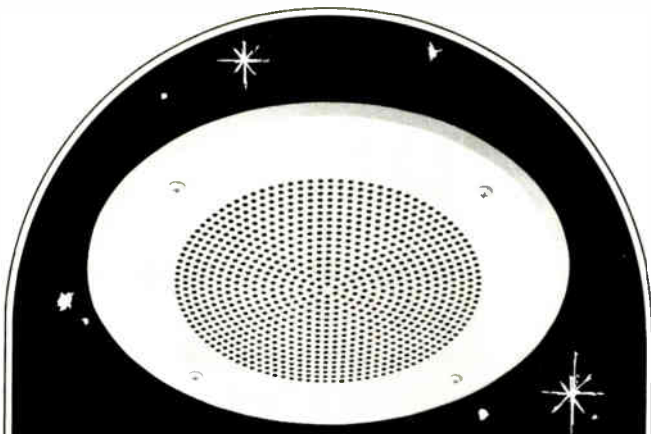

Have you seen the "STEALTH" Baffle?

Probably not! The new "Stealth" baffle from Fourjay is so inconspicuous you may never notice it. The 11" round, flush mount baffle has 25% less surface area than competitive units and the "Stealth's" low profile and specially textured, non-glare coating blend perfectly with ceiling materials.

The "Stealth's" design and construction meet U.L. 1480 ceiling baffle requirements. You can choose either phillips head speaker mounting screws or pre-set studs with push-on nuts which slash installation time. Also available with factory assembled speakers and transformers, the "Stealth" baffle is fully compatible with all Fourjay 8" mounting systems including the Plenum Connection.

So if you would like to see the baffle that escapes observation, just give us a call. We'll be glad to show you what you've been missing.

Since 1956 customer satisfaction has been our first priority. All Fourjay products are in stock for immediate shipment. If you're not getting price, quality and fast service, you're not using Fourjay.

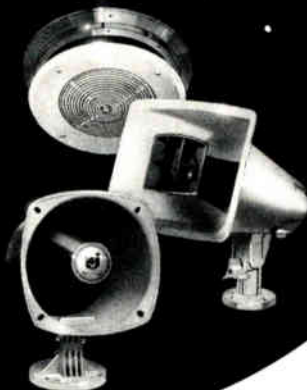

FOURJAY
INDUSTRIES, INC.

3400 STOP EIGHT ROAD • P.O. BOX 14617
DAYTON, OH 45413-0617
TELEPHONE (513) 890-6444 • FAX (513) 890-1692

Paso Sound Products, Inc.

14 First Street, Pelham, NY 10803
(914) 738-4800 (800) 231-3034 FAX: (914) 738-3954
Executive Vice President: Paul Mastrangelo;
Product Manager: Ken O'Brien; Credit Manager:
Marilyn Beckerson; Operations Manager:
Anthony Squegila
Anderson Sales, Braintree, MA 617-848-9194
Jack Mesnick Sales, Liverpool, NY 315-622-3211
Palmleri Associates, Fairfield, NJ 201-882-1266
Weller Electronic Sales, Inc., Worthington, OH
614-885-7819
Lienau Associates, Columbia, MD 301-621-4113
MJA Marketing, St. Charles, MO 314-447-7111
Northland Assoc., Moorehead, MN 218-233-4616
Allwest Sound & Communication, Camarillo, CA
805-388-7745
Dimension Pt. IX Marketing, Katy, TX 713-578-9277
Mountain Representatives, Denver, CO
303-333-7745
Miguel Lopez, Hialeah, FL 305-822-6853
Paco Electronics, Ltd., Markham, ON 416-475-0740
Robert Mlisk Co., Southfield, MI 313-354-3310
Marketline Inc., Snellville, GA 404-972-9048
Hawkins-Frederickson Assoc., Maitland, FL 407-
831-2474
Lintern Associates, Naperville, IL 708-904-1225
Robert Mlisk Co., Indianapolis, IN 317-842-3400
PRODUCTS: components, custom, decorative,
environment protected, flush mount,
foreground, full range, music system speakers

PEAVEY ELECTRONICS CORP.

711 A Street
P.O. Box 2898, Meridian, MS 39301
(601) 483-5365 FAX: (601) 484-4278
CEO: Hartley Peavey; President: Mella Peavey
Dimension/ Point IX, Lewisville, TX 214-436-3706
PRODUCTS: components, custom, flush mount,
full range, high power, omni-directional,
outdoor, processor-controlled

Quam Nichols Co.

234 E. Marquette Rd., Chicago, IL 60637
(312) 488-5800 FAX: (312) 488-6944
President: William G. Little; Vice President
Operations: Don E. Boyer; Sales Manager: Greg
L. Johns; Technical Director: Larry Salzwedel;
Customer Service: Randy S. Moore; Distributor
Sales: Vivian Merrills
Cartwright & Bean, Inc, Norcross, GA 404-368-0160
Hudson Marketing, Inc., Roslyn Heights, NY
516-625-0002
R.W. Kunz & Associates, Inc., Prairie Village, KS
913-648-3535
Browell-Schwartz Assoc., Gardena, CA 213-770-0300
Vector Manufacturers' Rep., Seattle, WA
206-368-8400
Dimension/ Point IX, Lewisville, TX 214-436-3706
PRODUCTS: decorative, flush mount,
foreground, music system speakers, outdoor

Radian Audio Engineering

4520 Eisenhower Circle, Anaheim, CA 92807
(714) 693-9277 FAX: (714) 692-9278
President: Richard Kontrimas; Director of Sales
& Mktg.: Jeff Phillips; Order Desk: Mary Wells;
Engineering Manager: Robert Ash; Controller:
Judy Truett; Traffic: Carmen Rivera
Seabridge Audio Marketing, Huntington Bch., CA
714-374-0202
Pappas Consulting, Menlo Park, CA 415-324-4325
Creative Audio Marketing, Atlanta, GA
404-642-7827
Lowery Assoc., Broomall, PA 215-356-5300
Professional Sound & Light, Lakewood, CO
303-986-5999
Cambridge Marketing, Westerville, OH 614-363-9191
Neal Hunter & Assoc., Syracuse, OH 315-437-2992
SRT Marketing, Tampa, FL 813-884-4805
Don Ludwig Assoc., Lindenhurst, IL 708-265-0090
PRODUCTS: foreground, full range, high power,
music system speakers

REVERE INDUSTRIES

1101 Bienville St.
New Orleans, LA 70112
(504) 523-3503 (800) 843-8321 FAX: (504) 525-6361
Vice President Mktg./Sales: Richard Harris
Camden Marketing, Pierre Fonds, QU 514-683-3377
PRODUCTS: components, custom, decorative, environment protected, flush mount, foreground, full range, high power, music system speakers, omni-directional, outdoor, processor-controlled

RING COMMUNICATIONS INC.

57 Trade Zone Drive
Ronkonkoma, NY 11779
(516) 585-7464 FAX: (516) 585-7410
President: Peter McLean; Vice President: Craig Krsanac; Vice President: Kjell (Ken) Solem
Monfort Electronic Marketing, Indianapolis, IN 317-872-8877
EESCO Systems, Inc., Los Angeles, CA 213-666-9601
Klumpp Sales Company, Jacksonville, FL 904-287-5205
The TK Group, Inc., Loveland, CO 303-669-1008
Avwest, Inc., Fountain Hills, AZ 602-946-1811
Gustafson Sales Company, Red Wing, MN 612-388-4277
Corrigan Agency, Covington, LA 504-893-7455
Pacnor Marketing, Lynnwood, WA 206-771-6016
Kaitec Communications, N. Vancouver, BC 604-987-1597

SONANCE

961 Calle Negocio
San Clemente, CA 92672
(714) 492-7777 (800) 582-7777 FAX: (714) 361-2705
President: Scott Struthers; Vice President: Geoff Spencer; Sales Manager: Dave Donald; International Sales Manager: Mark Cichowski; Public Relations Director: Mitch Simon; Dir. Sis Trn. & Mkt. Research: Kevin Leja
Morris Tait and Assoc., Los Angeles, CA 213-877-4424
Bach Sales, New York, NY 212-727-0404
Tandem Marketing, Chicago, IL 708-605-1960
Dobbs Stanford, Dallas, TX 214-358-0800
Balaton Marketing, Washington DC, 202-471-1764
MJA Marketing, St. Charles, MO 314-447-7111
PRODUCTS: decorative, environment protected, flush mount, full range, high power, outdoor

SOUND DEVELOPMENT INDUSTRIES

1342 S.E. 46th Lane, Cape Coral, FL 33904
(813) 549-6010
Owner: Uolevi L. Lahti; Marketing: Anita P. Zuefle; Field Service: U. Lahti, Jr.; Security: K. Lahti
AKU Lahti Industries, Whitmore Lake, MI 313-426-4292
JTL Industries, Pleasanton, CA 415-462-4230
SDI Industries, Pleasanton, CA 415-426-5537
JMS Marketing, Austin, TX 512-266-1113
PRODUCTS: foreground, full range, music system speakers, omni-directional

T-S-K ELECTRONICS, INC.

564 Young St.
Tonawanda, NY 14150
(716) 693-3916 FAX: (716) 692-6433
President: Kevin Kedzierski; Marketing Manager: Alan Gembola
JMS Marketing, Austin, TX 512-266-1113
PRODUCTS: custom, decorative, environment protected, flush mount, outdoor

**Subscribe to
Sound &
Communications
Magazine**

**The KSI 8081-CS
Ceiling Speaker**

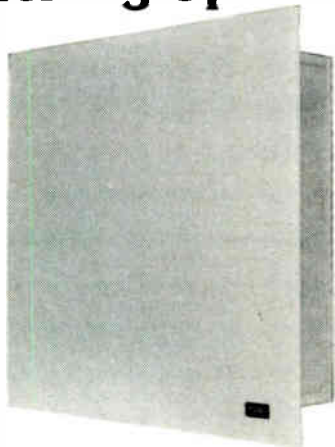

The 8081-CS is a cost-effective, high-fidelity ceiling speaker system which mounts in a standard 2X2 grid. An 8" bass-midrange, 3/4" mylar dome tweeter, and a 10" passive radiator yields unsurpassed performance. Comes complete with white or black grill, back box, mounting rings and FR construction. Saves labor, time and money for fast and easy installation.

For more information, call:



KARIBU SOUND INDUSTRIES, INC.
3500 Parkdale Avenue
Baltimore, MD 21211
301-383-2167 Fax 383-7573

Circle 265 on Reader Response Card

**MG IN WALL
ARCHITECTURAL
LOUDSPEAKERS**

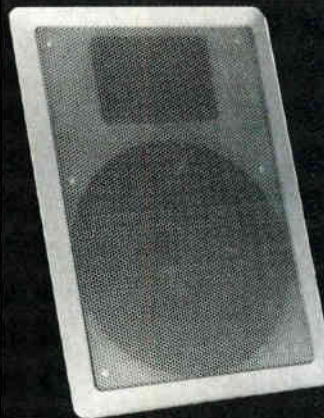

**They're
Out of Sight . . .
Their Price
Isn't !!!**

**Get the
Competitive Edge,
Call, Write or Fax**



SOUND PRODUCTS DIVISION
32 RANICK ROAD, HAUPPAUGE, N.Y. 11788
TEL: 516-582-3400 FAX: 516-582-3229

30 YEARS OF SOUND PRODUCTS

Circle 40 on Reader Response Card



TOA ELECTRONICS, INC.

601 Gateway Blvd. Suite 300
P.O. Box 2047, S San Francisco, CA 94080
(415) 588-2538 (800) 733-4750 FAX: (415) 588-3349
President: Yoshiro Ishida; Director, Audio Products Div: Richard Krochmal; Director, Comm. Systems Div.: Al Burns; Mgr., Marketing Development: Jeff Pallin; Manager, Western Division: Bill Ford; Manager Engineering Services: Bob Sweet
Chuck McGregor- Product Consit, Morris Plains, NJ 201-829-7047
John Murray-Eng.Snd. Mktg. Dev, Springfield, OH 513-324-1993
Bob Hager-Eastern Regional Mgr, Rosewell, CA 404-552-7624
Linda Wick-Central Reg. Mgr., Kansas City, MO 816-453-5775
Robert Slaughter-Cntrl Div Mgr, Houston, TX 713-460-3678
Pete Newmark-West Regional Mgr., Mesa, AZ 602-981-0050
Walter Best, Eastern Reg. Mgr., Sussex, NJ 201-702-0068
PRODUCTS: environment protected, foreground, full range, high power, music system speakers, outdoor, processor-controlled

Triad Speakers, LPC, Inc.

9106 NE Marx Dr.
Portland, OR 97220
(503) 256-2600 FAX: (503) 256-5966

UNIVERSITY SOUND INC.

13278 Rolston Avenue, Sylmar, CA 91342
(818) 362-9516 FAX: (818) 367-5292
President: Robert Sandell; Controller: Mary Coco; National Sales Manager: Greg McLagan; Design Engineer: Ken Koceski
Jim Burger, Philadelphia, PA 203-297-7160
PRODUCTS: components, flush mount, foreground, full range

Video Link

12950 Bradley Avenue, Sylmar, CA 91342
(818) 362-0353 (800) 843-5465 FAX: (818) 362-9506
President: Herb Seymour; V.P. Sales and Marketing: Bill Cawfield; Sales Manager: Larry W. Schatz; Asst. Sales Manager: Marguerita Kiser
J.B. Parent, Dublin, OH 614-764-0064
PRODUCTS: flush mount

WHEELOCK, INC.

273 Branchport Avenue, Long Branch, NJ 07740
(908) 222-6880 (800) 631-2148 FAX: (908) 222-8707
President: Peter W. Tarlton; V.P. Finance and Admin.: Joseph P. Henry; Vice President Operations: Douglas E. Phillips; Vice President Sales/Mktg.: William L. Goldstein;
Telephone/Paging Mktg. Mgr.: Arthur Arlow;
Life Safety Mktg. Mgr.: Rein Haus
Joseph P. McCaffrey, Glen Ellyn, IL 708-790-2898
Edward P. Draney, Peachtree City, GA 404-631-3193
Peter Koehler, Los Angeles, CA 213-572-1347
Steve Goldberg, East Windsor, NJ 609-448-1457
Dave Jackowlak, Burbank, IL 708-599-4099
MJA Marketing, St. Charles, MO 314-447-7111
PRODUCTS: flush mount, outdoor



Accusonics Systems

2101 Jericho Turnpike
P.O. Box 5416
New Hyde Park, NY 11040
(516) 328-3300 FAX: (516) 326-8827
General Manager: Michael D'Agostino
J.B. Parent, Dublin, OH 614-764-0064
PRODUCTS: components, environment protected, flush mount, outdoor

Alphone Corp.

1700 130th Ave. NE
Bellevue, WA 98005
(206) 455-0510 FAX: (206) 455-0071
President: Jun Matsumoto; Vice President, Marketing: Harry Quanz; Vice President, Sales: Jim Morrison; Residential Sales Manager: Stephen Birgh; Commercial Sales Manager: John Mosebar
Alphone East Coast Reg. Office, Rochelle Park, NJ 201-843-6115
Preclde, Morbio Inferiore, Switzerland, 914-31734
PRODUCTS: horns, outdoor, talkback

ATLAS/SOUNDOLIER

1859 Intertech Dr.
Fenton, MO 63026
(314) 349-3110 (800) 876-7337 FAX: (314) 349-1251
VP/Marketing & Sales: Charles Gushwa;
VP/Marketing Consultant: Herbert M. Jaffe;
National Sales Manager: Bud Waters; Eastern Sales Manager: Tony Satarlano; Western Sales Manager: Jeff Garstick; OEM Sales Manager: Larry Damato
Preclde, Morbio Inferiore, Switzerland, 914-31734
PRODUCTS: columns, components, custom, decorative, environment protected, explosion proof, flush mount, foreground, full range, high frequency drivers, high power, horns, outdoor, powered, siren/ voice warning, talkback

Bogen Communications, Inc.

50 Spring Street
P.O. Box 575
Ramsey, NJ 07446
(201) 934-8500 FAX: (201) 934-9832
President: John H. Ochtera; Vice President, Sales & Mktg.: David A. Chambers
Scott Whipple, Columbus, OH 614-272-1689
Sam Biasi, Ramsey, NJ 201-934-8500
Walter Spencer, Ramsey, NJ 201-934-8500
Fred Yosenick, Woodland, CA 916-668-6311
Edwards Company, inc., Livonia, MI 313-458-7777
PRODUCTS: columns, components, environment protected, flush mount, foreground, full range, horns, outdoor, talkback

BOSE CORP.

The Mountain
Framingham, MA 01701-9168
(508) 879-7330 FAX: (508) 872-6640
National Sales Manager: Timothy Dorwart;
Eastern Reg. Sales Manager: Bruce Hurst;
Western Reg. Sales Manager: Tim Landwehr; Sr. Applications/Des. Spec.: Bruce Myers; Sr. Sales Representative: Reed Strutzenberg; Sales Representative: Phil Nelson
HC Garrison Co., Tualatin, OR 503-638-4906
Westech Marketing, Culver City, CA 213-870-9286
Silver Peak Marketing, Wheat Ridge, CO 303-467-9042
Rancillo Assoc., St. Louis, MO 314-845-0202
CR Marketing, Clarkston, MI 313-625-2420
J.B. Parent, Dublin, OH 614-764-0064
Secom Systems, Atlanta, GA 404-455-0672
Bencsk Assoc., Ocala, FL 904-732-9775
Sigmat Corp., Valley Forge, PA 215-783-6666
Joseph P. Mazzeo Assoc., Inc., Rochester, NY 716-458-7851
Peter E. Schmitt Co., Inc., Leonia, NJ 201-944-2806
PRODUCTS: environment protected, flush mount, foreground, full range, outdoor, portable, powered, siren/ voice warning

CLARITY

1111 Industry Avenue, S.E.
Roanoke, VA 24013
(703) 982-7003 (800) 962-6009 FAX: (703) 982-7032
President: John W. Mason; Sales Coordinator: Linda T. Bishop; Product Manager: John D. Spencer
Featherstone Sales, Los Gatos, CA 408-356-3243
Unrep Inc., Valrico, FL 813-681-3477
M.I.N.K. Associates, Overland Park, KS 913-341-2112
Gerald Horne Associates, Stow, MA 508-897-1741
Forti Associates, Kensington, MD 301-949-1706
Holland Marketing, Bloomington, MN 612-881-8425
Adams & Associates, Greensboro, NC 919-272-6838
Reptronics Inc., New Madison, OH 800-888-0530
Dick Belew Sales, Dallas, TX 214-644-7881
PRODUCTS: flush mount, horns, outdoor, talkback

Dukane Corp.

2900 Dukane Drive
St. Charles, IL 60174
(708) 584-2300 FAX: (708) 584-2370
President/C.E.O.: J. McWilliams Stone Jr.;
Pres./Comm. Systems Division: Steven L. Deppe;
National Sales Director: Warren T. Anderson;
Service Manager: Cliff Carlson
Wally Smutts, Toronto, ON 519-748-5352
Doug Fellabaum, Sycamore, IL 815-895-7573
Ken Lind, Boston, MA 617-235-6817
Pete Kendall, Jacksonville, FL 904-262-6025
Jim Lacey, Moreno Valley, CA 714-243-1160
Jack Brown, Dallas, TX 214-943-7528
Sanford Lange, Indianapolis, IN 317-251-3112
PRODUCTS: columns, components, explosion proof, flush mount, full range

Eden Electronics, Inc.

310 1st St.
P.O. Box 338
Montrose, MN 55363
(612) 675-3650 FAX: (612) 675-3651
President: David Nordschow
Jim Burger, Philadelphia, PA 203-297-7160
PRODUCTS: foreground, horns

Elkay Industries

2925 North Market St.
St. Louis, MO 63106
(314) 535-1333 FAX: (314) 535-4118
CEO/ENG: Richard Hahn; President: Paul Grote;
Vice President, Sales: Martin Hahn; Engineering:
Jack Scilligo
Edwards Company, Inc., Livonia, MI 313-458-7777

ENVIRONMENTAL SOUND

31220 La Baya Dr., Bld. #110
Westlake Vlg., CA 91362
(818) 706-0228 FAX: (818) 889-5605
President: Pascal Delbuck; Marketing: Ron
Glatzhoffer; Plant Manager: Bill Ward
Cambridge Marketing, Westerville, OH
614-363-9191
PRODUCTS: columns, environment protected,
flush mount, foreground

Fanon Courier

14811 Myford Road
Tustin, CA 92680
(714) 669-9890 (800) 345-1354 FAX: (714) 669-1081
President: Frank Blaha; Director Sales &
Marketing: Murray Trottnier; Director of
Engineering: Miguel Santana
Greg Dzubay & Assoc., Glendale, AZ 800-999-0006

GAI-Tronics Corp.

525 Lancaster Ave.
Reading, PA 19611
(215) 372-5151 (800) 492-1212 FAX: (215) 374-1474
President: G. Edward Smith; Vice President Sales
& Mktg.: Daniel T. Peters; Controller: Jeff Jones
GAI-Tronics Corp., St. Rose, LA 504-466-1666
GAI-Tronics Corp., Indianapolis, IN 317-872-1140
GAI-Tronics Corp., Houston, TX 713-641-0095
GAI-Tronics Corp., Reading, PA 215-372-5151

Gemco Electronics, Inc.

550 Airport Rd.
P.O. Box 993
Gallatin, TN 37066
(615) 452-5960 (800) 624-3626 FAX: (615) 451-0026
General Manager: Jerry A. Graves; Order Entry:
Linda McCullough; National Sales Manager:
James F. Woodard
Gemco Electronics Jim Woodward, Gilmer, TX
903-762-2367
Audio Etc., St. Peters, MO 314-278-4130
PRODUCTS: columns, flush mount, horns,
outdoor, talkback

Harris Corp., Dracon Div.

809 Calle Plano
Camarillo, CA 93012
(805) 987-9511 (800) 437-2266 FAX: (805) 987-2547
Vice Pres. General Manager: John R. Mason; Vice
Pres. Sales/Marketing: Jack McGuigan; Controller:
Ron Burgess; Vice Pres. of Engineering: Ben
Pierce; Paging Product Manager: Tom Johnson;
Director Sales, Marketing: Tom Erdmann
Dave Forcey, Squaw Valley, CA 209-338-2124
Sam Blasl, Alexandria, VA 703-971-5095
Bill Boone, Libertyville, IL 708-816-1080
Bob Lincoln, IndianRocks Bch, FL 813-585-3055
Dave Whalen, Oxnard, CA 805-984-0197
Pete Newmark-West Regional Mgr., Mesa, AZ
602-981-0050
PRODUCTS: components, custom, decorative,
environment protected, explosion proof, flush
mount, foreground, full range, horns, outdoor,
portable, talkback

International Components Corp.

105 Maxess Road
Melville, NY 11747
(516) 293-1500 (800) 645-9154 FAX: (516) 293-4983
President: Mort Grossman; Executive Vice
President: Irwin Friedman; Vice President: Fred
Grossman; Eastern Regional Sales Mgr.: Ken
Reed; Vice President: Harvey Grossman
C.B. Electronic Marketing, Arvada, CO
303-422-0561
PRODUCTS: flush mount, full range, horns,
outdoor, portable, siren/ voice warning, talkback

J.W. DAVIS AND CO.

3030 Canton Street
Dallas, TX 75226
(214) 651-7341 (800) 527-5705 FAX: (214) 939-0328
President: Harvey Earp; Vice President, Sales:
Jack W. Tucker; Chief Engineer: Eric Simonson
Multi-Technical Reps., Brainerd, MN 218-828-9483
PRODUCTS: columns, components, decorative,
environment protected, explosion proof,
foreground, full range, horns, outdoor, portable,
talkback, underwater

JBL Professional

8500 Balboa Boulevard
P.O. Box 2200
Northridge, CA 91329
(818) 893-8411 FAX: (818) 893-3639
President: Ronald Means; Vice President, Sales:
Ken Lopez; Vice President, Marketing: Mark
Gander; Market Manager: Hector Martinez;
National Sales Manager: Neil Conley
Jim Chase, San Clemente, CA 714-492-6290
Bill Hamilton, Folsom, PA 215-543-4677
Bill Schuermann, Houston, TX 713-370-5553
Tom Walter, No. Barrington, IL 312-382-4925
ADCOM, Toronto, ON 416-251-3355
PRODUCTS: components, decorative, flush
mount, foreground, full range, high frequency
drivers, high power, horns, outdoor, portable

KARIBU SOUND INDUSTRIES INC.

3500 Parkdale Avenue
Baltimore, MD 21211
(301) 383-2167 FAX: (301) 383-7573
President: Larry Kirchner
Taub Sales Inc., Silver Spring, MD 301-622-9100
Leslie's, Chicago, IL 708-697-6677
Kodo Associates Inc., Minneapolis, MN 612-881-
1255
Vector Corp., Seattle, WA 206-368-1255
Multi-Technical Reps., Brainerd, MN 218-828-9483
PRODUCTS: columns, components, custom, flush
mount, foreground, full range, high frequency
drivers, high power, horns, portable

Lectrosonics, Inc.

P.O. Box 15900
Rio Rancho, NM 87174
(505) 892-4501 (800) 821-1121 FAX: (505) 892-6243
President: John Arasim; Vice President
Engineering: Larry Fisher; Vice President Mktg &
Sales: Bruce Jones
C.L. Pugh & Associates, Cleveland, OH 216-238-
1777
PRODUCTS: portable, powered

LEE DAN COMMUNICATIONS, INC.

155 Adams Avenue
Hauppauge, NY 11788-3699
(516) 231-1414 (800) 533-3261 FAX: (516) 231-1498
President: Leon Goldberg; Vice President
Operations: Lawrence J. Goldberg; V.P. Finance &
Administration: David H. Goldberg; Senior
Technician: Sanford Hoffman; Office Manager:
Rita Kaplan; Sr. Sales/Service Associate: Susan
Leon
C.L. Pugh & Associates, Cleveland, OH
216-238-1777
PRODUCTS: columns, components, flush mount,
full range, horns, outdoor, talkback

MG Electronics

32 Ranick Road
Hauppauge, NY 11788
(516) 582-3400 FAX: (516) 582-3229
President: Elliott Maltz; National Sales Manager:
Stan Grey; Asst. Sls. Mgr., Comm. Sound: Herb
Woll; CEM Sales Manager: John Kibbitt; Credit
Manager: Rita McIberger; Customer Service:
Sue Novak
Loomis and Associates, Fremont, CA
415-683-0883
PRODUCTS: custom, decorative, flush mount,
foreground, full range, high frequency drivers,
high power, horns, outdoor, siren/ voice
warning

MISCO/Minneapolis Speaker Co., Inc.

3806 Grand Avenue
Minneapolis, MN 55409
(612) 825-1010 FAX: (612) 825-7010
President: Dan Digre; Sales Manager: Don
Ringham; Vice President: Cliff Digre;
Production Manager: Tad Thompson
Audio Marketing Assoc., Brecksville, OH 216-526-
2426
Austin Associates, Willingsboro, NJ 609-871-9290
Miller Associates, Stamford, CT 203-329-9174
Pacnor Marketing, Lynnwood, WA 206-771-6016
Audio Etc., St. Peters, MO 314-278-4130
PRODUCTS: components, custom, environment
protected, flush mount, foreground, full range,
high frequency drivers, high power, horns,
outdoor, talkback

OWI INC.

1160 Mahalo Place
Compton, CA 90220
(213) 638-4732 (800) 638-1694 FAX: (213) 638-8347
President: Ned Morioka; Vice President: Hiro
Okayama; Director of Sales: Kristin Jo Morioka;
Credit Manager: June Morioka
Loomis and Associates, Fremont, CA 415-683-
0883
PRODUCTS: custom, decorative, flush mount,
foreground, full range, outdoor

PA Concepts

450 Taft Dr.
South Holland, IL 60473
(708) 339-8014
Camden Marketing, Pierre Fonds, QU 514-683-
3377

Paso Sound Products, Inc.

14 First Street
Pelham, NY 10803
(914) 738-4800 (800) 231-3034 FAX: (914) 738-3954
Executive Vice President: Paul Mastrangelo;
Product Manager: Ken O'Brien; Credit Manager:
Marilyn Beckerson; Operations Manager:
Anthony Squegila
Anderson Sales, Braintree, MA 617-848-9194
Jack Mesnick Sales, Liverpool, NY 315-622-3211
Palmer Associates, Fairfield, NJ 201-882-1266
Weller Electronic Sales, Inc., Worthington, OH
614-885-7819
Lienau Associates, Columbia, MD 301-621-4113
MJA Marketing, St. Charles, MO 314-447-7111
Northland Assoc., Moorehead, MN 218-233-4616
Allwest Sound & Communication, Camarillo, CA
805-388-7745
Dimension Pt. IX Marketing, Katy, TX 713-578-9277
Mountain Representatives, Denver, CO 303-333-
7745
Miguel Lopez, Hialeah, FL 305-822-6853
Paco Electronics, Ltd., Markham, ON 416-475-0740
Robert Milsk Co., Southfield, MI 313-354-3310
Marketline Inc., Snellville, GA 404-972-9048
Hawkins-Frederickson Assoc., Maitland, FL 407-
831-2474
Lintern Associates, Naperville, IL 708-904-1225
Robert Milsk Co., Indianapolis, IN 317-842-3400
PRODUCTS: columns, components, decorative,
environment protected, flush mount,
foreground, full range, high frequency drivers,
high power, horns, portable, talkback

REVERE INDUSTRIES

1101 Bienville St.
New Orleans, LA 70112
(504) 523-3503 (800) 843-8321 FAX: (504) 525-6361
Vice President Mktg./Sales: Richard Harris
Camden Marketing, Pierre Fonds, QU 514-683-
3377
PRODUCTS: columns, components, custom,
decorative, flush mount, foreground, full range,
high frequency drivers, high power, horns,
outdoor, siren/ voice warning, talkback

San Ming Sound Co.

17921 Lyons Circle
Huntington Bch, CA 92647
(714) 842-9969 FAX: (714) 842-9571
Vice President, Marketing: Chen Hsieh
Karp Communications, Tampa, FL 813-968-7098

SONANCE

961 Calle Negocio
San Clemente, CA 92672
(714) 492-7777 (800) 582-7777 FAX: (714) 361-2705
President: Scott Struthers; Vice President:
Geoff Spencer; Sales Manager: Dave Donald;
International Sales Manager: Mark Cichowski;
Public Relations Director: Mitch Simon; Dir. Sis
Trn. & Mkt. Research: Kevin Leja
Morris Tait and Assoc., Los Angeles, CA 213-877-
4424
Bach Sales, New York, NY 212-727-0404
Tandem Marketing, Chicago, IL 708-605-1960
Dobbs Stanford, Dallas, TX 214-358-0800
Balaton Marketing, Washington DC, 202-471-
1764
MJA Marketing, St. Charles, MO 314-447-7111
PRODUCTS: decorative, environment protected,
flush mount

**SOUND DEVELOPMENT
INDUSTRIES**

1342 S.E. 46th Lane
Cape Coral, FL 33904
(813) 549-6010
Owner: Uolevi L. Lahti; Marketing: Anita P.
Zuefle; Field Service: U. Lahti, Jr.; Security: K.
Lahti
AKU Lahti Industries, Whitmore Lake, MI 313-426-
4292
JTL Industries, Pleasanton, CA 415-462-4230
SDI Industries, Pleasanton, CA 415-426-5537
JMS Marketing, Austin, TX 512-266-1113
PRODUCTS: custom, flush mount

TALK-A-PHONE CO.

5013 N. Kedzie Ave.
Chicago, IL 60625
(312) 539-1100 FAX: (312) 539-1241
Vice President: Samuel Shanes; Sales Manager:
Dan F. Kagan; President: Z. Liberman
JMS Marketing, Austin, TX 512-266-1113
PRODUCTS: environment protected, flush
mount, horns, outdoor, talkback

Technical Audio Devices (TAD)

2265 East 220th Street
Long Beach, CA 90810
(213) 816-0415 FAX: (213) 816-0472
Product Manager: Leon Slevers; Administrative
Assistant: Aaron Ray
Audio Biz, Mundellen, IL 708-949-0280

**TOA ELECTRONICS, INC.**

601 Gateway Blvd. Suite 300
P.O. Box 2047
S San Francisco, CA 94080
(415) 588-2538 (800) 733-4750 FAX: (415) 588-3349
President: Yoshiro Ishida; Director, Audio
Products Div: Richard Krochmal; Director,
Comm. Systems Div.: Al Burns; Mgr., Marketing
Development: Jeff Pallin; Manager, Western
Division: Bill Ford; Manager Engineering
Services: Bob Sweet
Chuck McGregor- Product Consit, Morris Plains,
NJ 201-829-7047
John Murray-Eng.Snd. Mktg. Dev, Springfield, OH
513-324-1993
Bob Hager-Eastern Regional Mgr, Rosewell, GA
404-552-7624
Linda Wick-Central Reg. Mgr., Kansas City, MO
816-453-5775
Robert Slaughter-Cntrl Div Mgr, Houston, TX
713-460-3678
Pete Newmark-West Regional Mgr., Mesa, AZ
602-981-0050
Walter Best, Eastern Reg. Mgr., Sussex, NJ 201-
702-0068
PRODUCTS: foreground, full range, high
frequency drivers, high power, horns, outdoor

UNIVERSITY SOUND INC.

13278 Rolston Avenue
Sylmar, CA 91342
(818) 362-9516 FAX: (818) 367-5292
President: Robert Sandell; Controller: Mary
Coco; National Sales Manager: Greg McLagan;
Design Engineer: Ken Koceski
Jim Burger, Philadelphia, PA 203-297-7160
PRODUCTS: columns, decorative, environment
protected, explosion proof, flush mount,
foreground, full range, horns, outdoor, siren/
voice warning, talkback, underwater

Valcom Inc.

1111 Industry Avenue
Roanoke, VA 24013
(703) 982-3900 FAX: (703) 982-7032
President: John W. Mason; V.P. Marketing and
Sales: Donald D. Buck
Cambridge Marketing, Westerville, OH
614-363-9191

WHELOCK, INC.

273 Branchport Avenue
Long Branch, NJ 07740
(908) 222-6880 (800) 631-2148 FAX: (908) 222-8707
President: Peter W. Tarlton; V.P. Finance and
Admin.: Joseph P. Henry; Vice President
Operations: Douglas E. Phillips; Vice President
Sales/Mktg.: William L. Goldstein;
Telephone/Paging Mktg. Mgr.: Arthur Ariow;
Life Safety Mktg. Mgr.: Rein Haus
Joseph P. McCaffrey, Glen Eilyn, IL 708-790-2898
Edward P. Draney, Peachtree City, GA
404-631-3193
Peter Koehler, Los Angeles, CA 213-572-1347
Steve Goldberg, East Windsor, NJ 609-448-1457
Dave Jackowiak, Burbank, IL 708-599-4099
MJA Marketing, St. Charles, MO 314-447-7111
PRODUCTS: flush mount, horns, outdoor,
powered, siren/ voice warning, talkback

Whelen Engineering Company

Route 145, Winthrop Road
Chester, CT 06412
(203) 526-9504 FAX: (203) 526-4078
President: John F. Olson; Vice
President, Systems Group: Charles Phelps; Dir. of
Mktg., Systems Group: David A. Hale; Dir. of
Technical Services: Tilton L. Block
MJA Marketing, St. Charles, MO 314-447-7111
PRODUCTS: siren/ voice warning

**Order More
Blue Books
Now!**

Ingenious.

You've waited 20 years for a paging projector with all these benefits.

The innovative PA430, a 30-watt paging projector, gives you easier, more economical installation than any other paging speaker...*plus* better sound and more controlled area coverage. And it fits a wider variety of applications.

The versatile PA430 mounts directly to all common electrical backboxes and is quickly clamped to posts or beams. An exclusive University-developed swivel assembly permits pinpoint orientation in any direction, at any angle.

You won't find a paging projector with better speech intelligibility. As the first paging projector ever to feature our constant-directivity principle, it provides accurate 60° x 40° pattern control over the important 2 kHz to 10 kHz range. And its double-slit phasing plug—another “first” in paging projectors—boosts high frequencies for improved off-axis performance. Its durable, high-impact horn eliminates the hollow ringing common in metal horns.

Designing the PA430 for improved speech intelligibility was a major advance. Designing it to reduce total installed costs...*now, that was ingenious.* The PA430—**pro quality in commercial sound**—available only from:

 **University
Sound**
a MARK IV company

13278 RALSTON STREET
SYLMAR, CA 91342-7607
(818) 362-9516 FAX (818) 367-5292

Mark IV Audio Canada
345 Herbert Street
Gananoque, Ontario K7G 2V1
Phone (613) 382-2141
FAX (613) 382-7466



your life easier...

*Larger Selection... Proven Reliability...
Delivered On Time, When You Need It!*

Today more than ever, convenience and dependability are vital to success. Our "instant" lifestyle demands immediate satisfaction. We do things faster, and we expect more.

This is increasingly true both at home and in business. We thrive on the ease of "one stop shopping" and the comfort of purchasing a "sure thing."

With Atlas/Soundolier, you will enjoy these same qualities and more. We offer you the ease and convenience of broad product selection... the means of ordering everything at once—from commercial and professional sound loudspeakers to intercoms and emergency signalling devices... from sound masking equipment to microphone stands, cabinets and enclosure systems.

We offer you that "comfortable feeling" that comes from dealing with people you trust and products you can depend on.



ATLAS / SOUNDOLIER

DIVISION OF AMERICAN TRADING AND PRODUCTION CORPORATION
1859 INTERTECH DRIVE / FENTON, MISSOURI 63026 U.S.A.
TEL: (314) 349-3110 / 800#: 1-800-876-7337 / FAX: (314) 349-1251

MESSAGE REPEATERS STORECASTERS

360 Systems

18740 Oxnard Street
Tarzana, CA 91356
(818) 342-3127 FAX: (818) 342-4372
Director of Sales/Marketing: Don Bird
JMS Marketing, Austin, TX 512-266-1113
PRODUCTS: digital systems, cart machines,
message units

3M SOUND PRODUCTS

Bldg. 551-1W-01
St. Paul, MN 55144
(612) 736-0843 FAX: (612) 736-7614
National Sales Manager: Don Sluder
JMS Marketing, Austin, TX 512-266-1113
PRODUCTS: cart machines

Alarmco

211 South Main Street
P.O. Box 343
Canandaigua, NY 14424
(716) 398-2510 (800) 824-5006 FAX: (716) 394-8861
Marketing: Ron Cook
Cordial/Riley Marketing, Clarkston, MI
313-625-2420
C.L. Pugh, Cleveland, OH 216-238-1777
Repworks, Chicopee, MA 413-533-0845
C.B. Electronic Marketing, Arvada, CO
303-422-0561
Ziskind Associates, Arlington Hts., IL 708-577-1624
Greg Dzubay & Assoc., Glendale, AZ 800-999-0006
PRODUCTS: digital systems, message units,
digital voice recording

ANTEX ELECTRONICS CORP.

16100 S. Figueroa
Gardena, CA 90248
(213) 532-3092 (800) 338-4231 FAX: (213) 532-8509
President: James P. Antrim; Vice President
Sales: Richard Gross; Product Sales Manager:
Robert Bird
Greg Dzubay & Assoc., Glendale, AZ 800-999-0006
PRODUCTS: digital systems, digital voice
recording

APPLIED TECHNICAL SYSTEMS

815 King Pl.
Shreveport, LA 71115
(318) 868-7413 (800) 444-7161 FAX: (318) 631-7613
President: Jim Reccelli; Vice President: Richard
Davis
C.L. Pugh & Associates, Cleveland, OH
216-238-1777
Total Marketing, Fort Worth, TX 817-560-3970
Western Audio Sales, Burbank, CA 818-954-9300
PRODUCTS: message units, sign systems

Atis

6025 Atlantic Blvd., Ste. D
Norcross, GA 30071
(404) 446-7234 FAX: (404) 446-7237
J.B. Parent, Dublin, OH 614-764-0064

Audiocom, Inc.

8100 Oak Lane #401
Miami Lakes, FL 33016
(305) 825-4653 (800) 272-0555 FAX: (305) 558-8799
President: Ron Deblinger; Vice President of
Operations: Art Hecht; Director of Marketing:
Stu Ginsberg
Edwards Company, Inc., Livonia, MI 313-458-7777

Automation Devices

Automation Pk. Box AD
Fairview, VA 16415-0904
(814) 474-5561

Automation Electronics Corp.

11501 Dublin Blvd.
Dublin, CA 94568
(415) 828-2880 FAX: (415) 828-1686
Audio Etc., St. Peters, MO 314-278-4130

Bogen Communications, Inc.

50 Spring Street
P.O. Box 575
Ramsey, NJ 07446
(201) 934-8500 FAX: (201) 934-9832
President: John H. Ochtera; Vice President, Sales
& Mktg: David A. Chambers
Scott Whipple, Columbus, OH 614-272-1689
Sam Blasi, Ramsey, NJ 201-934-8500
Walter Spencer, Ramsey, NJ 201-934-8500
Fred Yosenick, Woodland, CA 916-668-6311
Edwards Company, Inc., Livonia, MI 313-458-7777
PRODUCTS: digital systems, digital voice
recording

Clever Devices Ltd.

10 Sagamore Hill Drive
P.O. Box 2002
Port Washington, NY 11050
(516) 767-0682 (800) 872-6129 FAX: (516) 767-3635
President: William Long; Engineer: Michael
Conway
Precide, Morbio Inferiore, Switzerland,
914-31734

Gliderfluke & Co.

820 Thompson Avenue #35
Glendale, CA 91201
(818) 546-1618 FAX: (818) 546-1619
Owner: Doug Mobley; Marketing: Denise
Dougherty
Greg Dzubay & Assoc., Glendale, AZ 800-999-0006
PRODUCTS: digital systems

Helirotrope General

3733 Kenora Dr.
Spring Valley, CA 92077
(619) 460-3930 FAX: (619) 460-9211

INNOVATIVE ELECTRONIC DESIGNS, INC.

9701 Taylorsville Rd.
Louisville, KY 40299
(502) 267-7436 FAX: (502) 267-9070
President: Hardy Martin; Vice President, Mkt'g&
Sales: Tom Roseberry; Sales Application
Engineer: Mark Lewellyn; V.P. Research &
Development: Bob Ponto; Vice President,
Engineering: Ed Young; Vice President,
Software: John Johnson
Yore Company, White Bear Lake, MN 612-770-
9760
Steffey Marketing Assoc. Inc., Northbrook, IL 708-
480-3575
WesTech Marketing, Culver City, CA 213-870-9286
Repworks, Chicopee, MA 413-533-0845

Darmstedter Associates, Baldwinsville, NY 315-
638-1261

John Anthony, Stamford, CT 203-322-9202
Bencsik Associates, Ocala, FL 904-732-9775
C.L. Pugh, Cleveland, OH 216-238-1777
Monford Electronics Marketing, Indianapolis, IN
317-872-8877
C.M. Sales, Farmington Hill, MI 313-553-8070
B.C. Electronic Sales, Mission, KS 913-262-1720
Marketing Concepts, Irving, TX 214-869-0669
Torbett/Kelser Group, Loveland, CO 303-669-1008
Plus Four Marketing, Walnut Creek, CA 415-937-
0650
North Shore Marketing, Seattle, WA 206-284-9699
Island Instruments, Kaneohe, HI 808-235-7544
PRODUCTS: digital systems, message units,
digital voice recording

J.W. DAVIS AND CO.

3030 Canton Street, Dallas, TX 75226
(214) 651-7341 (800) 527-5705 FAX: (214) 939-0326
President: Harvey Earp; Vice President, Sales:
Jack W. Tucker; Chief Engineer: Eric Simonson
Multi-Technical Reps., Brainerd, MN 218-828-9483
PRODUCTS: message units, digital voice
recording

LaBelle Display Sciences Group

510 S. Worthington
Oconomowoc, WI 53066
(414) 567-9101 (800) 558-9526 FAX: (414) 567-4047
Vice President: Glenn Schulz; Sales Manager: Bill
Hughes
Precide, Morbio Inferiore, Switzerland, 914-
31734
PRODUCTS: sign systems

MACKENZIE LABORATORIES, INC.

5507 Peck Road
Arcadia, CA 91006
(818) 579-0440 (800) 423-4147 FAX: (818) 448-7137
President: Sam Houry; Sr. Vice President: Nagi
Khattar; Manager, Sales: Joe Vitale
Audio Etc., St. Peters, MO 314-278-4130
PRODUCTS: digital systems, cart machines,
digital voice recording

Microvoice Corporation

1 Vanderblit
P.O. Box 19784
Irvine, CA 92715
(714) 859-1091 FAX: (714) 951-7405
Cambridge Marketing, Westerville, OH 614-363-
9191
PRODUCTS: digital systems, message units,
digital voice recording

Nel-Tech Labs, Inc.

15 Londonderry Rd.
P.O. Box 1030
Londonderry, NH 03053
(603) 434-8234 FAX: (603) 434-1265
President & CEO: Gary N. Stapleford; Vice
President Engineering: Joseph St. Onge
Dimension/Point IX, Lewisville, TX 214-436-3706
PRODUCTS: digital systems, message units,
digital voice recording, sign systems

Neutrik USA, Inc.

195-s3 Lehigh Ave., Lakewood, NJ 08701
(908) 901-9488 FAX: (908) 901-9608
General Manager: James E. Cowan; Product
Manager: Kenneth W. Smalley; Product
Manager: William J. Dorman
Dimension/Point IX, Lewisville, TX 214-436-3706
PRODUCTS: digital systems

Racom Products, Inc.

5504 State Rd.
Cleveland, OH 44134
(216) 351-1755 (800) 722-6664 FAX: (216) 351-0392
Sales Manager: Jerry Cahill; Production
Manager: Drew Miller; Sales Consultant: David
Williams
Design Factors, Hacienda Hgts., CA 213-697-7576
Sound Sales, Inc., Columbia, MD 301-964-1170
PRODUCTS: digital systems

SONY CORP. OF AMERICA, A/V PRODUCTS

10833 Valley View Street
Cypress, CA 90630
(714) 229-4318 (800) 326-7669 FAX: (714) 229-4298
Vertical Markets Manager: T. Park; AV Product
Manager: A. Nitta; AV Sales Manager: K. Carr; AV
Product Support Spvr.: A. Ruppe; Management
Associate: D. Williams; Product Support
Coordinator: P. Penell
Cambridge Marketing, Westerville, OH 614-363-
9191
PRODUCTS: cart machines, digital voice
recording

Television Technology Corp.

650 S. Taylor Ave.
Louisville, CO 80027
(303) 665-8000 FAX: (303) 673-9900
President: Dirk Freeman; Vice President,
Engineering: Hal Rabinowitz; Director of
Marketing: Don Massa

TOA ELECTRONICS, INC.

601 Gateway Blvd. Suite 300
P.O. Box 2047
S San Francisco, CA 94080
(415) 588-2538 (800) 733-4750 FAX: (415) 588-3349
President: Yoshiro Ishida; Director, Audio
Products Div: Richard Krochmal; Director,
Comm. Systems Div.: Al Burns; Mgr., Marketing
Development: Jeff Pailin; Manager, Western
Division: Bill Ford; Manager Engineering
Services: Bob Sweet
Chuck McGregor- Product Const, Morris Plains,
NJ 201-829-7047
John Murray-Eng.Snd. Mktg. Dev, Springfield, OH
513-324-1993
Bob Hager-Eastern Regional Mgr, Rosewell, GA
404-552-7624
Linda Wick-Central Reg. Mgr., Kansas City, MO
816-453-5775
Robert Slaughter-Cntrl Div Mgr, Houston, TX 713-
460-3678
Pete Newmark-West Regional Mgr., Mesa, AZ
602-981-0050
Walter Best, Eastern Reg. Mgr., Sussex, NJ 201-
702-0068
PRODUCTS: message units

WHEELOCK, INC.

273 Branchport Avenue
Long Branch, NJ 07740
(908) 222-6880 (800) 631-2148 FAX: (908) 222-8707
President: Peter W. Tarlton; V.P. Finance and
Admin.: Joseph P. Henry; Vice President
Operations: Douglas E. Phillips; Vice President
Sales/Mktg.: William L. Goldstein;
Telephone/Paging Mktg. Mgr.: Arthur Arlow;
Life Safety Mktg. Mgr.: Rein Haus
Joseph P. McCaffrey, Glen Ellyn, IL 708-790-2898
Edward P. Draney, Peachtree City, GA 404-631-
3193
Peter Koehler, Los Angeles, CA 213-572-1347
Steve Goldberg, East Windsor, NJ 609-448-1457
Dave Jackowiak, Burbank, IL 708-599-4099
MJA Marketing, St. Charles, MO 314-447-7111
PRODUCTS: digital voice recording

**Subscribe to
Sound &
Communications
Magazine**

Stop feedback with the *new* FE-2!

MacKenzie's new Digital Feedback Eliminator, Model FE-2, is a completely redesigned version of our highly successful FE-1. The FE-2 is a solid-state, digital record/play unit designed to be installed between power amplifiers and the paging system. When a paging station is actuated, the message is digitized and stored in memory. When the page ends, the digitized message is released to play over the system's speakers. Since the open microphone is eliminated, amplifiers may be turned up to any desired level - *with no feedback at all!*

The FE-2 has many new features, including compact size - only 7" wide, 8" high and 2" deep - and a newly designed body configured for wall mounting in a telephone equipment room. The unit's voice quality is entirely natural, just like a tape recording. And the FE-2 interfaces with all popular page-control modules. The following standard features are available via dip-switch settings:

- Message time of 60 seconds at 3.4 KHz or 30 seconds at 6.8 KHz.
- Automatic insertion of a pre-page alert tone during recording and playback.
- Repeat page once or twice with automatic insertion of a pause between pages.
- DTMF restriction that aborts pages if unauthorized DTMF tones are received.
- Supervisory contacts to indicate recording, playing, busy, etc.

For more information about the new FE-2, call MacKenzie Laboratories toll-free:

800-423-4147

MACKENZIE

5507 Peck Road • Arcadia, California 91006 USA • (818) 579-0440 • Fax: (818) 448-7131

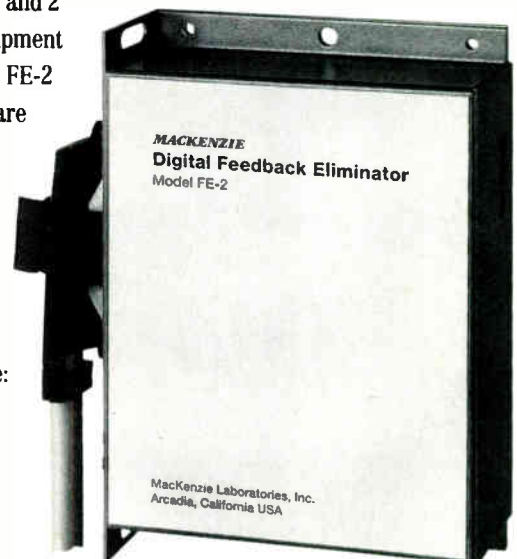

Circle 245 on Reader Response Card

FOR CREATIVE

NAMM TV NEWS

MUSIC & SOUND Awards

AES-TV NEWS

**INCLUDING:
CROSTALK SYMPOSIUM**

NAB

TV NEWS

1991
INTERNATIONAL

DJ expo

ES-TV NEWS

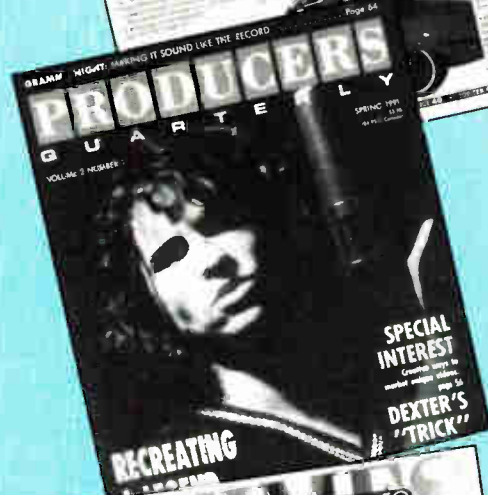
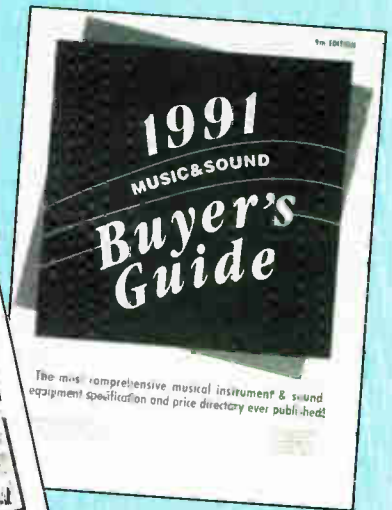

Testa Communications publications and television productions share a common commitment to service and develop specialized markets in related industries for creative professionals.

RENEW

CONTINUE YOUR
FREE
SUBSCRIPTION

TO

SOUND
&
COMMUNICATIONS

FILL ALL THE
QUESTIONS AND
MAIL YOUR
NEW
SUBSCRIPTION
OR RENEWAL
TODAY.

FOR YOUR FREE
SUBSCRIPTION TO BE
PROCESSED THE FORM
MUST BE COMPLETED
PROPERLY, SIGNED AND
DATED FOR THOSE
QUALIFIED INDIVIDUALS.

YES! I WANT TO STAY ON TOP OF THE INDUSTRY BY RECEIVING
A COPY OF **SOUND & COMMUNICATIONS** EVERY MONTH

- NEW RENEWAL
- 1 Year \$15.00 3 Years \$37.50 (Savings \$7.50)
- Payment Enclosed Bill My Credit Card Visa MC AE
- (Foreign: Add \$10 for delivery) Card # _____ Expires: _____
- DO YOU WISH A FREE SUBSCRIPTION? YES NO — COMPLETE BELOW:

Signature _____ Date _____

Name _____ Title _____

Company _____

Address _____

City _____ State _____ Zip _____

- | | | |
|--|--|--|
| <p>(1) Do you wish to receive Sound & Communications?
Yes <input type="checkbox"/> No <input type="checkbox"/></p> <p>(2) Primary Job Function (only one):</p> <ul style="list-style-type: none"> <input type="checkbox"/> A Management/Owner <input type="checkbox"/> B Engineer/Technical Mgt. <input type="checkbox"/> C Sales/Marketing <input type="checkbox"/> D In-House Maintenance/Service <input type="checkbox"/> E Field Installation/Maintenance <input type="checkbox"/> F Consultant <input type="checkbox"/> G Advertising/Promotion <input type="checkbox"/> H Other _____ | <p>(3) Primary business of company (only one):</p> <ul style="list-style-type: none"> <input type="checkbox"/> 1 Contractor—Engineered Sound/Acoustical <input type="checkbox"/> 2 Contractor—Interconnect/Intercom <input type="checkbox"/> 3 Contractor—Fire/Alarm/Safety <input type="checkbox"/> 4 Electrical Contractor <input type="checkbox"/> 5 Pro Audio/Studio/Reinforcement <input type="checkbox"/> 6 Architect/Designer <input type="checkbox"/> 7 Engineering/Acoustical Consulting <input type="checkbox"/> 8 Maintenance/Service <input type="checkbox"/> 9 Dealer/Distributor/Rep <input type="checkbox"/> M Manufacturer <input type="checkbox"/> O Other _____ | <p>(4) Your purchasing authority:</p> <ul style="list-style-type: none"> <input type="checkbox"/> A Final approval/Buyer <input type="checkbox"/> B Recommend/Specifier <input type="checkbox"/> C No Direct Authority/User <p>(5) Number of employees at your company:</p> <ul style="list-style-type: none"> <input type="checkbox"/> 1-3 <input type="checkbox"/> 4-10 <input type="checkbox"/> 11-25 <input type="checkbox"/> 26-100 <input type="checkbox"/> Over 100 |
|--|--|--|
- 8/91

YES! I WANT TO STAY ON TOP OF THE INDUSTRY BY RECEIVING
A COPY OF **SOUND & COMMUNICATIONS** EVERY MONTH

- NEW RENEWAL
- 1 Year \$15.00 3 Years \$37.50 (Savings \$7.50)
- Payment Enclosed Bill My Credit Card Visa MC AE
- (Foreign: Add \$10 for delivery) Card # _____ Expires: _____
- DO YOU WISH A FREE SUBSCRIPTION? YES NO — COMPLETE BELOW:

Signature _____ Date _____

Name _____ Title _____

Company _____

Address _____

City _____ State _____ Zip _____

- | | | |
|--|--|--|
| <p>(1) Do you wish to receive Sound & Communications?
Yes <input type="checkbox"/> No <input type="checkbox"/></p> <p>(2) Primary Job Function (only one):</p> <ul style="list-style-type: none"> <input type="checkbox"/> A Management/Owner <input type="checkbox"/> B Engineer/Technical Mgt. <input type="checkbox"/> C Sales/Marketing <input type="checkbox"/> D In-House Maintenance/Service <input type="checkbox"/> E Field Installation/Maintenance <input type="checkbox"/> F Consultant <input type="checkbox"/> G Advertising/Promotion <input type="checkbox"/> H Other _____ | <p>(3) Primary business of company (only one):</p> <ul style="list-style-type: none"> <input type="checkbox"/> 1 Contractor—Engineered Sound/Acoustical <input type="checkbox"/> 2 Contractor—Interconnect/Intercom <input type="checkbox"/> 3 Contractor—Fire/Alarm/Safety <input type="checkbox"/> 4 Electrical Contractor <input type="checkbox"/> 5 Pro Audio/Studio/Reinforcement <input type="checkbox"/> 6 Architect/Designer <input type="checkbox"/> 7 Engineering/Acoustical Consulting <input type="checkbox"/> 8 Maintenance/Service <input type="checkbox"/> 9 Dealer/Distributor/Rep <input type="checkbox"/> M Manufacturer <input type="checkbox"/> O Other _____ | <p>(4) Your purchasing authority:</p> <ul style="list-style-type: none"> <input type="checkbox"/> A Final approval/Buyer <input type="checkbox"/> B Recommend/Specifier <input type="checkbox"/> C No Direct Authority/User <p>(5) Number of employees at your company:</p> <ul style="list-style-type: none"> <input type="checkbox"/> 1-3 <input type="checkbox"/> 4-10 <input type="checkbox"/> 11-25 <input type="checkbox"/> 26-100 <input type="checkbox"/> Over 100 |
|--|--|--|
- 8/91



FOR YOUR **FREE** SUBSCRIPTION ALL YOU NEED TO DO, AS A PROFESSIONAL IN OUR SOUND AND COMMUNICATION INDUSTRY, IS TO COMPLETE THE CARD BELOW AND MAIL IT. THIS QUALIFICATION IS NECESSARY FOR AUDIT PURPOSES. DO NOT MISS A SINGLE ISSUE. MAIL YOUR CARD TODAY.

Place
Stamp
Here

SOUND & COMMUNICATIONS

25 Willowdale Avenue
Port Washington, NY 11050

Place
Stamp
Here

SOUND & COMMUNICATIONS

25 Willowdale Avenue
Port Washington, NY 11050

PROFESSIONALS

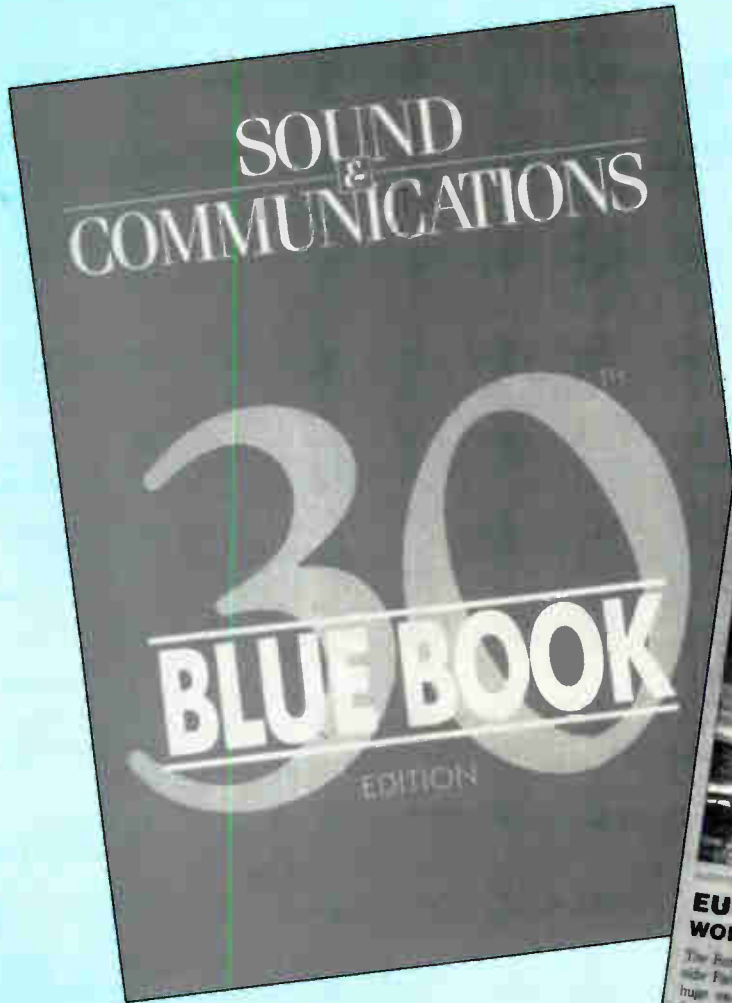

ASCO
TV NEWS



Editorial, Advertising & Circulation

25 Willowdale Avenue

Port Washington, NY 11050

Phone: 516-767-2500; Fax: 516-767-9335

TESTA
COMMUNICATIONS

MICROPHONES WIRELESS



Audex

713 N. 4th St.
Longview, TX 75601
(903) 758-9392 FAX: (903) 753-9546
Audio Etc., St. Peters, MO 314-278-4130

AUDIO-TECHNICA U.S., INC.

1221 Commerce Drive
Stow, OH 44224
(216) 686-2600 FAX: (216) 688-0719
Vice President, Marketing: Ken Reichel; National
Marketing Manager: Earl "Buzz" Goodwin;
National Sales Manager: Garry Elliott; Inside
Sales: Tony O'Keefe; Sales Coordinator: Kim
Wallace
Nova Marketing, San Francisco, CA 415-952-0943
PRODUCTS: body packs, hand-held, lavaller, noise
reduction, receivers, single channel, true
diversity, UHF, VHF

beyerdynamic)))

5-05 Burns Ave.
Hicksville, NY 11801
(516) 935-8000 FAX: (516) 935-8018
Vice President/ General Mgr.: Paul Murphy;
Marketing Manager: Michael Solomon; Service
Manager: Jim Hassel
Henderson Company, Concord, MA 508-287-0020
Applied Audio Marketing, Aseville, NC
704-252-9313
New Horizons, Bannockburn, IL 708-234-6500
Marcon, Irving, TX 214-869-0669
Derek Allen Associates, Burbank, CA 818-840-8327
Cambridge Marketing, Westerville, OH
614-363-9191
PRODUCTS: batteries, body packs, hand-held,
lavaller, multi-channel, noise reduction,
receivers, single channel, true diversity, UHF, VHF

CLARITY

1111 Industry Avenue, S.E.
Roanoke, VA 24013
(703) 982-7003 (800) 962-6009 FAX: (703) 982-7032
President: John W. Mason; Sales Coordinator:
Linda T. Blishop; Product Manager: John D.
Spencer
Featherstone Sales, Los Gatos, CA 408-356-3243
Unirep Inc., Valrico, FL 813-681-3477
M.I.N.K. Associates, Overland Park, KS
913-341-2112
Gerald Horne Associates, Stow, MA 508-897-1741
Forti Associates, Kensington, MD 301-949-1706
Holland Marketing, Bloomington, MN
612-881-8425
Adams & Associates, Greensboro, NC
919-272-6838
Repptronics Inc., New Madison, OH 800-888-0530
Dick Belew Sales, Dallas, TX 214-644-7881
PRODUCTS: body packs, hand-held, lavaller,
single channel, VHF

Comtek

357 West 2700 South, Salt Lake City, UT 84115
(801) 466-3463 FAX: (801) 484-6906
President: Ralph Belgique; Applications
Engineering: Steve Kartchner; Applications
Engineering: Steve Dupalx; Service Manager:
Laurel Robertson; Credit Manager: Dana
Pelletier
Edwards Company, Inc., Livonia, MI 313-458-7777
PRODUCTS: batteries, body packs, hand-held,
lavaller, multi-channel, noise reduction,
receivers, single channel, true diversity, VHF

Electron Processing

P.O. Box 708
Medford, NY 11763
(616) 228-7020

HM ELECTRONICS, INC.

6675 Mesa Ridge Road, San Diego, CA 92121
(619) 535-6060 FAX: (619) 552-0139
General Sales Manager: Bruce Siemmer; Western
Regional Sales Mgr.: David VanEpps; Midwest
Regional Sales Mgr.: John Debrocke; Eastern
Regional Sales Mgr.: Milke Cerveny
Derek Allen Associates, Toluca Lake, CA
818-840-8327
A/V Marketing, Carmel, IN 317-846-1034
John B. Anthony Company, Stamford, CT
203-322-9202
ADCOM, Toronto, ON 416-251-3355
PRODUCTS: batteries, body packs, hand-held,
lavaller, multi-channel, noise reduction,
receivers, single channel, true diversity, VHF

International Components Corp.

105 Maxess Road, Melville, NY 11747
(516) 293-1500 (800) 645-9154 FAX: (516) 293-4983
President: Mort Grossman; Executive Vice
President: Irwin Friedman; Vice President: Fred
Grossman; Eastern Regional Sales Mgr.: Ken
Reed; Vice President: Harvey Grossman
C.B. Electronic Marketing, Arvada, CO
303-422-0561

International Logistics Systems Inc

295 Cortlandt Street
P.O. Box 25
Belleville, NJ 07109
(201) 759-0007 FAX: (201) 759-8989
President: Carmine O. Pellosie; Vice President:
Dar Hyatt
ADCOM, Toronto, ON 416-251-3355
PRODUCTS: body packs, hand-held, UHF, VHF

J.W. DAVIS AND CO.

3030 Canton Street
Dallas, TX 75226
(214) 651-7341 (800) 527-5705 FAX: (214) 939-0328
President: Harvey Earp; Vice President, Sales:
Jack W. Tucker; Chief Engineer: Eric Simonson
Multi-Technical Reps., Brainerd, MN 218-828-9483
PRODUCTS: batteries, body packs, hand-held,
lavaller, multi-channel, noise reduction,
receivers, single channel, true diversity, UHF, VHF

Lectrosionics, Inc.

P.O. Box 15900
Rio Rancho, NM 87174
(505) 892-4501 (800) 821-1121 FAX: (505) 892-6242
President: John Araslm; Vice President
Engineering: Larry Fisher; Vice President Mktg &
Sales: Bruce Jones
C.L. Pugh & Associates, Cleveland, OH 216-238-
1777
PRODUCTS: body packs, hand-held, lavaller,
multi-channel, noise reduction, receivers, single
channel, true diversity, VHF



LIGHTSPEED TECHNOLOGIES, INC.

10101 S.W. Barbur Blvd. # 207
P.O. Box 19479, Portland, OR 97219
(503) 244-0608 (800) 732-8999 FAX: (503) 244-8527
President: Jerry Ramey; National Sales Manager:
Mark Sheperd
Chuck Olson Assoc., Renton, WA 206-271-5416
PRODUCTS: body packs, hand-held, lavaller,
receivers, single channel, true diversity, VHF

Nady Systems, Inc.

6701 Bay Street, Emeryville, CA 94608
(415) 652-2411 FAX: (415) 652-5075
President: John Nady; National Sales Manager:
Howard Zimmerman; Dir. of Product
Development: Jonathan Cohen; Advertising
Manager: Tono Rondone; International Mktg.
Mgr.: Raj K. Judge; Export Sales Manager: James
Merlicle
Audio Biz, Mundellen, IL 708-949-0280
PRODUCTS: body packs, hand-held, lavaller,
multi-channel, noise reduction, receivers, single
channel, true diversity, UHF, VHF

Paso Sound Products, Inc.

14 First Street, Pelham, NY 10803
(914) 738-4800 (800) 231-3034 FAX: (914) 738-3954
Executive Vice President: Paul Mastrangelo;
Product Manager: Ken O'Brien; Credit Manager:
Marilyn Beckerson; Operations Manager:
Anthony Squeglia
Anderson Sales, Braintree, MA 617-848-9194
Jack Mesnick Sales, Liverpool, NY 315-622-3211
Palmler Associates, Fairfield, NJ 201-882-1266
Weller Electronic Sales, Inc., Worthington, OH
614-885-7819
Lienau Associates, Columbia, MD 301-621-4113
MJA Marketing, St. Charles, MO 314-447-7111
Northland Assoc., Moorehead, MN 218-233-4616
Allwest Sound & Communication, Camarillo, CA
805-388-7745
Dimension Pt. IX Marketing, Katy, TX 713-578-9277
Mountain Representatives, Denver, CO 303-333-
7745
Miguel Lopez, Hialeah, FL 305-822-6853
Paco Electronics, Ltd., Markham, ON 416-475-0740
Robert Milsk Co., Southfield, MI 313-354-3310
Marketline Inc., Snellville, GA 404-972-9048
Hawkins-Frederickson Assoc., Maitland, FL 407-
831-2474
Lintern Associates, Naperville, IL 708-904-1225
Robert Milsk Co., Indianapolis, IN 317-842-3400
PRODUCTS: body packs, hand-held

PEAVEY ELECTRONICS CORP.

111 A Street
P.O. Box 2898
Meridian, MS 39301
(601) 483-5365 FAX: (601) 484-4278
CEO: Hartley Peavey; President: Mella Peavey
Dimension/ Point IX, Lewisville, TX 214-436-3706
PRODUCTS: batteries, body packs, hand-held,
lavaller, multi-channel, noise reduction,
receivers, single channel, true diversity, UHF, VHF

Phonic Ear Inc.

1880 Cypress Drive, Petaluma, CA 95954-7600
(707) 769-1110 (800) 227-0735 FAX: (707) 769-9624
President & CEO: James C. Mulford; V.P., Sales &
Marketing: Richard G. Pimentel; Director of
Business Dev.: Richard L. Steighner; V.P.,
Technical Operations: Gene Strohallen; Project
Engineer: Lee Henderson
Phonic Ear Eastern Region, Columbia, MD
(301) 725-8883
Phonic Ear Ltd., Mississauga, ON 416-677-3231
Dimension/ Point IX, Lewisville, TX 214-436-3706

Plainview Batteries, Inc.

23 Newtown Rd.
Plainview, NY 11803
(516) 249-2873 FAX: (516) 249-2876
Dimension/ Point IX, Lewisville, TX 214-436-3706

Samson Technologies Corp.

262 Duffy Ave, Hicksville, NY 11801
(516) 932-3810 FAX: (516) 932-3815
Vice Pres. Sales & Marketing: Scott Goodman;
Vice President - Engineering: Doug Bryant;
Export Sales: Kevin Moran; Domestic Sales:
David Olivier
Image Marketing, Fountain Valley, CA
714-957-0630
Jamm Distributing, Flossmoor, IL 708-799-0550
Reflex Marketing, Hempstead, NY 516-565-2323
JMS Marketing, Austin, TX 512-266-1113
Worldwide Electronics, Davie, FL 305-584-7024
Karp Communications, Tampa, FL 813-968-7098

Schell Electronics, Inc.

120 N. Lincoln, Chanute, KS 66720
(316) 431-2350 FAX: (316) 431-2365
President: Jerry Schell; Secretary/Treasurer
(Sales): Janice Schell
Cambridge Marketing, Westerville, OH 614-363-
9191
PRODUCTS: batteries, body packs, hand-held,
lavaller, receivers, single channel

Sennheiser Electronic Corp.

6 Vista Drive
P.O. Box 987, Old Lyme, CT 06371
(203) 434-9190 FAX: (203) 434-1759
President: Andrew Brakhan; Pro Products
Manager: Albert C. Zang Jr.
MJA Marketing, St. Charles, MO 314-447-7111
PRODUCTS: body packs, hand-held, lavaller,
multi-channel, receivers, single channel, true
diversity, UHF, VHF

SHURE BROTHERS, INC.

222 Hartrey Avenue
Evanston, IL 60202-3696
(708) 866-2200 (800) 257-4873 FAX: (708) 866-2279
President: James H. Kogen; Vice Pres. Finance &
Sales: Robert Gilbert; Vice President, Sales:
Lottie Morgan; Director, Technical Markets: John
Phelan; Director Microphone Products: Sandy
Schroeder; Dir., Mktg. Communications: Nancy
Calvert
Audio Biz, Mundelein, IL 708-949-0280
PCM Marketing, Walnut Creek, CA 415-935-0900
Peter E. Schmitt Company, Inc., Leonia, NJ 201-
944-2806
Millar Electronics, Inc., Atlanta, GA 404-634-3350
Pro Tech Marketing, Midvale, UT 801-561-8844
Karp Communications, Tampa, FL 813-968-7098

**Sony Corp./Business & Pro. Aud.
Grp**

3 Paragon Drive
Montvale, NJ 07645-1735
(201) 930-1000
President, Sales & Marketing: Mark Gray; Senior
VP Sales: C.F. Taylor; V.P. Product Marketing:
Anthony Gargano; Marketing Manager, Pro
Audio: Courtney Spencer; Sales Manager, Pro
Audio: Gary Rose; V.P. Audio Products: Ron
Remschel
Matt Robertson, Western Dist., 213-469-9084
Audio Etc., St. Peters, MO 314-278-4130
PRODUCTS: lavaller, UHF, VHF

Systems Wireless, Ltd.

465 Herndon Parkway
Herndon, VA 22070
(703) 471-7887 (800) 542-3332 FAX: (703) 437-1107
President: Theodore Bennett; Vice President:
William Slen; Sales Engineer - Wireless: John
Kowalski; Sales Engineer - Intercom: Pat Hamp;
Rental Manager: Tom Conner; Service Manager:
Jim Cohlil
Sound Sales, Inc., Columbia, MD 301-964-1170

TELEX COMMUNICATIONS, INC.

9600 Aldrich Avenue South
Minneapolis, MN 55420
(612) 884-4051 FAX: (612) 884-0043
President: Jeffrey Wetherell; Vice President
Marketing: John Schofield; Vice President Sales:
Dan Dantzler; Director of Marketing: Don
Mereen; Manager/Advertising & Mktg: Ron
Taylor
WestTech Marketing, Culver City, CA 213-870-9286
Bencsik Associates, Ocala, FL 904-732-9775
Burcaw Company & Associates, Warren, MI 313-
573-4605
SAGA, Oswego, NY 315-343-5739
Monfort Electronic Marketing, Indianapolis, IN
317-872-8877
Murphy & Cotta, Inc., Atlanta, GA 404-875-2525
Northland Associates, Moorhead, MN 218-233-
4616
Rancillo Associates, Inc., St. Louis, MO 314-845-
0202
J.Y. Schoonmaker Company, Dallas, TX 214-349-
1650
Sigmet Corporation, Valley Forge, PA 215-783-
6666
Weller Electronic Sales, Worthington, OH 614-
885-7819
Ziskind Associates, Rolling Meadows, IL 312-577-
1624
White Radio Ltd., Burlington, ON 416-632-6894
Silver Peak Marketing, Denver, CO 303-467-9042
PacNor Marketing, Lynnwood, WA 206-771-6016
PRODUCTS: body packs, hand-held, true diversity

The Music People, Inc.

2074 Park St., Hartford, CT 06106
(203) 236-7134 (800) 289-8889 FAX: (203) 233-6888
President: James R. Hennessey; Controller:
John Cutowski; Import/Export Manager: Kelly
Heintz; Purchasing Manager: Paul Thaxton
West Coast Warehouse Facility, Los Angeles, CA
PRODUCTS: batteries, body packs, hand-held,
lavaller, multi-channel, noise reduction,
receivers, single channel, true diversity, UHF, VHF

The Sandell Company

24808 Aden Av, Newhall, CA 91321
(805) 259-0108 FAX: (805) 259-0108
President: Robert W. Sandell; Executive Vice
President: Cynthia P. Sandell; Vice President,
Operations: Lillian R. Cory
Camden Marketing, Pierre Fonds, QU
514-683-3377
PRODUCTS: windscreens

**TOA ELECTRONICS, INC.**

601 Gateway Blvd. Suite 300
P.O. Box 2047
San Francisco, CA 94080
(415) 588-2538 (800) 733-4750 FAX: (415) 588-3349
President: Yoshiro Ishida; Director, Audio
Products Div: Richard Krochmal; Director,
Comm. Systems Div.: Al Burns; Mgr., Marketing
Development: Jeff Pailin; Manager, Western
Division: Bill Ford; Manager Engineering
Services: Bob Sweet
Chuck McGregor - Product Consit, Morris Plains,
NJ 201-829-7047
John Murray-Eng.Snd. Mktg. Dev, Springfield, OH
513-324-1993
Bob Hager - Eastern Regional Mgr, Rosewell, GA
404-552-7624
Linda Wick-Central Reg. Mgr., Kansas City, MO
816-453-5775
Robert Slaughter-Cntrl Div Mgr, Houston, TX 713-
460-3678
Pete Newmark-West Regional Mgr., Mesa, AZ
602-981-0050
Walter Best, Eastern Reg. Mgr., Sussex, NJ 201-
702-0068
PRODUCTS: body packs, hand-held, lavaller,
multi-channel, noise reduction, receivers, single
channel, true diversity, VHF

Vega

9900 Baldwin Place
El Monte, CA 91734
(818) 442-0782 (800) 877-1771 FAX: (818) 444-1342
President: Gary Stanfill; Wireless Mkt'g
Specialist: James Stoffo
Metropolis Audio Marketing Inc, Edison, NJ 201-
225-0085
R.J. Marketing Limited, Rockville, MD 301-251-
0330
Ouzunoff and Associates, Yorktown Hts., NY 914-
245-6452
Ron Tunks Sales Inc., Tamarac, FL 305-722-2803
Wilson Audio Sales, Nashville, TN 615-646-4477
Cambridge Marketing, Westerville, OH 614-363-
9191

WE'LL TAKE YOU THERE

VIDEO CASSETTES NOW AVAILABLE WITH FULL COVERAGE OF ALL THE INDUSTRY TRADE SHOWS IMPORTANT TO YOUR BUSINESS.

You and your key personnel can travel to the trade show on your VCR. Each video cassette contains 3 full days of on-the-spot show coverage of the people, products, and hottest news in the industry.

**DON'T MISS
A THING!
ORDER YOUR
TAPES TODAY.**

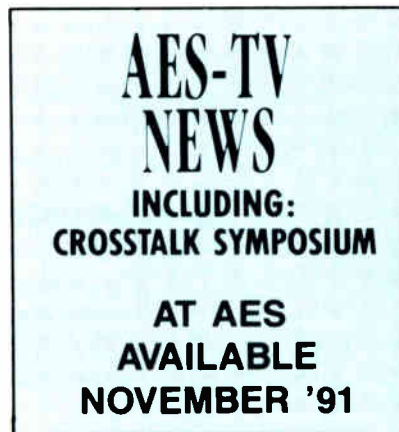
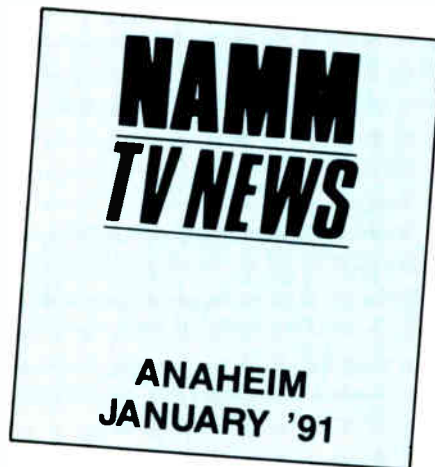

Please check the Show(s) you want.
First Tape **\$59.95**; Additional tapes just **\$24.98** each

- NSCA-TV NEWS — Cincinnati**
Nat'l Sound & Communications Assn
Contractors Expo '91
- NAB-TV NEWS — Las Vegas**
Nat'l Assn. of Broadcasters Show
- NAMM-TV NEWS — Anaheim**
Nat'l Assn. of Music Merchants
- AES-TV NEWS/CROSSTALK Symposium**
Audio Engineering Society Convention, NY
- CES-TV NEWS — Las Vegas**
Consumer Electronics Show

All shows are independently produced by Testa Communications

Please send _____ tape(s).
1 Tape, **\$59.95**; 2 for **\$84.93**; 3 for **\$109.91**; 4 for **\$134.89**;
All Five for **\$159.87**

Name _____
Company _____
Address _____
City _____ State _____ Zip _____
Telephone: _____
Indicate payment method: (Prepayment required)
Credit Card # _____
 Visa MC AmEx Check Enclosed
Expiration Date _____
Signature _____

Mail to: TV Tapes, 25 Willowdale Avenue, Port Washington, N.Y. 11050

Williams Sound Corp.

10399 W. 70th St.
Eden Prairie, MN 55344
(612) 943-2252 (800) 328-6190 FAX: (612) 943-2174
President: James M. Broz; Vice President of Marketing: Paul Ingebrigtsen; National Sales Manager: Todd Bergum; Customer Service Manager: Barb Gudnecht; Vice President, Engineering: Jay Kershaw
J.B. Parent, Dublin, OH 614-764-0064
PRODUCTS: batteries, body packs, lavaller, multi-channel, receivers, VHF

WISSCO

1599 Superior Avenue, A-1
Costa Mesa, CA 92627
(714) 645-1281 (800) 854-6280 FAX: (714) 642-4292
President: Jeanne Wanlass
Cambridge Marketing, Westerville, OH
614-363-9191
PRODUCTS: batteries, body packs, hand-held, lavaller, multi-channel, noise reduction, receivers, single channel, true diversity, UHF

**Ac-cetera Inc.**

3120 Banksville Road, Pittsburgh, PA 15216
(412) 344-1520 (800) 537-3491 FAX: (412) 344-0818
President: Susan Stamm
Nova Marketing, San Francisco, CA 415-952-0943

AKG Acoustics, Inc.

1525 Alvarado Street, San Leandro, CA 94577
(510) 351-3500 FAX: (510) 351-0500
President (USA): S. Richard Ravlich; Marketing Manager: David Roudebush; Vice President Operations: Derek Pilkington; Director of National Sales: David Angress; Sales Manager (C&S America): Jesse Maxenchs
Jeff Radke, Midwest Reg. Mgr., Appleton, WI
414-749-0044
Jim Burger, Philadelphia, PA 203-297-7160
PRODUCTS: boundary, communications, condenser, contact pickups, dynamic, electret condenser, goosenecks, hand-held, headset boom, miniature, podium, shotgun, specialty, stands, stereo

Altec Lansing Corp.

10500 W. Reno, Oklahoma City, OK 73128
(405) 324-5311 FAX: (405) 324-8981
President: Dave Merrey; Vice President, Sis. & Mktg: Chuck Lange; National Sales Manager: Jerry Spriggs; Manager Export Marketing: John Sexton; Technical Services Manager: Gary Jones; Customer Services Manager: Jim Brown
Dave Read, McKinney, TX 214-542-6328
Jim Faber, Shreveport, LA 318-631-1766
Paul Froula, Lombard, IL 708-268-1831
Alan Feckanin, Port St. Lucie, FL 407-879-1078
George Solti, Philadelphia, PA 215-637-3429
Larry Schlrmer, Pontiac, MI 313-340-9588
Stu Moffit, Renton, WA 206-277-8851
PRODUCTS: condenser, dynamic, electret condenser, goosenecks, miniature, podium, push-to-talk

AMS Industries, Inc.

7 Parklawn Dr., Bethel, CT 06801
(203) 792-4997 FAX: (203) 730-8549
President: John Gluck; Nat. Sales Mgr., Stand. Prod: Adrian Weldmann
Gus Skinas, Hollywood, CA 213-957-2265
Michael Mueller-Sen. Sis. Eng., New York, NY
212-956-2907
Douglas Ordon-Sen. Sis. Eng., Chicago, IL
312-645-9888
Tom Semmes-S.E. Reg. Sis. Mgr., Nashville, TN
615-329-9584
Soundings Inc., Seattle, WA 206-624-1317
ADCOM, Toronto, ON 416-251-3355
PRODUCTS: specialty, stereo

Audio Engineering Associates

1029 N. Allen Ave., Pasadena, CA 91104
(818) 798-9127 FAX: (818) 798-2378
President: Wes Dooley; Sales: Steve Trunnell;
Operations Manager: Jawxllion Loeb
Vector Corp., Seattle, WA 206-368-8400

AUDIO-TECHNICA U.S., INC.

1221 Commerce Drive, Stow, OH 44224
(216) 686-2600 FAX: (216) 688-0719
Vice President, Marketing: Ken Relchel; National Marketing Manager: Earl "Buzz" Goodwin;
National Sales Manager: Garry Elliott; Inside Sales: Tony O'Keefe; Sales Coordinator: Kim Wallace
Nova Marketing, San Francisco, CA 415-952-0943
PRODUCTS: boundary, condenser, dynamic, electret condenser, goosenecks, hand-held, headset boom, miniature, podium, shotgun, stereo

Audix Corp.

19439 SW 90th Court, Tualatin, OR 97062
(503) 692-4426 (800) 394-7007 FAX: (415) 463-2149
Operations Manager: Fred Bigen; Vice President, Sales: Cliff Castle; Customer Support: LuCinda LeDonne
Triad Marketing, Wayne, NJ 201-696-8625
Elliot Goldman Sales, Framingham, MA
508-877-1537
Robert Louis Associates, Pittsburgh, PA
412-487-7001
TC Marketing, Los Angeles, CA 818-776-8120

beyerdynamic)))

5-05 Burns Ave., Hicksville, NY 11801
(516) 935-8000 FAX: (516) 935-8018
Vice President/ General Mgr.: Paul Murphy;
Marketing Manager: Michael Solomon; Service Manager: Jim Hassel
Henderson Company, Concord, MA 508-287-0020
Applied Audio Marketing, Asheville, NC 704-252-9313
New Horizons, Bannockburn, IL 708-234-6500
Marcon, Irving, TX 214-869-0669
Derek Allen Associates, Burbank, CA 818-840-8327
Cambridge Marketing, Westerville, OH 614-363-9191
PRODUCTS: boundary, communications, condenser, contact pickups, dynamic, electret condenser, goosenecks, hand-held, headset boom, instrumentation, miniature, podium, push-to-talk, ribbon, shotgun, specialty, stands, stereo

Black Audio Devices

P.O. Box 106
Ventura, CA 93002
(805) 653-5557
President: Bruce Black
Nova Marketing, San Francisco, CA 415-952-0943
PRODUCTS: stands

Bogen Communications, Inc.

50 Spring Street
P.O. Box 575, Ramsey, NJ 07446
(201) 934-8500 FAX: (201) 934-9832
President: John H. Ochtera; Vice President, Sales & Mktg: David A. Chambers
Scott Whipple, Columbus, OH 614-272-1689
Sam Blasl, Ramsey, NJ 201-934-8500
Walter Spencer, Ramsey, NJ 201-934-8500
Fred Yosenick, Woodland, CA 916-668-6311
Edwards Company, Inc., Livonia, MI 313-458-7777
PRODUCTS: dynamic, electret condenser, goosenecks, hand-held, push-to-talk, stands

C-T Audio

3050 SW 14th Place #3, Boynton Beach, FL 33426
(407) 738-0622 FAX: (407) 738-0319
President: Jack Waligora
Edwards Company, Inc., Livonia, MI 313-458-7777

CLARITY

1111 Industry Avenue, S.E., Roanoke, VA 24013
(703) 982-7003 (800) 962-6009 FAX: (703) 982-7032
President: John W. Mason; Sales Coordinator: Linda T. Bishop; Product Manager: John D. Spencer
Featherstone Sales, Los Gatos, CA 408-356-3243
Unirep Inc., Vairco, FL 813-681-3477
M.I.N.K. Associates, Overland Park, KS 913-341-2112
Gerald Horne Associates, Stow, MA 508-897-1741
Forti Associates, Kensington, MD 301-949-1706
Holland Marketing, Bloomington, MN 612-881-8425
Adams & Associates, Greensboro, NC 919-272-6838
Reptronics Inc., New Madison, OH 800-888-0530
Dick Belew Sales, Dallas, TX 214-644-7881
PRODUCTS: electret condenser, goosenecks, hand-held, push-to-talk, stands

Countryman Associates, Inc.

417 Stanford Ave., Redwood City, CA 94063
(415) 364-9988 (800) 669-1422 FAX: (415) 364-2794
President: Carl Countryman
Leslie's, Elgin, IL 708-697-6677
Edwards Company, Inc., Livonia, MI 313-458-7777
PRODUCTS: condenser, electret condenser, headset boom, goosenecks, instrumentation, miniature, podium, specialty

**Crown**

P.O. Box 1000
Elkhart, IN 46515
(219) 294-8000 (800) 535-6289 FAX: (219) 294-8329
President: Clyde Moore; Sales Manager: Jim Beattie; Marketing/Advertising: Gerry Barclay;
Division Head: Gill Nichols
Dobbs-Stanford, Dallas, TX 214-358-0800
Seabridge Audio, Huntington Bch., CA 714-848-3697
Sigmet, Freehold, NJ 908-462-1221
PCM Marketing, San Francisco, CA 415-935-0900
Bencsik Assoc., Ocala, FL 904-732-9775
Cambridge Marketing, Westerville, OH 614-363-9191
PRODUCTS: boundary, miniature, podium

CTI Audio, Inc.

Harbor & Jackson Streets
P.O. Box 120
Conneaut, OH 44030
(216) 593-1111 (800) 421-3161 FAX: (216) 593-5395
Commercial Product Manager: Tess Cunningham; CAD Sales Manager: Mike Ketchell; Communications Product Mgr.: Roxanne Meola; Director of Sales & Mkt'g: Bruce Forbes
Dick Bellew Sales, Dallas, TX 214-644-7881
C.P. Pores, Manhasset, NY 516-365-7810
Henry W. Phillips Co., Rosewell, CA 800-877-3070
Chuck Olson & Assoc., Renton, WA 206-271-5416
M.I.P.A., Lyons, CO 303-823-5101
J.B. Parent, Dublin, OH 614-764-0064
PRODUCTS: communications, condenser, dynamic, electret condenser, goosenecks, hand-held, miniature, podium, push-to-talk, stands

Dukane Corp.

2900 Dukane Drive
St. Charles, IL 60174
(708) 584-2300 FAX: (708) 584-2370
President/C.E.O.: J. McWilliams Stone Jr.; Pres./Comm. Systems Division: Steven L. Deppe; National Sales Director: Warren T. Anderson; Service Manager: Cliff Carlson
Wally Smutts, Toronto, ON 519-748-5352
Doug Fellabaum, Sycamore, IL 815-895-7573
Ken Lind, Boston, MA 617-235-6817
Pete Kendall, Jacksonville, FL 904-262-6025
Jim Lacey, Moreno Valley, CA 714-243-1160
Jack Brown, Dallas, TX 214-943-7528
Sanford Lange, Indianapolis, IN 317-251-3112
PRODUCTS: communications, dynamic, stands

Electro-Voice Inc.

600 Cecil Street
Buchanan, MI 49107
(616) 695-6831 (800) 827-6701 FAX: (616) 695-1304
President: Paul McGuire; Director of Marketing: Jim Long; Director of Sales: Garry Tempilin; Sales & Distribution Mgr.: Janine Masten; Director of Service/Rapair: Frank Spain; Public Relations Director: Keith Clark
Metropolis Audio Marketing Inc, New York, NY 908-225-0085
R.J. Marketing Ltd., Rockville, MD 301-251-0330
Ouzunoff & Associates, Yorktown Hts., NY 914-248-7888
Ron Tunks Sales Inc., Tamarac, FL 305-722-2803
Wilson Audio Sales, Nashville, TN 615-646-4477
Audio Resources, Westmont, IL 708-655-1180
B.C. Electronic Sales Inc., Shawnee, KS 913-962-1990
Jones Audio Sales, Plano, TX 214-618-2600
Excellence Marketing, Eden Prairie, MN 612-949-9011
C.L. Pugh and Associates Inc., Cleveland, OH 216-238-1777
Riley and Petchell Sales Inc., Detroit, MI 313-937-3000
Loppnow and Associates, Issaquah, WA 206-392-3936
Radon and Associates Inc., Sacramento, CA 916-923-2524
The Torbett/ Keiser Group Inc., Loveland, CO 303-669-1008
Western Audio, Burbank, CA 818-954-9300
Electro-Voice West, Visalia, CA 209-651-7777
PRODUCTS: communications, condenser, dynamic, electret condenser, goosenecks, hand-held, podium, push-to-talk, shotgun, specialty, stands

FOSTEX CORPORATION OF AMERICA

15431 Blackburn Ave.
Norwalk, CA 90650
(213) 921-1112 (800) 7-FOSTEX
FAX: (213) 802-1964
V.P. Marketing/ General Mgr.: Robert Veri; V.P. Sales: Mark Cohen
J.B. Parent, Dublin, OH 614-764-0064
PRODUCTS: ribbon, stereo

International Components Corp.

105 Maxess Road, Melville, NY 11747
(516) 293-1500 (800) 645-9154 FAX: (516) 293-4983
President: Mort Grossman; Executive Vice President: Irwin Friedman; Vice President: Fred Grossman; Eastern Regional Sales Mgr.: Ken Reed; Vice President: Harvey Grossman
C.B. Electronic Marketing, Arvada, CO 303-422-0561
PRODUCTS: electret condenser, hand-held

International Logistics Systems Inc

295 Cortlandt Street
P.O. Box 25
Belleville, NJ 07109
(201) 759-0007 FAX: (201) 759-8989
President: Carmine O. Pellosie; Vice President: Dar Hyatt
ADCOM, Toronto, ON 416-251-3355
PRODUCTS: condenser, contact pickups, electret condenser, hand-held, shotgun

J.W. DAVIS AND CO.

3030 Canton Street
Dallas, TX 75226
(214) 651-7341 (800) 527-5705 FAX: (214) 939-0328
President: Harvey Earp; Vice President, Sales: Jack W. Tucker; Chief Engineer: Eric Simonson
Multi-Technical Reps., Brainerd, MN 218-828-9483
PRODUCTS: communications, condenser, dynamic, electret condenser, goosenecks, hand-held, headset boom, miniature, podium, push-to-talk, stands

Knowles Electronics

3100 N. Mannheim Rd.
Franklin Park, IL 60131
(708) 455-3600

Larson Davis Laboratories

1681 W 820 N
Provo, UT 84601
(801) 375-0177 FAX: (801) 375-0182
Director Of Marketing: John Carey
Audio Etc., St. Peters, MO 314-278-4130
PRODUCTS: condenser

Lectrosonics, Inc.

P.O. Box 15900
Rio Rancho, NM 87174
(505) 892-4501 (800) 821-1121 FAX: (505) 892-6243
President: John Arasim; Vice President Engineering: Larry Fisher; Vice President Mktg & Sales: Bruce Jones
C.L. Pugh & Associates, Cleveland, OH 216-238-1777
PRODUCTS: electret condenser, headset boom

Milab

200 Sea Lane
Farmingdale, NY 11735
(516) 249-3660 FAX: (516) 420-1863
President: Jack Kelly; Sales Manager: Sam Spennacchio
Loomis and Associates, Fremont, CA 415-683-0883
PRODUCTS: boundary, condenser, dynamic

Miliphonics

155 Logan Mill Rd
Boulder, CO 80302
(303) 444-3167
Owner: Don Witte
Camden Marketing, Pierre Fonds, QU 514-683-3377

Neumann (USA)

6 Vista Drive, Old Lyme, CT 06371
(203) 434-5220 FAX: (203) 434-3148
President: Andrew Brakhan; Sales Manager: Jeff Alexander; Service Manager: Uwe Sattler
Jurgen Wahl, Van Nuys, CA 818-780-1229
Precide, Morbio Inferiore, Switzerland, 914-31734
PRODUCTS: boundary, condenser, hand-held, miniature, shotgun, stands, stereo

Panasonic Professional Audio Sys.

6550 Katella Avenue
Cypress, CA 90630
(714) 373-7278 FAX: (714) 373-7242
Nat. Sales & Marketing Mgr.: Steve Woolley; Marketing Manager: Chris Foreman; Western Regional Sales Mgr.: James Murray; Midwest Regional Sales Mgr.: Greg Braithwaite; Eastern Regional Sales Mgr.: Carla Campbell; Telemarketing Sales Mgr.: Lynn Thompson
James Murray, Cypress, CA 714-373-7389
Greg Braithwaite, Arlington, IL 708-981-7329
Carla Campbell, Norristown, PA 215-630-1651
Cambridge Marketing, Westerville, OH 614-363-9191
PRODUCTS: condenser, miniature

Paso Sound Products, Inc.

14 First Street
Pelham, NY 10803
(914) 738-4800 (800) 231-3034 FAX: (914) 738-3954
Executive Vice President: Paul Mastrangelo; Product Manager: Ken O'Brien; Credit Manager: Marilyn Beckerson; Operations Manager: Anthony Squeglla
Anderson Sales, Braintree, MA 617-848-9194
Jack Mesnick Sales, Liverpool, NY 315-622-3211
Palmleri Associates, Fairfield, NJ 201-882-1266
Weller Electronic Sales, Inc., Worthington, OH 614-885-7819
Llenau Associates, Columbia, MD 301-621-4113
MJA Marketing, St. Charles, MO 314-447-7111
Northland Assoc., Moorehead, MN 218-233-4616
Allwest Sound & Communication, Camarillo, CA 805-388-7745
Dimension Pt. IX Marketing, Katy, TX 713-578-9277
Mountain Representatives, Denver, CO 303-333-7745
Miguel Lopez, Haleah, FL 305-822-6853
Paco Electronics, Ltd., Markham, ON 416-475-0740
Robert Miisk Co., Southfield, MI 313-354-3310
Marketline Inc., Snelville, CA 404-972-9048
Hawkins-Frederickson Assoc., Maitland, FL 407-831-2474
Lintern Associates, Naperville, IL 708-904-1225
Robert Miisk Co., Indianapolis, IN 317-842-3400
PRODUCTS: communications, condenser, dynamic, electret condenser, goosenecks, hand-held, podium, push-to-talk, stands

PEAVEY ELECTRONICS CORP.

711 A Street
P.O. Box 2898, Meridian, MS 39301
(601) 483-5365 FAX: (601) 484-4278
CEO: Hartley Peavey; President: Mella Peavey
Dimension/ Point IX, Lewisville, TX 214-436-3706
PRODUCTS: boundary, communications, condenser, contact pickups, dynamic, electret condenser, goosenecks, hand-held, headset boom, instrumentation, miniature, podium, stands, stereo



Introducing
The Shure
SM102.
Now The
Choice Is
Black And White.

The new Shure Microflex™ SM102 makes the job of choosing a miniature condenser microphone an effortless one.

With its flexible, 6-inch gooseneck, the SM102 is easy to set up and aim. And its high sensitivity and smooth frequency response assure a clear and natural sound.

Compare directional characteristics. You'll find the SM102's cardioid polar pattern exceptionally uniform throughout its frequency range, which accounts for its outstanding background noise and feedback rejection. What's more, it has the lowest self-noise in its class, so you pick up distant voices down to a near-whisper

and assure the intelligibility of every word.

And with a choice of in-line or wall plate preamps, both with switchable gain, the SM102 gives you the unmatched flexibility to hang it any way, anywhere.

In fact, the toughest decision you need to make is black or white. Take your pick.

The SM102 is a proud member of the new Shure Microflex family of miniature condenser microphones. For more information on the SM102 or other Shure Microflex products, call 1-800-25-SHURE. The Sound of the Professionals ... Worldwide.

SHURE[®]
microflex[™]

Circle 201 on Reader Response Card

Posthorn Recordings

142 W. 26th St.
New York, NY 10001
(212) 242-3737 FAX: (212) 924-1243
Owner-President: Jerry Bruck; Public Relations:
Louise A. Bloomfield; Service Manager: Michael
P. Hesse

Ronald Streicher, Monrovia, CA 818-359-8012
Camden Marketing, Pierre Fonds, QU 514-683-
3377
PRODUCTS: boundary, condenser, electret
condenser, goosenecks, hand-held, miniature,
podium, shotgun, specialty, stands, stereo

REVERE INDUSTRIES

1101 Blenville St., New Orleans, LA 70112
(504) 523-3503 (800) 843-8321 FAX: (504) 525-6361
Vice President Mktg./Sales: Richard Harris
Camden Marketing, Pierre Fonds, QU 514-683-
3377
PRODUCTS: carbon, communications, condenser,
contact pickups, dynamic, goosenecks, hand-
held, headset boom, miniature, push-to-talk,
shotgun, specialty, stands, stereo

**Sanken Microphone/Developing
Tech.**

1032 N. Sycamore Avenue
Los Angeles, CA 90038
(213) 469-4773 FAX: (213) 962-2603
Director of Sales: Jim Schaller; Vice President:
Jim Pace
Karp Communications, Tampa, FL 813-968-7098
PRODUCTS: condenser, electret condenser

Sennheiser Electronic Corp.

6 Vista Drive
P.O. Box 987, Old Lyme, CT 06371
(203) 434-9190 FAX: (203) 434-1759
President: Andrew Brakhan; Pro Products
Manager: Albert C. Zang Jr.
MJA Marketing, St. Charles, MO 314-447-7111
PRODUCTS: communications, condenser,
dynamic, electret condenser, hand-held, headset
boom, miniature, podium, shotgun, stands

Shogyo International Corp.

287 Northern Boulevard, Great Neck, NY 11021
(516) 466-0911 FAX: (516) 466-0922
President: Mark A. Rubin; Vice President:
Howard Rubin
Karp Communications, Tampa, FL 813-968-7098
PRODUCTS: electret condenser

SHURE BROTHERS, INC.

222 Hartrey Avenue
Evanston, IL 60202-3696
(708) 866-2200 (800) 257-4873 FAX: (708) 866-2279
President: James H. Kogen; Vice Pres, Finance &
Sales: Robert Gilbert; Vice President, Sales:
Lottie Morgan; Director, Technical Markets: John
Phean; Director Microphone Products: Sandy
Schroeder; Dir., Mktg. Communications: Nancy
Calvert
Audio Blz, Mundelein, IL 708-949-0280
PCM Marketing, Walnut Creek, CA 415-935-0900
Peter E. Schmitt Company, Inc., Leonia, NJ
201-944-2806
Millar Electronics, Inc., Atlanta, GA 404-634-3350
Pro Tech Marketing, Midvale, UT 801-561-8844
Karp Communications, Tampa, FL 813-968-7098

**Sony Corp./Business & Pro. Aud.
Grp**

3 Paragon Drive
Montvale, NJ 07645-1735
(201) 930-1000
President, Sales & Marketing: Mark Gray; Senior
VP Sales: C.F. Taylor; V.P. Product Marketing:
Anthony Gargano; Marketing Manager, Pro
Audio: Courtney Spencer; Sales Manager, Pro
Audio: Gary Rose; V.P. Audio Products: Ron
Remschel
Matt Robertson, Western Dist., 213-469-9084
Audio Etc., St. Peters, MO 314-278-4130
PRODUCTS: dynamic, electret condenser,
goosenecks, hand-held, podium, ribbon,
shotgun, specialty, stereo

Stanley Hirsch Associates Inc.

5 Locust Place
Sea Cliff, NY 11579
(516) 674-8330
President: Stanley Hirsch
Sunrise Sales Company, LaMolle, IL 815-638-2660
PRODUCTS: goosenecks

TELEX COMMUNICATIONS, INC.

9600 Aldrich Avenue South
Minneapolis, MN 55420
(612) 884-4051 FAX: (612) 884-0043
President: Jeffrey Wetherell; Vice President
Marketing: John Schofield; Vice President Sales:
Dan Dantzier; Director of Marketing: Don
Mereen; Manager/Advertising & Mkt'g: Ron
Taylor
WestTech Marketing, Culver City, CA 213-870-9286
Bencsik Associates, Ocala, FL 904-732-9775
Burcaw Company & Associates, Warren, MI
313-573-4605
SAGA, Oswego, NY 315-343-5739
Monfort Electronic Marketing, Indianapolis, IN
317-872-8877
Murphy & Cotta, Inc., Atlanta, GA 404-875-2525
Northland Associates, Moorhead, MN
218-233-4616
Rancilio Associates, Inc., St. Louis, MO
314-845-0202
J.Y. Schoonmaker Company, Dallas, TX
214-349-1650
Sigmet Corporation, Valley Forge, PA
215-783-6666
Weller Electronic Sales, Worthington, OH
614-885-7819
Ziskind Associates, Rolling Meadows, IL
312-577-1624
White Radio Ltd., Burlington, ON 416-632-6894
Silver Peak Marketing, Denver, CO 303-467-9042
PacNor Marketing, Lynnwood, WA 206-771-6016
PRODUCTS: communications, condenser,
dynamic, electret condenser, goosenecks, hand-
held, headset boom, instrumentation, miniature,
podium, push-to-talk

The Music People, Inc.

2074 Park St.
Hartford, CT 06106
(203) 236-7134 (800) 289-8889 FAX: (203) 233-6888
President: James R. Hennessey; Controller:
John Gutowski; Import/Export Manager: Kelly
Helntz; Purchasing Manager: Paul Thaxton
West Coast Warehouse Facility, Los Angeles, CA
PRODUCTS: boundary, communications,
condenser, dynamic, electret condenser,
goosenecks, hand-held, headset boom,
instrumentation, miniature, podium, push-to-
talk, shotgun, specialty, stands, stereo

**How
To Mic
Your
Piano!****C-Ducer****C-P SERIES**

Preferred By More Professionals

Models also available for:
Guitar, Harp, Bass, Violin,
Mandolin and Dulcimer.

Contact Your Dealer or
Call 800 C-T AUDIO

**The Source for
the Latest
Information on
Models, Prices,
Specs.****THE
MUSIC
&
SOUND
BUYER'S
GUIDE****ORDER YOUR
1991 COPY NOW!**

For each copy send \$7.95 plus
\$2.00 postage and handling.

**THE MUSIC & SOUND
BUYER'S GUIDE**

25 Willowdale Ave.,
Port Washington, NY 11050

Attn: Arturo Lizarraga

Circle 279 on Reader Response Card

We've added a whole new twist to our LM microphones.

Crown introduces a new low-profile addition to our series of lectern microphones, the LM-300. Like our other lectern microphones, the LM-300 is aesthetically pleasing and unobtrusive.



A low-frequency roll-off switch reduces low-frequency rumble.

It's built for years of trouble-free use. It installs quickly and easily. And, like our other LM mics, it gives you beautiful, natural sound with superior gain-before-

feedback. But there's a twist. Literally.

The new LM-300 adds a noiseless gooseneck section for more flexible microphone positioning. Now, you can place the microphone exactly where you want

A noiseless gooseneck improves the positioning capabilities of the LM-300.

it without worrying where it might wander off to.

But we didn't stop there.

Along with the new gooseneck, we've provided additional mounting options: a standard 3-pin XLR panel connector, or the accessory *lockable* shock mount for reduced mechanical noise and theft prevention. We've also improved the already excellent characteristics of the microphone element. You'll enjoy smooth, wide-range frequency response, better control of ambience and



Optional lockable shock mount for the LM-300 reduces mechanical noise.

higher output. A new low-frequency roll-off switch helps reduce low-frequency rumble and "P-popping". Couple this with superior RF suppression and 12-48 V phantom powering and you'll find the LM series

perfect for all your lectern mic-ing problems.

Like all Crown microphones, the LM series carries a full three-year unconditional warranty against malfunction with a lifetime warranty on the acoustic system.

For more information on our complete line of microphones, see your Crown dealer or call toll-free: 1-800-535-6289.

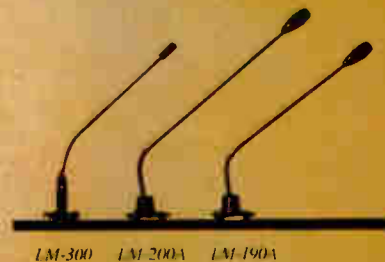

crown
Guaranteed Excellence

Made in U.S.A. Exported by Amcron
P.O. Box 1000 • Elkhart, IN 46515-1000

* See your Crown dealer for full warranty details.

The easy way to install the unique sound of UniPoint®...

New AT853PMa
cardioid condenser
with wall plate mount

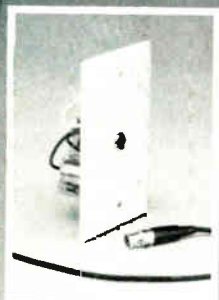

also available in white
as AT853PMWa

"The great sound
of the AT853a mike
has been enhanced
by the ease of installation of the
new AT853PMa plate mount!"

— Stephen Minozzi

Monte Brothers, Inc., Dobbs Ferry, NY

For further information write or call us today.

 **audio-technica.**

Audio-Technica U.S., Inc.
1221 Commerce Drive, Stow, OH 44224
(216) 686-2600 • FAX (216) 688-3752

The Sandell Company

24808 Aden Ave.
Newhall, CA 91321
(805) 259-0108 FAX: (805) 259-0108
President: Robert W. Sandell; Executive Vice
President: Cynthia P. Sandell; Vice President,
Operations: Lillian R. Cory
Camden Marketing, Pierre Fonds, QU 514-683-
3377
PRODUCTS: windscreens

TOA ELECTRONICS, INC.

601 Gateway Blvd. Suite 300
P.O. Box 2047
S San Francisco, CA 94080
(415) 588-2538 (800) 733-4750 FAX: (415) 588-3349
President: Yoshiro Ishida; Director, Audio
Products Div.: Richard Krochmal; Director,
Comm. Systems Div.: Al Burns; Mgr., Marketing
Development: Jeff Pallin; Manager, Western
Division: Bill Ford; Manager Engineering
Services: Bob Sweet
Chuck McGregor- Product Consit, Morris Plains,
NJ 201-829-7047
John Murray-Eng.Snd. Mktg. Dev, Springfield, OH
513-324-1993
Bob Hager-Eastern Regional Mgr, Rosewell, GA
404-552-7624
Linda Wick-Central Reg. Mgr., Kansas City, MO
816-453-5775
Robert Slaughter-Cntrl Div Mgr, Houston, TX 713-
460-3678
Pete Newmark-West Regional Mgr., Mesa, AZ
602-981-0050
Walter Best, Eastern Reg. Mgr., Sussex, NJ 201-
702-0068
PRODUCTS: communications, dynamic, electret
condenser, hand-held, push-to-talk

TSI (Tamco Systems Inc.)

393 Jericho Turnpike
Mineola, NY 11501
(516) 294-5390 (800) 628-2084 FAX: (516) 294-5008
CEO: Mario Maltese; President: Garani
Srinivasan; President (Spec. Prod. Div.): Richard
Stillwell; Sales Coordinator: Denise Matejka;
Marketing Manager: Karen Pepe
JMS Marketing, Austin, TX 512-266-1113
PRODUCTS: boundary, goosenecks, specialty

UNIVERSITY SOUND INC.

13278 Rolston Avenue
Sylmar, CA 91342
(818) 362-9516 FAX: (818) 367-5292
President: Robert Sandell; Controller: Mary
Coco; National Sales Manager: Greg McLagan;
Design Engineer: Ken Koceski
Jim Burger, Philadelphia, PA 203-297-7160
PRODUCTS: communications, condenser,
electret condenser, goosenecks, hand-held,
miniature, podlum, push-to-talk

Wright Microphones

2093 Faulkner Rd. N.E.
Atlanta, GA 30324
(404) 321-3886

YAMAHA CORP. OF AMERICA

6600 Orangethorpe Ave.
Buena Park, CA 90620
(714) 522-9011 FAX: (714) 739-2680
Sales & Marketing Manager: Gerald W. Tschetter;
Pro Digital Sls & Mktg Mgr.: Peter Chalkin;
Market Support Manager: Don Bowles
Precide, Morbio Inferiore, Switzerland, 914-
31734
PRODUCTS: dynamic, hand-held

MIDI

Akal/IMC

1316 E. Lancaster
Ft. Worth, TX 76102
(817) 336-5114 FAX: (817) 870-1271
President: Tommy Moore; Vice President, Akal
Div.: Woody Moran; Credit Manager: Bob
Sanford; Product Specialist: James Martin
John Chez, Ringos, NJ 908-788-5151
Grendal Hanks, Lake Forest, CA 714-229-6053
Jerry Sehl, Ft. Lauderdale, FL 305-525-0872
Bill Thompson, Lake Villa, IL 708-356-8818

Alesis

3630 Holdrege Avenue
Los Angeles, CA 90016
(213) 467-8000 (800) 5-ALESIS FAX: (213) 836-9192
President, COO: Russell Palmer; V.P. Sales and
Marketing: Ralph Goldhelm; V.P. Advertising &
Promotion: Allen Wald; Regional Sales Manager:
Ted Keffalo; Regional Sales Manager: Doug
White
Cambridge Marketing, Westerville, OH 614-363-
9191
PRODUCTS: hardware, signal processing

AMX Corporation

12056 Forestgate Drive
Dallas, TX 75243
(214) 644-3048 (800) 222-0193 FAX: (214) 907-2053
President: Scott Miller; Vice President of Sales:
William V. Anderson; Executive Vice President:
Art Chace; International Sales Manager: Ken
Sciater; Director of Marketing: Eric Johansen
Franklin Communications, Maple Glen, PA 215-
643-3031
Visitech Marketing Assoc., Elburn, IL 708-365-9600
KBZ Communications, Furlong, PA 215-348-9481
Westech Marketing, Culver City, CA 213-870-9286
Total Marketing, Ft. Worth, TX 817-560-3970
Karp Communications, Tampa, FL 813-960-7667
Richard Krudop, Andalusia, AL 205-222-8950
Pancor Marketing, Lynnwood, WA 206-771-6016
PRODUCTS: system controllers

Aphex Systems

11068 Randall Street
Sun Valley, CA 91352
(818) 767-2929 FAX: (818) 767-2641
President: Marvin Caesar; Vice President: Hugh
Wilcox; Sales Manager: Paul Freudenberg
Gould Marketing, Inc., Montreal, Quebec, 514-
342-4441
Clueco Pro Division, Paris, France, 331-43596159
AKG Acoustics, Munich, Germany, 498-9 87 160
Otaritec Corporation, Tokyo, Japan, 813-392-
7811
Sound Technology, Letchworth, UK 444-62480800
Nova Marketing, San Francisco, CA 415-952-0943
PRODUCTS: hardware, software, system
controllers

MIDI

Conquest Sound, Inc.

26113 S. Ridgeland Ave.
P.O. Box 268
Monee, IL 60449
(708) 534-0390 (800) 323-7671 FAX: (708) 534-0398
President: Bob Jares Jr.; Vice President: Larry Spalla; General Manager: Janet Jares;
Operations Manager: Deborah Hawtree; Sales: Ed Knecht; Sales: Sally Artman
Gary Castelluccio & Assoc., Clifton, NJ 800-888-1899
AMH Sales, Inc., Torrance, CA 213-373-2034
RS Enterprises, Redmond, WA 206-883-1482
Midwest Audio Marketing, Crete, IL 708-672-3056
AMH Sales, Northglenn, CO 303-465-5967
C.L. Pugh & Associates, Cleveland, OH 216-238-1777
PRODUCTS: cable

COVOX

675 D Conger St.
Eugene, OR 97402
(503) 342-1271

Digital Music Corp.

5312-J Derry Avenue
Agoura Hills, CA 91301
(818) 991-3881 FAX: (818) 991-4185
Vice President: Gene Barkin
Western Audio, Burbank, CA 818-954-9300
Applied Audio Marketing, Ashville, NC 704-252-9313
Worldwide Electronics, Fort Lauderdale, FL 904-287-7666
R.J. Marketing, Rockville, MD 301-251-0330
Audio Resources, Westmont, IL 708-655-1180
Cambridge Marketing, Westerville, OH 614-363-9191
PRODUCTS: hardware, signal processing, system controllers

FOSTEX CORPORATION OF AMERICA

15431 Blackburn Ave.
Norwalk, CA 90650
(213) 921-1112 (800) 7-FOSTEX FAX: (213) 802-1964
V.P. Marketing/ General Mgr.: Robert Veri; V.P. Sales: Mark Cohen
J.B. Parent, Dublin, OH 614-764-0064
PRODUCTS: hardware, software

Lone Wolf

1509 Aviation Boulevard
Redondo Beach, CA 90278
(213) 379-2036 FAX: (213) 374-2496
President: Mark Lacas; CEO: Andy Sargent; Dir. of Sales and Marketing: Shannon Casey; Sales Manager: Perry Cella; Vice President R & D: David Warman
Audio Etc., St. Peters, MO 314-278-4130
PRODUCTS: system controllers

PEAVEY ELECTRONICS CORP.

711 A Street
P.O. Box 2898
Meridian, MS 39301
(601) 483-5365 FAX: (601) 484-4278
CEO: Hartley Peavey; President: Mella Peavey
Dimension/ Point IX, Lewisville, TX 214-436-3706
PRODUCTS: cable, hardware, signal processing

Want more information on **SOUND** COMMUNICATIONS Advertisers?

JUST FILL OUT THE

FAST ACTION CARD



Circle the reader service number
you'll find on the ad and
mail by 12/1/91

— OR —

Call the Company today...
And when you call, say
you saw it in the
BLUE BOOK!

Rane Corp.

10802 47th Avenue West
Mukilteo, WA 98275-5098
(206) 355-6000

President: Steve Brakken; CEO: Linda Arink; V.P. of Manufacturing: Rick Bernard; V.P. of R & D: Dennis Bohn; V.P. of Marketing: Larry Winter; National Sales Manager: Ray Bloom
Larry Schirmer, Pontiac, MI 313-340-9588
PRODUCTS: signal processing

Sound Advice

P.O. Box 278
Cazadero, CA 95421
(707) 632-5911

STUDIOMASTER INC.

3941 Miraloma Avenue
Anaheim, CA 91719
(714) 524-2227 FAX: (714) 524-5096
President: Paul Reeve; National Sales Manager: Jim Giordano
J.B. Parent, Dublin, OH 614-764-0064
PRODUCTS: hardware, signal processing



**MIXERS &
MIXING
CONSOLES**

ADM Technology

1626 E. Big Beaver Rd.
Troy, MI 48084
(313) 524-2100
J.B. Parent, Dublin, OH 614-764-0064

Advantage

14270 NW Science Pk Dr.
Portland, OR 97229
(503) 641-7287 FAX: (503) 622-0281
J.B. Parent, Dublin, OH 614-764-0064

AFA/Martin Pro Audio Group

100 Stonehurst Ct.
Northvale, NJ 07647
(201) 767-1200 (800) 352-5598 FAX: (201) 784-8637
Director of Sales: Mike Bogen; Sales Manager: David Belline; Field Representative: Phil Cella
Loomis and Associates, Fremont, CA 415-683-0883
PRODUCTS: broadcast, computer controlled, digital, ENG, microprocessor, production, rack-mount, recording, theatrical, VCA

Alesis

3630 Holdrege Avenue
Los Angeles, CA 90016
(213) 467-8000 (800) 5-ALESIS FAX: (213) 836-9192
President, COO: Russell Palmer; V.P. Sales and Marketing: Ralph Goldheim; V.P. Advertising & Promotion: Allen Wald; Regional Sales Manager: Ted Keffalo; Regional Sales Manager: Doug White
Cambridge Marketing, Westerville, OH
614-363-9191
PRODUCTS: production, recording

Allen and Heath

5 Connlar Road
Orange, CT 06477
(203) 795-3594 FAX: (203) 795-6814
Nova Marketing, San Francisco, CA 415-952-0943
PRODUCTS: portable, production, rack-mount, recording

Altec Lansing Corp.

10500 W. Reno
Oklahoma City, OK 73128
(405) 324-5311 FAX: (405) 324-8981
President: Dave Merrey; Vice President, Sis. & Mktg: Chuck Lange; National Sales Manager: Jerry Spriggs; Manager Export Marketing: John Sexton; Technical Services Manager: Gary Jones; Customer Services Manager: Jim Brown
Dave Read, McKinney, TX 214-542-6328
Jim Faber, Shreveport, LA 318-631-1766
Paul Froula, Lombard, IL 708-268-1831
Alan Feckanin, Port St. Lucie, FL 407-879-1078
George Solti, Philadelphia, PA 215-637-3429
Larry Schirmer, Pontiac, MI 313-340-9588
Stu Moffit, Renton, WA 206-277-8851
PRODUCTS: automatic, rack-mount, recording

AMEK/TAC U.S. Operations

10815 Burbank Boulevard
N. Hollywood, CA 91601
(818) 508-9788 FAX: (818) 508-8619
Operations Manager: Sue Jones; National Sales Manager: Steve Harvey; National Service Manager: Ray Dilfield; Sales Manager: Ed Bigger; Service Engineer: Dennis Goettsch; Administrative Assistant: Lisa Kennedy
Bedford Audio Marketing, Atlanta, GA 404-636-0070
The Henderson Company, Concord, MA 508-287-0020
Marketing Concepts, Irving, TX 214-869-0069
Sigmet, Freehold, NJ 201-462-1221
J.B. Parent, Dublin, OH 614-764-0064
Nova Marketing, San Francisco, CA 415-952-0943
PRODUCTS: broadcast, computer controlled, custom, ENG, MIDI, modular, monitor, portable, production, rack-mount, recording, theatrical, VCA

API Audio Products Inc.

7951 Twist Lane
Springfield, VA 22153
(703) 455-8188 FAX: (703) 455-4240
President: Paul Wolff; Vice President-Operations: Kevin Raynor; Director of Finance: Artt Svrjcek; Electronic Assembler: Darrin Ward; Electronic Assembler: Dave Yacuoby; Wiring/Electronics: Jeff Lolmaugh
Studio Consultants, New York, NY 212-586-7376
Westlake Audio, Los Angeles, CA 213-851-9800
Harris Audio, Miami, FL 305-944-3444
Leo's Pro Audio, San Francisco, CA 415-652-1553
Pan Technical Sales, London, UK 01-247-6101
Sound Sales, Inc., Columbia, MD 301-964-1170
PRODUCTS: automatic, broadcast, compressor/leveler, computer controlled, custom, rack-mount, recording, theatrical

ASHLY**Ashly Audio, Inc.**

100 Fernwood Ave.
Rochester, NY 14621
(716) 544-5191 (800) 828-6308 FAX: (716) 266-4584
President: Bill Thompson; Senior Vice President: Bob French; Vice President: Dave Malloy; Operations Manager: Ellen Price
ADCOM, Toronto, ON 416-251-3355
PRODUCTS: broadcast, portable, powered, rack-mount, recording, theatrical

ATI-Audio Technologies Inc.

328 W. Maple Avenue
Horsham, PA 19044
(215) 443-0330 FAX: (215) 443-0394
President: Samuel B. Wenzel; Vice President: Edward M. Mullin
PRODUCTS: broadcast, compressor/leveler, VCA

Audio Systems Co.

1815 Michigan Ave.
Bismarck, ND 58504
(701) 223-3800 (800) 852-6522 FAX: (701) 222-8102
President: Lynn Mader; Vice President: Lyle Mader
Leslie Inc., Elgin, IL 708-697-6677
Doug Warren, Newport News, VA 804-930-3217
PRODUCTS: automatic, computer controlled, custom, microprocessor, paging, rack-mount, VCA

Audio Teknology Inc.

7556 SW Bridgeport Rd.
Portland, OR 97224
(503) 624-0405 FAX: (503) 624-0194
President/CEO: Chris Strahm; Vice President: Larry Droppa; Financial Manager: Vickie Sheppard; Marketing Manager: Vance Dickason
Doug Warren, Newport News, VA 804-930-3217
PRODUCTS: compressor/leveler, gated, monitor, portable, theatrical, VCA

AUDIO-TECHNICA U.S., INC.

1221 Commerce Drive
Stow, OH 44224
(216) 686-2600 FAX: (216) 688-0719
Vice President, Marketing: Ken Reichel; National Marketing Manager: Earl "Buzz" Goodwin; National Sales Manager: Garry Elliott; Inside Sales: Tony O'Keefe; Sales Coordinator: Kim Wallace
Nova Marketing, San Francisco, CA 415-952-0943
PRODUCTS: disco, ENG, portable

Audiotronics, Inc.

3750 Old Getwell Rd.
Memphis, TN 38118
(901) 362-1350 FAX: (901) 365-8629
President: William S. Sage; Director of Sales: Murray A. Shields; Engineering Manager: Jeff Paullus
Doug Warren, Newport News, VA 804-930-3217
PRODUCTS: broadcast

Autogram Corporation

1500 Capital Avenue
P.O. Box 456
Plano, TX 75074
(214) 424-8585 (800) 327-6901 FAX: (214) 423-4465
President: Ernest T. Ankele Jr.
PRODUCTS: broadcast

AV Systems Engineering Pty. Ltd.

28 Doonan Road, P.O. Box 192
Nedlands
W. AUSTRALIA, 6009
(619) 389-8105 FAX: (619) 389-8149
Managing Director: Phillip Jenkins
RCS, New Milford, NJ 201-261-5560
Total Marketing, Fort Worth, TX 817-560-3970
Winchester, Atlanta, GA 404-392-0200
Loomis & Associates, Riverside, CA 714-780-9477
Sound Sales, Inc., Columbia, MD 301-964-1170
PRODUCTS: computer controlled, custom,
microprocessor, modular, rack-mount

Blamp Systems

14270 NW Science Park Drive
Portland, OR 97229
(503) 641-7287 (800) 826-1457 FAX: (503) 626-0281
National Sales Manager: Ron Camden; President:
Ralph Lockhart; Vice President Finance: Jerry
Payette
Nova Marketing, San Francisco, CA 415-952-0943

Bogen Communications, Inc.

50 Spring Street
P.O. Box 575
Ramsey, NJ 07446
(201) 934-8500 FAX: (201) 934-9832
President: John H. Ochtera; Vice President, Sales
& Mktg: David A. Chambers
Scott Whipple, Columbus, OH 614-272-1689
Sam Blasi, Ramsey, NJ 201-934-8500
Walter Spencer, Ramsey, NJ 201-934-8500
Fred Yosnick, Woodland, CA 916-668-6311
Edwards Company, Inc., Livonia, MI 313-458-7777
PRODUCTS: modular, paging, rack-mount

Broadcast Audio

11306 Sunco Dr.
Rancho Cordova, CA 95670
(916) 635-1048 FAX: (916) 638-5012

Broadcast Electronics

4100 N. 24th St.
Quincy, IL 62305
(217) 224-9600 FAX: (217) 224-9607

Broadcast Equipment Sales

119 S. Oak St. Suite C
Raymond, MS 39154
(601) 857-8573 FAX: (601) 857-2346
President: Jeffery Corkren; Vice President: Bob
Bule; Director of Engineering: Tim Waltman;
Credit Manager: David T. Herring; Building
Maintenance: Flade Kinade
C.L. Pugh & Associates, Cleveland, OH 216-238-
1777

CADD Creative Audio Design & Dev.

1875 D Panama St.
Brossard, Que., J4W 2S8
(514) 466-1691 FAX: (514) 672-3399

D & R USA

1720 Chip N Dale Dr.
Arlington, TX 76012
(817) 548-1677 FAX: (817) 277-6066

Dan Dugan Sound Design

290 Napoleon St.
San Francisco, CA 94124
(415) 821-9776 FAX: (415) 826-7699
Proprietor: Dan Dugan
Doug Warren, Newport News, VA 804-930-3217
PRODUCTS: automatic

DAX

10240A NE Marx St.
Portland, OR 97220
(503) 252-4783 FAX: (503) 252-5338
Audio Etc., St. Peters, MO 314-278-4130

DDA

200 Sea Lane
Farmlandale, NY 11735
(516) 249-3660 FAX: (516) 420-1863
President: Jack Kelly; Sales Manager: Sam
Spennacchio; Product Sales Specialist: Chris L.
Fichera
Edwards Company, Inc., Livonia, MI 313-458-7777
PRODUCTS: automatic, compressor/leveler,
custom, ENG

Dukane Corp.

2900 Dukane Drive
St. Charles, IL 60174
(708) 584-2300 FAX: (708) 584-2370
President/C.E.O.: J. McWilliams Stone Jr.;
Pres./Comm. Systems Division: Steven L. Deppe;
National Sales Director: Warren T. Anderson;
Service Manager: Cliff Carlson
Wally Smutts, Toronto, ON 519-748-5352
Doug Fellabaum, Sycamore, IL 815-895-7573
Ken Lind, Boston, MA 617-235-6817
Pete Kendall, Jacksonville, FL 904-262-6025
Jim Lacey, Moreno Valley, CA 714-243-1160
Jack Brown, Dallas, TX 214-943-7528
Sanford Lange, Indianapolis, IN 317-251-3112
PRODUCTS: compressor/leveler, paging, rack-
mount

Ecler/TEI Electronics

570 W. 18 Street
P.O. Box 246
Hialeah, FL 33010
(305) 888-3980 (800) 327-8811 FAX: (305) 885-4950
President: Danny Alonso; Vice President: Mireya
A. Muniz; National Sales Manager: Walter
McNulty; Sales: Orlando Pineda; Sales: Jose
Hurcades; Customer Service: John Tembras
Greg Dzubay & Assoc., Glendale, AZ 800-999-0006
PRODUCTS: custom, production, rack-mount,
recording

EDCOR ELECTRONICS

7130 National Parks Hwy
P.O. Box 5098
Carlsbad, NM 88220
(505) 887-6790 (800) 854-0259 FAX: (505) 887-6880
Sales: P. Weston; Engineering: Brian Weston
Greg Dzubay & Assoc., Glendale, AZ 800-999-0006
PRODUCTS: automatic, broadcast, gated, paging,
rack-mount

Electro-Voice Inc.

600 Cecil Street
Buchanan, MI 49107
(616) 695-6831 (800) 827-6701 FAX: (616) 695-1304
President: Paul McGulre; Director of Marketing:
Jim Long; Director of Sales: Garry Tempilin; Sales
& Distribution Mgr.: Janine Masten; Director of
Service/Rapair: Frank Spain; Public Relations
Director: Keith Clark
Metropolis Audio Marketing Inc, New York, NY
908-225-0085
R.J. Marketing Ltd., Rockville, MD 301-251-0330

Ouzunoff & Associates, Yorktown Hts., NY 914-
248-7888

Ron Tunks Sales Inc., Tamarac, FL 305-722-2803
Wilson Audio Sales, Nashville, TN 615-646-4477
Audio Resources, Westmont, IL 708-655-1180
B.C. Electronic Sales Inc., Shawnee, KS 913-962-
1990

Jones Audio Sales, Plano, TX 214-618-2600
Excellence Marketing, Eden Prairie, MN 612-949-
9011

C.L. Pugh and Associates Inc., Cleveland, OH 216-
238-1777

Riley and Petchell Sales Inc., Detroit, MI 313-937-
3000

Loppnow and Associates, Issaquah, WA 206-392-
3936

Radon and Associates Inc., Sacramento, CA 916-
923-2524

The Torbett/ Keiser Group Inc., Loveland, CO 303-
669-1008

Western Audio, Burbank, CA 818-954-9300
Electro-Voice West, Visalia, CA 209-651-7777
PRODUCTS: automatic, ENG, portable, powered,
rack-mount, recording, theatrical

FOSTEX CORPORATION OF AMERICA

15431 Blackburn Ave.
Norwalk, CA 90650
(213) 921-1112 (800) 7-FOSTEX FAX: (213) 802-
1964
V.P. Marketing/ General Mgr.: Robert Veri; V.P.
Sales: Mark Cohen
J.B. Parent, Dublin, OH 614-764-0064
PRODUCTS: rack-mount, recording

Graham-Patten Systems, Inc.

P.O. Box 1960
Grass Valley, CA 95945
(916) 273-8412 (800) 547-2489 FAX: (916) 273-7458
V.P. Sales and Marketing: Tim Prouty
J.B. Parent, Dublin, OH 614-764-0064
PRODUCTS: automatic, digital, microprocessor,
rack-mount, VCA

Hill Audio/IMC

1316 E. Lancaster
Fort Worth, TX 76102
(817) 336-5114 FAX: (817) 870-1271
CEO: Tommy Moore; CFO: Jay McKim; Vice
President- Electronics: Tom Linklater; Product
Specialist: Ramon West; National Service
Manager: Ben Cano
ADCOM, Toronto, ON 416-251-3355
PRODUCTS: broadcast, combo, custom, modular,
monitor, portable, production, rack-mount,
recording, theatrical

Hosa Technology Inc./Phonic

6910 E. 8th St.
Buena Park, CA 90620
(714) 522-5675 (800) 255-7527 FAX: (714) 522-4540
President: Sho Sato; General Manager,
Sales/Mktg.: Lee Watkins; Sales Coordinator:
Vanessa Cooper
Marshall Sales, Los Angeles, CA 213-670-7071
PCM Marketing, Walnut Creek, CA 415-935-0900
Sound Marketing, Palos Park, IL 214-869-0669
Audio Associates, Verona, NJ 201-239-3727
Applied Audio, Asheville, NC 704-658-2291
Cambridge Marketing, Westerville, OH 614-363-
9191
PRODUCTS: combo, disc, monitor, portable,
powered, rack-mount

Howe Technologies

2300 Central Ave., Ste. E
Boulder, CO 80301
(303) 444-4693 FAX: (303) 444-8447

**INNOVATIVE ELECTRONIC
DESIGNS, INC.**

9701 Taylorsville Rd.
Louisville, KY 40299
(502) 267-7436 FAX: (502) 267-9070
President: Hardy Martin; Vice President, Mkt'g &
Sales: Tom Roseberry; Sales Application
Engineer: Mark Lewellyn; V.P. Research &
Development: Bob Ponto; Vice President,
Engineering: Ed Young; Vice President,
Software: John Johnson

Yore Company, White Bear Lake, MN 612-770-9760
Steffey Marketing Assoc. Inc., Northbrook, IL
708-480-3575
WesTech Marketing, Culver City, CA 213-870-9286
Repworks, Chicopee, MA 413-533-0845
Darmstedter Associates, Baldwinsville, NY
315-638-1261
John Anthony, Stamford, CT 203-322-9202
Bencsik Associates, Ocala, FL 904-732-9775
C.L. Pugh, Cleveland, OH 216-238-1777
Monford Electronics Marketing, Indianapolis, IN
317-872-8877
C.M. Sales, Farmington Hill, MI 313-553-8070
B.C. Electronic Sales, Mission, KS 913-262-1720
Marketing Concepts, Irving, TX 214-869-0669
Torbett/Kelser Group, Loveland, CO 303-669-1008
Plus Four Marketing, Walnut Creek, CA
415-937-0650

North Shore Marketing, Seattle, WA 206-284-9699
Island Instruments, Kaneohe, HI 808-235-7544
PRODUCTS: automatic, computer controlled,
custom, digital, ENC, gated, microprocessor,
modular, paging, rack-mount, theatrical, VCA

Intellx

10500 West Reno
P.O. Box 24031
Oklahoma City, OK 73124-4031 (800) 553-8252
FAX: (405) 324-5217
President: Dave Merrey; Marketing Manager:
Todd Rockwell; Hardware Technical Support:
Tracy Cranton; Software Technical Support: Jack
Vig
ADCOM, Toronto, ON 416-251-3355
PRODUCTS: computer controlled

IRP, A KNOWLES COMPANY

321 Bond Street
Elk Grove VII., IL 60007
(708) 439-3600 (800) 255-6993 FAX: (708) 640-9607
Vice President, General Mgr.: Brian Benn;
Marketing Manager: Roger Carroll; Senior Sales
Engineer: Gayle Campbell; Marketing
Coordinator: Laura Valavicius; Applications
Engineer: Norm Kinnaugh; Product Engineering
Manager: Mitch Bentz
Piper and Givan Assoc., Needham, MA
617-449-1144
Sigmet Corp., Freehold, NJ 201-462-1221
Richard S. Pass Associates, Langhorne, PA
215-757-6100
Henry W. Phillips Co., Rosewell, GA 404-992-3070
Bencsik Associates, Ocala, FL 904-732-9775
C.B. Electronic Marketing, Arvada, CO
303-422-0561
Avwest Inc., Fountain Hills, AZ 602-946-1811
EESCO Systems Inc., Los Angeles, CA 213-666-9601
Pappas Consulting, Menlo Park, CA 415-324-4325
Chuck Olson Assoc., Renton, WA 206-271-5416
Kaitec Communications, North Vancouver, BC
604-987-1597
More Technologies Inc., Los Angeles, CA
213-474-4211
Audio Marketing Assoc., Brecksville, OH
216-526-2426
StarIn Marketing, Chesterton, IN 219-929-4127
MJA Marketing, St. Charles, MO 314-447-7111
Graham Davis Inc., Dallas, TX 214-357-7677
PRODUCTS: automatic, broadcast, combo,
compressor/leveler, custom, gated, modular,
monitor, powered, production, rack-
mount, recording

Ivle Technologies Inc.

1366 West Center
Orem, UT 84057
(801) 224-1800 FAX: (801) 224-7526
President: Craig Berry; Vice President,
Marketing: Glenn Meyer; Vice President,
Product Mgt.: Larry Driskill; Sales Coordinator:
Georgla Hall; Production Vice President: Bob
Greene
Western Audio Sales, Burbank, CA 818-954-9300
Metropolis Audio Marketing, Edison, NJ
201-225-0085
Meyer Marketing, Deerfield Beach, FL
305-481-9250
Radon and Associates, Sacramento, CA
916-923-2524
Loppnow and Associates, Issaquam, WA
206-392-3936
Multi-Technical Reps., Brainerd, MN 218-828-9483



In a world of "or equals," Oxmoor Corporation introduces the DEQ-I and DEQ-II—high-resolution, programmable equalizers that simply have no equal.

Exceptional security. Set them and walk away, because Oxmoor's sophisticated system is more than just an easily removed front panel.

Comprehensive control. Both the DEQ-I and DEQ-II feature 29 constant-Q, minimum-phase, 1/3 octave combining filters, plus sweepable second-order low- and high-pass filters. Adjustment of third-octave filters and output gain is in precise 1/2 db steps over a

TWO EQUALIZERS. NO EQUALS.

(±)12 dB range. Store up to eight equalization curves and other settings in non-volatile memory presets for rapid recall. The DEQ-II's large LCD display and versatile front-panel controls make programming simple, while the DEQ-I's numerical read-out assists in programming through internal controls. Rear ports allow programming either model by a PC, a Macintosh, a PA-422 compatible controller system, or another DEQ-II.

Unequaled value. An unbeatable combination of security, flexibility, and performance—all at an affordable price.



OXMOOR®

Oxmoor Corporation, 2111 Parkway Office Circle, Birmingham, AL 35244
(205) 985-7040 Fax: (205) 985-9966

Circle 243 on Reader Response Card

J.L. Cooper Electronics

13478 Beach Avenue
Marina del Rey, CA 90292
(213) 306-4131 FAX: (213) 822-2252
President: Jim Cooper; Vice President & G.M.:
Steve Cunningham; National Sales & Mktg. Mgr.:
Chuck Thompson; Customer Service Manager:
Eli Slawson
Josh Blacker, Venice, CA 213-823-1252
Jones Audio Sales, Plano, TX 214-618-2600
Midwest Audio Marketing, Steger, IL 708-755-
9376
Reflex Marketing, Hempstead, NY 516-565-2323
Bruce Wismer, Atlanta, GA 404-523-6876
Doug Warren, Newport News, VA 804-930-3217

Lectrosomics, Inc.

P.O. Box 15900
Rio Rancho, NM 87174
(505) 892-4501 (800) 821-1121 FAX: (505) 892-6243
President: John Arasim; Vice President
Engineering: Larry Fisher; Vice President Mktg &
Sales: Bruce Jones
C.L. Pugh & Associates, Cleveland, OH 216-238-
1777
PRODUCTS: automatic, compressor/leveler,
modular, rack-mount

Logitek Electronics Systems Inc.

3320 Berling Dr.
Houston, TX 77057
(713) 782-4592 (800) 231-5870 FAX: (713) 782-7597
President: Tag Borland; Vice President: Susan
Borland; Chief Technician: Joe Huber
Camden Marketing, Pierre Fonds, QU 514-683-
3377
PRODUCTS: broadcast, computer controlled,
custom, ENG, microprocessor, modular,
portable, production, rack-mount, VCA

LPB Inc.

28 Bacton Hill Road
Frazer, PA 19355
(215) 644-1123 FAX: (215) 644-8651
President: Edward W. Devecka Jr.
LPB Inc., St. Michaels, MD 302-745-3977
LPB Inc., Canoga Park, CA 818-340-4590
Audio Etc., St. Peters, MO 314-278-4130
PRODUCTS: broadcast

LynTec

7030 Grandview
Merriam, KS 66204
(913) 722-4047 FAX: (913) 432-4157
Owner: Lynn Potter
Audio Etc., St. Peters, MO 314-278-4130
PRODUCTS: paging

Mag-Tags Inc.

2531 W. Tharpe
Tallahassee, FL 32303
(904) 386-5611 (800) 677-8247 FAX: (904) 385-5710
Owner: Alan Pippenger; CEO: Carolyn
Pippenger; National Sales Manager: Sondra
Hoover
Multi-Technical Reps., Brainerd, MN 218-828-9483

McCurdy Radio Industries Ltd.

108 Carnforth Road
Toronto, ON M4A 2L4
(416) 751-6262 FAX: (416) 751-6455
President: P. Hudson; General Manager: S.
Hobbs; Sales: D. Kupiec; Technical Sales
Support: C. Machado
Audio Etc., St. Peters, MO 314-278-4130

Meridian Communications

P.O. Box 97
Alameda, CA 94501
(415) 769-1515 FAX: (415) 523-6296
President: Shel Gunther
Audio Etc., St. Peters, MO 314-278-4130
PRODUCTS: broadcast, rack-mount, recording,
theatrical, VCA

MicroAudio Inc.

3025 SW Canby St.
Portland, OR 97219-2470
(503) 293-1782 (800) 445-1248 FAX: (503) 293-0562
President: Eugene Rimkelt; Director of
Marketing: H.C. "Bud" Garrison; Director of
Engineering: Richard Schomburg; Sales
Manager: Greg Johnson

Derek Allen, Los Angeles, CA 818-840-8327
Powerlines, Evanston, IL 708-864-1147
Sigmel, Valley Forge, PA 215-783-6666
Worldwide, Ft. Lauderdale, FL 305-584-7024
Online, Wadsworth, CA 216-336-7504
Sound Sales, Inc., Columbia, MD 301-964-1170
PRODUCTS: computer controlled, digital, rack-
mount

Midas

200 Sea Lane
Farmingdale, NY 11735
(516) 249-3660 FAX: (516) 420-1863
President: Jack Kelly; Sales Mgr.: Sam
Spennacchio
Loomis and Associates, Fremont, CA 415-683-
0883

**PLAN FOR THE UNEXPECTED.**

Because you can never be too well prepared, the TOA AX-1000 mixer has eight input ports with a choice of 37 modules — including mic, line, aux, BBE, I/O and bridging — making design, upgrades and changes, quite literally, a snap. Advanced circuitry lets you tailor the gain sharing to match the acoustic conditions ... so each mic gets maximum available gain for intelligibility. It's completely automatic, completely modular, completely silent, completely reliable. Just what you'd expect from TOA. A versatile, forward-thinking mixer that helps you look very well prepared indeed.



ENGINEERED SOUND PRODUCTS FROM:
TOA ELECTRONICS, INC., 601 GATEWAY BLVD.,
SOUTH SAN FRANCISCO, CA 94080
415/588-2538 • 800/733-7088

Neotek Corp.

1154 West Belmont Ave.
Chicago, IL 60657
(312) 929-6699 FAX: (312) 975-1700
President: Craig Connally; Sales and Support
Director: Tom Der; Sales Coordinator: Laura
Chase; Marketing Director: Tom Lay
Dimension/ Point IX, Lewisville, TX 214-436-3706

Optical Radiation Corporation

1300 Optical Drive
Azusa, CA 91702
(818) 969-3344 (800) 767-0456 FAX: (818) 812-9608
President: Richard Wood; Group Vice President:
Carl Froua; Vice President, Cinema Group: Glenn
Berggren; Program Director: Howard Flemming;
Director of Marketing: David Koyle; Manager of
Marketing: Barbara Stokes
Walter Browski, .
Barry Nicely, .
Bob Pinkston, .
Loomis and Associates, Fremont, CA 415-683-
0883

Otari Corp.

378 Vintage Pk Drive
Foster City, CA 94404
(415) 341-5900 FAX: (415) 341-7200
President: Jack Soma; VP Sales & Marketing:
John Carey; Controller: Jerry Yaffee; Service
Manager: Phil Sun; Credit Manager: Dick
Lannan; International Sales Mgr.: Lee Pomerantz
J.B. Anthony, Stamford, CT 203-322-9202
R.J. Marketing Ltd., Rockville, MD 301-251-0330
William J. Ray Associates, Smyrna, GA 404-436-7233

Starin Marketing, Chesterton, IN 219-929-4127
New West Audio, Burbank, CA 818-955-9700
Camden Marketing, Pierre Fonds, QU 514-683-
3377
PRODUCTS: production, recording

Outline

Via L. Davinci 56
25020 Flero, Italy
(30) 358-1341 (800) 358-1351 FAX: (30) 358-0431
President: Guido Noselli; Vice President, Sales:
Giorgio Biffi; Marketing Director: Marcello Croce;
R & D Director: Giancarlo Puzzi; Sales Manager:
Anna Guarenti; Purchasing Manager: Angelo
Ferraresi
Coemar Deutschland, ULM, Germany, 073-160-
1205
MBS, Lempdes, France, 073-910-630
Lebnitzer M. Bigler, Austria, 034-52-6515
Talseng Trading, Taipei, Taiwan, 253-13802
Universal, Singapore, 534-5993
Precide, Morbio Inferiore, Switzerland, 914-
31734
PCP Electronics, Limassol, Cyprus, 53-39297
Metronome Muzik, Istanbul, Turkey, 7-345-
2457
Tropical Recording, Malindi, Kenya, 723-27700
Point Rouge, Mutuelueville, Tunis, 7-345-2457
PRODUCTS: broadcast, disco, powered

OXMOOR CORP.

2111 Parkway Office Circle
Birmingham, AL 35244
(205) 985-7040 FAX: (205) 985-9966
President: Lynn A. McCroskey; Vice President/

Manager: Gary L. West; National Sales Manager:
Richard C. Mitchell; Sales Associate: Nick
Alsmiller; Production Manager: Jim Watson;
Director of Engineering: Gene Elghmy
John B. Anthony Company, Stamford, CT 212-
585-2027
ASR, Fallston, MD 301-893-0001
Audio Resources, Westmont, IL 708-655-1180
Dimension IX Marketing, Lewisville, TX 214-436-
3706
Evans Sales and Marketing, Nashville, TN
615-297-7997
Loomis and Associates, Fremont, CA
415-683-0883
Loppnow and Associates, Issaquah, WA
206-392-3936
R.J. Throckmorton Sales Co., Ballwin, MO
314-227-7222
Repworks, Chicopee, MA 413-553-0845
PRODUCTS: monitor, production, recording,
theatrical

Panasonic Professional Audio Sys.

6550 Katella Avenue, Cypress, CA 90630
(714) 373-7278 FAX: (714) 373-7242
Nat. Sales & Marketing Mgr.: Steve Woolley;
Marketing Manager: Chris Foreman; Western
Regional Sales Mgr.: James Murray; Midwest
Regional Sales Mgr.: Greg Braithwaite; Eastern
Regional Sales Mgr.: Carla Campbell;
Telemarketing Sales Mgr.: Lynn Thompson
James Murray, Cypress, CA 714-373-7389
Greg Braithwaite, Arlington, IL 708-981-7329
Carla Campbell, Norristown, PA 215-630-1651
Cambridge Marketing, Westerville, OH
614-363-9191
PRODUCTS: broadcast, combo, monitor,
production, theatrical, rack-mount

Peace Of Mind.



Designing a sound system puts your reputation and integrity on the line. People depend on you to create a complete solution to their audio needs; to put together just the right components to satisfy the job requirements and hold up over the long haul.

Specify products from ASHLY. You have our commitment of at least Five Years of trouble-free performance.* At ASHLY, every product

we manufacture is hand constructed right here in the USA from the finest components available, and 200% quality controlled before ever leaving our plant. Designed to be the best possible investment in professional audio equipment.

Whatever your audio application, design in reliability and system integrity. Design in peace of mind. Design in ASHLY.

ELECTRONIC CROSSOVERS
COMPRESSOR/LIMITERS
NOISE GATES • PREAMPS
PARAMETRIC EQUALIZERS
GRAPHIC EQUALIZERS
POWER AMPLIFIERS • MIXERS

ASHLY
AUDIO TOOLS FOR THE TRUE PROFESSIONAL

*All ASHLY products are covered by our exclusive Five Year Worry-Free Warranty. Contact ASHLY AUDIO directly for full details.

ASHLY AUDIO INC. • 100 FERNWOOD AVE • ROCHESTER, NY 14621 • TOLL FREE (800) 828-6308 • (716) 544-5191 • FAX: (716) 266-4589

Circle 249 on Reader Response Card

Paso Sound Products, Inc.

14 First Street
Pelham, NY 10803
(914) 738-4800 (800) 231-3034 FAX: (914) 738-3954
Executive Vice President: Paul Mastrangelo;
Product Manager: Ken O'Brien; Credit Manager:
Marilyn Beckerson; Operations Manager:
Anthony Squeglla
Anderson Sales, Braintree, MA 617-848-9194
Jack Mesnick Sales, Liverpool, NY 315-622-3211
Palmerl Associates, Fairfield, NJ 201-882-1266
Weller Electronic Sales, Inc., Worthington, OH
614-885-7819
Lienau Associates, Columbia, MD 301-621-4113
MJA Marketing, St. Charles, MO 314-447-7111
Northland Assoc., Moorehead, MN 218-233-4616
Allwest Sound & Communication, Camarillo, CA
805-388-7745
Dimension Pt. IX Marketing, Katy, TX 713-578-9277
Mountain Representatives, Denver, CO 303-333-
7745
Miguel Lopez, Hialeah, FL 305-822-6853
Paco Electronics, Ltd., Markham, ON 416-475-0740
Robert Misk Co., Southfield, MI 313-354-3310
Marketline Inc., Snellville, GA 404-972-9048
Hawkins-Frederickson Assoc., Maitland, FL 407-
831-2474
Lintern Associates, Naperville, IL 708-904-1225
Robert Misk Co., Indianapolis, IN 317-842-3400
PRODUCTS: paging, portable, powered, rack-
mount

PEAVEY ELECTRONICS CORP.

711 A Street
P.O. Box 2898
Meridian, MS 39301
(601) 483-5365 FAX: (601) 484-4278
CEO: Hartley Peavey; President: Mella Peavey
Dimension/ Point IX, Lewisville, TX 214-436-3706
PRODUCTS: automatic, combo, computer
controlled, custom, digital, disco, gated,
microprocessor, MIDI, modular, monitor,
portable, powered, production, rack-mount,
recording, theatrical

Professional Sound

5707 Cahuenga Blvd.
N. Hollywood, CA 91601
(818) 760-6544 FAX: (818) 980-9911

Protech Audio Corporation

Flowerfield Bldg. 1
St. James, NY 11780
(516) 584-5855 FAX: (516) 584-5904
Director of Marketing: Bill Murphy; Sales
Engineering: Joseph Glambone
Peregrine Southwest Reps, Houston, TX 713-589-
8481
First Choice Marketing, Seattle, WA 206-524-7344
Dimension/ Point IX, Lewisville, TX 214-436-3706
PRODUCTS: compressor/ leveler, modular,
paging, rack-mount, VCA

Quantam Audio Labs

2752 Walnut Ave.
Tustin, CA 92680
(714) 838-8833 FAX: (714) 838-9619
Camden Marketing, Pierre Fonds, QU 514-683-
3377

Radio Design Labs

5025 8th Street
Carpinteria, CA 93013
(805) 684-5415 FAX: (805) 684-9316
Director of Engineering: Joel Bump; Dir. of Sales
& Marketing: Jerry Clements
Karp Communications, Tampa, FL 813-968-7098

Recordex

1935 Delk Ind'l Blvd.
Marietta, GA 30067
Camden Marketing, Pierre Fonds, QU 514-683-
3377

Russco Electronics Mfg., Inc.

5690 E. Shields Avenue
Fresno, CA 93727
(209) 291-5591 FAX: (209) 291-9601
President/General Manager: Ron Reyes; Vice
President/Treasurer: Dave Haury; Marketing
Manager: Jeanette Montgomery
Sound Sales, Inc., Columbia, MD 301-964-1170
PRODUCTS: broadcast, portable, rack-mount

ULTIMATE FLEXIBILITY!

INNOVATIVE DESIGN SOLUTIONS FROM Ivie

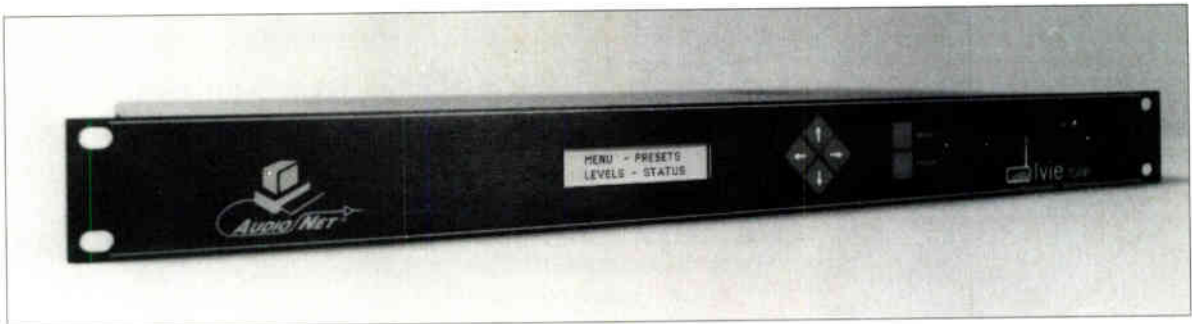

PROGRAMMABLE MATRIX MIXER

**WE COULD TELL YOU ALL ABOUT THIS MIXER WITH A 4 PAGE AD,
BUT THAT WOULD BLOW OUR WHOLE ADVERTISING BUDGET!**

**WHY NOT JUST CALL US FOR COMPLETE INFORMATION.
WE'D LOVE TO HELP WITH YOUR DESIGN SOLUTIONS.**



1366 West Center Street • Orem, UT 84057 • Phone: (801) 224-1800 • Fax: (801) 224-7526

S.E.M. Co.

#17-636 Clyde Ave.
W. Vancouver, BC V7T 1E1
(604) 922-0526 FAX: (604) 922-0526
President: Elk Ebert; Vice President: Anne Moretti
Karp Communications, Tampa, FL 813-968-7098
PRODUCTS: automatic, custom, modular

SHURE BROTHERS, INC.

222 Hartrey Avenue
Evanston, IL 60202-3696
(708) 866-2200 (800) 257-4873 FAX: (708) 866-2279
President: James H. Kogen; Vice Pres, Finance & Sales: Robert Gilbert; Vice President, Sales: Lottie Morgan; Director, Technical Markets: John Phelan; Director Microphone Products: Sandy Schroeder; Dir., Mktg. Communications: Nancy Calvert
Audio Biz, Mundelein, IL 708-949-0280
PCM Marketing, Walnut Creek, CA 415-935-0900
Peter E. Schmitt Company, Inc., Leonia, NJ 201-944-2806
Millar Electronics, Inc., Atlanta, GA 404-634-3350
Pro Tech Marketing, Midvale, UT 801-561-8844
Karp Communications, Tampa, FL 813-968-7098

Sony Corp./Business & Pro. Aud. Grp

3 Paragon Drive
Montvale, NJ 07645-1735
(201) 930-1000
President, Sales & Marketing: Mark Gray; Senior VP Sales: C.F. Taylor; V.P. Product Marketing: Anthony Gargano; Marketing Manager, Pro Audio: Courtney Spencer; Sales Manager, Pro

Audio: Gary Rose; V.P. Audio Products: Ron Remschel
Matt Robertson, Western Dist., 213-469-9084
Audio Etc., St. Peters, MO 314-278-4130
PRODUCTS: automatic, broadcast, combo, digital, ENG, portable, production, recording, theatrical

Sound Designers Studio

424 West 45th Street, New York, NY 10036-3565
(212) 759-5679 FAX: (212) 265-1250
President: Richard Fitzgerald; Vice President: Peter Fitzgerald; Designer: Bernard Fox; Manager: Gene Perla
Western Audio Sales, Burbank, CA 818-954-9300
Metropolis Audio Marketing, Edison, NJ 201-225-0085
R.J. Marketing Ltd., Rockville, MD 301-251-0330
S.C. Music, Cambridge, MA 617-876-9870
Audio Resources, Westmont, IL 708-655-1180
Preclde, Morbio Inferiore, Switzerland, 914-31734
PRODUCTS: automatic, broadcast, combo, compressor/leveler, computer controlled, custom, digital, disco, ENG, gated, microprocessor, MIDI, modular, monitor, paging, portable, powered, production, rack-mount, recording, theatrical, VCA

Soundcraft

8500 Balboa Blvd.
P.O. Box 2200, Northridge, CA 91329
(818) 893-4351 FAX: (818) 893-3639
President: Ronald Means; Vice President/Sales: Ken Lopez; Vice President/Marketing: Mark Gander; Market Manager: Hector Martinez; National Sales Manager: David Kimm

Jim Chase, San Clemente, CA 714-492-6290
Bill Hamilton, Folsom, PA 215-543-4677
Bill Schuermann, Houston, TX 713-370-4925
Tom Walter, No. Barrington, IL 708-382-4925
Dimension/Point IX, Lewisville, TX 214-436-3706
PRODUCTS: broadcast, monitor, portable, production, rack-mount, recording, theatrical

Soundtracs PLC

91 Ewell Road
Surrey, UK KT6 6AH
(81) 399-3392 FAX: (81) 399-6821
Managing Director: Todd Wells; Sales Director: John Carroll; Product Manager: Joel Singer
Worldwide Electronics, Davle, FL 305-584-7024
Image Marketing, Fountain Valley, CA 714-957-0630
Jamm Distributors, Flosser, IL 708-799-0550
Reflex Marketing, Hempstead, NY 516-565-2323
JMS Sales, Austin, TX 512-266-1113
Karp Communications, Tampa, FL 813-968-7098

Spatial Sound, Inc.

743 Center Boulevard
Fairfax, CA 94930
(415) 457-8114 FAX: (415) 457-6250
Sales Manager: Paul Devlas; Chief Engineer: Alain Martel
Karp Communications, Tampa, FL 813-968-7098
PRODUCTS: automatic, custom, disco, microprocessor, MIDI, rack-mount, theatrical, VCA

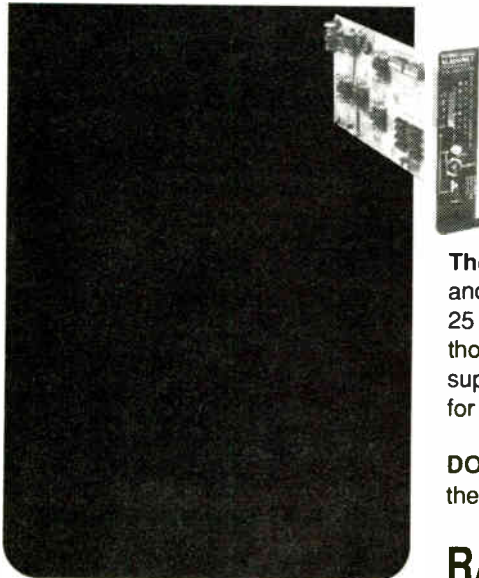
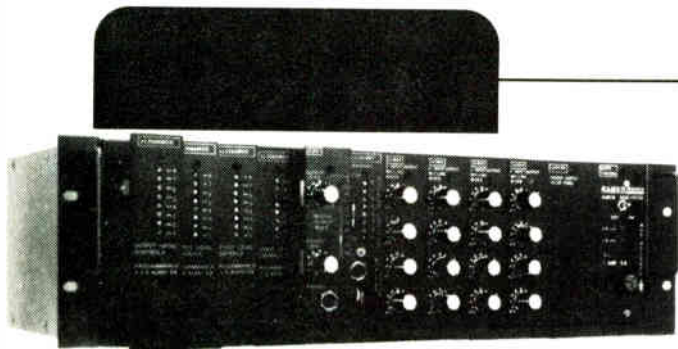

NEW!!

The xLAS-10. An integrated audio system so versatile, imagination may be its only limitation!

Let your imagination go! Visualize a modular sound system that will enable you to create an audio mixer with up to 32 channels or a 20 in by 80 out programmable distribution system or even an eight channel mixer with compression/limiting, EQ, eight output audio distribution and 4 input switching to both an individual output and the master mixing bus. All in one compact 5 1/4" x 19" main frame!

The possibilities are limitless. Sixteen plug-in modules currently in production and under development combined with 300 rear panel input output terminals and 25 interlinked, internal audio mixing and control busses, provide you with literally thousands of different variations. And, with the three different plug-in power supplies you have a choice of 110/230 VAC, 20VAC or 12VDC battery operation for mobile or remote operation.

DO IT NOW! Call TOLL FREE (800) 678-1357 or FAX (916) 635-0907 for the latest fact sheet & pricing on this fabulous new labor saver.

RAMKO RESEARCH (916)635-3600/3501-4 SUNRISE BLVD./RANCHO CORDOVA, CA 95742

Circle 247 on Reader Response Card

Sphere Electronics

20201 A Praire
Chatsworth, CA 91311
(213) 349-4747
Camden Marketing, Pierre Fonds, QU 514-683-3377

Studer Revox America, Inc.

1425 Elm Hill Pike
Nashville, TN 37210
(615) 254-5651 FAX: (615) 256-7619
President: Tore Nordahl; Executive Vice
President: Bill Muggler; Director, Professional
Prods.: David Bowman; Director of Tech.
Operations: Jim Kurowski; Dir. of Tech. and
Mktg. Svcs.: Doug Beard
Studer Revox America, New York, NY
212-255-4462
Studer Revox America, Los Angeles, CA
818-780-4234
Studer Revox Canada Ltd., Toronto, CA
416-510-1347
Jim Burger, Philadelphia, PA 203-297-7160
PRODUCTS: broadcast, custom, digital, portable,
production, recording, theatrical

STUDIOMASTER INC.

3941 Miraloma Avenue
Anaheim, CA 91719
(714) 524-2227 FAX: (714) 524-5096
President: Paul Reeve; National Sales Manager:
Jim Giordano
J.B. Parent, Dublin, OH 614-764-0064
PRODUCTS: MIDI, modular, monitor, portable,
powered, production, rack-mount, recording,
theatrical

Tascam

7733 Telegraph Rd.
Montebello, CA 90640
(213) 726-0303
Division Manager: Greg Hildebrandt; National
Field Sales Manager: Chas. Prada
JMS Marketing, Austin, TX 512-266-1113

TOA ELECTRONICS, INC.

601 Gateway Blvd. Suite 300
P.O. Box 2047
San Francisco, CA 94080
(415) 588-2538 (800) 733-4750 FAX: (415) 588-3349
President: Yoshiro Ishida; Director, Audio
Products Div.: Richard Krochmal; Director,
Comm. Systems Div.: Al Burns; Mgr., Marketing
Development: Jeff Pallin; Manager, Western
Division: Bill Ford; Manager Engineering
Services: Bob Sweet
Chuck McGregor - Product Conslt, Morris Plains,
NJ 201-829-7047
John Murray-Eng.Snd. Mktg. Dev, Springfield, OH
513-324-1993
Bob Hager - Eastern Regional Mgr, Rosewell, GA
404-552-7624
Linda Wick - Central Reg. Mgr., Kansas City, MO
816-453-5775
Robert Slaughte - Cntrl Div Mgr, Houston, TX 713-
460-3678
Pete Newmark - West Regional Mgr., Mesa, AZ
602-981-0050
Walter Best, Eastern Reg. Mgr., Sussex, NJ 201-
702-0068
PRODUCTS: automatic, broadcast, digital, gated,
microprocessor, modular, paging, rack-mount

Total Audio Concepts

10815 Burbank Blvd., N. Hollywood, CA 91601
(818) 508-9788 FAX: (818) 508-8619
Camden Marketing, Pierre Fonds, QU 514-683-3377

Trident Audio USA

2720 Monterey St. #40, Torrance, CA 90503
(213) 533-8900 FAX: (213) 533-7072
President: Wayne D. Freeman; Technical
Manager: Krls Jackson;
Sales Manager: Phil Wagner
JMS Marketing, Austin, TX 512-266-1113
PRODUCTS: broadcast, compressor/leveler,
computer controlled, custom, gated,
microprocessor, production, recording, VCA

Ward-Beck Systems

841 Progress Ave.
Scarborough, Ontario, M1H 2X4
(416) 438-6550 FAX: (416) 438-3865

YAMAHA CORP. OF AMERICA

6600 Orangethorpe Ave., Buena Park, CA 90620
(714) 522-9011 FAX: (714) 739-2680
Sales & Marketing Manager: Gerald W. Tschetter;
Pro Digital Sis & Mktg Mgr.: Peter Chalkin;
Market Support Manager: Don Bowles
Precide, Morbio Inferiore, Switzerland, 914-31734
PRODUCTS: combo, digital, disco, MIDI, monitor,
portable, powered, production, rack-mount,
recording, theatrical, VCA

**Alphone Corp.**

1700 130th Ave. NE., Bellevue, WA 98005
(206) 455-0510 FAX: (206) 455-0071
President: Jun Matsumoto; Vice President,
Marketing: Harry Quanz; Vice President, Sales:
Jim Morrison; Residential Sales Manager:
Stephen Birgh; Commercial Sales Manager: John
Mosebar
Alphone East Coast Reg. Office, Rochelle Park, NJ
201-843-6115
Precide, Morbio Inferiore, Switzerland, 914-
31734
PRODUCTS: telephone, zoned

The word "ASHLY" in a bold, blue, sans-serif font, with a horizontal line above and below the text.

Ashly Audio, Inc.

100 Fernwood Ave.
Rochester, NY 14621
(716) 544-5191 (800) 828-6308 FAX: (716) 266-4584
President: Bill Thompson; Senior Vice President:
Bob French; Vice President: Dave Malloy;
Operations Manager: Ellen Price
ADCOM, Toronto, ON 416-251-3355
PRODUCTS: mixer/ amplifier, mixer/ preamps,
processors

Audio Analysts U.S.A. Inc.

13 industrial Boulevard West
Plattsburgh, NY 12901
(518) 561-5071
President: Pierre Pare; Vice
President/Marketing: Bertrand Pare; Vice
President/Engineering: Albert Leccese
Audio Analysts, North Hollywood, CA
818-766-8155
Audio Analysts, Brossard, QU 514-466-1691
Audio Analysts USA Inc., Los Angeles, CA
213-653-2324
ADCOM, Toronto, ON 416-251-3355

Audio Systems Co.

1815 Michigan Ave.
Bismarck, ND 58504
(701) 223-3800 (800) 852-6522 FAX: (701) 222-8102
President: Lynn Mader; Vice President: Lyle
Mader
Leslie Inc., Elgin, IL 708-697-6677
Doug Warren, Newport News, VA 804-930-3217
PRODUCTS: mixer/ preamps, processors, zoned

Audio/Digital

8500 Balboa Blvd.
P.O. Box 2200
Northridge, CA 91329
(818) 893-8411 FAX: (818) 893-3639
President: Ronald Means; Vice President, Sales:
Ken Lopez; Vice President, Marketing: Mark
Gander; Market Manager: Hector Martinez; Sales
Manager: Neil Conley
Jim Chase, San Clemente, CA 714-492-6290
Bill Hamilton, Folsom, PA 215-543-4677
Bill Schuermann, Houston, TX 713-370-4925
Tom Walter, No. Barrington, IL 708-382-4925
Precide, Morbio Inferiore, Switzerland, 914-31734
PRODUCTS: processors

BBE SOUND, INC.

5500 Bolsa Ave. Ste. #245
Huntington Bch., CA 92649
(714) 897-6766 (800) 233-8346 FAX: (714) 895-6728
Chairman: John C. McLaren; National Sales
Manager: Rob Rizzuto; Director of Engineering:
Paul Gagon
Marshank Sales Co., Los Angeles, CA 213-670-7071
Starin Marketing, Chesterton, IN 219-929-4127
First Choice Marketing, Seattle, WA 206-365-4568
The Henderson Company, Concord, MA
508-287-0020
John B. Anthony Co., Stamford, CT 203-322-9202
Nova Marketing, San Francisco, CA 415-952-0943
PRODUCTS: processors

Bogen Communications, Inc.

50 Spring Street
P.O. Box 575
Ramsey, NJ 07446
(201) 934-8500 FAX: (201) 934-9832
President: John H. Ochtera; Vice President, Sale
& Mktg: David A. Chambers
Scott Whipple, Columbus, OH
614-272-1689
Sam Blasl, Ramsey, NJ
201-934-8500
Walter Spencer, Ramsey, NJ
201-934-8500
Fred Vosenlck, Woodland, CA
916-668-6311
Edwards Company, Inc., Livonia, MI
313-458-7777
PRODUCTS: mixer/ amplifier, mixer/ preamps,
modular, music distribution, telephone, zoned

BOSE CORP.

The Mountain
 Framingham, MA 01701-9168
 (508) 879-7330 FAX: (508) 872-6640
 National Sales Manager: Timothy Dorwart;
 Eastern Reg. Sales Manager: Bruce Hurst;
 Western Reg. Sales Manager: Tim Landwehr; Sr.
 Applications/Des. Spec.: Bruce Myers; Sr. Sales
 Representative: Reed Strutzenberg; Sales
 Representative: Phil Nelson
 HC Garrison Co., Tualatin, OR 503-638-4906
 Westech Marketing, Culver City, CA 213-870-9286
 Silver Peak Marketing, Wheat Ridge, CO 303-467-
 9042
 Rancillo Assoc., St. Louis, MO 314-845-0202
 CR Marketing, Clarkston, MI 313-625-2420
 J.B. Parent, Dublin, OH 614-764-0064
 Secom Systems, Atlanta, GA 404-455-0672
 Bencsik Assoc., Ocala, FL 904-732-9775
 Sigmet Corp., Valley Forge, PA 215-783-6666
 Joseph P. Mazzeo Assoc., Inc., Rochester, NY 716-
 458-7851
 Peter E. Schmitt Co., Inc., Leonia, NJ 201-944-2806

Cerwin-Vega

555 E. Easy St.
 Simi Valley, CA 93065
 (805) 584-9332 FAX: (805) 583-0865
 V.P. Pro Sales and Marketing: Rich Mandella;
 Tech/ Sales & Marketing: John Davies; Inside
 Sales: Gayle De Matoff
 Southwest Marketing, TX, AZ, NM, OK, CO 818-
 848-7512
 MJA Sales, NY, NJ 201-467-9898
 Image Marketing, CA, NV 714-957-0630
 Crescendo, FL 305-922-9553
 Audio Biz, IL 708-949-0280

CLARITY

1111 Industry Avenue, S.E.
 Roanoke, VA 24013
 (703) 982-7003 (800) 962-6009 FAX: (703) 982-7032
 President: John W. Mason; Sales Coordinator:
 Linda T. Bishop; Product Manager: John D.
 Spencer
 Featherstone Sales, Los Gatos, CA 408-356-3243
 Unirep Inc., Valrico, FL 813-681-3477
 M.I.N.K. Associates, Overland Park, KS 913-341-
 2112
 Gerald Horne Associates, Stow, MA 508-897-1741
 Fort! Associates, Kensington, MD 301-949-1706
 Holland Marketing, Bloomington, MN 612-881-
 8425
 Adams & Associates, Greensboro, NC 919-272-
 6838
 Reptronics Inc., New Madison, OH 800-888-0530
 Dick Belew Sales, Dallas, TX 214-644-7881
 PRODUCTS: mixer/ amplifier, mixer/ preamps,
 telephone

Dukane Corp.

2900 Dukane Drive
 St. Charles, IL 60174
 (708) 584-2300 FAX: (708) 584-2370
 President/C.E.O.: J. McWilliams Stone Jr.;
 Pres./Comm. Systems Division: Steven L. Deppe;
 National Sales Director: Warren T. Anderson;
 Service Manager: Cliff Carlson
 Wally Smutts, Toronto, ON 519-748-5352
 Doug Fellabaum, Sycamore, IL 815-895-7573
 Ken Lind, Boston, MA 617-235-6817
 Pete Kendall, Jacksonville, FL 904-262-6025
 Jim Lacey, Moreno Valley, CA 714-243-1160
 Jack Brown, Dallas, TX 214-943-7528
 Sanford Lange, Indianapolis, IN 317-251-3112

PRODUCTS: mixer/ amplifier, mixer/ preamps,
 modular, music distribution, signalling,
 telephone, zoned

EDCOR ELECTRONICS

7130 National Parks Hwy
 P.O. Box 5098
 Carlsbad, NM 88220
 (505) 887-6790 (800) 854-0259 FAX: (505) 887-6880
 Sales: P. Weston; Engineering: Brian Weston
 Greg Dzubay & Assoc., Glendale, AZ 800-999-0006
 PRODUCTS: mixer/ amplifier, mixer/ preamps,
 modular, music distribution, signalling,
 telephone, zoned

Fanon Courier

14811 Myford Road
 Tustin, CA 92680
 (714) 669-9890 (800) 345-1354 FAX: (714) 669-1081
 President: Frank Blaha; Director Sales &
 Marketing: Murray Trotiner; Director of
 Engineering: Miguel Santana
 Greg Dzubay & Assoc., Glendale, AZ 800-999-0006

FOSTEX CORPORATION OF AMERICA

15431 Blackburn Ave.
 Norwalk, CA 90650
 (213) 921-1112 (800) 7-FOSTEX FAX: (213) 802-
 1964
 V.P. Marketing/ General Mgr.: Robert Veri; V.P.
 Sales: Mark Cohen
 J.B. Parent, Dublin, OH 614-764-0064
 PRODUCTS: modular

Gliderfluke & Co.

820 Thompson Avenue #35
 Glendale, CA 91201
 (818) 546-1618 FAX: (818) 546-1619
 Owner: Doug Mobley; Marketing: Denise
 Dougherty
 Greg Dzubay & Assoc., Glendale, AZ 800-999-0006
 PRODUCTS: modular, processors, zoned

INNOVATIVE ELECTRONIC DESIGNS, INC.

9701 Taylorsville Rd.
 Louisville, KY 40299
 (502) 267-7436 FAX: (502) 267-9070
 President: Hardy Martin; Vice President, Mkt'g &
 Sales: Tom Roseberry; Sales Application
 Engineer: Mark Lewellyn; V.P. Research &
 Development: Bob Ponto; Vice President,
 Engineering: Ed Young; Vice President,
 Software: John Johnson
 Yore Company, White Bear Lake, MN 612-770-
 9760
 Steffey Marketing Assoc. Inc., Northbrook, IL 708-
 480-3575
 Westech Marketing, Culver City, CA 213-870-9286
 Repworks, Chicopee, MA 413-533-0845
 Darmstedter Associates, Baldwinsville, NY 315-
 638-1261
 John Anthony, Stamford, CT 203-322-9202
 Bencsik Associates, Ocala, FL 904-732-9775
 C.L. Pugh, Cleveland, OH 216-238-1777
 Monford Electronics Marketing, Indianapolis, IN
 317-872-8877
 C.M. Sales, Farmington Hill, MI 313-553-8070
 B.C. Electronic Sales, Mission, KS 913-262-1720
 Marketing Concepts, Irving, TX 214-869-0669
 Torbett/Kelser Group, Loveland, CO 303-669-1008
 Plus Four Marketing, Walnut Creek, CA 415-937-
 0650
 North Shore Marketing, Seattle, WA 206-284-9699
 Island Instruments, Kaneohe, HI 808-235-7544
 PRODUCTS: mixer/ preamps, modular, music
 distribution, processors, signalling, telephone,
 zoned

**The BLUE BOOK is a
 thoughtful and inexpensive
 token of appreciation
 for your employees
 and customers.**

**Additional copies of
 THE 31ST ANNUAL BLUE BOOK
 are \$12.00 plus shipping
 and handling**

**SEND YOUR CHECK OR MONEY ORDER TO:
 ARTURO LIZARRAGA, CIRCULATION DIRECTOR
 THE BLUE BOOK**

25 Willowdale Avenue
 Port Washington, NY 11050

Install advanced automatic mixing in lower cost jobs.

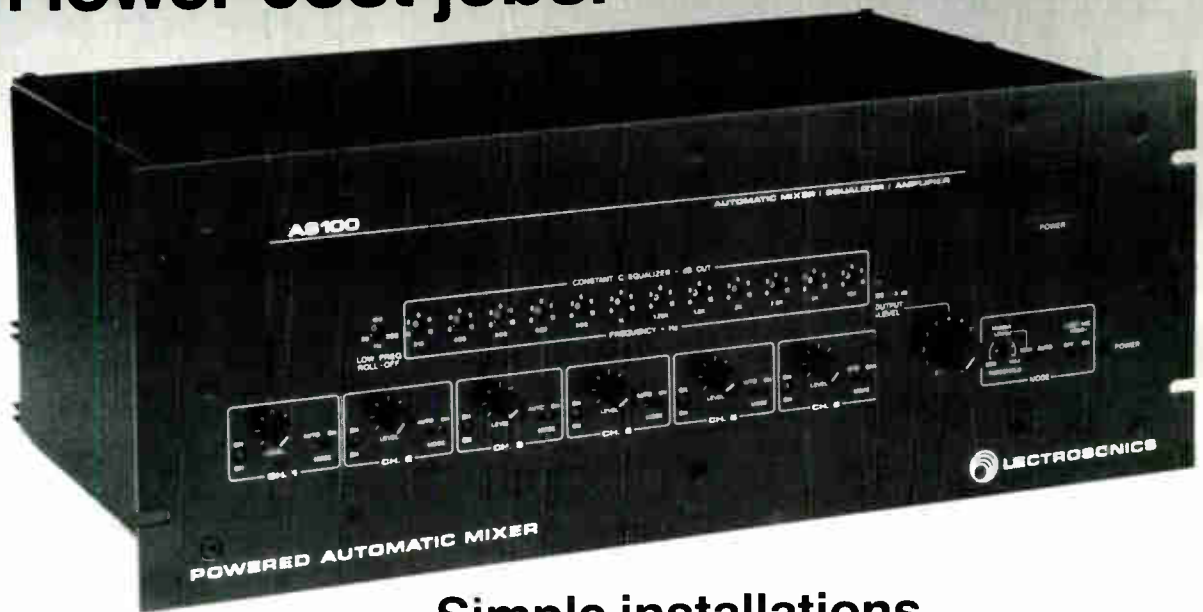

Simple installations. . .
 . . .impressive results.

Six channel Automatic Mixer

Unique non-gating automatic mixing circuitry • All inputs are adjustable from mic to line level • Phantom power selectable for each channel • "Last Mic Hold" function eliminates "pumping and breathing" • Remote control VCA connections on every input and the main output • Manual or automatic turn-on threshold • in/out patch point for external signal processing

Constant Q Equalizer

Adjustable low frequency roll-off • 10 band constant-Q, 1/3 octave equalizer, 315Hz to 2.5KHz • 2 band constant-Q, 1 octave equalizer, 5KHz and 10KHz • "Pre" or "Post" EQ jumpers for every channel • Security cover resists tampering

Power Amplifier

100 Watts RMS at 4 Ohms • Less than 0.25% THD at 20Hz to 20KHz • Built-in limiter to prevent clipping and protect the speaker system • Fully protected against shorts and highly reactive loads • Thermally protected • Optional 70 Volt output transformer

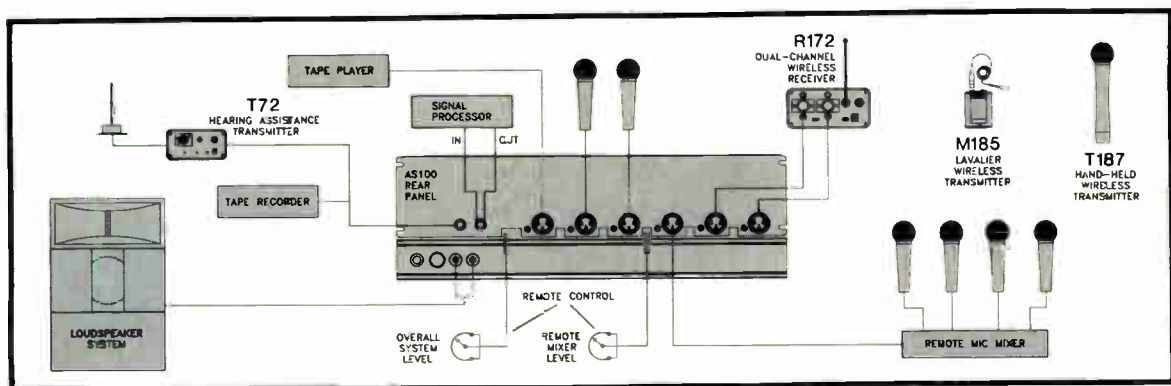

This diagram illustrates one example of a typical AS100 system installation. Each channel can be jumpered pre or post EQ. Remote VCA level control is provided for each input channel and on the main output. Each input may be operated in an "auto" or "direct" mode for microphones or line inputs. A "patch point" is provided for external signal processing.

Call for more information!
 Toll free: 800-821-1121

Made in the USA



LECTROSONICS, INC.

P.O. Box 15900 • Rio Rancho, NM • 87174
 581 Laser Rd. NE • Rio Rancho, NM • 87124
 (505) 892-4501 • (800) 821-1121

FAX (505) 892-6243

IRP, A KNOWLES COMPANY

321 Bond Street
Elk Grove VII., IL 60007
(708) 439-3600 (800) 255-6993 FAX: (708) 640-9607
Vice President, General Mgr.: Brian Benn;
Marketing Manager: Roger Carroll; Senior Sales
Engineer: Gayle Campbell; Marketing
Coordinator: Laura Valavicius; Applications
Engineer: Norm Kinnaugh; Product Engineering
Manager: Mitch Bentz
Piper and Givan Assoc., Needham, MA
617-449-1144
Sigmet Corp., Freehold, NJ 201-462-1221
Richard S. Pass Associates, Langhorne, PA
215-757-6100
Henry W. Phillips Co., Rosewell, GA 404-992-3070
Bencsik Associates, Ocala, FL 904-732-9775
C.B. Electronic Marketing, Arvada, CO 303-422-0561
Avwest Inc., Fountain Hills, AZ 602-946-1811
EESCO Systems Inc., Los Angeles, CA 213-666-9601
Pappas Consulting, Menlo Park, CA 415-324-4325
Chuck Olson Assoc., Renton, WA 206-271-5416
Kaltac Communications, North Vancouver, BC
604-987-1597
More Technologies Inc., Los Angeles, CA
213-474-1211
Audio Marketing Assoc., Brecksville, OH
216-526-2426
Starin Marketing, Chesterton, IN 219-929-4127
MJA Marketing, St. Charles, MO 314-447-7111
Graham Davis Inc., Dallas, TX 214-357-7677
PRODUCTS: mixer/ amplifier, mixer/ preamps,
modular, music distribution, processors, zoned

J.W. DAVIS AND CO.

3030 Canton Street, Dallas, TX 75226
(214) 651-7341 (800) 527-5705 FAX: (214) 939-0328
President: Harvey Earp; Vice President, Sales:
Jack W. Tucker; Chief Engineer: Eric Simonson
Multi-Technical Reps., Brainerd, MN 218-828-9483
PRODUCTS: mixer/ amplifier, mixer/ preamps,
music distribution, telephone, zoned

JBL Professional

8500 Balboa Boulevard
P.O. Box 2200
Northridge, CA 91329
(818) 893-8411 FAX: (818) 893-3639
President: Ronald Means; Vice President, Sales:
Ken Lopez; Vice President, Marketing: Mark
Gander; Market Manager: Hector Martinez;
National Sales Manager: Neil Conley
Jim Chase, San Clemente, CA 714-492-6290
Bill Hamilton, Folsom, PA 215-543-4677
Bill Schuermann, Houston, TX 713-370-5553
Tom Walter, No. Barrington, IL 312-382-4925
ADCOM, Toronto, ON 416-251-3355
PRODUCTS: music distribution, processors,
signaling

Lectrosonics, Inc.

P.O. Box 15900
Rio Rancho, NM 87174
(505) 892-4501 (800) 821-1121 FAX: (505) 892-6243
President: John Arasim; Vice President
Engineering: Larry Fisher; Vice President Mktg &
Sales: Bruce Jones
C.L. Pugh & Associates, Cleveland, OH
216-238-1777
PRODUCTS: modular, processors

LynTec

7030 Grandview
Merriam, KS 66204
(913) 722-4047 FAX: (913) 432-4157
Owner: Lynn Potter
Audio Etc., St. Peters, MO 314-278-4130
PRODUCTS: zoned

**MACKENZIE LABORATORIES,
INC.**

5507 Peck Road
Arcadia, CA 91006
(818) 579-0440 (800) 423-4147 FAX: (818) 448-7131
President: Sam Khoury; Sr. Vice President: Nagy
Khattar; Manager, Sales: Joe Vitale
Audio Etc., St. Peters, MO 314-278-4130

McGohan Electronics

1033 Fairway Dr.
Bensenville, IL 60106
(708) 595-2342 (800) 342-8853 FAX: (708) 595-2919
President: Jim McGohan; Vice President: Ronald
Johnston; Secretary: Helen McGohan; Director
of Engineering: Robert Henderlong
Murphy & Cota Company, Atlanta, GA 404-875-2525
Austin and Associates, Willingboro, NJ 609-871-9290
Malsh Sales, Mulberry, IN 317-296-2322
J.W. Lerner Company, Stow, OH 216-686-1965
Rancillo and Associates, St. Louis, MO 314-845-
0330
Sunrise Sales Company, LaMolle, IL 815-638-2660
PRODUCTS: mixer/ amplifier, mixer/ preamps,
music distribution, signaling, telephone, zoned

Midwest Electronic Industries

4945 W. Belmont Ave.
Chicago, IL 60641
(312) 685-3500 FAX: (312) 685-5286
Marketing: L.T. Chmiel; Marketing: Laurence
Chefalo
Camden Marketing, Pierre Fonds, QU 514-683-3377

OXMOOR CORP.

2111 Parkway Office Circle
Birmingham, AL 35244
(205) 985-7040 FAX: (205) 985-9966
President: Lynn A. McCroskey; Vice President/
Manager: Gary L. West; National Sales Manager:
Richard C. Mitchell; Sales Associate: Nick
Aismiller; Production Manager: Jim Watson;
Director of Engineering: Gene Elghmy
John B. Anthony Company, Stamford, CT 212-
585-2027
ASR, Fallston, MD 301-893-0001
Audio Resources, Westmont, IL 708-655-1180
Dimension IX Marketing, Lewisville, TX
214-436-3706
Evans Sales and Marketing, Nashville, TN
615-297-7997
Loomis and Associates, Fremont, CA 415-
683-0883
Loppnow and Associates, Issaquah, WA
206-392-3936
R.J. Throckmorton Sales Co., Ballwin, MO
314-227-7222
Repworks, Chicopee, MA 413-553-0845
PRODUCTS: music distribution, processors,
zoned

Panasonic Professional Audio Sys.

6550 Katella Avenue
Cypress, CA 90630
(714) 373-7278 FAX: (714) 373-7242
Nat. Sales & Marketing Mgr.: Steve Woolley;
Marketing Manager: Chris Foreman; Western
Regional Sales Mgr.: James Murray; Midwest
Regional Sales Mgr.: Greg Braithwaite; Eastern
Regional Sales Mgr.: Carla Campbell;
Telemarketing Sales Mgr.: Lynn Thompson
James Murray, Cypress, CA 714-373-7389
Greg Braithwaite, Arlington, IL 708-981-7329
Carla Campbell, Norristown, PA 215-630-1651
Cambridge Marketing, Westerville, OH
614-363-9191
PRODUCTS: mixer/ amplifier

Paso Sound Products, Inc.

14 First Street
Pelham, NY 10803
(914) 738-4800 (800) 231-3034 FAX: (914) 738-3954
Executive Vice President: Paul Mastrangelo;
Product Manager: Ken O'Brien; Credit Manager:
Marilyn Beckerson; Operations Manager:
Anthony Squegilla
Anderson Sales, Braintree, MA 617-848-9194
Jack Mesnick Sales, Liverpool, NY 315-622-3211
Paimler Associates, Fairfield, NJ 201-882-1266
Weller Electronic Sales, Inc., Worthington, OH
614-885-7819
Lienau Associates, Columbia, MD 301-621-4113
MJA Marketing, St. Charles, MO 314-447-7111
Northland Assoc., Moorehead, MN 218-233-4616
Allwest Sound & Communication, Camarillo, CA
805-388-7745
Dimension Pt. IX Marketing, Katy, TX 713-578-9277
Mountain Representatives, Denver, CO
303-333-7745
Miguel Lopez, Hialeah, FL 305-822-6853
Paco Electronics, Ltd., Markham, ON 416-475-0740
Robert Milsk Co., Southfield, MI 313-354-3310
Marketline Inc., Snellville, GA 404-972-9048
Hawkins-Frederickson Assoc., Maitland, FL
407-831-2474
Lintern Associates, Naperville, IL 708-904-1225
Robert Milsk Co., Indianapolis, IN 317-842-3400
PRODUCTS: mixer/ amplifier, mixer/ preamps,
modular, music distribution, processors,
telephone

PEAVEY ELECTRONICS CORP.

711 A Street
P.O. Box 2898
Meridian, MS 39301
(601) 483-5365 FAX: (601) 484-4278
CEO: Hartley Peavey; President: Mella Peavey
Dimension/ Point IX, Lewisville, TX 214-436-3706
PRODUCTS: mixer/ amplifier, mixer/ preamps,
modular, music distribution, processors,
signaling

Protech Audio Corporation

Flowerfield Bldg. 1
St. James, NY 11780
(516) 584-5855 FAX: (516) 584-5904
Director of Marketing: Bill Murphy; Sales
Engineering: Joseph Giambone
Peregrine Southwest Reps, Houston, TX 713-589-
8481
First Choice Marketing, Seattle, WA 206-524-7344
Dimension/ Point IX, Lewisville, TX 214-436-3706
PRODUCTS: mixer/ preamps, modular, music
distribution, processors, signaling, zoned

Radio Design Labs

5025 8th Street
Carpinteria, CA 93013
(805) 684-5415 FAX: (805) 684-9316
Director of Engineering: Joel Bump; Dir. of Sales
& Marketing: Jerry Clements
Karp Communications, Tampa, FL 813-968-7098

Rane Corp.

10802 47th Avenue West
Mukiteo, WA 98275-5098
(206) 355-6000
President: Steve Brakken; CEO: Linda Arlink; V.P.
of Manufacturing: Rick Bernard; V.P. of R & D:
Dennis Bohn; V.P. of Marketing: Larry Winter;
National Sales Manager: Ray Bloom
Larry Schirmer, Pontiac, MI 313-340-9588
PRODUCTS: modular, processors



Conversation Piece.

It's the "talk back" voice paging technology everyone is talking about.

If your customers' talk back paging system isn't from Wheelock, they might as well be talking to themselves.

Because Wheelock's amplified talk back systems can give them the kind of performance that's unheard of in two-way telephone-to-speaker communication.

Wherever a telephone is inaccessible or people must respond hands free, a quality talk back system is a must—whether it's for a computer room, laboratory, factory, warehouse, loading dock, auto service center, or hospital operating, exam, x-ray and nursery room.

Featuring an omni-directional microphone and a pre-amplifier for talk back, Wheelock's TBH-104 and TBM-101 speak well for your customers—providing fast, noiseless operation, no word clipping and superior talk back distances, direction and intelligibility. The TBM-101 has a 4" speaker and 1W amplifier for paging, while the TBH-104 has a 4W amplifier and one or two remote horns for paging. Both provide

separate talk back and paging volume controls, as well as a privacy LED.

And Wheelock paging products not only make great conversation, but they offer a wide variety of paging applications, all types of telephone access, zone paging, background music and tone alerting.

Whether it's a 70V central amplifier system or a 24 VDC amplified speaker system...when you choose Wheelock, you've made the right choice. With highly experienced technical support engineers and knowledgeable customer service representatives as close as your phone.

To cash in on Wheelock's 60 years of experience in easy-to-sell, easy-to-install telephone system add-ons, call 800-631-2148. Or contact Wheelock, Inc., 273 Branchport Avenue, Long Branch, NJ 07740.

And let's talk.

wheelock INC.

Circle 211 on Reader Response Card

Dyma Engineering

367 Main S.E.
P.O. Box 1535
Los Lunas, NM 87031
(505) 865-6700 (800) 222-3962 FAX: (505) 865-6776
President: C.G. Cunningham; Vice President: T. Johnson
PRODUCTS: audio/ video, components, digital, matrix, microprocessor, mic splitters, multi boxes, pre-wired, remote controllable, telephone type

Dynair Electronics, Inc.

5275 Market Street.
San Diego, CA 92114
(619) 263-7711 (800) 854-2831 FAX: (619) 264-4181
Vice Pres., Sales & Mktg: Jesse Blount Jr.;
Director of Int'l Mkt'g: Dick Scally; Director,
Western Marketing: Robert Jacobs; Order Desk
Supervisor: Doris Hitchcox
Dynair International, Reading, UK 734-476-571
Dynair Southern USA, Paris, TX 903-784-6268
Dynair Eastern USA, Norfolk, VA 804-482-4545
Dynair Western USA, San Diego, CA 619-263-7711
Edwards Company, Inc., Livonia, MI 313-458-7777

EECO

1601 E. Chestnut Ave.
Santa Ana, CA 92702
(714) 835-6000 FAX: (714) 953-3747

ESE

142 Sierra Street
El Segundo, CA 90245
(213) 322-2136 FAX: (213) 322-8127
President: Jerry Johnson; Vice President/Sales
Manager: Bob Mayers; Marketing Manager:
Brian Way; General Manager: Bill Kaiser
Cambridge Marketing, Westerville, OH
614-363-9191
PRODUCTS: audio/ video, remote controllable

FOSTEX CORPORATION OF AMERICA

15431 Blackburn Ave., Norwalk, CA 90650
(213) 921-1112 (800) 7-FOSTEX
FAX: (213) 802-1964
V.P. Marketing/ General Mgr.: Robert Verli; V.P.
Sales: Mark Cohen
J.B. Parent, Dublin, OH 614-764-0064
PRODUCTS: audio/ video

GEPCO INTERNATIONAL INC.

2225 West Hubbard, Chicago, IL 60612
(312) 733-9555 (800) 966-0069 FAX: (312) 733-6416
President: Gary R. Geppert; Chief Financial
Officer: David B. Mecklenburger; Assistant to the
President: Larry Smith, Sr.; Sales Manager: Larry
Smith, Jr.
Gepeco International Inc., Ocala, FL 904-368-1032
John Anthony, Stamford, CT 203-322-9202
PRODUCTS: audio/ video, cleaners, components,
digital, mic splitters, pre-wired, telephone type

Ghilmetti Inc.

30961 Agoura Rd.
Westlake VIII., CA 91361
(818) 707-1134 FAX: (818) 707-1754
National Sales Manager: Rick Odorfer
John Anthony, Stamford, CT 203-322-9202
PRODUCTS: audio/ video, matrix

H.M. Dyer Electronics

2982 Wixom Rd.
Milford, MI 48042
(313) 685-2560

Hedco

825 K Greenbrier Circle, Chesapeake, VA 23320
(804) 424-0896 (800) 433-2648 FAX: (804) 366-0522
President: John Walter; Sales Manager: Gary
Stephens; Vice President, Marketing: Don
Thompson
Shoreline, Los Angeles, CA 213-461-9800
Advanced Marketing, Redwood City, CA
415-365-3944
Roscor, Chicago, IL 708-947-6801
Wiltronix, Wash. Grove, MD 301-258-7676
DLE, Middleboro, MA 508-947-6801
ADCOM, Toronto, ON 416-251-3355
PRODUCTS: audio/ video, digital, matrix, multi
boxes, remote controllable

Hughes Electronic Devices

P.O. Box 1985
Grass Valley, CA 95945
(916) 273-9524 FAX: (916) 273-6948

INNOVATIVE ELECTRONIC DESIGNS, INC.

9701 Taylorsville Rd., Louisville, KY 40299
(502) 267-7436 FAX: (502) 267-9070
President: Hardy Martin; Vice President, Mkt'g &
Sales: Tom Roseberry; Sales Application
Engineer: Mark Lewellyn; V.P. Research &
Development: Bob Ponto; Vice President,
Engineering: Ed Young; Vice President,
Software: John Johnson
Yore Company, White Bear Lake, MN 612-770-9760
Steffey Marketing Assoc. Inc., Northbrook, IL
708-480-3575
Westech Marketing, Culver City, CA 213-870-9286
Repworks, Chicopee, MA 413-533-0845
Darmstedter Associates, Baldwinville, NY
315-638-1261
John Anthony, Stamford, CT 203-322-9202
Bencsik Associates, Ocala, FL 904-732-9775
C.L. Pugh, Cleveland, OH 216-238-1777
Monford Electronics Marketing, Indianapolis, IN
317-872-8877
C.M. Sales, Farmington Hill, MI 313-553-8070
B.C. Electronic Sales, Mission, KS 913-262-1720
Marketing Concepts, Irving, TX 214-869-0669
Torbett/Kelser Group, Loveland, CO 303-669-1008
Plus Four Marketing, Walnut Creek, CA
415-937-0650
North Shore Marketing, Seattle, WA 206-284-9699
Island Instruments, Kaneohe, HI 808-235-7544
PRODUCTS: digital, matrix, microprocessor, mic
splitters, remote controllable

Intelix

10500 West Reno
P.O. Box 24031, Oklahoma City, OK 73124-4031
(800) 553-8252 FAX: (405) 324-5217
President: Dave Merrey; Marketing Manager:
Todd Rockwell; Hardware Technical Support:
Tracy Cranton; Software Technical Support: Jack
Vig
ADCOM, Toronto, ON 416-251-3355
PRODUCTS: digital, matrix, microprocessor

IRP, A KNOWLES COMPANY

321 Bond Street, Elk Grove VII., IL 60007
(708) 439-3600 (800) 255-6993 FAX: (708) 640-9607
Vice President, General Mgr.: Brian Benn;
Marketing Manager: Roger Carroll; Senior Sales
Engineer: Gayle Campbell; Marketing
Coordinator: Laura Valavicius; Applications
Engineer: Norm Kinnaugh; Product Engineering
Manager: Mitch Bentz
Piper and Givan Assoc., Needham, MA
617-449-1144
Sigmat Corp., Freehold, NJ 201-462-1221

Richard S. Pass Associates, Langhorne, PA
215-757-6100
Henry W. Phillips Co., Rosewell, GA 404-992-3070
Bencsik Associates, Ocala, FL 904-732-9775
C.B. Electronic Marketing, Arvada, CO
303-422-0561
Avwest Inc., Fountain Hills, AZ 602-946-1811
EESCO Systems Inc., Los Angeles, CA 213-666-9601
Pappas Consulting, Menlo Park, CA 415-324-4325
Chuck Olson Assoc., Renton, WA 206-271-5416
Kaltex Communications, North Vancouver, BC
604-987-1597
More Technologies Inc., Los Angeles, CA
213-474-4211
Audio Marketing Assoc., Brecksville, OH
216-526-2426
Starlin Marketing, Chesterton, IN 219-929-4127
MJA Marketing, St. Charles, MO 314-447-7111
Graham Davis Inc., Dallas, TX 214-357-7677
PRODUCTS: matrix

J.N.S. Electronics, Inc.

P.O. Box 32550, San Jose, CA 95152
(408) 729-3838 FAX: (408) 926-1003
President: John E. Leonard, Jr.
ADCOM, Toronto, ON 416-251-3355

Lester Audio Laboratories

1111 W. Mockingbird La. #1342
Dallas, TX 75247
(214) 637-9311 FAX: (214) 637-9314
President: Laszlo Olah; VP of Administration:
Jennings Woodard; V.P. of Manufacturing:
Daniel Alvarado; Executive Assistant: Magdi
Takacs
Plarmec, U.K., 025-272-1236
Ace Music, , 407-629-2288
Dobbs-Stanford, , TX 214-358-0800
Bencsik & Associates, , FL 904-732-9775
High Tech Audio, , CA 415-726-2428
Audio Etc., St. Peters, MO 314-278-4130
PRODUCTS: digital, matrix

LynTec

7030 Grandview, Merriam, KS 66204
(913) 722-4047 FAX: (913) 432-4157
Owner: Lynn Potter
Audio Etc., St. Peters, MO 314-278-4130
PRODUCTS: matrix, remote controllable

Novadyne

P.O. Box 5508
San Mateo, CA 94402-0508
(415) 349-3241 FAX: (415) 579-1203
Jim Burger, Philadelphia, PA 203-297-7160

OXMOOR CORP.

2111 Parkway Office Circle
Birmingham, AL 35244
(205) 985-7040 FAX: (205) 985-9966
President: Lynn A. McCroskey; Vice President/
Manager: Gary L. West; National Sales Manager:
Richard C. Mitchell; Sales Associate: Nick
Alsmiller; Production Manager: Jim Watson;
Director of Engineering: Gene Elghy
John B. Anthony Company, Stamford, CT 212-
585-2027
ASR, Fallston, MD 301-893-0001
Audio Resources, Westmont, IL 708-655-1180
Dimension IX Marketing, Lewisville, TX 214-436-3706
Evans Sales and Marketing, Nashville, TN
615-297-7997
Loomis and Associates, Fremont, CA 415-683-0883
Lopphow and Associates, Issaquah, WA
206-392-3936
R.J. Throckmorton Sales Co., Ballwin, MO
314-227-7222
Repworks, Chicopee, MA 413-553-0845
PRODUCTS: matrix, remote controllable

Patch Bay Designation Co.

4742 San Fernando Rd.
Glendale, CA 91204
(818) 241-5585 FAX: (818) 507-5050
President: Ted Lookholder; Manager: Charles Schufer; Vice President: Dale Lookholder
Camden Marketing, Pierre Fonds, QU 514-683-3377

PEAVEY ELECTRONICS CORP.

711 A Street
P.O. Box 2898
Meridian, MS 39301
(601) 483-5365 FAX: (601) 484-4278
CEO: Hartley Peavey; President: Mella Peavey
Dimension/ Point IX, Lewisville, TX 214-436-3706

Protech Audio Corporation

Flowerfield Bldg. 1
St. James, NY 11780
(516) 584-5855 FAX: (516) 584-5904
Director of Marketing: Bill Murphy; Sales Engineering: Joseph Giambone
Peregrine Southwest Reps, Houston, TX 713-589-8481
First Choice Marketing, Seattle, WA 206-524-7344
Dimension/ Point IX, Lewisville, TX 214-436-3706
PRODUCTS: matrix, mic splitters, remote controllable

RCI Systems, Inc.

5615 Fishers Lane
Rockville, MD 20852
(301) 984-1800 (800) 765-4RCI FAX: (301) 984-6175
President: Jay W. Klingery; East Coast Audio Rep.: Brian K. Gross; Midwest Audio Rep.: Gordon Jacobs; West Coast Audio Rep.: Doug Macuch; Midwest Fact. Rep.: Total Mktg: David Taylor; Mid-Atlantic Fact. Rep.: Steve Taub
Sunrise Sales Company, LaMolite, IL 815-638-2660
PRODUCTS: audio/ video, mic splitters, multi boxes, pre-wired

S.E.M. Co.

#17-636 Clyde Ave.
W. Vancouver, BC V7T 1E1
(604) 922-0526 FAX: (604) 922-0526
President: Elk Ebert; Vice President: Anne Moretti
Karp Communications, Tampa, FL 813-968-7098
PRODUCTS: audio/ video, mic splitters, remote controllable, telephone type

Sierra Video Systems

13046 Loma Rica Drive
P.O. Box 2462
Grass Valley, CA 95945
(916) 273-9331 FAX: (916) 273-9390
Karp Communications, Tampa, FL 813-968-7098

Sony Corp./Business & Pro. Aud. Grp

3 Paragon Drive
Montvale, NJ 07645-1735
(201) 930-1000
President, Sales & Marketing: Mark Gray; Senior VP Sales: C.F. Taylor; V.P. Product Marketing: Anthony Gargano; Marketing Manager, Pro Audio: Courtney Spencer; Sales Manager, Pro Audio: Gary Rose; V.P. Audio Products: Ron Remschel
Matt Robertson, Western Dist., 213-469-9084
Audio Etc., St. Peters, MO 314-278-4130
PRODUCTS: audio/ video

Soundstream Technologies

120 Blue Ravine Road
Folsom, CA 95630
(916) 351-1288 FAX: (916) 351-0414
President: Donna Haas; Managing Director: Lee Adams; Director of Engineering: Wade Stewart; Ntl. Sales Mgr., Home Audio: Scott McAllister; Sales Engineer, Home Audio: Andrew Murray
John W. Steinberg Company, Encino, CA 818-705-7772
Moskau & Associates, Dallas, TX 214-821-4280
Creative Marketing Associates, Nashville, TN 615-831-9690
On Line Marketing, Wadsworth, OH 216-336-7504
Sound Marketing, Palos Hills, IL 708-598-6888
Cambridge Marketing, Westerville, OH 614-363-9191
PRODUCTS: audio/ video, remote controllable

STENTOFON COMMUNICATIONS, INC.

6119 Connecticut Avenue
Kansas City, MO 64120
(816) 231-7200 (800) 654-3140 FAX: (816) 231-7203
President: Joe Green; Marketing Manager: David E. Gill; National Sales Manager: Frederick Hall
Dan Rothrock, Kansas City, MO 816-231-7200
Tomas J. Reilly, Elmsford, NY 914-592-1048
Kerry L. Orr, Atlanta, GA 404-973-0736
Michael A. Wilcock, Glendora, CA 818-335-0543
Cartwright & Bean, Inc., Norcross, GA 404-368-0160
Dimension/ Point IX, Lewisville, TX 214-436-3706
Humble & Associates, Anaheim, CA 714-750-2248
LCA Sales Company, Tuckahoe, NY 914-961-4700
Levy, Grams, & Lassers, North Brook, IL 708-272-8500
Pearson & Pearson, Englewood, CO 303-770-0797
Roger Ponto Assoc., Inc., Kirkland, WA 206-821-2996
R.W. Kunz & Assoc., Inc., Prairie Village, KS 913-648-3535
R.W. Sales, St. Paul, MN 612-646-2710
Brian Trankle & Assoc., Belmont, CA 415-595-4004
F.M. Valenti, Inc. & Assoc., Nahant, CA 617-592-5300
Yocum Marketing Co., Inc., Mesa, AZ 602-834-3334
Weller Electronic Sales, Inc., Worthington, OH 614-885-7819
PRODUCTS: matrix, microprocessor

Trimm

400 W. Lake St.
Libertyville, IL 60048
(312) 362-3700 FAX: (312) 680-3888
Camden Marketing, Pierre Fonds, QU 514-683-3377

TSI (Tamco Systems Inc.)

393 Jericho Turnpike
Mineola, NY 11501
(516) 294-5390 (800) 628-2084 FAX: (516) 294-5008
CEO: Mario Maitese; President: Garani Srinivasan; President (Spec. Prod. Div.): Richard Stillwell; Sales Coordinator: Denise Matejka; Marketing Manager: Karen Pepe
JMS Marketing, Austin, TX 512-266-1113
PRODUCTS: audio/ video, remote controllable

Uptown Technologies, Inc.

4015 Walnut Street
Fort Atkinson, WI 53538
(414) 563-9932 FAX: (414) 563-8342
President: Al Jewer; Vice President, Sales: David Hill; Vice President, Manufacturing: Don Hay; Product Specialist: Jay Craggs
Hudson Marketing, Roslyn Heights, NY 516-625-0002
Syncopated Marketing, Silver Springs, MD 301-593-6610
Ron Tunks Sales, Tamarac, FL 305-722-2803
Shea-Lewis Sales, Chicago, IL 312-561-7086
Sound Sales, Inc., Columbia, MD 301-964-1170
PRODUCTS: audio/ video

Utah Scientific, Inc.

4750 Wiley Post Way
Salt Lake City, UT 84116
(801) 575-8801 (800) 453-8782 FAX: (801) 575-3299
National Sales Manager: Thomas Harmon; International Sales Manager: Joseph French; Marketing Manager: Doug Akers
Cambridge Marketing, Westerville, OH 614-363-9191

Wohler Technologies

1349 Kansas Street
San Francisco, CA 94107
(415) 285-5462 FAX: (415) 821-6414
Larry Schirmer, Pontiac, MI 313-340-9588
PRODUCTS: audio/ video



Anchor Audio

913 West 223rd Street
Torrance, CA 90502
(213) 533-5984 (800) ANCHOR-1
FAX: (213) 533-6050
Nova Marketing, San Francisco, CA 415-952-0943



Ashly Audio, Inc.

100 Fernwood Ave.
Rochester, NY 14621
(716) 544-5191 (800) 828-6308 FAX: (716) 266-4584
President: Bill Thompson; Senior Vice President: Bob French; Vice President: Dave Malloy; Operations Manager: Ellen Price
ADCOM, Toronto, ON 416-251-3355
PRODUCTS: amplifiers, mixer amplifiers, mixers, processors

Audio Centron

1400 Ferguson Ave.
St. Louis, MO 63133
(314) 727-4512 FAX: (314) 727-8929
Audio Etc., St. Peters, MO 314-278-4130

**Find Your Suppliers in the
Sound & Communications
Blue Book**

BOSE CORP.

The Mountain
Framingham, MA 01701-9168
(508) 879-7330 FAX: (508) 872-6640
National Sales Manager: Timothy Dorwart;
Eastern Reg. Sales Manager: Bruce Hurst;
Western Reg. Sales Manager: Tim Landwehr; Sr.
Applications/Des. Spec.: Bruce Myers; Sr. Sales
Representative: Reed Strutzenberg; Sales
Representative: Phil Nelson
HC Garrison Co., Tualatin, OR 503-638-4906
Westech Marketing, Culver City, CA 213-870-9286
Silver Peak Marketing, Wheat Ridge, CO 303-467-
9042
Ranillo Assoc., St. Louis, MO 314-845-0202
CR Marketing, Clarkston, MI 313-625-2420
J.B. Parent, Dublin, OH 614-764-0064
Secom Systems, Atlanta, GA 404-455-0672
Bencslk Assoc., Ocala, FL 904-732-9775
Sigmet Corp., Valley Forge, PA 215-783-6666
Joseph P. Mazzeo Assoc., Inc., Rochester, NY 716-
458-7851
Peter E. Schmitt Co., Inc., Leonia, NJ 201-944-2806
PRODUCTS: lecterns, powered speakers,
speakers, weatherproof speakers

Carvin Corporation

1155 Industrial Avenue
Escondido, CA 92029
(619) 747-1710 (800) 854-2235
Sales Manager: Nell Taylor
Edwards Company, Inc., Livonia, MI 313-458-7777
PRODUCTS: amplifiers, mixer amplifiers, mixers

Dukane Corp.

2900 Dukane Drive
St. Charles, IL 60174
(708) 584-2300 FAX: (708) 584-2370
President/C.E.O.: J. McWilliams Stone Jr.;
Pres./Comm. Systems Division: Steven L. Deppe;
National Sales Director: Warren T. Anderson;
Service Manager: Cliff Carlson
Wally Smutts, Toronto, ON 519-748-5352
Doug Fellabaum, Sycamore, IL 815-895-7573
Ken Lind, Boston, MA 617-235-6817
Pete Kendall, Jacksonville, FL 904-262-6025
Jim Lacey, Moreno Valley, CA 714-243-1160
Jack Brown, Dallas, TX 214-943-7528
Sanford Lange, Indianapolis, IN 317-251-3112
PRODUCTS: amplifiers, columns, mixer
amplifiers, speakers

Fanon Courier

14811 Myford Road
Tustin, CA 92680
(714) 669-9890 (800) 345-1354 FAX: (714) 669-1081
President: Frank Blaha; Director Sales &
Marketing: Murray Trotiner; Director of
Engineering: Miguel Santana
Greg Dzuby & Assoc., Glendale, AZ 800-999-0006

IRP, A KNOWLES COMPANY

321 Bond Street
Eik Grove VII., IL 60007
(708) 439-3600 (800) 255-6993 FAX: (708) 640-9607
Vice President, General Mgr.: Brian Benn;
Marketing Manager: Roger Carroll; Senior Sales
Engineer: Gayle Campbell; Marketing
Coordinator: Laura Valavclius; Applications
Engineer: Norm Kinnaugh; Product Engineering
Manager: Mitch Bentz
Piper and Givan Assoc., Needham, MA
617-449-1144
Sigmet Corp., Freehold, NJ 201-462-1221
Richard S. Pass Associates, Langhorne, PA
215-757-6100
Henry W. Phillips Co., Rosewell, GA 404-992-3070
Bencslk Associates, Ocala, FL 904-732-9775

C.B. Electronic Marketing, Arvada, CO
303-422-0561
Avwest Inc., Fountain Hills, AZ 602-946-1811
EESCO Systems Inc., Los Angeles, CA 213-666-9601
Pappas Consulting, Menlo Park, CA 415-324-4325
Chuck Olson Assoc., Renton, WA 206-271-5416
Kaltec Communications, North Vancouver, BC
604-987-1597
More Technologies Inc., Los Angeles, CA
213-474-4211
Audio Marketing Assoc., Brecksville, OH
216-526-2426
Starlin Marketing, Chesterton, IN 219-929-4127
MJA Marketing, St. Charles, MO 314-447-7111
Graham Davis Inc., Dallas, TX 214-357-7677
PRODUCTS: amplifiers, mixer amplifiers, mixers,
processors

J.W. DAVIS AND CO.

3030 Canton Street
Dallas, TX 75226
(214) 651-7341 (800) 527-5705 FAX: (214) 939-0328
President: Harvey Earp; Vice President, Sales:
Jack W. Tucker; Chief Engineer: Eric Simonson
Multi-Technical Reps., Brainerd, MN 218-828-9483
PRODUCTS: amplifiers, columns, lecterns,
megaphones, mixer amplifiers, mixers, speakers,
weatherproof speakers

JBL Professional

8500 Balboa Boulevard
P.O. Box 2200
Northridge, CA 91329
(818) 893-8411 FAX: (818) 893-3639
President: Ronald Means; Vice President, Sales:
Ken Lopez; Vice President, Marketing: Mark
Gander; Market Manager: Hector Martinez;
National Sales Manager: Nell Conley
Jim Chase, San Clemente, CA 714-492-6290
Bill Hamilton, Folsom, PA 215-543-4677
Bill Schuermann, Houston, TX 713-370-5553
Tom Walter, No. Barrington, IL 312-382-4925
ADCOM, Toronto, ON 416-251-3355
PRODUCTS: amplifiers, mixers, processors,
speakers

Komotech - (Lite-Sonic) Inc.

1108 W. Valley Blvd. #206
Alhambra, CA 91754
(818) 280-2565 FAX: (818) 282-6848
Cambridge Marketing, Westerville, OH
614-363-9191

Lectrosonics, Inc.

P.O. Box 15900
Rio Rancho, NM 87174
(505) 892-4501 (800) 821-1121 FAX: (505) 892-6243
President: John Arasim; Vice President
Engineering: Larry Fisher; Vice President Mktg &
Sales: Bruce Jones
C.L. Pugh & Associates, Cleveland, OH 216-238-
1777
PRODUCTS: DC battery powered

MagnaSound - div. of UXL Corp.

108-02 Otis Avenue
Corona, NY 11368
(718) 271-5200 FAX: (718) 271-5738
President: Benjamin Frankenstein; Secretary:
Dorothy Davis; Sales & Marketing: Nell Howard
Audio Etc., St. Peters, MO 314-278-4130
PRODUCTS: DC battery powered, powered
lecterns

Paso Sound Products, Inc.

14 First Street
Pelham, NY 10803
(914) 738-4800 (800) 231-3034 FAX: (914) 738-3954
Executive Vice President: Paul Mastrangelo;
Product Manager: Ken O'Brien; Credit Manager:
Marilyn Beckerson; Operations Manager:
Anthony Squeglia

Anderson Sales, Braintree, MA 617-848-9194
Jack Mesnick Sales, Liverpool, NY 315-622-3211
Palmieri Associates, Fairfield, NJ 201-882-1266
Weller Electronic Sales, Inc., Worthington, OH
614-885-7819
Lienau Associates, Columbia, MD 301-621-4113
MJA Marketing, St. Charles, MO 314-447-7111
Northland Assoc., Moorehead, MN 218-233-4616
Allwest Sound & Communication, Camarillo, CA
805-388-7745
Dimension Pt. IX Marketing, Katy, TX 713-578-9277
Mountain Representatives, Denver, CO
303-333-7745
Miguel Lopez, Hialeah, FL 305-822-6853
Paco Electronics, Ltd., Markham, ON 416-475-0747
Robert Milk Co., Southfield, MI 313-354-3310
Marketline Inc., Snelville, GA 404-972-9048
Hawkins-Frederickson Assoc., Maitland, FL
407-831-2474
Lintern Associates, Naperville, IL 708-904-1225
Robert Milk Co., Indianapolis, IN 317-842-3400
PRODUCTS: amplifiers, columns, DC battery
powered, lecterns, megaphones, mixer
amplifiers, mixers, powered lecterns, powered
speakers, processors, speakers, weatherproof
speakers, wireless

PEAVEY ELECTRONICS CORP.

711 A Street
P.O. Box 2898
Meridian, MS 39301
(601) 483-5365 FAX: (601) 484-4278
CEO: Hartley Peavey; President: Mella Peavey
Dimension/ Point IX, Lewisville, TX 214-436-3706
PRODUCTS: amplifiers, batteries, columns, DC
battery powered, lecterns, mixer amplifiers,
mixers, powered lecterns, powered speakers,
processors, speakers, weatherproof speakers,
wireless

Perma Power Electronics, Inc.

5601 W. Howard St.
Chicago, IL 60648
(312) 763-0763 (800) 323-4255 FAX: (312) 763-8336
Chairman, CEO: Norman Ackerman; President:
Leonard Abrahamson; Nat'l Sales Mgr., Comp.
Mkts: Ernest Weinberg; Director of Engineering
William Grossman; Nat'l Sales Mgr., Elec. Mkts:
Michael Shatz; V.P., Administration: Harris
Prince
Landan & Mack, Plainville, NY 516-293-3310
Teqni-Rep, Sun Valley, CA 818-768-4223
Adams & Assoc., Greensboro, NC 919-272-6838
Benthold Sales, Dallas, TX 214-328-0067
Fany Mkt., Maniton, NJ 609-985-6444
Dimension/ Point IX, Lewisville, TX 214-436-3706
PRODUCTS: amplifiers, DC battery powered,
lecterns, megaphones, powered lecterns

Rauland-Borg Corp.

3450 W. Oakton St.
Skokie, IL 60076
(708) 679-0900 FAX: (708) 679-0625
President: William Krucks; Executive Vice
President: Kenneth James; National Sales
Manager: Harry Hahn; Marketing Manager:
Vince Novak
Jack Hollis, Geneva, IL 708-208-1488
Joe Clotti, Longwood, FL 407-767-2007
Frank Riha, Austin, TX 512-926-3646
Hank Plaisier, El Toro, CA 714-837-2626
Vince Ward, Vashon Island, WA 206-463-5582
Doug Warren, Newport News, VA 804-930-3217
Suzanne Graham, Kent, OH 216-678-7307
Mike Gulhan, E. Long Meadow, MA 413-525-6090

Sieler Design Products

1308 W. 130th Street
P.O. Box 2128
Cardena, CA 90247
(213) 324-9663
President: Patrice Sieler
Karp Communications, Tampa, FL 813-968-7098
PRODUCTS: DC battery powered, powered speakers

STUDIOMASTER INC.

3941 Miraloma Avenue
Anahelm, CA 91719
(714) 524-2227 FAX: (714) 524-5096
President: Paul Reeve; National Sales Manager: Jim Giordano
J.B. Parent, Dublin, OH 614-764-0064
PRODUCTS: amplifiers, mixer amplifiers, mixers

TELEX COMMUNICATIONS, INC.

9600 Aldrich Avenue South
Minneapolis, MN 55420
(612) 884-4051 FAX: (612) 884-0043
President: Jeffrey Wetherell; Vice President Marketing: John Schofield; Vice President Sales: Dan Dantzier; Director of Marketing: Don Mereen; Manager/Advertising & Mkt'g: Ron Taylor
WesTech Marketing, Culver City, CA 213-870-9286
Bencsik Associates, Ocala, FL 904-732-9775
Burcaw Company & Associates, Warren, MI 313-573-4605
SAGA, Oswego, NY 315-343-5739
Monfort Electronic Marketing, Indianapolis, IN 317-872-8877
Murphy & Cotta, Inc., Atlanta, GA 404-875-2525
Northland Associates, Moorhead, MN 218-233-4616
Rancillo Associates, Inc., St. Louis, MO 314-845-0202
J.Y. Schoonmaker Company, Dallas, TX 214-349-1650
Sigmat Corporation, Valley Forge, PA 215-783-6666
Weller Electronic Sales, Worthington, OH 614-885-7819
Ziskind Associates, Rolling Meadows, IL 312-577-1624
White Radio Ltd., Burlington, ON 416-632-6894
Silver Peak Marketing, Denver, CO 303-467-9042
PacNor Marketing, Lynnwood, WA 206-771-6016
PRODUCTS: amplifiers, mixer amplifiers, wireless

**TOA ELECTRONICS, INC.**

601 Gateway Blvd. Suite 300
P.O. Box 2047
S San Francisco, CA 94080
(415) 588-2538 (800) 733-4750 FAX: (415) 588-3349
President: Yoshiro Ishida; Director, Audio Products Div: Richard Krochmal; Director, Comm. Systems Div.: Al Burns; Mgr., Marketing Development: Jeff Pallin; Manager, Western Division: Bill Ford; Manager Engineering Services: Bob Sweet
Chuck McGregor- Product Conslt, Morris Plains,

NJ 201-829-7047
John Murray-Eng.Snd. Mktg. Dev, Springfield, OH 513-324-1993
Bob Hager-Eastern Regional Mgr, Rosewell, GA 404-552-7624
Linda Wick-Central Reg. Mgr., Kansas City, MO 816-453-5775
Robert Slaughter-Cntrl Div Mgr, Houston, TX 713-460-3678
Pete Newmark-West Regional Mgr., Mesa, AZ 602-981-0050
Walter Best, Eastern Reg. Mgr., Sussex, NJ 201-702-0068
PRODUCTS: amplifiers, megaphones, mixer amplifiers, wireless

WISSCO

1599 Superior Avenue, A-1
Costa Mesa, CA 92627
(714) 645-1281 (800) 854-6280 FAX: (714) 642-4292
President: Jeanne Wanlass
Cambridge Marketing, Westerville, OH 614-363-9191
PRODUCTS: amplifiers, batteries, columns, DC battery powered, lecterns, megaphones, mixer amplifiers, mixers, powered lecterns, powered speakers, speakers, weatherproof speakers, wireless

**Bi-Tronics, Inc.**

76 Main Street
P.O. Box 125, Tuckahoe, NY 10707
(914) 961-2004 (800) 666-0996 FAX: (914) 961-4244
President: J. Schwartz; Engineering Sales Manager: Ron Huppert; Sales Administrator: C. Viofare
J.B. Parent, Dublin, OH 614-764-0064
PRODUCTS: line protectors, outlet strips, transformers

Commercial Sound Labs/ Cytech Ltd.

25416 CR 6 Suite 401, Elkhart, IN 46514
(219) 262-0776 FAX: (219) 262-9201
Manager: Joe Wisler; Cytech Manager: John Bachman; President: Clay Barclay
PCM Marketing, Walnut Creek, CA 415-935-0900
Kodo Associates, Minneapolis, MN 612-881-1255
Sigmat, Valley Forge, PA 215-783-6666
Audio Marketing, Brecksville, OH 216-526-2426
Secom Systems, Doraville, GA 404-445-0672
Sound Sales, Inc., Columbia, MD 301-964-1170

Deltec Electronics Corp.

2727 Kurtz Street, San Diego, CA 92110
(619) 291-4211 (800) 854-2658 FAX: (619) 291-2584
President: Raymond E. Meyer; Senior Vice President of Sis: Jeffrey M. Frank; Vice President of Finance: Barney McWilliams; Vice President of Operations: David J. McDonald; Director of Marketing: Susan Connell; V.P. of Engineering: Howard Handler, PhD.
Preclde, Morbio Inferiore, Switzerland, 914-31734

Dynamote Corporation

1200 W. Nickerson
Seattle, WA 98119
(206) 282-1000 (800) 426-2838 FAX: (206) 283-7714
President: Steve Handley; Director of Marketing Valerie Smith; V.P., Marketing: Mark Smock
Edwards Company, Inc., Livonia, MI 313-458-7777
PRODUCTS: Inverters

ETA Lighting Systems

1716 Enterprise Parkway
Twinsburg, OH 44087
(216) 425-3388 FAX: (216) 425-9700
President: Victor C. Pavona
Greg Dzubay & Assoc., Glendale, AZ 800-999-0006

Ethereal Concepts

750 La Playa- 1100
San Francisco, CA 94121
(415) 750-0431
PRODUCTS: power control

Furman Sound, Incorporated

30 Rich Street
Greenbrae, CA 94904
(415) 927-1225 FAX: (415) 927-4548
President: Jim Furman; Vice President: Susan Furman; Sales Manager: Joe Desmond; Chief Engineer: Gary Kephart
Metropolis Audio Marketing, New York, NY 908-225-0085
Pacific Audio Group, Gardena, CA 213-719-1383
SF Marketing, St. Laurent, QU 514-733-5344
New Horizons, Bannockburn, IL 708-234-6500
Secom Systems, Atlanta, GA 404-455-0672
Greg Dzubay & Assoc., Glendale, AZ 800-999-0006
PRODUCTS: line protectors, noise suppression, outlet strips, power control, power conversion, transformers

Linear & Digital Systems

46 Marco Ln.
Centerville, OH 45459
(513) 439-1758

LynTec

7030 Grandview
Merriam, KS 66204
(913) 722-4047 FAX: (913) 432-4157
Owner: Lynn Potter
Audio Etc., St. Peters, MO 314-278-4130
PRODUCTS: power control

One Power

7320 Ashcroft #104
Houston, TX 77081
(713) 772-1404 FAX: (713) 772-9124
President: Fred Sieber; Vice President: Peter M. Cook; Production/Design Mgr.: Robert A. Hunter; Administrative Coordinator: Lisa M. Hill
AMH Sales, Torrance, CA 213-373-2034
Marketing Concepts, Irving, TX 214-869-0689
Midwest Audio Marketing, Steger, IL 708-672-3056
Sigmat Corporation, Freehold, NJ 201-462-1221
First Choice Marketing, Seattle, WA 206-365-4568
Doug Warren, Newport News, VA 804-930-3217

Polyphaser

1425 Industrial Way
Gardnerville, NV 89410-1237
(702) 782-2511 FAX: (702) 782-4476
Audio Etc., St. Peters, MO 314-278-4130

RTE Deltec

2727 Kurtz Rd., San Diego, CA 92110
(619) 291-4211
Camden Marketing, Pierre Fonds, QU 514-683-3377

SL Waber Inc.

520 Fellowship Road
S-306, Mt. Laurel, NJ 08054
(609) 866-8888 (800) 634-1485 FAX: (609) 866-1945
Vice Pres. Sales & Marketing: Kevin Woznicki;
Sales Manager: Glenn Emery; Director of
Engineering: Jeff Wright; Director of Marketing:
Bob Eastwood
Karp Communications, Tampa, FL 813-968-7098
PRODUCTS: line protectors, noise suppression,
outlet strips, uninterrupted power

Sola

1717 Busse Road, Elk Grove Vlg., IL 60007
(708) 439-2800 (800) 289-7652 FAX: (800) 626-6269
President: Henry West; Vice President,
Marketing: Ruxton Tucker; Vice President, Sales:
James Kimball; Vice President, Engineering: Bill
Skelton
Karp Communications, Tampa, FL 813-968-7098
PRODUCTS: Inverters, line Isolators, line
protectors, noise suppression, power control,
power conversion, transformers, uninterrupted
power

SONANCE

961 Calle Negocio, San Clemente, CA 92672
(714) 492-7777 (800) 582-7777 FAX: (714) 361-2705
President: Scott Struthers; Vice President:
Geoff Spencer; Sales Manager: Dave Donald;
International Sales Manager: Mark Cichowski;
Public Relations Director: Mitch Simon; Dir. Sis
Trn. & Mkt. Research: Kevin Leja
Morris Tait and Assoc., Los Angeles, CA 213-877-4424
Bach Sales, New York, NY 212-727-0404
Tandem Marketing, Chicago, IL 708-605-1960
Dobbs Stanford, Dallas, TX 214-358-0800
Balaton Marketing, Washington DC, 202-471-1764
MJA Marketing, St. Charles, MO 314-447-7111
PRODUCTS: outlet strips

Square D/Topaz Products

9192 Topaz Way
San Diego, CA 92123
(619) 279-0111 FAX: (619) 569-8427
Sales & Marketing Mgr.: Gary Jasinski; Product
Marketing Mgr.: Tom Kilpatrick
Camden Marketing, Pierre Fonds, QU 514-683-3377
PRODUCTS: Inverters, line Isolators, line
protectors, noise suppression, power
conversion, transformers, uninterrupted power

Taylor-Simtec Digital

221-A W. Main St.
Taylors, SC 29687
(803) 268-7592 FAX: (803) 268-7596
Camden Marketing, Pierre Fonds, QU 514-683-3377

Tripp Lite

500 N. Orleans
Chicago, IL 60610-4188
(312) 329-1777 FAX: (312) 644-6505
National Sales Manager: Ray Foster; Account
Manager: Dave Slotten; Technical Support
Manager: Bert Brook
JMS Marketing, Austin, TX 512-266-1113
PRODUCTS: Inverters, line Isolators, line
protectors, noise suppression, outlet strips,
power control, power conversion, power relays,
transformers, uninterrupted power

Whitenton Industries

7320 Ashcroft #302
Houston, TX 77081
(713) 772-1404 FAX: (713) 772-9124
Audio Etc., St. Peters, MO 314-278-4130

**AMX Corporation**

12056 Forestgate Drive
Dallas, TX 75243
(214) 644-3048 (800) 222-0193 FAX: (214) 907-2053
President: Scott Miller; Vice President of Sales:
William V. Anderson; Executive Vice President:
Art Chace; International Sales Manager: Ken
Sciater; Director of Marketing: Eric Johansen
Franklin Communications, Maple Glen, PA 215-
643-3031
Visitech Marketing Assoc., Elburn, IL 708-365-9600
KBZ Communications, Furlong, PA 215-348-9481
Westech Marketing, Culver City, CA 213-870-9286
Total Marketing, Ft. Worth, TX 817-560-3970
Karp Communications, Tampa, FL 813-960-7667
Richard Krudop, Andalusia, AL 205-222-8950
Pancor Marketing, Lynnwood, WA 206-771-6016
PRODUCTS: A/V, audio level, boardroom, custom,
DTMF, EQ/remote, hardwired, microprocessor,
remote monitoring, video, wireless

Ancha Electronics Inc.

5540 Meadowbrook Court
Rolling Meadows, IL 60008-3800
(708) 437-7712 FAX: (708) 437-0271
President: Robert F. Ancha; Vice President,
Finance: Margaret Broch; Vice President, Sales &
Mktg: Steve Youngson; Vice President, Design:
Richard Tollberg; Vice Pres., Administration: R.C.
Ancha
Ancha Electronics Inc., Atlanta, GA 404-446-5894
Ancha Electronics Inc., Tampa, FL 813-626-0350
Nova Marketing, San Francisco, CA 415-952-0943

Aphex Systems

11068 Randall Street
Sun Valley, CA 91352
(818) 767-2929 FAX: (818) 767-2641
President: Marvin Caesar; Vice President: Hugh
Wilcox; Sales Manager: Paul Freudenberg
Gould Marketing, Inc., Montreal, Quebec, 514-
342-4441
Clueco Pro Division, Paris, France, 331-43596159
AKC Acoustics, Munich, Germany, 498-9 87 160
Otaritec Corporation, Tokyo, Japan,
813-392-7811
Sound Technology, Letchworth, UK 444-62480800
Nova Marketing, San Francisco, CA 415-952-0943
PRODUCTS: custom, remote monitoring

APPLIED TECHNICAL SYSTEMS

815 King Pl.
Shreveport, LA 71115
(318) 868-7413 (800) 444-7161 FAX: (318) 631-7613
President: Jim Reccelli; Vice President: Richard
Davis
C.L. Pugh & Associates, Cleveland, OH 216-238-
1777
Total Marketing, Fort Worth, TX 817-560-3970
Western Audio Sales, Burbank, CA 818-954-9300
PRODUCTS: custom, microprocessor, wireless

Audioaccess

26046 Eden Landing Rd. Ste. 5
Hayward, CA 94545
(510) 293-0183 FAX: (510) 293-0189
President: Chris Stevens; Operations & Sales
Manager: Bruce Tenenbaum; Engineering
Manager: Bill Orner; Production Manager: Kevin
Wilson; Technical Cust. Service Mgr.: Mark
Fowles

Crestron Electronics, Inc.

101 Broadway
Cresskill, NJ 07626
(201) 894-0660 (800) 237-2041 FAX: (201) 894-1192
Sales & Marketing Manager: Randy Klein
Robert Christopher Sales, New Milford, NJ
201-261-5560
Robert Christopher Sales, Whitefish Bay, WI
414-332-6555
RSI, Irving, TX 214-256-4551
Loomis & Associates, Freemont, CA 415-683-0883
Presentation Resources, Inc., Maudlin, SC
803-288-8840
Taub Sales, Silver Springs, MD 301-662-9100
PRODUCTS: A/V, audio level, boardroom, custom,
DTMF, hardwired, microprocessor, video,
wireless

Elkay Industries

2925 North Market St.
St. Louis, MO 63106
(314) 535-1333 FAX: (314) 535-4118
CEO/ENG: Richard Hahn; President: Paul Grote;
Vice President, Sales: Martin Hahn; Engineering:
Jack Scilligo
Edwards Company, Inc., Livonia, MI 313-458-7777

FSR Inc.

244 Bergen Boulevard
West Paterson, NJ 07424
(201) 785-4347 (800) 332-3771 FAX: (201) 785-3318
President: William C. Fitzsimmons; Vice
President: Janice Sandri; Engineering Manager:
Joseph Fischer; Special Projects Manager: John
Macaluso; Manager, Metal Products: Joseph
Amico
Sigmat Corporation, Valley Forge, PA
215-783-6666
Peregrine Southwest, Houston, TX 713-589-8481
Henry W. Phillips Inc., Roswell, GA 404-992-3070
Piper and Civan Associates, Needham, MA
617-449-1144
Design Factors, Hacienda Hts., CA 213-697-7576
Cambridge Marketing, Westerville, OH
614-363-9191
PRODUCTS: A/V, boardroom, custom, hardwired,
microprocessor, video, wireless

**INNOVATIVE ELECTRONIC
DESIGNS, INC.**

9701 Taylorsville Rd.
Louisville, KY 40299
(502) 267-7436 FAX: (502) 267-9070
President: Hardy Martin; Vice President, Mkt'g &
Sales: Tom Roseberry; Sales Application
Engineer: Mark Lewellyn; V.P. Research &
Development: Bob Ponto; Vice President,
Engineering: Ed Young; Vice President,
Software: John Johnson
Yore Company, White Bear Lake, MN
612-770-9760
Steffey Marketing Assoc. Inc., Northbrook, IL
708-480-3575
Westech Marketing, Culver City, CA 213-870-9286
Repworks, Chicopee, MA 413-533-0845
Darmstedter Associates, Baldwinville, NY
315-638-1261
John Anthony, Stamford, CT 203-322-9202

Bencsik Associates, Ocala, FL 904-732-9775
 C.L. Pugh, Cleveland, OH 216-238-1777
Monford Electronics Marketing, Indianapolis, IN 317-872-8877
 C.M. Sales, Farmington Hill, MI 313-553-8070
 B.C. Electronic Sales, Mission, KS 913-262-1720
 Marketing Concepts, Irving, TX 214-869-0669
 Torbett/Kelser Group, Loveland, CO 303-669-1008
 Plus Four Marketing, Walnut Creek, CA 415-937-0650
 North Shore Marketing, Seattle, WA 206-284-9699
 Island Instruments, Kaneohe, HI 808-235-7544
PRODUCTS: audio level, boardroom, custom, microprocessor, remote monitoring

Intelix

10500 West Reno
 P.O. Box 24031
 Oklahoma City, OK 73124-4031 (800) 553-8252
FAX: (405) 324-5217
President: Dave Merrey; **Marketing Manager:** Todd Rockwell; **Hardware Technical Support:** Tracy Cranton; **Software Technical Support:** Jack Vig
 ADCOM, Toronto, ON 416-251-3355
PRODUCTS: A/V, boardroom, custom, microprocessor

IRP, A KNOWLES COMPANY

321 Bond Street
 Elk Grove VII., IL 60007
 (708) 439-3600 (800) 255-6993 **FAX:** (708) 640-9607
Vice President, General Mgr.: Brian Benn;
Marketing Manager: Roger Carroll; **Senior Sales Engineer:** Gayle Campbell; **Marketing Coordinator:** Laura Valavicius; **Applications Engineer:** Norm Kinnaugh; **Product Engineering Manager:** Mitch Bentz
 Piper and Glivan Assoc., Needham, MA 617-449-1144
 Sigmet Corp., Freehold, NJ 201-462-1221
 Richard S. Pass Associates, Langhorne, PA 215-757-6100
 Henry W. Phillips Co., Rosewell, GA 404-992-3070
 Bencsik Associates, Ocala, FL 904-732-9775
 C.B. Electronic Marketing, Arvada, CO 303-422-0561
 Avwest Inc., Fountain Hills, AZ 602-946-1811
 EESCO Systems Inc., Los Angeles, CA 213-666-9601
 Pappas Consulting, Menlo Park, CA 415-324-4325
 Chuck Olson Assoc., Renton, WA 206-271-5416
 Kaltec Communications, North Vancouver, BC 604-987-1597
 More Technologies Inc., Los Angeles, CA 213-474-4211
 Audio Marketing Assoc., Brecksville, OH 216-526-2426
 Starlin Marketing, Chesterton, IN 219-929-4127
 MJA Marketing, St. Charles, MO 314-447-7111
 Graham Davis Inc., Dallas, TX 214-357-7677
PRODUCTS: audio level, boardroom, EQ/ remote, remote monitoring

LynTec

7030 Grandview
 Merriam, KS 66204
 (913) 722-4047 **FAX:** (913) 432-4157
Owner: Lynn Potter
 Audio Etc., St. Peters, MO 314-278-4130
PRODUCTS: audio level

Moseley Associates, Inc.

111 Castilian Drive
 Santa Barbara, CA 93117
 (805) 968-9621 **FAX:** (805) 685-9638
President: Douglas Hogg; **Vice President:** Jamal Hamdani
 Chuck Olson Assoc., Renton, WA 206-271-5416

OXMOOR CORP.

2111 Parkway Office Circle
 Birmingham, AL 35244
 (205) 985-7040 **FAX:** (205) 985-9966
President: Lynn A. McCroskey; **Vice President/Manager:** Gary L. West; **National Sales Manager:** Richard C. Mitchell; **Sales Associate:** Nick Alsmiller; **Production Manager:** Jim Watson;
Director of Engineering: Gene Elghmy
 John B. Anthony Company, Stamford, CT 212-585-2027
 ASR, Fallston, MD 301-893-0001
 Audio Resources, Westmont, IL 708-655-1180
 Dimension IX Marketing, Lewisville, TX 214-436-3706
 Evans Sales and Marketing, Nashville, TN 615-297-7997
 Loomis and Associates, Fremont, CA 415-683-0883
 Lopnow and Associates, Issaquah, WA 206-392-3936
 R.J. Throckmorton Sales Co., Ballwin, MO 314-227-7222
 Repworks, Chicopee, MA 413-553-0845
PRODUCTS: audio level, boardroom, EQ/ remote, remote monitoring

Protech Audio Corporation

Flowerfield Bldg. 1
 St. James, NY 11780
 (516) 584-5855 **FAX:** (516) 584-5904
Director of Marketing: Bill Murphy; **Sales Engineering:** Joseph Giambone
 Peregrine Southwest Reps, Houston, TX 713-589-8481
 First Choice Marketing, Seattle, WA 206-524-7344
 Dimension/ Point IX, Lewisville, TX 214-436-3706
PRODUCTS: audio level, remote monitoring

S.E.M. Co.

#17-636 Clyde Ave.
 W. Vancouver, BC V7T 1E1
 (604) 922-0526 **FAX:** (604) 922-0526
President: Elk Ebert; **Vice President:** Anne Moretti
 Karp Communications, Tampa, FL 813-968-7098
PRODUCTS: audio level, DTMF, EQ/ remote

SONANCE

961 Calle Negocio
 San Clemente, CA 92672
 (714) 492-7777 (800) 582-7777 **FAX:** (714) 361-2705
President: Scott Struthers; **Vice President:** Geoff Spencer; **Sales Manager:** Dave Donald; **International Sales Manager:** Mark Cichowski; **Public Relations Director:** Mitch Simon; **Dir. Sls Trn. & Mkt. Research:** Kevin Leja
 Morris Talt and Assoc., Los Angeles, CA 213-877-4424
 Bach Sales, New York, NY 212-727-0404
 Tandem Marketing, Chicago, IL 708-605-1960
 Dobbs Stanford, Dallas, TX 214-358-0800
 Balaton Marketing, Washington DC, 202-471-1764
 MJA Marketing, St. Charles, MO 314-447-7111
PRODUCTS: hardwired

Soundstream Technologies

120 Blue Ravine Road
 Folsom, CA 95630
 (916) 351-1288 **FAX:** (916) 351-0414
President: Donna Haas; **Managing Director:** Lee Adams; **Director of Engineering:** Wade Stewart;
Ntl. Sales Mgr., Home Audio: Scott McAllister;
Sales Engineer, Home Audio: Andrew Murray
 John W. Steinberg Company, Encino, CA 818-705-7772
 Moskau & Associates, Dallas, TX 214-821-4280

Creative Marketing Associates, Nashville, TN 615-831-9690
 On Line Marketing, Wadsworth, OH 216-336-7504
 Sound Marketing, Palos Hills, IL 708-598-6888
 Cambridge Marketing, Westerville, OH 614-363-9191
PRODUCTS: A/V, wireless

Teatronics/Lighting Innovations

3100 McMillan Rd.
 San Luis Obispo, CA 93401
 (805) 544-3555 **FAX:** (805) 544-3703
 Camden Marketing, Pierre Fonds, QU 514-683-3377

TSI (Tamco Systems Inc.)

393 Jericho Turnpike
 Mineola, NY 11501
 (516) 294-5390 (800) 628-2084 **FAX:** (516) 294-5008
CEO: Mario Maltese; **President:** Garani Srinivasan; **President (Spec. Prod. Div.):** Richard Stillwell; **Sales Coordinator:** Denise Matejka;
Marketing Manager: Karen Pepe
 JMS Marketing, Austin, TX 512-266-1113
PRODUCTS: A/V, boardroom, custom, hardwired

Video Link

12950 Bradley Avenue
 Sylmar, CA 91342
 (818) 362-0353 (800) 843-5465 **FAX:** (818) 362-9506
President: Herb Seymour; **V.P. Sales and Marketing:** Bill Cawfield; **Sales Manager:** Larry W. Schatz; **Asst. Sales Manager:** Marguerita Kiser
 J.B. Parent, Dublin, OH 614-764-0064
PRODUCTS: A/V, audio level, boardroom, custom, hardwired, video, wireless

Wireless Technology, Inc.

3021 S. Valley View Blvd. #104
 Las Vegas, NV 89102
 (702) 362-8686 **FAX:** (702) 362-8191
President: William G. Horrell; **Executive Vice President:** Daniel Fancher; **Sr. Vice Pres., Marketing:** Sanford H. Green
 Protection Systems, Tinley Park, IL 708-614-8990
 Valenti & Assoc., Nahant, MA 617-592-5300
 Pacer Sales Co., Lenexa, KS 913-541-1411
 Epic Marketing, San Mateo, CA 415-573-5881
 Florida Electronic/Repcos, N. Palm Beach, FL 407-622-7555
 MJA Marketing, St. Charles, MO 314-447-7111
PRODUCTS: remote monitoring, video, wireless

**Subscribe to
 Sound &
 Communications
 Magazine**

SIGNALING SYSTEMS

Alphone Corp.

1700 130th Ave. NE
Bellevue, WA 98005
(206) 455-0510 FAX: (206) 455-0071
President: Jun Matsumoto; Vice President,
Marketing: Harry Quanz; Vice President, Sales:
Jim Morrison; Residential Sales Manager:
Stephen Blirgh; Commercial Sales Manager: John
Mosebar
Alphone East Coast Reg. Office, Rochelle Park, NJ
201-843-6115
Precide, Morbio Inferiore, Switzerland,
914-31734
PRODUCTS: annunciator, audio, visual

Alpha Communications

89-D Cabot Court
Hauppauge, NY 11788-3717
(516) 434-8080 (800) 666-4800 FAX: (516) 434-8334
President: Mark S. Goldberg; Vice President:
Madelyn R. Goldberg; Office Manager: Rose
Tassone
Sound Sales, Inc., Columbia, MD 301-964-1170
PRODUCTS: annunciator, audio, bell, call-light,
tone, visual

APPLIED TECHNICAL SYSTEMS

815 King Pl.
Shreveport, LA 71115
(318) 868-7413 (800) 444-7161 FAX: (318) 631-7613
President: Jim Reccelli; Vice President: Richard
Davis
C.L. Pugh & Associates, Cleveland, OH
216-238-1777
Total Marketing, Fort Worth, TX 817-560-3970
Western Audio Sales, Burbank, CA 818-954-9300
PRODUCTS: timer, visual

ATLAS/SOUNDOLIER

1859 Intertech Dr.
Fenton, MO 63026
(314) 349-3110 (800) 876-7337 FAX: (314) 349-1251
VP/Marketing & Sales: Charles Gushwa;
VP/Marketing Consultant: Herbert M. Jaffe;
National Sales Manager: Bud Waters; Eastern
Sales Manager: Tony Satariano; Western Sales
Manager: Jeff Garstick; OEM Sales Manager:
Larry Damato
Precide, Morbio Inferiore, Switzerland,
914-31734
PRODUCTS: alarm, annunciator, audio, bell, call-
light, tone, visual

Audiosone

335 Benton St.
Stratford, CT 06497
(203) 377-4475
J.B. Parent, Dublin, OH 614-764-0064

Cornell Electronic Products, Inc.

4911 W. Good Hope Road
P.O. Box 23411, Milwaukee, WI 53223-0411
(414) 351-4660 FAX: (414) 351-4657
President: Donald J. Glaubitz; Vice President:
Gary M. Butler; Sales Manager: Pauline A. Haack;
Accounting: Thelma M. Plunkett; Production
Manager: Joel Karls
Richard S. Pass Associates, Philadelphia, PA 215-
757-6100
Dick Bellew Sales, Dallas, TX 214-644-7881
Winchester Electronic Sales, Atlanta, GA
404-392-0200
Cartwright & Bean, Orlando, FL 407-889-9100
Rancillo Associates, St. Louis, MO 314-845-0202
Vector Corp., Seattle, WA 206-368-8400
Kingston Sales, Indianapolis, IN 317-876-2545
Bidwell-Schwartz Associates, Gardena, CA
213-770-0300
Yocum Marketing, Mesa, AZ 602-834-3334
Avcom, Inc., North Olmstead, OH 216-777-2060
Kodo Associates, Minneapolis, MN 612-881-1255
W.A. Hendrickson Co., North Scituate, MA
617-545-0652
LSM Associates, Phelps, NY 315-548-4891
R & S Sales, Rockville Ctr., NY 516-678-6887
PRODUCTS: alarm, annunciator, audio, call-light,
tone, visual

Edwards Company, Inc.

195 Farmington Avenue
P.O. Box 1188
Farmington, CT 06034
(203) 678-0410 FAX: (203) 677-5881
President: Timothy Mellen; Vice Pres. Mktg.,
Sales Mgr.: Louis Riccio; Vice President Finance:
Paul DeFillippo; Vice President, Engineering: Ed
Miller; Vice Pres. Employee Relations: Robert
Maxwell
Edwards Company, Inc., Cherry Hill, NJ 609-482-
5300
Edwards Company, Inc., Atlanta, GA 404-451-0362
Edwards Company, Inc., City Of Indus., CA
818-854-8670
Edwards Company, Inc., Pleasanton, CA
415-463-1788
Edwards Company, Inc., Downers Grove, IL
708-515-1900
Edwards Company, Inc., Livonia, MI 313-458-7777
Edwards Company, Inc., Dallas, TX 214-233-8998
Edwards Company, Inc., Miami, FL 305-592-0510
Edwards Company, Inc., Norwood, MA
617-762-9115
Edwards Company, Inc., Norwalk, CT
203-847-1115
Edwards Company, Inc., Lorton, VA 703-550-7815
PRODUCTS: alarm, annunciator, audio, bell, call-
light, timer, tone, visual

ESE

142 Sierra Street
El Segundo, CA 90245
(213) 322-2136 FAX: (213) 322-8127
President: Jerry Johnson; Vice President/Sales
Manager: Bob Mayers; Marketing Manager:
Brian Way; General Manager: Bill Kaiser
Cambridge Marketing, Westerville, OH 614-363-9191

EXI ELECTRONICS MANUFACTURING

803 Erlin St.
Winnipeg, MB R3G 2W2
(204) 453-0573 FAX: (204) 775-1165
Sales Engineer: Mort Larsen; R & D Engineer:
Vladimir Federman; Marketing: Les Toutant
Doug Warren, Newport News, VA 804-930-3217
PRODUCTS: alarm, annunciator, timer, tone,
visual

Gorman Redlich Mfg. Co

257 W. Union St.
Athens, OH 45701
(614) 593-3150 FAX: (614) 592-3898
Owner: James T. Gorman
Doug Warren, Newport News, VA 804-930-3217
PRODUCTS: alarm

INNOVATIVE ELECTRONIC DESIGNS, INC.

9701 Taylorsville Rd.
Louisville, KY 40299
(502) 267-7436 FAX: (502) 267-9070
President: Hardy Martin; Vice President, Mkt'g &
Sales: Tom Roseberry; Sales Application
Engineer: Mark Lewellyn; V.P. Research &
Development: Bob Ponto; Vice President,
Engineering: Ed Young; Vice President,
Software: John Johnson
Yore Company, White Bear Lake, MN
612-770-9760
Steffey Marketing Assoc. Inc., Northbrook, IL 708-
480-3575
WeSTech Marketing, Culver City, CA 213-870-9286
Repworks, Chicopee, MA 413-533-0845
Darmstedter Associates, Baldwinville, NY
315-638-1261
John Anthony, Stamford, CT 203-322-9202
Bencsik Associates, Ocala, FL 904-732-9775
C.L. Pugh, Cleveland, OH 216-238-1777
Monford Electronics Marketing, Indianapolis, IN
317-872-8877
C.M. Sales, Farmington Hill, MI 313-553-8070
B.C. Electronic Sales, Mission, KS 913-262-1720
Marketing Concepts, Irving, TX 214-869-0669
Torbett/Kelser Group, Loveland, CO 303-669-1008
Plus Four Marketing, Walnut Creek, CA
415-937-0650
North Shore Marketing, Seattle, WA 206-284-9699
Island Instruments, Kaneohe, HI 808-235-7544
PRODUCTS: alarm, audio, tone

International Components Corp.

105 Maxess Road
Melville, NY 11747
(516) 293-1500 (800) 645-9154 FAX: (516) 293-4983
President: Mort Grossman; Executive Vice
President: Irwin Friedman; Vice President: Fred
Grossman; Eastern Regional Sales Mgr.: Ken
Reed; Vice President: Harvey Grossman
C.B. Electronic Marketing, Arvada, CO
303-422-0561
PRODUCTS: alarm, annunciator, audio, tone

Lathem Time Corporation

200 Sellg Dr. SW
Atlanta, GA 30378
(404) 691-0400 FAX: (404) 696-6048
Larry Schirmer, Pontiac, MI 313-340-9588
PRODUCTS: alarm, bell, timer

LEE DAN COMMUNICATIONS, INC.

155 Adams Avenue
Hauppauge, NY 11788-3699
(516) 231-1414 (800) 533-3261 FAX: (516) 231-1498
President: Leon Goldberg; Vice President
Operations: Lawrence J. Goldberg; V.P. Finance &
Administration: David H. Goldberg; Senior
Technician: Sanford Hoffman; Office Manager:
Rita Kaplan; Sr. Sales/Service Associate: Susan
Leon
C.L. Pugh & Associates, Cleveland, OH
216-238-1777
PRODUCTS: annunciator, audio, bell, tone, visual

MED-TEK HEALTHCARE PRODUCTS

1335 S. Claudina St.
 Anaheim, CA 92805
 (714) 774-8484 (800) 955-9540 FAX: (714) 774-7388
 Distributor & Dealer Acct's: John Sykora; V.P.,
 Marketing & Sales: William A. Haines; President:
 William K. Haines; Operations: Daniel Haines;
 Technical Director: Tom Ludden
 Camden Marketing, Pierre Fonds, QU
 514-683-3377
 PRODUCTS: call-light

Microframe Corporation

P.O. Box 1700
 Broken Arrow, OK 74013
 (918) 258-4839 (800) 635-3811 FAX: (918) 258-3500
 Loomis and Associates, Fremont, CA
 415-683-0883
 PRODUCTS: call-light, timer, visual

Protech Audio Corporation

Flowerfield Bldg. 1
 St. James, NY 11780
 (516) 584-5855 FAX: (516) 584-5904
 Director of Marketing: Bill Murphy; Sales
 Engineering: Joseph Glambone
 Peregrine Southwest Reps, Houston, TX
 713-589-8481
 First Choice Marketing, Seattle, WA 206-524-7344
 Dimension/ Point IX, Lewisville, TX 214-436-3706
 PRODUCTS: annunciator

REVERE INDUSTRIES

1101 Blenville St.
 New Orleans, LA 70112
 (504) 523-3503 (800) 843-8321 FAX: (504) 525-6361
 Vice President Mktg./Sales: Richard Harris
 Camden Marketing, Pierre Fonds, QU
 514-683-3377
 PRODUCTS: alarm, annunciator, audio, bell, call-
 light, timer, tone, visual

TALK-A-PHONE CO.

5013 N. Kedzie Ave.
 Chicago, IL 60625
 (312) 539-1100 FAX: (312) 539-1241
 Vice President: Samuel Shanes; Sales Manager:
 Dan F. Kagan; President: Z. Liberman
 JMS Marketing, Austin, TX 512-266-1113
 PRODUCTS: alarm, annunciator, audio, bell, call-
 light

Varitronics Inc.

620 Parkway
 Broomall, PA 19008
 (215) 356-3995 (800) 345-1244 FAX: (215) 356-5222
 Technical Sales Manager: Mark Minassian
 Cambridge Marketing, Westerville, OH
 614-363-9191

Vis A Com

517 E. 132 Street
 Bronx, NY 10454
 (212) 402-4444
 Cambridge Marketing, Westerville, OH 614-363-
 9191

WHELOCK, INC.

273 Branchport Avenue
 Long Branch, NJ 07740
 (908) 222-6880 (800) 631-2148 FAX: (908) 222-8707
 President: Peter W. Tarlton; V.P. Finance and
 Admin.: Joseph P. Henry; Vice President
 Operations: Douglas E. Phillips; Vice President
 Sales/Mktg.: William L. Goldstein;

Telephone/Paging Mktg. Mgr.: Arthur Arlow;
 Life Safety Mktg. Mgr.: Rein Haus
 Joseph P. McCaffrey, Glen Ellyn, IL 708-790-2898
 Edward P. Draney, Peachtree City, GA
 404-631-3193
 Peter Koehler, Los Angeles, CA 213-572-1347
 Steve Goldberg, East Windsor, NJ 609-448-1457
 Dave Jackowlak, Burbank, IL 708-599-4099
 MJA Marketing, St. Charles, MO 314-447-7111
 PRODUCTS: alarm, annunciator, audio, bell, tone,
 visual



Aegis Development, a div. Oxxl Inc.

1339 E. 28th St., Long Beach, CA 90806
 (213) 427-1227 FAX: (213) 427-0971
 Audio Etc., St. Peters, MO 314-278-4130

Altec Lansing Corp.

10500 W. Reno, Oklahoma City, OK 73128
 (405) 324-5311 FAX: (405) 324-8981
 President: Dave Merrey; Vice President, Sls. &
 Mktg: Chuck Lange; National Sales Manager:
 Jerry Spriggs; Manager Export Marketing: John
 Sexton; Technical Services Manager: Gary Jones;
 Customer Services Manager: Jim Brown
 Dave Read, McKinney, TX 214-542-6328
 Jim Faber, Shreveport, LA 318-631-1766
 Paul Froula, Lombard, IL 708-268-1831
 Alan Feckanin, Port St. Lucie, FL 407-879-1078
 George Solti, Philadelphia, PA 215-637-3429
 Larry Schlrmer, Pontiac, MI 313-340-9588
 Stu Moffit, Renton, WA 206-277-8851
 PRODUCTS: CAD software, sound system design

Anahelm Technologies Inc.

320 Fifth Avenue, Troy, NY 12182
 (518) 237-1474 FAX: (514) 739-8526
 President: Neil Gordon; Vice President: Ara
 Altounlian
 Anahelm Technologies, Montreal, QU 514-745-2272
 Greg Dzubay & Assoc., Glendale, AZ 800-999-0006
 PRODUCTS: bid software

Audio Teknology Inc.

7556 SW Bridgeport Rd.
 Portland, OR 97224
 (503) 624-0405 FAX: (503) 624-0194
 President/CEO: Chris Strahm; Vice President:
 Larry Droppa; Financial Manager: Vickie
 Sheppard; Marketing Manager: Vance Dickason
 Doug Warren, Newport News, VA 804-930-3217
 PRODUCTS: CAD software, speaker design

Autodesk Inc.

2320 Marinship Way
 Sausalito, CA 94965
 (415) 332-2344 (800) 445-5415 FAX: (415) 331-8093
 President & CEO: Alvar J. Green; Sr. VP of
 Marketing & Sales: Dr. Malcolm Davies; CFO:
 Carolyn Aver; Director of Marketing: Frank
 Ballinson; Public Relations Supervisor: Andrew
 Zarrillo; Personnel Manager: Kim Young
 Vector Corp., Seattle, WA 206-368-8400
 PRODUCTS: CAD software

BOSE CORP.

The Mountain, Framingham, MA 01701-9168
 (508) 879-7330 FAX: (508) 872-6640
 National Sales Manager: Timothy Dorwart;
 Eastern Reg. Sales Manager: Bruce Hurst;
 Western Reg. Sales Manager: Tim Landwehr; Sr.
 Applications/Des. Spec.: Bruce Myers; Sr. Sales
 Representative: Reed Strutzenberg; Sales
 Representative: Phil Nelson
 HC Garrison Co., Tualatin, OR 503-638-4906
 Westech Marketing, Culver City, CA 213-870-9286
 Silver Peak Marketing, Wheat Ridge, CO
 303-467-9042
 Rancillo Assoc., St. Louis, MO 314-845-0202
 CR Marketing, Clarkston, MI 313-625-2420
 J.B. Parent, Dublin, OH 614-764-0064
 Secom Systems, Atlanta, GA 404-455-0672
 Bencsik Assoc., Ocala, FL 904-732-9775
 Sigmot Corp., Valley Forge, PA 215-783-6666
 Joseph P. Mazzeo Assoc., Inc., Rochester, NY
 716-458-7851
 Peter E. Schmitt Co., Inc., Leonia, NJ 201-944-2806
 PRODUCTS: CAD software, sound system design

Dynaware USA, Inc.

950 Tower Lane #1150, Foster City, CA 94404
 (415) 349-5700 (800) 445-DYNA
 FAX: (415) 349-5879
 President: Robert G. Howard; International
 Marketing Mgr.: Pamela K. Millar; Business
 Development Exec.: Vanessa Klein; Product
 Manager, MIDI: Jane Smith; Product Manager,
 Graphics: Farhad Nouri; Sales Representative:
 Brian Smith
 PRODUCTS: CAD software, graphics plotting,
 sound system design

G.R. Thurmond & Associates

1509 Brushy View Cove
 Austin, TX 78754-2009
 (512) 837-7252
 Owner: Bob Thurmond
 PRODUCTS: sound system design

INNOVATIVE ELECTRONIC DESIGNS, INC.

9701 Taylorsville Rd.
 Louisville, KY 40299
 (502) 267-7436 FAX: (502) 267-9070
 President: Hardy Martin; Vice President, Mkt'g &
 Sales: Tom Roseberry; Sales Application
 Engineer: Mark Lewellyn; V.P. Research &
 Development: Bob Ponto; Vice President,
 Engineering: Ed Young; Vice President,
 Software: John Johnson
 Yore Company, White Bear Lake, MN 612-770-
 9760
 Steffey Marketing Assoc. Inc., Northbrook, IL 708-
 480-3575
 WesTech Marketing, Culver City, CA 213-870-9286
 Repworks, Chicopee, MA 413-533-0845
 Darmstedter Associates, Baldwinsville, NY
 315-638-1261
 John Anthony, Stamford, CT 203-322-9202
 Bencsik Associates, Ocala, FL 904-732-9775
 C.L. Pugh, Cleveland, OH 216-238-1777
 Monford Electronics Marketing, Indianapolis, IN
 317-872-8877
 C.M. Sales, Farmington Hill, MI 313-553-8070
 B.C. Electronic Sales, Mission, KS 913-262-1720
 Marketing Concepts, Irving, TX 214-869-0669
 Torbett/Kelser Group, Loveland, CO 303-669-1008
 Plus Four Marketing, Walnut Creek, CA
 415-937-0650
 North Shore Marketing, Seattle, WA 206-284-9699
 Island Instruments, Kaneohe, HI 808-235-7544
 PRODUCTS: operational software, project
 management, sound system design

JENSEN TRANSFORMERS INC.

10735 Burbank Blvd.
North Hollywood, CA 91601
(213) 876-0059 FAX: (818) 763-4574
President: Bill Whitlock; Vice President,
Engineering: Steve Hogan; Vice President,
Operations: Dave Hill
C.B. Electronic Marketing, Arvada, CO
303-422-0561
PRODUCTS: CAD software

Nasca Automated Systems

3901 Pepper Tree La
Silver Spring, MD 20906
(301) 460-6842 (800) 878-6841 FAX: (301) 460-6154
President: Tony Nasca
Dimension/ Point IX, Lewisville, TX 214-436-3706
PRODUCTS: bid software, business software,
operational software, project management

North Star Sound, Inc.

1406 First Avenue South
Minneapolis, MN 55403
(612) 871-6016 FAX: (612) 871-6017
Chief Engineer: Tom McCarthy
Dimension/ Point IX, Lewisville, TX 214-436-3706
PRODUCTS: cluster probing prediction

Old Colony Sound Laboratory

305 Union St.
P.O. Box 243
Peterborough, NH 03458
(603) 924-6371 FAX: (603) 924-9467
PRODUCTS: speaker design

Renkus-Helz, Inc.

17191 Armstrong Ave.
Irvine, CA 92714
(714) 250-0160 FAX: (714) 250-1035
President: Harro K. Helz; National Sales & Mktg.
Mgr.: Carl C. Dorwaldt; Chief Engineer: Frank
Ostrander; Product Manager: Mark Duncan
Karp Communications, Tampa, FL 813-968-7098

Richard J. Lemker & Associates

345 Montclair
Covington, KY 41016
(606) 261-9529 FAX: (606) 261-6318
Karp Communications, Tampa, FL 813-968-7098

Richmond Sound Design Ltd.

1234 West Sixth Avenue
Vancouver, BC V6H 1A5
(604) 732-1234
President: Charlie Richmond; General Manager:
Damon Wootten; Project Coordinator: Marilyn
Williams; Administration: Jennifer Bass
W3 Marketing, Atlanta, GA 404-981-7021
Sound Sales, Baltimore, MD 301-964-1173
Richmond Sound Design, Orlando, FL
407-352-0458
Audesco Electronics Ltee, Montreal, QC
514-931-5888
Gerr Electro Acoustics Ltd., Toronto, ON
416-868-0527
Gustafson Sales Company, Red Wing, MN
612-388-4277
PRODUCTS: operational software

Scientific Design Software

P.O. Box 3248
Chatsworth, CA 91313
(818) 718-1201 FAX: (818) 349-6076
Camden Marketing, Pierre Fonds, QU 514-683-3377
PRODUCTS: speaker design

Swanson Analysis Systems, Inc.

Johnson Road
P.O. Box 65, Houston, PA 15342
(412) 746-3304 (800) 937-3321 FAX: (412) 746-9494
President & C.E.O.: John A. Swanson; Vice
President: Gabriel DeSalvo; Secretary/Treasurer:
Marcia S. Morton; Manager, Systems &
Production: Lauralee Wagner; Manager, Mktg &
Training: Suzanne C. Batt; Manager, Quality
Assurance: Mark Imgrund
Comp. Aided Engineering Assoc, Woodbury, CT
203-263-4606
Defiance - SMC, Troy, MI 313-583-7117
JLR Computer Analysis, Inc., Everett, WA
206-353-8089
Engineering Methods Inc., W. Lafayette, IN
317-497-4477
H.C. Engineering, Toronto, ON 416-674-8505
Karp Communications, Tampa, FL 813-968-7098

Video Design Pro

749 Carver Road, Las Cruces, NM 88005
(505) 524-8959 (800) VIDCAD-6 FAX: (505) 524-
9669
Owner: Dr. Walter P. Black
Steve Bogart, Las Cruces, NM 505-524-8959
Cambridge Marketing, Westerville, OH 614-363-9191

Would you like to advertise in Sound & Communications?

We'd be happy to send
you our media kit
with all the information
you need to get started.

- Rate Card
- Editorial Spotlights
- BPA - Audited Circulation Statement
- Convention television schedule, including NSCA-TV News.

Just call, write or fax to:
Sound & Communications Media Kit
25 Willowdale Avenue
Port Washington, NY 11050
(516) 767-2500, FAX: 767-9335

Club Designers & Installers!

For the most exciting trends in sound & lighting systems
for today's dance clubs, plan to attend the



Walt Disney World Dolphin
Lake Buena Vista, Florida
October 14, 15, & 16 1991

For Expo Registration Form Call: (516) 767-2500, or write:
1991 INTERNATIONAL DJ EXPO
25 Willowdale Avenue, Port Washington, NY 11050
For Exhibit Space, contact: TOM DORSAM

- Daily sound & lighting
demos
- Special Sessions on:
- CD Mixing
 - Crossover Radio
 - National Club DJ ConFab
 - Mobile Law
 - Dance Club Design Trends
 - Remixers/Producers

SOUNDMASKING PRODUCTS & SYSTEMS

Ashly Audio, Inc.

100 Fernwood Ave.
Rochester, NY 14621
(716) 544-5191 (800) 828-6308 FAX: (716) 266-4584
President: Bill Thompson; Senior Vice President:
Bob French; Vice President: Dave Malloy;
Operations Manager: Ellen Price
ADCOM, Toronto, ON 416-251-3355
PRODUCTS: graphic equalizers

ATI-Audio Technologies Inc.

328 W. Maple Avenue
Horsham, PA 19044
(215) 443-0330 FAX: (215) 443-0394
President: Samuel B. Wenzel; Vice President:
Edward M. Mullin
PRODUCTS: noise generators

ATLAS/SOUNDOLIER

1859 Intertech Dr.
Fenton, MO 63026
(314) 349-3110 (800) 876-7337 FAX: (314) 349-1251
VP/Marketing & Sales: Charles Gushwa;
VP/Marketing Consultant: Herbert M. Jaffe;
National Sales Manager: Bud Waters; Eastern
Sales Manager: Tony Satariano; Western Sales
Manager: Jeff Garstick; OEM Sales Manager:
Larry Damato
Preclde, Morbio Inferiore, Switzerland,
914-31734
PRODUCTS: central, loudspeakers, noise
generators, self contained/ pre-engineered

Dukane Corp.

2900 Dukane Drive
St. Charles, IL 60174
(708) 584-2300 FAX: (708) 584-2370
President/C.E.O.: J. McWilliams Stone Jr.;
Pres./Comm. Systems Division: Steven L. Deppe;
National Sales Director: Warren T. Anderson;
Service Manager: Cliff Carlson
Wally Smutts, Toronto, ON 519-748-5352
Doug Fellabaum, Sycamore, IL 815-895-7573
Ken Lind, Boston, MA 617-235-6817
Pete Kendall, Jacksonville, FL 904-262-6025
Jim Lacey, Moreno Valley, CA 714-243-1160
Jack Brown, Dallas, TX 214-943-7528
Sanford Lange, Indianapolis, IN 317-251-3112
PRODUCTS: central, graphic equalizers,
loudspeakers, noise generators, self contained/
pre-engineered, zoned

Dynasound, Inc.

6439 Atlantic Blvd.
Norcross, GA 30071
(404) 242-8176 (800) 356-3288 FAX: (404) 242-8176
President: Dr. Robert C. Chanaud; Director, Sales
& Marketing: Tom Koenig; Customer Service:
Lynn Hobbs; Operations Manager: Lisa Minton;
Technical Services: Pat Forchee
Edwards Company, Inc., Livonia, MI 313-458-7777
PRODUCTS: central, graphic equalizers,
loudspeakers, noise generators, processors,
programmable, zoned

Elkay Industries

2925 North Market St.
St. Louis, MO 63106
(314) 535-1333 FAX: (314) 535-4118
CEO/ENG: Richard Hahn; President: Paul Grote;
Vice President, Sales: Martin Hahn; Engineering:
Jack Schillgo
Edwards Company, Inc., Livonia, MI 313-458-7777

Interior Acoustics, Inc.

176 Rt. 206 So
Somerville, NJ 08876
(201) 874-4155 (800) 221-0580 FAX: (201) 874-4525
President: Art Barkman; Marketing Manager:
Scott Randolph
Lizotte Assoc., Edgewater, MD 301-261-7776
Frank Meika, West Caldwell, NJ 201-226-9575
Office Works Plus, Boca Raton, FL 407-391-9261
J.W. Fox Co., Grapevine, TX 817-481-5559
Robert Hanlon, Willowbrook, IL 708-986-9797
ADCOM, Toronto, ON 416-251-3355
PRODUCTS: self contained/ pre-engineered

J.W. DAVIS AND CO.

3030 Canton Street
Dallas, TX 75226
(214) 651-7341 (800) 527-5705 FAX: (214) 939-0328
President: Harvey Earp; Vice President, Sales:
Jack W. Tucker; Chief Engineer: Eric Simonson
Multi-Technical Reps., Brainerd, MN 218-828-9483
PRODUCTS: loudspeakers, noise generators,
processors

LynTec

7030 Grandview
Merrillan, KS 66204
(913) 722-4047 FAX: (913) 432-4157
Owner: Lynn Potter
Audio Etc., St. Peters, MO 314-278-4130
PRODUCTS: noise generators, programmable

OXMOOR CORP.

2111 Parkway Office Circle
Birmingham, AL 35244
(205) 985-7040 FAX: (205) 985-9966
President: Lynn A. McCroskey; Vice President/
Manager: Gary L. West; National Sales Manager:
Richard C. Mitchell; Sales Associate: Nick
Aismiller; Production Manager: Jim Watson;
Director of Engineering: Gene Elghmy
John B. Anthony Company, Stamford, CT
212-585-2027
ASR, Fallston, MD 301-893-0001
Audio Resources, Westmont, IL 708-655-1180
Dimension IX Marketing, Lewisville, TX 214-436-
3706
Evans Sales and Marketing, Nashville, TN
615-297-7997
Loomis and Associates, Fremont, CA
415-683-0883
Loppnow and Associates, Issaquah, WA
206-392-3936
R.J. Throckmorton Sales Co., Ballwin, MO
314-227-7222
Repworks, Chicopee, MA 413-553-0845
PRODUCTS: graphic equalizers, programmable

Paso Sound Products, Inc.

14 First Street
Pelham, NY 10803
(914) 738-4800 (800) 231-3034 FAX: (914) 738-3954
Executive Vice President: Paul Mastrangelo;
Product Manager: Ken O'Brien; Credit Manager:
Marilyn Beckerson; Operations Manager:
Anthony Squeglla
Anderson Sales, Braintree, MA 617-848-9194
Jack Mesnick Sales, Liverpool, NY 315-622-3211
Palmer Associates, Fairfield, NJ 201-882-1266

Weller Electronic Sales, Inc., Worthington, OH
614-885-7819
Lienau Associates, Columbia, MD 301-621-4113
MJA Marketing, St. Charles, MO 314-447-7111
Northland Assoc., Moorehead, MN 218-233-4616
Allwest Sound & Communication, Camarillo, CA
805-388-7745
Dimension Pt. IX Marketing, Katy, TX 713-578-9277
Mountain Representatives, Denver, CO
303-333-7745
Miguel Lopez, Hialeah, FL 305-822-6853
Paco Electronics, Ltd., Markham, ON 416-475-0740
Robert Milk Co., Southfield, MI 313-354-3310
Marketline Inc., Snellville, GA 404-972-9048
Hawkins-Frederickson Assoc., Maitland, FL
407-831-2474
Lintern Associates, Naperville, IL 708-904-1225
Robert Milk Co., Indianapolis, IN 317-842-3400
PRODUCTS: graphic equalizers, loudspeakers

PEAVEY ELECTRONICS CORP.

711 A Street
P.O. Box 2898
Meridian, MS 39301
(601) 483-5365 FAX: (601) 484-4278
CEO: Hartley Peavey; President: Mella Peavey
Dimension/ Point IX, Lewisville, TX 214-436-3706
PRODUCTS: graphic equalizers, processors,
programmable

Sabine Musical Mfg. Co., Inc.

4637 N.W. 6th Street
Gainesville, FL 32609
(904) 371-3829 (800) 626-7394 FAX: (904) 371-7441
President/C.E.O.: Doran Oster; Sales & Marketing
Director: John M. Annin; Sales & Customer
Service: Neil Rapaport
Sound Sales, Inc., Columbia, MD 301-964-1170
PRODUCTS: processors

SonoMask Systems, Inc.

1130 Route 22 West
P.O. Box 1070
Mountainside, NJ 07092
(201) 232-7000 FAX: (201) 232-7991
Karp Communications, Tampa, FL 813-968-7098

SOUND DEVELOPMENT INDUSTRIES

1342 S.E. 46th Lane
Cape Coral, FL 33904
(813) 549-6010
Owner: Uolevi L. Lahti; Marketing: Anita P.
Zuefle; Field Service: U. Lahti, Jr.; Security: K.
Lahti
AKU Lahti Industries, Whitmore Lake, MI
313-426-4292
JTL Industries, Pleasanton, CA 415-462-4230
SDI Industries, Pleasanton, CA 415-426-5537
JMS Marketing, Austin, TX 512-266-1113
PRODUCTS: loudspeakers

**Order More
Blue Books
Now!**

This magazine's got your name, your rank and your number.

The better we know you, the better our chances of writing articles you'll find relevant and useful. The same holds true for our advertisers.

Knowing who you are (your name, job title, company and industry) enables them to more easily develop messages which meet your informational requirements.

Circulation information helps advertisers determine who you are, what to say and where to say it. And since advertisers support our publication and allow us to keep bringing you high quality editorial, we think they deserve the most reliable and current circulation facts and figures available.

BPA (Business Publications Audit of Circulation, Inc.) helps us provide it. An independent, not-for-profit organization, BPA audits our circulation list once a year to verify that it's accurate and up to date.

The BPA audit makes sure our advertisers get the readers they pay for. And when advertisers get the readers they pay for, chances are they get the results they pay for, too.

BPA. For readers it stands for meaningful information. For advertisers it stands for meaningful readers. Business Publications Audit of Circulation, Inc.
360 Park Ave. So., New York, NY 10010.



We make sure you get what you pay for.



TOA ELECTRONICS, INC.

601 Gateway Blvd. Suite 300
P.O. Box 2047
S San Francisco, CA 94080
(415) 588-2538 (800) 733-4750 FAX: (415) 588-3349
President: Yoshio Ishida; Director, Audio Products Div: Richard Krochmal; Director, Comm. Systems Div.: Al Burns; Mgr., Marketing Development: Jeff Pallin; Manager, Western Division: Bill Ford; Manager Engineering Services: Bob Sweet
Chuck McGregor- Product Const, Morris Plains, NJ 201-829-7047
John Murray-Eng.Snd. Mktg. Dev, Springfield, OH 513-324-1993
Bob Hager-Eastern Regional Mgr, Rosewell, GA 404-552-7624
Linda Wick-Central Reg. Mgr., Kansas City, MO 816-453-5775
Robert Slaughter-Cntrl Div Mgr, Houston, TX 713-460-3678
Pete Newmark-West Regional Mgr., Mesa, AZ 602-981-0050
Walter Best, Eastern Reg. Mgr., Sussex, NJ 201-702-0068
PRODUCTS: central, graphic equalizers, processors



AMX Corporation

12056 Forestgate Drive
Dallas, TX 75243
(214) 644-3048 (800) 222-0193 FAX: (214) 907-2055
President: Scott Miller; Vice President of Sales: William V. Anderson; Executive Vice President: Art Chace; International Sales Manager: Ken Sclater; Director of Marketing: Eric Johansen
Franklin Communications, Maple Glen, PA 215-643-3031
Visitech Marketing Assoc., Elburn, IL 708-365-9600
KBZ Communications, Furlong, PA 215-348-9481
Westech Marketing, Culver City, CA 213-870-9286
Total Marketing, Ft. Worth, TX 817-560-3970
Karp Communications, Tampa, FL 813-960-7667
Richard Krudop, Andalusia, AL 205-222-8950
Pancor Marketing, Lynnwood, WA 206-771-6016
PRODUCTS: microprocessor

ATI-Audio Technologies Inc.

328 W. Maple Avenue
Horsham, PA 19044
(215) 443-0330 FAX: (215) 443-0394
President: Samuel B. Wenzel; Vice President: Edward M. Mullin
PRODUCTS: microphone specific

AUDIO-TECHNICA U.S., INC.

1221 Commerce Drive
Stow, OH 44224
(216) 686-2600 FAX: (216) 688-0719
Vice President, Marketing: Ken Reichel; National Marketing Manager: Earl "Buzz" Goodwin; National Sales Manager: Garry Elliott; Inside Sales: Tony O'Keefe; Sales Coordinator: Kim Wallace
Nova Marketing, San Francisco, CA 415-952-0943
PRODUCTS: automixing, microphone specific, microprocessor, telephone interface

Colorado Video

P.O. Box 928
Boulder, CO 80306
(303) 530-9580

Crestron Electronics, Inc.

101 Broadway
Cresskill, NJ 07626
(201) 894-0660 (800) 237-2041 FAX: (201) 894-1192
Sales & Marketing Manager: Randy Klein
Robert Christopher Sales, New Milford, NJ 201-261-5560
Robert Christopher Sales, Whitefish Bay, WI 414-332-6555
RSI, Irving, TX 214-256-4551
Loomis & Associates, Fremont, CA 415-683-0883
Presentation Resources, Inc., Maudlin, SC 803-288-8840
Taub Sales, Silver Springs, MD 301-662-9100
PRODUCTS: microprocessor

Dan Dugan Sound Design

290 Napoleon St.
San Francisco, CA 94124
(415) 821-9776 FAX: (415) 826-7699
Proprietor: Dan Dugan
Doug Warren, Newport News, VA 804-930-3217
PRODUCTS: automixing

Eby Co.

2751 Southampton Rd.
Philadelphia, PA 19154
(215) 969-4200

EDCOR ELECTRONICS

7130 National Parks Hwy
P.O. Box 5098
Carlsbad, NM 88220
(505) 887-6790 (800) 854-0259 FAX: (505) 887-6880
Sales: P. Weston; Engineering: Brian Weston
Greg Dzubay & Assoc., Glendale, AZ 800-999-0006
PRODUCTS: automixing, manual, microphone specific

ESE

142 Sierra Street
El Segundo, CA 90245
(213) 322-2136 FAX: (213) 322-8127
President: Jerry Johnson; Vice President/Sales Manager: Bob Mayers; Marketing Manager: Brian Way; General Manager: Bill Kaiser
Cambridge Marketing, Westerville, OH 614-363-9191

FSR Inc.

244 Bergen Boulevard
West Paterson, NJ 07424
(201) 785-4347 (800) 332-3771 FAX: (201) 785-3318
President: William C. Fitzsimmons; Vice President: Janice Sandri; Engineering Manager: Joseph Fischer; Special Projects Manager: John Macaluso; Manager, Metal Products: Joseph Amico
Sigmet Corporation, Valley Forge, PA 215-783-6666
Peregrine Southwest, Houston, TX 713-589-8481
Henry W. Phillips Inc., Roswell, GA 404-992-3070
Piper and Givan Associates, Needham, MA 617-449-1144
Design Factors, Hacienda Hts., CA 213-697-7576
Cambridge Marketing, Westerville, OH 614-363-9191
PRODUCTS: microphone specific, telephone interface

Gentner Communications Corporation

1825 Research Way
Salt Lake City, UT 84119
(801) 975-7200 FAX: (801) 977-0087
Manager, Teleconferencing: Dan Marchetto;
Asst. Sales Mgr., Teleconf.: Cory Guttu;
International Sales Manager: Elaine Jones; Pro Audio Sales: Dave Pedersen; Director of Marketing: Dave Finley
Greg Dzubay & Assoc., Glendale, AZ 800-999-0006
PRODUCTS: automixing, manual, microphone specific, microprocessor, telephone interface

**Find Your Suppliers in the
Sound & Communications
Blue Book**



Full Discount Wholesalers offers **WHOLESALE PRICES** to dealers and contractors **ONLY!** If you want to receive **FREE** mailings on the latest audio, video and lighting equipment offered at wholesale prices, **CALL NOW** and make sure you're on our mailing list!

1-800-828-0509

**FULL DISCOUNT
WHOLESALE**

Local:
(608) 273-5488
Madison, WI

A STACKED DECK!



Today, more jobs are being done with card frame systems. The reasons are simple. They take less space, are more flexible, and more cost-effective.

Protech Audio has been manufacturing the INTEGRA III SYSTEM for over 10 years. We offer the design professional a complete card frame system. Competitive in both small and large installations. State-of-the-art circuitry and audio control, with field proven reliability.

Our design philosophy is simple. Offer the system designer a menu of modules for each function, and let them decide which best fits their application. With over 160 different modules, the INTEGRA III SYSTEM offers more choices than any other card frame system. Picking the most cost-effective module is easy. Our new product selector guide lets you decide which options you want in a module, and quickly provides the model number. And your customer pays for only the options required.

For the 1990's, you need the freedom to design systems from the very small, to the very large. You need to be able to develop your design in a minimum amount of time. The flexibility of the INTEGRA III SYSTEM will allow you to do just that! Increase productivity, and reliability.

For the winning story, call or write today!

PROTECH®

Protech Audio Corporation
Flowerfield Building 1
St. James, New York 11780
516-584-5855

INNOVATIVE ELECTRONIC DESIGNS, INC.

9701 Taylorsville Rd.
Louisville, KY 40299
(502) 267-7436 FAX: (502) 267-9070
President: Hardy Martin; Vice President, Mkt'g & Sales: Tom Roseberry; Sales Application Engineer: Mark Lewellyn; V.P. Research & Development: Bob Ponto; Vice President, Engineering: Ed Young; Vice President, Software: John Johnson
Yore Company, White Bear Lake, MN 612-770-9760
Steffey Marketing Assoc. Inc., Northbrook, IL 708-480-3575
Westech Marketing, Culver City, CA 213-870-9286
Repworks, Chicopee, MA 413-533-0845
Darmstedter Associates, Baldwinsville, NY 315-638-1261
John Anthony, Stamford, CT 203-322-9202
Bencsik Associates, Ocala, FL 904-732-9775
C.L. Pugh, Cleveland, OH 216-238-1777
Monford Electronics Marketing, Indianapolis, IN 317-872-8877
C.M. Sales, Farmington Hill, MI 313-553-8070
B.C. Electronic Sales, Mission, KS 913-262-1720
Marketing Concepts, Irving, TX 214-869-0669
Torbett/Kelser Group, Loveland, CO 303-669-1008
Plus Four Marketing, Walnut Creek, CA 415-937-0650
North Shore Marketing, Seattle, WA 206-284-9699
Island Instruments, Kaneohe, HI 808-235-7544
PRODUCTS: automixing, microphone specific, microprocessor, telephone interface

Intelx

10500 West Reno
P.O. Box 24031
Oklahoma City, OK 73124-4031 (800) 553-8252
FAX: (405) 324-5217
President: Dave Merrey; Marketing Manager: Todd Rockwell; Hardware Technical Support: Tracy Cranton; Software Technical Support: Jack Vig
ADCOM, Toronto, ON 416-251-3355
PRODUCTS: microprocessor

IRP, A KNOWLES COMPANY

321 Bond Street
Elk Grove VII., IL 60007
(708) 439-3600 (800) 255-6993 FAX: (708) 640-9607
Vice President, General Mgr.: Brian Benn; Marketing Manager: Roger Carroll; Senior Sales Engineer: Gayle Campbell; Marketing Coordinator: Laura Valavicius; Applications Engineer: Norm Klinnaugh; Product Engineering Manager: Mitch Bentz
Piper and Givan Assoc., Needham, MA 617-449-1144
Sigmat Corp., Freehold, NJ 201-462-1221
Richard S. Pass Associates, Langhorne, PA 215-757-6100
Henry W. Phillips Co., Rosewell, GA 404-992-3070
Bencsik Associates, Ocala, FL 904-732-9775
C.B. Electronic Marketing, Arvada, CO 303-422-0561
Avwest Inc., Fountain Hills, AZ 602-946-1811
EESCO Systems Inc., Los Angeles, CA 213-666-9601
Pappas Consulting, Menlo Park, CA 415-324-4325
Chuck Olson Assoc., Renton, WA 206-271-5416
Kaltec Communications, North Vancouver, BC 604-987-1597
More Technologies Inc., Los Angeles, CA 213-474-4211
Audio Marketing Assoc., Brecksville, OH 216-526-2426
StarIn Marketing, Chesterton, IN 219-929-4127
MJA Marketing, St. Charles, MO 314-447-7111
Graham Davis Inc., Dallas, TX 214-357-7677
PRODUCTS: automixing

Marcom (The Scotts Valley Grp.) Inc

P.O. Box 66507
Scotts Valley, CA 95066
(408) 438-4273 FAX: (408) 438-6617
President: Martin Jackson; Vice-President: Shirley Jackson; Sales Specialist: Ted Tripp
Engineer: Brant Herrett
Camden Marketing, Pierre Fonds, QU 514-683-3377
PRODUCTS: automixing, manual, microphone specific, microprocessor, telephone interface

Meridian Communications

P.O. Box 97
Alameda, CA 94501
(415) 769-1515 FAX: (415) 523-6296
President: Shel Gunther
Audio Etc., St. Peters, MO 314-278-4130
PRODUCTS: manual

Orchard Communications

101 N. Plains Industrial Road
Wallingford, CT 06492
(203) 284-1680 (800) 523-7893 FAX: (203) 269-2964
President: John M. Iles; Dir. of Systems Engineering: Dean H. Bogert; Vice President of Sales: Ronald F. Jones
Loomis and Associates, Fremont, CA 415-683-0883

OXMOOR CORP.

2111 Parkway Office Circle
Birmingham, AL 35244
(205) 985-7040 FAX: (205) 985-9966
President: Lynn A. McCroskey; Vice President/Manager: Gary L. West; National Sales Manager: Richard C. Mitchell; Sales Associate: Nick Alsmiller; Production Manager: Jim Watson; Director of Engineering: Gene Elghmy
John B. Anthony Company, Stamford, CT 212-585-2027
ASR, Fallston, MD 301-893-0001
Audio Resources, Westmont, IL 708-655-1180
Dimension IX Marketing, Lewisville, TX 214-436-3706
Evans Sales and Marketing, Nashville, TN 615-297-7997
Loomis and Associates, Fremont, CA 415-683-0883
Loppnow and Associates, Issaquah, WA 206-392-3936
R.J. Throckmorton Sales Co., Ballwin, MO 314-227-7222
Repworks, Chicopee, MA 413-553-0845
PRODUCTS: automixing

SHURE BROTHERS, INC.

222 Hartrey Avenue
Evanston, IL 60202-3696
(708) 866-2200 (800) 257-4873 FAX: (708) 866-2279
President: James H. Kogen; Vice Pres, Finance & Sales: Robert Gilbert; Vice President, Sales: Lottie Morgan; Director, Technical Markets: John Phelan; Director Microphone Products: Sandy Schroeder; Dir., Mktg. Communications: Nancy Calvert
Audio Biz, Mundelein, IL 708-949-0280
PCM Marketing, Walnut Creek, CA 415-935-0900
Peter E. Schmitt Company, Inc., Leonia, NJ 201-944-2806
Millar Electronics, Inc., Atlanta, GA 404-634-3350
Pro Tech Marketing, Midvale, UT 801-561-8844
Karp Communications, Tampa, FL 813-968-7098

Circle 275 on Reader Response Card

Solid State Systems

1300 Shiloh Rd.
Kennesaw, GA 30144
(404) 423-2229 FAX: (404) 423-2228
Camden Marketing, Pierre Fonds, QU 514-683-3377

SONY CORP. OF AMERICA, A/V PRODUCTS

10833 Valley View Street, Cypress, CA 90630
(714) 229-4318 (800) 326-7669 FAX: (714) 229-4298
Vertical Markets Manager: T. Park; AV Product Manager: A. Nitka; AV Sales Manager: K. Carr; AV Product Support Spvr.: A. Ruppe; Management Associate: D. Williams; Product Support Coordinator: P. Penell
Cambridge Marketing, Westerville, OH 614-363-9191

Sony Corp./Business & Pro. Aud. Grp

3 Paragon Drive
Montvale, NJ 07645-1735
(201) 930-1000
President, Sales & Marketing: Mark Gray; Senior VP Sales: C.F. Taylor; V.P. Product Marketing: Anthony Gargano; Marketing Manager, Pro Audio: Courtney Spencer; Sales Manager, Pro Audio: Gary Rose; V.P. Audio Products: Ron Remschel
Matt Robertson, Western Dist., 213-469-9084
Audio Etc., St. Peters, MO 314-278-4130

Sound Control Technologies, Inc.

28 Knight St.
Norwalk, CT 06851
(203) 854-5701 FAX: (203) 854-5702
President: Adolph Neaderland; Sales/Marketing: David Neaderland
Powerlines Marketing, Chicago, IL 708-864-1147
Franklin Communications, Philadelphia, PA 215-643-2808
KB2 Communications, New York, NY 215-348-9481
Visitec Marketing, Minneapolis, MN 612-925-2691
Total Marketing, Fort Worth, TX 817-560-3970
Karp Communications, Tampa, FL 813-968-7098
Richard Krupop, Andalusia, AL 205-222-8950
PRODUCTS: microprocessor, telephone interface

Studer Revox America, Inc.

1425 Elm Hill Pike
Nashville, TN 37210
(615) 254-5651 FAX: (615) 256-7619
President: Tore Nordahl; Executive Vice President: Bill Muggler; Director, Professional Prods: David Bowman; Director of Tech. Operations: Jim Kurowski; Dir. of Tech. and Mktg. Svcs: Doug Beard
Studer Revox America, New York, NY 212-255-4462
Studer Revox America, Los Angeles, CA 818-780-4234
Studer Revox Canada Ltd., Toronto, CA 416-510-1347
Jim Burger, Philadelphia, PA 203-297-7160
PRODUCTS: telephone interface

Teleconferencing Systems Int'l Inc.

925 Tonne Rd.
Elk Grove Vill., IL 60007
(708) 228-5444
President: Fred Toussaint; Vice President, Sales: Tom O'Malley; Vice President, Engineering: Gerald Delnzer
Camden Marketing, Pierre Fonds, QU 514-683-3377

Telos Systems

1729 Superior Avenue
Cleveland, OH 44114
(216) 241-7225 FAX: (216) 241-4103
Audio Bliz, Mundellen, IL 708-949-0280

TSI (Tamco Systems Inc.)

393 Jericho Turnpike
Mineola, NY 11501
(516) 294-5390 (800) 628-2084 FAX: (516) 294-5008
CEO: Marlo Maltese; President: Garani Srinivasan; President (Spec. Prod. Div.): Richard Stillwell; Sales Coordinator: Denise Matejka; Marketing Manager: Karen Pepe
JMS Marketing, Austin, TX 512-266-1113
PRODUCTS: telephone interface

Westell

7630 Quincy St.
Willowbrook, IL 60521 (800) 323-6883

**A.W. Sperry Instruments**

245 Marcus Blvd.
Hauppauge, NY 11788
(516) 231-7050 (800) 645-5398 FAX: (516) 434-3128
President: Fred Malawista; V.P., Sales and Marketing: Dennis W. Carroll; Comptroller: Rebecca Bellinate; Engineer: Kevin Basso; Office Manager: Carol Sugrue; Sales/Service Manager: Joanne Doherty
Camden Marketing, Pierre Fonds, QU 514-683-3377
PRODUCTS: analog multimeters, bench-top instrumentation, digital multimeters, digital storage oscilloscopes, hand-held instruments, oscilloscopes

ACO Pacific, Inc.

2604 Read Ave.
Belmont, CA 94002
(415) 595-8588 FAX: (415) 591-2891
President: Noland Lewis
Davis Engineering, Indianapolis, IN 317-299-9655
WestTech, Seattle, WA 206-271-5490
PRODUCTS: bench-top instrumentation, noise & vibration analyzers, precision amplifiers, sound intensity measurement equipment & microphones, SPL meters, transducers

Acoustilog, Inc.

19 Mercer St.
New York, NY 10013
(212) 925-1365
Sales Manager: Greg Guarino
PRODUCTS: RT60 meters

Altair Electronics

1694 Calle Zocalo
Thousand Oaks, CA 91360
(805) 529-2496
J.B. Parent, Dublin, OH 614-764-0064

Amber Electro Design, div. Coreco

6969 Trans-Canada Hwy., Ste.113
St. Laurent, QU H4T 1V8
(514) 333-8748 (800) 361-4914 FAX: (514) 333-1388
Sales Manager: Vincent DeSouza; Technical Support Specialist: Hermann Elbich; Sales & Marketing Assistant: Ilona Scholch
Creative Marketing Assoc. Ltd., Columbia, MD 301-880-4161
Data Marketing Associates, Dallas, TX 214-661-0300
Pat Jenks Associates, Beverly, MA 508-921-4600
Scientific Devices West, Huntington Bch., CA 714-840-3501
Southern Marketing Associates, Longwood, FL 407-682-7317
Doug Warren, Newport News, VA 804-930-3217

Amprobe Instrument

630 Merrick Rd.
P.O. Box 329, Lynbrook, NY 11563
(516) 593-5600 FAX: (516) 593-5683
Vice President, Sales: D. Ladd; Vice President, Production: J. Perilli; Marketing Manager: C. Dengler; Advertising Manager: R. Christopher; Application Engineer: M. Hendrickson
Atlas Electronics, Toronto, ON 416-789-7761
ADCOM, Toronto, ON 416-251-3355
PRODUCTS: analog multimeters, cable testers, digital multimeters, electronic tools, hand-held instruments, metering systems, transducers

Ariel Corp.

433 River Rd.
Highland Park, NJ 08904
(908) 249-2900 FAX: (908) 249-2123
President: Anthony Agnello; Product Manager: Fred Ridder
Precide, Morbio Inferiore, Switzerland, 914-31734

Audio Control Industrial

22313 70th Avenue West
Mountlake Terr., WA 98043
(206) 775-8461 FAX: (206) 778-3166
Sales Manager: Rick Chinn; President: Tom Walker; Export Sales: Ron Haverkamp
PRODUCTS: CD test disks, function generators, realtime analyzers

Audio Precision

P.O. Box 2209
Beaverton, OR 97075
(503) 627-0832 (800) 231-7350 FAX: (503) 641-8900
President, Int'l Mktg Mgr.: Bob Metzler; U.S. Marketing and Sales Dir: Tom Mintner
Northwest Test and Measurement, Beaverton, OR 503-645-9000
Douglas Ordon and Company, Inc, Chicago, IL 312-889-5532
Martech Sales Company, Scotts Valley, CA 408-439-9672
Spectra Sales, Richardson, TX 214-234-3600
Elmark, Huntington Val., PA 215-947-0750
Shea Sales, Maplewood, NJ 201-762-2382
Parsons Audio, Wellesley Hills, MA 617-431-8708
Southeastern Design & Consulting, Nashville, TN 615-883-7375
PRODUCTS: audio tape diagnostics, distortion analyzers, DSP hardware, DSP software, dual-channel spectrum analyzers, FFT-spectrum analyzers, FM stereo testing, frequency-domain acquisition/analysis, MTS test equipment, PC systems, software

AVNC/Instrument Div.

250 Shagbark Dr., RD #1
Cheswick, PA 15024
(412) 265-4444
J.B. Parent, Dublin, OH 614-764-0064

B & B Systems, Inc.

28111 Ave. Stanford, Valencia, CA 91355
 (805) 257-4853 (800) 345-1256 FAX: (805) 257-4853
 President/CEO: William Burnsed; Managing Director: John Bradford; Executive Vice President: Dave Bartolone;
 Manufacturing/Product Sales: Ramon Patron; Purchasing: Dana Kelly; Systems Engineer: Kevin Bohn
 J.B. Parent, Dublin, OH 614-764-0064
 PRODUCTS: metering systems, oscilloscopes

B & K Precision

6470 West Cortland St, Chicago, IL 60635
 (312) 889-1448 FAX: (312) 794-9740
 President, B & K Precision: Bob Tyler; President, International Div: Joe Jaboszewski; Director of Sales: Richard Polak; Director of Marketing: John Kong; Vice President, Int'l: Gerry Zigman; Manager, Mkt'g Comm.: Gregg Elmore
 Mike Roth Sales, Inc., Santa Ana, CA 714-647-0606
 Erickson Sales Inc., Dallas, TX 214-739-2329
 Bralnard-Nielsen Marketing Inc, Arlington Hts., IL 708-437-6438
 Electra-Tech, Edgewood, MD 301-676-2254
 Champion Electronic Sales, Medford, NJ 609-983-0707
 Audio Etc., St. Peters, MO 314-278-4130
 PRODUCTS: analog multimeters, bench-top instrumentation, digital multimeters, digital storage oscilloscopes, FFT-spectrum analyzers, function generators, hand-held instruments, oscilloscopes, video test signal generators

Beckman Industrial Corporation

3883 Ruffin Road, San Diego, CA 92123-1898
 (619) 495-3200 (800) 854-2708 FAX: (619) 268-0172
 President: Robert Buchanan; Vice President Marketing: James Bordin; Director of Sales: Michael Latham; Customer Service Manager: Don Borawski; Credit Supervisor: Rae Aldridge
 Len Bednar, Reg. Sales Mgr., Cherry Hill, NJ 609-751-4106
 Neil Christensen, Reg Sales Mgr., LaHabra, CA 213-690-4383
 Steve Arnold, Reg. Sales Mgr., Toledo, OH 419-535-3875
 Larry Bines, Reg. Sales Mgr., Dallas, TX 214-392-2958
 Nova Marketing, San Francisco, CA 415-952-0943
 PRODUCTS: digital multimeters

BJM Electronics Ltd.

2589 Richmond Terrace
 Staten Island, NY 10303
 (718) 442-0223 FAX: (718) 442-1451
 President: Robert Manzo; Sales Manager: Jeff Salitel; Purchasing: Jason Manzo
 Precide, Morbio Inferiore, Switzerland, 914-31734
 PRODUCTS: cable testers, hand-held instruments, lineman's test sets, mic cable testers, oscilloscopes, tool kits, video test signal generators, waveform recorders

Boonton Electronics

791 Rt. 10
 Randolph, NJ 07869
 (201) 584-1077
 J.B. Parent, Dublin, OH 614-764-0064

Bruel & Kjaer Instruments, Inc.

185 Forest Street
 Marlborough, MA 01752
 (508) 481-7000 FAX: (508) 485-0519
 President: Joseph Gill; Vice President, Finance: Kenneth Fisher; Advertising Manager: Julie Peiz; Purchasing Manager: Donna Hay; National Service Manager: Ronald Coble
 Bruel & Kjaer, Hoffman Estates, IL 708-358-7582
 Bruel & Kjaer, Orange, CA 714-978-8066
 Bruel & Kjaer, Marletta, GA 404-422-5200
 Bruel & Kjaer, West Caldwell, NJ 201-227-6100
 Bruel & Kjaer, Livonia, MI 313-522-8600
 Nova Marketing, San Francisco, CA 415-952-0943

PRODUCTS: bench-top instrumentation, distortion analyzers, dual-channel spectrum analyzers, FFT-spectrum analyzers, filter sets, frequency-domain acquisition/analysis, hand-held instruments, noise & vibration analyzers, plotters, precision amplifiers, realtime analyzers, sound intensity measurement equipment & microphones, speech transmission analysis/Intelligibility, transducers

Calculated Industries, Inc.

22720 Savi Ranch Parkway
 Yorba Linda, CA 92687
 (714) 921-1800 (800) 854-8075 FAX: (714) 921-2799
 President: Fred Alexander; Vice President: Ken Alexander; General Manager: Steve Kennedy; Director of Advertising: Mark Paulsen
 Audio Etc., St. Peters, MO 314-278-4130

Celestial Software

125 University Ave.
 Berkeley, CA 94710
 (415) 420-0300

CG Instruments

434 Windsor Park Dr.
 Dayton, OH 45459
 (513) 434-6952 FAX: (513) 434-7643

Chadwick Helmuth

4601 N. Arden Dr.
 El Monte, CA 91731
 (818) 575-6161

Computational Systems

835 Innovation Dr., Ste. 110
 Knoxville, TN 37932
 (615) 675-2110 FAX: (615) 675-3110

Contact East, Inc.

335 Willow Street
 No. Andover, MA 01845
 (508) 682-2000 (800) 225-5370 FAX: (508) 688-7829
 Customer Service Manager: Jayne Handscom; Sales Manager: Dick Sullivan; Marketing & Media: Mary Lou Adamowski
 Contact East Inc., Wallingford, CT 203-265-9333
 Edwards Company, Inc., Livonia, MI 313-458-7777
 PRODUCTS: analog multimeters, bench-top instrumentation, cable testers, data acquisition, digital multimeters, digital storage oscilloscopes, dual-channel spectrum analyzers, electronic tools, function generators, hand-held instruments, lineman's test sets, logic analyzers, metering systems, oscilloscopes, RF signal generators, tool kits

Cretec Signal Computer USA

3337 Kifer Rd.
 Santa Clara, CA 95051
 (408) 738-3744 FAX: (408) 749-8172

Cyborg

94 Bridge Street
 Newton, MA 02158
 (617) 964-9020 FAX: (617) 332-8819
 Taub Sales, Silver Springs, MD 301-662-9100

Data Check

9918 Via Pasar
 San Diego, CA 92126
 (619) 578-0101 FAX: (619) 566-2014

Data Physics

1210 S. Bascom Ave., Ste. 224
 San Jose, CA 95128
 (408) 977-0800 FAX: (408) 977-0801

Davis Instrument Mfg. Co., Inc.

4701 Mt. Hope Dr.
 Baltimore, MD 21215
 (301) 358-3900 (800) 368-2516 FAX: (301) 358-0252
 John Anthony, Stamford, CT 203-322-9202

Dorrough Electronics

5221 Collier Place
 Woodland Hills, CA 91364
 (818) 999-1132 FAX: (818) 998-1507
 President: Michael Dorrough
 Allied Broadcast Equipment, Richmond, IN 317-962-8596
 Bradley Broadcast Sales, Galtersburg, MD 301-948-0650
 Midwest Communications, Highland Hts., KY 606-781-2200
 Westlake Audio, Los Angeles, CA 213-851-9800
 Winfield Scott & Assoc, Grapevine, TX 303-582-3433
 Edwards Company, Inc., Livonia, MI 313-458-7777
 PRODUCTS: metering systems, sound intensity measurement equipment & microphones, waveform recorders

DRA Laboratories

607 W. Nettletree Road
 Sterling, VA 22170
 (703) 430-2761 FAX: (703) 430-0765
 Edwards Company, Inc., Livonia, MI 313-458-7777
 PRODUCTS: FFT-spectrum analyzers, PC systems, software, RT60 meters, speech transmission analysis/Intelligibility, SPL meters, transducers

DSP Development Corp.

One Kendall Square Bldg. 100
 Cambridge, MA 02139
 (617) 577-1133 FAX: (617) 577-8211
 Sales Administrator: Susan Stewart
 John Anthony, Stamford, CT 203-322-9202
 PRODUCTS: DSP software, frequency-domain acquisition/analysis, PC systems, software

Dunegan Div., Physical Acoustics

19-B Thomas St.
 Irvine, CA 92718
 (714) 380-1544 FAX: (714) 951-1269

Dynamic Software Systems

6272 Guyson Ct.
 Pleasanton, CA 94566
 (415) 484-1111

Endevco

30700 Rancho Viejo Rd.
 San Juan Capistrano, CA 92675
 (714) 493-8181 FAX: (714) 661-7231

Forward Innovations

P.O. Box 9429
 Santa Rosa, CA 95405 (800) 866-6264
 Partner: W.A. Cooney; Partner: Dave Bronfeld
 Audio Etc., St. Peters, MO 314-278-4130

GHI Systems

916 N. Western Ave., 201
 San Pedro, CA 90732
 (213) 548-6544 FAX: (213) 548-5749

Gold Line

P.O. Box 500
 W. Redding, CT 06896
 (203) 938-2588 FAX: (203) 938-8740
 President: Martin E. Miller; Vice President: Lennart Landellus; Vice President, Sales: Marjorie D. Miller
 C.L. Pugh and Associates, Cleveland, OH 216-238-1777
 Quad Mkt. Shawnee Mission, KS 913-677-1013
 Brian Trankle, Belmont, CA 415-595-4004
 William J. Ray, Smyrna, GA 404-436-7233
 Pro Musica, Keene, NH 603-352-4831
 John Anthony, Stamford, CT 203-322-9202

Hewlett-Packard

3000 Hanover St.
Palo Alto, CA 94304
(415) 857-1501 FAX: (415) 857-5518

Hoffend & Sons

34 E. Main St.
Honeoye, NY 14471
(716) 229-5998 FAX: (716) 229-2746

Honeywell Test Instruments Div.

P.O. Box 5227
Denver, CO 80217
(303) 773-4700 FAX: (303) 773-4762

Ivle Technologies Inc.

1366 West Center, Orem, UT 84057
(801) 224-1800 FAX: (801) 224-7526
President: Craig Berry; Vice President,
Marketing: Glenn Meyer; Vice President,
Product Mgt.: Larry Driskill; Sales Coordinator:
Georgia Hall; Production Vice President: Bob
Greene
Western Audio Sales, Burbank, CA 818-954-9300
Metropolis Audio Marketing, Edison, NJ
201-225-0085
Meyer Marketing, Deerfield Beach, FL 305-481-9250
Radon and Associates, Sacramento, CA
916-923-2524
Loppnow and Associates, Issaquam, WA
206-392-3936
Multi-Technical Reps., Brainerd, MN 218-828-9483

Iwatsu America

430 Commerce Blvd.
Carlstadt, NJ 07072
(201) 935-8580

Jensen Tools

7815 S. 46th St.
Phoenix, AZ 85044
(602) 968-6241 FAX: (800) 366-9662
Marketing Manager: Gary Treiber
PRODUCTS: analog multimeters, bench-top
instrumentation, cable testers, digital
multimeters, digital storage oscilloscopes,
electronic tools, function generators, hand-held
instruments, lineman's test sets, oscilloscopes,
tool kits

John Fluke Manufacturing Co., Inc.

6920 Seaway Blvd.
Everett, WA 98203
(206) 347-6100 (800) 443-5853 FAX: (206) 356-5116
CEO: Bill Parzybok; President: George Winn;
Director of Worldwide Sales: Ronald R. Wambolt;
Marketing Communications Mgr: Bob Virkelyst
John Fluke Mfg. Co., Inc., Irvine, CA 714-863-9031
John Fluke Mfg. Co., Inc., Palatine, IL 708-705-0500
John Fluke Mfg. Co., Inc., Paramus, NJ
201-262-9550
John Fluke Mfg. Co., Inc., Fremont, CA
415-651-5112
Fluke Electronics Canada, Mississauga Ont,
416-890-7600
C.B. Electronic Marketing, Arvada, CO
303-422-0561
PRODUCTS: analog multimeters, bench-top
instrumentation, data acquisition, digital
multimeters, digital storage oscilloscopes,
function generators, hand-held instruments,
oscilloscopes, PC systems, software, RF signal
generators, video test signal generators

Kay Elemetrics Corp.

12 Maple Ave.
P.O. Box 2025
Pine Brook, NJ 07058
(201) 227-2000 FAX: (201) 227-7760
President: John M. Crump; Sales Manager:
Stephen P. Crump; Director of Engineering: Bill
Harbeson; Controller: George Zolnowski

Keithley Instruments Div.

28775 Aurora Rd.
Cleveland, OH 44139
(216) 248-0400

Kelvin Electronics

7 Fairchild Ave.
Plainville, NY 11801
(516) 349-7620 (800) 645-9212 FAX: (516) 349-7830
Doug Warren, Newport News, VA 804-930-3217
PRODUCTS: analog multimeters, bench-top
instrumentation, digital multimeters, function
generators, logic analyzers, oscilloscopes

Kinometrics/TrueTime

3243 Santa Rosa Ave.
Santa Rosa, CA 95407
(707) 528-1230

Krohn-Hite

255 Bodwell St.
Avon, MA 02322
(617) 580-1660 FAX: (508) 583-8989

Menlo Scientific, Ltd.

Acoustical Consulting
and design services for
sound contractors

Contact Michael Klasco

Menlo Scientific, Ltd.
39 Menlo Place
Berkeley, California 94707

(415) 528-1277

FAX (415) 526-8087

Labor Saving Devices

1355 Marlan St., Lakewood, CO 80214
(303) 232-6341 (800) 648-4714 FAX: (303) 233-8769
M.A.B. Corporation DIX, 800-535-2850
McCarten Company, Denver, CO 303-239-0790
Audio Etc., St. Peters, MO 314-278-4130
PRODUCTS: cable testers, electronic tools, hand-held instruments, tool kits

Larson Davis Laboratories

1681 W 820 N, Provo, UT 84601
(801) 375-0177 FAX: (801) 375-0182
Director of Marketing: John Carey
Audio Etc., St. Peters, MO 314-278-4130
PRODUCTS: dual-channel spectrum analyzers, FFT-spectrum analyzers, hand-held instruments, noise & vibration analyzers, sound intensity measurement equipment & microphones

Leader Instruments Corp.

380 Oser Avenue, Hauppauge, NY 11788
(516) 231-6900 (800) 645-5104
President: S. Hirota; Director of Sales: R. Sparks;
Product Market Manager: J. Fisher
Audio Etc., St. Peters, MO 314-278-4130
PRODUCTS: analog multimeters, bench-top instrumentation, cable testers, digital multimeters, digital storage oscilloscopes, distortion analyzers, FM stereo testing, function generators, hand-held instruments, logic analyzers, metering systems, MTS test equipment, oscilloscopes, RF signal generators, vector scopes, video test signal generators, waveform recorders

LEQ Measurements

175 Advance Blvd., Brampton, ON L6T 4J1
(416) 791-3440

Lucasfilm Ltd./THX Group

5858 Lucas Valley Road
P.O. Box 2009, San Rafael, CA 94912
(415) 662-1900 FAX: (415) 662-2186
Audio Biz, Mundellen, IL 708-949-0280
PRODUCTS: bench-top instrumentation, data acquisition, frequency-domain acquisition/analysis, microprocessor systems, noise & vibration analyzers, PC systems, software, realtime analyzers, RT60 meters, speech transmission analysis/intelligibility, SPL meters

Magnetic Reference Lab

229 Polaris Ave, Suite 4, Mountain View, CA 94043
(415) 965-8187 FAX: (415) 965-8548
Technician: Jay McKnight; Production Manager: Chuck Booye; Administration: Marlena Covaars
T.C. Marketing, Reseda, CA 818-776-8120
PRODUCTS: audio tape diagnostics

Meridian Technologies, Inc.

80 Mott Avenue, Inwood, NY 11696
(516) 371-9300 FAX: (516) 371-9301
President: Robert Klein; Director of Engineering: Jack Krol
Doug Warren, Newport News, VA 804-930-3217
PRODUCTS: cable testers, electronic tools, hand-held instruments, metering systems, tool kits, transmission link testing

MetraByte

440 Myles Standish Blvd.
Taunton, MA 02780
(508) 880-3000 FAX: (508) 880-0179
Camden Marketing, Pierre Fonds, QU 514-683-3377

Metrosonics

P.O. Box 23075
Rochester, NY 14692
(716) 334-7300
Camden Marketing, Pierre Fonds, QU 514-683-3377

Meyer Sound Laboratories Inc.

2832 San Pablo Ave.
Berkeley, CA 94702
(415) 486-1166 FAX: (415) 486-8356
Vice President, Sales & Mktg: Helen Meyer;
Marketing Manager: Ralph Jones; Director of Technical Mkt'g: Mark Johnson; Customer Service Manager: Scott Gledhill; National Sales Manager: Cindy Ramos
Loomis and Associates, Fremont, CA 415-683-0883
PRODUCTS: dual-channel spectrum analyzers, FFT-spectrum analyzers

Multigon Industries, Inc.

559 Gramatan Ave.
Mt. Vernon, NY 10552
(914) 664-7300 FAX: (914) 664-9502
President: W. Stern; Vice President, Sales: A. Frum; Vice President, Operations: L. Machmir;
Chief Purchasing Agent: G. Miller; Assistant Purchasing Agent: A. Wizenbag
Camden Marketing, Pierre Fonds, QU 514-683-3377

Music Supply Company, Inc.

809 N. Madison, Dallas, TX 75208
(214) 946-8450 (800) 527-1522 FAX: (214) 946-9155
President: W.E. Brown; Sales: Betty Brown
Audio Etc., St. Peters, MO 314-278-4130

Neutrik USA, Inc.

195-s3 Lehigh Ave., Lakewood, NJ 08701
(908) 901-9488 FAX: (908) 901-9608
General Manager: James E. Cowan; Product Manager: Kenneth W. Smalley; Product Manager: William J. Dorman
Dimension/ Point IX, Lewisville, TX 214-436-3706
PRODUCTS: bench-top instrumentation, distortion analyzers, noise & vibration analyzers, sound intensity measurement equipment & microphones

Nicolet Instrument Corporation

5225 Verona Rd
P.O. Box 4288
Madison, WI 53711
(608) 271-3333 FAX: (608) 273-5061
Dimension/ Point IX, Lewisville, TX 214-436-3706

Non-Linear Systems

4174 Sorrento Valley Blvd.
San Diego, CA 92121
(619) 535-2161 FAX: (619) 535-2169
Sales Manager: Jeanne Simmons
Camden Marketing, Pierre Fonds, QU 514-683-3377
PRODUCTS: bench-top instrumentation, hand-held instruments, lineman's test sets, metering systems, oscilloscopes

Norland

Norland Dr., Fort Atkinson, WI 53538
(414) 563-8456 FAX: (414) 563-8456
Camden Marketing, Pierre Fonds, QU 514-683-3377

PEAVEY ELECTRONICS CORP.

711 A Street
P.O. Box 2898, Meridian, MS 39301
(601) 483-5365 FAX: (601) 484-4278
CEO: Hartley Peavey; President: Mella Peavey
Dimension/ Point IX, Lewisville, TX 214-436-3706
PRODUCTS: cable testers, distortion analyzers, DSP hardware, DSP software, mic cable testers, precision amplifiers, realtime analyzers

Princeton Applied Research

P.O. Box 2565, Princeton, NJ 08650
(609) 452-2111 FAX: (609) 883-7259
Camden Marketing, Pierre Fonds, QU 514-683-3377

Progressive Electronics

325 S. El Dorado, Mesa, AZ 85202
(602) 966-2931 FAX: (602) 967-8602
Camden Marketing, Pierre Fonds, QU 514-683-3377

Prosonus

11126 Weddington St, North Hollywood, CA 91601
(818) 766-5221 (800) 999-6191 FAX: (818) 766-6098
Vice President: Martin Fortler; Production Director: Mark Hlskey; Director of Sales/ U.S.A.: Tom Meadows; Director of Client Relations: Shelly Williams
Dimension/ Point IX, Lewisville, TX 214-436-3706
PRODUCTS: CD test disks

Quest Electronics

510 S. Worthington St., Oconomowoc, WI 53066
(414) 567-9157 (800) 245-0779 FAX: (414) 567-4047
Managing Director: Paul James; General Manager: James Banach; Engineering Manager: Ted Kuemmel; Customer Service Manager: Rita Suechting
Quest Electronics, Baltimore, MD 301-252-3347
Quest Electronics, Los Angeles, CA 714-495-3639
Quest Electronics, Atlanta, GA 404-979-6281
Dimension/ Point IX, Lewisville, TX 214-436-3706

R.B. Annis Co, Inc.

1101 N. Delaware Street, Indianapolis, IN 46202
(317) 637-9282 FAX: (317) 637-9282
President: R.B. Annis; Production Manager: R.D. Hudson; Secretary: B. Hamdrick
Audio Etc., St. Peters, MO 314-278-4130
PRODUCTS: bench-top instrumentation, hand-held instruments

R.C. Electronics, Inc.

6464 Hollister Ave., Goleta, CA 93117
(805) 685-7770 FAX: (805) 685-5853
President: Richard Renck; Vice President, Marketing: Chao-Sun Pang; Vice President, Operations: Brian Scarminach
Camden Marketing, Pierre Fonds, QU 514-683-3377
PRODUCTS: data acquisition, digital storage oscilloscopes, dual-channel spectrum analyzers, FFT-spectrum analyzers, filter sets, frequency-domain acquisition/analysis, function generators, realtime analyzers, waveform recorders

RAG Electronics

21418 Parthenia St., Canoga Park, CA 91304
(818) 998-6500 FAX: (818) 407-5559
Camden Marketing, Pierre Fonds, QU 514-683-3377

Rapid Systems, Inc.

433 N. 34th Street, Seattle, WA 98103
(206) 547-8311 FAX: (206) 548-0322
President: Tom Bardeen; Vice President: Bo Ray
Sunrise Sales Company, LaMolle, IL 815-638-2660

RE Instruments Corp.

31029 Center Ridge Rd, Westlake, OH 44145
(216) 871-7617 FAX: (216) 871-4303
President: P.A. Bosworth; Sales & Mktg. Manager: T.M. Ruane; Engineering Manager: M. Hirka; Operations Manager: S.L. Watts
Camden Marketing, Pierre Fonds, QU 514-683-3377

Riser-Bond Instruments

5101 N. 57th Street
Lincoln, NE 68507
(402) 466-0933 (800) 688-8377 FAX: (402) 466-0967
President: Marshall B. Borchert; Director of Operations: Jennie M. Borchert; Vice President, Sales/Mktg.: Walter (Duff) Campbell; National Sales Manager: R.P. (Dick) Sommerfeld; Regional Sales Manager: Deb Nissen; Media Specialist: Sheryl Anderson
Karp Communications, Tampa, FL 813-968-7098
PRODUCTS: cable testers, electronic tools, hand-held instruments, lineman's test sets

Rockland Scientific Corp.

P.O. Box 3135
Princeton, NJ 08543
(609) 844-0800 FAX: (609) 895-9726
CEO: Sotirios J. Vahaulolos; Vice President,
Engineering: S.N. Thanos; Sales Manager:
Michael Classen; Director of Operations: Charles
Schulz
Sunrise Sales Company, LaMolle, IL 815-638-2660
PRODUCTS: dual-channel spectrum analyzers,
FFT-spectrum analyzers, noise & vibration
analyzers, realtime analyzers, waveform
recorders

Schlumberger Technologies

829 Middlesex Turnpike
P.O. Box 7004
Billerica, MA 01821
(508) 671-9700 (800) 225-5765 FAX: (508) 671-9704
Karp Communications, Tampa, FL 813-968-7098

Scientific Atlanta/OPTIMA Div.

2166 Mountain Ind'l Blvd.
Tucker, GA 30084
(619) 268-7100 FAX: (619) 268-7074

Scott Instrument Lab., Div. of Lind

40 Roselle St.
Mineola, NY 11501
(516) 746-6505 FAX: (516) 746-6510
Camden Marketing, Pierre Fonds, QU 514-683-3377

Sencore

3200 Sencore Drive
Sioux Falls, SD 57107
(605) 339-0100 (800) 736-2673 FAX: (605) 335-6379
President: Al Bowden; V.P., Sales and Marketing:
Doug Bowden; National Sales Manager: Garrett
Carter
Sunrise Sales Company, LaMolle, IL 815-638-2660
PRODUCTS: bench-top instrumentation, cable
testers, FM stereo testing, MTS test equipment,
oscilloscopes, RF signal generators, sound
intensity measurement equipment &
microphones, video test signal generators

Sennheiser Electronic Corp.

6 Vista Drive
P.O. Box 987
Old Lyme, CT 06371
(203) 434-9190 FAX: (203) 434-1759
President: Andrew Brakhan; Pro Products
Manager: Albert C. Zang Jr.
MJA Marketing, St. Charles, MO 314-447-7111
PRODUCTS: bench-top instrumentation

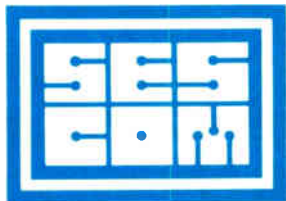
**SESCOM, INC.**

2100 Ward Drive, Henderson, NV 89015
(702) 565-3400 (800) 634-3457 FAX: (702) 565-4828
President: Franklin J. Miller; Vice President:
Brenda Miller
Cambridge Marketing, Westerville, OH 614-363-9191
PRODUCTS: cable testers, distortion analyzers,
function generators, hand-held instruments, mic
cable testers, oscilloscopes

Shigma/Ono Soki C. Ltd.

80 Martin Ln.
Elk Grove Villa, IL 60007
(708) 640-8640 FAX: (708) 640-1276
Camden Marketing, Pierre Fonds, QU 514-683-3377

Simpson Electric

853 Dundee Ave.
Elgin, IL 60120
(708) 697-2260
Camden Marketing, Pierre Fonds, QU 514-683-3377

Soltec Corp.

12977 Arroyo St.
San Fernando, CA 91340
(818) 365-0800 FAX: (818) 365-7839
Camden Marketing, Pierre Fonds, QU 514-683-3377
PRODUCTS: PC systems, software, plotters,
realtime analyzers, transducers, waveform
recorders

Sound Technology, Inc.

1400 Dell Ave
Campbell, CA 95008
(408) 378-6540 FAX: (408) 378-6847
President: Robert Andersen; Sales Manager: Lee
White
Atlantic Marketing Services, Charlotte, NC
704-542-3380
Hartman Associates, Long Valley, NJ 908-850-3750
Funke and Associates, Campbell, CA 408-866-0648
Hartman and Associates, W. Chicago, IL
708-231-5915

Pringle Division, Willowdale, ON 416-262-2447
PRODUCTS: audio tape diagnostics, distortion
analyzers, dual-channel spectrum analyzers,
frequency-domain acquisition/analysis, realtime
analyzers, RT60 meters, sound intensity
measurement equipment & microphones, SPL
meters

SPM Instrument

359 N. Main St.
Marlborough, CT 06447
(203) 295-8241 FAX: (203) 295-0182
Camden Marketing, Pierre Fonds, QU 514-683-3377

Standard Tape Laboratory, Inc.

26120 Eden Landing Road, #5
Hayward, CA 94545
(415) 786-3546 FAX: (415) 786-1180
Karp Communications, Tampa, FL 813-968-7098

Structural/Kinematics

950 Maplelawn, Troy, MI 48084
(313) 643-4622 FAX: (313) 643-6790
Camden Marketing, Pierre Fonds, QU 514-683-3377

Techron, div. Crown International

1718 W. Mishawaka Road, Elkhart, IN 46517
(219) 294-8300 FAX: (219) 294-8329
Sales Manager: Larry Shank; Marketing Manager:
Jim Bumgardner
Audio Biz, Mundellen, IL 708-949-0280
PRODUCTS: DSP hardware, RT60 meters, speech
transmission analysis/ intelligibility

World's Most Popular RTA

Affordable, 1/3 Octave, Real Time Analyzer With Memories & SPL Display SA-3050A

- Large, easy to read display-selectable RTA or SPL
- Discrete ANSI class II filters
- Digital full screen SPL or bar graph with peak hold
- 3 display speeds
- Six nonvolatile memories, can be averaged & weighted
- Freeze frame
- Peak hold on RTA
- Printer interface, internal battery, rack mount, case optional
- Pink Noise
- 1, 2, 3, & 4 dB resolution
- 92 dB range plus fine sensitivity
- Made in USA
- Balanced XLR, balanced 1/4" & BNC

Also available: Plug-in A & C Weighting Filter, Prosonus SRD Test Compact Disc, Accurate measuring devices

Call today for more information!

AudioControl Industrial™

22313 70th Ave West • Mountlake Terrace, WA 98043 • (206) 775-8461 • FAX (206) 778-3166

Circle 267 on Reader Response Card

Tektronix Signal Analysis Unit

1350 Dell Ave., Campbell, CA 95008
 (408) 374-6464 (800) 234-1256 FAX: (408) 374-6467
 U.S. Sales Manager: Jon Milbrandt; Marketing
 Manager: Curt Quantz
 Audio Biz, Mundellin, IL 708-949-0280
 PRODUCTS: data acquisition, dual-channel
 spectrum analyzers, FFT-spectrum analyzers,
 noise & vibration analyzers, oscilloscopes, PC
 systems, software

Tentel Corp.

4475 Golden Foothill Pkwy, El Dorado Hills, CA 95630
 (916) 939-4005 (800) 538-6894 FAX: (916) 939-4114
 Sales Manager: Wayne Graham; Sales Engineer:
 Kirk McConnell
 Camden Marketing, Pierre Fonds, QU 514-683-3377
 PRODUCTS: audio tape diagnostics, hand-held
 instruments

Vertigo Recording Products

12115 Magnolia Blvd., #116, N. Hollywood, CA 91607
 (818) 907-5161
 Camden Marketing, Pierre Fonds, QU 514-683-3377

Vibration Specialty Corp.

100 Gelger Rd, Philadelphia, PA 19115
 (215) 698-0800 FAX: (215) 677-8874
 President: William McGucklin; Field Service
 Manager: Bruce Majer
 Camden Marketing, Pierre Fonds, QU 514-683-3377
 PRODUCTS: data acquisition, dual-channel
 spectrum analyzers, FFT-spectrum analyzers,
 frequency-domain acquisition/analysis, noise &
 vibration analyzers

VIZ Test Equipment

335 E. Price St, Philadelphia, PA 19144
 (215) 844-2626 FAX: (215) 844-4410
 Camden Marketing, Pierre Fonds, QU 514-683-3377

Wavetek San Diego

9045 Balboa Ave., San Diego, CA 92123
 (619) 279-2200 FAX: (619) 565-9558

Westpark Communications

2408 Superior Dr.
 Arlington, TX 76013
 (817) 469-1144

Wiltron

490 Jarvis Drive, Morgan Hill, CA 95037-2809
 (408) 778-2000
 Audio Etc., St. Peters, MO 314-278-4130

Wohler Technologies

1349 Kansas Street, San Francisco, CA 94107
 (415) 285-5462 FAX: (415) 821-6414
 Larry Schirmer, Pontiac, MI 313-340-9588
 PRODUCTS: metering systems

Zonic A & D Co.

25 Whitney Dr, Milford, OH 45150
 (513) 248-1911 FAX: (513) 248-1589
 General Manager: William J. Ashton
 Zonic A & D, Warwick, NY 914-986-8742
 Zonic A & D, Coloma, MI 616-468-4955
 Zonic A & D, Lakeside, CA 619-390-8511
 Zonic A & D, CA 714-723-0640
 Audio Biz, Mundellin, IL 708-949-0280

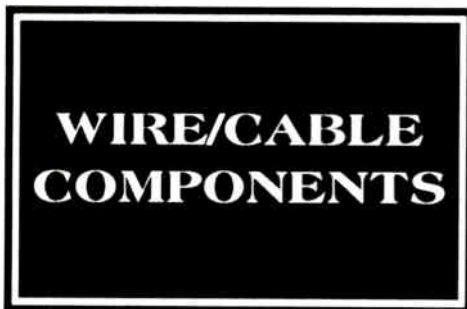
**ADC Telecommunications**

4900 W. 78th St., Minneapolis, MN 55435
 (800) 726-4266
 J.B. Parent, Dublin, OH 614-764-0064
 PRODUCTS: connectors, fiber optics, panels, pre-
 wired systems, telecommunications, video

ALARM ACCESSORY LTD.

P.O. Box 212, Claymont, DE 19703
 (302) 792-3620 (800) 441-7082 FAX: (302) 792-7713
 President: William Holt; Operations Mgr.: Angela
 Bopp
 Sound Sales, Inc., Columbia, MD 301-964-1170
 PRODUCTS: conduits, connectors, raceways,
 switches

All Electronics

6228 Sepulveda Blvd.
 Van Nuys, CA 91408
 (818) 904-0524 FAX: (818) 781-2653

Almetek Industries, Inc.

2 Joy Drive, Hackettstown, NJ 07840
 President: A.A. Burlando; Sales Manager: Ken
 McIsaac; Marketing Manager: Robert Grove
 Almetek Industries Inc., Sacramento, CA
 Doug Warren, Newport News, VA 804-930-3217
 PRODUCTS: markers

AMP Inc.

P.O. Box 3608
 Harrisburg, PA 17105
 (717) 564-0100 (800) 522-6752 FAX: (717) 561-6110
 Audio Etc., St. Peters, MO 314-278-4130

AMP Netcon

P.O. Box 1776
 Southeastern, PA 19482
 (215) 647-1000 FAX: (215) 251-6227

Berk-Tek

132 White Oak Rd.
 New Holland, PA 17557
 (717) 354-6200
 J.B. Parent, Dublin, OH 614-764-0064

Bl-Tronics, Inc.

76 Main Street
 P.O. Box 12, Tuckahoe, NY 10707
 (914) 961-2004 (800) 666-0996 FAX: (914) 961-4244
 President: J. Schwartz; Engineering Sales
 Manager: Ron Huppert; Sales Administrator: C.
 Vlafore
 J.B. Parent, Dublin, OH 614-764-0064
 PRODUCTS: accessories, adapters, alarm, audio,
 computer cable & peripherals, conduits,
 connectors, control, data, fiber optics, hardware,
 hybrids, jacks, low-capacitance, markers, panels,
 plenum cable, plugs, pre-wired systems,
 raceways, security, shielded, sleeving, solid,
 specials, stranded, telecommunications,
 terminals, transformers, tubing, video, XLR
 connectors

BJM Electronics Ltd.

2589 Richmond Terrace
 Staten Island, NY 10303
 (718) 442-0223 FAX: (718) 442-1451
 President: Robert Manzo; Sales Manager: Jeff
 Salitei; Purchasing: Jason Manzo
 Precide, Morbio Inferiore, Switzerland, 914-
 31734
 PRODUCTS: accessories, adapters, alarm, audio,
 computer cable & peripherals, conduits,
 connectors, control, control, data, fuses and
 holders, hardware, jacks, low-capacitance,
 panels, plenum cable, plugs, pre-wired systems,
 raceways, shielded, sleeving, solid, stranded,
 telecommunications, tubing, video, XLR
 connectors

Black Audio Devices

P.O. Box 106
 Ventura, CA 93002
 (805) 653-5557
 President: Bruce Black
 Nova Marketing, San Francisco, CA 415-952-0943
 PRODUCTS: accessories

Brim Electronics

P.O. Box 336 S
 Fair Lawn, NJ 07410
 (201) 796-2886 FAX: (201) 778-2792
 President: B. Danziger; Sales Manager: B. Brown
 G H Assoc., Stow, MA 508-897-3534
 Boerger Assoc., Mpls., MN 612-560-3435
 Mactronix, Phoenix, AZ 602-998-1848
 Roburn Agencies, Yonkers, NY 914-968-1016
 Nova Marketing, San Francisco, CA 415-952-0943
 PRODUCTS: accessories, adapters, alarm, audio,
 computer cable & peripherals, control, data,
 fuses and holders, hardware, jacks, low-
 capacitance, plenum cable, plugs, shielded,
 sleeving, solid, specials, stranded, tubing

Cableready, Inc.

480 E. 76th Ave. 5-A
 Denver, CO 80229
 (303) 288-8107 (800) 222-2142 FAX: (303) 288-4769
 President: Randy Holliday; Vice President of
 Sales: Doug Jensen; Technical Advisor: Kevin
 Bell
 LCA Sales Co, Tuckahoe, NY 212-402-6600
 Ziskind Assoc., Arlington Hgts., IL 708-577-1624
 Roger Ponto Assoc., Kirkland, WA 206-821-2996
 Doug Warren, Newport News, VA 804-930-3217
 PRODUCTS: raceways

Cal Switch

13717 S. Normandie Ave.
 Gardena, CA 90249
 (213) 770-2330 (800) CAL-SWCH FAX: (213) 327-
 2741
 Sales: Gayle Danielson; Sales: Amy Zalewski;
 Sales: Dana DeWayne; Sales: Violet Zavala
 John Anthony, Stamford, CT 203-322-9202
 PRODUCTS: accessories, adapters, audio,
 computer cable & peripherals, connectors, fiber
 optics, fuses and holders, hardware, jacks,
 panels, plenum cable, plugs, shielded, stranded,
 switches, XLR connectors

**Find Your Suppliers in the
 Sound & Communications
 Blue Book**



Canare

511 5th Street #C
San Fernando, CA 91340
(818) 365-2446 FAX: (818) 365-0479
General Manager: Barry Brenner
Edwards Company, Inc., Livonia, MI 313-458-7777
PRODUCTS: audio, connectors, jacks, low-capacitance, panels, plugs, shielded, stranded, telecommunications, video, XLR connectors

Cat Wire and Cable Corp.

1139 NW 72nd St.
Miami, FL 33150
(305) 836-3600 (800) 262-5999 FAX: (305) 835-0974
President: Benjamin L. Nemser
Doug Warren, Newport News, VA 804-930-3217
PRODUCTS: alarm, audio, computer cable & peripherals, control, data, low-capacitance, plenum cable, security, shielded, solid, specials, stranded, telecommunications, video

Champlain Cable

PO Box 7
Winooski, VT 05404
(802) 655-2121 FAX: (802) 655-2025

Cliff Electronics Inc.

9821 Whithorn
Houston, TX 77095
(713) 855-6685 FAX: (713) 855-6684
General Manager: Robert Tupper
Sunrise Sales Company, LaMotte, IL 815-638-2660
PRODUCTS: accessories, connectors, jacks, plugs

Clifford of Vermont, Inc.

Route 107
P.O. Box 51
Bethel, VT 05032
(802) 234-6822 (800) 451-4381 FAX: (802) 234-5006
Product/Sales Manager: Stan Capron
Taub Sales, Silver Springs, MD 301-662-9100

Comm/Scope, Inc.-Network Cable Div.

3642 Hwy. 70 East
P.O. Box 879
Claremont, NC 28610
(704) 459-5000 (800) 982-1708 FAX: (704) 459-5099
Vice Pres. & General Manager: Brian Garrett; Vice Pres. Sales & Mktg.: Joe Teague; Inside Sales Manager: Nita Hunsucker; Product Manager: Richard Hunter; Product Manager: Charile Amann
PreClde, Morbio Inferiore, Switzerland, 914-31734
PRODUCTS: computer cable & peripherals, data, fiber optics, plenum cable, shielded, solid, stranded, telecommunications, video

Conquest Sound, Inc.

26113 S. Ridgeland Ave.
P.O. Box 268, Monee, IL 60449
(708) 534-0390 (800) 323-7671 FAX: (708) 534-0398
President: Bob Jares Jr.; Vice President: Larry Spalla; General Manager: Janet Jares;
Operations Manager: Deborah Hawtree; Sales: Ed Knecht; Sales: Sally Artman
Gary Castelluccio & Assoc., Clifton, NJ 800-888-1899
AMH Sales, Inc., Torrance, CA 213-373-2034
RS Enterprises, Redmond, WA 206-883-1482
Midwest Audio Marketing, Crete, IL 708-672-3056
AMH Sales, Northglenn, CO 303-465-5967
C.L. Pugh & Associates, Cleveland, OH 216-238-1777
PRODUCTS: accessories, adapters, alarm, audio, computer cable & peripherals, conduits, connectors, control, data, fiber optics, fuses and holders, hardware, jacks, low-capacitance, markers, panels, plenum cable, plugs, pre-wired systems, security, shielded, sleeving, solid, specials, stranded, switches, telecommunications, terminals, transformers, tubing, video, XLR connectors

Cooper Industries/Belden Division

P.O. Box 1980, Richmond, IN 47375
(317) 983-5200 (800) BELDEN-1
FAX: (317) 983-5294
President: Nish Tesholan; Director, Domestic Sales: Mike Murphy; Director, Int'l Sales & Mktg: Larrle Rose; Director, Marketing: John Valentine; Mgr., Marketing Comm.: John Hitch; Manager of Marketing: Kathy Lucid
Western Regional Sales Office, Irvine, CA 714-474-1200
North Central Region, Naperville, IL 708-717-7300
South Central Region, Dallas, TX 214-788-4300
Eastern Regional Sales Office, Worcester, MA 508-795-1100
Southeastern Region, Atlanta, GA 404-934-6767
Nova Marketing, San Francisco, CA 415-952-0943

CZ Labs

135 N. Route 9W, P.O. Box 126
Congers, NY 10920
(914) 268-5056 FAX: (914) 268-5350
Vector Corp., Seattle, WA 206-368-8400

Daburn Electronics and Cable Corp.

224 Pegasus Ave.
Northvale, NJ 07647
Edwards Company, Inc., Livonia, MI 313-458-7777

Duncan Electronics

2865 Fairview Rd.
Costa Mesa, CA 92626
(714) 545-8261

Eastman Wire & Cable Company

1085 Busch Highway
Pennsauken, NJ 08110
(609) 488-8800 (800) 257-7940 FAX: (609) 488-8899
President: Jack Leporati; Vice President: Chris Leporati; National Sales Manager: Mike McQuade; Controller: Dan Crimmlie
Associated Power Prod., Norwood, MA 617-769-7516
Chenault & Associates, Dallas, TX 214-320-3323
Fortl Associates, Kengington, MD 301-949-1706
Interstate Electronics, Redmond, WA 206-885-5257
Jeff Nill & Associates, Elma, NY 716-652-3110
Greg Dzubay & Assoc., Glendale, AZ 800-999-0006
PRODUCTS: alarm, audio, data, security, shielded, specials, stranded, telecommunications

EVG

1 Lee Pl.
Freeport, NY 11520
(516) 536-5000 FAX: (516) 764-5747

Fiber Options

80 Orville Drive, Ste. 102
Bohemia, NY 11716
(516) 567-8320 (800) 342-3748 FAX: (516) 567-8322
CEO: Bob De Lia; Vice President: Clyde Smith;
Vice President: Jack Fitzsimmons; Sales Manager: Rita Edrich
F.M. Valenti, Nahant, MA 617-592-5300
Thaw Sales & Marketing, So. Plainfield, NJ 201-757-8150
Intermountain Marketing, Castle Rock, CO 303-688-5507
Marketing Specialists, Simi Valley, CA 805-582-0666
Universal Technologies S.A., Waure, Belgium, 321-0-242520
PRODUCTS: fiber optics

General Instrument Network Cable

P.O. Box 1729
Hickory, NC 28602
(704) 324-2200 FAX: (704) 459-5099

GEPCO INTERNATIONAL INC.

2225 West Hubbard
Chicago, IL 60612
(312) 733-9555 (800) 966-0069 FAX: (312) 733-6416
President: Gary R. Geppert; Chief Financial Officer: David B. Mecklenburger; Assistant to the President: Larry Smith, Sr.; Sales Manager: Larry Smith, Jr.
Gepco International Inc., Ocala, FL 904-368-1032
John Anthony, Stamford, CT 203-322-9202
PRODUCTS: accessories, adapters, alarm, audio, computer cable & peripherals, connectors, control, data, fiber optics, jacks, low-capacitance, markers, panels, plenum cable, plugs, pre-wired systems, raceways, security, shielded

GNWC Wire, Cable & Network Products

1401 Brook Drive
Downers Grove, IL 60515
(708) 627-1777 (800) 232-4692 FAX: (708) 932-4342
CEO: Thomas Katsoullis; President: James Dellaripa; Vice President: David Bemoras
GNWC, Richardson, TX 214-680-9831
GNWC, Denver, CO 303-922-0038
GNWC, Norcross, GA 404-441-2231
GNWC, Phoenix, AZ 602-470-0055
Greg Dzubay & Assoc., Glendale, AZ 800-999-0006

Hamilton Standard Controls

131 Godfrey St.
Logansport, IN 46947
(219) 722-2244

Ideal Wire Products Inc.

Lorum St.
Tewksbury, MA 01876
(508) 851-4541 (800) 762-7668
President: Robert T. Leahy
ADCOM, Toronto, ON 416-251-3355
PRODUCTS: security, shielded, stranded, telecommunications

International Components Corp.

105 Maxess Road
Melville, NY 11747
(516) 293-1500 (800) 645-9154 FAX: (516) 293-4983
President: Mort Grossman; Executive Vice President: Irwin Friedman; Vice President: Fred Grossman; Eastern Regional Sales Mgr.: Ken Reed; Vice President: Harvey Grossman
C.B. Electronic Marketing, Arvada, CO 303-422-0561
PRODUCTS: accessories, adapters, alarm, connectors, jacks, plugs

**Subscribe to
Sound & Communications
Magazine**

International Elec. Wire & Cable Co

89 1/2 O'Leary Drive, Bensenville, IL 60106
(708) 860-2210 (800) 323-0210 FAX: (708) 860-0305
President: Dale Hellenbach; Sales Manager:
Kevin McClure; Controller: Barbara Roguszczyk
Design Factors, La Habra Hgts., CA 213-697-7576
Pacnor Marketing, Lynwood, WA 206-771-6016
Repworks, Chicopee, MA 413-533-0845
Weller Sales, Worthington, OH 614-885-7819
BC Electronic Sales, Shawnee, KS 913-962-1990
ADCOM, Toronto, ON 416-251-3355

International Electronic Wire & Cable

520 Business Center Drive, Mount Prospect, IL 60056
(708) 299-0021 (800) 323-0210 FAX: (708) 298-8433
President: Dale Hellenbach; National Sales
Manager: Kevin McClure
C.B. Electronic Marketing, Arvada, CO 303-422-0561

ITT Pomona Electronics

1500 E. Ninth St.
P.O. Box 2767, Pomona, CA 91769
(714) 623-3463 (800) 488-7666 FAX: (714) 629-3317
General Manager: Thomas Barber; Marketing
Manager: Art Brostrand; Engineering Director:
Ken Baldwin; Controller: Brian Olmsted
Vale Electric Associates, Irvine, CA 714-551-4004
Darco Distributor Sales, Burbank, CA 818-504-2425
Engineering Associates, Santa Clara, CA
408-988-5001
David S. Linz Inc., Philadelphia, PA 215-379-0734
William M. Linz Associates, Palatine, IL
708-705-8555

J.W. DAVIS AND CO.

3030 Canton Street, Dallas, TX 75226
(214) 651-7341 (800) 527-5705 FAX: (214) 939-0328
President: Harvey Earp; Vice President, Sales:
Jack W. Tucker; Chief Engineer: Eric Simonson
Multi-Technical Reps., Brainerd, MN 218-828-9483
PRODUCTS: audio, plenum cable

JSC Wire & Cable

Burgess Place
Wayne, NJ 07474
(201) 694-6200 (800) 572-9473 FAX: (201) 694-8297
National Sales Manager: Richard Wojtowitz;
President: R.D. Foster; Purchasing/QC Manager:
Frank Moitane; Plant Manager: Charles Mampe
Doug Warren, Newport News, VA 804-930-3217

Kable King

PO BOX 2646
Savannah, GA 31402
(912) 233-8959

King Wire & Cable

179-45 110th Ave.
Jamaica, NY 11433
(718) 657-4422 FAX: (718) 739-7138

Kulka-Smith

1913 Atlantic Ave.
Manasquan, NJ 08736
(201) 233-9400 FAX: (201) 223-8788

LEE DAN COMMUNICATIONS, INC.

155 Adams Avenue
Hauppauge, NY 11788-3699
(516) 231-1414 (800) 533-3261 FAX: (516) 231-1498
President: Leon Goldberg; Vice President
Operations: Lawrence J. Goldberg; V.P. Finance &
Administration: David H. Goldberg; Senior
Technician: Sanford Hoffman; Office Manager:
Rita Kaplan; Sr. Sales/Service Associate: Susan
Leon
C.L. Pugh & Associates, Cleveland, OH 216-238-1777
PRODUCTS: alarm, audio, security, shielded,
solid, stranded, telecommunications, video

Lemo USA, Inc.

P.O. Box 11488, Santa Rosa, CA 95406
(707) 578-8811 (800) 444-5366 FAX: (707) 578-0869
General Manager: Sam Sokolik; Adv. Supervisor:
Karen Beehler; Customer Service Supervisor:
Debra Ward; Controller: Cheryl Powers;
Engineering Manager: Bill Lee; Cable Assembly
Manager: John Connolly
Audio Etc., St. Peters, MO 314-278-4130
PRODUCTS: accessories, connectors, plugs

Marletta Wire & Cable

463 Commerce Pk Dr.
Marletta, CA 30067
(404) 422-5708
Camden Marketing, Pierre Fonds, QU 514-683-
3377

Marshall Electronics Inc.

5649 Mesmer Avenue
P.O. Box 2027, Culver City, CA 90230
(213) 390-6608 FAX: (213) 391-8926
Vice President: Leonard Marshall
Bi-Tronics, Tuckahoe, NY 800-666-0996
Evans Sales & Marketing, Nashville, TN 615-297-7997
Northshore Marketing, Seattle, WA 206-284-9699
Audio Etc., St. Peters, MO 314-278-4130

Math Associates, Inc.

2200 Shames Drive, Westbury, NY 11590
(516) 334-6800 FAX: (516) 334-6473
President: Ellen Math; Chairman of Board/Tech.
Dir.: Irwin Math; Vice President: Martin Rein;
Director of Mktg. and Sales: James Treuhart
Sel-Tronics, Inc. - Gary Brown, Landover, MD
301-341-2700
Light Brigade - Larry Johnson, Renton, WA
206-277-1240
Al Barshop, Inc., Davie, FL 305-680-8366
Seevid, Inc., Huntington Beach, CA 714-898-6100
Crockett Sales Co., Dallas, TX 214-250-3377
Jim Burger, Philadelphia, PA 203-297-7160
PRODUCTS: fiber optics

Medisco, Inc.

8788 Robbins Road
P.O. Box 40806, Indianapolis, IN 46240
(317) 872-8877 (800) 872-8862 FAX: (317) 876-2384
President: Tony Monfort; Sales: David Utterback
Audio Etc., St. Peters, MO 314-278-4130

Meridian Technologies, Inc.

80 Mott Avenue
Inwood, NY 11696
(516) 371-9300 FAX: (516) 371-9301
President: Robert Klein; Director of
Engineering: Jack Krol
Doug Warren, Newport News, VA 804-930-3217
PRODUCTS: accessories, audio, connectors,
control, data, fiber optics, security, video

Microtran Company

145 E. Mineola Ave.
Box 236
Valley Stream, NY 11582-0236
(516) 561-6050 FAX: (516) 561-1117
President: Albert J. Eisenberg; Vice President,
Sales: Walter Benscher; Chief Engineer: Vulf
Ozechov
Kottmeier Assoc., San Jose, CA 408-371-8700
Universal Components, Torrance, CA 213-783-
0220
CS Technical Sales, Wheaton, IL 708-653-8126
Newscott Co., Wellesley, MA 617-235-6868
Ed Glass Assoc., Englewood Clfs., NJ 201-592-0200
Camden Marketing, Pierre Fonds, QU 514-683-3377
PRODUCTS: transformers

Middle Atlantic Products

8 North Corporate Dr.
P.O. Box 29
Riverdale, NJ 07457
(201) 839-1011 FAX: (201) 839-1976
President: Bob Schluter; National Sales Mgr.:
Eric Demarest; National Director Operations:
Scott Mathews; Office Manager: Rosemarie
Curti; West Coast Operations Mgr.: Sean Freida
Middle Atlantic Rack Distr., Haskell, NJ 201-839-2714
Middle Atlantic Western Distr., Moorepark, CA
805-529-6104
Audio Etc., St. Peters, MO 314-278-4130
PRODUCTS: panels

National Electric Cable

1730 Elmhurst Rd.
Elk Grove Villa, IL 60007
(708) 593-8100
Camden Marketing, Pierre Fonds, QU 514-683-
3377

Nemal Electronics International Inc

12240 NE 14th Ave
N. Miami, FL 33161
(305) 899-0900 (800) 522-2253 FAX: (305) 895-8178
President: Benjamin Nemser; Sales Admin.:
Hilda Manten
Jim Burger, Philadelphia, PA 203-297-7160

Neutrik USA, Inc.

195-s3 Lehigh Ave.
Lakewood, NJ 08701
(908) 901-9488 FAX: (908) 901-9608
General Manager: James E. Cowan; Product
Manager: Kenneth W. Smalley; Product
Manager: William J. Dorman
Dimension/ Point IX, Lewisville, TX 214-436-3706
PRODUCTS: audio, connectors

Noramco Wire & Cable

4185 Dawson St.
Burnaby, BC V5C 4B3
(604) 298-2240 FAX: (604) 298-9115
Vice President & C.O.O.: Gary J. MacNeil; VP
Finance & Administration: Chris M. Bond; Senior
Vice President: Bob A. Pickard; Marketing
Manager: Ken R. Brown
Noramco Wire & Cable, Burnaby, BC 604-298-2133
Noramco Wire & Cable, Edmonton, AL 403-468-
5678
Noramco Wire & Cable, Calgary, AL 403-291-2955
Noramco Wire & Cable, Toronto, ON 416-238-8180
Noramco Wire & Cable, Montreal, QU 514-744-
8180
Dimension/ Point IX, Lewisville, TX 214-436-3706

North Hills Electronics

1 Alexander Place
Glen Cove, NY 11542
(516) 671-5700 FAX: (516) 793-3327
Product Manager: Joe Barbuto
Rayma, Laurel, MD 800-447-2962
Milestek, Argyle, TX 800-683-7444
Jim Burger, Philadelphia, PA 203-297-7160

Oiflex Wire & Cable

30 Plymouth St., Fairfield, NJ 07006
(201) 575-1101 (800) 225-1336 FAX: (201) 575-7178
Executive Vice President: John P. Ciccone;
Director of Marketing: Pete Duschner; Sales
Administration Manager: Harry J. Pizutelli
Camden Marketing, Pierre Fonds, QU 514-683-3377
PRODUCTS: accessories, audio, computer cable &
peripherals, control, low-capacitance, shielded,
stranded

NICE-DUC[®]

SELF-ADHESIVE WIRING DUCT

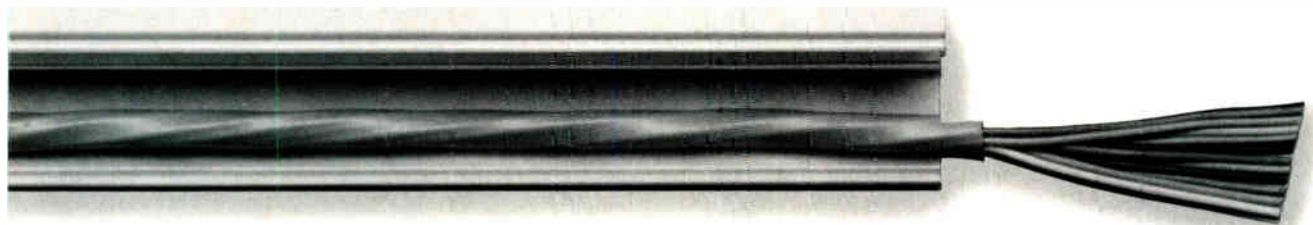

NEW Easy wire load design.
Hinged side opens and closes
for fast installation.



Same low profile good looks.
Versatile size.
Five decorator colors.



Premium 3M[®] acrylic
adhesive. Maximum long-term
sticking power.

Count the features.
Nothing looks nicer than NICE-DUC[®].



ALARM ACCESSORY LTD. • WILMINGTON, DE • (800) 441-7082

Circle 220 on Reader Response Card

World Radio History



Paige Electric Corp.

1071 Hudson St., Union, NJ 07083
(908) 687-7810 (800) 327-2443 FAX: (908) 687-8860
President: Lou Grotta; Vice President: Henry J. Coffey; Vice President: Orlando DiRienzo
Norman Hagemann, Batavia, IL
Precide, Morbio Inferiore, Switzerland, 914-31734

Pandult Corp.

17301 Ridgeland Ave, Tinley Park, IL 60477
(708) 532-1811 (800) 777-3300 FAX: (708) 532-1811
Camden Marketing, Pierre Fonds, QU 514-683-3377

PEAVEY ELECTRONICS CORP.

711 A Street
P.O. Box 2898, Meridian, MS 39301
(601) 483-5365 FAX: (601) 484-4278
CEO: Hartley Peavey; President: Mella Peavey
Dimension/ Point IX, Lewisville, TX 214-436-3706
PRODUCTS: accessories, adapters, alarm, audio,
computer cable & peripherals, conduits,
connectors, control, data, shielded, sleeving, solid,
specials, stranded, switches, XLR connectors



PAIGE ELECTRIC CORP.

**3 IN 1 FLEXIBLE
EASY STRIP CABLE FROM STOCK
MP (NON-PLENUM)
MPP (PLENUM) / MPR (RISER)
THE ONE CABLE LISTED AND
PERMITTED BY UL FOR USE AS**

- 1 - ARTICLE 725 CL2/CL2P/CL2R
CL3/CL3P/CL3R
- 2 - ARTICLE 760 FPL/FPLP/FPLR
- 3 - ARTICLE 800 CM/CMP/CMR

CALL THE CABLE EXPERTS
TO FILL YOUR DEMANDING REQUIREMENTS

908-687-7810, 800-327-2443
Fax: 908-687-8860

1071 Hudson Street, P.O. Box 368
Union, NJ 07083-6809

Circle 288 on Reader Response Card

Power Technologies

7400 E. Slauson Ave., Los Angeles, CA 90040
(213) 728-1371 (800) 866-9728 FAX: (213) 721-9207
General Manager: Carl Tom; Sales Administrator:
Jan Barkee; Sales Administrator: Aneta McLeod
Precide, Morbio Inferiore, Switzerland, 914-31734

Preh Electronic Industries, Inc.

470 E. Main St., Lake Zurich, IL 60047
(708) 438-4000 FAX: (708) 438-5522
President: Marcel Didier; Sales Manager (C): R.
VanOrden; Sales Manager (E): Pat Jones; Sales
Manager (W): E. Helme
Camden Marketing, Pierre Fonds, QU 514-683-3377
PRODUCTS: connectors, switches

Promark Electronics Inc.

3524 Griffith Street, St. Laurent, QC H4T 1A7
(514) 733-5344 FAX: (514) 733-6236
President: Syd Knecht; Vice President: Sol
Fleisling
Promark Electronics, Toronto, ON 416-332-1145
Promark Electronics, Vancouver, BC 604-681-9850
Dimension/ Point IX, Lewisville, TX 214-436-3706

Proto-Tec

108 Fairlane Dr., Joliet, IL 60435
(815) 744-7173
Dimension/ Point IX, Lewisville, TX 214-436-3706

Raychem Corp.

300 Constitution Drive, Menlo Park, CA
(415) 361-3333 FAX: (415) 361-5447

Remeo Products Corporation

186 North Main Street, Florida, NY 12771
(914) 651-4431 (800) 431-3864 FAX: (914) 651-4160
President: Al Muhrad; V.P. Sales and Marketing:
Ken Pimental; Controller: Julia Sullivan; V.P.
Plant Operations: Ray Conlin; Nat'l Sls. Mgr.
Fiber Optics: Mary Galbraith
Sunrise Sales Company, LaMolle, IL 815-638-2660

Resco, Inc.

366 Washington Street
P.O. Box 2244, Newburgh, NY 12550
(914) 565-7570 (800) 431-9473 FAX: (914) 565-7878
President: Stephen Roth; Vice President:
Leonard Ellentuch
Karp Communications, Tampa, FL 813-968-7098
PRODUCTS: accessories, adapters, alarm, audio,
computer cable & peripherals, conduits,
connectors, control, data, fiber optics, hardware,
jacks, plenum cable, plugs, pre-wired systems,
raceways, security, shielded, sleeving

REVERE INDUSTRIES

1101 Bienville St., New Orleans, LA 70112
(504) 523-3503 (800) 843-8321 FAX: (504) 525-6361
Vice President Mktg./Sales: Richard Harris
Camden Marketing, Pierre Fonds, QU 514-683-3377
PRODUCTS: accessories, adapters, alarm, audio,
computer cable & peripherals, conduits,
connectors, control, data, fiber optics, fuses and
holders, hardware, hybrids, jacks, markers,
panels, plugs, pre-wired systems, security,
shielded, sleeving, solid, specials, stranded,
switches, telecommunications, terminals,
transformers, tubing, video, XLR connectors

RMS Electronics Inc.

621 Route 46, Hasbrouck Hts., NJ 07604
(201) 288-8833 FAX: (201) 288-1625
Sunrise Sales Company, LaMolle, IL 815-638-2660

Seam-Tech

P.O. Box 77394, San Francisco, CA 94107
(415) 543-0170 FAX: (415) 777-9868
Owner: Michael Paul Fennell
Sound Sales, Inc., Columbia, MD 301-964-1170
PRODUCTS: accessories

Shogyo International Corp.

287 Northern Boulevard
Great Neck, NY 11021
(516) 466-0911 FAX: (516) 466-0922
President: Mark A. Rubin; Vice President:
Howard Rubin
Karp Communications, Tampa, FL 813-968-7098
PRODUCTS: accessories, adapters, alarm, audio,
computer cable & peripherals, connectors, fuses
and holders, jacks, plugs, shielded, specials,
switches, telecommunications, terminals,
transformers

Signal Cable Company

2500 Commonwealth
N. Chicago, IL 60064
(708) 689-9090 (800) 323-9355 FAX: (708) 689-1192
V.P. General Manager: Kerry Glicker; General
Sales Manager: Steven Vivacue; Customer
Service: Ray Deeter; Customer Service: Lynn
Pack
Cambridge Marketing, Westerville, OH 614-363-9191
PRODUCTS: alarm, computer cable & peripherals,
control, plenum cable, security, shielded, solid,
specials, stranded, telecommunications, video

SoilCo/mec

75 Locust Street, Hartford, CT 06114
(203) 527-3092 FAX: (203) 527-6047
Director of Marketing: Larry Rutherford; Sales
Engineer: Jackie Saunders
Wes-Garde Components Group, Hartford, CT
203-527-7705
Wes-Garde Components Group, Lakeland, FL
813-644-7564
Wes-Garde Components Group, Van Nuys, CA
818-786-3724
Wes-Garde Components Group, Dallas, TX
214-357-1768
Wes-Garde Components Group, Carol Stream, IL
708-653-1460
Cambridge Marketing, Westerville, OH 614-363-9191
PRODUCTS: switches

SONANCE

961 Calle Negocio
San Clemente, CA 92672
(714) 492-7777 (800) 582-7777 FAX: (714) 361-2705
President: Scott Struthers; Vice President:
Geoff Spencer; Sales Manager: Dave Donald;
International Sales Manager: Mark Cichowski;
Public Relations Director: Mitch Simon; Dir. Sls
Trn. & Mkt. Research: Kevin Leja
Morris Tait and Assoc., Los Angeles, CA
213-877-4424
Bach Sales, New York, NY 212-727-0404
Tandem Marketing, Chicago, IL 708-605-1960
Dobbs Stanford, Dallas, TX 214-358-0800
Balaton Marketing, Washington DC,
202-471-1764
MJA Marketing, St. Charles, MO 314-447-7111
PRODUCTS: accessories, audio, connectors, jacks,
video

Sound Quest

2600 Commonwealth
P.O. Box 940, North Chicago, IL 60064
(708) 473-1200 (800) 457-4579 FAX: (708) 473-2436
President: Jay Lovett; Operations Mgr./ Sales
Mgr.: Jack Geary; Controller: Mike Lundy;
Product Specialist: Eric Kernodle
Lark & Associates, New York, NY 914-353-0180
Pro Marketing, Chicago, IL 708-887-1866
dB South, Atlanta, GA 404-474-4020
Candoza & Co., Pleasanton, CA 415-484-8444
Apex Performance Marketing, Redondo Beach,
CA 213-376-5560
Karp Communications, Tampa, FL 813-968-7098

Soundstream Technologies

120 Blue Ravine Road
Folsom, CA 95630
(916) 351-1288 FAX: (916) 351-0414
President: Donna Haas; Managing Director: Lee Adams; Director of Engineering: Wade Stewart; Ntl. Sales Mgr., Home Audio: Scott McAllister; Sales Engineer, Home Audio: Andrew Murray
John W. Steinberg Company, Encino, CA 818-705-7772
Moskau & Associates, Dallas, TX 214-821-4280
Creative Marketing Associates, Nashville, TN 615-831-9690
On Line Marketing, Wadsworth, OH 216-336-7504
Sound Marketing, Palos Hills, IL 708-598-6888
Cambridge Marketing, Westerville, OH 614-363-9191
PRODUCTS: accessories, adapters, audio, fuses and holders, low-capacitance, plenum cable, shielded, video

Stancor Div. White-Rodgers

131 Godfrey St.
Logansport, IN 46947
(219) 753-7521 FAX: (219) 722-5189
Technical Service Manager: Richard Noel;
Product Manager: Stephanie Starbuck
Camden Marketing, Pierre Fonds, QU 514-683-3377
PRODUCTS: transformers

Standard Wire & Cable Co.

1959 East Cashdan St.
Rancho Dominguez, CA 90220
(213) 609-1811 (800) 326-0006 FAX: (213) 609-1862
President: Russ Skrabie; Vice President

Operations: Jerry Gaither; Regional Sales Manager: Dan Varvals; International Sales Mgr.: Jim Bonnet; National Sales Support Mgr.: Bob Wilson; Controller: Joyce Lambdin
Standard Wire & Cable Co., Phoenix, AZ 602-269-2501
Standard Wire & Cable Co., Concord, CA 415-674-0138
Standard Wire & Cable Co., San Diego, CA 619-281-4397
Sound Sales, Inc., Columbia, MD 301-964-1170
PRODUCTS: computer cable & peripherals, conduits, control, data, fiber optics, plenum cable, pre-wired systems, raceways, security, shielded, solid, specials, stranded

Switchcraft, Inc. Components Div.

5555 N. Elston Ave., Chicago, IL 60630
(312) 792-2700 FAX: (312) 792-2129
Vice Pres./General Manager: Keith A. Bandolik;
Dir. Marketing and Sales: William M. Pagett; Dir. Engineering: Tim O'Meara; Mgr. Marketing Comm.: Herbert C. Klapp
Sunrise Sales Company, LaMotte, IL 815-638-2660
PRODUCTS: accessories, adapters, audio, computer cable & peripherals, connectors, jacks, panels, plugs, XLR connectors

Tag-It Division, Peter Mangone, Inc.

12687 W. Cedar Dr. #100, Lakewood, CO 80228
(303) 986-5447 (800) 338-2448 FAX: (303) 989-1207
Sales Associate: Millie Stekete
JMS Marketing, Austin, TX 512-266-1113

Tappan Wire & Cable

256 Oak Tree Rd.
Tappan, NY 10983
(914) 359-9300 (800) 247-9099 FAX: (914) 359-9369
President: Sidney Grant; Vice President: Michael Ressa; Inside Sales Manager: Darren Krych;
Inside Sales: Dianna Lopez
JMS Marketing, Austin, TX 512-266-1113

TEI Electronics Inc.

570 W. 18 St.
P.O. Box 246
Hialeah, FL 33011
(305) 888-3980 (800) 327-8811 FAX: (305) 885-4950
President: Danny Alonso; Vice President: Mireya A. Muniz; National Sales Manager: Walter McNulty; Customer Service: John Tembras;
Sales: Orlando Pineda; Sales: Jose Hurcades
Audio Biz, Mundell, IL 708-949-0280
PRODUCTS: accessories, adapters, alarm, audio, connectors, fuses and holders, jacks, plugs, switches, telecommunications, terminals, video, XLR connectors

Teledyne Thermatics

P.O. Box 909
Elm City, NC 27822
(919) 236-4311 FAX: (919) 236-3613
President: Roy Inscore; Vice President of Technology: Bill Strickland; Vice President, Engineering: Bruce Pike; Vice President of Mfg.: Lawson Maddox; Marketing Manager: Carole A. Mulkey; Product Manager: Jay Morris
Ed Howell, Whittier, CA 213-945-1581
Paul Caruso, Branford, CT 203-483-9030

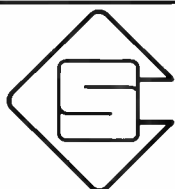

CAL SWITCH

CALIFORNIA SWITCH & SIGNAL, INC.

Makes Buying Easier

With

Switchcraft®

A Raytheon Company

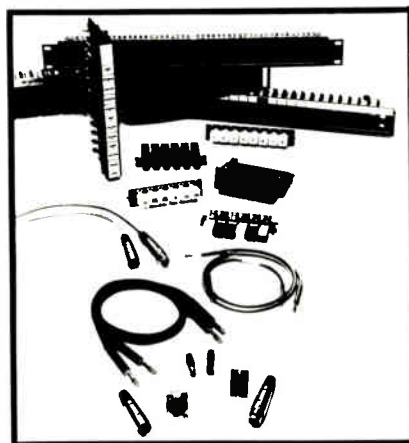

Adapters
Connectors
Jack Panels
Jacks
Plugs
Switches

** We Stock The Complete
Switchcraft Line **

We Offer
Fast Delivery
Custom Assembly
Custom Engraving
Custom Modification

Call (800) CAL-SWCH Today !

13717 South Normandie Avenue · Gardena, California 90249 · (213) 538-9830 · FAX: (213) 327-2741

Circle 251 on Reader Response Card

WHICH SYSTEM ARE YOU INSTALLING?

WEST PENN WIRE COVERS ALL YOUR ELECTRONIC CABLE NEEDS



No matter what system you are installing, you can count on West Penn Wire to offer you a complete selection of the low voltage electronic cable that best meets all of your requirements. And we back everything we sell with the dependable quality, outstanding service, competitive pricing and complete engineering and technical assistance that you expect from an industry leader like West Penn Wire.

Make sure your cable needs are covered by the best. To place your order or for more information call

800-245-4964

(in PA call 800-222-8883) or write West Penn Wire, P.O. Box 762, 2833 West Chestnut Street, Washington, PA 15301.

	SOUND REINFORCEMENT <ul style="list-style-type: none"> • Public Address • Background Music • Paging 			PREMISES PROTECTION <ul style="list-style-type: none"> • Video Surveillance • Card Access • Perimeter Access 	
	FIRE ALARM SYSTEMS <ul style="list-style-type: none"> • Single Zone/Multi Zone • Multiplex Monitor & Control 			HEALTH CARE <ul style="list-style-type: none"> • Nurse Call • MATV • Paging Intercom 	
	SCHOOL COMMUNICATIONS <ul style="list-style-type: none"> • PA/Intercom • Internal/External Telephones • Classroom Computer Linkage 			CONFERENCE/MEETING ROOM AV AIDS <ul style="list-style-type: none"> • Video Projection • Conference Room Systems • Wireless Microphone Systems 	
	TELECOMMUNICATIONS <ul style="list-style-type: none"> • Voice/Data Communications • Key/PBX Systems • Voice Processing Systems 			CORRECTIONAL FACILITIES <ul style="list-style-type: none"> • Courtroom AV Systems • Video/Audio Surveillance • Security Intercom/Paging 	
	TELEVISION SYSTEMS <ul style="list-style-type: none"> • CCTV • CATV/MATV • Satellite Up-Link/Down-Link 			DATA TRANSMISSION <ul style="list-style-type: none"> • LAN • Coaxial Distribution • Remote Data Retrieval 	
	CHURCH & RELIGIOUS <ul style="list-style-type: none"> • Computer Designed P.A. • Multi Purpose Room P.A. • CCTV/Recording 			FIBER OPTICS <ul style="list-style-type: none"> • Communications • Data Transmission • Process Control 	

WPW
WEST PENN WIRE
NOT EQUAL...BUT BETTER.



Circle 231 on Reader Response Card

Teledyne Thermatics

P.O. Box 909, Elm City, NC 27822
 (919) 236-4311 FAX: (919) 236-3613
 President: Roy Inscore; Vice President of
 Technology: Bill Strickland; Vice President,
 Engineering: Bruce Pike; Vice President of Mfg.:
 Lawson Maddox; Marketing Manager: Carrole A.
 Mulkey; Product Manager: Jay Morris
 Ed Howell, Whittier, CA 213-945-1581
 Paul Caruso, Branford, CT 203-483-9030
 Ben Jeffery, Lilburn, GA 404-923-4197
 Joe Sullivan, Batavia, IL 708-406-9776
 Mike Cannon, Wilson, NC 919-237-9473
 JMS Marketing, Austin, TX 512-266-1113
 PRODUCTS: alarm, audio, plenum cable, security,
 shielded, solid, specials, stranded,
 telecommunications

TeleMatic

108-02 Otis Ave., Corona, NY 11368
 (718) 271-5200 FAX: (718) 271-5738
 President: Ben Frankenstein
 Camden Marketing, Pierre Fonds, QU 514-683-3377
 PRODUCTS: specials

TMB ASSOC.

3416 W. Burbank Blvd., Burbank, CA 91505
 (818) 842-9652 FAX: (818) 842-1064
 Camden Marketing, Pierre Fonds, QU 514-683-3377

Trompeter Electronics

31186 La Baya Dr.
 P.O. Box 5069, Westlake Vlg., CA 91362-4047
 (818) 707-2020 FAX: (818) 706-1040
 Vice President, Sales & Mktg: Ray Calvin;
 Advertising: Ray Uwate
 L & M Associates, Elmwood Park, NJ 201-797-0441
 Knight Company, Los Angeles, CA 213-670-2833
 Currie, Peak & Frazier, Orlando, FL 407-855-0843
 Interconnect Sales Group, Santa Clara, CA 408-
 980-1166
 Sectronics, Landover, MD 301-341-2700
 Camden Marketing, Pierre Fonds, QU 514-683-3377
 PRODUCTS: accessories, adapters, audio,
 connectors, jacks, panels, plenum cable, plugs,
 shielded, solid, stranded, telecommunications,
 video

Trouper Industries, Ltd.

20960 Brant Avenue
 Carson, CA 90810
 (213) 639-8281 FAX: (213) 639-8284
 President: Andrew Martin; Vice President:
 Cynthia Claypool
 Sound Sales, Inc., Columbia, MD 301-964-1170
 PRODUCTS: accessories

USD Products

7300 W. Wilson
 Chicago, IL 60656
 (708) 867-4600 FAX: (708) 867-2211
 General Manager: H. Ray Ege; National Sales
 Manager: Christopher Osmun; Marketing
 Manager: John E. Grimm; Customer Service
 Supv.: Pamela Masiana; Engineering Manager:
 Larry Happ
 Western Automation, Laguna Hills, CA 714-859-
 6988
 Tech-tron Sales, Schaumburg, IL 708-843-7530
 CFE/Gray Associates, Kenil, NJ 201-927-6662
 Marty Flynn Associates, Chelmsford, MA
 508-649-3086
 O'Donnell Assoc. North, San Jose, CA 408-432-1940
 T.C. Marketing, Reseda, CA 818-776-8120
 PRODUCTS: connectors, fuses and holders,
 plugs, terminals

Wesflex

1880 Garden Tract Rd., Richmond, CA 94801
 (415) 233-6670

**WEST PENN WIRE CORP.**

2833 W. Chestnut Street
 P.O. Box 762
 Washington, PA 15301
 (412) 222-7060 (800) 245-4964 FAX: (412) 222-6420
 Exec. Vice Pres. Marketing: Donald J. Hastings;
 Vice President Sales: Louis V. Valente; Regional
 Sales Manager: Daniel J. Hastings; Regional Sales
 Manager: Richard Tovornik; Regional Sales
 Manager: Robert Bruno
 Jim Miles, Dallas, TX
 Allen McAllister, Chino, CA
 MJA Marketing, St. Charles, MO 314-447-7111
 PRODUCTS: fiber optics, low-capacitance,
 plenum cable, security, shielded, stranded, video

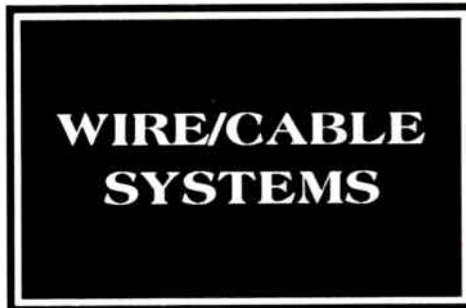
**ADC Telecommunications**

4900 W. 78th St.
 Minneapolis, MN 55435 (800) 726-4266
 J.B. Parent, Dublin, OH 614-764-0064
 PRODUCTS: fiber optics, snakes, fiber optic,
 video

Alpha Wire Corp.

711 Lidgerwood Ave.
 Elizabeth, NJ 07207
 (908) 925-8000 (800) 52ALPHA FAX: (908) 925-
 7429
 President: Grant McLennan; CEO: Phillip R.
 Cowen; Vice President Sales: Linda Smith; Vice
 President Marketing: Larry Myers
 J.B. Parent, Dublin, OH 614-764-0064

Atlas Wire & Cable

133 S. Van Norman Rd.
 Montebello, CA 90640
 (213) 723-2401
 J.B. Parent, Dublin, OH 614-764-0064

AUDIO-TECHNICA U.S., INC.

1221 Commerce Drive
 Stow, OH 44224
 (216) 686-2600 FAX: (216) 688-0719
 Vice President, Marketing: Ken Reichel; National
 Marketing Manager: Earl "Buzz" Goodwin;
 National Sales Manager: Garry Elliott; Inside
 Sales: Tony O'Keefe; Sales Coordinator: Kim
 Wallace
 Nova Marketing, San Francisco, CA 415-952-0943
 PRODUCTS: audio, microphone cable snakes,
 MIDI, speaker

Bi-Tronics, Inc.

76 Main Street, P.O. Box 125, Tuckahoe, NY 10707
 (914) 961-2004 (800) 666-0996 FAX: (914) 961-4244
 President: J. Schwartz; Engineering Sales
 Manager: Ron Huppert; Sales Administrator: C.
 Vlafore
 J.B. Parent, Dublin, OH 614-764-0064
 PRODUCTS: audio, cable reels, custom, data,
 fiber optics, instrument, microphone cable
 snakes, MIDI, multi-pair, multi-pin disconnect,
 panels, snakes, digital, snakes, fiber optic,
 speaker, splitting, stageboxes, video

BJM Electronics Ltd.

2589 Richmond Terrace, Staten Island, NY 10303
 (718) 442-0223 FAX: (718) 442-1451
 President: Robert Manzo; Sales Manager: Jeff
 Salitel; Purchasing: Jason Manzo
 Preclde, Morbio Inferiore, Switzerland, 914-31734
 PRODUCTS: audio, cable reels, data, instrument,
 microphone cable snakes, multi-pair, panels,
 splitting, stageboxes, video

Black Audio Devices

P.O. Box 106, Ventura, CA 93002
 (805) 653-5557
 President: Bruce Black
 Nova Marketing, San Francisco, CA 415-952-0943
 PRODUCTS: audio

Brim Electronics

P.O. Box 336 S, Fair Lawn, NJ 07410
 (201) 796-2886 FAX: (201) 778-2792
 President: B. Danzinger; Sales Manager: B. Brown
 G H Assoc., Stow, MA 508-897-3534
 Boerger Assoc., Mpls., MN 612-560-3435
 Mactronix, Pheonix, AZ 602-998-1848
 Roburn Agencies, Yonkers, NY 914-968-1016
 Nova Marketing, San Francisco, CA 415-952-0943
 PRODUCTS: audio, custom, data, microphone
 cable snakes, multi-pair, speaker

Cabletronix

366 Washington St., Newburgh, NY 12550
 (914) 565-7570 FAX: (914) 564-5332

**Canare**

511 5th Street #G
 San Fernando, CA 91340
 (818) 365-2446 FAX: (818) 365-0479
 General Manager: Barry Brenner
 Edwards Company, Inc., Livonia, MI 313-458-7777
 PRODUCTS: audio, cable reels, instrument,
 microphone cable snakes, multi-pair, multi-pin
 disconnect, panels, snakes, digital, speaker,
 stageboxes, video

Chester Cable

15 Oakland Ave.
 Chester, NY 10918
 (914) 469-2141 FAX: (914) 469-2141

CLARITY

1111 Industry Avenue, S.E., Roanoke, VA 24013
(703) 982-7003 (800) 962-6009 FAX: (703) 982-7032
President: John W. Mason; Sales Coordinator:
Linda T. Bishop; Product Manager: John D. Spencer
Featherstone Sales, Los Gatos, CA 408-356-3243
Unirep Inc., Valrico, FL 813-681-3477
M.I.N.K. Associates, Overland Park, KS 913-341-2112
Gerald Horne Associates, Stow, MA 508-897-1741
Forti Associates, Kensington, MD 301-949-1706
Holland Marketing, Bloomington, MN 612-881-8425
Adams & Associates, Greensboro, NC 919-272-6838
Reptronics Inc., New Madison, OH 800-888-0530
Dick Belew Sales, Dallas, TX 214-644-7881
PRODUCTS: audio

Connectronics Corp.

300 Long Beach Blvd., Stratford, CT 06497
(203) 375-5577 (800) 322-2537 FAX: (203) 375-5811
President: Richard Chivers
New Horizons, Chicago, IL 708-234-6500
Pacific Audio Group, Los Angeles, CA 213-719-1383
Marcon, Dallas, TX 214-869-0669
Hudson Marketing, New York, NY 516-625-0002
North Coast Marketing, Erie, PA 814-465-6435
Edwards Company, Inc., Livonia, MI 313-458-7777
PRODUCTS: audio, cable reels, custom, data,
instrument, microphone cable snakes, MIDI,
multi-pair, panels, speaker, splitting, stageboxes,
video

Conquest Sound, Inc.

26113 S. Ridgeland Ave, P.O. Box 268,
Monee, IL 60449
(708) 534-0390 (800) 323-7671 FAX: (708) 534-0398
President: Bob Jares Jr.; Vice President: Larry
Spalla; General Manager: Janet Jares;
Operations Manager: Deborah Hawtree; Sales:
Ed Knecht; Sales: Sally Artman
Gary Castelluccio & Assoc., Clifton, NJ 800-888-1899
AMH Sales, Inc., Torrance, CA 213-373-2034
RS Enterprises, Redmond, WA 206-883-1482
Midwest Audio Marketing, Crete, IL 708-672-3056
AMH Sales, Northglenn, CO 303-465-5967
C.L. Pugh & Associates, Cleveland, OH 216-238-1777
PRODUCTS: audio, custom, data, fiber optics,
instrument, microphone cable snakes, MIDI,
multi-pair, multi-pin disconnect, panels, snakes,
digital, snakes, fiber optic, speaker, splitting,
stageboxes, video

Consolidated Elec. Wire & Cable

11044 King Street, Franklin Park, IL 60131-1412
(708) 455-8830 FAX: (708) 455-8979
President: Tom Mann; Vice President: Karl
Rankin; Sales Operations Manager: Steve Boynton
Edwards Company, Inc., Livonia, MI 313-458-7777
PRODUCTS: audio, custom, data, instrument,
microphone cable snakes, MIDI, multi-pair, multi-
pin disconnect, panels, snakes, digital, speaker

Daburn Electronics and Cable Corp.

224 Pegasus Ave.
Northvale, NJ 07647
Edwards Company, Inc., Livonia, MI 313-458-7777

Dekoron Div. Of Furon Co.

1199 S. Chilliocthe Rd.
Aurora, OH 44202
(216) 562-9111 (800) 562-5151 FAX: (216) 562-5717
Director of Sales/Marketing: Don Goodrich;
Product Manager: Jack Brouhard; Customer
Service Manager: Jackie Amato
Edwards Company, Inc., Livonia, MI 313-458-7777

Delta Wire/Cable

2550 Communwealth
P.O. Box 833
North Chicago, IL 60064
(708) 473-4990 FAX: (708) 473-2425
President: Matt Coleman; Sales Manager: Perry
Stein
Edwards Company, Inc., Livonia, MI 313-458-7777

Developmental Technologies Grp. Inc

31139 Via Collinas #205
Westlake VIII., CA 91362
(818) 706-3338
John Anthony, Stamford, CT 203-322-9202

Fiber Optek

232 New Hackensack Rd.
Wappingers Fls., NY 12590
(914) 462-6356 FAX: (914) 462-1780
President: Michael S. Pascazi; Vice President:
Frank P. Zarzcks

Fiber Options

80 Orville Drive, Ste. 102
Bohemia, NY 11716
(516) 567-8320 (800) 342-3748 FAX: (516) 567-8322
CEO: Bob De Lla; Vice President: Clyde Smith;
Vice President: Jack Fitzsimmons; Sales
Manager: Rita Edrich
F.M. Valenti, Nahant, MA 617-592-5300
Thaw Sales & Marketing, So. Plainfield, NJ 201-
757-8150
Intermountain Marketing, Castle Rock, CO 303-
688-5507
Marketing Specialists, Simi Valley, CA 805-582-
0666
Universal Technologies S.A., Waure, Belgium,
321-0-242520
PRODUCTS: fiber optics

Fotec, Inc.

529 Main St.
P.O. Box 246
Boston, MA 02129-0998
(617) 241-7810 (800) 537-8254 FAX: (617) 241-8616
Sales Manager: William B. Pierce; Marketing
Manager: Roland S. Hadley; Vice President,
Engineering: George Shinopoulos; President:
James E. Hayes
PRODUCTS: fiber optics

GEPCO INTERNATIONAL INC.

2225 West Hubbard
Chicago, IL 60612
(312) 733-9555 (800) 966-0069 FAX: (312) 733-6416
President: Gary R. Geppert; Chief Financial
Officer: David B. Mecklenburger; Assistant to the
President: Larry Smith, Sr.; Sales Manager: Larry
Smith, Jr.
Gepeco International Inc., Ocala, FL 904-368-1032
John Anthony, Stamford, CT 203-322-9202
PRODUCTS: audio, cable reels, custom, data,
fiber optics, instrument, microphone cable
snakes, MIDI, multi-pair, multi-pin disconnect,
panels, snakes, digital, speaker, splitting,
stageboxes, video

Hi Lo Fabrication & Manufacturing

P.O. Box 509 / CR 1105
Rio Vista, TX 76093
(817) 373-2247
President: Cecil Caro; Production Engineer:
Cecil Caro; Vice President, Sales: Bridget Caro
ADCOM, Toronto, ON 416-251-3355
PRODUCTS: cable reels, custom, speaker,
stageboxes

J.W. DAVIS AND CO.

3030 Canton Street
Dallas, TX 75226
(214) 651-7341 (800) 527-5705 FAX: (214) 939-0328
President: Harvey Earp; Vice President, Sales:
Jack W. Tucker; Chief Engineer: Eric Simonson
Multi-Technical Reps., Brainerd, MN 218-828-9483
PRODUCTS: audio, speaker

LEE DAN COMMUNICATIONS, INC.

155 Adams Avenue
Hauppauge, NY 11788-3699
(516) 231-1414 (800) 533-3261 FAX: (516) 231-1498
President: Leon Goldberg; Vice President
Operations: Lawrence J. Goldberg; V.P. Finance &
Administration: David H. Goldberg; Senior
Technician: Sanford Hoffman; Office Manager:
Rita Kaplan; Sr. Sales/Service Associate: Susan
Leon
C.L. Pugh & Associates, Cleveland, OH
216-238-1777
PRODUCTS: audio, microphone cable snakes,
multi-pair, speaker, video

Lester Audio Laboratories

1111 W. Mockingbird La. #1342
Dallas, TX 75247
(214) 637-9311 FAX: (214) 637-9314
President: Laszlo Olah; VP of Administration:
Jennings Woodard; V.P. of Manufacturing:
Daniel Alvarado; Executive Assistant: Magdi
Takacs
Plarmec, U.K., 025-272-1236
Ace Music, 407-629-2288
Dobbs-Stanford, TX 214-358-0800
Bencsik & Associates, FL 904-732-9775
High Tech Audio, CA 415-726-2428
Audio Etc., St. Peters, MO 314-278-4130
PRODUCTS: snakes, digital, snakes, fiber optic

Math Associates, Inc.

2200 Shames Drive
Westbury, NY 11590
(516) 334-6800 FAX: (516) 334-6473
President: Ellen Math; Chairman of Board/Tech.
Dir.: Irwin Math; Vice President: Martin Rein;
Director of Mktg. and Sales: James Treuhaff
Sel-Tronics, Inc. - Gary Brown, Landover, MD
301-341-2700
Light Brigade - Larry Johnson, Renton, WA
206-277-1240
Al Barshop, Inc., Davie, FL 305-680-8366
Seevid, Inc., Huntington Beach, CA 714-898-6100
Crockett Sales Co., Dallas, TX 214-250-3377
Jim Burger, Philadelphia, PA 203-297-7160
PRODUCTS: fiber optics

Meridian Technologies, Inc.

80 Mott Avenue
Inwood, NY 11696
(516) 371-9300 FAX: (516) 371-9301
President: Robert Klein; Director of
Engineering: Jack Krol
Doug Warren, Newport News, VA 804-930-3217
PRODUCTS: audio, custom, data, fiber optics,
instrument, snakes, fiber optic, video

Middle Atlantic Products

8 North Corporate Dr.
P.O. Box 29
Riverdale, NJ 07457
(201) 839-1011 FAX: (201) 839-1976
President: Bob Schluter; National Sales Mgr.:
Eric Demarest; National Director Operations:
Scott Mathews; Office Manager: Rosemarie
Curti; West Coast Operations Mgr.: Sean Freida
Middle Atlantic Rack Distr., Haskell, NJ
201-839-2714
Middle Atlantic Western Distr., Moorepark, CA
805-529-6104
Audio Etc., St. Peters, MO 314-278-4130
PRODUCTS: panels

Monster Cable

274 Wattis Way
S. San Francisco, CA 94080
(415) 871-6000
President: Noel Lee; Dir., Special Markets Dev.: Gary Reber
Loomis and Associates, Fremont, CA 415-683-0883
PRODUCTS: audio, cable reels, custom, data, fiber optics, instrument, microphone cable snakes, MIDI, multi-pair, multi-pin disconnect, snakes, digital, snakes, fiber optic, speaker, splitting, stageboxes, video

Mystery Electronics

707 Kendall Drive
Nashville, TN 37209
(615) 352-1322 FAX: (615) 356-2516
National Sales Manager: W. John Ryan; Account Manager: Debbie Ryan
ASR Enterprises, Fallston, MD 301-893-0001
Centurian Marketing, Ballwin, MO 314-227-7229
Henry Phillips Co., Roswell, GA 404-992-3070
Monfort Electronics Marketing, Indianapolis, IN 317-872-8877
Tenikl & Assoc., Houston, TX 713-528-2005
Audio Etc., St. Peters, MO 314-278-4130
PRODUCTS: stageboxes

Neutrik USA, Inc.

195-s3 Lehigh Ave.
Lakewood, NJ 08701
(908) 901-9488 FAX: (908) 901-9608
General Manager: James E. Cowan; Product Manager: Kenneth W. Smalley; Product Manager: William J. Dorman
Dimension/ Point IX, Lewisville, TX 214-436-3706
PRODUCTS: audio

OptoDigital Design Inc.

8920 Business Park Drive #435
Austin, TX 78759
(512) 338-4707 FAX: (512) 794-9997
CEO: Rodney Herman; V.P., Sales and Marketing: Barry Thornton
Audio Etc., St. Peters, MO 314-278-4130
PRODUCTS: fiber optics, snakes, digital, snakes, fiber optic

PEAVEY ELECTRONICS CORP.

711 A Street
P.O. Box 2898
Meridian, MS 39301
(601) 483-5365 FAX: (601) 484-4278
CEO: Hartley Peavey; President: Mella Peavey
Dimension/ Point IX, Lewisville, TX 214-436-3706
PRODUCTS: snakes, digital

Pro Co Sound Inc.

135 E. Kalamazoo Ave.
Kalamazoo, MI 49007 (800) 253-7360 FAX: (616) 388-9681
President: Charlie Wicks; Vice President - Sales: Jerry Smelker; Director of Marketing: Dan Driessche; East Region Sales Manager: Roger Burns; Central Region Sales Manager: William Eaton; West Region Sales Manager: Kathy Hill
Dimension/ Point IX, Lewisville, TX 214-436-3706
PRODUCTS: audio, custom, data, instrument, microphone cable snakes, MIDI, multi-pair, multi-pin disconnect, panels, speaker, splitting, stageboxes

Quabbin Wire & Cable Co., Inc.

10 Maple St.
Ware, MA 01082
(413) 967-6281 (800) 368-3311 FAX: (413) 967-7564
President: Paul D. Engel; Manager of Sales & Marketing: Thomas R. Russell; Operations Manager: George W. Meilnik; Buyer: Melissa A. Delargy
McCoy Associates, Richardson, TX 214-864-1838
John P. Jaso & Associates, Sarasota, FL 813-371-3814
R. F. Mayo Associates, Boulder, CO 303-442-2155
Component Solutions, Brea, CA 213-690-0053
XYZ Marketing, St. Charles, IL 708-584-3001
Camden Marketing, Pierre Fonds, QU 514-683-3377
PRODUCTS: audio, custom, data, instrument, multi-pair

Rapco International Inc.

Route 1, Box 50
Jackson, MO 63755 (800) 467-2726
FAX: (314) 243-1384
Chief Executive Officer: Peter Marsac; National Sales Manager: Mike Torbet
J.B. Parent, Dublin, OH 614-764-0064
PRODUCTS: audio, cable reels, custom, instrument, microphone cable snakes, MIDI, multi-pair, multi-pin disconnect, panels, panels, speaker, splitting, stageboxes

REVERE INDUSTRIES

1101 Blenville St.
New Orleans, LA 70112
(504) 523-3503 (800) 843-8321 FAX: (504) 525-6361
Vice President Mktg./Sales: Richard Harris
Camden Marketing, Pierre Fonds, QU 514-683-3377

Shogyo International Corp.

287 Northern Boulevard
Great Neck, NY 11021
(516) 466-0911 FAX: (516) 466-0922
President: Mark A. Rubin; Vice President: Howard Rubin
Karp Communications, Tampa, FL 813-968-7098
PRODUCTS: audio

Signal Cable Company

2500 Commonwealth
N. Chicago, IL 60064
(708) 689-9090 (800) 323-9355 FAX: (708) 689-1192
V.P. General Manager: Kerry Cllicken; General Sales Manager: Steven Vivacue; Customer Service: Ray Deeter; Customer Service: Lynn Pack
Cambridge Marketing, Westerville, OH 614-363-9191
PRODUCTS: cable reels, data, instrument, microphone cable snakes, speaker, video

SONANCE

961 Calle Negocio
San Clemente, CA 92672
(714) 492-7777 (800) 582-7777 FAX: (714) 361-2705
President: Scott Struthers; Vice President: Geoff Spencer; Sales Manager: Dave Donald; International Sales Manager: Mark Cichowski; Public Relations Director: Mitch Simon; Dir. Sis Trn. & Mkt. Research: Kevin Leja
Morris Tait and Assoc., Los Angeles, CA 213-877-4424
Bach Sales, New York, NY 212-727-0404
Tandem Marketing, Chicago, IL 708-605-1960
Dobbs Stanford, Dallas, TX 214-358-0800
Balaton Marketing, Washington DC, 202-471-1764
MJA Marketing, St. Charles, MO 314-447-7111
PRODUCTS: audio

Wadla Digital Corp.

624 Troy Street
River Falls, WI 54022
(715) 426-5900 FAX: (715) 426-5665
Vice President, Sales & Mktg: Jim McCullough
Cambridge Marketing, Westerville, OH 614-363-9191
PRODUCTS: fiber optics

**WEST PENN WIRE CORP.**

2833 W. Chestnut Street
P.O. Box 762
Washington, PA 15301
(412) 222-7060 (800) 245-4964 FAX: (412) 222-642X
Exec. Vice Pres. Marketing: Donald J. Hastings; Vice President Sales: Louis V. Valente; Regional Sales Manager: Daniel J. Hastings; Regional Sales Manager: Richard Tovornik; Regional Sales Manager: Robert Bruno
Jim Miles, Dallas, TX
Allen McAllister, Chino, CA
MJA Marketing, St. Charles, MO 314-447-7111
PRODUCTS: audio, data, fiber optics, microphone cable snakes, multi-pair, snakes, fiber optic

Whirlwind

P.O. Box 1075
Rochester, NY 14603
(716) 663-8820 (800) 733-9473 FAX: (716) 865-8930
President: Michael Lalacona; Vice President: Bonnie Gardner; Electrical Engineer: Jim Kelsey; Sr. Design Engineer: Carl Cornell
MJA Marketing, St. Charles, MO 314-447-7111
PRODUCTS: audio, cable reels, custom, instrument, microphone cable snakes, MIDI, multi-pair, multi-pin disconnect, panels, speaker splitting, stageboxes

Wilco Communications

P.O. Box 60579
Sunnyvale, CA 90061
(408) 746-3993

Wireworks Corp.

380 Hillside Avenue
Hillside, NJ 07205
(908) 686-7400 (800) 642-9473 FAX: (908) 686-0482
President: Gerald J. Krulowicz; Secretary/Treasurer: Larry J. Williams; Customer Service Manager: Angela Kelly
Cambridge Marketing, Westerville, OH 614-363-9191
PRODUCTS: audio, cable reels, custom, data, microphone cable snakes, multi-pair, multi-pin disconnect, panels, speaker, splitting, stageboxes, video

**Order More
Blue Books
Now!**

MARKETPLACE

FACILITY FOR SALE

MUSIC STORE

Family owned music store established 1939. Best location for music store in progressive city of 100,000. Outstanding franchises available like Peavey, Yamaha, Ibanez, Crate and more. School band instrument rental program with Selmer and Bundy. Private teaching rooms. Assume lease on present building with option to buy. Buyer must be willing to maintain family tradition of service and customer satisfaction. Contact:

C.C. Martin at Martin Music
Pueblo, CO
(719) 543-0775

HELP WANTED

Service Technician

Thompson Engineering Company is accepting applications for the position of Service Technician. Candidates must possess the following knowledge, experience, skills and abilities:

- Factory training, extensive experience and skills in the installation and service of Rauland institutional communications products
- A thorough general knowledge of electronic key telephone systems, television systems, sound systems, security systems and fire alarm systems
- A proven ability to provide exceptional customer service and satisfaction to a wide variety of customer types and personalities

Please send complete resume, documentation, references and salary history to:

Gregor E. Eberhardt, General Manager
Thompson Engineering Company
3651 Oakley Ave.
Riverside, CA 92501

SKB ATA Rack Mounts at an Affordable Price



Meets ATA class 300, Cat. 1 Spec. available in 2U - 12U sizes and is half the weight of conventional wooden racks. Call your local dealer for a demo or fax for the name of your nearest distributor.

434 West Levers Place, Orange, CA 92667 (817) 847-5400 FAX (817) 847-6319



Circle 1 on Reader Response Card

HELP WANTED

GENERAL SALES MANAGER

For excellent territory in S.E. United States. Must have experience in sound, drive thru and background music selling. This position provides an opportunity for earnings of 50k to 80k based on production of market. Full Benefits. Send Resume:

Sound & Communications
Dept. 71
25 Willowdale Avenue
Port Washington, NY 11050

Manufacturer's Rep & Dealers Wanted

RACOM PRODUCTS INC. is seeking Manufacturer's Reps and Dealers for our line of Digital Voice Announcers, Feedback Eliminators, Multi-line Paging Concentrator and other related digital voice storage/announcers line.

Call 1-800-722-6664
or Fax
216-351-0392
for details

SALES MANAGEMENT OPPORTUNITY

Established Rauland-Borg distributor seeking individual experienced in the design, layout and bidding of school intercom, nurse call systems and commercial sound systems. Sales management opportunity. Salary, commission and benefits. Please send resume to:

M.J. Emerson, President
MTC Systems
P.O. Box 71002
Des Moines, IA 50325

MARKETPLACE

INSTALLERS!

EASY KARY®
Wire Reel Holders



- 3 SIZES
- All Steel Construction

Carry like a briefcase

PUSH-PULL RODS Get cable through impossible places. Extends 45'. Light weight. Flexible



SPEAKER & TILE SUPPORTS



SPEAKER ENCLOSURES



ALL STEEL LIGHT WEIGHT but STRONG for all 4" and 8" SPEAKERS in ALL types of CEILINGS
U.L. LISTED FREE SAMPLES

The Audio Serviceman's Right Arm. Check the complete sound system from MIC to SPEAKER ... and much, much more.

TESTSET TS-1A

CALL OR WRITE FOR CATALOG
MUSIC SUPPLY CO., INC.
809 North Madison • Dallas, TX 75208
ALL 50 STATES 1-800-527-1522
FAX 214-946-9155 Local 214-946-8450

800-527-1522

30 DAY FREE TRIAL

INSTANT OPEN ACCOUNT

Circle 2 on Reader Response Card

FREE 56-PG CATALOG



Complete line of audio modules and accessories for all engineered sound & broadcast applications

MODULAR AUDIO PRODUCTS
1-800-333-7697 • 516-345-3100 • FAX 516-345-3106
DIV OF MODULAR DEVICES INC • 1 RONE RD • SHIRLEY, NY 11967

Circle 3 on Reader Response Card

FREE Catalog & Audio/Video Applications

250 PRODUCTS



Stereo/Mono Pwr. Ampl.



Video & Audio Dist. Amplis.
RGB-Sync Dist. Amplis.



250 PRODUCTS
PWR SUPP, EQ,
PHONO, MIC,
TRANS, ACN,
TAPE, VIDEO,
LINE, OSC

NETWORK FEED BOXES

- 1-in / 16-out Audio/Video
- 2-in / 18-out Audio
- 2-in / 24-out Audio
- 4-in / 1-out Audio/Mixer
- Routing Switchers



OPAMP LABS INC (213) 934-3566
1033 N Sycamore Av, LOS ANGELES CA, 90038

Circle 4 on Reader Response Card

DOCTORS REGISTER SYSTEMS



FAST INSTALLATION!!

No longer necessary to cut in backboxes for the EDSTAN Doctors Register

Now you can order EDSTAN in our new pre-wired wall.

EDSTAN, INC.
Baldwin Park, CA 91706
(800) 423-4765
FAX (818) 337-3796

Circle 7 on Reader Response Card



Miniloop II,™
Superloop II,™
Superloop "PRO,"™
& **"Satellite"™**

Personal and Large Space
Induction Loop
Assistive Listening Systems

Introducing the **"3-D"™**
(Three Dimensional)
Induction ALS

OVAL WINDOW AUDIO

78 Main Street
Yarmouth, ME
04096
(207) 846-6250
Voice/TDD
FAX (207) 781-2719



"The leader in induction ALS technology"

Circle 5 on Reader Response Card

Cord Fox

VELCRO CORD-TIES



- Over 20 Standard Designs
- 18 Colors Available
- Custom Printing
- Can Build to Your Specs!

Toleeto Fasteners International
170 Mace St. E-6 (619) 426-3725
Chula Vista, CA 92011 FAX (619) 422-2084

Circle 6 on Reader Response Card

1991 BLUE BOOK AD INDEX

Company	Page	RS #	Company	Page	RS #	Company	Page	RS #
Aiphone Communication Systems	25	233	IED-Innovative Electronic Design	CII/3	226	Quam-Nichols	9	216,
Alarm Accessory	193	220	IRP Professional Sound	42	274		110	282
Ashly Audio	162	249	Ivie Technologies	163	262		131	283
Atlas/Soundolier	142/143	225	JBL Professional	CIV	208	Ramko Research	164	247
AudioControl Industrial	189	267	Karibu Sound	137	265	Rane Corporation	43	230
Audio Logic	47	236	LaBelle Industries	55	286	Rauland-Borg	103	241
Audio Technica	156	276	Lectrosonics	167	210	Raxxess Metalsmiths	66	291
BBE Sound	48	292	Lee Dan Communications	27,95	38,228	Renkus-Heinz	129	250
Cal Switch	195	251	Lowell Manufacturing	63	257	Ring Communications	93	212
Carver Professional	36	263	Mackenzie Laboratories	145,109	245,244	Rolls Corporation	39	273
Celestion	124	270	Manufacturers' Reps. Ed. Research Foundation	121	—	RPG Diffusor Systems	22	260
Columbia Scientific Industries	102	41	Mehlich Electronics	97	39	Sencore	CIII	215
Community Light & Sound	127	259	Menlo Scientific	187	258	Sennheiser Electronics	85	209
Component Specialties/CSI	170	261	Meyer Sound Laboratories	123	232	Sharp LCD	53	221
Crown International	33,155	218,222	MG Electronics	115,137	219,40	Shure Brothers	153	201
C-T Audio	154	279	Middle Atlantic Products	65	242	SKB	200	1
David Clark	80	252	Modular Devices	201	3	Sonic Systems/Soundsphere	130,134	255,256
Delta Communications	101	289	Music Supply Company	201	2	SoundScape Speakers	131	280
DOD Electronics	45	217	OAP Audio	128	237	Stentonfon Communications	91	238
Edstan	201	7	Opamp Labs	201	4	Tascam	75	240
Electrosonic	56	234	Oval Window Audio	201	5	Technical Projects	81	281
Electro-Voice	125	205	OWI	132	268	Tektone Sound & Signal	88	206
ESE	21	284	Oxmoor	160	243	Telecall Communication Systems	106	207
Fostex	135	202	Oz Electronics	76	293	TOA Electronics	4,133,	229,
Fourjay Industries	111,136	36,37	Paige Electronics	194	288		161	253,254
Frazier	126	277	Panasonic CCVED	69	204	Toleeto Fasteners	201	6
Freeform R&D	78	285	Peavey/Architectural Acoustics	49	213	TSI	64	269
Full Discount Wholesalers	59,183	264,235	Phonic Ear	84	290	TSK Electronics	100	278
Gefen Systems	60	271	Pioneer Laser	77	203	University Sound	141	214
Gemco Electronics	119	223	ProTech Audio	184	275	West Penn Wire	196	231
ICC-International Components Corp.	117	239	QSC Audio Products	35	227	Wheelock	169	211
						White Instruments	46	272
						Wohler Technologies	34	266

SECTIONS MANUFACTURER'S INDEX STARTS ON PAGE 10

5	QUICK REFERENCE CATEGORY INDEX	18	CONTRACTOR'S CALENDAR & INDUSTRY ASSOCIATIONS AND SHOWS
7	PRODUCT DIRECTORY AND INDEX	20	31st ANNUAL DIRECTORY OF INDUSTRY SUPPLIERS
17	TRADE NAME INDEX		

Copyright © 1991 SOUND & COMMUNICATIONS PUBLISHING, INC. Reprint of any part of contents without permission forbidden. Titles Registered in the U.S. Patent Office. Sound & Communications (U.S. P.S. 943-140) (ISSN #0038-1845) is published monthly by Sound & Communications Publications, Inc., 25 Willowdale Avenue, Port Washington, N.Y. 11050. 516-767-2500. President, Vincent P. Testa. Subscription rates: U.S.—1 year \$15.00, 3 years \$37.50. All other countries—1 year \$25.00, 3 years \$67.50. Subscriptions outside of U.S. must be paid in American currency. Second-class postage paid at Port Washington, NY and at additional mailing office. POSTMASTER: Send address changes to Sound & Communications, 25 Willowdale Avenue, Port Washington, NY 11050.

.2 mV ➔ 5,000 Watts*
Only One Instrument Will Take You This Far!

The Missing Link In Audio Servicing!



The PA81 Stereo Power Amplifier Analyzer!
A Sencore Exclusive!

Introducing the "Missing Link In Audio Servicing" that allows you to measure the level, listen to the audio, and view the audio during all amplifier tests. The PA81 provides everything you need for analyzing signals from microphones to power amplifier outputs fully integrated into one complete package, with:

- Twin Frequency Compensated Autoranged Wattmeters: 250 watts per channel (500 watts if paralleled or 5 KW if using PM82)
- Built-in IHF/EIA Testing Components At Your Fingertips: 2, 4, 8, 16, 32 ohm-zero reactance loads, and all specified bandpass audio filters
- Monitor Sound Quality At Every Step To Prevent Backtracking
- Measure RMS Volts And dB As You Trace Through Circuits: Plus, programmable dB to measure stage gain

- Test Intermittents To Prevent Amplifier Damage: Built-in DC balance test-automatically opens loads
- Test Audio Line Levels To Make Sure The Driver Input Signal Is Correct: Check turntables, AM tuners, FM tuners, TV stereo demodulator outputs, CD players, etc. for standard line levels
- Monitor Stereo Separation To 126 dB: Monitor, troubleshoot, or align AM-FM or TV Stereo separation circuits

*PM82 Power Max™ 5 KW
EIA/IHF Decade Audio
Power Multiplier — Accessory
To The PA81



For More Details Call 1-800-SENCORE ext. 618
(736-2673)

Even Our Smaller Systems Can Fill A Big Hall.

SR4700 Series

You've seen and heard our big systems, installed in major venues around the world and on tour with some of the biggest names in the music business. The SR4700 Series Loudspeaker Systems are equally at home on the road or in the hall.

Their legacy comes from Cabaret® Series, a prime player in small to medium club sound reinforcement since the seventies. Their influence is Concert

Series™, the new standard in packaged JBL systems. With

Cabaret as the starting point and Concert Series as our current direction, we listened to your comments and suggestions, turning them into the sound system of the nineties and beyond.

The SR4700 Series is pure pro audio. Pure JBL components, the same caliber as those in our larger systems, including the Vented Gap Cooling™ low frequency drivers and the 2445J compression driver. Pure JBL enclosures, five times stronger than traditional designs, and protected by plastic-coated steel grills and super-durable fabric-laminated plywood cabinets. Pure JBL sensibility, interlocking enclosures with heavy-duty steel handles and recessed input connectors, so they travel tighter, set-up easier and last longer.

SR4700 Series, pure JBL. Be the first in line to hear them today at your local JBL dealer.



JBL Professional
8500 Balboa Boulevard, Northridge, CA 91329 USA
A Harman International Company