

SOUND & COMMUNICATIONS

Volume 35 Number 8

September 25, 1989

HANDS-FREE CHURCH SYSTEM

When a church in Pennsylvania paid off its mortgage, it had enough money for an upgrade to its sound system. A 50-voice active choir and strong preaching demanded design considerations, as did an overflow room where churchgoers participate in the service via TV monitors and speakers. This church records its services and has recording equipment in the overflow room. Two sets of mixers were required. The designer-installer advised a simple-to-use system with maxi-

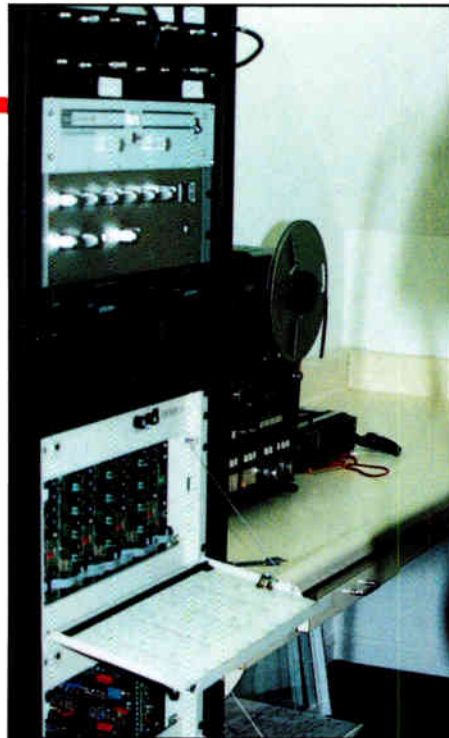

imum space and cost effectiveness. The purchasing committee was reasonable, the installation was completed; and a lesson was learned. **28**

HEALTH COMMUNICATIONS

The role of the microprocessor in the institutional setting is the technological basis of discussions on health care communications. But there's more. What exactly is health care in the 1990's? What are the building codes, liability concerns, standards? A panel of participants in the health care industry discusses the issues and technology facing businessmen in health communications. Get ready for the twenty-first century. But first, get through the nineties. **33**

MEASURING INTENSITY

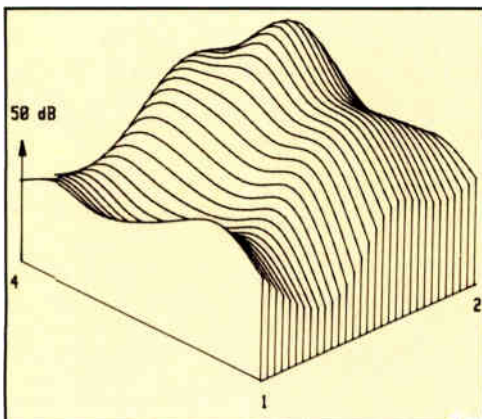

The use of sound intensity is currently dominated by laboratory oriented procedures. Steven Orfield walks us through the procedures, from determining measurement range — in frequency and in level — to the choice of microphones, to the end results. What are the actual processes of measuring sound intensity? In the first part of this series, Mr. Orfield discussed the theory of sound intensity measurement. This month he offers an explanation of the steps in measurements. **44**



**BUSINESS
MUSIC**

In this month of the IBMA convention, business music is on our minds. What is the state of the market? What is the prognosis for the future? How are the *new media* impacting upon the industry? And what does it all mean? Our report on Business Music is inside these pages. **24**



You can't build a better mousetrap unless you know your mice.

For years, those of you who wished to enjoy the many benefits of processed speaker systems had to endure one major drawback: loss of sound quality when the system switched into the protect mode.

The new DeltaMax™ electronically controlled loudspeaker systems put an end to such frustration.

We built our knowledge of loudspeakers . . . and their destruct modes . . . into a controller which addresses overexcursion, voice-coil overheating, and amplifier clipping without altering frequency response—the system's incredible clarity remains unchanged.

In addition, front-panel LED's indicate these problems clearly and distinctly. From that point, it's your option to either make a change in the mix yourself or allow the controller to compensate automatically.

We also rigged these systems for flight—with optional three-point harnesses equipped with steel-reinforced pan-fitting hardware, perfect for safely arraying speakers in multi-cabinet clusters.

DeltaMax is brought to you by the same company that invented a variety of better mousetraps for the audio world, including constant-directivity horns and the world's first neodymium compression driver, the N/DYM® 1.

Give us a call today for more information and engineering data sheets.

Circle 202 on Reader Response Card



Electro-Voice®

a MARK IV company
600 Cecil Street
Buchanan, MI 49107
Phone: 616-695-6831

In Canada: Mark IV Audio Canada, Inc.
345 Herbert Street
Gananoque, Ontario K7G2V1

Get automatic mixing capabilities
and the best modular
signal processing.

SYSTEM 41...

with
VOICE-MATIC®
Modules

Two new Voice-Matic microphone mixer modules add automatic flexibility and operating performance to System 41 installations. The DJ-4114 Voice-Matic Microphone Mixer Module and DJ-4115 Voice-matic Master Module offer noise-free interconnection and total compatibility with all other System 41 components.

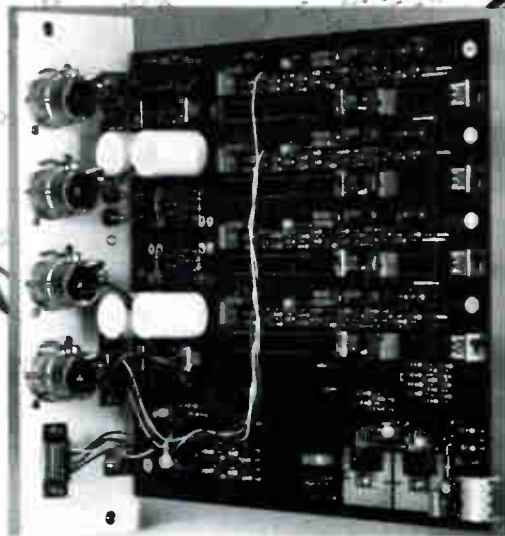

Model DJ-4114 Voice-matic Microphone Mixer Module

The DJ-4114 Input Mixing Module features buffered pre-amp outputs, pre or post gates, status LED and logic outputs and 18 volt phantom power supply. Optional features include remote level and input controls and 48 volt phantom power.

All IRP Products are made in the U. S. A.



Model DJ-4115 Voice-matic Master Module

The DJ-4115 Voice-matic Master Module mixes the microphone signals from all DJ-4114 Modules in the system along with any auxiliary input signals. Various remote controls are optional.

IRP industrial
research
products, inc.
A Knowles COMPANY

321 Bond St. • Elk Grove Village, IL 60007
TOLL FREE: 1-800-255-6993 • In IL: 312-439-3600
TELEX: 701845 • FAX: 312-640-9607

Circle 203 on Reader Response Card

C O N T E N T S

Volume 35 Number 9

September 25, 1989



14



28

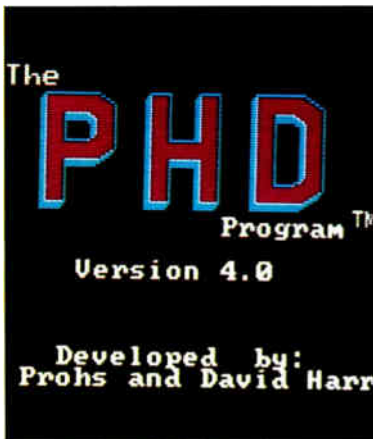

55

FEATURES

14 Measuring Sound Intensity, Part 2

By Steven J. Orfield and Richard G. Pierson

An explanation of the process of measuring sound intensity, with emphasis on acoustics and electroacoustics applications.

21 The IBMA Convention

By Maria M. Conforti

New technology and new members promise to make this year's event exciting. Also, President Joseph Elum's recent missive to the Association membership.

24 Business Music

By Suzan Prince

A technology and market update, with input by some of the industry's dynamic leaders.

28 A Two-Way Church System

TekCom Corporation provided a Pennsylvania church with a system that could handle both a strong preaching style and powerful choir vocals.

33 Health Care Communications

Where is this market going? Are legal problems a threat to the manufacturers or to the installers? How responsible — and responsive — are health care facilities? A transcript of the lively panel held at this year's NSCA. Also, health care communication product news.

46 The Carvin MX2488 Console

By Hector La Torre

From clubs to stadiums to broadcasting and more, this new board can seemingly do it all.

55 The PHD Program: A Review

By Mike Klasco

An overview of John Prohs' brain child.

COLUMNS

12 Sales and Marketing

42 Ask Dr. Wokka

By Dr. Wilhelm Wokka

44 Book Review

By Hector La Torre

70 30 Years Ago in Sound and Communications

By Maria M. Conforti

DEPARTMENTS

6 Letters To The Editor

9 Newsletter

61 Update

People	61
Contracting Close-up	62
Products	64
Literature	64
Calendar	67

68 Classifieds

SOUND & COMMUNICATIONS

Copyright © 1989 SOUND & COMMUNICATIONS PUBLISHING, INC. Reprint of any part of contents without permission forbidden. Titles Registered in the U.S. Patent Office. Sound & Communications (U.S. P.S. 943-140) is published monthly by Sound & Communications Publications, Inc., 25 Willowdale Avenue, Port Washington, N.Y. 11050. 516-767-2500. President, Vincent P. Testa. Subscription rates: U.S.—3 years \$37.50, 1 year \$15.00. Canada and Mexico—3 years \$48.00, 1 year \$18.00. Foreign and South America—3 years \$60.00, 1 year \$25.00. Second-class postage paid at Port Washington, NY and at additional mailing office. POSTMASTER: Send address changes to Sound & Communications, 25 Willowdale Avenue, Port Washington, NY 11050.

Coming in October. . .

AES Convention plans, the speech intelligibility issue, and stadium/arena sound. Don't miss it.

THE NEXT STAGE IN WIRELESS

Stage 22: True Diversity Wireless With dbx* At A Price That Won't Hold You Back

Stage 22 is the first affordable *no compromise* true diversity wireless system for musical performance and sound reinforcement.

Samson True Diversity technology with built-in dbx Noise Reduction yields superb high-fidelity wireless sound in every application.

The best news? Stage 22 comes fully equipped at a price so low everyone can afford to go wireless with the most thoroughly professional system available.

Don't be left out of the wireless future. Cut the cables of the past now with Stage 22.

SAMSON
WE ARE THE WIRELESS FUTURE™

Samson Technologies Corp.
485-49 South Broadway, Hyltonville, NY 11851 (516) 532-3800 FAX (516) 532-2423
In Canada: Commercial Corp. (905) 880-1422
9255 Ave. La Presse, Dorval, Québec H9P 1A2 (514) 636-0171



Stage 22 is available with the Electro-Voice N/Dym 757 microphone sold exclusively in wireless by Samson.

*dbx is a registered trademark of BSR North America © 1988 Samson Technologies Corp.

Circle 217 on Reader Response Card

World Radio History

TO THE EDITOR

WE have DR. WOKKA YOU MUST S-EN. A DAT Recorder

to BOX 36681
ATLANTA, GA.
30332

or WE USE The

SPEAKER TAPPING MACHINES !!!

Our position is firm: Sound & Communications magazine will not negotiate with terrorists, especially not with phony terrorists. Despite the threat inherent in this note, we have independently retrieved the hostage Dr. Wokka. His column in this issue explains it all. Crime does not pay.
—The Editors

LETTER FROM THE EDITOR

Although we in this industry are all in the business of communication — and this magazine itself is called *Sound & Communications* — communications itself is ludicrously difficult to define. When an industry is, in addition, growing at a technological rate fitting to the late twentieth century, as soon as you define it, you've lost it.

This issue of *Sound & Communications* focuses on three aspects of communications that are undergoing serious technological changes that could impact upon the definition of those aspects of the business: Business Music; Hospital Communications; and Computer Aided Design.

The background/foreground music business has changed and is changing. The current terminology of business music is no faddish change of nomenclature; it truly better describes the field. It is a business that encourages business — or should, if done right. And yet an enormous percentage of public oriented businesses has not

yet turned on to music. Our contributing writer Suzan Prince talked to some of the participants in that part of the business. And her report can be read in these pages.

Nurse call has undergone a sea change. It is now really hospital communications, and in the future it could be part of a total institutional computerized communications network. At the last NSCA convention, *Sound & Communications* sponsored a panel discussion on the subject; and we are reproducing an edited transcript this month.

And what about sound systems; how have they changed? Part of the enormous change in design and installation practices has been the growing development and interest in computer aided design. Mike Klasco continues his series of software reviews, focusing this month on the PHD program.

We hope you enjoy this issue. And let us know what changes you're seeing in the business.

Editorial Director/Publisher
Vincent P. Testa

Assistant Editor
Maria Conforti

Contributors
**Mike Klasco, Hector La Torre,
Richard G. Pierson, Suzan Prince,
Steven J. Orfield**

Technical Council
Dr. Mort Altshuler
Professor Audiology, Hahneman University,
Chief of Audiology, V.A. Hospital, Phila, PA

Mike Biegel
EPD Technology Corporation
C. Leroy James
Rees Associates, Inc.

Richard N. Jamieson
Jamieson and Associates, Inc.
Russell Johnson
Artec Consultants, Inc.

Richard Negus
Purcell Noppe Associates, Inc.
William Parry
Maryland Sound Industries, Inc.

Daniel Queen
Daniel Queen Associates
Jon Sank
Cross Country Consultants

William R. Thornton
Phd, PE

Art Director
Gerard Caramannello

Staff Artists
Steven E. Ingram
Germaine Cassidy

Typesetting
Leo Ancona

Circulation Director
Robert Evans

Advertising Director
Nancy Davis

Vice President/Editorial
Judith Morrison

Editorial and Sales Office
Sound & Communications
25 Willowdale Avenue
Port Washington, New York 11050
(516) 767-2500

 BPA

 COMMUNICATIONS

Sound & Communications • DJ Times • Post
Sound & Communications Blue Book
The Music & Sound Retailer • The Retailer Red Book
The Music & Sound Buyer's Guide
CES-TV News • NAB-TV News • NAMM-TV News
NSCA-TV News • CROSSTALK/AES-TV News

THE IEQ WITH Smartcurve™

Not Just Another
Programmable Equalizer
With MIDI™

The IEQ with Smartcurve™ is a programmable, high performance graphic equalizer that includes a video output. For those who wish to enjoy the video output of the IEQ, ART makes the IEQ Video Monitor.* Smartcurve™, proprietary software developed by ART gives you instant actual frequency response as easy as the push of a button.

The IEQ Family consists of both the 2/3 octave and the 1/3 octave graphic equalizers. Both types come in two varieties, Controllers and Satellites. A Controller is a self-contained programmable intelligent graphic equalizer capable of controlling 15 satellites at once. IEQ Satellites are exactly the same unit except the front panel controls are eliminated.

IEQ Model Specifications:

Controller & Satellite

- 128 battery backed presets
- MIDI
- Frequency Response 20Hz-20kHz \pm 0.5dB
- THD \leq .009% @ 1kHz, 0dBm typical
- Dynamic Range \geq 100dB typical
- Balanced inputs and outputs

*IEQ Video Monitor Features

- 19" rack mountable
- NTSC compatible monochrome monitor
- 4 Selectable inputs
- Standard RCA jacks for easy connections

It Has To Be A Work Of . . .

ART

Applied Research & Technology

215 Tremont Street
Rochester, NY 14608
(716) 436-2720
TELEX 4949793 ARTROC
FAX (716) 436-3942

For more information see your local dealer.

Circle 209 on Reader Response Card

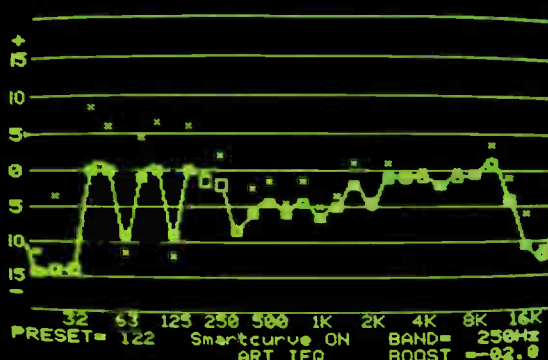
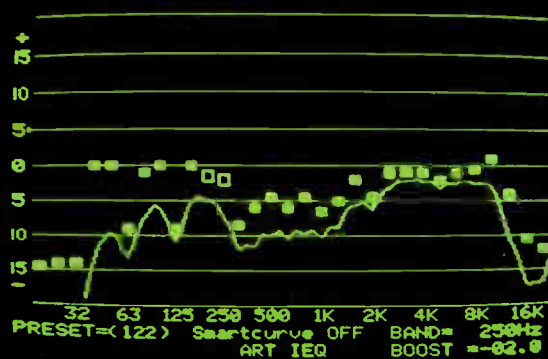
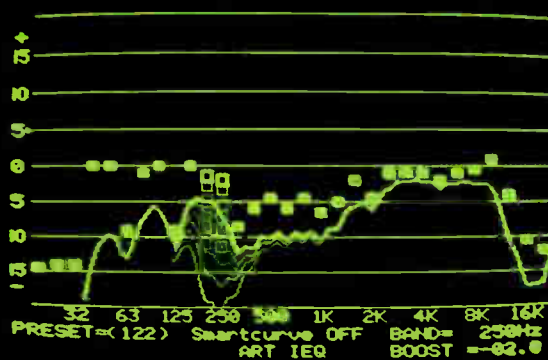

1 See the Sound

This is a video output of the IEQ as the unit is being adjusted. The sliders can be moved \pm 15dB in 1/2dB steps to get the exact response you need. With the simple push of a button, complex equalization can be done in seconds with incredible accuracy.

2 Hear the Sound

The power of the IEQ readily becomes apparent as the video display plots the frequency response due to the slider settings. The IEQ offers high quality constant "Q" equalization. The video graphic display shows the correlation between the sliders and the frequency response.

3 Perfect Sound

Turn Smartcurve™ on and perfect equalization is at your fingertips. Note the difference between the second frame, (Smartcurve™ OFF) and this frame. The position of the sliders represent the actual frequency response of the EQ. Interaction between bands is virtually eliminated. Incredible! Just think, now when you adjust the EQ you get exactly what you need. The "perfect" EQ? Let your eyes and ears decide.



The Benefit is Easy to See— the Ceiling Baffle is Not!

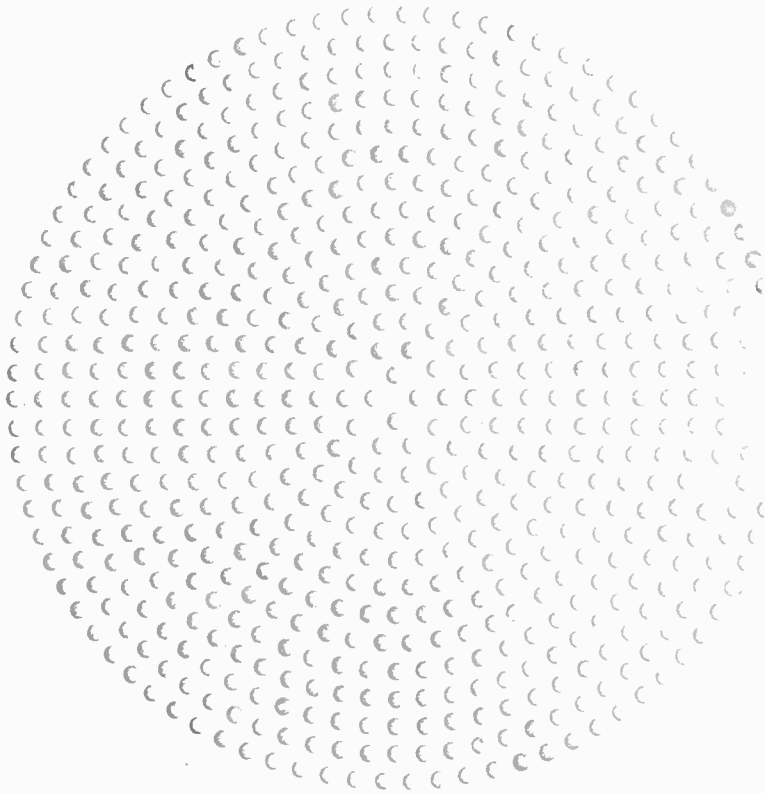

You asked for baffles that would be as unobtrusive as possible on the ceiling. Quam listened . . . and responded with a complete new baffle concept, with:

- A third less surface area than conventional 8" speaker baffles
- No visible hardware
- Made from steel textured to match popular contemporary ceiling tiles
- Quick and easy installation

A complete assembly . . . a complete solution . . . a complete demonstration of the Quam philosophy: **We hear you!**

Quam has earned its position as preferred supplier to commercial sound contractors through responsiveness in product design and in service. A broad line to meet your needs. Inventory on *our* shelves, so you don't need it on yours . . . incoming WATS for quick efficient order-processing.

Call today for your free copy of the **Quam Commercial Sound Catalog and Tech Spec 33** on the new **BR8-10WS** unobtrusive baffles.

Quam

The Sound
Decision
since 1930

Circle 204 on Reader Response Card

Quam-Nichols Company • 234 E. Marquette Road • Chicago, Illinois 60637 • Phone: (312) 488-5800 • Fax: (312) 488-6944

NEWSLETTER

OTARI CORP. PURCHASES SOUND WORKSHOP AND DIGITAL CREATIONS CORP.

Otari Corporation (Foster City, CA), the U.S. subsidiary company of Otari Inc. of Japan, has announced all assets, inventories, and interests of Sound Workshop Professional Audio Products Inc., Sound Workshop Inc., and Digital Creations Corp have been purchased from Michael Tapes and Paul Galburt for an undisclosed amount.

According to Jack Soma, president of Otari Corporation, "We had been actively pursuing a diversification strategy for Otari and we saw a mixing console product line as a natural addition to our tape recorders."

"The addition of Michael Tapes, Paul Galburt and the Sound Workshop design team's creativity and expertise further strengthens Otari's commitment to remain a leading supplier of professional audio tools," marketing manager John Carey said.

Otari will introduce the Console Series 54 at the AES convention. Previewed by Sound Workshop, three units were presold at press time.

TELEX ACQUIRES RTS

Telex Communications, Inc. (Minneapolis, MN) has acquired the assets of RTS Systems Inc. of Burbank, California. Jeffrey S. Wetherell, president of Telex, expects the company's manufacturing capabilities to enhance the cost competitiveness of RTS' product lines.

SENSORMATIC'S MINIDOME DESIGN AWARDED PATENT

Sensormatic Electronics Corporation (Deerfield Beach, FL) has been awarded a patent for its security TV systems camouflage device, the MiniDome. Approximately the size of a basketball, the MiniDome can pan a full 360 degrees.

ICIA NOMINATIONS OPEN FOR ACHIEVEMENT AWARDS

The International Communications Industries Association is soliciting nominations for its annual Communications Achievement Awards to recognize significant contributions by individuals and companies in the communications products industry. Award categories are: Distinguished Achievement Award, Manufacturer of the Year, Dealer of the Year, Educator of the Year, Business and Industry Communicator of the Year, and Not-For-Profit Communicator of the Year.

For more information, contact Barbara Reck, manager of membership and promotion, at ICIA (703) 273-7200, or write ICIA, 3150 Spring St., Fairfax, VA 22031. Entry deadline is October 31, 1989.

REP NEWS

Lowell Manufacturing Company (St. Louis, MO) has appointed Radon to represent the company in the northern California/northern Nevada area.

International Electronic Wire & Cable Company (Mt. Prospect, IL) has named Repworks, Inc. as its Sound and Communications Representative of the Year. The annual award recognizes outstanding service and sales performance by a rep organization.

Richmond Sound Design Ltd. (Vancouver, Canada) has named the following territory representatives: Master Sound and Communications (Vancouver) as agents for the Pacific rim including Southeast Asia, China, and Japan; W3 Marketing (Atlanta, GA) for the southeast U.S.; and Acromedia Corp (Los Angeles, CA) for the California and Nevada regions.

Shuttlesound Ltd. (London, UK) has been appointed UK distributor for Gauss (loudspeakers) and SCV Audio (signal processors).

NEWSLETTER

RAULAND-BORG, BIAMP SYSTEMS TEAM UP

Rauland-Borg Corporation (Skokie, IL) has acquired a financial interest in Biamp Systems (Portland, OR). Biamp designs and manufactures mixing consoles, power amps, and signal processing components. Selected Biamp products will be sold under Rauland-Borg's name, reinforcing the latter's product strength in the sound reinforcement market. Biamp's management, location and distribution channels will remain independent of Rauland-Borg.

International Music Company sold Biamp only a year after acquiring the company itself. Jerry Freed, president of International Music, said, "We divested ourselves of Biamp on August 1 and the reason is simply that our corporate strategy changed."

"We are extremely pleased with this development," said Ralph Lockhart, president of Biamp Systems. "Rauland-Borg is highly respected in the markets it serves. Its management philosophy and commitment to the industry are very compatible with the direction we have been taking Biamp over the past few years."

The management team that purchased the company in 1986—before the IMC buyout—will continue to operate the company. Aside from Lockhart, those three are Jerry Payette, vice president of finance, Robert Doty, vice president of engineering, and Ralph Tennant, vice president of manufacturing. "We're really looking forward to being able to give our guys the kinds of tools they need in terms of new products, literature, and selling aids," said Ron Camden, Biamp's sales manager. "Rauland-Borg has already demonstrated its financial commitment to the partnership."

KLARK-TEKNIK NOW TURBOSOUND U.S. DISTRIBUTOR

Klark-Teknik, distributor of signal processing, lighting and mixing consoles, recently acquired distribution of Turbosound speakers and BSS signal processing equipment in the United States and Puerto Rico. The Turbosound and BSS lines, which had been distributed by Edge Distribution Company, are now part of a five-year distribution arrangement with Klark-Teknik (Farmingdale, NY).

In a maturing industry where large audio suppliers are consolidating and acquiring, Klark-Teknik sees this distribution arrangement as a chance to move from being just a sound and lighting supplier to being an entertainment equipment supplier, said Jack Kelly, president of Klark-Teknik. With everything from signal processing gear, lighting, trussing, recording and live sound consoles, the only thing the company really needed was a high-end speaker line, Kelly said.

"We have a seven-year history with BSS, and we have a friendly history with Turbosound," said Kelly. Klark-Teknik had distributed BSS from 1983 to 1988, when Edge Technology group was formed, and the separation then "was very amicable," Kelly said.

For Turbosound, it's a chance to be united with an expanding distributor. "The nature of the industry now is that it's maturing so rapidly, that we'll really be able to take advantage of being part of a much expanded family of products," said Dan Abelson, vice president of sales for Edge Distribution Company. "In this market, these days, you need clout and leverage."

Edge will close the door of its 1½-year-old headquarters north of New York City this fall. Abelson will handle Turbosound and Dave Talbot will handle BSS sales from Klark-Teknik's Farmingdale offices.

Warning: To Avoid Risk Of Shock,

Ignore This Amp-To-Amp Confrontation.

Let's be frank. We're out to change your idea of what — and who — makes a professional power amplifier. So if you just bought a Crown MacroTech, turn the page — this comparison won't be a polite one. But it will stick to the facts.

A look inside these two amps will give you a better idea of why BGW amps like the GTB Grand Touring Amplifier are built like no others in the world. And raise some questions about Crown MacroTechs.

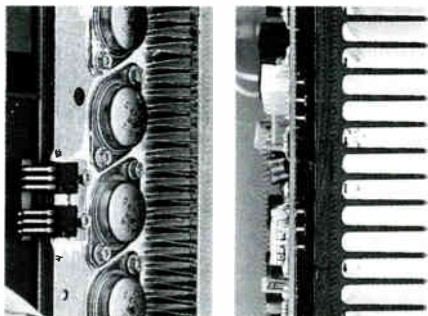

Left: The MacroTech uses mostly air to dissipate heat, not metal. The closely spaced fins are vulnerable to airborne dust and dirt.

Right: BGW uses ten pounds of aluminum to absorb thermal transients, extending power transistor life.

TAKING THE HEAT

If the MacroTech heat exchanger reminds you of an air conditioner, you've grasped its design. This approach works, at least until dust and dirt clog the fins. But as soon as the air flow slows or stops, temperature rises. Soon after that, the Crown shuts off — it could even fail.

The GTB uses massive extruded aluminum heat sinks with widely spaced fins. The

mass of metal absorbs thermal transients without straining the fan. And without quick changes in transistor temperature. That's important: Transient musical loads put the worst kind of stress on power transistors. The effects of thermal cycling fatigue may not show up until after the warranty, but they can destroy lesser amps. Meanwhile, BGWs keep right on delivering clean, reliable power.

REAL SPEAKER PROTECTION

Most amps today are direct coupled, so a blown output transistor (the most common failure) connects the power supply directly to the speakers. Earlier MacroTechs had no protection against DC. Now Crown has learned their lesson — or have they? The sensing circuit and relay they now use shuts off the power transformer, but allows the filter capacitors to discharge stored DC energy directly into your drivers — risking real damage.

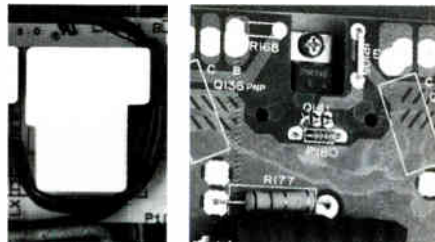

Left: Crown uses a slow-acting, less reliable relay. It can allow the filter capacitors to discharge stored energy directly into your drivers.

Right: BGW's modular power output section protects your speakers against DC damage with an instantaneous Thyristor Crow Bar. And the module is easily replaced in the unlikely event of failure.

BGW pioneered DC speaker protection in 1971. We stopped using relays years ago, when they no longer met our reliability standards for BGW amps. The GTB, like all BGWs over 200 Watts, uses solid-state Thyristor Crow Bars to keep DC from ever reaching your valuable speaker cones or compression drivers.

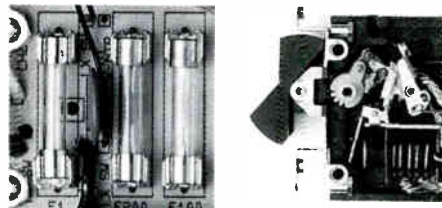

Left: Time is money, and with Crown's MacroTech you can lose plenty of both: You have to pull it out of the rack every time a fuse blows.

Right: The GTB's power switch is also a rock-actuated magnetic circuit breaker. You can reset it in a second if power lines hiccup.

MAKE YOUR OWN COMPARISON

Before you buy or spec your next power amp, call us at **800-468-AMPS** (213-973-8090 in CA). We'll send you tech info on BGW amps and the name of your nearest dealer. He can arrange a demo of any BGW model against any amp you choose. Then you'll be able to appreciate the advantages of BGW engineering with your ears, as well as your eyes.



13130 Yukon Avenue, P.O. Box 5042
Hawthorne, CA 90251-5042
Tel 213-973-8090 • Fax 213-676-6713

Circle 213 on Reader Response Card

Corporate Identity: Your Primary Marketing Tool

By John C. Stap

A well-designed and consistently applied corporate identity is one of the strongest marketing tools a sound contractor can have, but all too often, company logos, copy taglines and trademarks are applied haphazardly. This results in confusion among your customers, prospects and suppliers. Even employees can be confused about what their company stands for when they see its corporate identity changing from day to day.

Corporate identity is not a tool designed solely for mega-corporations and conglomerates. In fact, small companies like sound contractors and consultants can benefit even more from a consistent identity than larger concerns. A well thought out and correctly used identity can make a small business seem larger and more credible, and can improve that company's recognition in a given field and community.

Consistency is the key to creating a strong image. Many communications experts have said that a weak symbol applied consistently is more effective than a better symbol used inconsistently; companies are particularly fortunate when their logo is both well designed and well established, because it gives them a big step up as they face the task of making its application more consistent.

This consistency begins with a set of graphic standards for all corporate identification elements — letterhead, labels, advertising, exterior signage,

literature — anything with your company name on it. The set of standards will establish guidelines for logo size, color, and format for various applications.

A uniform identity has several advantages — both external and internal. Let's talk about your public image first, then return to the internal benefits of an identity program.

Consultants and sales organizations alike address a number of audiences: current and prospective customers, competitive companies, dealers, financial institutions, suppliers and neighbors. Some of these groups know you personally and have experienced first-hand your regard for quality and customer service. Others have not. Their first and often brief impression of your company is accomplished through its identity.

You can have the most eye-catching logo in the world or the most attractive literature — but that's only the beginning. The real work of communications is in sustaining your image so that many split-second impressions work together to create an overall picture of company excellence. Eventually, your name will become synonymous with quality, stability and consistency.

Conversely, if these many impressions of your company are confusing—for instance, if your logo is rendered in a variety of color combinations or typefaces—any work you've done to create a reputation for quality that stands behind your logo can be eroded. And you may look far less professional or quality-conscious than you really are. A consistently applied communications program isn't intended to create your corporate identity, but it

does help you communicate your true corporate values.

As your logo usage becomes more consistent, it also becomes more recognizable — so your communications programs become more cost-effective over time. If your logo is trademarked, consistent and correct usage will also protect you legally from any infringement. You'll also look like a large, established organization because your identity will be strong and well defined.

There's an additional strong marketing benefit in being able to unite various product groups under a single umbrella of corporate excellence. The internal advantages of a consistent communications program are both tangible and intangible. Let's start with the tangible. If you develop easy-to-understand and easy-to-use standards for the application of your name and logo, you won't have to reinvent the wheel each time a new project comes up. Employees and outside suppliers alike will eventually become so familiar with your standards that decisions about size, color and materials will be almost second nature. You'll also be able to make more prudent buys of sales literature and other communication tools because your long-range communications needs will be better defined.

The next benefit is hard to quantify, but a strong corporate identity can actually improve morale by giving employees a clear image of the type of company they work for. . . a company with good taste, good service, good products and good values. A good competitor and a good neighbor. A

(continued on page 50)

SYSid™

The Complete Acoustic Test Instrument

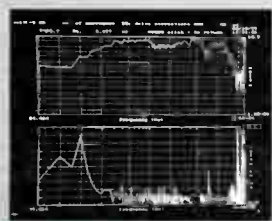
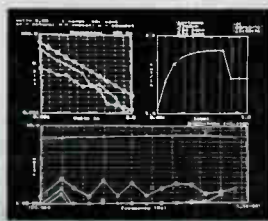
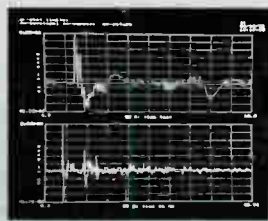
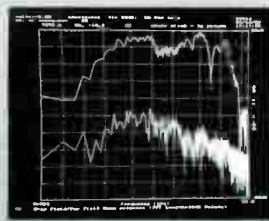

TEST SIGNAL (STIMULUS)

SYSTEM RESPONSE

SYSTEM RESPONSE



True system identification requires complete characterization of an unknown system's response. SYSid™ is the inexpensive, accurate instrument for characterizing any system operating from DC to 25kHz.

Developed in conjunction with AT&T Bell Labs, SYSid quickly does the work that used to require several costly instruments. In seconds, SYSid measures and displays:

- Impulse and time domain response
- Transfer function
- Harmonic distortion
- Intermodulation distortion
- Noise floor measurements
- Ratiometric measurements
- Complex impedance measurements

SYSid's 16-bit, 50kHz converters, double precision integer averaging and floating point signal analysis ensure consistent and precise measurements.

- Unbeatable price/performance ratio
- Self-contained within your PC
- Completely portable for field testing

When used to study or test transducers, measure room acoustics, perform structural analysis, or analyze any other audio bandwidth system, SYSid is the cost effective, complete acoustic test instrument.

Ariel_

Call Today For More Information:

201-249-2900

Ariel Corporation, 433 River Road, Highland Park, NJ 08904
FAX: 201-249-2123 / DSP BBS: 201-249-2124 / Telex: 4997279 ARIEL

SYSid requires an IBM compatible PC with floating point coprocessor and graphics capability.
IBM is a registered trademark of International Business Machines Inc.

Circle 211 on Reader Response Card

World Radio History

MEASURING SOUND INTENSITY

Part 2

By STEVEN J. ORFIELD and RICHARD G. PIERSON

In our last column, the theory underlying sound intensity measurement was discussed, along with specific uses and examples of intensity measurement, including architectural acoustics and electroacoustics applications. This month, an explanation will be offered of the actual process of measuring sound intensity, with emphasis on measurements within the audio field.

A complete sound intensity measurement system is generally made up of the components noted in Figure 1.

Most sound intensity measurements are made "in-lab," as the use of sound intensity is currently dominated by sound power testing and other laboratory oriented procedures. Additionally, sound intensity systems are often large in size, making their use as portable systems less attractive (this is why Orfield Associates uses a DAT recorder in much of its field work). (see S&C, June 1989.)

SET UP DECISIONS

Unlike many acoustical measurements, there are a number of decisions required

Figure One: Sound Intensity System

1. Dual Channel Real Time Analyzer
2. Sound Intensity Probe
3. Phase-Matched Sound Intensity Microphones
4. Intensity Calibrator, Noise Source & Pistonphone
5. Post-Processing Software
6. Plotter/Printer
7. DAT Data Recorder



Figure Two: Sound Intensity System

of the operator prior to use of an intensity system, and some potential decisions are noted in Figure 3.

The first set of decisions is with regard to measurement range, both in frequency and in level. The range of the measurement is defined by the range and settings of the analyzer and by the selection of microphone types and spacers for the actual measurement. In using the Bruel and Kjaer 2133 system, the spacer placed between the microphones can be either 6mm, 12mm or 50mm, and the typical measurement range suggested by the choice of spacer is noted below:

Spacer Size:	6mm	12mm	50mm
4181 Frequency Range (typ.)	N/A	125-5 kHz	31.5-1.25 kHz

A nomograph for selection of spacer types is noted in Figure 4.

Additionally, two sets of standard microphones are suggested, the 4178 set and the 4181 set. The 4178 set is less sensitive but covers a range of 125 Hz to 10 KHz with two different spacers (6 mm and 12 mm). A second and parallel interest is the probable frequency resolution of interest within the selected frequency spectrum, as this may affect the measurement setup (some systems, such as the 2133, can measure at very high resolution [1/12 Octave] and can post-process to lesser fractional octave or average values; they cannot post-process to higher resolution than the actual measurement). Therefore, the resolution of the measurement must be selected to be equal to or higher than the resolution of the desired result.

The dynamic range of the measurement

Today's most intelligent sound system is the one you won't outgrow tomorrow.



FLEXIBLE.

Four integrated amps, four power amps, thirty-seven interchangeable plug-in modules, two in-wall amps, AM/FM and SCA tuners, mixer, monitor panel and equalizer give you limitless system design and expansion capability. Adapting to changing needs is as easy as plugging any of Toa's remarkable modules into our 900 Series. It's fast, easy, smart.



THE 900 SERIES FROM TOA.

Legendary flexibility and reliability. And with 37 plug-in modules — it grows along with you. Smart today, even smarter tomorrow.



ACCOMMODATING.

Toa's been voted the #1 company to do business with — four years running. That's a partner you can grow with.

GROWABLE.

Toa's plug-in modules mean installation and system expansion take minutes, not hours. Because they anticipate change, it's neither costly nor time consuming.

REVOLUTIONARY.

Introducing the F-01R Sonic Maximizer BBE module. It breaks a signal into three bands and conditions it to offset inherent short-comings in speakers and mic's ... without adding harmonics or noise. The result is the most "hearable" advance in clarity, depth and intelligibility since high fidelity itself. With Toa, you just plug it in.

UNFORGETTABLE.

Dedicated modules let you tailor sound character — unforgettable sound at a very smart price.

TRUSTWORTHY.

The Toa 900 Series is fantastically reliable. Indeed, it can make callbacks a thing of the past. Specify it. Install it. Forget it.



TOA ELECTRONICS, INC.
211 GATEWAY BLVD., SO. SAN FRANCISCO, CA
94066 (415) 588-2538 FAX (415) 588-3348

**Figure Three:
Decisions prior to testing**

1. Frequency range of measurement
2. Frequency area of highest probable interest
3. Dynamic range of measurement
4. Desired tolerance of measurement
5. Probability of significant residual intensity
6. Type of measurement procedure: sweep vs. point
7. Averaging: exponential vs. linear
8. Sampling rate
9. Probable post-processing needs

later analysis. With signals that have any real level of fluctuation (as most signals do), a linear averaging time of at least 30 seconds per measurement position will often begin to resolve the data fluctuations. Additionally, there may be significant residual intensity (sound incident at an angle to the probe axis due to reflections, diffusion or other sources) from the space within which the measurement is taken, and this can be analyzed for its effect either automatically by the analyzer performing a P-I index (pressure-intensity index) or by using a nomogram such as that noted in Figure 5 to consider 1 dB confidence limits.

While the intensity method is generally good at measuring in very low and negative signal-to-noise ratio conditions, negative ratios of P-I of more than -10 dB to -20 dB begin to affect the measurements accuracy.

In many cases of measurement, the operator will want to select a simulated plane or cube around the object under test, so that the sound intensity can be plotted along a geometric solid. The measurement of sound power is a case in point.

There are two different approaches to gathering intensity data along the

is important in determining both the basic setup and the screen range selection; if the range is somewhat limited, the vertical axis of the screen may be expanded for a higher resolution, lower dynamic range display. Additionally, if the dynamic range is limited, less averaging may be necessary. (Over some averaging period, the signal must be reasonably constant if the measurement is to be meaningful.)

The tolerance (confidence limits) of the measurement can either be preset, as with the 2133, or it can be determined by

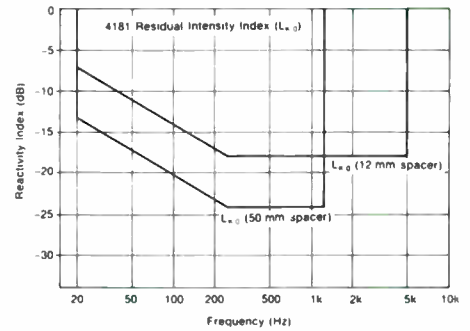

**Figure Five:
Pressure Intensity Index Nomograph**

measurement plane in question for sources with reasonably constant sound power output, the first being a sweep technique and the second being a point technique. In the sweep method, the probe is moved at a slow but constant

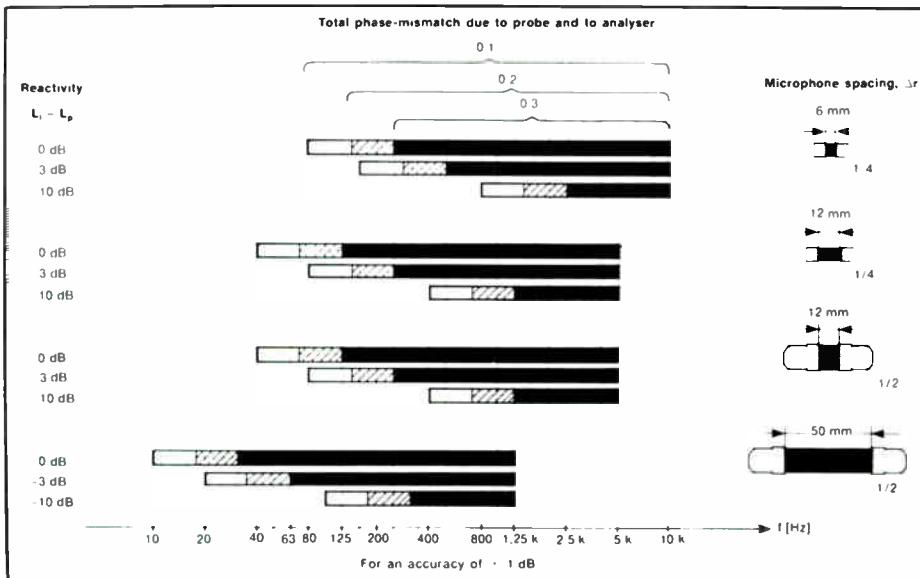

**Figure Four:
Ranges for Spacer Selections**

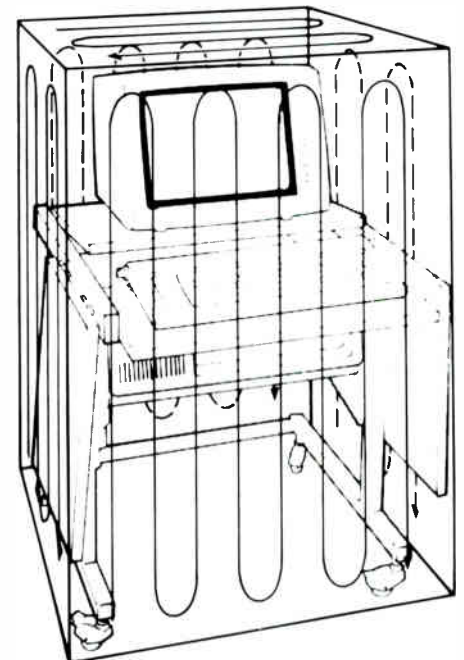

Figure Six: Intensity Measurement Sweep Technique

speed and swept back and forth through the area in question, never covering any portion of the area more than once. (Figure 6.)

In the point measurement, a set of points are defined along a grid which will represent the area well (determined by a

(continued on page 51)

Meet an
entertainer
who plays
all the best
nightclubs,
puts in a full
week of school,
and still finds
time to sing
in the choir
on Sundays.



Laser Karaoke. Only from Pioneer.

Suddenly, every facility is a potential customer once again. Because Pioneer has just introduced Laser Karaoke™, the newest and most phenomenal entertainment system yet.

Laser Karaoke is a one-of-a-kind sing-along system with music for all generations and every occasion. Music-video style pictures and superimposed lyrics immediately sweep everyone into the fun. And there are hundreds of hits for them to sing, all fully orchestrated and



reproduced by laser optics for lasting audio-video quality.



Laser Karaoke plays right into your hands, because it comes

as a complete system or as individual components.

Which means you not only expand existing systems, but your business, too.



To get in on the act, contact Pioneer Laser Entertainment, Inc., 22010 South Wilmington Avenue, #201, Carson, CA., 90745. Or call (213) 518-4531.

LaserKaraoke™
LaserKaraoke
PIONEER

Circle 207 on Reader Response Card

The IBMA Convention

New technologies are expected to generate the most interest at 1989's convention of the International Business Music Association. The annual event, held this year at the Marriott Mountain Shadows in Scottsdale, Arizona, takes place from September 20 through September 23. In excess of 300 attendees and more than 60 exhibitors are expected for the convention at presstime.

"We've had a great deal of response [to the convention] from a lot of new people in our industry," said Jerry Anderson, IBMA vice president and new member chairman. "We seem to have a lot of new member interest as well as established member interest.

"A lot of the focus will be on the new technology in our industry—direct broadcast, satellite programming, messaging and video conferencing—looking very closely at the new technology, aggressively pursuing the new markets." As a matter of fact, this new technology can be credited at least in part for the influx of new members to the Association. Many of the new suppliers that will be participating in this year's convention stem from direct broadcast data companies, said Anderson.

Attending the Convention will afford a chance to vote on Association policy changes. "We're going to vote on a change in the association by-laws," IBMA President Joseph Elum said. "It will basically limit the number of members on the board of directors according to their affiliation so [the board will be] more evenly representative."

Of particular interest to attendees will be a guest panel on business music usage. It will feature "a panel of operations people from different companies—from food to fashion—[in which] each one gives a presentation of the service or system they use and how they use music within their operations. It's very interesting to hear your customers tell you *why* they bought your service," said Michael Malone, an Association director. Other convention

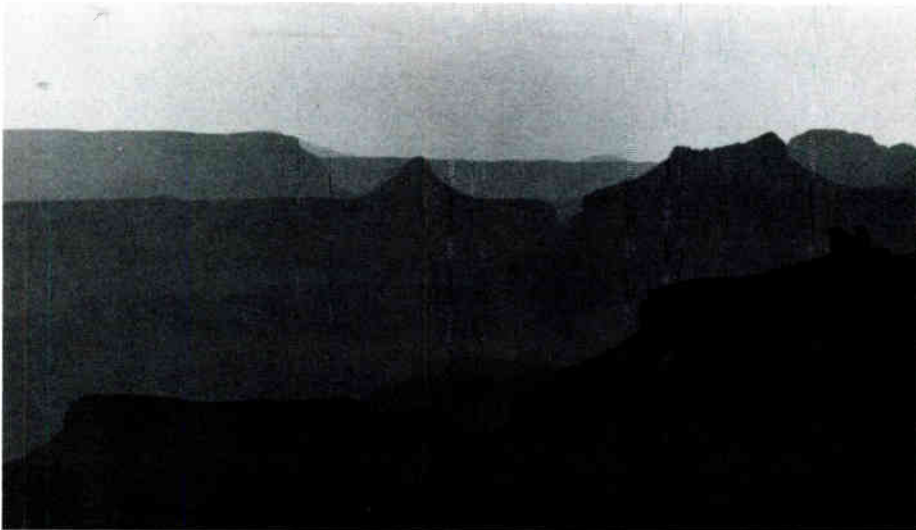

highlights will include a presentation by motivational speaker Rocky Bleier; Dan Hart's "Money In Your Office You Didn't Know You Had" seminar; and Mark Sanborn's "The Three Best Customers You'll Ever Have: How to Better Care For The People Who Really Matter," which is a combination of information and sugges-

tions for customer service, team building, and professional development.

There's good news for retired Association members who are no longer active in the industry: For \$100 yearly dues, they can retain their ties to the IBMA and its membership base, and be able to attend this and future conventions.

LETTER FROM THE PRESIDENT

(This letter from IBMA President Joe Elum was recently sent out to the Association's membership.)

In 1957 a group of independent background music operators started an organization to have a voice in dealing with ASCAP for a new contract as well as having a voice in changes that the FCC was considering with regard to FM stations and Multiplex. This organization functioned for a few years and did indeed negotiate a new contract with ASCAP. In the early sixties the National Association of Background

Music Operators was formed for similar purposes and it, too, lasted a few years.

In 1970 at a Seeburg Distributor's meeting in Chicago, Joe Hards and Dan Hart suggested that a new Independent Background Music Operators organization be formed. After the distributors meeting was over, we did form the Independent Background Music Association. Membership was limited, no Muzak or 3M distributors were allowed to be members.

As time went on there were many heated arguments within the association about including Muzak and 3M members.

The membership fiercely resisted all efforts to make this an industry-wide organization. They felt that Muzak had its own organization and 3M had its own organization, so that the independents should have their own place to talk freely without combatting the competition.

In 1976, Joe Bein, who had been president for a number of years, acquired the Los Angeles Muzak franchise and resigned as president. A year later Dan Lee became president and persuaded the membership that the music industry had changed during the years and the IBMA should expand to meet the need for an industry-wide organization. There were a few who still held to the fear that the organization would be taken over by an influx of Muzak or 3M operators, but the majority decided to take the chance and voted to open the membership to all members of the industry.

For the past ten years or so the IBMA has indeed functioned as an industry-wide trade association with the addition of a number of Muzak and 3M members. However, with the recent consolidation of music program suppliers it is almost impossible to find what might be called an "independent" other than perhaps Joe Elum, Randy Johnson, John Glans and a few others. Some few operators that have multiple music sources such as Walt Pridham and Keene Smith might still be considered as "independents."

During and after the last convention a number of members spoke to Dan Hart, Joe Bein and Joe Elum and expressed their feeling that the IBMA was splitting into self-interest groups. Dan Pfohl felt strongly enough about it that he sent a letter that was printed in the December 1988 edition of our Newsletter. In case you missed it let me quote it: "Now that our annual convention is over and I've had time to reflect on it, I would like to pose this question: Am I the only one who feels that the future of the IBMA is now, more than ever, at risk?"

"The September 1988 issue of *Sound and Communications* stated that this convention would provide those in attendance with the opportunity to 'network, to ex-

change ideas and information... an opportunity that is crucial given the current climate of shifting ownerships and alliances.'

"In my opinion, this past convention did not live up to those expectations. Excellent guest speakers and renewal of valued friendships aside, it did more to foster individual music supplier purposes and create feelings of acute alienation and discontent than it did to address the concerns and future directions of the business music industry as a whole.

"It is time we took a serious look at why we have this association and why, every year, many of us travel a considerable number of miles to meet. It's time, in my opinion, to re-establish our purpose and to do so we need to look to the past.

Am I the only one who feels that the future of the IBMA is at risk?

"The grass root purpose for the IBMA has always been and should remain to be an association through which members of the industry can share information that relates to a common goal — future betterment of their industry.

"Since 1980, when membership was opened to everyone regardless of their affiliation, this organization has truly been a trade association. However, certain feelings still exist that the IBMA is for non-Muzak operators. With that attitude maybe it should be for non-Seeburg or non-3M operators...well, I'm sure you can see where that would take us. Each major group of music dealers has the opportunity for their own association whose purpose is totally different. Somehow I feel we're losing the distinction between the two and it's up to the membership to bring things back into focus.

"We should not allow the two to become confused nor should we allow the purpose of the IBMA to change. Both should have their appropriate time and place in our business strategies. If we feel that it makes good sense to belong to one common trade group then we, as members of the IBMA, should do all we can to stop the tug-of-war that's taking place and ensure that our board of directors continues to take the organization in the direction that we want it to go.

"This association needs support and involvement especially now when its purpose is threatened by the major changes taking place. Not only does this mean continuing and encouraging a full, open membership policy for anyone involved in the business music industry, but also ensuring that a good cross-section of the membership is represented on the board — big and small, old and new, red, white or blue. That's my opinion, what's yours?"

At the IBMA Board of Directors meeting held March 4, 1989, Joe Bein raised the issue of Dan Pfohl's letter concerning the fragmentation of the IBMA and proposed an amendment to the by-laws to try to deal with it. The board felt the matter was of such importance that the entire voting membership should discuss it and vote on it. Therefore, we have enclosed a copy of the proposed amendment for you to consider. A vote will take place at our annual meeting on September 21, 1989.

Proposed Article VI, Section 2, part "d" amendment to the by-laws:

d. In order that the Board of Directors stay balanced in relation to member affiliation, the Board of Directors shall consist of the following:

- (2) Muzak affiliated members
- (2) 3M affiliated members
- (2) AEI affiliated members
- (2) Independent members
- (2) Directors Emeritus members, Joe Bein and Dan Hart

The directors' affiliation shall be determined by the largest percentage of customers billing in the above categories.

Our New QM-300 Series Speakers Are This Easy To Install.

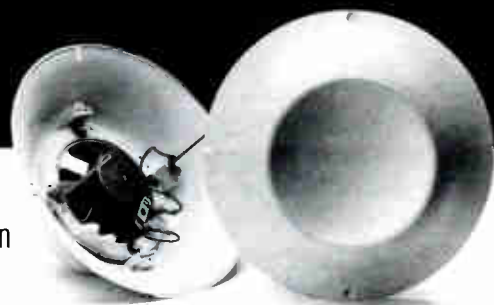

And almost as fast.

Simply push the twin metal mounting posts through any lift-out ceiling tile, then secure the QM-300 Series speaker in place with the Push-n-Lok® mounting system. The posts double as speaker leads, and special clips make wiring and installation one easy step.

What's more, you won't have to worry about panels sagging—thanks to the QM-300 Series' lightweight design. And when a system has to be taken out or moved, it's as easy as it was to install.

So put a ceiling on your installation time and costs. With the QM-300 Series speaker. For a complete listing of available sizes and features, ask your electronics distributor or contact GEMCO today.

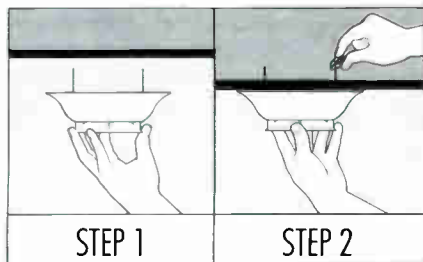

STEP 1

STEP 2

MADE IN THE
USA

To install, simply puncture ceiling tiles with the mounting posts. Then secure in place and connect speaker leads with our Push-n-Lok® retaining clips. To remove, reverse procedure.

 **GEMCO**

GEMCO Electronics, Inc. P.O. Box 993 Gallatin, TN 37066 615-452-5960

Circle 205 on Reader Response Card

World Radio History

CHANGE IS THE ONLY CONSTANT

BY SUZAN PRINCE

That "change is the only constant" aptly describes the current business music systems and software climate, both in terms of the technology and the marketplace. Because the widely scattered industry includes so many niches and diverse components—everything from SCA equipment to CD changers—suppliers say it's a bit impractical, if not impossible for them to try to project any cohesive annual sales results.

Crystal clear, however, is the expanding range of market growth opportunities just beginning to pop for manufacturers and sound contractors throughout the industry, largely spurred by R & D breakthroughs within select segments.

"There are such shifts in the industry in terms of who the players are and their market shares that it's a little bit difficult to ascertain how strong the market is," says W.G. Little, president of loudspeaker components maker Quam Nichols. "But my best guess is that the overall market is probably very strong."

The industry, he concedes, has experienced "incredible changes" in the last 12 to 18 months, "probably more than it has undergone in the previous 30 years. The players have changed; the products have changed; the delivery method has changed."

Little, like other executives, expects extended future growth to occur through additional product introductions that will "broaden substantially" the current spectrum of client offerings well beyond straightforward background, foreground, and environmental music systems and software.

Among such developments, suppliers are pushing full steam ahead into piggy-backing numerous ancillary data, video and audio communications services onto the backs of direct broadcast satellite systems

already used by clients to receive music programming.

"We have found a good, stable market for our DBS sound products and services that continues to grow," reports Rick Baker, 3M Sound Products marketing manager. He notes that direct broadcast is fast becoming a lucrative and variable

year; ahead of forecast." The company currently provides four popular categories of satellite-fed tunes to restaurants, retailers and other businesses that reap "significant advantages" in the system's simplicity of operation, sound quality and low maintenance, he says.

DBS users increasingly are choosing not

Suppliers are pushing full steam ahead into piggy-backing numerous ancillary services onto the backs of direct broadcast satellite systems already used by clients to receive music programming.

pipeline to existing as well as potential customers.

"That's what's so exciting about it. From our point of view, we see the opportunity to provide not only music, but messaging services and data services like E-mail, from point-to-multipoint and point-to-point using combined systems." 3M also offers audio messaging programs deliverable to satellite users with at least 50 to 100 locations.

"If you've got two stores, it doesn't pay to set up a data link via satellite," he adds. "But if you have 250 stores, then you may see some excellent savings in establishing a data link using a DBS system. And at that point, it certainly becomes economically attractive to use things like messaging via satellite and the advances that that offers, versus on-location systems. So we're seeing a lot of new opportunities out there for providing other services to customers, along with the music."

On the music side, Baker says 3M's DBS revenues are "especially strong this

to live by business music alone, agrees Leslie Ritter, Muzak's marketing manager. The company debuted several direct broadcasting add-on services in the last 12 months, including data communications and occasional-use video.

Muzak's 1990 marketing plans focus heavily on those products, as well as on the latest offering, ad parting. According to Ritter, all three primarily target large, multi-location outfits such as restaurant chains, retail stores and banks.

"We're finding that many of these major businesses that initially bought into the music services are now equally interested in expanding their systems' capabilities to include the adjunct services that DBS makes possible," she continues. For example, "In addition to our existing satellite products, we recently introduced 'ad parting,' or satellite-delivered advertisements that blend in with the music," she explains.

Especially for companies already heavily invested with high-end two-way data



The most reliable house keeper since Hazel.

It might be nice to have a little help around the house for a change.

Well, here's a hard-working, entirely capable volunteer for your house system. The new Yamaha PM1800 Professional Audio Mixing Console.

First off, the PM1800 inherited most of its features and capabilities from the legendary PM3000. So it's already got a lot going for it.

Most importantly, though, the PM1800 is remarkably reliable. Performance after performance. With system after system. Through pratfalls and curtain calls.

The design, just like its predecessor the M1500, is familiar in all the right aspects and improved in the others. Such as a unique transformer option,

so you can work with or without them. And wide use of internal jumpers so you can change signal flow just about any way you want.

Head for the nearest Yamaha Professional Audio Dealer to take a look at the new PM1800.

It's so reliable, it won't even ask for Thursdays off.

Yamaha Music Corporation, Professional Audio Division, P.O. Box 6600, Buena Park, CA 90622. In Canada, Yamaha Canada Music Ltd., 135 Milner Avenue, Scarborough, Ontario M1S 3R1.



YAMAHA[®]
Engineering Imagination™

Circle 206 on Reader Response Card

World Radio History

systems, Ritter contends Muzak's one-way, or point-to-multipoint DBS system can effectively enhance the use of existing configurations.

"There's a lot of information transmitted over expensive two-way data systems that is really only one-way data," she says. "Think of your 'in' basket and the number of things that you look at, absorb and file, or maybe throw away after you've read. For somebody who's already using a two-way system, point-to-multipoint data communication is good for that kind of application."

Companies should be able to justify the one-way transmission system's cost, she adds, "Because it's all accomplished through a single, integrated system—one satellite receiver, one antenna, with very little else required in the way of equipment."

Recent advances such as the development of small UHF antennas allow DBS installers to achieve very high quality sound throughout the installation site, notes 3M's Baker. "UHF is really today's frequency of choice in that it allows you to use quite a small antenna—typically .75 to 1.2 meters in diameter, or about two to three feet overall—and still draw in a good signal."

Proper UHF installation is critical, the manager cautions. "You have to check and double check to make certain it's properly installed and focused so that it picks up and gives you a good, strong signal." Assuming the installer has done his job correctly, the powerful, 15,000-Hz broadcast signal will yield "excellent quality music" throughout the building, Baker adds.

Of course, the marketing exec notes, "It certainly doesn't make sense to pump excellent-quality music through a middle-quality speaker system. If you're working with a client who truly desires the ultimate in sound quality, one issue you'll definitely want to explore with him is the upgrading of the existing speaker system."

That, he suggests, is how step-up sales are made. For example, "If you're feeding
(continued on page 50)

HIDDEN HARDWARE: PRODUCTS TO HEAR AND HIDE

As in any part of the music business, the background/foreground market takes in both hardware and software. While companies like AEI and Muzak battle it out, hardware manufacturers continue to produce all the accoutrements necessary for reproducing music: amplifiers, tape players, newly popular satellite dishes and, increasingly, speakers. Loudspeaker companies are increasingly becoming attuned to the needs of the business music market and the current desire for looks as well as viability.

In-wall speaker makers are making more noise — and sound — in the market, as new product introductions about. For instance, Boston Acoustics recently enhanced its in-wall speaker system with its new In-Wall Enclosure, which the company says provides a more secure mounting surface than is possible with wallboard alone, and reduces sound transmission to the back wall. The omnidirectional PowerVent 12 is a separate subwoofer for custom-installed speaker systems. It requires a one-inch clearance for its vent holes.

Bertagni Electronic Sound Transducers (B.E.S.T.) of Cerritos, California, says its transducers reproduce the full satellite bandwidth's extended frequency response with 180-degree uniform dispersion at all frequencies. This results in fewer devices required to cover a given space, says B.E.S.T.

As for amps, Bogen Communications is producing the D Series of modular amps, self-contained units that fit on a shelf or can be mounted on or in a wall. Twenty-, 40-, 80-, and 160-watt versions are available, with plug-in module options. The



Blonder-Tongue's MAM Audio Modulator

weather-resistant FG-10 speaker features a built-in transformer for matching 70V lines, and a universal mounting bracket.

The MAM audio modulator from Blonder-Tongue is an all-solid-state heterodyne unit that provides an unmodulated visual and a modulated aural RF carrier output on any one VHF, midband, or superband channel. It can be used to put

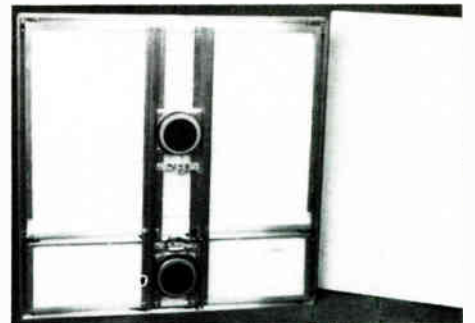

B.E.S.T.'s CT72D transducer system.

sound on any unused channel of a closed-circuit MATV or SMATV system. A monaural FM band version with increased audio deviation and a suppressed visual carrier is also available.

The business music market is of course bigger than any individual product. Business music is an environmental controller, a mood processor. And each piece of the hardware is chosen for system suitability.

—Editor

THE AMERICAN ALTERNATIVE



For decades the Peavey name has stood for superb audio, reliable performance, and outstanding value. This American tradition continues with the introduction of a broad range of audio products specifically engineered for fixed installation... Peavey Architectural Acoustics™. The benefits of our years of audio experience and product refinements are now available to sound contractors everywhere.

At Peavey, quality is not just another trendy buzzword. It's a hard, quantifiable fact. Throughout the entire purchasing, assembly and shipping process, skilled technicians monitor the performance and reliability of our products against the toughest standards in the industry. It's no accident that every day our products reach new heights of excellence.

While other companies come and go, Architectural Acoustics has the unyielding Peavey commitment to customer service and follow-up support. Year after year, you can depend on Peavey Architectural Acoustics.



PEAVEY™

ARCHITECTURAL
ACOUSTICS™

Circle 215 on Reader Response Card

A DIVISION OF PEAVEY ELECTRONICS CORPORATION 711 A Street / P.O. Box 2898 / Meridian, MS 39302-2898 (601) 483-5365
Telex: 504115 / Fax: (601) 484-4278

World Radio History

©1989

A TWO-WAY CHURCH SYSTEM

A compact new signal-processing system at Salem Baptist Church (Jenkintown, PA) provides hands-free operation and two sets of mixes, one for the house speakers and one for line transmission and recording.

Having recently paid off of its building mortgage, the church had the funds to bring about a long delayed upgrade of its sound. The upgrade cost was \$26,000. It is designed to carry the strong preaching and powerful choir vocals which are characteristic of this congregation.

There are two mics on the podium (at the lectern and pulpit), two over the choir, one at the baptistry and one on the ceiling, where it picks up a sense of the room's ambience for the line mix (not the house mix). Two mics are wireless, one lavalier and one hand held. Eight open mic outlets provide flexibility for choral groups and soloists. A speaker array is suspended near the front; further back, a delay-fill horn is suspended. Two monitor speakers face the 50-voice choir.



An exterior view of the Jenkintown, Pennsylvania house of worship.



The Salem Baptist Church is a place of both moving sermons and strong choir vocals.

The purchasing committee had envisioned a system with a complicated mixing console, said L. Richard Feld, president of TekCom Corporation, Philadelphia,

The system is real-estate effective as well as cost effective.

which designed and installed the new system. "But I explained that hands-free operation would be more up-to-date and practical. Few congregations have cadres of technical people who can operate audio

Ceiling Dynamics

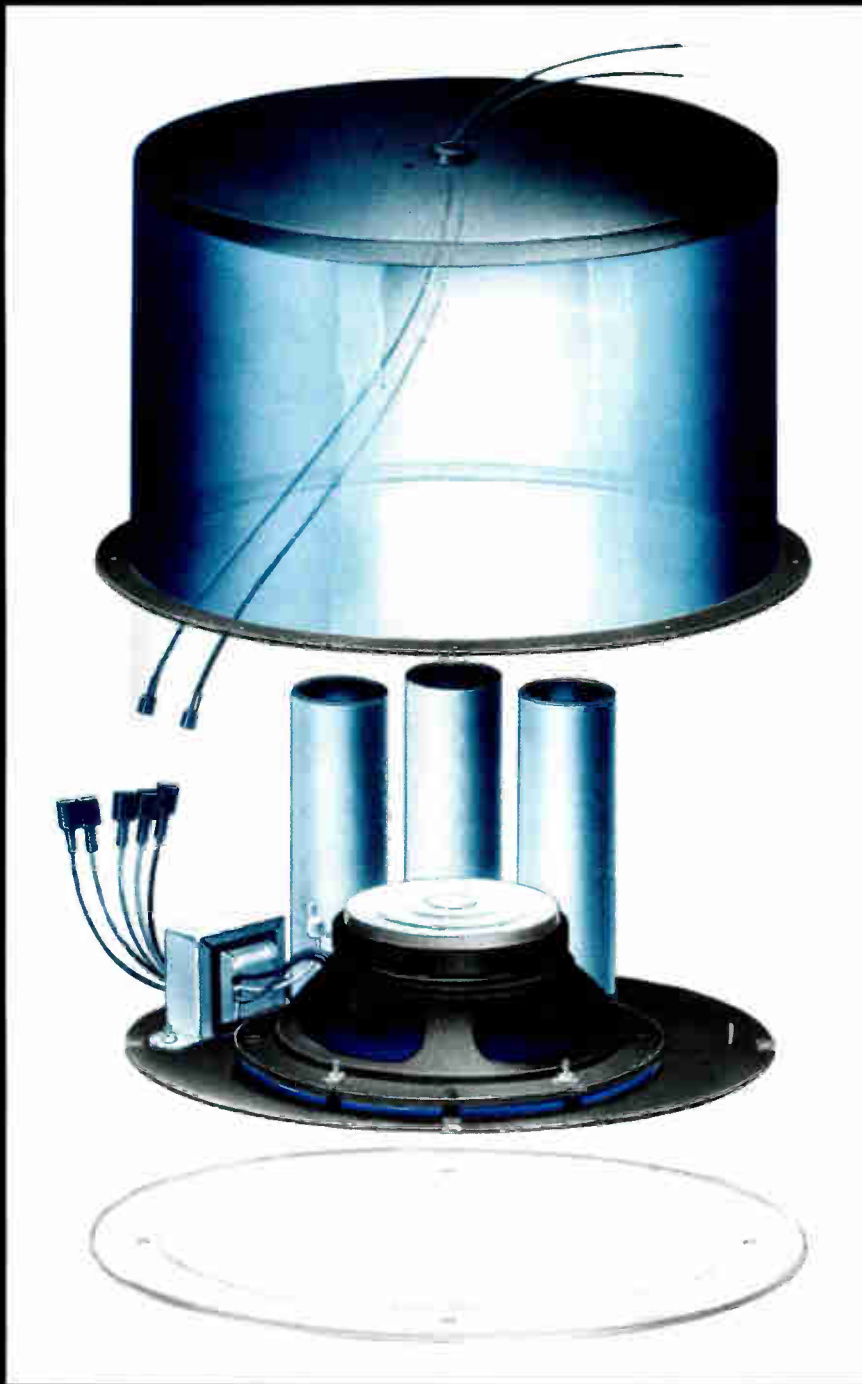

Pro-Sound Quality for Recessed Distributed Sound Applications

EA Series 8" diameter ceiling loudspeaker system delivers high fidelity sound for foreground music and paging in:

- Restaurants, nightclubs, lounges
- Stores, malls, commercial buildings
- Meeting rooms, hotels, convention centers
- Airports, bus terminals
- Sports and recreational facilities

It combines the technology of professional acoustics with the convenience and architectural integrity of conventional ceiling installations.

The 50 watt loudspeaker system consists of a high performance 8" dia. low frequency reproducer and a 4" dia. high frequency piezo transducer housed within a ported bass reflex ceiling enclosure which achieves optimum response and system resonance. It requires no proprietary electronics.

EA Series is aesthetically pleasing, cost effective, and the new performance standard for high quality distributed sound systems from:

 **ATLAS / SOUNDOLIER**

ATLAS/SOUNDOLIER DIVISION OF AMERICAN TRADING AND PRODUCTION CORPORATION
1859 INTERTECH DRIVE / FENTON, MISSOURI 63026 U.S.A. / TEL. (314) 349-3110 / TELEX: 910-760-1650 / FAX: (314) 349-1251

Circle 216 on Reader Response Card

consoles. The solution is automatic mixing. The state-of-the-art solution is modular.''

Automatic mixers process the signal that drives the house speakers; line mixers process the broadcast signal. The church's mixers, level controls, a 29-band equalizer,

a 5-notch filter and a buffered distribution amplifier were all modules of the industrial Research Products, Inc. System 41.

For the house mix, four DJ-4114 Voice-Matic microphone-mixer modules feed their summed signal into a DJ-4115 Voice-Matic master. Automatically this gates off

Are you getting everything you can out of the business music industry?

**The IBMA is!!
Make a SOUND investment
Join The Professionals!**

IBMA represents every facet of the background music & sound contracting business. Membership opens the channels to direct, two-way communication with other top professionals. We are, as a group, dedicated to exchanging ideas, helping each other benefit from our collective experience, and keeping each other informed of the latest trends and developments.

- Your direct line of communication.
- Your quarterly newsletter.
- Your business seminar.
- Your sales and sales management workshops.
- Your trade show representative.
- Your manufacturer contacts.
- Your voice in the legislature.
- Your annual business convention.



Circle 254 on Reader Response Card

For IBMA Membership Information call:
Jack Beattie, Vice President & New Member Chairman
(408) 436-1570

Associate membership is also available and manufacturers of equipment and supplies related to our industry.



This rack features the Tandem IRP System 41, which was crucial to the Salem Baptist Church installation.

the inactive mics and turns on the active mics, thereby minimizing background noise and maximizing gain before feedback. For the line mix, pre-gated mic signals are fed at summing level to four DJ-4113 line-selected mixers.

The house and line mix both feed a DJ-4138 dual Level-Matic master module, which automatically adjusts two different master gains. Its line-mix output goes directly to a DJ-4118 buffered distribution amplifier. The distribution amplifier feeds the radio station, a cassette recorder, a reel-to-reel recorder, and an amplifier in the fellowship room, where people come when the sanctuary is full. There, too, they can participate in the service, which

they hear on column speakers and see on TV monitors.

The Level-Matic master module's house-mix output goes through a DJ-4117 transversal equalizer (which provides 29 bands of equalization on 1/3 octave centers) and a JBL 7922 delay unit. The delay unit has an undelayed output (amplified by Crown PS200) which goes to an enclosure 18 feet above the floor and slightly to the front of the chancel. This JBL 4660 enclosure contains a 15-inch direct-radiating low-end and a horn-loaded high-frequency device.

The delayed output, through another Crown PS200, channel powers a JBL 2344 bi-radial horn with a 100x100-degree pattern. The horn is about two thirds of the way to the rear of the 85-foot-long room. In another mixing-system output, which bypasses the Level-Matic module, the house mix is notch-filtered in a DJ-4106 module on its way to the two Bose 402 choir monitors.

Because of gain-before-feedback problems, Feld said it was necessary to install new mics at the pulpit and the lectern. An Audio Technica AT857QM is now used in each of those locations.

There are 13 System 41 modules, some of which take up more than one of the 13 mounting spaces in the 10.5-inch-high mainframe, DJ-4100. Feld had to use an additional mainframe. Even at that, he found, "the system is real-estate-effective as well as cost-effective." To tune the system with the DJ-4117 transversal equalizer "took me much less time than it does with a traditional third-octave equalizer." This is his company's first System 41 installation. "We expect to install the next one in half the time, now that we're familiar with it."

(Acoustical Consultant Jesse Klapholtz calculated the reverberation times and recommended the devices and their locations. Gayle Campbell, and Industrial Research Products engineer, suggested the layout of the System 41 components.)

Specify the Best...

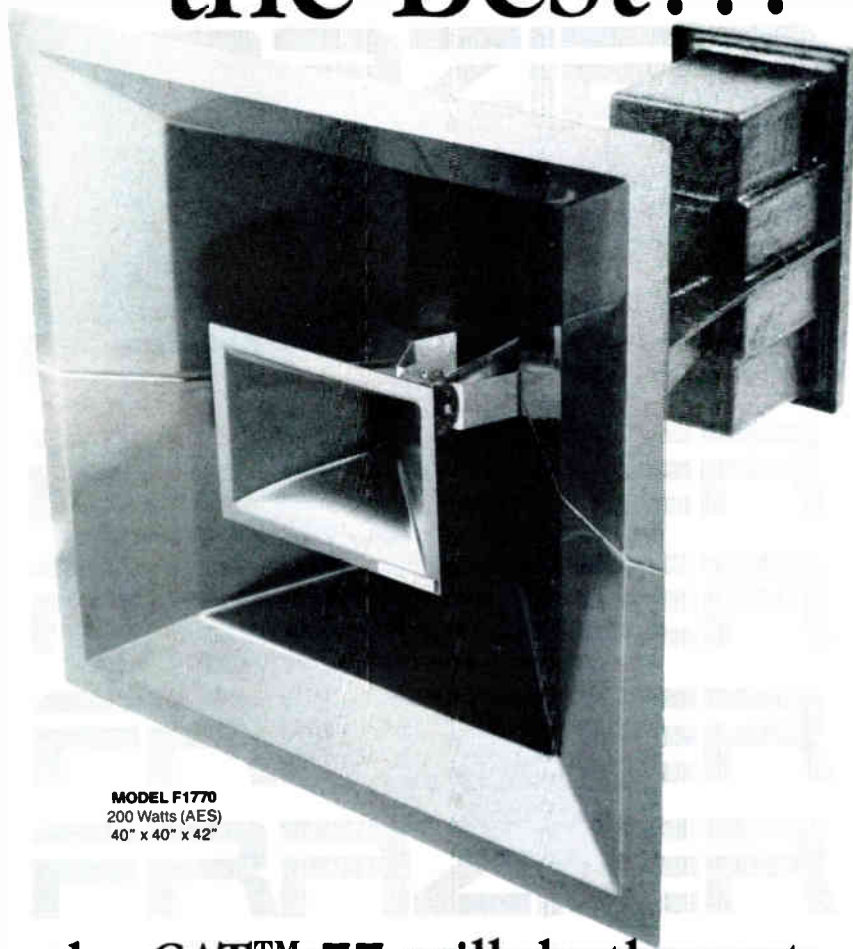

MODEL F1770
200 Watts (AES)
40" x 40" x 42"

the CAT™ 77 will do the rest.

- Lightweight—under 90 lbs.
- No external crossover or delay required
- Factory assembled and tested
- Isobar tabular data available for PHD/CAD PROGRAM™
- CAT™ Design—Coincident Aligned Transducers
- Weatherproof housing
- Reinforced mounting points included
- Internal transformer compartment

If natural, intelligible speech reinforcement is important to your customer...FAX or call TOLL-FREE NOW for complete data on this important new FRAZIER system.

FRAZIER

Route 3, Box 319 • Morrilton, AR 72110
(501) 727-5543

Toll Free 1-800-643-8747 • FAX (501) 727-5402

Circle 240 on Reader Response Card



Innovations In Communications™

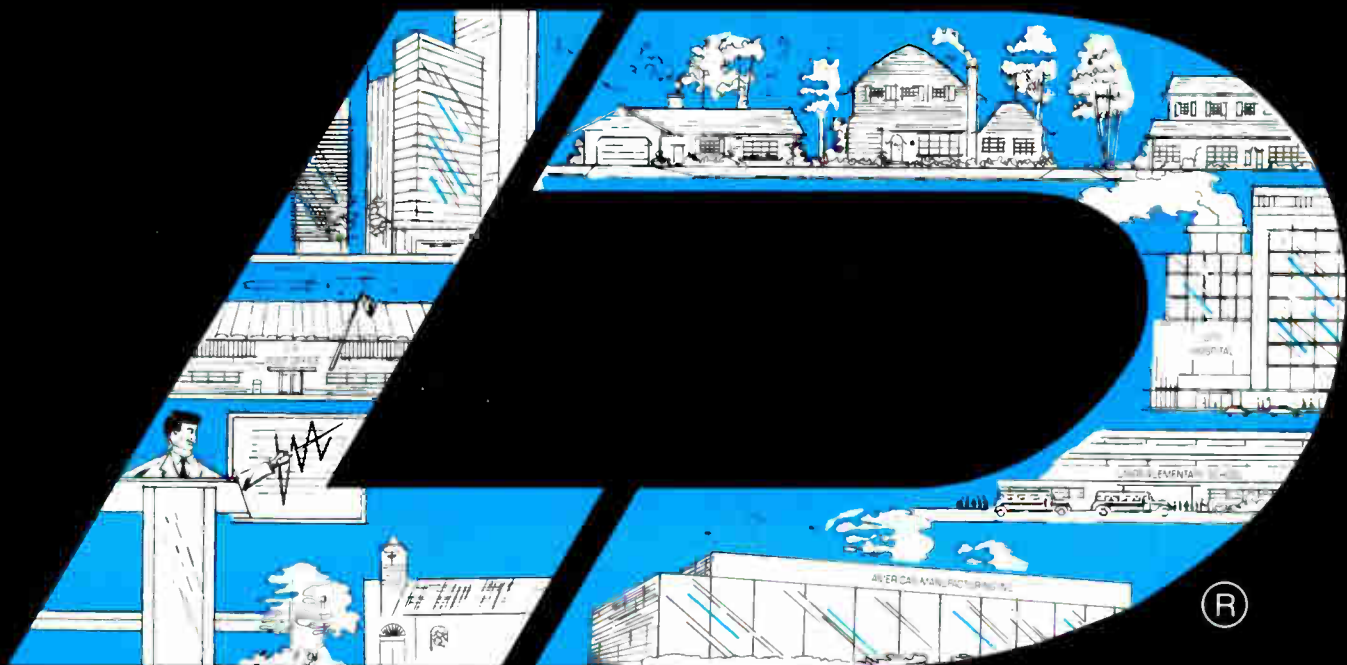

Since 1955

Wherever people have the need for better communications, safety and convenience, you'll find a **LEE DAN®** intercom system hard at work.

For over 34 years, we've been manufacturing intercoms for homes, apartments, townhouses, offices, factories, schools and hospitals. Our experience can help you turn a complicated specification into a simple, profitable solution.

Our large product line, teamed with our quick, affordable, customizing abilities, can help you meet your equipment needs, schedules, and profit margins.

Next time you need an intercom, call **LEE DAN®**. Our sales staff will assist you in equipment selection. We'll provide a detailed written quotation (not a lump sum price) with literature, spec sheets, wiring information, and anything else you need to put together a great system and a winning proposal.



Circle 208 on Reader Response Card

We're here to help. Call us toll-free.

N.Y. (800) 231-1414 (516) 231-1414
U.S.A. (800) LEE DAN-1 FAX (516) 231-1498
155 Adams Avenue, Hauppauge, New York 11788-3699

INTERCOMS • NURSE-CALL • MAILBOXES • DIRECTORIES • ANNUNCIATORS • WIRE & CABLE • CCTV

World Radio History

HEALTH CARE COMMUNICATIONS

At the NSCA convention in May 1989, Sound & Communications sponsored a panel discussion on microprocessor nurse call systems. Panelists were: Steve Deppe and Ken Lind of Dukane; Ken James of Rauland Borg; Tom Hendricks of Tektone; Robert Shipley of Fisher Berkeley; and contractor Ron Rosen. Bill Intemann of Sound & Communications moderated. An edited transcript follows.

Intemann: Welcome. This morning we will be addressing the issue of technological evolution and what impact it's going to have on health care communications. To begin, Steve Deppe is the chairman of the hospital signaling group in National Electrical Manufacturers Association (NEMA). Steve, can you say a few words about the work that this organization is doing?

Deppe: The NEMA Hospital Signaling Group was formed approximately five



Steve Deppe

years ago to have an industry voice in what was happening in hospital signaling equipment, so that we could present a unified stance on legislation, on things that were happening in the industry, and move forward together. To that end it has worked out well. We work very closely on things like standards, UL1069, the Life Safety Code NFPA101. We try to anticipate how changes might affect us and frankly have a lot of input into what would be good for our industry and good for the end users so that we're moving together professionally. It seems to me that the microprocessor itself is a tool that can be used within a nurse call system or any type of signaling system or communication system. As far as the state of the market, the issue to me is: What is the most cost-effective solution for the end user? And that probably will dictate what is going to be the technology and the product of choice. As technology has evolved, I don't think there's any question that microprocessor technology will be, if it isn't already, the most cost-effective solution.

As the industry has evolved from electromechanical components to discrete solid state components to microprocessor components and now further miniaturization and more software-driven technology and software-driven product, each of those changes has brought with it what I call technological discontinuities. Whether it is the design engineering point, the application engineering part of the business, the service part of the business, the installation part of the business or the end user part of the business—all these areas have been affected by these technological discontinuities. We've just got to keep up with it.

We have a responsibility to train whoever it is that is going to be using this product. Everybody along the way has the same responsibility to understand these products. And that goes for the installer,

whoever that might be. It's not always the sound contractor in a case of health care systems. But there's also a responsibility for the end user. And part of our job, I believe, as manufacturers and as distributors, sound contractors, installers, servicers of the equipment, is education of the end user as well. What are these technologies? What are the strengths? What are the limitations? And what will the end user have to change at his end in order for us to be successful together?

There is one other point. The health care portion of the business that we get involved with is the most difficult portion of the business that we are in. It has the highest entry barriers to success of any of the segments. Because of the large number of codes and regulations which we have to watch as manufacturers and you have to watch as installers, it has without question the highest liability of any of the products that we get involved with. The

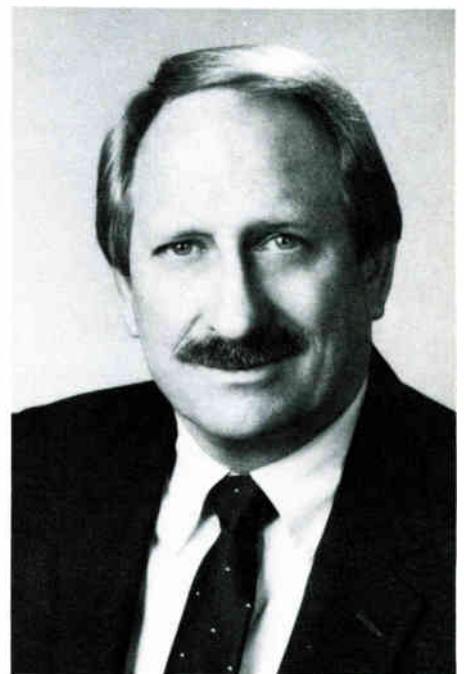

Ken James

point is that it takes a long-term look for this kind of business—from a financial standpoint and from a training standpoint and commitment standpoint—in order to be successful on a long-term basis.

Intemann: Ken James, you've been involved in this for a while. Would you agree with Steve that commitment is very important here?

James: All the manufacturers that I know in this business are unanimous on most of the general issues. I'll give you some brief points that are really important to us at Rauland Borg.

First of all, Steve mentioned commitment. And he mentioned that the health care section of our market place is almost isolated in its own uniqueness. And some other points he made are absolutely true. Right now the manufacturers represented here are facing enormous new investments to embrace the new technology that is on the horizon. We're retooling. And I'm sure the other people are doing the same thing. Surface mount technology is coming into our factory. And the buzzword you keep hearing again and again and again is ISDN. That's four short little letters but it's a



Kenneth Lind

New Hospital Communications Products

Hospital communications takes in a broad range of products and concepts, from an individual handset to a full-blown intra-facility communication system, from an enormous teaching hospital to a small nursing home facility. New product announcements that cross our desk are becoming both more specific and more flexible as manufacturers pay attention to changes in the market and in technology.

- Jeron Electronic Systems has introduced a microprocessor controlled nurse call system that displays all calls in the system at once. The AV-680 features multiple masters, four simultaneous voice channels, and 29 levels of priority.



Jeron's AV-680

- Diversatronics' latest AC multiplexed system, the CS2000, offers an LED master panel in each room for "instant" location of personnel and traffic control throughout the office. The system is completely programmable, and is available with an optional telephone intercom.
- The Florence Communicator A/V nurse call system from Florence Corporation consists of master station, control unit and remote stations. Among the master station's features



The Florence Communicator

- are: annunciation of normal and emergency calls; audio communications with remote stations; single-button station selection, etc.
- Atlas/Soundolier's door monitoring system was designed to detect unauthorized exit/entrance in secured areas within institutional and industrial establishments and to provide immediate audible/visual annunciator-alert at an assigned supervising position. The system will monitor doors and windows, stairwell access, laboratory and treatment areas in institutional facilities.

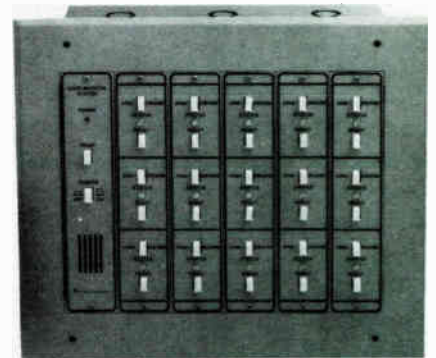

Atlas/Soundolier's Door Monitoring System

- The ProCare 2000 is Dukane's micro-
- (continued on page 40)*

whole new universe.

If I could give one piece of advice, I think I would say to read everything every day. Technology that affects our business is almost all electronic. Stay abreast of general technology. There's no other way. There's no other place. You can't just go to a meeting like this once a year and sit in a presentation like this for an hour and go away with everything you've ever needed to know about nurse call but were afraid to ask.

Microprocessor technology in the nurse call portion of the health care industry is about 10 years old as far as practical applications. We're evolving as we speak to the next level. But we have all been in an environment that is very, very hostile to our industry.

Our customers are absolutely the most difficult people you will ever deal with, and anybody in this room who has sold and serviced hospitals any time at all will agree with me. Not only are they demanding, but the environment itself is very hostile. The three of us on this side of the podium have fought unbelievable battles over UL1069 and unbelievable battles with hospitals—and individually with our own distributors—over ESD [electrostatic discharge].

A typical hospital room, because of staph infection issues, has a humidity environment kept very low to prevent the transmission of infection. Any of you who have ever seen that big blue spark snap your microprocessor know that low humidity contributes to the ESD phenomenon. In our own laboratory and on job sites, our engineering department has measured ESD in excess of 100,000 volts coming off the bed and going up our call cord into our nurse call station.

We should not be expected to protect ourselves against an unconscionable environment of that type. Our equipment should be able to stand 25,000 volts of ESD; beyond that the hospital has a problem. They're going to have to help us modify the environment to a point.

I don't think any of us really knows where the marketplace is headed because the hospitals embrace technology faster

than we do. Go into a typical acute care hospital for 500 beds, and you'll see space age electronics up and down every corridor. Stuff you don't recognize. Brand names you never heard of. That keeps us

running at breakneck speed, just to understand what they really want. At the same time that these people buy leading edge technology, they are also very demanding customers. And if you're not ready to send

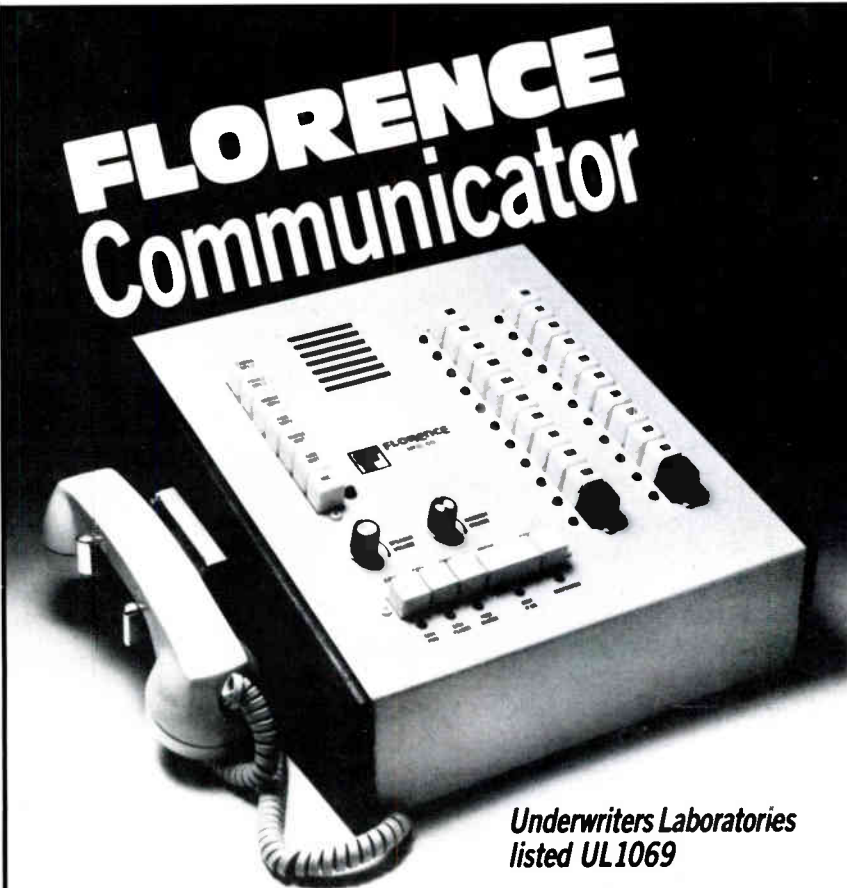

Underwriters Laboratories listed UL1069

Audio Visual Nurse Call System

Features of the Master Station

- Annunciation of normal and emergency calls
- Audio communications with remote stations
- Visual display of calls
- Convenient, single button station selection
- Room numbers on button caps
- Group page
- Call forward
- Call hold
- Tone silence
- Press-to-talk bar
- Call cancel
- Handset for privacy with voice switching
- Listen controls for handset and speaker
- Panel speaker-microphone

FOR CATALOG CALL, FAX, WRITE

FLORENCE MANUFACTURING CO.
A UNIT OF FLORENCE CORPORATION

2101 N. ELSTON AVENUE, CHICAGO, ILLINOIS 60614
312-384-3310 • FAX-312-384-3460



FSR inc.

LEADERS IN:

- Hotel Ballroom Combining Systems
- Digital Boardroom Control Systems
- Teleconferencing Equipment
- Remote Control Modules For All Audio Visual Equipment
- Deluxe Conference Room Floor Boxes
- Custom Panels
- Custom Engineering
- Audio & Video Switching Units
- Infrared Control Equipment

FSR inc.

creators of innovative
products for AV systems

220 Little Falls Road
Cedar Grove, NJ 07009
201/783-3966 ■ 201/239-0988

COMMUNICATIONS

a qualified, capable person to that hospital to do in-service training on your equipment for a 24-hour period on the weekend, and come back in the middle of the week again at 2 a.m. to pick up the people whose shift was such that they weren't present for your in-service training, you're just leading with your chin. The people who use this thing are being overcome by technology. They don't read the manual. If you don't make your equipment user friendly for them, you've got a real problem.

What's the bottom line? This is not a business that runs on low markup. You'd be surprised how many people think that they can pick up a product line and run out and do a job and mark it up at 1.5 and come out. It doesn't work that way. You might get by with it for a little while but it doesn't work that way in the long haul. You must be professional. And to be professional, you have to be profit-generated. You also have to treat your customers in an absolutely professional manner to overcome the obstacles that we're talking about.

One other issue I would raise before I give up the microphone is the product liability issue. Product liability is a major issue. All you have to do is pick up the newspaper or pay your product liability insurance premium, and you'll find out it's a major issue. It's a really difficult one for manufacturers but it's even more difficult for individuals such as yourselves because you're the actual people who tie the wire to the equipment, turn on the switch and hopefully make it work.

The product liability issues in a hospital are compounded by the obvious. And you just must be prepared to deal with it. You need good heavy product liability coverage; you also need good well trained experienced installers putting this equipment in simply to keep your liability down. Never, never fall into the trap that one of our distributors (who will remain unnamed for obvious reasons) fell into about three years ago. He got conned by a hospital administrator into installing the system, micro-processor based, in occupied patient rooms. He was literally stumbling over the patient to pull wire and screw things to the

wall. The system failed. In the middle of the night a 72-year-old woman couldn't get a nurse, she got out of bed, fell and broke her hip and her lawyers are still making money off of it.

The real issue here is to listen to your manufacturers, read and study the manuals, use experienced, capable installers and be prepared, in every case, to do the homework required to make the customer happy and the product work well.

Your manufacturers to a man are very cognizant of these issues and will support you in every way they can, but all of us up here sell through independent distribution simply because we don't want to run factory stores. So that leaves the primary efforts in your hands.

Get the right technologies going, because we may not have a nurse call system as we know it in the next few years. Hospitals are embracing computerized information systems on such a scale that we may in fact be part of a communications ladder or bus or pathway, if you will, throughout the hospital. We're talking about one that's all encompassing. Things like automatic patient charting through electronics are probably going to be accomplished in not too many more years. Just think about that for a minute. The nurse never has to go to the room to take the patient's vital signs, and when those vital signs are taken they're automatically transmitted into a computer file and called up—in some type of CRT or printout or whatever—as an information system. The technology required to accomplish this just boggles your mind.

Intemann: Bob Shipley, Steve mentioned that you've been working with the OSHA requirements. Maybe you can tell us something about that.

Shipley: It's important from the standpoint of risk management that would be clear to anybody who has watched a lawsuit, whether it's been in nurse call or not. If a hospital has an injury because a 72-year-old woman falls because the nurse call didn't work and she had to get out of bed to get help, certainly there will be a product liability suit. The hospital will be

the first one named. The installing contractual chain will all be named and of course the equipment supplier will be named. If one has to defend oneself and the plaintiff's attorney is good, you're going to be answering the question: Does your equipment conform to American National Standards? Is there a National Standard in place? If so, was this tested by a third-party independent testing laboratory that's nationally recognized? If you have to make the embarrassing response that no it isn't, you're probably not going to pass the bill and will spend a lot more than \$200. Another salient question is how important is the listing? It's required by law. Federal law requires that nurse call equipment and a lot of other equipment that appears in hospitals be listed by a national recognized testing laboratory. And that's part of the code of federal regulations Title 29 CFR Section 1910 Subpart S. It's not legal to install equipment that is not listed by either Underwriters Laboratories or, as of just recently, MET Electrical Testing. Those are the two laboratories that are nationally recognized to test this type of equipment; the standard to which it's tested is the ANSI standard UL1069.

So, I guess between product liability and law, the results are, if the hospital is cited, it is the hospital's burden. But hospitals, as Ken noted, tend to hand the problem back down the line to you and to the manufacturer. So if you sold the hospital a bill of goods, and the equipment is not UL listed and the hospital is cited and they have to close nursing units because the equipment isn't listed, they'll probably look to you for some sort of compensation.

NEMA as a group has been working with Underwriters Laboratories, and with OSHA. The Department of Labor has just issued a formal ruling on that subject.

The market factors that alter the direction of the products are many and varied. We have more control over some than others. The performance standards cannot be met if the equipment is not designed and installed correctly. UL1069 has just been reissued, republished. One of the things that each of our companies has

done is to try to facilitate the latitude inside of 1069 to design and manufacture equipment that will facilitate the future pipelining of information—the connection of other ancillary information systems in a safe manner. And certainly that would argue for continued use of microcomputers, microprocessor-based products and other LSI custom-integrated circuits.

Construction is another influence that is more difficult for the manufacturers to get control of. But construction techniques—the types of cabling systems, where the cables are run with what they're run, the tendency away from rigid metallic tubing which provides electromagnetic shielding as well as mechanical protection—influence your costs and influence the way we review the design process.

Hospital costs are probably the single biggest influence on the direction of the

marketplace. If the hospital costs are largely labor, as they are right now, anything that can be introduced that lowers those labor costs gets reviewed by the hospital as something that they want to make their capital investment in. Naturally, each of us pays very close attention to hospital labor costs and things that we might do through you to reduce costs.

I guess the last area of major influence in the direction of the market is the GATT Treaty. The GATT Treaty will be enforced in the early 1990's. And what it does is to remove unilaterally all barriers to trade. We can no longer say to the European market, "You must build your stuff to install in electrical black boxes." That is illegal according to federal law effective starting in 1990, and phased into our business over the next two years. From a manufacturer's perspective it also uni-



JERON

One screen shows all!



- Microprocessor controlled
- Multiplexed operation — no home runs
- Simultaneous display of all rooms
- Full sentence instructions on-screen

CALL TODAY OR FAX FOR MORE INFORMATION!

JERON ELECTRONIC SYSTEMS, INC.

1743 W. Rosehill Drive Chicago, IL 60660 (312) 275-1900

Call us: 1-800-621-1903 FAX us: 1-312-275-0283

AV-680 Nurse Call

J-9-3

laterally opens up Europe, and they've been very effective at putting up artificial trade barriers that make it difficult for us as manufacturers to export.

But as it impacts you and your business we can all expect that there will be a greater availability of greater diversified products, products that were designed not for our marketplace but which our marketplace will be legislated to accept, starting in the early 1990's. That will influence our design process and the products that we will make available to you. It will also influence you and the way that you need to compete in the bidding process. It changes the way that we're all used to doing business.

The direction of technology is likely to incorporate more and different functions into singular communications systems, so the tendency is not to view oneself as a nurse call manufacturer but rather a communications manufacturer, and as communications installers and contractors.

I would agree with both Ken and Steve there's profit to be made, it's a good business to be in, but only if you are committed to approaching it in a professional manner, if you're there for the long haul, if you're willing to spend time with the hospitals. Hospitals have to be held, have to be nurtured.

The nursing staff can be your biggest headache or your strongest supporter. The installation work can be exactly the same, but if you don't support it with in-service training, if you're not there to answer questions and make sure that they know how the equipment is supposed to work, what it will do for them, how it benefits them, how it makes their jobs easier, you've developed an enemy who creates service calls for you and just eats you alive. What profit you had in it will be gone in a matter of months. And certainly, the liability issues over not training someone are very great.

Intemann: That would be a good point to bring Ron Rosen into this discussion. Ron's written about hospital communications and has been involved in the field with these kinds of systems for a long

time. Ron, maybe you could give another point of view of how these systems work in the field and what your experience has been.

Rosen: A couple of years ago I wrote a guest editorial for *Sound & Communications* defending—passionately defending—the microprocessor nurse call system in response to a letter that a manufacturer had written. And I still believe very strongly in that type of equipment. In addition to writing I am also a health care contractor within the state of New Jersey and I manufacture a temporary wireless system.

Yes, this technology is cost effective. It can be very cost effective. And I think that first of all we have to analyze the per-bed costs.

If you've handled both microprocessor and manual systems, you know the microprocessor becomes very cost effective as the number of beds increases. Based on a bed, technology is not too terribly cost effective at the low end. There are advances being made there.

Technology has become a lot more user friendly. There's a lot of resistance in the nursing community; there's no question about that. If you really analyze it, if you spend time at a nursing station and see what the nurses do and speak with nurses. We can say, "Yes you have all of the rooms come up during digital display." They say, "Well, I want to see every room get a call at one time." "Well, you can scroll through." "Well I don't want to scroll through." "Okay." "I'm used to the old way where we have a button." Okay.

I believe sincerely that there will be a place for a form of electromechanical system, if that's what the customer desires. As well as the more technologically advanced microprocessor systems.

The microprocessor does some great things that are not possible in an electromechanical system. There is a lot of integration, a lot of combining, networking, being able to program one system to take over one or any number of others.

We touched briefly on the static problem. It is a problem. I don't know if we are taking a totally correct approach.

I know a lot of the hospitals, particularly in VA days, were built right after World War II with steam heat and other forms of extremely dry heat. So the lower humidity is not perhaps a matter of intention. And then we sell them our new microprocessor based system. And they push a button and they crash a station. And we go back and change more stations and then we go to the hospital and say we have to do something about your environment. And they say no, you have to do something about your nurse call system.

After a while it's as if we buy a new car and we take it home and we run into our driveway and the tire goes flat. We go back to the dealer and he says, "I'm sorry, I'll give you another one." After two or three he says, "What's the matter with your driveway?" You say, "Well, I've got potholes in it." He says, "Why don't you fix them?" "No, you put better tires on your car." You see something similar in the hospital environment.

I believe we are not paying enough attention to the matter of education. I think we should educate the user, the hospital, to bring the humidity up to a reasonable level, but it shouldn't be dripping wet. You can see the service calls in the northeast go up in direct proportion to the drop in the temperature. If the temperature goes down, the heat goes up and the service calls go up.

We've been talking about hospitals. I'd be very interested in anybody else's feedback on nursing homes. In New Jersey, we have approximately three times as many nursing homes as hospitals and I would assume that holds true in many other parts of the country. The future for microprocessor systems in the average nursing home—the for-profit nursing home—is not quite as promising as a hospital. I believe there's a lot of education and study of regulations to be done there.

The licensing codes for a nursing home in New Jersey are what the inspectors use when they go out to inspect the facility. The code for the New Jersey nursing homes says, "There shall be a call bell by each bedside accessible to the visitor and

the patient," and that is the extent of it. Obviously, we are trying to get something done about it. The construction codes are a lot more stringent. And they should be brought into line. That is something I would suggest to all of you here. Look into your codes and see exactly what we're looking for, if we are going to move microprocessor based systems —and yes it is the way to go. I don't think we should run helter skelter into it. I don't think we should install it as a matter of specmanship because another manufacturer or another distributor specified it and we have to have something to meet it. I think we should put it in for the right reasons. Because it's better.

Intemann: Tom Hendricks of Tektone, your company is based in Florida. Surely the nursing home issue is of a concern to you as well.

Hendricks: Yes. I've been in the nurse call business since about 1968 where the majority of nurse call systems were visual: hard wired visual nurse call systems with a light and a buzzer. Now I would say that the majority of the specifications written or coming out for bid these days are including microprocessor technology.

I would chance to say everyone in this room has attended this meeting to answer some basic questions as to how microprocessor nurse call fits into your individual business. Now the questions that I feel that you folks should be asking yourselves are: Are you providing the best possible products for the builder or the developer or the customer that you're serving? Can you install it and make money in the process? Is the technology safe enough to allow you to install it with your current personnel without too much reinvestment in higher priced people? Can you make money in the after market? After I sell this to my electrical contractor or builder-developer, is it done? Is my making money over with? What opportunity does microprocessor offer me in the after market? And should I be afraid of the technology?

Let's try to talk about each one of these subjects individually. As Ken James said,

microprocessor technology has been around and serviceable in nurse call for about 10 years. In my opinion the technology has reached a workable stage where you can install it with confidence and walk away from the job without creating a nightmare for yourself.

But there are responsibilities that go along with installing a microprocessor

nurse call system. On the contractor's end, that means the purchasing of good wire, the proper terminations, of grounding, and general care be put into the installation of the product, thereby insuring the function that the manufacturer says this system will provide. I am always amazed at the flexibility and the ability of the microprocessor nurse call system to

EKTACOM G

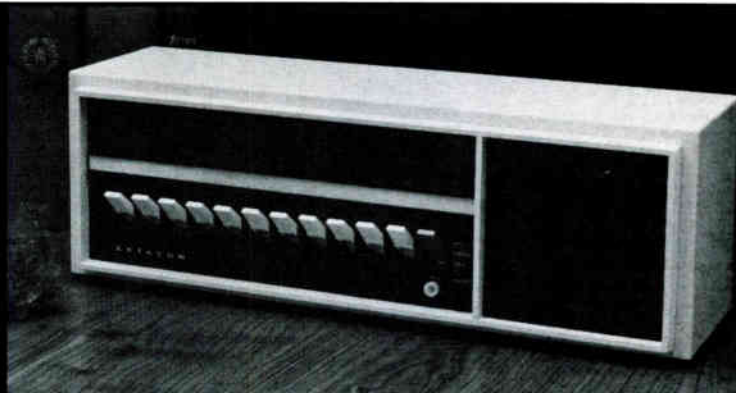

Loudspeaking, Direct-Select Intercom

A few days ago a consulting engineer said to us, "You know, the G Series is built like a battleship. Those solid gold (not plated) switch contacts seem to wear forever. And everything is so rugged." You who have installed G Series know he is right—it is a remarkable system. True, it is a system without computer sophistication. But it has flexibility many contemporary designs do not offer. For example: who has 11 watts RMS output? Who has 4" high sensitivity speakers? (they really do work better!) Who offers two to 1,000 stations all with light annunciators? Who offers both in-and-out volume controls on every master? Who offers desk, flush and rack mounting? And who gives you the kind of superb sound quality found only in the G? This is a time-tested product—some systems 25 years old still operate perfectly on a daily basis!

It has been around awhile, but it is continually updated. For many applications, there simply isn't anything else even nearly as good!

Call us today for complete technical data!

FISHER BERKELEY CORPORATION
955 THIRD STREET • OAKLAND, CALIFORNIA 94607
(415) 655-9696



Circle 250 on Reader Response Card

September 1989 39

COMMUNICATIONS

(continued from page 34)

processor-controlled nurse call system providing two-way voice communications between nursing stations and patient rooms or staff areas. A single system provides coverage from 20 to 80 beds in 20-bed increments.



The Rauland Responder III

- The Responder III nurse call system from Rauland offers simultaneous digital display of up to four incoming patient calls indicating room number, bed, and priority; automatic selection of calls by priority; "privacy" and "monitor" display; and more.

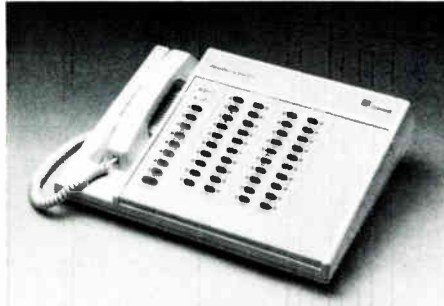

Dukane's ProCare 2000

- The microprocessor-based Survicomm from Multi-Vox Ltd. permits the transfer of communications control from one or more nurse master

stations to a single master station. The wiring consists of four pairs of parallel cable for more economical installation.

- The NC301 master station from TekTone, also microprocessor-driven, offers voice communication, menu-driven programmable functions, master-to-master intercom capability.

How do we define nurse call in the nineties? Sony is wondering if the definition will include such products as its DS-2000, a digital central dictation system with fiber optic communications. One system can handle 31 simultaneous record, review, or playback operations.

The updated Edstan II doctors register provides physicians with 10-second "personalized" printouts of messages, bulletins, and patient locations. Now IBM PC-based, it networks to hospital computer systems and other PCs through a software interface. One system can serve multiple hospitals.

AES-TV

ON-THE-AIR IN N.Y.

Day 1

DESIGNING LOUDSPEAKERS FOR LARGE SPACES

What are the newest theories and the newest controversies? How applicable are signal processing speakers? A panel of designers, acousticians, and installers discusses the current wisdom.

Day 2

3-D SOUND

Is there a revolution in reproduced sound? Has video caused sound designers to think about the delivery of music in new ways? What's new in the coding, decoding and design of surround sound? How important is it? Designers, engineers and installers discuss the revolution for the home and for public places.

Day 3

NEW ISSUES IN RECORDING

1. Console Automation: Fad or Future?
2. Sampling and the Recording Engineer.
3. MIDI: New Applications

A panel of recording engineers discusses these issues and more.

Crosstalk

A Television Symposium

do things that were absolutely unheard of five to 10 years ago. Multiple conversation pads over common wires. No section wires required. Doing a 120-bed nursing home on eight conductors fully supervised and diagnostic. Remote programming and remote system verification. Printer outputs for hard copy retrieval of all the functions of the system.

The technology is there that allows you, the contractor, to buy a good grade of microprocessor product, take it to your contractor and your builder-developer with confidence and know that because the system doesn't function after it has been properly installed you won't lose this contractor who gives you repeat business.

One of the things that needs work is the definition of the necessity of how nurse call equipment applies. There are increasingly more acute definitions of the type of care rendered in the nursing home industry such as continuance care, acute care, long-term health care, congregate living. All of these different titles imply different

levels of nursing services requirements. I see more often than I would like to a misapplication of nurse call equipment in facilities that really don't require it. So, I think you ought to start every conversation by asking, "What are the requirements of this facility?" "Is 24-hour registered nursing service going to be applied here?" Make a decision as to whether it's nurse call equipment that's required or senior citizens alarm systems that are required.

Another thing is the responsibility of the sound contractor to apply the right equipment with relation to size. To provide a microprocessor based system for a six-bed intensive care unit or coronary care unit ward is using a cannon to kill a gnat.

If you're going to serve the engineers and architects and building developers in a useful manner, you should not be afraid to say a hard wire visual system would apply best here. However, when you're looking for the flexibility of having paging in multiple zones, programmable room stations and how microprocessor truly ap-

plies, don't be reluctant to specify it, to seek out microprocessor product because the manufacturers at this table have spent millions of dollars developing what we feel now is the type of technology that can serve your customers well.

What we're looking for is qualified defenseable distributors—people who will, as I said before, buy the proper wire, insure the terminations, make money in the after market by supplying timely support services to the health care facilities, and be responsible to the industry. This is critical communications equipment. It should not be installed lightly and it should not be applied irresponsibly. It implies a level of protection and, therefore, everyone who handles it and installs it and maintains it should understand it and be able to convey his understanding to the end user.

In conclusion, I think that yes, the age of microprocessor nurse call system is here. Yes, you can install it with confidence, and yes you should buy it from confident manufacturers of the same product.

TO LAST FOR CENTURIES

Centuries ago the Dutch built their windmills to help them with their fight against sea and water. Hundreds of them are still working today. With the same craftsmen and top quality materials, now they build HACOUSTIC amplifiers which are designed to give years of troublefree operation.

HACOUSTIC
 Sound & Communications of America
 3963 Magnolia Lane, Buford GA 30518
 telephone: (404) 945 - 3142 fax: (404) 945 - 6174

Circle 281 on Reader Response Card

**Personnel Register
 Designed by People who
 have installed the others!!!**

*"We Can Easily Customize
 To Replace Your Existing Systems"*

CALL TOLL FREE
1-800-852-6522

AUDSCO
 Audio Systems Co. • 1815 Michigan Ave. • Bismarck, ND 58504

Circle 280 on Reader Response Card



Ask Dr. Wokka

by Dr. Wilhelm Wokka

Editor's Note: We discovered in his last column that our good friend Dr. Wokka had fallen into the clutches of a criminal conspiracy of global proportions, a diabolical ring using CD's to broadcast their insidious subconscious sales pitches. We are pleased to report that we've just received the following communication from the good Doctor, indicating that after a harrowing journey (which brought him in captivity to the Far East), he has escaped his tormentors, and is not only alive but apparently doing very well. Perhaps Dr. Wokka should explain.

I have received literally millions of congratulatory letters, along with many gifts of flowers, yellowtail sushi, Kirin Beer, you name it, now that I'm a national hero here in Japan. Yes, I'm fine, though still recovering from my ordeal in the never-ending fight to make the world safe for Audiophonical Genio-technology (and Science). It seems like only yesterday that I was waiting for room service at the Tydee Nytee Motel in downtown Akron. Let me tell you, now that it's out in the open, how I saved the world from the powers of Satan that reside unchecked in the missing bits of information in every digital musical recording, silently drug-ging the world into subconscious sub-liminal submission.

You will no doubt recall that as I was

preparing to send a taped warning to *Sound & Communications*, I was captured, drugged, and transported via private jet to Japan, where I was to be interrogated by the Secret Society for Digital Enslavement of the World (SS/DEW). These villains are responsible for all the hidden messages making scrambled eggs of the brains of unknowing listeners worldwide. They wanted to know how the Philadelphia College of Musical Knowledge (PMCMK) and the Philadelphia Church

They were also able to obtain a copy of the *Sweet 1600 Pleniovoneic Ex-potaxial Loudspeaker* to listen to from a local Tokyo retailer.

Anyway, we listened to both coded and uncoded digital recordings, where-upon I said, "Can't you hear the change in quality? The clearer image, the depth of the soundstage, the transparency..." (along with many other audiophile magazine patterings). Of course they couldn't hear any difference, but they all nodded knowingly

I don't have to tell you
that high-fidelity equipment
is the equivalent of the
Holy Grail in Japan.

of the Living Sound were able to detect the code.

Their appeal to my enormous ego almost broke my will: "Oh Great Audio Guru, please teach undeserving audiophile the secret of CD code-breaking so your greatness can be fully appreciated and revered." Indeed! And then they'd kill me and my staff so their secret would remain a secret! Not likely, I thought.

So, on the spur of the moment, I devised a plan. I requested both coded and uncoded digital recordings for the purpose of honoring their request.

and pretended they could anyway, so as not to lose face. I then told them that I could fix the sound quality problem and still provide their Satanic advertising in between the bittys and biters or whatever computer-banterings are called these days.

Now, I don't have to tell you that high-fidelity equipment is the equivalent of the Holy Grail in Japan. When my captors truly realized that it was I who invented the *Sweet 1600* loudspeaker, I who founded the PMCMK, I who am the God of Audio Redemption Incarnate, I who alone hold *The*

Wokka is an instructor and mentor at the Philadelphia Medical College of Musical Knowledge.



Key, well they began treating me as though I was the President of the AES—McDonald's, sashimi, poison fish, Pepsi, you name it.

To make a long story short (I do go on, don't I), I discovered that only two companies make the CD transports for the entire world. It turns out that each and every transport has a special WARM or ROGM or some such-named chip that puts the messages out with every boot of music it plays. Also, these chips are programmable from a satellite-linked base in Beijing China, so that new messages can be added at any time.

Well, I put a stop to that! Having broken the code, I programmed all their secret messages out, programmed in my own message revealing my secret place of captivity, and sat back to watch the fireworks as the new CD players came off the line. Within days, a battalion of secret Ninja-Force troops, dis-

patched by Mr. Uno himself, came to my rescue (complete with the latest video cameras to capture all the action.) The "Big CD Bust," was televised all over Japan—I became a national hero in microseconds. The criminally-insane companies became nationalized and I, of course, was handed overall technical control of both.

I began work at once on my master plan. I incorporated the following technical reforms into all new compact disc players:

1. Automatic VISA and AMEX credit card billing directly to artists' accounts, based on the selections played and the frequency of play. No credit card—no CD! Now we don't have to worry about artists being "ripped-off"; whenever we play, we automatically pay. Of course, the various record labels love this as well.

2. Censorship! Whenever the "f" or the "s" words are encountered (or any

like them), funds are deducted from the offending artist's royalty account and deposited in a fund to help the new, decent artists who are trying to make a living from clean music, no easy task these days. Many phrases using alleged "clean" words in a "double off-fendra" or whatever they call it are also included.

3. Better sound! We increased the bits and the sampling frequency. Of course, this makes all the CD's currently on the market useless, but the new ones will really have that dynamical electronical speculation, well worth the price. The record companies love it!

Well, that's it. I'll probably stay here a few more weeks, if I can only convince Blanche I'm not fooling around with these in between TV interviews and photo sessions with glamorous Hollywood models. So, from Tokyo, I bid you Psychonara. ■

STOP FEEDBACK!



The Mackenzie Feedback Eliminator (model FE-1) is a solid-state, digital record/play unit which has no moving parts and requires no maintenance. It is designed to be installed between the power amplifier and the paging system. When a paging station is actuated, the message is digitized on a real-time basis and stored in memory. When the paging station deactuates, the recorded page is played over the paging system speakers. Since the open microphone has been eliminated, amplifiers can be turned up to any desired level without any feedback at all.

Voice reproduction is entirely natural-sounding. Message length is up to 30 seconds. The on-board microprocessor senses message termination and automatically switches from the *Record* mode to the *Page Playback* mode with no "dead time."

HOW THE FE-1 WORKS:

- 1) When the paging station is actuated, a contact closure furnished by the paging system actuates the *Record* mode.
- 2) The user makes the page.
- 3) When the paging system releases the contact closure, the FE-1 automatically switches from the *Record* to the *Play* mode and sends out the page.

For additional information about the FE-1 Digital Feedback Eliminator, call MacKenzie Laboratories toll-free: **800-423-4147**

MACKENZIE MacKenzie Laboratories, Inc.
5507 Peck Road, Arcadia, California 91006 USA, 818/579-0440 FAX: 818/448-7131

Sound Recording Handbook

By Hector G. La Torre

It seems that books about sound, recording and recording technology generally fall into one of two categories:

- The Techno Tome—Weighty, pedantically written and so full of numbers and formulas that even the majority of people already working in the field don't have a clue as to what is being discussed. The novice doesn't stand a chance in these X<Y-infested waters.
- The Private Club Book — Here the author uses techniques and the recording science as a means to relive his/her days on the road/in the studio with The Stones, The Grateful Dead, etc. This type of book is filled with inside jokes, weird microphone placements and stories that wind up leaving most of us on the outside not wanting to get in.

John Woram's latest book, the *Sound Recording Handbook* (Howard W. Sams & Company, \$49.95, 586 pps.) falls into neither of the above categories. It is, instead, a book written with the understanding that the industry still needs solid, helpful information, but that not everyone wants to wade through tons of math in order to mix or record music. Also, it is written somewhat tongue-in-cheek—as a reminder that most of us got into this business to try to have a good time, do a good job and maybe, while we were at it, earn a few bucks. It's music, Ladies and Gents, not atomic energy.

La Torre is a record producer and recording consultant for Fits and Starts Productions (Lincroft, NJ).

Don't get me wrong; Woram takes his subject seriously. He delivers accurate, in-depth information, and does so in a clear, intelligent, non-threatening manner. The book is divided into 12 chapters and four sections. The chapters are: Basic Audio Theory; Music, Electronics and Psychoacous-

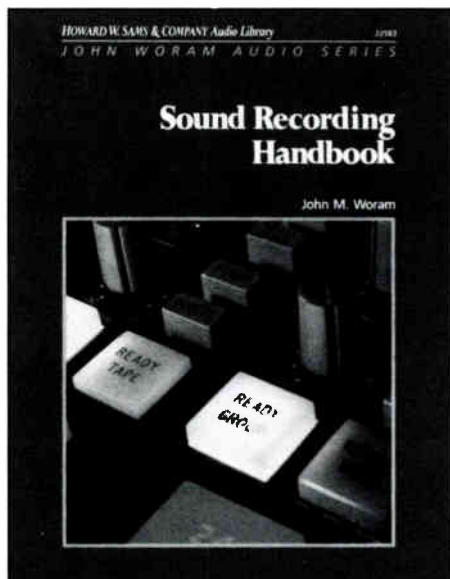

tics; Microphones; Special Purpose Microphones; Monitor Systems; Delay and Reverberation Systems; Equalization; Dynamic Range (compression, expansion, gating, etc.); Magnetic Tape; Tape Transport Systems; Noise Reduction; and Recording Consoles. The four additional sections include a reprint from the SMPTE organization describing SMPTE Time Code, a glossary of terms, descriptions of abbreviations, acronyms and symbols used in the industry and bibliography.

John Woram knows his audience. He understands that while math is at the heart of mixing, recording and music, it is not necessary to have a

complete working knowledge of formulas and theories in order to create music. There is a greater emphasis on knowing why equipment and music fundamentals work and sound the way they do. There are excellent chapters on equalization, console design and signal flow, including in-depth explanations of split and in-line types, as well as sections on the different forms of noise reduction, especially Dolby SR (Spectral Recording). (I was surprised to find no mention of dbx's 563x "Silencer" noise filter, or the Dynafex or Rocktron single-ended noise reduction systems.)

The book does not delve into digital techniques, and some readers may find this derelict in a book published in 1989. However, this book is not about the latest in modern technology; it is about the fundamentals, techniques and proper utilization of modern technology. Whether one uses digital or analog equipment, the basic techniques stay the same. Perhaps a more important omission is that of MIDI. MIDI has revolutionized the world of recording by directly involving musicians who five years ago pleaded disinterest in the hands-on process of recording. These same players now own mixing consoles, DAT machines and racks on processing gear, and are some of the many who should rush out and grab this book. A look at MIDI would have made this book more complete and, more importantly, friendlier to musicians.

Nonetheless, the *Sound Recording Handbook* is an extremely fine book. It will be invaluable both as a support system for those new to the industry and as a reference source for the experienced.

In loudspeaker systems, uniform coverage equals superior response. The frequency response of a loudspeaker is the acoustic pressure level it will produce with a constant voltage input, over a variety of frequencies. The coverage of a loudspeaker is the angular wedge of sound radiation it produces; that is, the area it will serve in actual use. What have frequency response and angular coverage to do with each other?

It isn't very difficult today to create a loudspeaker with excellent frequency response directly on-axis. This axial response may actually be one of the less interesting ways to measure response. To know the frequency response most audience members will hear, we must consider the coverage of the loudspeaker. This is especially important in the case of multiple loudspeakers used jointly to cover adjacent areas.

If a loudspeaker coverage pattern narrows down in some frequency bands, listeners outside this diminished coverage hear it as a response deficit: a dip in the response at those frequencies. If a loudspeaker coverage pattern widens at other frequencies, and this loudspeaker is used in conjunction with other similar loudspeakers for wider-area coverage, listeners in the overlap area hear $\sin x/x$ interference, sometimes popularly called comb filtering.

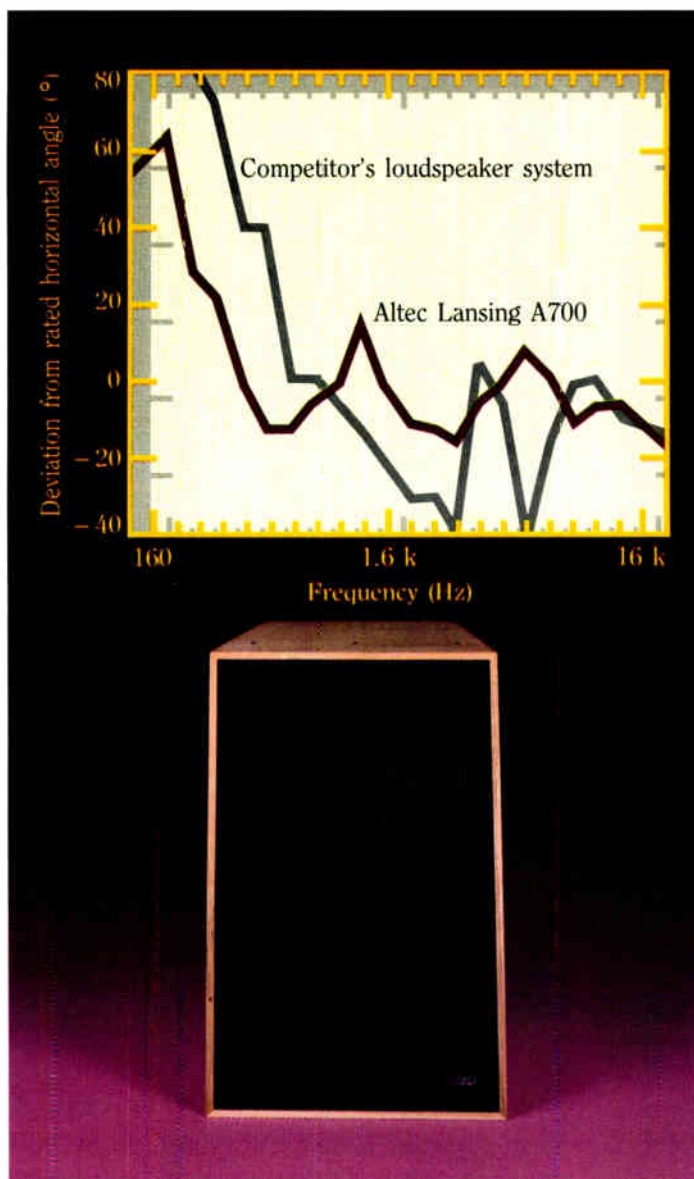

The graph shows deviation from rated horizontal coverage angle, for the Altec Lansing model A700, and for a popular loudspeaker system of approximately the same size and price.

The coverage of both loudspeakers widens at low frequencies, however the A700 exhibits much greater uniformity over this range. Note also the A700's smoother behavior in the critical upper octaves while the competitor's unit allows the pattern to collapse at two frequencies.

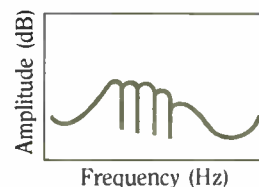

Coverage overlap produces interference; reduced coverage produces frequency response gaps.

The designer of a loudspeaker system must take great care that its coverage remains constant over most of its useful frequencies. This way, most listeners in a correctly-designed application benefit from the best frequency response the loudspeaker can produce. Gaps or overlaps in coverage all deteriorate the frequency response the audience will hear.

What is the benefit of uniform loudspeaker coverage? Superior frequency response for all listeners.

Fact.

In Loudspeaker Systems, Uniform Coverage = Superior Response



P.O. Box 26105 • Oklahoma City, Oklahoma 73126-0105 USA • 405-324-5311

©1989 Altec Lansing Corporation a MARK IV company

Circle 210 on Reader Response Card

Mark IV Audio Canada, Inc. • P.O. Box 520 • Gananoque, Ontario K7G2V1 • 613-382-2141

World Radio History

THE CARVIN MX2488 CONSOLE

BY HECTOR LA TORRE

Carvin designed the MX2488 with several markets in mind. It is a board capable of operating as a sound reinforcement tool in clubs, stadiums, churches, convention centers, and the like, as well as in the recording studio, broadcast arena, and personal production facility. The MX2488 has a 24 x 8 x 2 configuration. Four monitor mixes and eight sub-groups are available. For those requiring fewer inputs, this board design also comes in a 16-input version—the MX1688. Its dimensions are 8.75 inches H x 35.125 inches W x 29 inches D, with weight set at 80 pounds. The MX2488 is differentiated by its slightly greater dimensions and weight, a separate power supply, and, as you've already figured out, eight more inputs.

The MX2488 offers modular construction in its circuit board design; circuitry is connected via ribbon-type cable (as you might see on a computer). Getting inside the 2488 is very easy. Simply tilt the board onto its back panel, unscrew the bottom panel and you're in. Of course, if you are using the board for recording or in a permanent-installation setting where you have patchbay, multi-track tape recorder, two-track, cassette machine and assorted processing and MIDI gear connections sticking out of the rear, this presents the problem of having to tilt the unit back onto, and possibly damaging, those connections. One person will find it very difficult to do the tilting and inspecting on his/her own. If you are using the board for live sound where you are setting up and breaking down each night, the problem becomes minimal.

Overall construction and appearance are excellent. The body is made of steel, the separate control sections have color-coded knobs for visual continuity, and a padded

arm rest and oak side panels add a nice cosmetic touch.

A VIEW FROM ABOVE

As you look at the console you see that its operations can be divided into four main sections: 1) Input Channel Section; 2) Effects Master Section; 3) Master Control Section; 4) Output Channel Section. I'll start with number 1, and you can follow along by checking out the respective photos/diagrams.

At the top of each of the 24 input channels, there is a mic/line button. (The MX24 has a nominal operating level of +4 dBV, but it also can be operated at -10 dBV output levels, depending on your need. Just below is the Gain Control knob. Following is a 3-band Parametric EQ section controlled by dual concentric knobs in each of the three bands. The inside knob

boosts or cuts by an amount of up to ± 15 dB, while the outer knob permits the choosing of the frequency. There is a High EQ with a range from 1 kHz-16 kHz; Mid, 200 Hz-4 kHz; Low, 40 Hz-800 Hz. The EQ can be switched in and out of the circuit via a button.

Next in line is Cue Send section. There are two Cue Sends controls, as there are two Effects Send controls just below them. Each section can be made to operate either pre- or post-fader, enabling you to use, if needed, all four simultaneously as either cue sends or effects sends. Next we've got the Group Assign section with its five buttons (1-2, 3-4, 5-6,7-8, L-R) and pan pot. By depressing button 1-2, for example, and then turning the pan pot full left—counterclockwise—you send input signal 1 to output channel 1. The L-R button assigns the input channel signal to the



2-track buss, circumventing the output channels. Continuing on we find the Channel Mute button and Channel Solo button, plus the channel Peak LED. At the bottom of the strip is a 100 mm input level fader.

Section 2 is the Effects Master Section. First are the two Cue Send Master knobs and two Effects Send Master knobs. These are the overall (hence, Master) level controls for the channel effects and cue sends. They provide the juice it takes to get an effects device or cue amp properly driven, while the individual channel effects and cue sends adjust the groups; Effect Return A and Effect Return B. These are to control the level of a special effect in the cue system, mains or 2-track mix. Each Return section provides Assign buttons—Cue 1-2, Sub 1-2, 3-4, 5-6, 7-8, L-R—a Pan Pot, solo button and Level Control. At the strip's end are two closely-

spaced faders which adjust the signal level of the 2-track outputs to your main speaker system (live work) or 2-track mix-down recorder (studio). The Owner's Manual has these mislabeled as "CR Level" in Section 1-3.—where all the buttons and switches that don't belong anywhere else end up. Many are overall operating controls.

So, again starting at the top, let's look at this section. First is the Phantom Power button. Depressing it will permit operation of condenser microphones in any input channel. This is a 48 Volt D.C.-type power source. (A BNC-type connector also resides here, as a connection point for a 6-VAC mini-lamp. Useful in a dark theatre for seeing how much damage you've done to the board from spilling your favorite beverage into it.) Proceeding along you'll see the Meter Function area, with one button labelled 5-6 Cue for deciding

whether you need to monitor output levels of 5 and 6 or Cue #1 and #2 output levels; and the other button labelled 7-8/L-R for monitoring output levels of 7 and 8 or output levels of the 2-track Master Sends.

Studio Select is next, and here we can choose which feed is sent to the studio (as opposed to the control room), and we have a choice of sending the main output signals, 2-track playback, Cue 1 & 2 or Effects 1 & 2. The Talkback section follows, and it has a built-in condenser microphone; Level control for that mike; and select switches for Cue 1 & 2 (speaking to the players in their phones or through the on-stage monitors); Studio (speaking to players through the studio speakers); Effects 1 & 2 (for effects signal verification); and Slate (for verbally slating, or marking, tapes for identification purposes—with song titles, take numbers, edit points, etc.). Depressing with Talkback switch

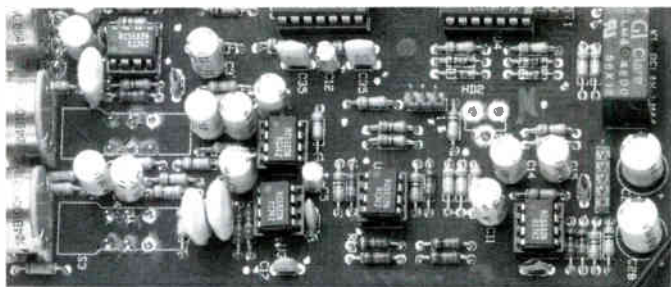

Timed audio turn on during power up.

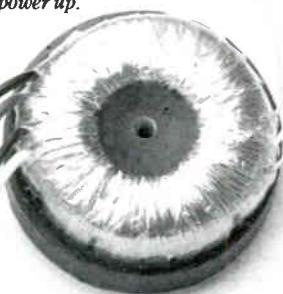

Torroidal transformer for greatly reduced AC hum.

1% polypropylene capacitors and 1% metal film resistors for accuracy and stability; 5532 opamps used for low noise and high slew rate.

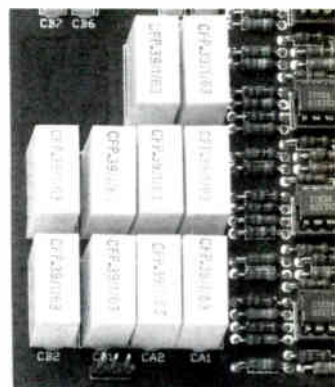

NO GUTS. NO GLORY.

It takes guts to compare yourself to the best names in the industry.

The Audio Logic SC31 is a powerful EQ designed for professional use. It offers 31 $\frac{1}{3}$ octave centered bands with selectable 6 dB or 12 dB of boost and cut.

Look at the chart.* In every category the SC31 delivers better specs plus incomparable sound quality.



	Audio Logic SC31	RANE GE 30	JBL/Urei 5547A	Klark-Tekwik DN 300
Noise	Less than -90 dBm	Less than -90 dBm	Less than -90 dBm	Less than -90 dBm
Maximum Output	+27 dBm	+24 dBm	+22 dBm	+22 dBm
Dynamic Range	+117 dBm	+114 dBm	+112 dBm	+112 dBm
Frequency Response	18 Hz to 30 kHz +/-0.5 dB	10 Hz to 40 kHz +0/-3 dB	20 Hz to 20 kHz +1/-2 dB	20 Hz to 20 kHz +/-0.5 dB
Number of Bands	31	30	30	30
THD plus noise	Less than .005% @ +22 dBm @ 1 kHz	Less than .01% @ +4 dBm	Less than .5% @ +22 dBm	Less than .01% @ +4 @ 1 kHz
Suggested Retail Price	\$550.00	\$749.00	\$849.00	\$1,050.00

With this much quality and technology, why shouldn't we display more than a little intestinal fortitude?

Manufactured in the U.S.A. For more information, contact Audio Logic, 5639 So. Riley Lane, Salt Lake City, Utah 84107. (801) 268-8400.

*All specs taken from manufacturers' published literature.



Circle 251 on Reader Response Card

September 1989 47

automatically lowers the control room monitor levels. In the Control Room Group there is an LED to indicate "Master" Solo status and Solo level control, along with four assign buttons which when depressed will access signals appearing at the rear panel jacks of 2-Track outputs, 2-track playback, Cue 1 & 2 and Effects 1 & 2.

offer. All twenty-four inputs provide 1/4-inch Line inputs. I should mention here that the first eight Line inputs of the board are internally connected so as to be routed ("normalled") to the eight output channels. The first eight channels will match up to the eight outputs of your multi-track. Clubs, theatres, conference centers and

instrument) to the 2-track master outputs. This will allow you to control the overall level of the individual channels as well as the overall level of the main house system with the 2-track master faders. Subgrouping of channels can either be done on a per-instrument-group-basis (that is, combining groups of background vocal mics, overhead mics or rack and floor tom mics, and sending them to the sub-output faders for easier control while keeping other instruments on their own input channel fader) or by sending all instruments (channels) to the eight sub-group faders, thereby handling the entire mix via those eight faders. The two Cue Sends are able to deliver separate and independent mixes to the musician's monitors.

Prior to doing a complete band mix, I started out by mixing and monitoring some brutal acoustic drum and drum machine combinations. Proper gain structure was easy to get right even without an attenuation pad. The peak LED is active 6 dB below clipping. The board's circuitry is reasonably forgiving, because I pounded the inputs and still came away clean to the house and tape machine.

The 3-band EQ is very useful in that it is musical. What I mean by that is that the EQ boosts and cuts at musically useful points. Each available EQ band overlaps its neighbor over a broad range, allowing for smooth blending of instruments.

This console is a winner. Yes, I do have two reservations; but they don't change my favorable opinion. One reservation concerns the life span of the power supply. This baby gets quite hot when left on for extended periods. I kept the unit continuously fired up for several days without encountering electrical problems, but, as we all know, heat is no friend to electronics. However, without keeping the supply on for long periods over many months' time it should be impossible for me to tell what the net result of all that heat would be. Perhaps nothing negative at all. I would, however, suggest setting up a small fan and a shade canopy alongside the supply if you are planning to mix outdoor events under the summer sun.

Getting inside the unit is easy. Simply tilt it onto its back panel and unscrew the bottom panel.

Also, there is a Stereo/Mono switch, and lastly, the two Control Room Level faders.

At last, we have arrived at the fourth and final section: the Output Channel Section. There are eight output channels, each offering the following controls: Pre/Post switch for the Cue Sends, two level controls for Cue 1 & 2, Pre/Post switch for the Effects Sends and two controls for Effects Sends 1 & 2. ["Pre" is before the output channel fader; "Post" is after the output fader but before the 2-Track Level Monitor fader (see below).] A Tape button is next. Depressing it routes the multi-track's playback to the 2-track monitor section. Which brings us to the 2-Track Monitor Fader and associated Pan pot. Underneath the monitor fader is a Sub Mute button and a Sub Solo button. Depressing the Sub Mute switch will eliminate that particular output channel's signal from your mix. At the strip's end are the eight Output Channel faders. These feed the two-track faders and send the record levels to your multi-track tape machine. The eight VU meters show what's happening with these faders (unless instructed to do otherwise, as mentioned above).

ON THE BACK STREETS

The MX2488's back panel has plenty to

music groups looking to have recordings at the end of the night will find it a breeze to integrate an 8-track deck into the live system. The eight sub outputs each have 1/4-inch Send and Return jacks, XLR output jacks and 1/4-inch output jacks (to tape machine inputs). In addition, there are thirty-two more 1/4-inch jacks on the back panel, running the gamut from 2-track's inputs and outputs to Cue Send jacks to control room outputs to studio room outputs and much more.

ROAD TEST

I spent quite a bit of time with the MX2488. In addition to doing a considerable amount of recording with it, I also dragged it out and used it as a house mixing board during a live band rehearsal, and then did some recording of the rehearsal. I'll say right off that electrically the console is extremely quiet. The preamps are stable and sonically unobtrusive. Even when I purposely misrouted signals and cranked up their level the board was outstandingly quiet.

The signal routing is very simple to follow, making the board very friendly. You can accomplish a basic live mix very easily. Simply assign and pan each input (in-

My other negative observation has to do with the owner's manual. Overall this manual is very good. It details the console's operating parameters in plain English and flows from point to point in a logical manner. Plus, it has quality schematics, instructive sections on tri-amping and bi-amping, an audio glossary and suggestions for "efficient set-up" in recording and live sound situations. However, somebody forgot to check the manual for proper spelling. There are several misspelled words here, including impedance repeatedly misspelled as "inpedance." In addition, the descriptive sections use what appear to be photocopies. What happens—specifically on the rear panel shots—is that the black lines used to highlight particular sections blend into the darkness of the photocopy and make

Electrically, the console is extremely quiet.

it very difficult to discern which jack the manual is trying to point out. Carvin has attempted to reverse the black lines into white in some cases, but it doesn't quite work. I suggest using clear expanded line

drawings of the rear panel rather than photocopies.

The price for this console is \$3,995.00. I consider that a steal for 24 inputs, 8 outputs, a useful monitoring section, solid EQ, quality electrical specs and performance flexibility. And Carvin offers professional sound contractors an 8 percent discount when ordering a "complete system" (a complete system is designated as such when it appears in the Carvin catalog). If the sound contractor needs a custom system, then Carvin will provide a 5 percent discount. Both discounts are reflected in the printed price, not taken off the top.

La Torre is a record producer and recording consultant for Fits & Starts Productions, Lincroft, NJ.

COMPARE SPECS AND PRICES

The 1989-90 Music & Sound Buyer's Guide
It's the handiest reference you will find for model numbers, specs and list prices.

- Speakers
 - Power Amps
 - Microphones
 - Signal Processors
 - Mixing Consoles
 - Sound Projection
- ... and musical instruments, too!

Easy Comparison

ORDER TODAY!

Mail to:
MUSIC&SOUND BUYER'S GUIDE
25 Willowdale Avenue
Port Washington, NY 11050
att: Bob Evans

YES. I want the 1990 MUSIC&SOUND BUYER'S GUIDE for \$4.95, plus \$1.00 for postage and handling.

Payment enclosed

Bill my credit card Visa MC AmEx

Card # _____ Exp. Date _____

Name _____

Address _____

City _____ State _____ Zip _____

Signature _____

SALES & MARKETING

(continued from page 12)

consistent corporate identity program can also bring employees together by uniting them under a common identity and facilitating communication throughout the company.

The benefits are clear, but you're probably wondering what's involved in developing a corporate identity program. Is it complicated? Difficult to monitor? Expensive?

First of all, the program must be simple and user friendly. The goal is to get as many people as possible safeguarding the way your name and logo are being used. If it is too complicated, people won't use it. You'll need to develop printed standards that cover all possible logo applications—from transportation vehicles to stationery. This should also include standards for typefaces and styles used in conjunction with the logo. And you'll need a looseleaf binder to keep them in so they can be easily referenced and easily updated as new applications arise.

And then you'll begin the process of communicating these new standards. Here, visible management support is critical, because you'll be asking people to alter the way they've been doing their jobs—and the reasons for that change must be abundantly clear—and urgent. Management support is usually communicated in the form of a personal letter that accompanies distribution of the binder to everyone who uses your logo. And you'll need someone to monitor the standards; this job will become easier as the standards become better understood and more widely applied.

It's that simple: Develop the rules, communicate them, and make sure they're obeyed. It's an on-going job, requiring very modest expenditures for very big advantages.

Your name and your logo are among your most precious corporate assets—the public affirmation of your commitment to excellence. Like any asset, they need protection from the daily wear-and-tear of business life. Start now to work to safeguard your corporate identity for the 21st century. ■

BUSINESS MUSIC

(continued from page 26)

the premises through standard, 8-inch

50 *Sound & Communications*

speaker pairs, you could upgrade to a coaxial speaker with wider frequency response for better fidelity."

DBS transmission quality measures about "three times greater" than that of sub-carrier authority, concurs Michael Malone, president of Audio Environments Inc. "We believe our future growth—and our particular market strength—lies in selling the direct broadcast satellite service because it has a much higher fidelity, a much higher quality for music programming."

Although AEI, Muzak's main competitor, recently inaugurated a DBS music service, Malone says subscriptions to taped programming still comprise 70 percent to 75 percent of annual revenues. "The control that tape offers, and the flexibility of changing those tapes, is a very viable service for our clients," he says. "In that respect, I don't think tape will ever be totally replaced by satellite distribution."

Additionally, the CEO says AEI's restaurant and retail clients, like the 900-unit Jack in the Box fast food chain and the Limited women's clothing stores, are increasingly receptive to programming carved into ever finer demographic slivers.

"We call it 'demographically reflective programming,'" remarks Malone. "A Jack in the Box serving the same hamburgers and frittatas everywhere gets four different types of music—anything from ethnic to rock and roll—depending on its outlets' local customer profile."

The carefully disseminated music is "extremely effective," he adds, "because it creates a more positive and supportive atmosphere for the employees, and obviously, for those customers coming in, this is the music they enjoy."

Adds Baker: "On-location music is becoming more and more of a niche product. Where satellite-fed music can't be justified, on-location music can be customized and configured to exactly meet the needs of a particular customer."

But suppliers contend the on-location system, like DBS, also is fast becoming a lucrative vehicle for marketing ancillary audio services. Besides music, 3M offers on-location messaging programs. Ritter acknowledges that while DBS is Muzak's primary focus, "Certainly we are still selling quite a bit of on-premises taped music and playback equipment, and we're now just starting to aggressively promote our in-house production capabilities for audio

marketing services."

Muzak says it will soon launch a major promotional campaign for audio point-of-purchase messaging services that include "marketing-on-hold," for which the company provides equipment, recording studios, professional talent and staff copywriters, and "audio in-store marketing"—messages produced to mix in with the music source and played on Muzak's Ad-cap 1200 repeater unit.

Despite Muzak's 250 independent and company owned U.S. franchise locations and AEI's next-biggest breadth of coverage, Malone puts the total number of American businesses utilizing music services at less than 250,000. "That's maybe about a 13 percent market penetration" representing great future growth potential, but also a few obstacles to growth, he opines.

"As far as the future is concerned, the one big negative is lack of general awareness as to effective use of music within an environment, whether that's a retail environment, or a business environment. It's an educational process that needs to be addressed by the industry."

Citing recent Electronic Industries Association statistics, Malone notes Americans spent some \$5.6 billion on prerecorded compact discs and audio tapes in 1988. "They spent \$10.2 billion just on stereo equipment for their homes; and I think \$4.5 billion on stereo equipment for their cars. Now that's major spending," he says.

"And what it tells you is that people are aware of, enjoy and obviously consume music massively. Yet those very same people are managers and owners of businesses who aren't putting two and two together and saying, 'Wow—if Americans are that much into music, how can I use it to enhance my work environment?'"

Dave Donald, national sales manager for in-wall speaker manufacturer Sonance Inc., readily acknowledges a musically enriched environment "can be advantageous, regardless of whether you actually have clients coming into your office or whether you just like the atmosphere to be more soothing for the people who work there."

He also suggests new options and advances in the marketplace are dramatically changing end users' buying criteria from what was once strictly an order for a busi-

(continued on page 63)

MEASUREMENT THEORY

(continued from page 16)

set procedure), and measurements are taken over a set linear averaging time at each of these points. When the operator is interested in "source localization" (when one area of the source is thought to be higher in power than others), he may decide to move the probe along the surface of the device under test, with the probe-microphone axis being parallel to the device under test. In this case, the operator will watch for the change in intensity from positive-to-negative or vice-versa, and this shift will imply the position of a dominant noise source.

There are two types of averaging available in sound intensity measurement, exponential and linear averaging. Exponential averaging tends to be used when there is little variation in the sound source, and linear averaging is far more common due to the need for long term averages in most measurements due to this variation. The sample rate ($\frac{1}{8}$, $\frac{1}{4}$ or 1 second, for example) is based on the inherent fluctuation of the source and the period of this fluctuation. Shorter sampling rates will allow a signal with much shorter transient variations to be more accurately monitored.

A final consideration is the determina-

tion of post-processing needs. In most standardized measurements, such as sound power, these needs are limited to determining the value of the result. In many other cases of diagnostic measurement, the operator does not have a quick ability to determine this issue. During the analysis of measurement, many questions often arise which suggest that plotting and displaying various analyses of the phenomenon under measurement may assist in the understanding of the data in dramatic ways. With this in mind, there is a tendency in diagnostic and experimental measurement to select a certain approach, as follows:

1. Calibrate the system with an intensity calibrator.
2. Perform a preliminary set of measurements to define the frequency and level range of the signal.
3. Calculate the P-I Index to determine the level of concern for residual intensity.
4. Use 1/3 or 1/12 octave measurements of the signal.
5. Select long averaging times, up to one or two minutes.
6. Measure in a cube or in sliced steps

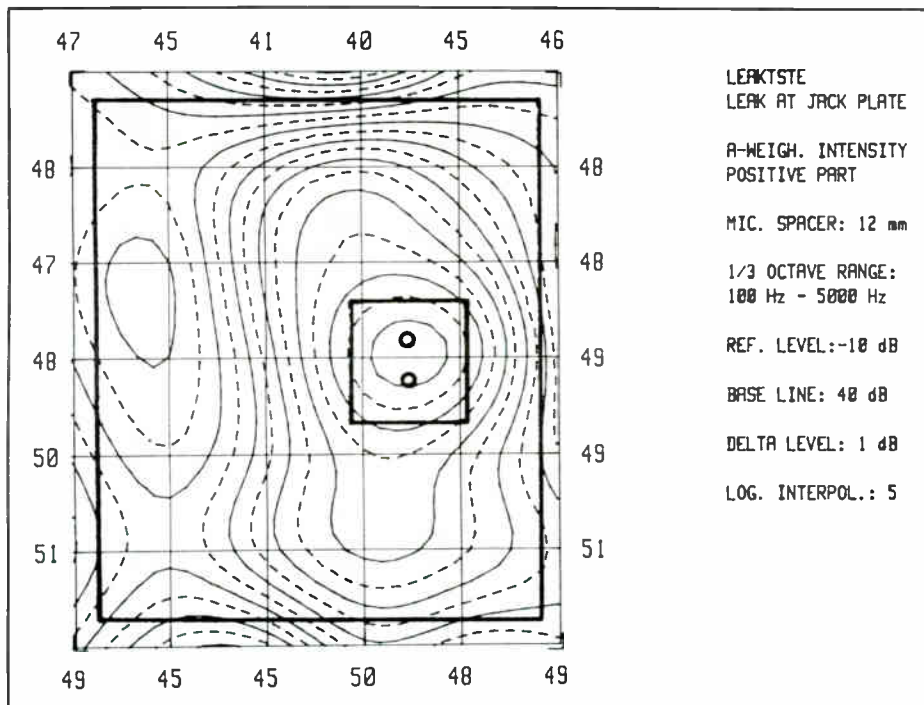

Figure Seven: Cabinet Sound Intensity Contours

THE SOUND OF SILENCE GT4A NOISE GATE



SIGNAL PROCESSING

- Unique optical system ensures absolutely quiet operation
- Front panel key switches
- Rack mounting • \$395
- Easy to use • 4 channel

The Omnicraft GT4A is ideal for studio & live work. Available in NEW high-speed version.

Call for literature, review or your nearest dealer.

1 - 800 CT AUDIO

C-T Audio,
3050 SW 14th Pl, Ste3, Boynton Beach,
FL 33426.

In Canada call: Reid King,
(604) 222 8190

Circle 292 on Reader Response Card

When You Need It
We've Got It

Switchcraft®

A Raytheon Company

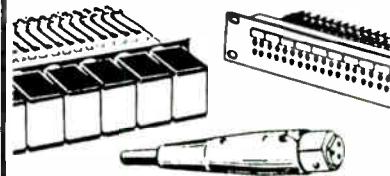

- JACK PANELS
- AUDIO CONNECTORS
- PLUGS AND PATCH CORDS
- MULTI-SWITCH® SWITCHES



**WE STOCK THE COMPLETE
SWITCHCRAFT LINE**

**Cal Switch
(800) CAL-SWCH**

13717 S. Normandie Avenue
Gardena, California 90249

Circle 293 on Reader Response Card

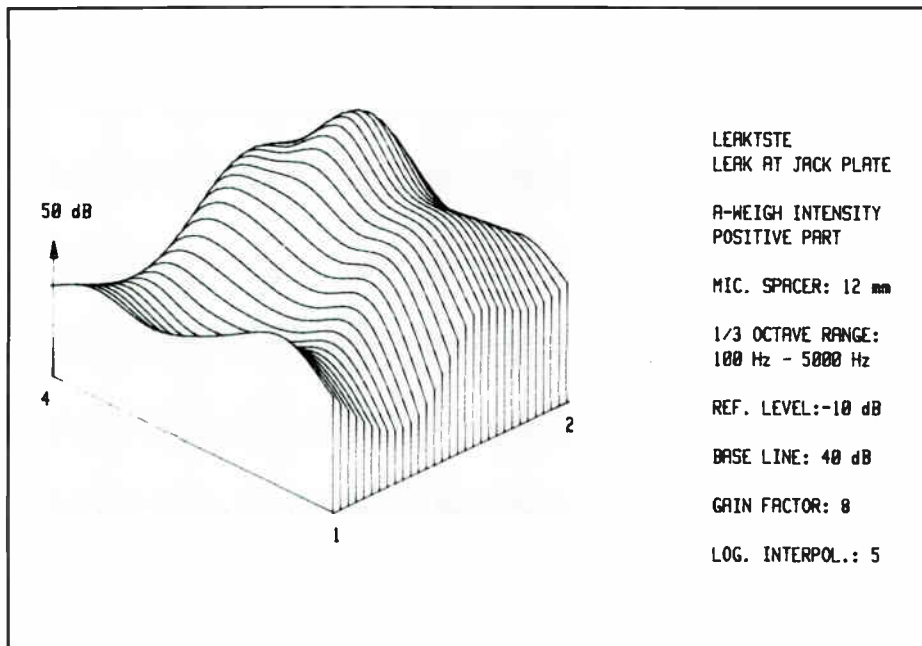

Figure Eight:
Cabinet Sound Intensity Contours

and file the results as "Multispectra" (B&K term for arrays) for later analysis and plotting.

7. Use a DAT recorder to tape the measurement procedure, if it is not easily repeated, for later alternative analysis.

The following is an example of the use of sound intensity to locate "leaks" at the back of a loudspeaker cabinet. The speaker tested in this example has two unsealed 1/4-inch phone jacks mounted on an aluminum plate at the back of the cabinet, allowing air and/or sound to "leak" through the unused jack.

To map the sound intensity flow at the back of the speaker cabinet, point measurements were obtained along a grid. The grid allowed four inches between each measurement point and extended beyond the edges of the cabinet.

Measurements were obtained along the grid at an axis normal to the speaker cabinet. Figure 7 shows the contours of the sound intensity flow measured at the back of the cabinet. The jack plate is traced over this contour and is seen as a small square containing two circles, in-

dicating the jacks, near the center of the grid. The contours emanate in a circular pattern from near these jacks. As seen on the 3-D intensity plot shown in Figure 8,

the sound intensity is at a maximum at the jack plate, indicating a significant leak at this point compared to the rest of the back of the cabinet.

Figure 9 shows the P-I index for a typical point (4,3) on the measurement grid. Comparison of these P-I indices with the nomograph shown in Figure 5 indicates that these are all within tolerance. This indicates the measured intensity data is accurate.

As has been shown in this series of articles, intensity is a very powerful diagnostic test method. It has the ability to determine the direction of sound propagation and is very useful in determining the location of sound sources and in investigating how these sources interact. Whereas sound pressure level measurements can be used to plot the overall flow of sound from an object at a distance, sound intensity can be used to plot the flow of sound in the nearfield of an object.

Orfield is president of Orfield Associates (Minneapolis, MN).

Richard G. Pierson is an acoustical consultant specialist in A/V design and testing. His background is in physics.

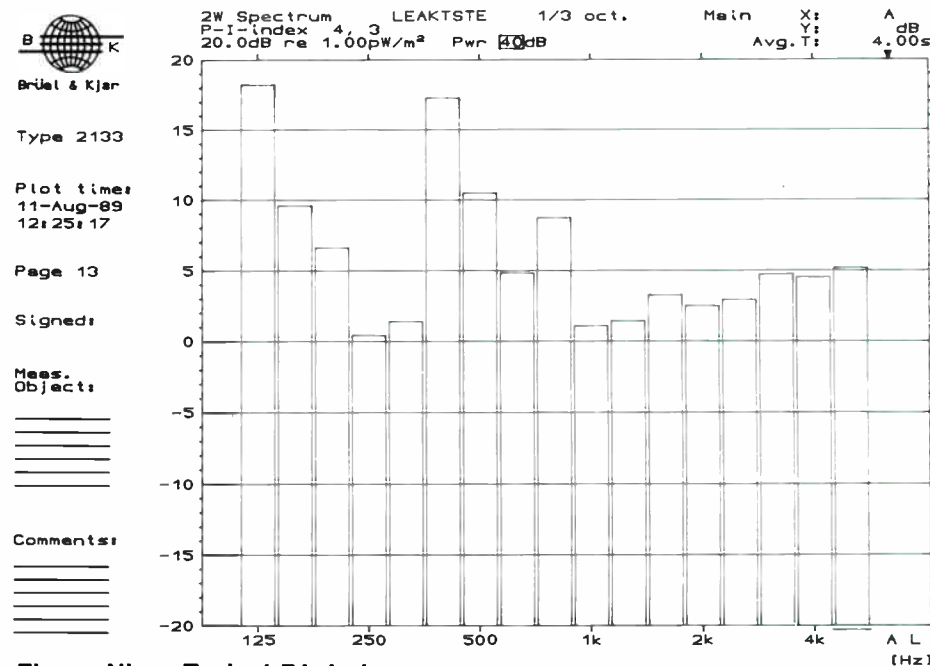

Figure Nine: Typical P.I. Index

The PHD™ Program: A Review

BY MIKE KLASCO

John Prohs, after attending an early Altec seminar on acoustical mapping techniques, decided to develop a more accurate approach based on a transparent sphere rather than a flat map. In 1982, his "Sphere Program" was marketed by Community. The package consisted of two transparent hemispheres, and an optional light source, and was used in conjunction with an HP 41 scientific calculator. This was the only program endorsed by Syn-Aud-Con and a number of sound contractors and consultants still use this design aid today.

Version 2 of this program was known as the PHD™ Program and was distributed by PHD Software. The HP 41 magnetic strips were replaced by floppy disks for the IBM personal computer, but the sphere remained. Aside from using the sphere for

documentation, the computer system could optionally print out flat maps *a la* Altec's array perspective technique. Version 2 also introduced Q-Plus, an ancillary program that maintains the loudspeaker patterns used in the graphic section of the program. Q-Plus can calculate the Q (and Di/directionality) of any loudspeaker as well as review, add, or delete horn patterns. A (monochrome) version that ran on the Crown Tecron TEF analyzer was also introduced. In March 1987, I received a "prebeta" copy of version 3.0 which offered all the features of 2.0 but without the need of the plastic sphere. All the speaker layout, mapping, and documentation could now be prepared on the computer. The program was shown at the 1988 NSCA and was released soon afterward.

Version 3.0 was not released for the

TEF machine, as color capability was considered critical for visualization and TEF does not support color graphics. Furthermore, the monitor screen on the TEF was too small for the adequate detail to be viewed on the graphics. I thought this was unfortunate, as the concept of integrated simulation and test within the same system is very powerful, and the only sensible direction of performance prediction and proof of performance. The next step in computer prediction of sound system performance is to close the loop and integrate this with CAT (computer-aided test). The proof of the pudding of all of these sound system design programs will be to be able to complete the accuracy of the predictive results with the measurements (which hopefully will be accurate).

PHD 3.2 has been distributed by *Sound*

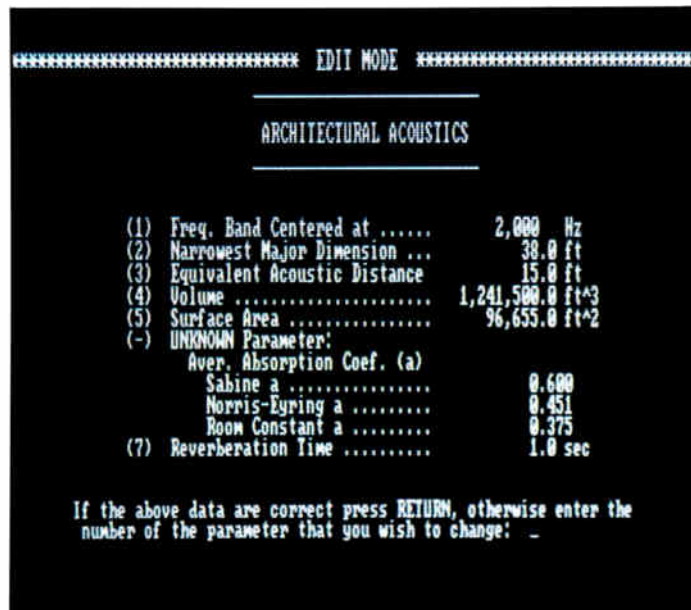
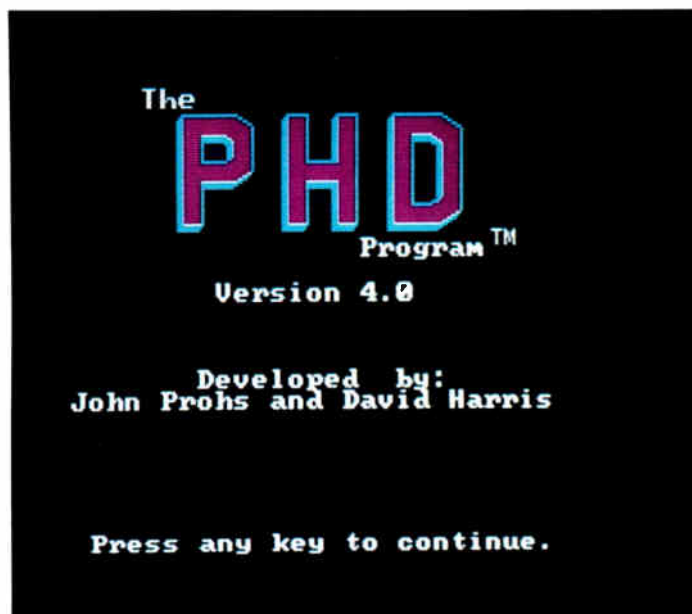

Acoustical Parameter Report

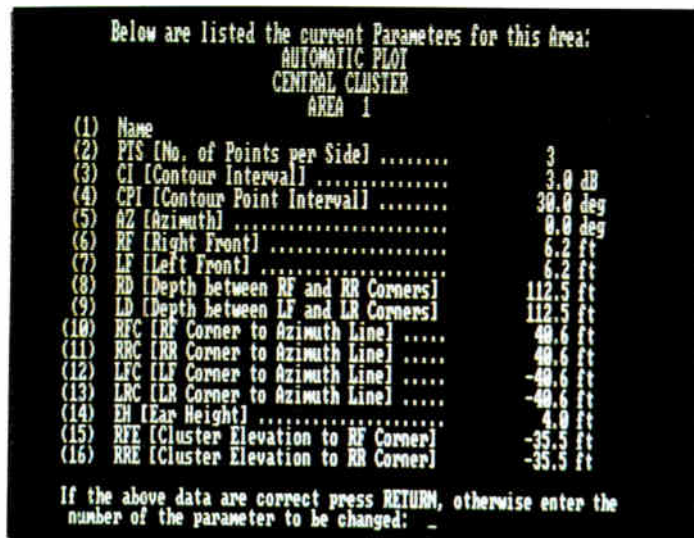

Architectural Mapping Data

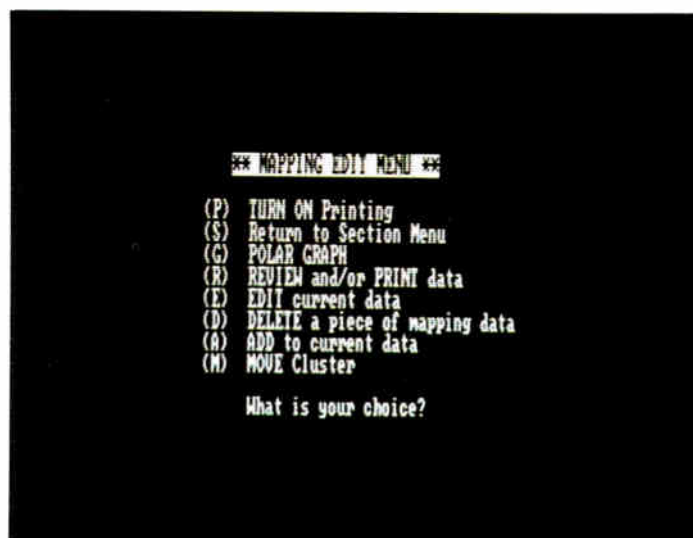

Architecturing Mapping Edit Menu

& Communications magazine. A \$300 donation to the Heyser Memorial Fund is required. This review is of the latest version of the program, 4.0, which will be available about the time this review is printed. All registered users of the program will receive this release at no charge.

HARDWARE REQUIREMENTS

PHD 4.0 will run on IBM (MS-DOS) compatibles using dual 360LK 5.25 inch floppy drives. A medium resolution (CGA) graphics board and color monitor are required. An Epson compatible printer can be used for hardcopy. This IBM XT class configuration can be bought for about \$1,100. Alternatively, higher resolution color video systems with an EGA or VGA graphics board/monitor (that is backwards compatible with CGA) would be a better investment and would add about \$500 to the tab. Also, the XT is getting a little outdated and the higher performance AT class has come down in price. AT type computers are faster, have larger power supplies (so you can add more goodies), use higher capacity floppy disk drives, and so on, yet cost only about \$500 or so more than the XT units. The very popular Hercules high resolution monochrome graphics standard will not normally work with PHD. There are emulator programs

that allow CGA software to work with the Hercules graphics standard, but there are MS-DOS computer compatibility problems with many of these combinations of hardware and software.

A hard disk drive would save a lot of time eliminating floppy disk swapping and searching for which disk had the data files you were looking for. PHD software will work with a hard disk drive and the manual provides installation procedures. Hard disks with controller boards cost \$250 on up. The present version of PHD does not support use of the math coprocessor option on MS-DOS computers. Math coprocessors cost between \$150 and \$250 depending on the speed and type of microprocessor used in your computer. The coprocessor plugs into a socket on the computer's motherboard and would be an appealing addition, as software that takes advantage of this option can run from two times to ten times faster. Note that the PHD™ Program is not computationally intensive and computer processing time, even for slow XT configurations, is not significant.

SOFTWARE REQUIREMENTS AND AVAILABILITY

The program is not copy-protected.

Unlike some of the software sponsored by speaker manufacturers, the PHD™ Program is not restricted to authorized dealers, but is available to everyone. The program includes data library for JBL, Community, EV, Altec, TAD, University and Renkus-Heinz components, and is the most comprehensive of all software programs. To print graphics you will need either a "screen dump: software utility file" (such as GRAPHIC.COM on your DOS disk or one of the more comprehensive utility programs such as Pizazz Plus [508/433-5201] or Graphics Plus [206/937-1081].) This will let you exploit special features of some printers such as color printing, wide carriage, high resolution 24-pin dot matrix, or laser printing.

USER INTERFACE

PHD is menu driven, with a main menu and sub-menus. All data entry is by keyboard, and no support is provided for a mouse, special function keys or a graphics tablet. PHD uses four color limited resolution graphics. Some of the latest sound system software programs offer more sophisticated user interface with features such as windows, pull down menus, mouse support and high resolution graphics. The program does provide a "Tutor model," a contextual help system, and this can be

TEF[®] eliminates guesswork.



When he speaks, everyone listens...

...but some can't hear.

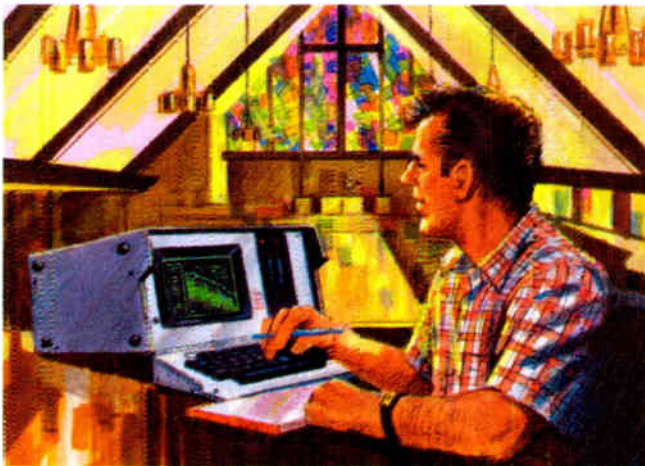

TEF shows you why.

Echoes arriving at different times from multiple directions. Poor coverage. Rough frequency response.

Whatever the problem, TEF identifies it and shows you how to fix it.

Eliminate the guesswork. Get TEF. Now starting at only \$152 per month.*

To set up a TEF demonstration or for more information, contact Techron.

TECHRON[®]

1718 W. Mishawaka Road, Elkhart, Indiana 46517 • (219) 294-8300

Techron is a division of Crown[®] International, Inc.

Circle 214 on Reader Response Card

*Based on approximate monthly cost of \$152.00 for 60-month lease on a TEF 12. Prepaid purchase option at 10% of TEF 12 list price plus tax required.

switched on or off. This learning aide is helpful, and is just now being adopted by some of the other sound system engineering programs.

DOCUMENTATION AND SUPPORT

PHD 3.2 was provided with its manual on the floppy disk. No pictorials were provided in this manual. A fairly comprehensive printed manual is now being prepared with graphics and design examples. I have been using a preliminary version of this new manual for this review and have found it clear with information and hints beyond the "help" mode in the program. Program setup, operation, and applications are covered. Also helpful (and not supplied by most of the other programs) is a number of jobs on the data disk, from small to quite large. One of these jobs was used for the graphics in this review. PHD 'Mapping Data Guide Overlays' are included which aid in taking mapping measurements, and a worksheet is also included.

PROGRAM FLOW

You advance through each module in order, since each section is dependent upon the other. The Architectural Acoustics module is dealt with first (reverb prediction, room surface area and volume,

etc.). Most of the Architectural Acoustics section can be skipped if you only want to know about the direct sound field and are comfortable in ignoring the reverberant field (such as a very dead room, or an outdoor facility). Architectural Mapping is next, where seating areas and other room boundaries are defined. Polar Graphing is then used for defining cluster locations and horn aiming. Power Analysis follows, horns and drivers are selected, and shows the power required to achieve the desired SPL on-axis. The final step is the performance analysis where uniformity of direct sound coverage, on and off axis, intelligibility, gain, and the interaction of the horns on these parameters are examined.

GETTING STARTED ARCHITECTURAL ACOUSTICS

The four major acoustical parameters required are the volume, surface area, average absorption co-efficients, and reverb time. When any three of these parameters are entered, the fourth will be automatically calculated. If more than one of these parameters are unknown, the program shifts into a utility sub-module for determination of the needed parameter.

The architectural acoustics reverb module is fairly comprehensive, although it is not as efficient as some third party

utility programs for "what if" simulations for room reverberation optimization. Specifically, you cannot go back and completely edit the surface material data, but must re-enter all the data as a new room. One situation where this is limiting is when you want to quickly test out a room for empty and full crowd conditions.

Equations for Sabine or Norris-Eyring, with or without Fritzyoy, are all offered for calculation of reverberation time. In the power analysis section you also have an option of specifying the absorption coefficient for each surface (to factor in early reflection absorption), which can provide more accurate results than the statistical reverberation calculations. This is especially useful for jobs that have marginal acoustics and you suspect you will have a problem.

While most of the new 'third generation' sound system design programs require the time consuming approach of specifying each surface material (whether you want to or not), the PHD™ Program defaults to statistical reverberation calculation options of Sabine, Norris-Eyring or the slightly higher accuracy of Fritzyoy method, and only later, if you find you are in a questionable situation, provides you with more powerful (and tedious)

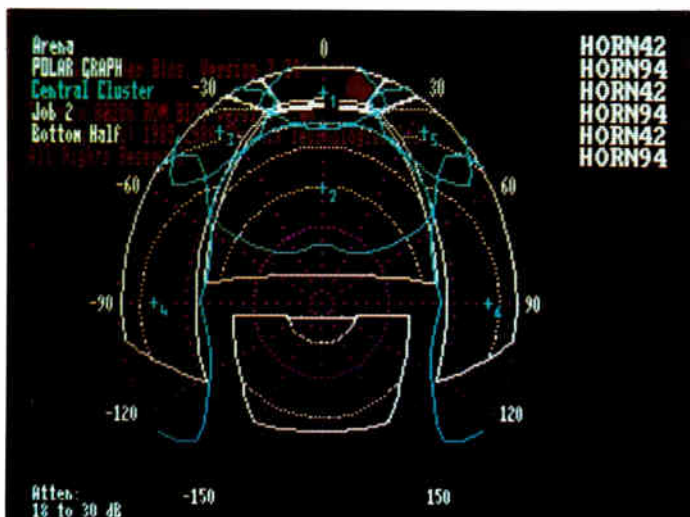

Polar Graph of Room with Horn Coverage (-6 dB Contours Only)

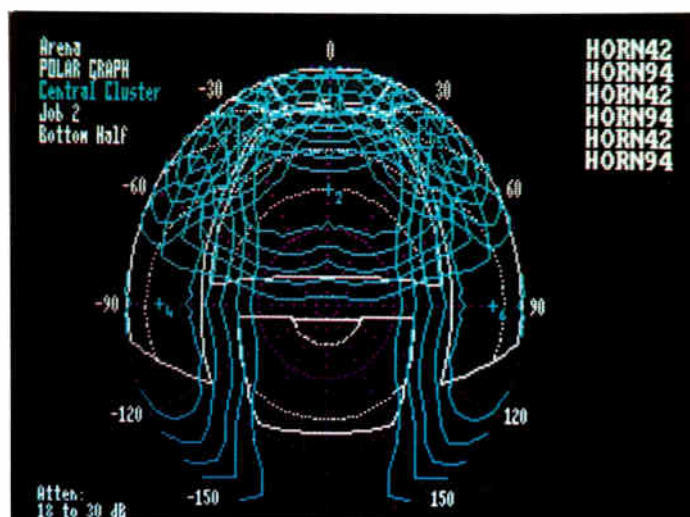

This figure shows all horns with 3 dB, 6 dB, 9 dB, 12 dB and 15 dB contours showing.

techniques.

The frequency band of interest is selected. Six octave bands are available from 125 Hz to 4 kHz, with the 2 kHz being considered the most critical band for intelligibility.

Rough determination of RT60 will require less than 30 minutes with any of these programs, but count on at least another half an hour checking on surface materials, etc. with architects and interior decorators, as well as looking up absorption co-efficients. Calculation of room volume and surface area, even for complex and oddly shaped rooms is handled effectively by the PHD architectural acoustics module. A comprehensive library of absorption co-efficients is built into the program, and files can be easily expanded or edited.

The operator is then asked for the Equivalent Acoustic Distance (EAD). This is the distance in which a good listener can understand a good talker speaking with no amplification.

On completing this module, the operator returns to the Main Menu and selects the Architectural Mapping section.

ARCHITECTURAL MAPPING

By entering the room and speaker information into the program, a model of the proposed sound system and the room is created within the computer.

This information may be taken from the blueprints, or actual on-site measurements. A hand drawn sketch is prepared or the blueprints can be marked up. The operator must predetermine whether the

design will be a central cluster or multiple clusters early in the simulation.

I mark up the floor plan and elevation drawings with a scale on the borders of the prints. A T-square or a drafting table will be helpful. PHD allows you to use feet or meters but you must stick to whatever you decide to use.

MAPPING DATE GUIDE OVERLAYS

Two transparencies are supplied with the program and make up the Mapping Guide Overlays. The two sheets can be used with a plan of the room scaled down to fit a standard sheet of paper or on larger copies. In any case, their function is to help orient the measurements during mapping.



“...SOUNDSPHERE LOUDSPEAKERS ARE THE REASON FOR THE CLARITY OF SOUND”

Don Hartley/President • Dynamic Sound • Exeter, NH

Comments Mr. Hartley on the Sun Foods store, “The Lowell store has approximately 76,000 square feet and is the largest supermarket in New England. It contains 24 checkout counters....

...This store is owned by Hannaford Brothers and they basically have three or four names that they use for different stores. In 1984, they built a store similar to this, with a 22-foot ceiling and at that time we were just completing a new installation at their warehouse, which comprised of twelve 250-watt amplifiers and approximately 80 Soundspheres. Since the ceiling in their new store was going to be 22-feet high, we strongly recommended Soundsphere #110's and guaranteed equal sound in each and every part of the store. This installation was completed; and last year when another store was planned in Lowell, they called us for an installation similar to Keene....

...The size of the store and the use of Soundspheres have caused many supermarket competitors throughout the United States to evaluate this store, and we have received numerous phone calls about the sound system since it works so efficiently and about its clarity where you have all concrete walls, concrete floors and open girders in the ceiling. We have given all of them the same answer that it is very obvious the Soundspheres are the reason for the clarity of sound.”

We strongly recommended Soundsphere #110's.

Write or call direct for further information.

SOUNDSPHERE A PRODUCT OF
SONIC SYSTEMS, INC.

737 Canal Street • Bldg 23B • Stamford, CT 06902 • USA • Tel (203) 356-1136

WORKSHEET

Data entry into the worksheet from the marked-up prints can take from a few minutes on a simple job, to half an hour or more, depending on the complexity and number of the seating planes and sound system. Although some users do not use the worksheet, but enter the data directly into the program, mistakes become harder to trace. The (architectural data) worksheet documents a seating area, contour resolution, plan view and elevation data.

Automatic or manual point generation for boundary areas is selected, depending on the complexity of the area.

The loudspeaker clusters are named. Note that in the editing mode, entire cluster locations can be easily moved, rather than requiring tedious relocation of each speaker component as required in some other programs.

An optional PAG-NAG subroutine for predicting gain before feedback is provided. The number of open mics with this cluster is asked for the distance from the cluster to the closest open mic, and the maximum distance average that a talker will be from the mic. The listening area location is then named.

The automatic plotting feature outlines any four- or three-sided area (or even a line), up to 15 points for each side for print-outs. The designer selects how many points per side he wants to plot and each side of the area will be divided accordingly. Curved walls are not directly supported and should be approximated with a number of straight lines that fall outside of the curved boundaries. I like to sketch in the curve so I don't try to improve room coverage for an area outside the boundary of the job.

The seating areas with their dB contours are drawn and then you start adding and aiming the horns. The program does not let you mirror symmetrical clusters or identical split clusters, which would be a time saving and error reducing step.

You can display the room, the horn isobar and decibel contours on the screen. Each will have their own color. After the

room is mapped on the polar grid choose the desired horn. The manual suggests that after the graphics are printed out, you can separately hand color each horn's pattern to avoid confusion.

An unlimited number of seating plane areas may be entered within one job. If the seating area is all on one plane, then only one floor section needs to be entered. Details such as small outcroppings of the wall, beams, etc., generally are not entered, as the screen would become too busy. Obstructions can be clearly seen (an advantage of the program), but to effectively get dimensions of the shadowing areas it is necessary to plot on the prints with a ruler. Although this technique is not covered in the manual, this will be covered in an update. While leaving out the walls and ceiling features expedites modeling, care is required by the designer to carefully view the room from time to time, in order to account for features, such as beams, reflecting surfaces, and other characteristics that should be considered that will not appear in the computer model.

The CGA graphics standard used by the program is adequate for the text and report format, but shows its limitations in the only graphics provided, the Polar Sphere Module. This is the section that replaced the transparent plastic sphere. The graphics can look very busy and somewhat confusing when a number of norms with a number of contours are used. Whether the use of the sphere to flat map transformation or the lack of resolution and colors is the problem is hard to say, but almost all of the other sound system design programs have switched over to high resolution graphics. It is too bad that this latest release could not be upgraded to the EGA or VGA graphics standard. In a recent conversation, John Prohs lamented that the entire program would need to be rewritten in a different computer language if more colors and higher resolution graphics were to be used.

As there is no graphics printout in the reports, you must screen dump the polar

sphere graphics. Since obstructions are manually sketched into the polar sphere graphics, the largest possible printout would aid in getting enough engineering detail into the plot. A color wide carriage printer would be helpful, and one of the new 24-pin, color, C-size dot matrix printers (from JDL and AMT) in conjunction with a software screen dump utility program would be ideal. It takes about 10 minutes for a color screen dump on a dot matrix printer, although this is a function of the printer, not the PHD™ Program.

Room mapping is fairly quick after you become familiar with the program. I usually look over the floor plan and elevation prints for half an hour, another half an hour to add scales to the border and sketch in the approximated room model. There is no provision for mirroring symmetrical rooms, a feature provided by some of the other programs.

SPEAKER AIMING

If the coverage is not as required, then re-aiming a new speaker location or a speaker with a different pattern may be tried. Basic intuition and experience are used to make these determinations, i.e., if the room is wide and not too deep, then try a wide coverage horn, if the room is long and narrow try a long thrown horn. The polar sphere with the sound contours is a very effective way to depict uniformity of coverage. Manipulation of the speaker's orientation would be far more efficient if the user could look at the speaker's pattern superimposed over the room map (as is now provided in the polar sphere section) and use the cursors to re-arrange the speaker's aiming angles.

Preliminary calculation of time delay settings for secondary clusters can be determined through the Architectural Mapping module's report.

Different drivers can be used on different horns. The data libraries can hold almost an unlimited number of horns and drivers, but the design simulations are limited to clusters of 18 components. Since you will be plotting only midrange or only

(continued on page 67)



People

Lange Joins Altec Aiphone Promotions

Numark's New East Coast Sales Manager

George Rose was appointed East Coast regional sales manager at Numark Electronics Corp. (Edison, NJ), for which he will be a part of the expansion of DJ, video and consumer electronic products. He will oversee sales management and distribution of these products throughout the Eastern seaboard.



George Rose

Siderski Additions

Jerry Hummel, former chief engineer of Editel-Chicago, was hired as special projects consultant for Siderski Electronics Incorporated (Elk Grove Village, IL). Also new to the Siderski staff are Fred Gervase as senior application engineer, and Thomas Berger as project engineer.

Ravn Moves Into Valley

Jorgen Ravn was appointed to the newly created position of sales director of Valley International, Inc. of Nashville, Tennessee. Ravn was previously from dbx, where he was regional sales manager.

Anixter Names Browe

Bernard Browe was appointed vice

president-communication industry sales at Skokie, Illinois-based Anixter Bros., Inc. He is responsible for sales to manufacturers of telephone systems. Prior to joining Anixter, Browe was vice president/general manager of Metropolitan Fiber Optics Co.

Badke "Crowned" Engineer

Crown International (Elkhart, IN) appointed Dennis Badke product applications engineer. Badke has been with Crown for 14 years, including six years with the engineering department.



Dennis Badke

Lange Now Altec's VP Of Sales/Marketing

Altec Lansing (Oklahoma City, OK) has appointed Charles "Chuck" Lange to the position of vice president, sales and marketing. Prior to joining Altec Lansing, Lange was vice president, sales and merchandising for The Bolen Corporation in Milwaukee.



Charles Lang

He received his BS in marketing from the University of Wisconsin, and is a member of the American Marketing Association.

Kleiman Joins E-V



Claude Kleiman

Claude Kleiman was appointed market development manager for wireless mics at Electro-Voice (Buchanan, MI). Working with the company's market development managers, he is responsible for the marketing and sales of Vega and Electro-Voice wireless mics to all pro audio markets.

Two Managers Move Up

Aiphone Corporation (Bellevue, WA) has announced the promotions of James E. Morrison and Harry Quanz. Morrison, formerly national sales manager, has been made vice president of national sales. Harry Quanz, who used to be the firm's marketing and advertising manager, is the new vice president of marketing.



Harry Quanz



James Morrison

As vice president of sales, Morrison will oversee regional sales managers, the inside and outside technical sales staff, and customer service personnel. He has been with Aiphone for seven years.

Quanz, who has been with Aiphone for three years, is responsible for the company's advertising, marketing and public relations programs. Prior to joining Aiphone, he was executive vice president of Goodman Quanz, Inc. ■

Contracting Close-up

Audio Services, Defense Facility News

Floating Sound

Putting a sound system into a steel-hulled structure doesn't allow much leeway for error, but Audio Services (Virginia Beach, VA) rose to the occasion for its work on *The Spirit of Norfolk*. The vessel is a 165-foot cruise ship that sails the Norfolk harbor on tourist, corporate and private charter cruises.

The ship features three full decks (one open, two enclosed) with full disco and live entertainment showrooms, as well as full A/V capabilities for meetings, etc. Three independent sound systems—one on each deck—use a QSC MPS2300, with an additional QSC A2150 integrated amp for the enclosed decks to power the delay on the 70-volt speaker system.

Peter Florance, owner of Audio Services, designed the system and installed it with two others. "The installation was a combination of entertainment and emergency announcement capability, so reliability and versatility were critical," he said.

Working on a new sea-going vessel afforded some unusual considerations, like corrosion-resistant units that could withstand the salt air. On the plus side, because the ship was not yet fully constructed when Audio Services was contracted for the job, Florance and crew were able to do some prewiring and pre-installation before the ship was completed. The rest of the job was finished once the *The Spirit of Norfolk* was docked.

"Make sure you know what the customer needs before you start the job—it's very difficult on a ship to rewire or change," cautioned Florance. "When you're talking about marine construction, it's very difficult to back up!"

Facility Upgraded

The Engineering Installation Division of the Tinker Air Force Base in Oklahoma recently began upgrading and modernizing the existing DOD Joint Communications Facility in Permasen in the Federal Republic of Germany.

The work will result in an integrated high-frequency radio transmit facility

with computer controls and automated message processing functions. The system is composed of eight 10Kw HF-USB transmitters and monitor receivers to be installed and connected to an existing government-furnished antenna system. An operator's console will be provided for remote control selection and configuration of antennas, transmitters and monitor receivers. The equipment for the radio operations area will perform functions on the received data for Autodin, including manipulation, storage, conversion to voice, continuous wave, data signals and queuing and forwarding of the signals to the transmitters.

Harris Long Range Radio Division (Rochester, NY) was awarded a \$4 million contract to supply the high-frequency radio equipment, along with full logistics support, on-site operator training and maintenance for initial users. ■

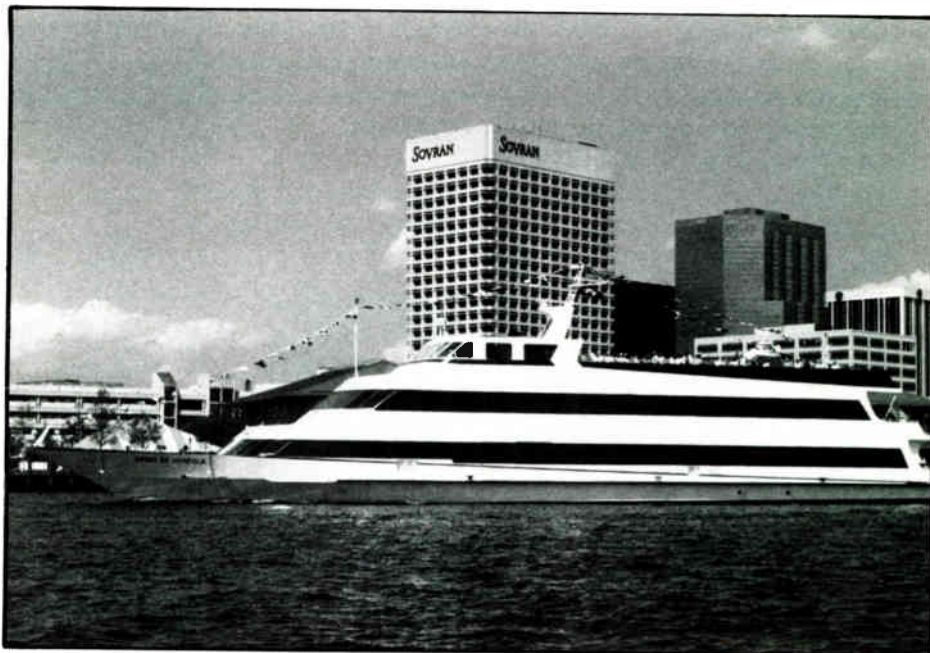

Audio Services worked on the ship before it was in the water.

(continued from page 50)

ness or commercial background music system.

"Demand for fully featured systems is getting greater because people realize there are more choices available than previously," he elaborates. "Some of our own dealers are now outfitting a number of offices and commercial establishments with rather high-end product, largely because the client has recently had his or her own home done, or has seen a friend's home done with a multiroom, multisource system. Now they're asking for the same items in their businesses."

Total order price naturally depends on just how high-end a client wants to go, as well as on the installation's level of difficulty, Donald adds. "A contractor can go in and do a volume control and a pair of speakers and we're talking \$200 to \$300 per room, plus installation." It can go up from there, he notes.

Costs may also vary by room. "For instance, one office may have a separate source system to accommodate an executive who likes to listen to CDs or tapes that are different from what the rest of the system plays."

But Sonance says it is equally determined to put its dealer-installer base in touch with the growing lower-end market for sound systems which includes single-location shops, small businesses and professional offices.

"We've got speaker products coming out that are going to be down around the \$100 to \$125 a pair price range specifically to address that segment," he reveals. Additionally, late-model programmable CD changers are gaining solid ground with customers at both ends of the market, he reports.

According to Tom Roseberry, vice president of marketing and sales at Innovative

Electronic Designs Inc., "More manufacturers are coming to the marketplace with digital signal processing equipment for audio." The VP says IED's emphasis on computer-controlled audio systems and the utilization of DSP has led it to enjoy "a very strong market that has grown progressively in a very sharp curve over the last four years and that we anticipate will continue to grow for quite a period of time."

IED's systems turn up in many facilities employing background music such as factories, airports, convention centers, even racetracks. Similarly, Roger Carroll, marketing manager for Industrial Research Products, which makes black boxes for sound reinforcement installed engineered systems, reports IRP's new modular System 41 "is getting quite active in the industrial markets right now." ■

WHEN THE TIME COMES FOR PERFECT SOUND, THERE'S ONLY ONE DELAY YOU SHOULD PUT UP WITH.

ADD-2
ADD-3

Audio Digital sets the world's standards for precise synchronization in the most demanding acoustical environments.

The Audio Digital ADD-2, with two delay outputs, and ADD-3, with three delay outputs, bring sound perfection within easy reach.

- Microprocessor controlled and programmable from front panel in 15 microsecond increments.
- Easy to use...with the industry's only alpha-numeric display for precise settings and diagnostics.
- Rich, transparent sound quality. Low distortion and wide dynamic range.
- Competitively priced for utmost affordability.
- Reliable. UL listed. Unique security mode.

Audio Digital Inc., 1000 S. Bertelsen, Suite 4
Eugene, Oregon 97402 (503) 687-8412
1-800-423-1082



Literature

Full-Line Catalogs From Belden, Bird

Amp's Selection

Amp Incorporated has a selection of written material to choose from.

Catalog 88-811 covers the AMP-modu .025 square interconnection system, including board-mounted posts and receptacle assemblies, posted

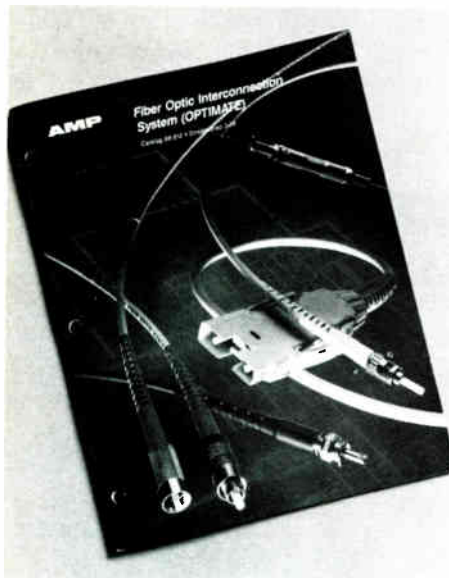

discussed in the 88-page catalog 88-812, from FDDI-compatible Fixed Shroud Duplex products to the Optimated mechanical splice. Product facts, performance characteristics and materials information on each product are provided, backed by detailed product drawings and photographs.

Circle 27 on Reader Response Card

Full-Line Catalog From Belden

Belden Wire and Cable is offering a full-line product catalog that features more than 3,000 product codes. The 382-page catalog is divided into 11 product sections. Complete technical information including construction details, performance characteristics and standard lengths are provided for all product families. Also included is a cable finder chart and a detailed part

number index. In addition, a standards reference guide, an NEC reference chart and a glossary of terms are featured.

Circle 28 on Reader Response Card

Bird Electronic Corporation's Catalog

Bird Electronic Corporation has released its a 60-page full line catalog of RF power measuring equipment and accessories. It includes photos plus detailed descriptions, specifications and ordering information. In addition to Bird's wattmeters, selections of calorimeters, plug-in elements, line sections, QC-connectors, RF loads, attenuators, switches, and more are presented.

Circle 29 on Reader Response Card

Info On Modular Cabinets, Series 2000 From Elma

Elma's 110-page catalog details several modular enclosures for desktop and 19-inch rackmount applications. It includes full detailed drawings and assembly instructions along with ordering information. Series 2000 includes plug-in units, front panels, ejectors, card guides, etc.

Circle 30 on Reader Response Card

Products

University Expands Mixer/Amp Line; CCD Camera Offerings

header assemblies, and wire-applied contact housings for crimp snap-in pin and receptacle contacts. The 104-page catalog also includes a mating post selection guide, information on accessories and application tooling, and more.

Catalog 73-177, 54 pages long, covers the AMP-Latch ribbon cable connector system that mass terminates up to 64 conductors simultaneously without requiring advance preparation of cable. Detailed information on AMP-Latch receptacle connectors, PCB headers, pin connectors, DIP plugs, card edge connectors, etc., is provided.

The Optimate fiber-optic family is



Precision Digital Meter

Symetrix's SX205 Precision Digital Meter is a microprocessor-controlled,

2-channel level display that measures both voltage and power. The half-rack unit allows bar graph or dot format to

be selected, and peak-hold time to be adjusted from instantaneous to infinite.

Circle 10 on Reader Response Card

University Adds To Its 9000 Series

University's 9000 series of mixer/power amplifiers are for use in churches, schools, auditoriums, business/industrial environments, background/foreground music systems and paging systems. New to the line are the 9003, a 30-watt module with six input ports, and the 9012, a 120-watt piece with one input port.

University has also introduced the US690 and US690F supercardioid, shock-mounted, gooseneck dynamic mics.

Constant-directivity paging projectors new from the company include the PA 430 and PA 430T (transformer version). The manufacturer claims that the paging horn maintains accurate pattern control between 2 kHz and 10 kHz. Its swivel design allows aiming over 360 degrees with hand tightening.

Circle 11 on Reader Response Card



Expandable Switcher Package

The SuperSwitcher Plus is Javelin Electronics' new microprocessor-controlled switcher system. This ex-

pandable unit is composed of a master control, a video gathering panel, and a power supply, and it allows sequencing and call up of 10 video cameras.

Circle 12 on Reader Response Card

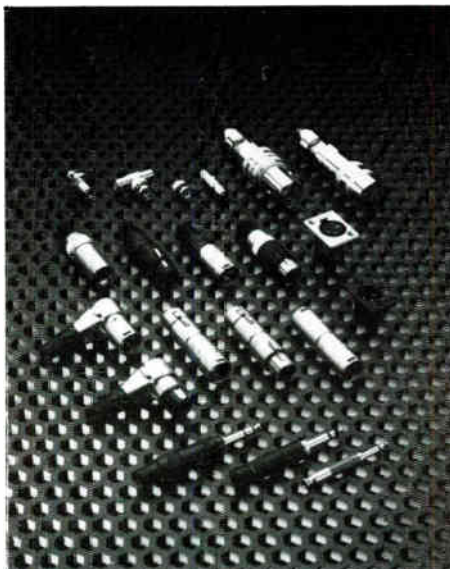

New A/V Connector Line

Belden Wire and Cable has added Neutrik audio and Kings video connectors to its broadcast product line. Video connectors available from Kings include BNC and Tri-loc connectors, bulk head jacks and adapters. The Neutrik line includes compact and screwless products that feature 3-prong internal strain relief.

Circle 13 on Reader Response Card

Timelapse Recorder And More From Gyr

The TLC2400 is Gyr's timelapse video recorder. It can record up to 240 hours of digitally compressed audio on a two-hour VHS cassette. Other features include a seven-day on/off timer, time/date generator, and electronic security lockout.

The TLC1400-S10 Plus allows its switching program to be implemented on like recorders via a personal computer or transfer box; also, a virtual page feature displays text over only

those camera positions to which the text applies.

The new Digiquad DQ8 with zoom is a new digital multiplexer that expands the coverage of CCTV systems, says the manufacturer. It allows display of up to eight camera views, four at a time.

The TLC1400-DC timelapse recorder operates on either 120 VAC power or with a 12-volt battery, thus enabling it to be used in remote locations such as law enforcement vehicles, buses, planes, etc.

Circle 14 on Reader Response Card

Speakers For Music, Speech

The AE-4 single-amped, electronically coupled loudspeaker system from Apogee Sound Inc. is meant for musical and speech applications. The AE-4CV version is available in black or grey, and has rigging hardware on its sides for permanent installation. The AE-4AV features an internal fitting for a tripod, steel trim, and the rigging hardware found on the CV.

Circle 15 on Reader Response Card

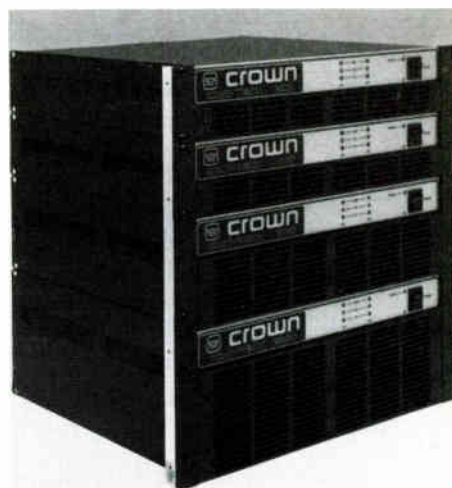

Crown Power Amps

Crown International designed the ComTech series of power amps for the sound contractor market. Units are available in 200-, 400-, 800-, and

1600-watt versions on a maximum average in mono mode. The 200- and 400-watt models stand 3.5 inches tall, while the 800- and 1600-watt models are 5.25 and 7 inches tall, respectively. Each is 19-inch rack mountable.

Circle 16 on Reader Response Card

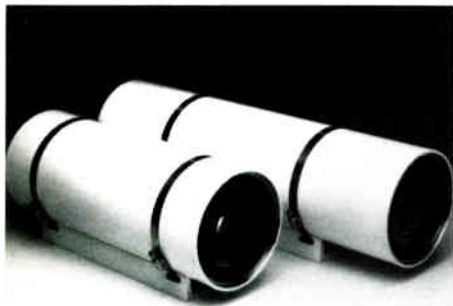

has developed an ultrasonic tape measure that provides transfer of measured data to its built-in calculator mode for adding lengths as well as calculating areas, volumes, and circumferences of circles. Its functions include instant recall of the last data read, a tape locking system, etc.

Circle 18 on Reader Response Card

For Touring Sound, More

The RS880 loudspeaker system is the newest in Community Light & Sound's RS series. The 3-way units is housed in a trapezoidal, braced plywood enclosure covered with black carpet. It was designed for touring sound, fixed installations, and other flying arrays.

Circle 19 on Reader Response Card

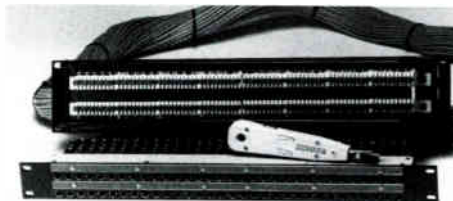

Pre-Wired Punch-Down Patch Bay

Audio Accessories, Inc. has developed a series of pre-wired patch bays

incorporating the Krone punch-down terminal blocks. These punch-down units are available with either a connect or a disconnect block, and with 24, 26, or 32 long-frame .25-inch jacks per row. They can be supplied in a self-contained chassis, or with a cable harness between the panel and hinged back plate.

Circle 20 on Reader Response Card



Celestion Expands SR Series

The SR3 PA cabinet and SRC3 loudspeaker processor have been added to Celestion's SR loudspeaker series. The two new units are designed for stage monitoring, and can also be used for fill-in of live/pre-recorded material broadcast in night clubs, theatres, churches, restaurants, hotels and stores.

Circle 21 on Reader Response Card

Heavy-Duty CCD Cameras

Burle's TC106 series 2/3-inch format CCD cameras are prepackaged in environmental-resistant housing. The cameras offer continuous service in difficult environments, so their suggested applications include surveillance, industrial, or military.

Circle 17 on Reader Response Card

Electronic Tape Measure

Arax Libermann Ltd. of Hong Kong

New Large Display Countdown Timer for timing speakers, events and live broadcast.



We'll send you a FREE brochure telling how the Visual-Pager Model 604 large display Dual Count up/ Countdown Timer will help you start and stop speakers, events and broadcast on time. Large 5.5 inch remote readout display clock(s) can be seen from 150 feet. Send for a free brochure today describing the timer and easy installation. Discount to dealers.

- Two timers in one package
- Multiple output displays
- Large easy-to-read displays
- Satisfaction Guaranteed

Free Brochure Call Toll Free 1-800-635-3811

Microframe Corp. 8236 E. 71 Street Suite 356 Tulsa Ok. 74133



\$598

TB4

Remote-Head CCIR Monochrome CCD Camera

The 6700 series remote-head CCIR monochrome CCD camera is new from Cohu. It features a remote imager, and a 15-foot cable that connects the remote imager to a camera control unit that measures 2 by 5 by 7 inches. Designed for scientific and industrial applications, it is also suited to security/surveillance applications where space limitations are a consideration.

Circle 22 on Reader Response Card

Circle 290 on Reader Response Card

CALENDAR

Upcoming Events

SEPTEMBER

IEEE Broadcast Symposium: Washington, D.C. Contact: 212-705-7900. September 21-22.

Syn-Aud-Con Sound Engineering Seminar: Norman, IN. Contact: 812-995-8212. September 22-24.

OCTOBER

National Electrical Contractor Association (NECA): Chicago, IL. Contact: 301-657-3110. October 1-3.

Syn-Aud-Con Sound Engineering Seminar: Norman, IN. Contact: 812-995-8212. October 5-7.

Hong Kong International Electronics Fair: Hong Kong. Contact: 212-838-8688. October 16-19.

Syn-Aud-Con Sound Engineering Seminar: Secaucus, NJ. Contact: 812-995-8212. October 17-18.

87th AES Convention: New York, NY. Contact: 212-661-8528. October 18-21.

Georgia Tech Education Extension Courses: Washington, D.C. Contact: 404-894-2547. October 10-11; Nashville, TN, 17-18; Boston, MA, 19-20.

Society of Motion Picture and Television Engineers: Los Angeles, CA. Contact: 914-761-1100. October 21-25.

Security Show: Los Angeles, CA. Contact: 213-376-8878. October 25-27.

Syn-Aud-Con Sound Engineering Seminar: Rockville, MD. Contact: 812-995-8212. October 26-27.

(continued from page 60)

the high frequency components at any one time, this may not be a problem. For very large jobs you may need to break the job into quadrants.

The original Sphere/HP 41 calculator program and the first release of the IBM compatible program both used a transparent plastic sphere, with all the results of the calculations (from the HP 41 or the computer) presented in a "report" format, that is, as a data listing of the information for a specific location.

While PHD releases 3.0 through 4.0 depict the room and the speaker coverage graphically using architectural mapping techniques, all the other performance simulations still use the "report" format.

Briefly, the concept behind using spherical mapping is to depict the room from the horn's perspective. Imagine a gigantic transparent fish bowl around the cluster. If this was mapped to a flat piece of paper then you would have the "array perspective."

Using the computer to compensate for a spherical to flat transformation can reduce some of the distortions inherent in this process.

Other approaches to coverage used by the competing programs have used plan views (overhead) of the floor with either numerical dB levels provided at various data points or intensity contour maps overlaid over the floor plan. PHD uses a data report for most of the simulations (see reports). I feel that data that are common to most or all of the room, such as reverberation time, are effectively con-

veyed using this format, while performance parameters that vary throughout the listening area such as direct sound levels and intelligibility are best communicated through both numeric and contour plots.

The numerical plot format is most useful in providing hard data on performance acceptable, while the contour plot provides an intuitively satisfying result.

PHD provides a statistical analysis of the variance of the low to the high points throughout the specified area, but I do not find this as useful as a plan view with numeric data points and/or contour plots.

The program provides the option of selecting indoor or outdoor facilities. Unlike the indoor selection, the outdoor function does not compensate for the effect of air absorption, as this was considered too hard to predict. PHD has an almost unlimited capacity of large areas, and would be effective for large hillside amphitheatres, siren/voice warning systems and stadiums.

Designers of outdoor facilities will be disappointed that there is no control of level/distance loss. Experienced engineers usually try 6 dB, 8 dB, 10 dB and even 12 dB drop with doubling of distance to account for varying humidity effects, wind, ground/air temperature effects, etc.

In next month's continuation of our review of the PHD™ Program we will explore the power analysis and performance analysis modules.

Klasco is president of Menlo Scientific, Berkeley, California.

Visual-Pager for Churches, Auditoriums and Restaurants

The **VISUAL-PAGER** system quickly pages an individual from a waiting room, restaurant or a large audience without disturbance. **VISUAL-PAGER** by Microframe Corp. is used in hundreds of churches all over America for quietly paging mothers to the nursery when needed. Send for a free brochure today describing easy installation. Discount to qualified system installers.



Visual-Pager Systems from \$398
2, 3, and 4 Digit versions available

FREE Brochure "B2"- CALL TOLL FREE 1-800-635-3811

Microframe Corp. 8236 E. 71 Street Suite 356 Tulsa Ok. 74133

B2

Circle 291 on Reader Response Card

CLASSIFIEDS

HELP WANTED

SHARE THE PROFITS

SERVICE, DESIGN, AND INSTALLATIONS
Positions available in Club/Hotel and Theme Park divisions with projects local and worldwide.

INSIDE AND OUTSIDE SALES POSITIONS
are also available in our rapidly expanding corporation. Team leaders/managers share in the profits you create. Unlimited future potential with possible shared ownership of our locations. Send resume to:

William Dettman
Pro Sound & Stage Lighting
13110 Magnolia
Garden Grove, CA 92644
(714) 530-6760
or (800) 678-9700



**Washington, DC: Virginia, Maryland
Muzak—AEI—3M Distributor**

Immediate openings. Background, Foreground Sound System Installers/Service men needed at once. Experienced only. New satellite technology requires additional top field personnel, salary commensurate with experience/potential.

Contact:

Mr Roy Evers, VP-Engineering
Music Incorporated
1341 L Street NW
Washington, DC 20005
(202) 737-4051
Telephone collect or write,
detailing background.

APPLICATIONS ENGINEER

JBL Professional, the manufacturer and marketer of JBL loudspeakers and UREI electronic products for the professional audio marketplace, has an immediate opening in the area of technical product applications at its Northridge, California factory.

The successful candidate will have a minimum of 3-5 years experience in the design of sound systems for both fixed installations and portable applications. Major emphasis will be placed on good communication skills and a positive, problem solving attitude, since customer contact comprises a major portion of the job. Familiarity with each of the various vertical markets within professional audio, such as sound contracting, home and studio recording, musical instruments, broadcast, cinema, tour sound, etc., is required. Personal computer proficiency is also necessary.

JBL Professional offers a competitive salary, comprehensive benefits package and the challenge of working for an industry leader. If you would like to be part of our team, please submit your resume including salary history in confidence to:



Mark Gander, Vice-President Marketing
JBL Professional
8500 Balboa Blvd.
P.O. Box 2200
Northridge, CA 91329

ARE YOU AN EXPERIENCED INSTALLATION/SERVICE MANAGER?

Do you want to be part of a winning team? Le Com Engineering has an opening for an installation manager with strong experience in sound and communication systems. Send resume and salary history to:

Le Com Engineering, Inc.
1388 E. Pacifico
Anaheim, CA 92805
or call Mike Hester at
(714) 938-0991

OUTSIDE SALES IN SUNNY SOUTH FLORIDA!

Fort Lauderdale-based Sound, Lighting and Video Contractor needs aggressive sales people immediately. In exchange for your outstanding productivity, we offer generous commission, bonus and incentive plans. Send resume and salary history to:

Sales Manager
P.O. Box 70602
Fort Lauderdale, FL
33307-0602

BACKGROUND/FOREGROUND MUSIC SALES

**Northern California:
Sacramento, San Francisco**

Exploding metro area

Immediate openings with unique opportunity for aggressive **OUTSIDE SALESPERSON**. Experienced only, with proven track record. We offer generous commission, bonus, incentive, and benefit package. Send resume and salary history in confidence to:

Sales Manager
P.O. Box 215651
Sacramento, CA 95821

Rate

Information

(per column inch)

CLASSIFIED

1 time \$42

6 times \$38

12 times \$34

MARKETPLACE

1 time \$76

6 times \$68

12 times \$60

To Place an ad, call **RICH KOBEL, (516) 767-2500**

MARKETPLACE

HELP WANTED

National Sound, Light, and Video system contracting firm has an immediate opening for 2 positions:

ARCHITECT/A/V SYSTEMS SPECIALIST

Position involves design, specification and technical documentation of all aspects of installation. Excellent Drafting skills and Macintosh CAD experience required.

SOUND, LIGHT AND VIDEO SYSTEMS TECHNICIAN

Second position is for an installer with experience in all phases of system installation and service. This position will involve extensive travel. Computer literacy is useful.

Both positions will be based in Houston, Texas. Send resume, picture, salary requirements and work samples to:

Charles Hulme
CORE Systems, Inc.
 10440 Westpark
 Houston, Texas 77042

AUDIOVISUAL / ACOUSTICAL

Consulting firm in Midtown Manhattan (NYC), is seeking qualified designers or engineers with 3 to 5 years experience in AV, video production, teleconference facilities and/or architectural acoustics, mechanical noise control applications. The firm has exciting projects worldwide, good benefits and advancement opportunities. Rush resume and salary requirements to:

Shen, Milsom & Wilke
 6 East 39th Street, NY 10016
 or fax: 212-725-0864

SALES ENGINEER

Dayton Ohio Audio/Video contractor seeks qualified professional audio engineer. Applicants shall have a minimum of 5 years experience in professional audio. All replies held in strictest confidence. Good benefits, no commission. Send resume and salary requirements to:

Personnel Director
 P.O. Box 292974
 Dayton, Ohio 45429

This ad may be small, but you're reading it. To place a classified or marketplace ad, call . . . (516) 767-2500.

INSTALLERS!

EASY-KARY®
 Wire Reel Holders



- 3 SIZES
- All Steel Construction

Carry like a briefcase.

PUSH-PULL RODS Get cable through impossible places. Extends 45". Light weight. Flexible.



SPEAKER & TILE SUPPORTS **SPEAKER ENCLOSURES**



ALL STEEL LIGHT WEIGHT but STRONG for all 4" and 8" SPEAKERS in ALL types of CEILINGs. U.L. LISTED FREE SAMPLES

The Audio Serviceman's Right Arm. Check the complete sound system from MIC to SPEAKER -- and much more.

Model TS-1

30 DAY FREE TRIAL INSTANT OPEN ACCOUNT
 CALL OR WRITE FOR BROCHURE

MUSIC SUPPLY CO., INC.
 809 North Madison Dallas, Texas 75208
 ALL 50 STATES 1-800-527-1522
 FAX 214-946-9155 Local 214-946-8450

800-527-1522

Circle 24 on Reader Response Card

Monitoring "Type" Routing Switchers (2 to 24 stat'n)

12-in/1-out RSP-12 Mono-Aud/Video	\$250	Specs:
RSP-12S St-Aud/Video	\$325	Int'lk P-B
16-in/1-out RSP-16 Mono-Aud/Video	\$300	DC-8MHZ
RSP-16S St-Aud/Video	\$375	1 RU x 6"D
		3 lbs.

Also Assign Types Avail.

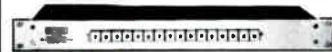

Free Catalog
OPAMP LABS INC (213) 934-3566
 1033 N Sycamore Av LOS ANGELES CA, 90038

Circle 25 on Reader Response Card

Free Catalog & Audio/Video Applications

Routing Switchers (St-A/V) (24, 16, 12, 8, 4, 2 stations)

Mic, EQ, Line, Tape, Phono, Osc, Trans, Video, ACN, Pwr. Supp.

Press Boxes 1-in/16-out Video/Audio

Video & Audio Dist. Ampls. 2-in/24-out Audio

RGB-Sync Dist. Ampls.



OPAMP LABS INC (213) 934-3566
 1033 N Sycamore Av LOS ANGELES CA, 90038

Circle 26 on Reader Response Card

ATTENTION SOUND CONTRACTORS

Be a part of a proven direct mail newsletter marketing program for churches. Sold on a protected market basis in your primary market area. Call today for free brochure and samples.

SOUND ADVICE

612-231-2122

INSTITUTE

or write
 P.O. Box 53, Willmar, MN 56201

Increase Church Sales

CUSTOM SERVICES

CUSTOM PANELS COMPUTER ENGRAVING

TO YOUR SPECIFICATIONS

Panels, cabinets, enclosures to your specifications. Anodized aluminum, photo aluminum, photo plastic, elegant brass. Engraving or silk screening for control panels and connector termination. Rack rails, hardware. Custom machining.

FROM ONE TO ANY QUANTITY



(815) 744-7173

108 Fairlane Dr., Joliet, IL 60435

New! Extruded breakout boxes; headphone boxes. Designed and used for Summer Olympics (NBC). Any color, any length.

NEW SERVICE FROM PROTO-TEC:

Custom Logo and Artwork Scanning. Computer Precision enables intricate detail, such as flow chart on panels. Ask us!

Custom Cases Acoustic Foam Custom Stands Studio Furniture



Request Catalogue: 800-343-1433, 516-563-0633
 Island Cases, 1121-20 Lincoln Ave., Holbrook NY 11741

1-800-821-2432

In Illinois (312) 486-7100



CURRENT

CABLE COMPANY, INC.
 QUALITY ELECTRICAL
 ELECTRONIC &
 COMMUNICATION CABLE

Your Circuit Is Not Complete . . . without **CURRENT**

FOR SALE

EXCESS INVENTORY

Sunbelt sound contractor has excess inventory for sale. Numerous manufacturers. For complete inventory, please reply to:

P.O. Box 924109
 Houston, TX 77292

or contact: **Robert Peters**
 (713) 686-2555

NEED A CLUSTER?

Used Altec horns/drivers. Twelve MR42 horns/throats/frames, \$200.00 U.S. Fourteen MR64 horns/throats/frames, \$120.00 U.S. Twenty 291-16 drivers Alnico with diaphragms, \$190.00 U.S. In good condition. Call:

Oakwood Audio — (204) 786-6715
 Ask for Ricco

AD INDEX

Company	Page	RS #
Altec Lansing (405) 324-5311	45	210
Applied Research & Technology (716) 436-2720	7	209
Ariel (201) 247-2900	13	211
Atlas/Soundolier (314) 349-3110	29	216
Audio Digital (800) 423-1082	63	256
Audio Logic (801) 268-8400	47	251
Audio Systems (701) 223-3800	41	280
BGW Systems (213) 973-8090	11	213
Cal-Switch (800) CAL-SWCH	51	293
Carvin Corp (619) 747-1710	CIII	—
CT-Audio (800) CT-AUDIO	51	292
Electro-Voice (616) 695-6831	CII	202
Fisher Berkeley Corp (415) 655-9696	39	250
Florence Mfg. (312) 384-3310	35	252
Frazier (800) 643-8747	31	240
FSR Inc. (201) 239-0988	36	271
Gemco (615) 452-5960	23	205
Hacoustic (404) 945-3142	41	281
IBMA (408) 436-1570	30	254
Industrial Research Products (312) 439-3600	3	203
JBL Professional (818) 893-8411	CIV	201
Jeron Electronic (312) 275-1900	37	270
Lee Dan (516) 231-1414	32	208
Mackenzie Laboratories (800) 423-4147	43	257
Microframe (800) 635-3811	66	290
Peavey Architectural Acoustics (601) 483-5365	67	291
Pioneer Laser Entertainment (213) 518-4531	27	215
Quam-Nichols Co. (312) 488-5800	17-18	207
Samson Technologies (516) 932-3810	8	204
Sonic Systems (203) 356-1136	5	217
Sonic Systems (203) 356-1136	59	255
Techron (219) 294-8300	57	214
TOA Electronics (800) 843-4753	15	212
Yamaha Pro Audio (714) 522-9011	25	206

30 Years Ago

In the September 1959 issue of *Sound & Communications* there were strong indications of what was to come—and go—in the sound contracting field.

Changing technology in intercoms (like wireless, push button, and PAX units) had resulted in steady increases in business, with 6- and 9-button phones “fast clambering over the back of ‘squawk’ boxes.” Leading intercom producers reported increased sales and a stepping-up in their production rates.

Another industry stir was caused by citizens band radio—the CB. Its many manufacturers were quickly revamping their distribution plans and policies, due to incredible demand: A record-breaking 300 applications for CB radios were being processed daily with more than 50,000 authorizations delivered in September 1959. Uses included doctor and nurse paging, communication with field cars and delivery trucks, pleasure and commercial boats in harbors and rivers, and by “sportsmen and explorers.”

In September of 1959, this magazine’s new product section told of Bennett Laboratories’ Model 101 wireless intercom, which could communicate with its twin up to a mile away. “Normally sold in pairs,” the intercom could be used with up to a dozen units simultaneously....Meanwhile, Blonder-Tongue’s improved Observer TV camera included an interlace bypass system, more stability in the counter

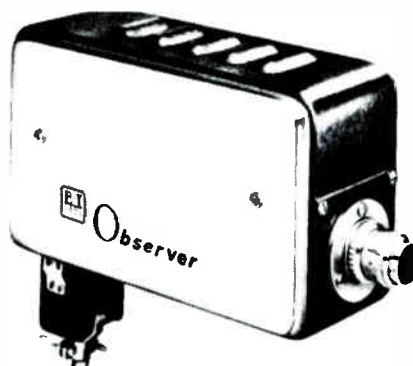

BETTER SOUND STARTS HERE

The professionals who know that a microphone can make or break a sound system have made the Shure UNIDYNE the most widely used, most requested microphone in the world. Where sound reproduction is most critical, the most articulate, ultra-artificial uni-directional microphone put its up-erogable inside shading of sound without distortion and with expert suppression of random background noise. Frequency response, 50 to 15,000 cps—and now 41% higher in response level.

UNIDYNE BY SHURE

Send for Free Literature
SHURE BROTHERS, INC.
222 Harvey Avenue • Evanston, Illinois • Dept. 44-1

Standard carrier of the World Famous Shure Stereo-Diverse Phono Cartridge

circuits, and restyling of the sync generator “for both appearance and operating convenience.”

Advertisements were a mirror of the times as well Evanston, Illinois-based Shure extolled the strengths of its Unidyne microphone: It was “the most widely used, most requested mic in the world.” . . . A full-page Astatic ad featured three pictures of a full-bodied young woman in a green body suit and bonnet. The ad, for three of the company’s Futura microphones, had a headline that read, “Futura Triplets.”



. . . . Mellotone, maker of “The High Fidelity Grille Fabric,” included a 3.5-by-6.5-inch sample of Fabricane 1106 in its ad. The product permitted high fidelity transmission, the ad read, because Mellotone fabrics were woven with single-strand fibers.

THE MX88 SERIES -

"SUPERIOR DESIGN, PERFORMANCE AND VALUE..."

...A SUPERIOR CONSOLE"

"Truly targeted at the professional recording or sound engineer. It is obvious that the people who designed this unit spent a lot of time in both recording studios and at concerts where sound reinforcement is both critical and complex."

- Len Feldman, db Magazine

"The MX2488 is the best performing console at its price. Period."

-Tony Bongiovi,
Power Station Studios, N.Y.

"The MX2488 is good or better than a lot of boards costing twice as much...very quiet, very versatile."

-Hector LaTorre, Audio Reviewer

Price: \$4195 for the MX2488

\$3195 for the MX1688

(includes external power supply)

MADE IN THE
USA

EXTERNAL POWER SUPPLY

Our goal was simple. To build a console ideally suited for recording, production, broadcast and even film. We feel we've done that with the MX88 Series - a versatile control center configured especially for use in an eight rack environment. No cumbersome patch bays, no external wiring - all the routing is as easy as a flick of a switch. The MX88 consoles are exceptionally quiet and transparent as well, thanks to the external power supply, and their parametric EQ assures discriminating tonal control.

As for the reasonable price, that's the benefit of ordering **DIRECT** from us - top quality equipment without the retail markup. Discover the advantage of buying **DIRECT** - exclusively from Carvin.

(Prices include Shipping). Outside of USA: Available through Dealers Only.

CARVIN

THE DIRECT ADVANTAGE

For more information or to order, call:

toll free: (800) 854-2235

Send me Carvin's full line catalog on Pro Sound Equipment::

FREE Catalog \$1 for RUSH 1st Class Mail

Name _____

Address _____

City _____

ST _____

ZIP _____

Send to: MS15,1155 Industrial Ave., Escondido, CA 92025

Hollywood Showroom: 7414 Sunset Blvd. (213)851-4200

Power Play.



Loudspeaker design: To achieve high power handling capability, sensitivity suffered. You could get more power, but you had to accept less play.

Another Advance From JBL

Ever since Jim Lansing flattened voice coil wire in the early thirties, JBL has continually edged loudspeaker design closer and closer to perfection. The introduction of our new 2200 Series models marks another JBL advance in transducer technology.

Vented Gap Cooling™

As a voice coil's temperature rises, so does its impedance, causing power compression. Every dB of power compression translates into one less dB of output.



To reduce power compression and gain overall sensitivity, JBL created vents from the voice coil, through the magnet structure, to the rear of the loudspeaker. As the cone travels, heat is dispersed and cool air returned to the voice coil.

The result, a true 600 watt loudspeaker with high sensitivity. You get twice the power handling plus greater output.



New SFG™ Magnet Structure.

Through computer modeling and simulation, the 2200 Series SFG magnet structure achieves optimum flux density and significantly lower distortion while realizing up to 20% weight reduction.

We Heard You Loud And Clear.

Whether you're looking for a mega-watt touring loudspeaker, or for a low distortion critical listening device, JBL has the model for you. All with the new SFG magnet structure with Vented Gap Cooling. The new 2200 Series models give you the best of both worlds. Power, and play.



JBL Professional
8500 Balboa Boulevard, Northridge, CA 91329 USA

A Harman International Company

Circle 201 on Reader Response Card