

SOUND & COMMUNICATIONS

COVERING TELECOMMUNICATIONS
AND ELECTRO-ACOUSTICS

AUGUST 1985

THE BLUE BOOK 25TH EDITION

SGND2MBAL5000 .GAO 01 000MAY86*
MARK GANDER
JBL INCORPORATED
8500 BALBOA BLVD
NORTHBRIDGE CA 91329



NEW WAVE DESIGN

Blocking the Incoherent Wave

Cast into the throat of every **TransPlanar™ HP horn**, unique beamwidth control vanes represent a revolutionary advance in constant-directivity design. Until now, two-inch-throat designs were compromised by on-axis dropout. Intrigued with this curious problem, EV engineers applied principles of geometric optics to isolate the incoherent waveform responsible for this phenomenon. Instead of courting down the horn in an organized fashion, this offending wave reflects off the walls of a two-inch throat, shadowing direct output and causing a loss in level. Ray analysis was used to predict this occurrence and determine the exact configuration of slotted waveguides which block the cancelling wave and eliminate on-axis dropout.

Acting together with an optimum diffraction slot, the beamwidth control vanes also eliminate both horizontal and vertical beaming in the very highest octave. Other two-inch-throat designs exhibit narrowing of the coverage angle above 10,000 Hz. But the new HP horn maintains uniform dispersion to 20,000 Hz!

When Electro-Voice invented the constant-directivity horn in 1972, we really started something. Now we're making waves again . . . introducing second-generation CD design with the most uniform beamwidth control in the industry. To learn more about the the new HP horn or the high-performance DH-1 and DH-2 two-inch-exit drivers designed especially for them, contact Pro Sound Marketing at Electro-Voice, 600 Cecil St., Buchanan, 49107. **We'll be glad to tell you why when the competition beams, we just smile.**



Reader Service #230

EV **Electro-Voice®**
SOUND IN ACTION™

THE TEKTONE COLLECTION

Six simple steps –
engineered to meet all your
intercommunications needs.

1 Tek-Select office
intercom systems...
● featuring the SM210
master with remote LED
indication, total selectivity
& hands-free reply.



2 Apartment house intercom systems—
standard AM series or custom made CM
● series. Available with a variety of
remote stations.

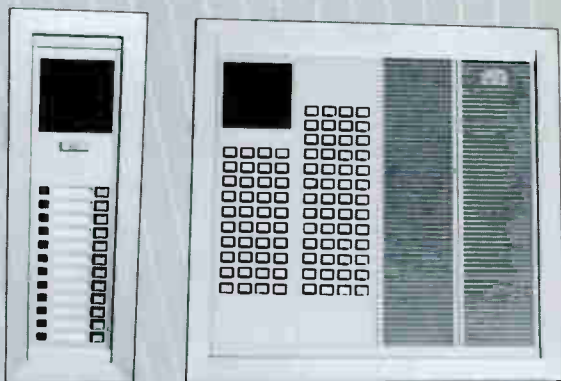

3 Tek-Sound AM/FM Master
● Radio Intercom Systems.



4 Tek-Entry Telephone
Entry Systems. Complete,
● automatic call and
entrance control.



5 Tek-View VM-102A for security and
communication combined. Ideal for
● high rises, homes or apartments.

6 Tek-Lite NC-150 UL
listed Nurse Call system.



TekTone

Sound & Signal Mfg., Inc.

1331 S. Killian Drive

Lake Park, FL 33403-1988

(305) 844-2383—Toll free order (800) 327-8466

SOUND & COMMUNICATIONS

AUGUST 1985

Volume 31 #8

FEATURES

- PACKAGED SOUND SYSTEMS: PORTABLE AND PROFITABLE** 14
Manufacturers discuss the coattail effects of tacking a portable sound system to an installation contract as a backup and extension. The product comes in various shapes and sizes—from small wireless handheld units to larger lectern systems
- DUPLEX INTERCOM: RIGHT ON TRACK** 24
Peter McLean, vice president at Ring Group of North America, discusses the company's reorganization as a response to the return of the demand to duplex intercom systems. A product sampling of what is available in the market is also included.
- SERVICING TODAY—ELIMINATING DOWN TIME** 33
Walker Cottrell, a veteran of the industry, reflects on how servicing departments have changed over the past 20 years, today's real concern for the contractor to eliminate his client's downtime, and how microchips have helped in this quest.
- INSTALLATION PROFILE: MORE TO SOUND THAN MEETS THE EYE** 39
Bob Kehl of AVC Systems Inc., a contractor in Minneapolis, MN, reports on the recent mammoth installation AVC did, which included 500 loudspeakers, 56 amps, and 30,000 watts of audio signal, in the new Ordway Music Theatre in St. Paul, MN.
- SIMULTANEOUS INTERPRETATION** 44
With the involvement of many business and political groups in more and more international meetings, the need for simultaneous interpretation systems grows. What should the sound contractor know about these systems and what must he consider when installing them?

COLUMNS

- IDEAS & VIEWPOINTS** 6
Ideas on expanding and promoting our small industry which depends heavily on the ups and downs of the economy.
- THEORY & APPLICATION** 10
Jim Brown continues his review of basic audio theories from dBs to dynamic ranges.

1985 BLUE BOOK

Annual Purchasing Directory

This edition marks the 25th publication of the Blue Book directory, a milestone in *Sound & Communications'* history. As has the directory for a quarter of a century, we look forward to serving your needs.

DEPARTMENTS

- NEWSLETTER** 8
- PRODUCT IN REVIEW** 48
- A CLOSER LOOK BY GARY D. DAVIS** . 49
- BOOK REVIEW BY TED UZZLE** 65
- SUPPLIES/SUPPORT/SERVICES** 67
- FACES AND PLACES** 70
- REP NEWS** 71
- DATEBOOK** 76
- CLASSIFIEDS** 77

combining **SOUND MERCHANDISING & MODERN COMMUNICATIONS**

FOUNDED 1955

© **SOUND & COMMUNICATIONS PUBLISHING, INC.**, 1985. Reprint of any part of contents without permission forbidden. Titles Registered in the U.S. Patent Office. *Sound & Communications* (U.S. P.S. 943-140) is published monthly by Sound & Communications Publications, Inc., 220 Westbury Ave., Carle Place, N.Y. 11514. 516-334-7880. President, Vincent P. Testa; Vice President, Paul G. Gallo. Subscription rates: U.S.—3 years \$37.50, 1 year \$15.00. Canada and Mexico—3 years \$48.00, 1 year \$18.00. Foreign and South America—1 year \$25.00. Second Class postage paid at New York, NY and at additional mailing office. Postmaster: If undeliverable notify on Form 3579 address correction.

Introducing

the handiers
UNIDIRECTIONAL DYNAMIC MICROPHONES



paso
SOUND PRODUCTS

For more information please contact:
Paso Sound Products, Inc.
14 First Street — Pelham, New York 10803
Phone 914-738-4800 Telex No. 646783
Reader Service #232



8000 SERIES
APARTMENT
HOUSE
INTERCOM

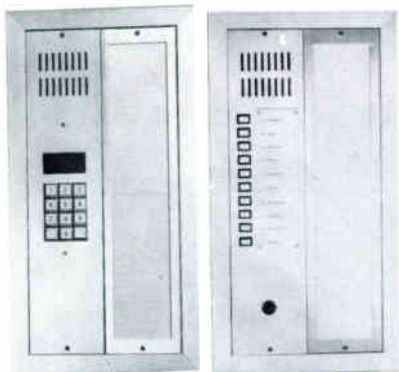

Speaker/
touchpad
Panel to
899 units,
with
Directory

Speaker/
Pushbutton
Panel with
Directory

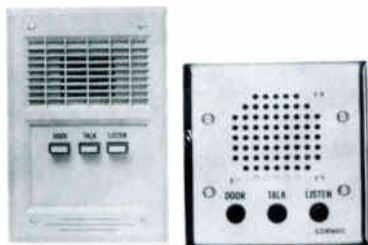

Suite Stations



Transformer

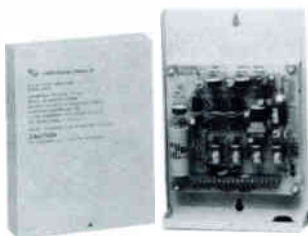

Amplifier

**Cornell
Electronic
Products, Inc.**

P.O. Box 23411
4911 W. Good Hope Road
Milwaukee, Wisconsin 53223
(414) 351-4660

IDEAS & VIEWPOINTS

EXPANDING OUR MARKET

by Chris Foreman

You're probably tired of hearing me say "there's just not much new in the sound and communications business, and I'm worried that we're too tied to the ups and downs of the U.S. economy."

The truth is, I'm tired, too. Tired of being part of an industry that is, in many ways, in the doldrums. For years, I've watched for some way out. I know it's possible. Look at the early days at Altec. Altec's first business was the cinema (movie theater) sound business, which they took over from Western Electric in the 1920s. The cinema sound business, *a new and growing market*, helped Altec grow even through the Depression.

Altec's early days are an example of an answer to both of my gripes. The cinema sound business was very much new when Altec took over from Western Electric and it was definitely *not* tied to the U.S. economy. What I keep asking myself is, "Can we find some way to duplicate this feat?"

The answer I keep coming up with is, "Probably not, because there's nothing quite like the cinema business of the 20s around today." The interconnect business held promise, and it has expanded our overall marketplace, but it seems to have reached a plateau a bit earlier than we expected. Thus, we're back, as an industry, to being tied to the ups and downs of the economy. Of course, we could just get lucky. Some other new business could pop up and give us the growth spurt we want. Then again, maybe it won't.

Why don't we do something about the market?

The trouble is our sound and communications industry is, as we all know, comparatively small. We don't have anywhere near the resources to create (buy?) a new marketplace even if we could dream one up. The other problem is that, as small as we are, we're fragmented into even smaller pieces and those pieces have a reputation for territoriality. We'd have to find a common cause and an acceptable neutral conduit for any industry-wide actions.

So there doesn't seem to be much hope. Or does there? We can't be the only small, fragmented industry looking for a way to control its own destiny (or at least *affect* its own destiny). What can we learn from others?

Promoting Our Industry

How about these two unlikely candidates—the milk producers and orange growers. The milk producers have been doing national "drink milk" ads for years now, and the orange growers are promoting their product with the clever "orange you smart" slogan. Both groups are fragmented, like we are, but have found a common cause (promoting their product in a generic manner) and an acceptable neutral conduit (their own trade organization).

Food producers aren't the only ones who have learned how to band together for the good of the group. Some industries hire major stars to promote themselves. For example, Raymond Burr lists the advantages of buying insurance through an independent insurance agent. There must be dozens of other examples.

If industries as diverse as these can get together to promote their products and services, why can't we? I think the answer is "we can."

The National Association of Music Merchants (NAMM) will start a series of test market commercials on nationwide MTV (Music Television) this fall. One purpose of those commercials is "to promote the benefits of playing music." The primary purpose, of course, is *to promote the sale of musical instruments*. NAMM intends to have an evaluation of its test marketing program sometime in 1986 and the implication is that, if it is as successful as they believe it will be, they will continue and expand the program.

(continued on page 62)

STAFF

Editorial Director
CHRIS FOREMAN

Managing Editor
ELLIOT LUBER

Assistant Editor
NANCY PETERSON

Consulting Editor
JEROME J. BROOKMAN

Contributing Editor
GARY D. DAVIS

Contributors
JIM BROWN
WALKER COTTRELL
JOHN P. FRANTZ
BOB KEHL

PETER MCLEAN
TED UZZLE
JIM WOOD

Bluebook Research Assistant
JANICE L. POLK

Art Director
JAKE UZO

Production
DEBORAH M. CASSANO
BETH CHARNEY
LORI KATZ
WILLIAM MONCURE

Typesetting
GEORGE PROPER
ARTHUR VIDRO

Circulation Director
BUNNY FRIED

National Advertising Sales Manager
CLIFFORD CAPONE

West Coast Sales Manager
JAY S. MARTIN

Vice President/Associate Publisher
PAUL G. GALLO

President/Publisher
VINCENT P. TESTA

Editorial And Sales Offices
Sound & Communications
220 Westbury Avenue
Carle Place, New York 11514
(516) 334-7880

Advertising/West Coast
15532 Cohasset St.
Van Nuys, CA 91406
(818) 904-9669

Circulation audited by
Verified Audit Circulation Corp.

VERIFIED
AUDIT CIRCULATION

TESTA
COMMUNICATIONS
Inc

Sound & Communications • Music & Sound Output
Pro Sound News • The Music & Sound Buyer's Guide
CES-TV News • NAMM-TV News • The Daily
The Music & Sound Electronics Retailer
Home Entertainment Magazine

AUDIOCOM™

"The Intercom System"

INTRODUCING Phase 2

Now with two channel capability



Intercom technology takes a giant step forward as Telex advances to PHASE 2 of its popular Audiocom Intercom System. What's more, two channel capability and a full duplex audio system for both monaural and binaural systems is only a small part of the story! The new master station/power supply shown above features built-in IFB (interrupt feedback) and easy-to-use color coded line/channel buttons that can correspond with the same color of optional extension cables for convenient visual reference. The master station also features a brand new 20 kHz light signaling system, interlocking push-button channel switches, a listen/volume control, a mike on/off/signal control and a power on/off LED indicator.

Belt-pack headset station has special features

The new two-channel belt-pack intercom station allows the operator to selectively monitor one channel or both simultaneously. It has a mike on/off switch and separate listen/volume controls for each channel as well as a special carbon headset input and separate sidetone adjustments. There is also a rack mountable version of this unit available with all the same features. Additionally, Telex has developed an entirely new line of intercom headsets to accompany these exciting Phase 2 changes. And, they are lighter and more comfortable than ever before! The new offering consists of single/dual side units, monaural and binaural units, a super lightweight and a new headset.

ANNOUNCING complete compatibility!

Telex introduces the CCB-1 Clearcom/Telex interface unit. This new interface and others already in the line ends forever any problems in field compatibility between Telex and Clearcom, RTS or Telco.

For complete technical information and specifications write or call Telex today. Write Telex Communications, Inc., 9600 Aldrich Ave. So., Minneapolis, MN 55420. For quick information call toll free 800-328-3771. In Minnesota call 612-887-5550.

TELEX®

TELEX COMMUNICATIONS, INC.

MATSUSHITA, PANASONIC'S PARENT COMPANY, TO MAKE KEY SYSTEMS IN U.S.

Matsushita Communication Corporation of America, one of Japan's Matsushita Electric's 14 operations in the U.S., has announced plans to begin manufacture of key telephone systems in Franklin Park, IL this November. The giant corporation is known to the sound reinforcement market through its RAMSA Product line, and is perhaps best known as the maker of Panasonic and Technics audio and video products for the consumer market. The company has considerable marketing clout, as witnessed by the market acceptance of its VHS video format. Toshiba had announced similar plans at press time.

NATA FCC COMPLAINT CHARGES 12 B.O.C.s WITH UNFIAR CENTREX PRICING

The North American Telecommunications Association has filed a complaint with the Federal Communications Commission, seeking to have the F.C.C. strike down Centrex pricing practices by 12 Bell Operating Companies which it feels are illegal. The complaint charges that Centrex pricing discriminates against customer premises equipment users such as offices with PBX systems. The group cited the 1934 Federal Communications Act as well as the 1981 Computer II deregulation plan as documentation against such practice.

REPORT SAYS STAND-ALONE VS&F MARKET EXPECTED TO DECLINE

While the Voice Store and Forward (VS&F) market as a whole is growing, the market for stand-alone VS&F units as a portion of overall sales is expected to decline, according to a 150-page report from International Resource Development Inc., a research firm. According to the report, VS&F will face severe competition from the telephone industry, shared-tenant services and service bureaus. The report estimates an average annual growth rate for PABX-based VS&F systems at 50 percent over the next decade, compared to only 30 percent for stand-alone systems.

TEMMER SELLS GOTHAM AUDIO TO HIS VICE PRESIDENT AFTER 27 YEARS

Stephen F. Temmer, founder and president of New York's Gotham Audio Corporation, a major importer and exporter of professional audio equipment, has sold the corporation and name to his vice president, Russello Hamm. Gotham, which celebrated its 25th anniversary in 1983, was sold to an investors group lead by Hamm for an undisclosed amount of money, termed "mostly cash." Temmer will retain the Gotham Building, as well as a substantial interest in Gotham A.G., and Thorens-Franz AG, both of Switzerland. Thorens is known for its turntables. Gotham lines include EMT, Studer, Beyer, Klein & Hummel, NTP, Doerfler, FABEC, AEG-Telefunken and its original line Neumann.

LEUPOLD & STEVEN ACQUIRES ASSETS OF BIAMP SYSTEMS

The assets of Biamp Systems had been sold to Leupold & Stevens, another Oregon firm known for making Leupold rifle scopes and binoculars and Stevens water resource measuring devices, for an undisclosed amount. Don Waggoner, senior vice president of L&S for corporate ventures and acquisitions will serve as president of the new firm, Biamp Systems Inc. L&S president Werner Wildauer said the additional financing and clout will enable Biamp to take a more aggressive marketing stance with its high-tech designs.

RICHARD LONG APPROVES OUTSIDE MANUFACTURING OF HIS SOUND PRODUCTS

Richard Long Associates Ltd. of Long Island City, NY, a designer and installer of custom sound systems, has expanded with a series of manufacturing joint ventures, which had lead to his first outside manufacturing of RLA products in order to keep up with the demand. He is setting up a limited dealer network said to be less than 50 worldwide when complete.

BLONDER-TONGUE CELEBRATES 35TH ANNIVERSARY

Blonder-Tongue Laboratories Incorporated is celebrating its 35th anniversary in 1985 with the introduction of a number of major new products among other activities. The company was founded by Ben H. Tongue, currently president, and Isaac S. Blonder in Yonkers, NY as a single product enterprise. The company marketed the first commercially successful broadband TV amplifier and later expanded into other amplifiers and electronics for home TV and MATV applications. The company has been in Old Bridge, NJ since 1970.

PRESIDENT HONORS PEAVEY ELECTRONICS FOR CONTINUED EXPORT ACHIEVEMENT

Peavey Electronics was recently awarded the Presidential "E Star" Award at official ceremonies in Meridian, MS. Commerce Secretary Malcolm Baldrige and a representative of President Ronald Reagan presented the award to president Hartley D. Peavey and vice president Melia Peavey for continued excellence in export achievement.

MOST LARGE U.S. CORPORATIONS PLAN TO UPGRADE THEIR PHONE SYSTEMS

A study by The Conference Board, a non-profit research firm, estimates that more than two thirds of all large U.S. Corporations over \$10 million in annual sales plan to purchase upgrades for their telephone systems which support voice and data intergration over the next three years. Respondents ranked their selection criteria to be First: system reliability; Second: vendor service and support, and Third: long-term cost of system.

PAGING INDUSTRY BECOMING A CONSUMER MARKET CROSSOVER

Theodore S. Oleck, president of Cellular Technology Inc. claims that then percent of the population will carry radio paging devices by 1990. Oleck predicts that by 1990 his company will have at least 50,000 subscribers, since the price of such products may drop by as much as 80 percent in the near future, but that the industry mainstay will be the advanced informational pager rather than a mere beeper, and that service areas will extend to about 100 miles in diameter from today's 50. However, Oleck said he doesn't feel a national paging system will ever be necessary.

CREST ELECTRONICS PURCHASES ALTECOM DIVISION FROM ALTEC CORPORATION

Crest Electronics of Dassel, MN, has purchased the Altecom Communications Systems division of Altec Corporation for an undisclosed amount. The purchase includes nurse call, intercom and dormitory call systems, which will now be manufactured in Dassel, and gives Crest UL-approved systems, many with new product features suitable for both hospitals and nursing homes. Vice president Kelsey Page said the company's first priority will be to provide replacement-part support for the almost 600 Altecom systems already in the field, and that Crest plans to market new Altecom systems once existing customers are serviced. "We've been involved in signalling all along, though it was visual only. But Crest is known for its audio products and has been marketing products such as pillow speakers, so the addition of the Altecom line will compliment our existing lines," he said. Crest plans to contact all known Altecom dealers in the future.

THE BASICS OF AUDIO

by Jim Brown

dB and Audio

The decibel is a very convenient mathematical method of thinking about the levels of voltage, power, and sound pressure in electronic and acoustic systems, particularly if these circuits are designed to interface with humans. This is because the decibel is a logarithmic unit of measurement and most human senses (mainly hearing and sight) are logarithmic in their response. (Have you ever noticed that camera "stops" are 3 dB increments of light?) In addition, many computations of interest to audio engineers are simplified by the use of logarithms, and this special case of logarithms, the decibel.

Mathematically, the decibel is defined as 10 times the log (to the base of 10) of the ratio of two powers:

$$\text{dB} = 10 \log_{10}(P_2/P_1)$$

The power definition can be translated to the voltage ratios equivalent to the power ratio by using the *secondary* relationship:

$$\text{dB} = 20 \log_{10}(E_2/E_1) - 10 \log_{10}(Z_2/Z_1)$$

where Z_2 and Z_1 are the load impedances across which E_2 and E_1 respectively are measured.

If input and output impedances are the same, or if only the voltage gain is to be considered, the impedance term may be ignored, so that:

$$\text{dB} = 20 \log_{10}(E_2/E_1)$$

Electrical Power For a Sine Wave

Absolute values of voltage or power cannot be measured in dB without defining a reference, since dB is by definition a ratio.

Several commonly used references exist in audio. The first is the electrical sine wave power reference, 0 dBm, or dB with respect to one milliwatt. Although most meters commonly used to measure dBm are voltmeters referenced to the voltage equivalent of 1 mw in a

600 ohm resistive load, 0 dBm is defined as 1 mw in any load impedance.

Electrical Power For Complex Program Material

A closely related definition is the VU, or volume unit. "0 VU" is defined in exactly the same way as "0 dBm" except that VU is a measurement of the RMS value of complex program material, not sine waves, and using the standard defined VI meter with 1 mw as the reference. Like the dBm, the VU is defined as the power in any impedance, but is measured with a meter whose scale is calibrated assuming that the load impedance is 600 ohms. The standard for interpreting the VI meter reading is to use the highest reading obtained in a one minute period, excluding one or two abnormal peaks.

Decibels With Respect To One Volt

Another common reference is 0 dBv, or 1 volt RMS on a sine wave. Since power is not a part of the definition, impedance is also not considered except for the possible loading effect of the meter on a relatively high impedance source.

Sound Pressure Level

There are several common acoustic references, the most common of which is for "0 dB SPL" of .0002 dynes/cm². Since this is sound pressure level (pressure corresponds to voltage):

$$\text{dB SPL} = 20 \log_{10} [\text{SPL}/(.0002 \text{ dynes/cm}^2)]$$

This is the reference for which sound level meters are calibrated.

Program Dynamic Range

The dynamic range of the program material is the difference in volume (audio level) between the loudest and softest parts. Some programs need wide dynamic range for dramatic or musical effect. Films like "Raiders of the Lost Ark" and "Apocalypse Now" depend on a powerful sound system in the theater or home listening en-

vironment to be able to convey the full impact of the magnificent special effects. Audiences who viewed "Apocalypse Now" in the handful of well equipped theaters playing it in its original release came out almost "shell-shocked" from the intensely powerful experience of guerilla warfare. Viewing it without that sound experience is like comparing surfing Hawaii's finest waters to soaking one's own bathtub.

Similar comparisons could be made with respect to the Chicago Symphony, Count Basie's Orchestra, a documentary on a rain forest, and many other presentations.

Other programs need limited dynamic range for maximum effect. A lecture in a classroom, or the narration of a tutorial is much easier to follow if the voice of the instructor is held at a relatively constant level. A documentary of a psychoanalysis session where every word (even every accent and nuance) must be clearly understood needs careful attention to clear, distinct sound pickup. Straining to listen to "off-mic" comments can be very fatiguing, make comprehension difficult, and even lose important parts of the program.

In some cases, wide and limited dynamic range in the same program can help separate different segments from each other. The well controlled (and limited dynamic range) narration of a nature documentary establishes a "normal" listening level for subsequent wide range sound effects.

Electronic Dynamic Range

Electronically, the dynamic range is also the difference between the quietest and loudest sounds that can be recorded. At the low end of the scale, we are limited by the noise level. At the high end of the scale the limitation is simply by how much signal we can "cram onto" the recording medium.

Maximum signal limitations

are determined by the saturation levels of magnetic tape stocks, the widths of phonograph and optical tracks, the voltages used in electronic circuits, and certain physical dimensions of loudspeaker systems.

Noise results from random motion of electrons in a circuit, the non-uniformity of the recording medium (tape, optical print, disc), imperfect contact between the recording medium and our pickup of it (the exciter lamp in a film chain, the stylus in a phonograph, tape head contact in a magnetic system).

Noise can result from pickup of electrical interference in a studio or remote system, the acoustical pickup of undesired sounds by the microphone, or background noise in the listening environment. Much of this noise can be eliminated or controlled by good production or applications engineering.

Common sources of electrical interference in the real world are inexpensive consumer grade SCR light dimmers, radio and television transmitters, defective motors, computers and other microprocessor devices. All of these noises can be reduced or eliminated by good engineering practice both at the source of the noise and in the audio system itself.

Acoustic Dynamic Range

Acoustically, the dynamic range is defined by the loudest sound level at which the listener wishes to listen to in the program (and which the playback system will reproduce well) and the quietest sound which will not be interfered with by the noise level in the listening room.

Acoustical noises in the studio or listening room can result from poor vibration isolation of motors, poor sound isolation from other areas, poorly designed air handling systems, cheap or defective fans

(continued on page 12)

Digital Power

Reflections Of The Future

Digital Energy Conversion Amplification™ . . . A new standard of power. Brought to you by Peavey via the DECA™-700 and DECA™-1200 power amps. The world's first (and only) 90 percent efficient and truly digital power amplifiers.

Because linear amplification allows at best between 40 and 60 percent efficiency, we knew that in order to manufacture a 90 percent efficient power amp, we would have to depart from conventional technology. DECA™ is not a conventional Class AB amplifier passed off under some "fancy" name. Its technology isn't analog. It's a totally new approach on which we have applied for six patents.

The DECA-700 and DECA-1200 power amps deliver time after time with virtually no heat, very little mass (24 and 26 pound units) and 90 percent efficiency. The DECA-700 specs out at a rated minimum power output of 350 watts RMS per channel into 4 ohms and 700 watts RMS into 8 ohms (in bridge mode). Our DECA-1200 is rated at minimum power of 600 watts RMS into 4 ohms and 1200 watts RMS into 8 ohms (in bridge mode). Other features include DDT™ compression circuitry to prevent amplifier overload, absolutely no measurable TIM or slew rate induction distortion, multiple overload output and load protection features. They are both available in a 19" rack mount (two space) configuration.

DECA Technology. Yesterday our competitors said it couldn't be done. Today they're wanting to know how we did it.

Discover for yourself DECA™ power amps by visiting your nearest authorized Peavey dealer. Or send \$1.00 to Peavey Electronics, 711 A Street, Meridian, MS 39301 and we'll send you our Professional Audio Systems catalog with specs and features of the DECA Power amps.



Reader Service #293



World Radio History

THEORY & APPLICATION

(continued from page 10)

in studio cameras and other electronic devices, and from normal crew activities in the production process.

We can eliminate or reduce these noises at their source by good mechanical engineering. We can also minimize their transmission from the source to our microphone or ear by good acoustic treatment of the environment. And we can minimize their pickup in our soundtrack by good choice and placement of microphones, and by good audio engineering at every step of the recording/transmission process.

Tom Holman of Lucasfilms found that the wide dynamic range of their films was being limited by the background noise in many of the theaters playing them, making quieter

background effects inaudible and some dialog difficult to hear. He solved the problem by adding random noise of the same type as found in those noisy theaters to the theaters in which his soundtracks were mixed. The mixing engineer was then able to produce a soundtrack which had the desired dramatic effect under "real world" conditions.

Signal To Noise Ratio

The signal to noise ratio is the difference between the rms value of the maximum sine wave which can be passed undistorted through a medium and the rms value of the noise level of that medium. The ratio is usually expressed in decibels.

It is normal to limit the bandwidth of the noise being measured to the audible bandwidth of human hearing or the bandwidth of the system itself. The reason for this is that it is mean-

ingless to consider noise which is inaudible to the listener. The common bandwidths used are 15.7 kHz (the bandwidth of FM broadcasting) and 20 Hz to 20 kHz.

It is also common to "weight" the noise according to a several standard pre-emphasis curves to either bias the data to make it look more favorable than it really is or to make the data more meaningful by having the more audible higher mid-frequencies contribute more strongly to the signal to noise ratio. When comparing signal to noise ratios it is wise to look carefully at the way in which the ratio is determined. The same signal to noise ratio can be weighted to yield numbers 20 dB or more different.

Distortion

Distortion is simply the unfaithful reproduction of an input signal. It may take many

forms. Most distortions are undesirable, but many are done on purpose. The distortions discussed here are those which are undesirable and unintentional.

The most unpleasant forms of distortions result from imperfections in audio systems called non-linearities. They happen most often when a system (or some part of it) is called upon to handle a sound that is louder than it was designed to handle. The sound takes on a certain "harshness" or "raspiness" that is not present in the original form.

Two of these forms of non-linear distortions are harmonic distortion and intermodulation distortion. While harmonic distortion is the more common, it is the least obnoxious because it is closely related to the overtones of musical instruments.

When a signal is harmonically

(continued on page 74)

SOUND REPUTATION.

The task of sound reinforcement is never simple - the choice of equipment complex.

AKG has taken the guesswork out of microphone selection with low noise, reliable condenser microphones for distinct applications:

The C-535 is both durable and dependable. Practical features such as output and response attenuation make it ideal for both stage and pulpit, choir and phones.

The C-567 lavalier is a small miracle which reproduces speech or music with fullness and clarity.

The C-568 short shotgun microphone is only 10 inches long, yet has extended "reach" to cover those difficult spots.

...and sound reputation...
AKG

 **AKG**
ACOUSTICS

77 Selleck Street
Stamford, CT 06902
203/348-2121



AUDIO-SIGNAL DELAY

It started with the Audio-Signal Delay...

VOICE-MATIC
MICROPHONE MIXER

TRANSVERSAL
EQUALIZER

LEVEL-MATIC
GAIN CONTROL

Introducing The Model DH-4020 Power Amp

- Dual 100 Watt/channel
- High efficiency MOSFET output stages
- Very low heat dissipation
- High reliability design
- Maintenance free/no fans
- Small size
- Extremely light weight - 10 lbs.
- No 60 Hz magnetic field
- Solid state load protection and mute
- High fidelity specs

INDUSTRIAL
RESEARCH
PRODUCTS, INC.

A *Knowles* COMPANY

321 Bond Street
Elk Grove Village, IL 60007
312-439-3600

Reader Service #236

PACKAGED SOUND



Mayor of Albuquerque, NM, Harry Kinney addressing spectators and participants in "Albuquerque Marathon" held last May.

Packaged sound systems are tough to design, but they are said to be easy items for a sound contractor to sell.

The systems are often used to complement sound installations by giving sound to rooms that were not otherwise covered. They can provide reliable backup to installed systems and are fairly easy to setup, transport, and operate. While people are less likely to upgrade their packaged systems, the number of potential users is great because of the system's low price.

Designing packaged sound systems is another story. Manufacturers report that they have a difficult time making trade-offs between power and portability, and between sophistication and ease of operation. One design engineer said that his end users want the sound quality that comes out of a massive component engineered sound system to emanate from a single lightweight box

with a control knob labeled "more."

With packaged sound systems, everything is not state-of-the-art and many good systems go unnoticed. In fact, often the only time an audience or a speaker notices a packaged sound system is when it malfunctions.

A good definition of what constitutes a packaged sound system is: "a totally self-contained, mobile sound unit that can be quickly setup and used on a temporary or semi-permanent basis. The three major concerns associated with packaged sound systems are quality, price, and most importantly, user friendliness."

According to many manufacturers, the sound contractor has one of the better positions in the industry to sell packaged sound systems. The best avenue, most agree, is not to hire outside sales personnel, but to suggest and include brochures of the units in invoices and contract bids

portable

by John P. Frantz

& profitable

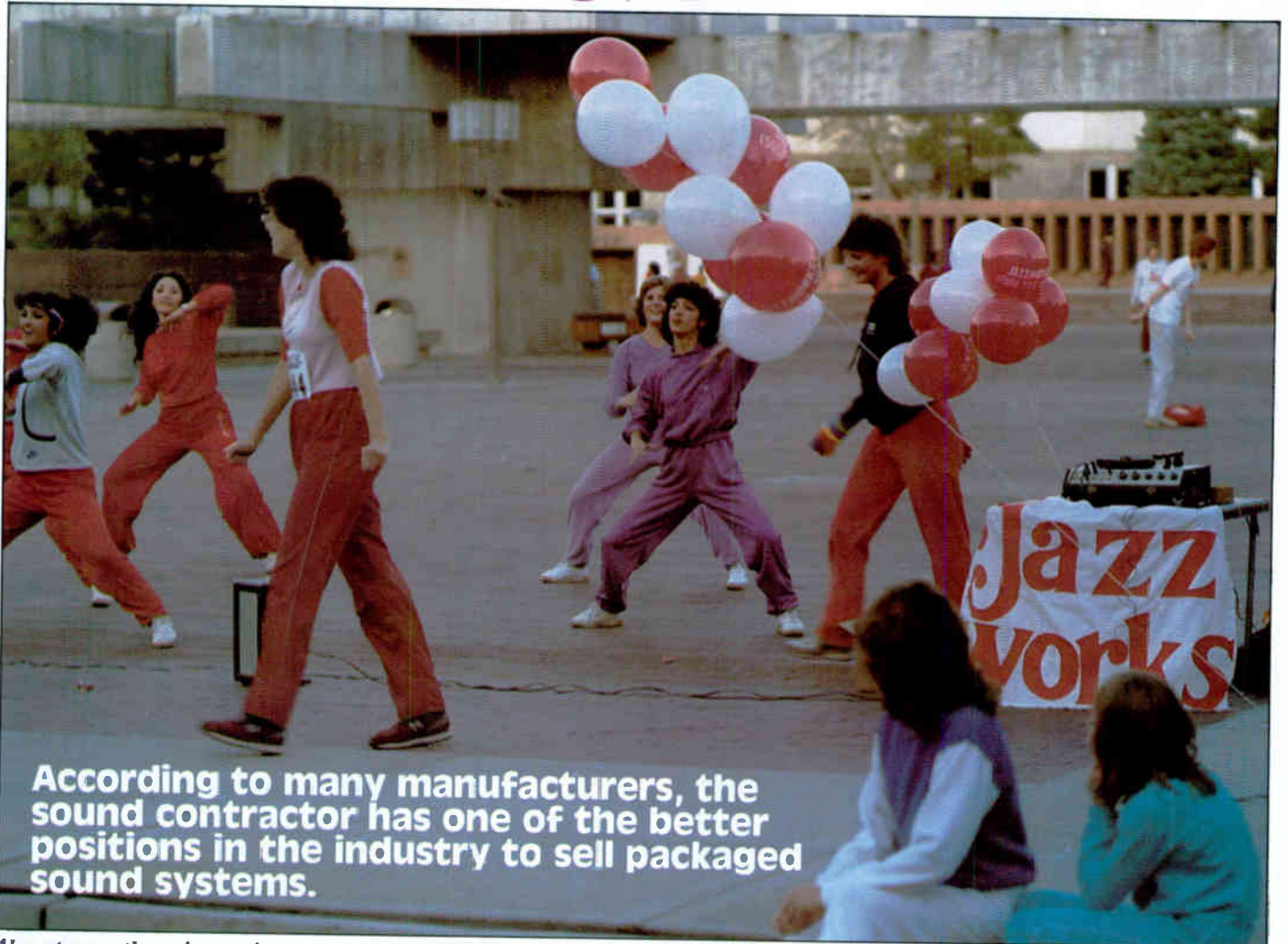

According to many manufacturers, the sound contractor has one of the better positions in the industry to sell packaged sound systems.

Also at marathon, jazzercisers use portable sound system to work out.

Today's most popular packaged sound system is the lectern in the form of a tabletop or free standing model. Lecterns can provide both a sound system and a place to keep papers.

An increased popularity has also surfaced for over-the-shoulder units that weigh about 10 pounds but can cost just as much as a lectern.

In general, most packaged sound systems vary in price between \$200 and \$1,200. But, of course, there are high end exceptions with prices ranging up to \$2,500.

Today's introductions vary little from their predecessors of the 1970s. With simplicity and price restrictions dictating what the industry innovates, few modifications have taken place since then.

Simplicity of operation is an important consideration. One manufacturer said, "A majority of the people who use a packaged sound system

August 1985

have never used that model before and probably will never use it again."

The industry's first hey day in popularity and sales was the early 1960s after the advent of transistors and solid state electronics. Although packaged sound tube systems existed in the 1950s and many companies that manufacture them today got their starts in the 1940s, true portability through lightweight materials didn't occur until the evolution of solid state.

The exact number of packaged sound systems in use today is difficult to calculate, however several manufacturers have estimated the total to be between five and 10 million. Presently, sales only are estimated at 20,000 units annually. The slowdown in education spending, a major packaged sound system market, and the decrease in hotel and meeting center construction have contributed to the slowdown. The fact that

NADY 501 VHF WIRELESS. AFFORDABLE, AND EASY TO USE.

The Nady 501 VHF Wireless System is the perfect wireless for most stages, churches and studios. List price is under \$900.

And we designed the 501 with the speaker or entertainer in mind — you don't have to be a sound engineer to set it up and use it.

The 501 VHF is available with a good-looking handheld microphone, transmitter or a bullet-proof lavalier microphone transmitter. A lightweight, portable AC or DC-powered receiver completes the system.

Nady VHF wireless is the choice of today's major musical groups. Nine out of ten (based on Billboard Magazine's 1985 Talent Almanac) use our wireless microphone and instrument systems.

There are reasons for this. Nady Wireless is road-proven dependable. With audio quality that measures up to these artists' demanding standards. (Try a side-by-side comparison yourself — Nady Wireless always sounds best.)

Send for the specs on our affordable 501 VHF Wireless System, or ask your Nady rep for a demonstration. You'll like what you see — and hear.



Nady Systems, Inc.
1145 65th St.,
Oakland CA 94608
415/652-2411
Reader Service #239



Variation of the Amplicolumn with lectern.

many customers do not upgrade units if they still meet their intended needs, has also added to the slowdown. Unlike the recording industry where a race for the latest technology produces large turnovers of equipment, packaged sound systems today are basically the same units they were in the 1960s.

A very conservative estimate by the National Audio Visual Association (NAVA) lists 22 packaged sound manufacturers. Other industry sources said the figure could be double that when considering offshoot firms and companies with small market shares.

Yet, other markets exist besides education and meeting rooms. Consumers of packaged sound systems also include churches, trade associations, clubs, and any other avenue that brings people together to meet. Off-beat applications, such as auctioneers, have reportedly grown quickly as a viable market with the influx of bankruptcies in the 1980s. Sports groups and fitness centers are also likely buyers. And a New England pharmacist has claimed to have sold a "ton of equipment" to a mailing list of Alcoholics Anonymous groups.

The continuing fad of aerobics exercise classes has influenced sales, most manufacturers agree. But, other uses include use with swimming instructors, parade floats, stage monitoring systems, tour guides, marching band directors, horse trainers, computer classes, missionaries, and street musicians.

Distribution methods have changed drastically since the 1970s where most



Paso's TA2 Audiovoice system.

packaged sound systems were sold through electronic distributors. Today audio/visual houses, hotel supply outlets, office furniture stores, general catalog houses, and sound contractors all command reasonable shares of the market.

Spectra Sonics of Ogden, UT, currently has four models and has put an effort into wireless packaged sound systems. The 22-year-old firm offers the following systems: model 3100, \$599, a portable unit; model 3100C, \$630, a similar unit to the 3100 but it's semi-permanent; model 3100M at \$699, has no microphone pre-amp and is geared more for entertaining situations; model 3100W and 3100WL, both \$1,800, include a handheld wireless microphone and a lavalier microphone respectively.

According to Greg Dilley, national sales manager, Spectra Sonics, which specializes in pro sound, first entered the packaged sound system market when it began to mass produce a system (model 3100) it custom designed for the Jesus Christ of the Latter Day Saints Church.

Dilley sees the trend in packaged sound systems leaning toward lighter-weight units. Spectra Sonics' next introduction will weigh 31 pounds, which is eight pounds lighter than any of its present units.

There have always been trade-offs between quality, price, and simplicity of operation throughout the tenure of the industry, according to David Moore, national sales manager for Paso Sound Products of Pelham, NY.

And
now a message on
Yamaha's M1500
series
mixing consoles.

M1516A



GENERAL SPECIFICATIONS

FREQUENCY RESPONSE +0, -3dB, 20Hz to 20kHz; +0, -0.5dB, 30Hz to 15kHz.

TOTAL HARMONIC DISTORTION (THD)*

Less than 0.5% @ +10dB, 20Hz to 20kHz. Less than 0.1% @ +20dB, 50Hz to 20kHz.

HUM AND NOISE* (20Hz to 20kHz, 150Ω source, Input Selector set at "-60")

- 128dBm Equivalent Input Noise (EIN);
- 95dB residual output noise with all Faders down.
- 73dB PROGRAM OUT (77dB S/N); Master Fader at nominal level & all Input Faders down.
- 64dB PROGRAM OUT (68dB S/N); Master Fader and one Input Fader at nominal level.
- 73dB MATRIX OUT; Matrix Mix and Master controls at maximum, one PGM Master Fader at nominal level, and all Input Faders down.
- 64dB MATRIX OUT (68dB S/N); Matrix Mix and Master controls at maximum, one PGM Master Fader and one Input Fader at nominal level.
- 70dB FB or ECHO OUT; Master level control at nominal level and all FB or ECHO mix controls at minimum level. (Pre/Post Sw. @ PRE.)
- 64dB FB or ECHO OUT (68dB S/N); Master level control and one FB or ECHO mix control at nominal level. (Pre/Post Sw. @ PRE.)

MAXIMUM VOLTAGE GAIN (Input Selectors set at "-60" where applicable)

PROGRAM & MATRIX 84dB; Channel In to the corresponding output. EFFECTS 20dB; Effects In to PGM Out.
FB & ECHO 94dB; Channel In to FB/ECHO Out. SUB IN 10dB; Sub In to PGM Out.

EQUALIZATION (±15dB maximum)

LOW: 50, 100, 200, 350, 500Hz, shelving. HIGH MID: 1.2, 2, 3.5, 5.7kHz, peaking.
LOW MID: 250, 350, 500, 700, 1000Hz, peaking. HIGH: 10kHz, shelving.

HIGH PASS FILTER 18dB/octave rolloff below 80Hz.

PHANTOM POWER For remote powering of condenser microphones, +40V DC can be switched on via a rear panel Master phantom power switch. When an individual Input Phantom switch is also On, voltage is applied to pins 2 and 3 of that input's balanced XLR connector.

DIMENSIONS/WEIGHT M1516A 34" W x 36 1/2" D x 14 1/2" H 147 lbs. M1524 55 3/4" W x 36 3/4" D x 14 1/2" H 213 lbs.
M1532 55 3/4" W x 36 3/4" D x 14 1/2" H 231 lbs.

*Measured with a 6dB/octave filter @12.47kHz; equivalent to a 20kHz filter with infinite dB/octave attenuation.

The specs shown are for the 16-channel M1516A console. When you need the same outstanding performance but more channels, there's the 24-channel M1524 and the 32-channel M1532. All three mixers have remote rack-mounted power supplies and are ideal for just about any fixed or portable sound reinforcement or broadcast application.

Of course, all three M1500 consoles have legendary Yamaha quality, reliability and craftsmanship. Which explains why you see Yamaha mixers wherever you look. Studios. Concert halls. Clubs. Theatres. Churches. We could go on, but you get the message.

For more information, write: Yamaha International Corporation, Combo Products Division, P.O. Box 6600, Buena Park, CA 90622. In Canada, Yamaha Canada Music Ltd., 135 Milner Ave., Scarborough, Ont. M1S 3R1.



YES! I WANT TO STAY ON TOP OF THE INDUSTRY BY RECEIVING A COPY OF **SOUND & COMMUNICATIONS EVERY MONTH** NEW RENEWAL

1 Year \$15.00 3 Years \$37.50 (Savings \$7.50)
 Payment Enclosed Bill My Credit Card Visa MC AE
 (Foreign: Add \$5) Card # _____ Expires: _____

Signature _____
 Name _____
 Company _____
 Address _____
 City _____ State _____

<p>① Are you a subscriber to Sound & Communications? <input type="checkbox"/> Yes <input type="checkbox"/> No</p> <p>② Primary Job Function (only one): <input type="checkbox"/> Management/Owner <input type="checkbox"/> Engineering/Technical Mgt <input type="checkbox"/> Sales/Marketing <input type="checkbox"/> In-House Maintenance/Service <input type="checkbox"/> Field Installation/Maintenance <input type="checkbox"/> Consultant <input type="checkbox"/> Advertising/Promotion <input type="checkbox"/> Other _____</p>	<p>③ Primary business of company (only one): <input type="checkbox"/> Contractor—Engineered Sound/Acoustical <input type="checkbox"/> Contractor—Interconnect/Intercom <input type="checkbox"/> Contractor—Fire/Alarm/Safety <input type="checkbox"/> Electrical Contractor <input type="checkbox"/> Pro Audio/Studio/Reinforcement <input type="checkbox"/> Architect/Designer <input type="checkbox"/> Engineering/Acoustical Consulting <input type="checkbox"/> Maintenance/Service <input type="checkbox"/> Dealer/Distributor/Rep <input type="checkbox"/> Manufacturer <input type="checkbox"/> Other _____</p>	<p>④ Your purchasing authority is: <input type="checkbox"/> Final approval/Buyer <input type="checkbox"/> Recommend/Specifier <input type="checkbox"/> No Direct Authority/User</p> <p>⑤ Intensity of your product need: <input type="checkbox"/> Have salesman call <input type="checkbox"/> Need within 3-6 months <input type="checkbox"/> Future projects</p> <p>⑥ Number of employees at your company: <input type="checkbox"/> 1-3 <input type="checkbox"/> 4-10 <input type="checkbox"/> 11-25 <input type="checkbox"/> 26-100 <input type="checkbox"/> over 100</p>
--	---	---

YES! I WANT TO STAY ON TOP OF THE INDUSTRY BY RECEIVING A COPY OF **SOUND & COMMUNICATIONS EVERY MONTH** NEW RENEWAL

1 Year \$15.00 3 Years \$37.50 (Savings \$7.50)
 Payment Enclosed Bill My Credit Card Visa MC AE
 (Foreign: Add \$5) Card # _____ Expires: _____

Signature _____
 Name _____
 Company _____
 Address _____
 City _____ State _____

<p>① Are you a subscriber to Sound & Communications? <input type="checkbox"/> Yes <input type="checkbox"/> No</p> <p>② Primary Job Function (only one): <input type="checkbox"/> Management/Owner <input type="checkbox"/> Engineering/Technical Mgt <input type="checkbox"/> Sales/Marketing <input type="checkbox"/> In-House Maintenance/Service <input type="checkbox"/> Field Installation/Maintenance <input type="checkbox"/> Consultant <input type="checkbox"/> Advertising/Promotion <input type="checkbox"/> Other _____</p>	<p>③ Primary business of company (only one): <input type="checkbox"/> Contractor—Engineered Sound/Acoustical <input type="checkbox"/> Contractor—Interconnect/Intercom <input type="checkbox"/> Contractor—Fire/Alarm/Safety <input type="checkbox"/> Electrical Contractor <input type="checkbox"/> Pro Audio/Studio/Reinforcement <input type="checkbox"/> Architect/Designer <input type="checkbox"/> Engineering/Acoustical Consulting <input type="checkbox"/> Maintenance/Service <input type="checkbox"/> Dealer/Distributor/Rep <input type="checkbox"/> Manufacturer <input type="checkbox"/> Other _____</p>	<p>④ Your purchasing authority is: <input type="checkbox"/> Final approval/Buyer <input type="checkbox"/> Recommend/Specifier <input type="checkbox"/> No Direct Authority/User</p> <p>⑤ Intensity of your product need: <input type="checkbox"/> Have salesman call <input type="checkbox"/> Need within 3-6 months <input type="checkbox"/> Future projects</p> <p>⑥ Number of employees at your company: <input type="checkbox"/> 1-3 <input type="checkbox"/> 4-10 <input type="checkbox"/> 11-25 <input type="checkbox"/> 26-100 <input type="checkbox"/> over 100</p>
--	---	---

Subscribe Now!

SOUND & COMMUNICATIONS IS NOT JUST A MAGAZINE... IT'S AN INDUSTRY.



**SOUND &
COMMUNICATIONS
IS NOT JUST
A MAGAZINE...
IT'S AN INDUSTRY.**

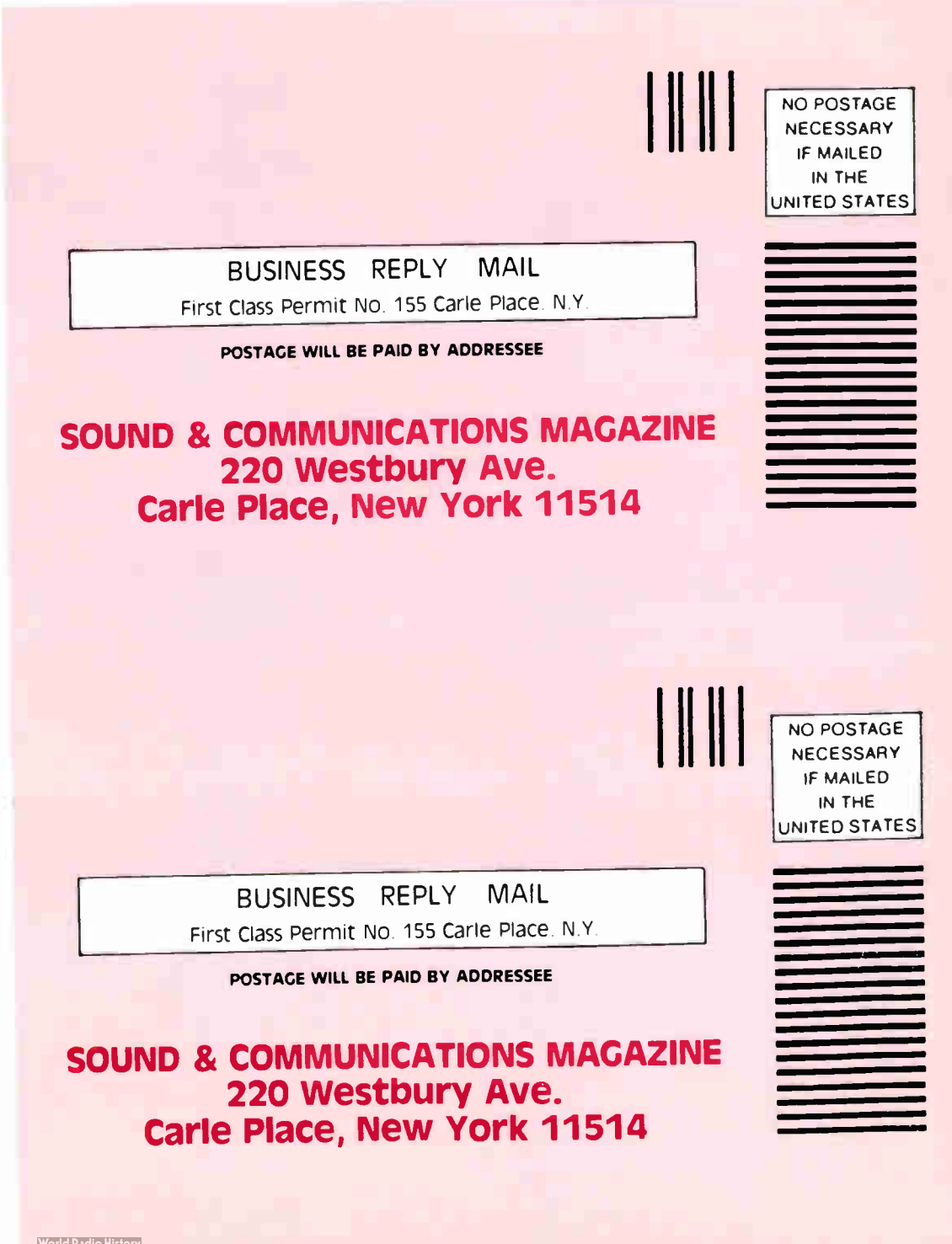

"You've got to keep the tech-minded people happy, but at the same time you've got to keep it simple enough for the lay person," Moore said. He added that many manufacturers have opted for price over quality which has given the industry a bad name.

Paso offers 15 systems with a price range of \$197 for its TA2, a 41-pound, 15 watt, over-the-shoulder model which offers a 200 yard coverage, to \$1,200 for its Amplicolumn, a self-amplified steel column that covers up to 20,000 square feet.

New for Paso is a variation of the Amplicolumn which features a plexiglass copy holder. The unit doubles as a lectern or as a high-powered public address system. The CA160/L has a suggested list price of \$480 and can be set-up in less than five minutes.



The Freedomike 831 from Lectrosomics.

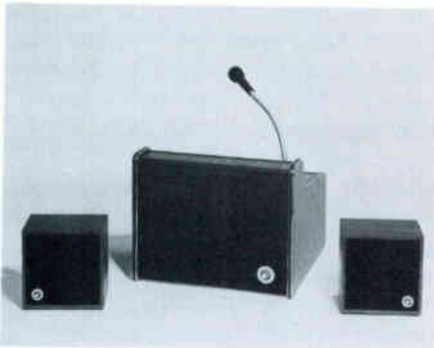

The Voice Projector from Lectrosomics.

Another innovation is a thumb regulated volume control on the microphone, which can be removed from the unit via a retractable cable.

Portable units or those carried while in use should weigh no more than eight pounds, and semi-permanent units should weigh no more than 25 pounds so that almost any individual can use one, Moore recommended.

The trademarked name of Voice Projector has put the 14-year-old Lectrosomics of Albuquerque, NM, on the packaged sound system map. The firm's VP-35, which has been on the



Pioneering better commercial sound system components since 1956



Innovators in engineering acoustic devices and accessories, Fourjay Industries continues to pioneer labor saving installation procedures and to build better baffles and speakers just as it has during its past years of growth.

Fourjay is distinguished as the first to manufacture mounting rings for speakers and baffles—a concept that drastically reduces the amount of labor normally required for installation.

Fourjay is also credited with the introduction of non-metallic baffles to eliminate metallic resonance. First manufactured in fiberglass, Fourjay baffles are now manufactured by injection molding.

In 1975 Fourjay produced the first all non-metallic Re-entrant Paging/Talk-back Horn Speaker. Most recently they introduced the compact Model 440 Thundering Mini, 40 watts continuous speaker with response 500 to 7000 hertz.

Look to Fourjay for solutions. Call us for more information about our innovative line.



FOURJAY INDUSTRIES, INC.
2801 Ontario Ave.
P.O. Box 14617
Dayton, Ohio 45414-0617
(513) 278-9416

Reader Service #240

market for almost 10 years, functions as a free-standing or tabletop lectern and has a suggested list price of \$789.50. It also features a low impedance feed that can be connected to a larger house system.

Two new introductions, the VP-85 at \$599 and VP-85E at \$729.50 are more refined variations of the VP-35 with added features and lower prices. The VP-85E, with its two additional extension speakers and accompanying amplifiers can service up to 2,500 people.

"Wireless has been one of our biggest growth areas," stated Bruce Jones, sales/marketing manager at Lectro-



Peavey's power mixer with two enclosures.

sonics. Two of the company's wireless products are the \$1,027.50, FM-AV4

and the newer FM-AV5 at \$1,049 offer users two FM frequency units between the FCC-assigned frequencies of 30.84 and 42.98 MHz. The units offer complete mobility and the FM-AV5 supplies 33 watts RMS and complement Lectrosonics' line of 12 packaged sound systems.

Jones said he sees the industry primarily as a replacement market. Rental aspects of the industry are also experiencing shake ups since some 12 audio/visual rental chains have acquired smaller rental firms in the last few years, according to Jones. Traditionally, the industry had some 4,000 rental firms. Each chain had an estimated five to 50 branches that offered anywhere from one to 25 packaged sound systems each.

"The market has leveled off some in the last five years," Jones said. "There's an occasional surge when a new market is tapped like aerobics or quarter-horse training as we have recently found for over-the-shoulder units."

As in distribution, the packaged sound system industry has also seen a changing of the guard with the manufacturers who hold the largest market shares. The leaders today are not the leaders of 10 and 15 years ago. One new competitor from another branch of the industry is Peavey Electronics of Meridian, MS, a musical instrument and amplifier specialist, who has attained a strong foothold in the PA market. Peavey packaged sound systems may not be familiar to many sound contractors, because the firm primarily distributes through musical instrument dealers. Hartley Peavey, president of Peavey and its sister company Audio Media Research, predicted that AMR will introduce systems that will cause a quake in the market in 1986.

Peavey claims to be a leader in the packaged sound system industry although most sales have not been through the conventional avenues.

One model backing Peavey's claim is the \$600 XR600, a 300-watt RMS with .1 percent distortion into 2 ohms amp/mixer that can be combined with a host of Peavey speakers. The unit comes with built in compression and a two-band equalizer per channel.

"We have the major share of this market," Peavey said. "We build hundreds of these units per day. You'd be hard pressed to find some of the people who are claiming to have major

Six new things from NEI:

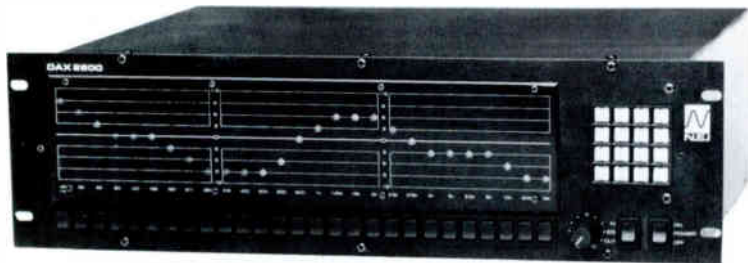

The DAX 2800. A digitally controlled 28-band third-octave graphic equalizer.

The DAX 2800. A digitally controlled 28-band third-octave real time analyzer.

The DAX 2800. Storage and immediate recall of 16 digital EQ or RTA memory settings.

The DAX 2800. Instantaneous automatic EQ and RTA averaging! A real time-saver when equalizing acoustically complex rooms.

The DAX 2800. Automatic equalization to any RTA memory setting! The **DAX 2800** will actually measure the room and quickly EQ your system to any desired memory setting!

The DAX 2800. The master programmer for NEI's new DAX EQ POD, a blank-panelled, dedicated third-octave equalizer for permanent sound system installations.

The DAX 2800. Truly a remarkable integration of high-quality audio engineering and digital technology.

See our complete line of professional audio equipment.

934 N.E. 25th Avenue • Portland, Oregon 97232
Telephone (503) 232-4445 • Telex 364412 INTR



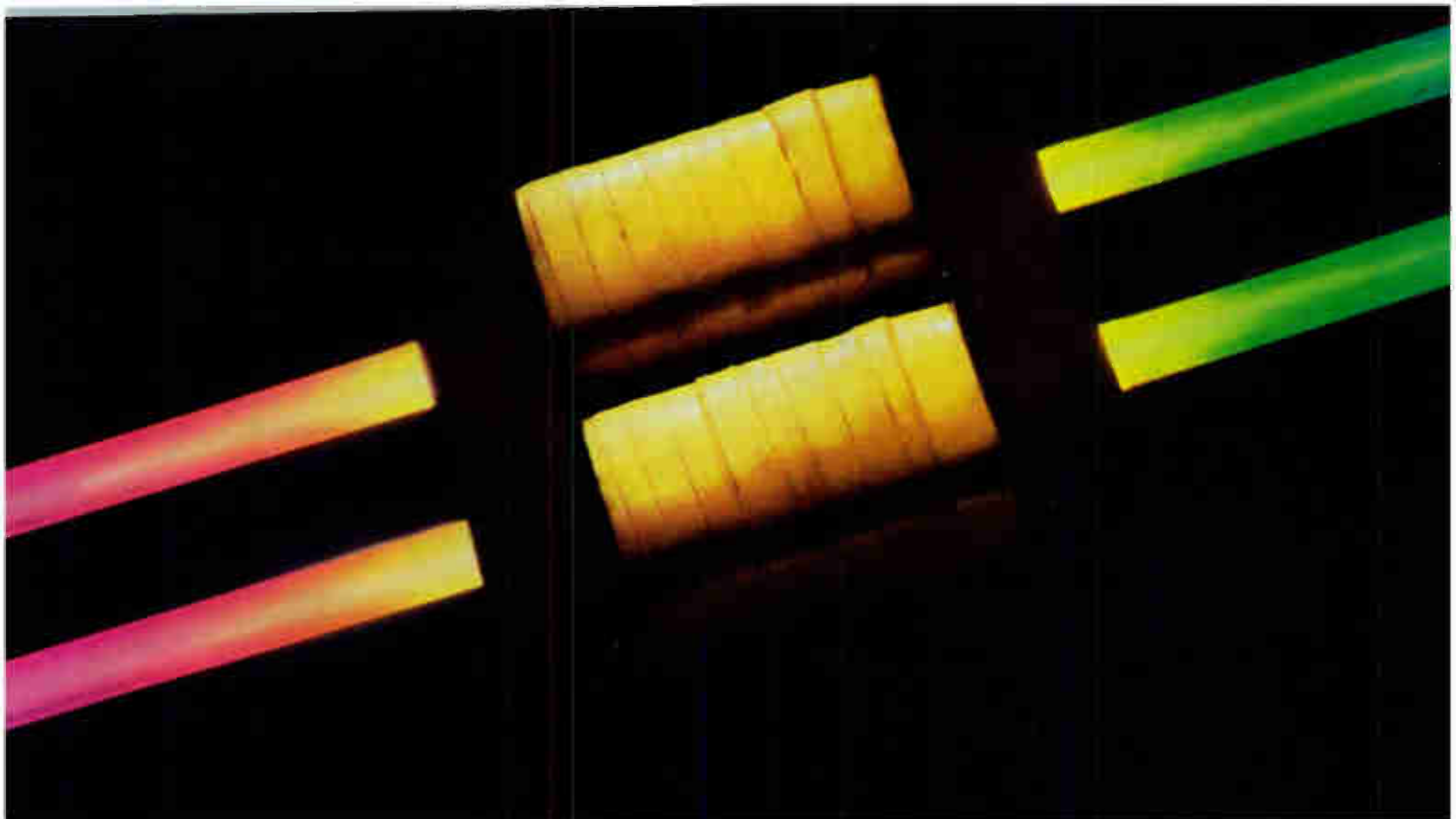

Our painstaking vacuum and coil-winding technology increases efficiency and eliminates acoustical 'buzz'

OUR SCIENTISTS HAD TO OPERATE IN A VACUUM TO GIVE YOU A NEW QUALITY OF SOUND.

The quality of any sound system begins at its source. Precision in the power supply is vital to capturing and maintaining the fullness and subtlety of amplified sound. The need for that exactness is why we insist on operating in a vacuum rather than depending on outside sources.

A vacuum tank, to be precise. An environment in which our transformer is created with an air expulsion process. Where air pockets are purged from multi-layers of the transformer's high grade core laminations, and the core made airtight with a special impregnating sealant.

This process gives us impeccable control of transformer function and quality. Which gives you the assurance of the most efficient transfer of power possible, and an end to the acoustical "buzz" that so often fights sound purity.

To a lot of manufacturers the lowly transformer is far down on the list of priorities. For us, every element in the sound system relies on the exacting performance of every other element, and must be painstakingly attended to.

Whether you're driving your studio monitors in a demanding final mix, or powering a massive sound reinforcement array, you'll find our technology giving outstanding clarity to your work in products from our new Model 6230 and 6260 amplifiers to our broad line of signal processing equipment. To find out which system is designed to meet your needs, contact your authorized JBL/UREI professional products dealer today.



JBL Incorporated,
8500 Balboa Boulevard,
P.O. Box 2200,
Northridge, CA 91329
U.S.A.



UREI
ELECTRONIC
PRODUCTS

JBL harman international © JBL INCORPORATED 1984

Reader Service #287

D U P

L E X

I N T E R

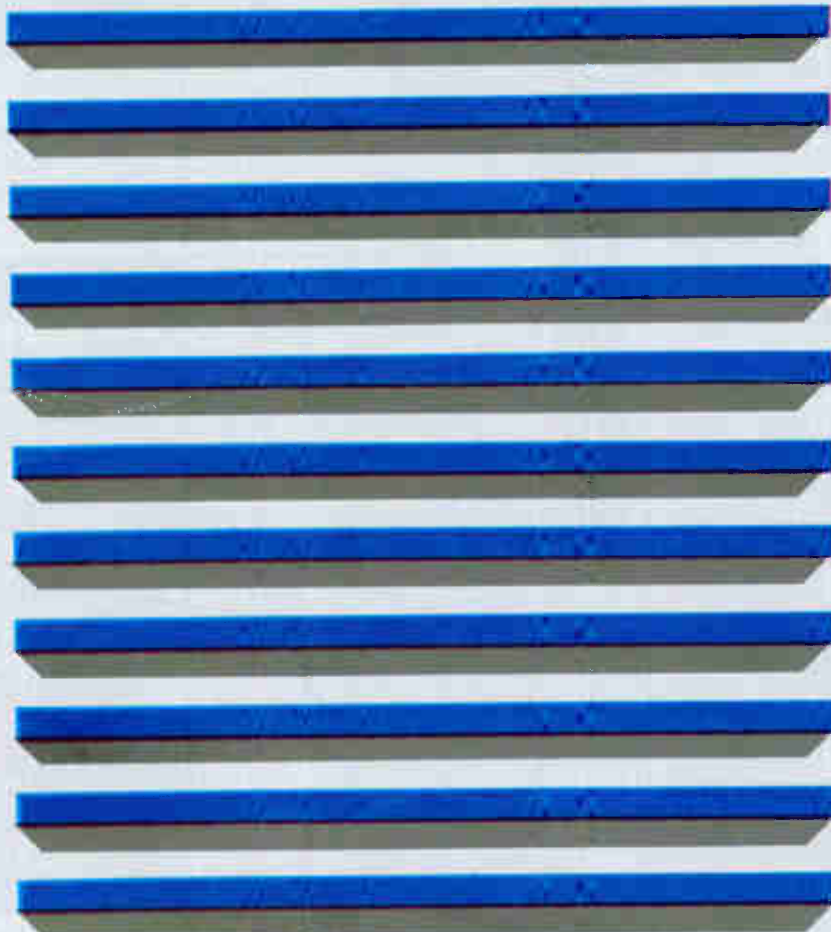

Back On Track

by Peter McLean
Vice President, Internal Communications
Ring Group of North America

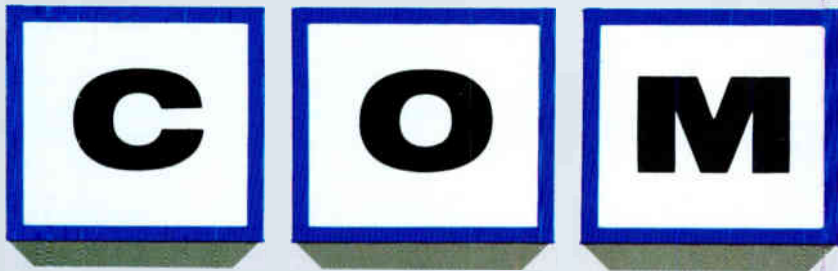

Duplex intercoms allow handsfree, two-way internal communications to be handled efficiently.

For a few months, Sound & Communications has been reporting on the resurgence of the duplex intercom. The following is how one major manufacturer of duplex, Ring Group of North America, dealt with the market slump and as a result turned its strategy around to better market and sell duplex intercom systems.

A sampling of some of the duplex systems in the marketplace appears on page 28.

Hold the obituary! Rumors of duplex intercom's demise have been greatly exaggerated. The truth is, duplex intercom sales never died—they were subverted by our inability to respond quickly enough to the changing needs of the marketplace. The mortality rate was unfortunately high, and sadly, predictable and avoidable.

The Bottom Falls Out

We went wrong down many different trails. Some of us continued selling the same old tired applications, not bothering to explore new uses or markets. As a result, sales curves relaxed at the bottom. Many firms, curiously enough, were thrown by new technology. The competition of electronic phone systems with built-in intercoms seemingly offered a knockout punch to stand-alone duplex systems. Many companies went down for the count, abandoning duplex sales. Others simply grew too complacent, accepting whatever orders came through the transom as if the business world would continue lining up at their doorstep, purchase orders in hand. They rested their fortunes on their previous successes, many never awakening from that blissful state.

But now, it's 1985. Deregulation is fact and interconnect is in. The duplex intercom market is thriving, much healthier than ever. Can it be that we've finally learned the lessons so many of our peers failed to master? From Ring's perspective, the answer is yes!

EZ CALL electronic code call system

25, 49, or
343 CODE
CAPACITY



- Alarm
- Telephone Access
- Up to 7 Messages

EZ CALL is the answer for many organizations who have to locate people quickly and confidentially — coded calls are FAST, PERSONAL, and DO NOT DISTURB other individuals.

TELEPHONE SALES AND SERVICE COMPANY
25 DeForest Street, Amityville, New York 11701 516-842-4800



Reader Service #245

OWI Think Small, Think Quick.

B A P - 1 0 0

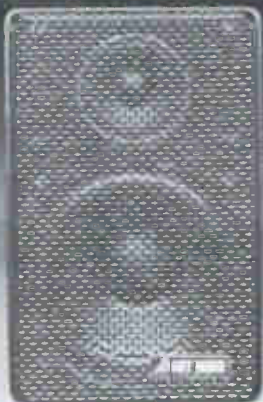

OWI brings forward a special kind of qualitative, extension mini-speaker, one intended for the installer as well as the end user: The BAP-100./SMALL BUT EFFECTIVE. Dimensions of 7-1/8"

× 4-1/2" × 4-1/8" allow easy handling and unobtrusive installation, yet this 2-Way sacrifices little else./SPEEDY INSTALLATION. With features such as a built-in line matching transformer, input power selector knob (2.5W,



Exercise sound judgement — investigate the BAP-100, BAP-25 and OWI's complete mini-speaker line, including the weatherized, outdoor BAW-50. The quicker the better.

5W, 10W or 15W) and an input line voltage of 70.7V, nothing extra is necessary beside a screwdriver or possibly, a power drill. Needless to say, this aluminum die-cast model comes complete with a bracket and hardware. OWI also makes available the BAP-25 (with a 25V line).

Designed For Background/Foreground Music.
OWI INCORPORATED 1160 Mahalo Place., Compton, CA 90220, (213) 638-4732

Reader Service #246

The International Connection

Product and reputation are the two most important attributes a company should have. As the wholly owned subsidiary of Scanvest Ring A/S of Norway, Ring Group of North America has strongly benefitted from the close relationship with our parent. Scanvest Ring, a manufacturer and marketer of telecommunications systems, computers and office automation systems, is one of Scandinavia's leading suppliers in the field of information processing.

Laying The Foundation

In 1983, we gutted our organization in order to achieve our long term goals. We reevaluated our entire marketing structure and redesigned it to become more responsive to our distributors and end users alike. Manufacturers' reps were hired to blanket the nation in a support web. We then went to work, in tandem with our reps, to identify strong dealers, familiarize them with our duplex intercom systems and bring them on board. Training sessions were held, manuals and support materials were prepared, and distributed and qualified leads were fed to our distributors. We introduced a toll-free 800 number to be of maximum assistance. We also enlarged our warehouse and expanded our support staff as a further concrete sign of our renewed commitment.

Calls placed on hold or calls that must be returned because someone couldn't be located hurt businesses in their bottom line.

An in-house software research and development department was formed which works to continually improve our products as well as test all of our systems in actual customer configurations before they are shipped. This particular element of our work is costly and time consuming, but save lots of aggravation, costly reshipments and evokes a positive and reliable reputation for our company's products.

Marketing Duplex Intercoms

Extensive market research revealed the need for duplex intercom systems in specialized areas including hospitals and health care facilities, correctional

(continued on page 30)

THE dbx LINE

INDUSTRY STANDARDS



STANDARD-BEARER When so much is at stake in your sound, why settle for anything less than this classic? The 160X is the most popular compressor we — the leader in the field — have ever made. And for good reason. It's user-friendly (with at-a-glance metering), it operates at pro (+4) levels, and it's full of features you've demanded: switchable compression (including our famous OverEasy); "dynamic reversal" effects ($\infty:1$ to $-1:1$ compression); detector input; stereo linking; versatile connections (barrier strip or jacks).



TOP OF THE LINE The dbx 165A truly has it all. It's manual and automatic, flexible and continuously variable. No-error stereo strapping... OverEasy compression... and of course PeakStop — absolute protection against unwanted signal peaks without audible distortion! It's a broadcaster's dream... yet completely at home in the studio.



SILENCE, PLEASE With the advent of digital recording and transmission, any noise is more of a no-no than ever. Oh sure, you're going digital — eventually. But until then, get full "digital" silence on your analog projects by using dbx noise reduction. It's quieter than 16-bit PCM (honest). No wonder that in the last ten years, dbx has taken over the NR market, from small applications to the biggest.



TOTAL CONTROL, TOTAL VERSATILITY — AND TOUGH, TOO We do mean total. Look at what you can put into a 900 frame. You knew about some of these modules, but not all of them, we'll bet. These set the pace for complete signal processing in the recording and broadcasting industries.



DIGITAL NOW! You've read the articles about the dbx model 700. About its revolutionary digital technology... its musical, crystal-clear sound quality ("non-PCM," some say)... its enthusiastic acceptance by all segments of the industry. You've even been thinking of getting one. Did you know it's still only \$4600? (And yes, you can do fine editing, error-corrected copying, and now disc-mastering!) Broadcasters should know about the 700's application as the best STL in the world. Just ask WGBH-FM, the country's leading public radio station, about the sound — and the audience response — they're getting from their live Boston Symphony Orchestra broadcasts via the 700. (Recently, New York's WNYC decided to follow suit!)

dbx

Professional Products Division
71 Chapel St.
Newton, Mass. 02195 USA
Telephone: (617) 964-3210
Telex: 92-2522

THE STANDARDS
OF THE
PROFESSIONAL
AUDIO INDUSTRY

Reader Service #238

World Radio History

In the marketplace...



The Siedle Intercom-2000 is a semi-duplex system: microprocessor controlled, decentralized, with supplementary and control functions.



Through a central video display, connected to a Stentofon Pamex MPC Intercom System, you can see who's in, who's out, and when they will be back.



F/B Ektacom's hands-free digital intercom uses a simple, three-pair cable that circulates between stations.

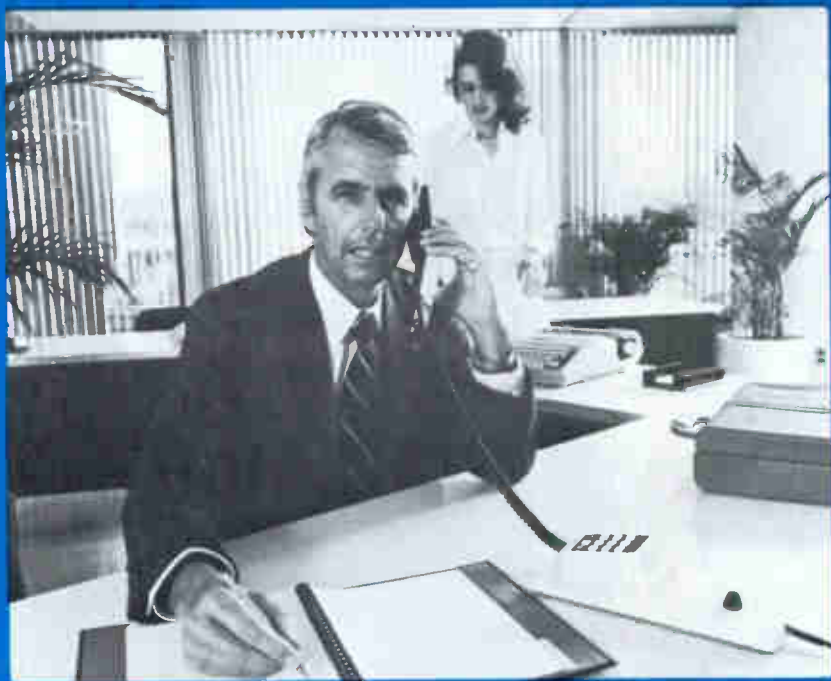

TOA's duplex intercom is a micro-computerized system.



Ring Group's duplex system is microprocessor-controlled unit that offers optional two-way radio, telephone, and alarm interfacing.



YKX combination speaker-phone intercom by Aiphone is a microprocessor-based intercom.



Clear-Com offers the CS-120 two-channel main station which supports up to 60 remote channels.



Through a central video display, connected to a Stentofon Pamex MPC Intercom System, you can see who's in, who's out, and when they will be back.

DUPLEX INTERCOM

(continued from page 26)

institutions, data processing centers, and the financial industry (banks and brokerage firms). We met with a wide range of end users, from secretarial and support staffs to middle management to CEO's; listening to their needs and trying to understand how they did business.

As a result, we created a niche marketing plan, placing the greatest proportion of our resources into the development of products and applications for these markets. Ring's presence in the marketplace has been bolstered through an aggressive advertising and public relations campaign. The direct mail route has also proven itself with a strong response and a high ratio of qualified sales leads, all of which were shared with our dealer network.

In diversifying our market efforts, we've also entered into a number of OEM agreements. In the financial community, for example, many different trader turrets feature Ring-Master intercoms. We've also been careful not to favor any end of the in-

dustry. As a result, some BOCs now sell Ring-Master intercoms.

Back to Basics

Most importantly, we've educated the entire intercom selling family to the strong true advantages of duplex systems. Calls placed on hold or calls that must be returned because someone couldn't be located hurt businesses in their bottom line. The standard industry axiom of letting a telephone do what it does best—external communications, i.e. handle calls going into or out of a company—was never truer. Duplex intercoms allow handsfree, two-way internal communications to be handled efficiently.

The duplex intercom debate may go on forever within our industry. But, if the level of business being written is indicative of the real need and desire for this kind of equipment, the wise contractor will leave the debate for their competitors while he starts making sales.

**SUBSCRIBE TO
SOUND &
COMMUNICATIONS**

THE GALAXY AUDIO HOT SPOT



PART II

Quality Design

- * **Two 5" Drivers**
5lbs. of magnet structure.
- * **High Temperature Voice Coils**
For 120 watts power rating.
- * **Step Attenuator
Volume Control**
More control & it won't burn out.
(Available on Hot Spot VC model)
Reader Service #292

Write or call for free literature
on monitors and mixing consoles
GALAXY AUDIO/625 E. Pawnee/Wichita, Kansas 67211
316-263-2852

PROFESSIONAL PERFORMANCE AFFORDABLE PRICE

System 420—A Truly Cost-Effective Wireless

- Uncompromising audio quality
- Solid RF—no interference guaranteed
- Your choice of microphones
- AC or external DC-powered receiver

The HME System 420, built to the same exacting standards as the systems used by leading entertainers, TV networks, and Broadway theatres, but priced for the budget-minded user.

A four-section helical resonator, multi-pole IF filters, and heavy RF shielding in our receiver, minimize the possibility of outside interference. If local interference should occur, HME will solve the problem, at no cost, or your money will be refunded, within 90 days of purchase.

Call or write for detailed information on HME's complete line of wireless microphones, wireless intercoms and cabled intercoms.

hme
HM ELECTRONICS, INC.

9675
Business Park
Avenue
San Diego, CA 92131
(619) 578-8300
Telex: 350-771

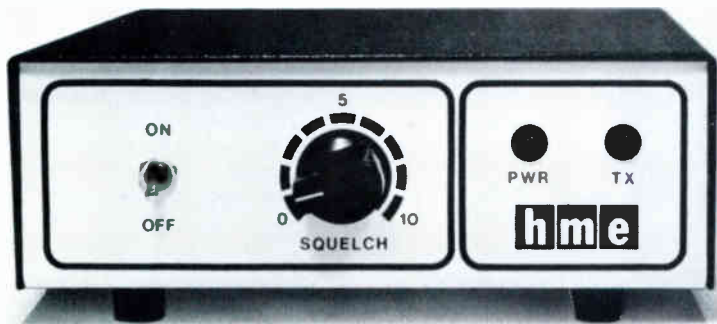



MOSFET MASTERY

Two New Power Amplifiers Bring MOSFET Reliability and Performance to Engineered Sound Systems

Now the advantages of Power MOSFET design are available in 125-watt and 250-watt power amplifiers specifically designed for engineered sound system applications.

Bogen's new HI-TEK™ Professional Models HTA-125 and HTA-250 incorporate Power MOSFET output stages specially selected for their cooler operation, linearity, flat response, and higher switching speeds. Among the resulting benefits are unsurpassed reliability and performance, reduced size, lighter weight, higher efficiency, lower power consumption.

The HI-TEK™ amplifiers can safely drive any recommended load continuously, with less than 0.5% total harmonic distortion, and frequency response ± 1 dB, 20 Hz to

20 KHz at rated power. Unlike other types of transistor amplifiers, they need not fear thermal runaway or secondary breakdown.

The MOSFETS are cost effective, too. Thanks to their simplified circuitry and heat-dissipation requirements, the HTA-125 and HTA-250 are not only superior amplifiers, they are also competitively priced.

Just two more reasons why Bogen is the one to watch in sound. For more information, call or write:

 **BOGEN**®
A LEAR SIEGLER COMPANY
P.O. Box 500, Paramus, NJ 07653
(201) 343-5700

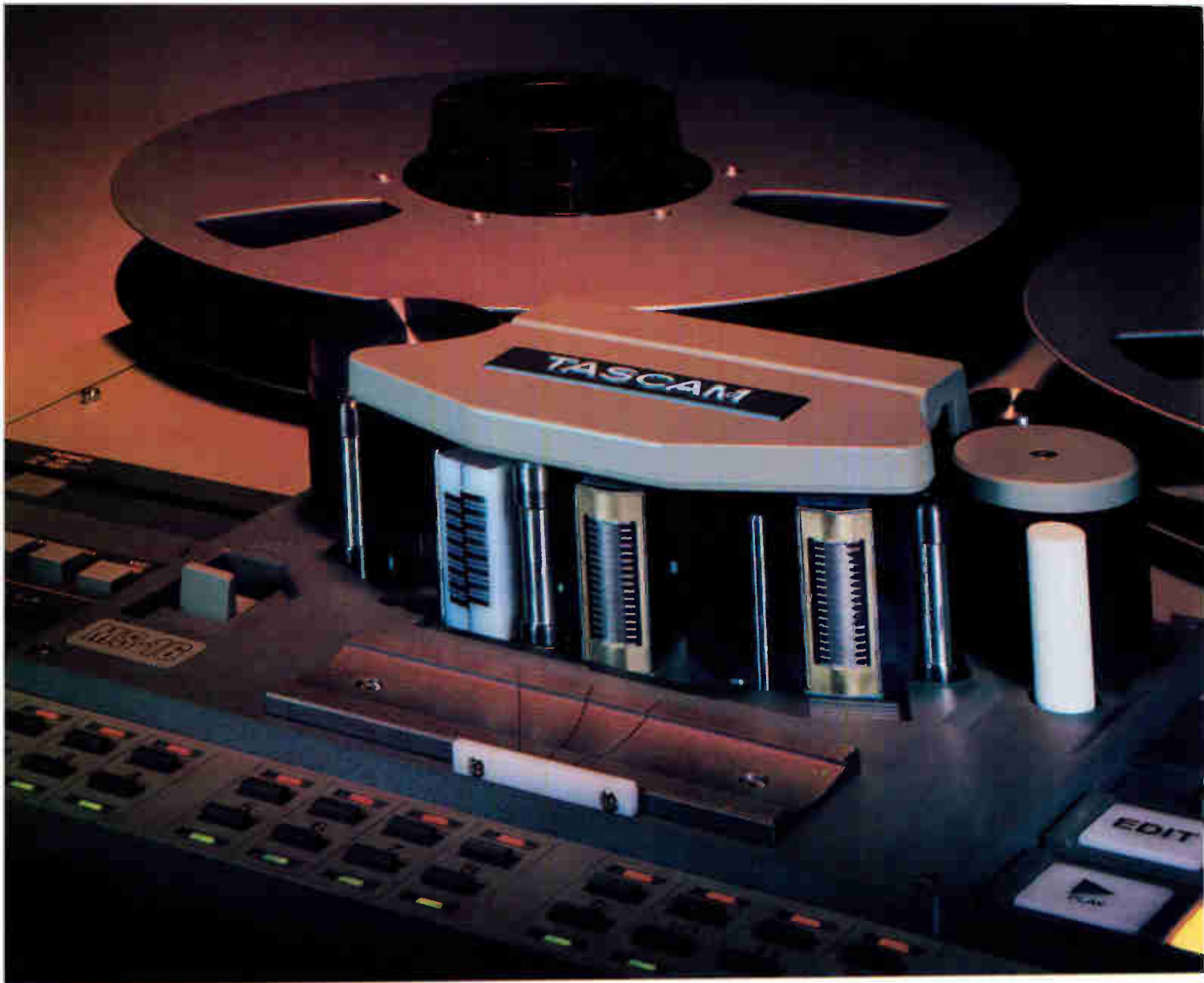

FINISH UP ON TIME WITHOUT SACRIFICING QUALITY.

You want it quick and you want it good. In today's competitive post-production audio/visual scene, the rewards go to those who can produce results that are quick *and* good. That's why TASCAM designed the MS-16 1" 16-track recorder—to bring together top-notch audio quality plus premium features that streamline production and move you ahead of schedule.

Quality reproduction starts with the heads, and TASCAM has three decades of design experience behind the MS-16's new micro-radii heads. They bring "head bumps" under control and ensure flat frequency response. And unlike most tape machines, the MS-16 record/sync and playback heads are identical in performance. Because sync response equals repro response on the MS-16, you can make critical EQ and processing decisions on overdubs or punch-ins without having to go back and listen a second time. You get what you want sooner and with fewer headaches.

The MS-16 cuts down on the time you spend locking up with other audio and video machines as well. A 38-pin standard SMPTE/EBU interface affords speedy, single-cable connection with most popular synchronizers and editing systems. It's the easy, efficient way to get the most out of today's sophisticated synchronization equipment. The MS-16's new Omega Drive transport is tough enough to stand up to long days of constant shuttling... while handling tapes with the kid-glove kindness they deserve.

Record/Function switches for each track allow effortless, one-button punch-ins. Input Enable allows instant talkback during rewinds, fast forwards and cue searches. These features speed you through sessions and let you concentrate on the project at hand... not on your tape machine.

Take a closer look at the MS-16. See your TASCAM dealer for a demo or write us for more information at 7733 Telegraph Road Montebello, CA 90640.

THE TASCAM MS-16 SIXTEEN TRACK



TASCAM THE SCIENCE OF BRINGING ART TO LIFE.



SERVICING TODAY

Eliminating Downtime

by Walker Cottrell

Cottrell on Quality

In the past decade, various buzz phrases, including "computer grade," "video standard," or "hi-tech quality" have been used to describe the up-graded level of component quality now being used by many producers of sound amplifiers, signal processors, mixing boards, and other elements contractors are incorporating in their sound and communication installations. Loudspeakers, horn drivers, connectors, and microphones also have enjoyed electrical and mechanical improvements—all leading to extended life and higher reliability.

Most successful contractors believe keeping systems functioning as intended, shares equal importance with selling them in the first place. The average user/buyer is not interested in brand names or technical specifications, but rather the cost effectiveness of the utility of the installation over the long term. After the sale support is mandatory for contractors who want to be called when the system is expanded, or when another project is anticipated by the owner.

Today's equipment reflects the advances in component quality and performance. Carefully selected and pro-

perly installed systems can deliver years of trouble-free utility.

As most contractors know, the majority of troubles are usually electro-mechanical faults which can be quickly repaired on site. Faulty switches, broken connections, dirty relays, bad cords, open circuit breakers at AC panels, and other minor non-electronic faults produce most of the calls for service. Today it is rare to find smoking power transformers, shorted filters, bad circuit boards, and other troubles of the 1960s and 70s. Although, from time to time there are faulty output transistors, which can be quickly iden-

of the 1960s and 70s. Although, from time to time there are faulty output transistors, which can be quickly identified and on site replaced.

It is the *obligation of the manufacturer* to supply his customer with workable, quality, dependable equipment. It is the *duty of the installer-contractor* to deploy the equipment for the purpose intended in a manner reflecting good engineering and trade practice, thereby providing the user with the function he has purchased and can properly expect.

Contractors On Service

High technology is having a profound effect on the workbench. Most service work bypasses the bench entirely, while other work can be done by simply replacing the proper circuit card. Although systems are getting more sophisticated, modular construction and higher quality assurance keeps a system's down time to a minimum—an important sales consideration.

Barry Glick, president of Glicktronix in Clifton, NJ, said that particularly in the area of telephone interconnect, reliable electronics and better system organization have saved money and added to the longevity of systems, once it survives the initial few months.

"There is a noticeable infant mortality rate among new interconnect systems, but once electronic PBXs or CPUs are in place, phone systems have a considerably longer trouble-free life," Glick said. He explained that with phones themselves, mechanical rotary parts and relays in traditional 182 phones wear out quickly due to friction and wear, while electronic stations, after proven operational over a few months of operation, will function uninterrupted for years. Unless damaged by accident or until general wear affects non-electrical parts—the circuits are secure.

"In the old days, we needed a skilled technician who could understand the schematic, trace an open, and find out why the system wasn't functioning, put it on the bench and fix it. Today, you pop out the bad module and put in a new one." He said it is pretty much the same for sound systems and intercoms, but that the installer still needs to know about sound and repairing amps and electro-mechanical devices.

"They haven't gone digital yet, so there is less complexity. But that means you have electro-mechanical devices to repair," said Glick.

"When a client notifies us that the phone system isn't working, it's always one of four things. First, it could be a Bell System problem, not related to our work, which they fix. Second, it could be a user mistake. In this case, we simply talk the user through the system on the phone. Third, it could be a station problem. We just place a replacement station in a box and ship it UPS Next Day. And they just put the station that failed in the same box and send it back to us. The fourth problem could be a bad switch, or something legitimately wrong with the system. Quite often—about 85 percent of the time—it turns out to be a Bell problem. And they send someone who says it's not. Often we locate the problem, and it is their's, especially with PBX systems. They lay star trunk lines without being able to
(continued on page 38)

Exceptional Sound Quality ... And Sound Profits

Our customers are important to us. That's why we manufacture sound products built to stringent and exacting standards — to keep our customers one step ahead of their competition.

Dukane sound products are built for reliability and flexibility — to solve even the toughest communications problems. Designed for high quality sound reproduction, our *new* horns, amplifiers, and speakers deliver the outstanding performance

you expect from Dukane. Our new amplifiers are versatile... compatible with all telephone systems. And they're competitively priced to put greater profits in your pocket.

Dukane sound products — exceptional sound quality and exceptionally sound profits. Interested in taking a closer look at how you can increase your sound revenues? Contact Dukane today.

DUKANE CORPORATION/COMMUNICATIONS SYSTEMS DIVISION
2900 DUKANE DRIVE/ST. CHARLES, IL. 60174/1-312-584-2300



Reader Service #252

SWISS PERFECTION

NEUTRIK® AUDIO CONNECTORS ON THE CUTTING EDGE.

Audio connectors that can't cut it have no place in today's sophisticated audio market. Which is why sound professionals who demand perfection from their equipment rely on Neutrik products available only from Kulka-Smith and its authorized distributors.

Neutrik is known for a broad, innovative line of superior audio connectors. Like compact, screwless X Series connectors that are simple to assemble and disassemble and will accommodate larger OD cables. High quality XLR straight and right-angle cable connectors. The unique 'D' Series receptacle with a printed circuit mount that requires less panel space than ever. And superior phone jacks and plugs.

In addition, Kulka-Smith offers modules, adapters and a full complement of products that keeps Neutrik's line a cut above the rest. Now, if that sounds like music to your ears, contact us for more information. Kulka-Smith, Inc., 1913 Atlantic Ave., Manasquan, NJ 08736. (201) 223-9400.

**Kulka
Smith**
A NORTH AMERICAN PHILIPS COMPANY

Reader Service #283

World Radio History

RING. TWO YEARS LATER. AND 300% GREATER.

Two years ago, we made you some very big promises.

Two years later, we're 300% larger. And if you're a Ring distributor, it's growth you've not only contributed to, but shared in.

Number-one in intercommunications.

Today, Ring is the largest manufacturer of duplex intercoms marketed in North America. Considered by industry professionals the benchmark in performance and reliability.

This year saw the sale of the largest intercom system ever installed in the United States (over 1800 stations) to a major financial institution, where speed and reliability are absolutely essential. And, backed by a successful track record—plus aggressive marketing and promotion—we set sales records in targeted vertical markets such as health care, data centers, correctional institutions, brokerages and banks—to name just a few.

Our innovative new Ring 3000 has brought us similar success in the school market as well.

Number-one in automatic call distribution.

Ring is now also the recognized leader in enhanced 9-1-1 emergency automatic call distribution systems. This year alone, we accepted orders for

nine major metropolitan areas. And the trend is accelerating.

Ring designed and introduced a new line of digital call distribution systems that makes advanced call-processing technology accessible and affordable to smaller- and medium-sized commercial users.

Number-one in the future.

With all this progress, we're not about to rest on our achievements. We've introduced our new Scanpager™—a pocket paging message information system incorporating alphanumeric display, expanded storage, hard-copy capabilities and many other unique features. We've expanded our staff, including software R&D, technical and sales support. We've enlarged our service and warehouse facilities. And we've developed powerful new marketing programs to help our distributors make the most of all these resources.

Thank you for the past. And the future.

Last year, we thanked you for helping us make the preceding year the most successful ever. And this year, we're happy to be thanking you for the same, once again.

So if you've been thinking about giving Ring a ring, maybe it's time you called our toll-free number.

Or, you could lose another year.

CALL TOLL FREE 1-800-645-9690

OORING
RING GROUP OF NORTH AMERICA

230 Community Drive, Great Neck, New York 11021 Call Toll-Free 800-645-9690; in NY Metro Area, 516-487-0250;
Other offices in California, Canada and Mexico • Solid-State Microcomputer-Based Intercoms • Automatic Call Distribution Systems • Tridex™
• 911/Emergency ACD • Ring-Master™ • Ring 3000 School System

© 1985, Ring Group of North America, a subsidiary of Scanvest-Ring A/S

Reader Service #254

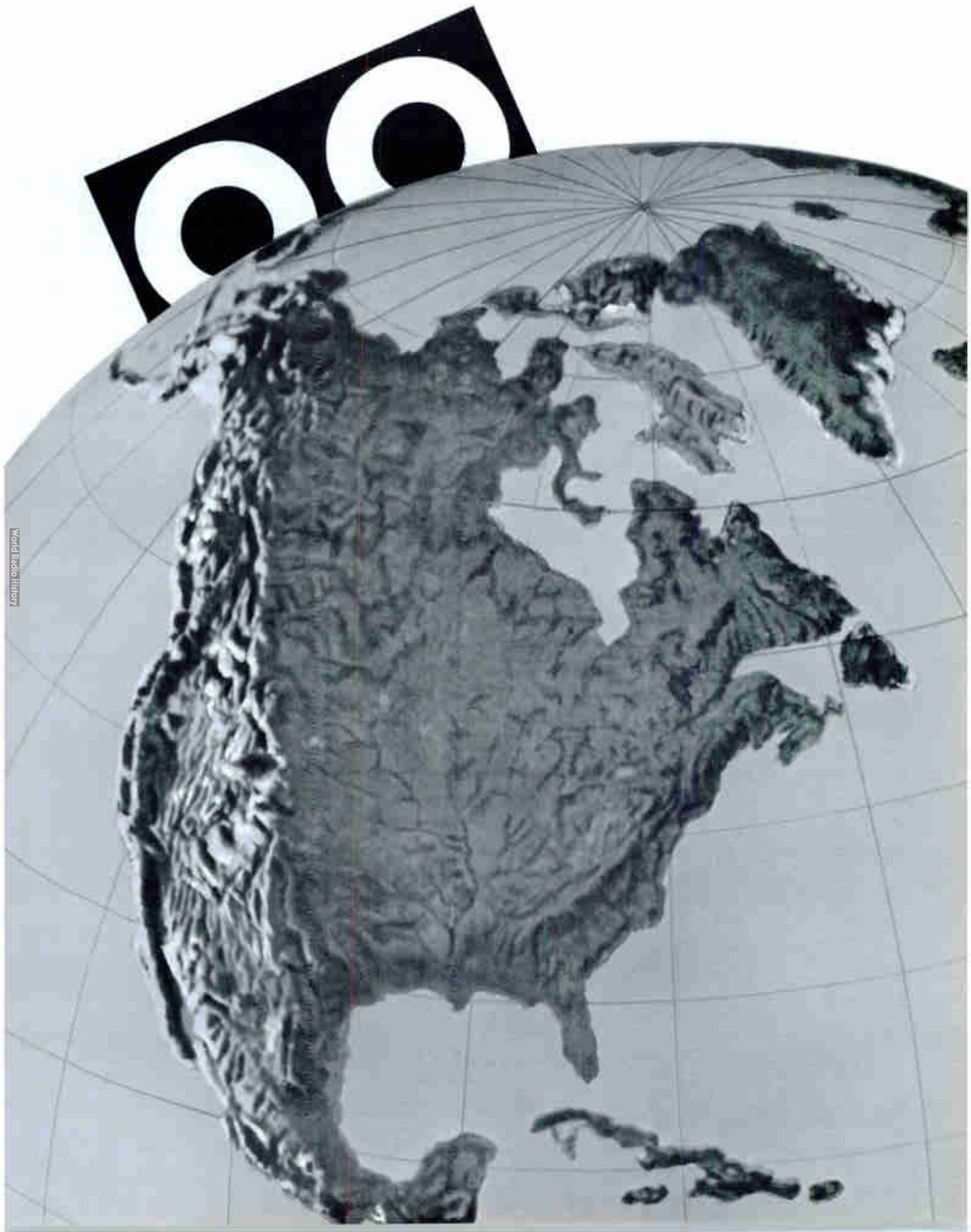

SERVICING TODAY

(continued from page 34)

test polarity. In many cases Bell workmen just don't have the knowledge to confirm polarity, so they just check for a dial tone, and say their part is okay.

"Of course, sometimes it is our fault, and then we end up sending out a crew to fix it, but the vast majority of calls are handled via telephone, UPS or Bell, without us ever sending a

crew," said Glick.

"With microchips, the manufacturers generally make the repairs, though a contractor with those capabilities can save a lot of money. Manufacturers put in a 20-cent chip and charge you a quarter to a third the price of a new phone. They make a considerable profit, but it still pays to have the unit repaired. Manufacturers know this, and they're very careful to make sure it is still worth your while to get the unit repaired. We fix our own

182 phones," he said.

Clarence Hessing of Aatronics Inc. in Boise, ID, said, "The biggest trend in repair is toward a more modular approach to systems so that the field person can unplug and repair the unit right in the field instead of taking it home for a lengthy search through each circuit. If you go to the job with spare modules, you can send the bad one back to the factory or to a factory authorized service center when you take it back, leaving the customer immediately with a working system.

"As far as installations go, they are now learning to make wiring more of a fastener or multi-pin connector job instead of having to connect and solder everything. It makes things like putting an intercom system in so much faster, and it makes replacement or bad parts much more simple. Of course, with the growing sophistication of computerized equipment, everything is getting more complex at the same time," he said.

He explained that locating a problem in a system can be tough today as well, though there are some basic ways to locate problems.

"You still have to use good sense and rely on your experience with systems. Usually, you can listen to a system and tell about where the problem is located. Then you simply have to replace that section, usually in the field. A few do come back to the shop, but not as many as in the past, when you had to take the amps apart and turn them upside down in the field. And if you couldn't see any signs of a burned out section, you had to bring it back to the shop and search for hours. It's a second service call to bring it back out again," Hessing said.

Cliff Fortin, senior bench technician at Industrial Communication Company of Oak Park, MI, said that it's often tough to keep up with the state of the art in the commercial sound industry. Getting the proper information or schematics for the latest "state-of-the-art" designs can pose some difficulties.

He said Industrial Communication still services everything it sells with its own warranty with few "rare" exceptions. He also said that the modularity of products allows for an awful lot of convenience in servicing. "We're prime contractors for K-Mart stores nationwide, so we see a lot of routine amplifier service. We can service the

(continued on page 75)

ANOTHER NEW PRODUCT FROM J. W. DAVIS

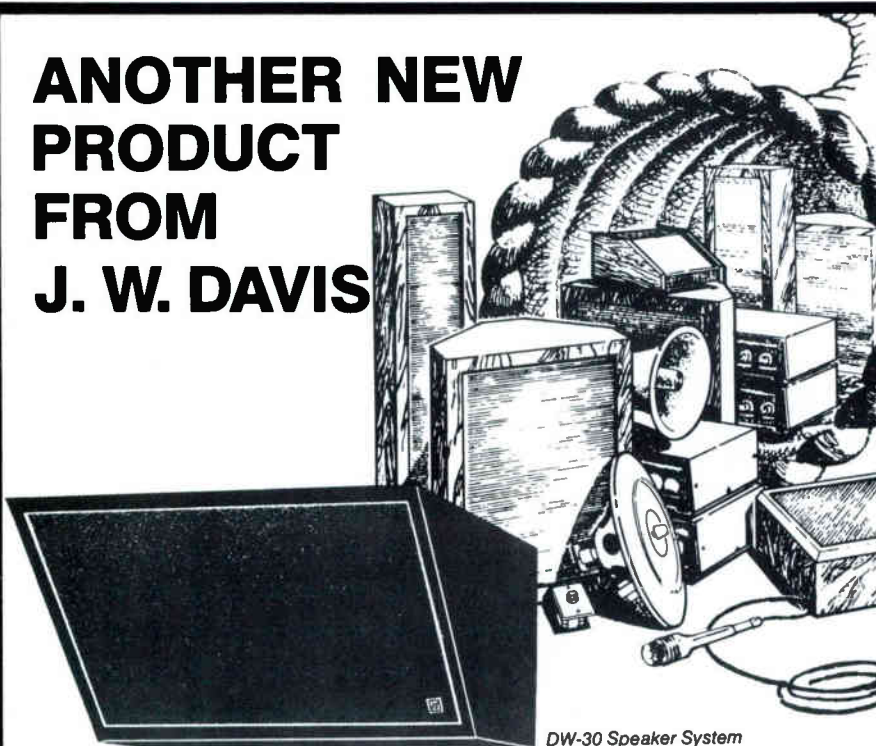

DW-30 Speaker System

Heard our update of a classic design?

The DW-30 unites the latest speaker technology with a field-tested product... and at a practical price. Especially recommended for auditoriums, theaters and meeting rooms requiring clear, faithful voice reproduction. Precise engineering of the tuned port enclosure also provides lower frequencies necessary for background music applications. Sound is cleanly projected by a heavy-duty woofer and an exponential horn tweeter. Minimal phase distortion is assured by a first order crossover network. Size, weight, shape and finish of the cabinet allow maximum versatility. Rated at 30 watts continuous input.

At Davis, our guarantee of satisfaction permits purchase of the DW-30 speaker system with complete confidence!... Call toll-free for performance specifications on the DW series systems plus information on our entire line of products necessary to do a professional sound installation.



J.W. DAVIS & COMPANY

3215 Canton Street • P.O. Box 26177 • Dallas, Texas 75226 • 214-651-7341 (Dallas)
Toll free 1-800-442-1564 (Texas) • Toll free 1-800-527-5705 (Outside Texas)

Installation Profile:

More to Sound than Meets the Eye

by Bob Kehl
Systems Consultant, AVC Systems Inc.

Edited by N. Peterson

The Ordway Music Theatre, St. Paul, Minnesota's newest performing arts center is styled after 19th century European opera houses and is adorned with luxurious seating, ornate plaster and woodwork, and elegant lighting. The acoustics can be "tuned" to suit a chamber orchestra, an opera, or a range of other performances. But, more than the acoustical properties of the theater are responsible for the "Ordway sound."

A little known fact is that a listener seated in the main house of the Ordway is surrounded by more than 250 loudspeakers hidden in the architecture of theater. The speakers are part of the sound system installed by AVC Systems of Minneapolis, MN, and designed by R. Lawrence Kirkegaard & Associates of Downers Grove, IL.

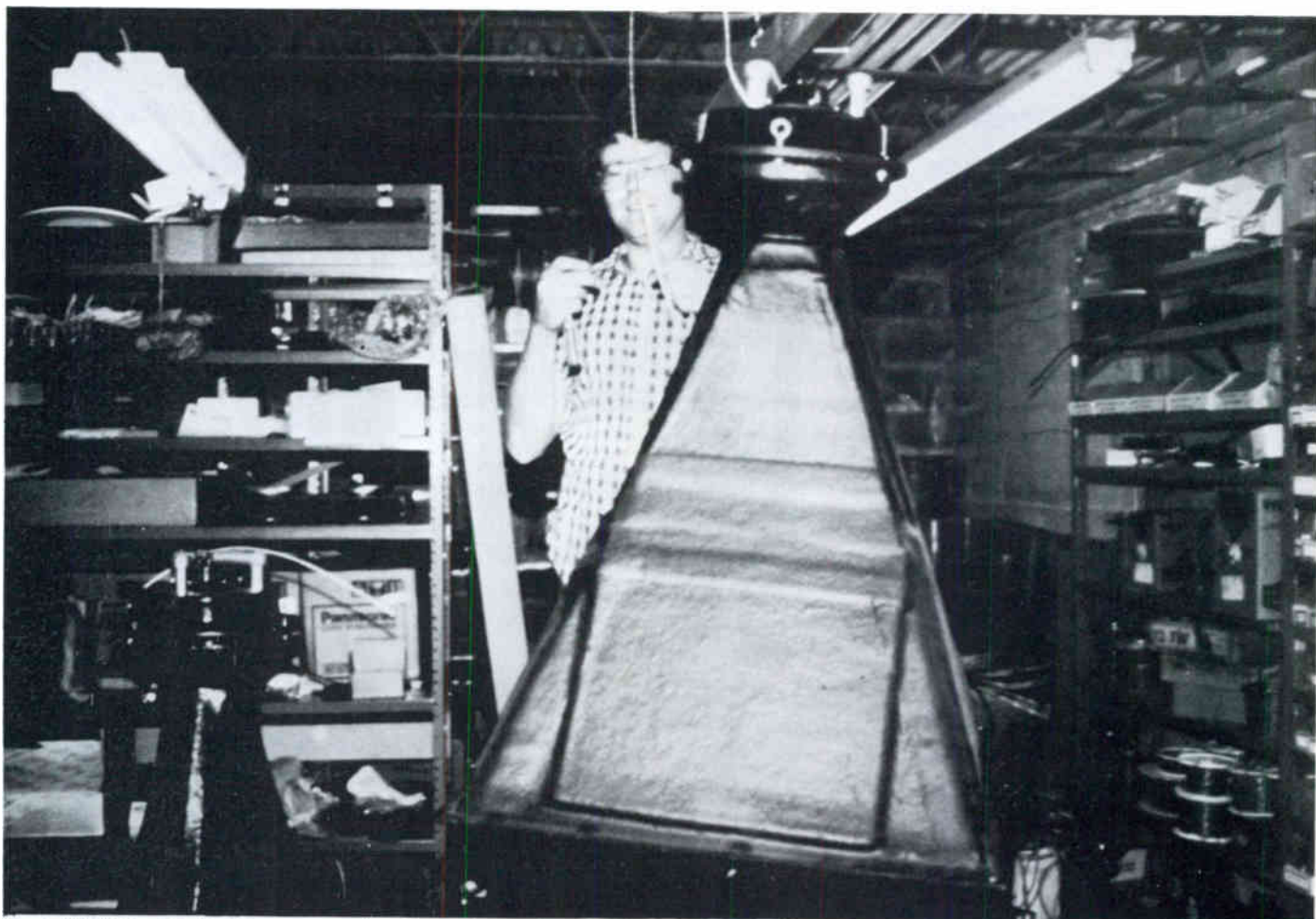

Kevin Pahl, lead technician, preparing the main speaker clusters to be hoisted up to the catwalk, where they were then reassembled.

The Ordway sound system is one of the most elaborate in the upper midwest, and the largest system of its kind ever installed by a Minnesota-based contractor. The architects were Benjamin Thompson & Associates.

The sound system, which cost nearly a half million dollars, was designed to complement the acoustics of the Theatre and is used whenever a performance requires additional reinforcement or sound effects.

Some Background

Although the architecture reflects that of an earlier century, construction on the Ordway was actually completed late last year.

"We didn't finalize the product list and sign the contract until August 22," Bruce Olsen, head of engineering at AVC, said. "And the first performance was scheduled for December 12."

Considering the amount of equipment which had to be installed, there wasn't much time.

Including the small theater system, the monitor/page system, and the portable sound equipment, there are more than 500 JBL loudspeakers in the Ordway sound system. The loudspeakers

are powered by the new JBL 62/30 and 62/60 professional amplifiers. Altogether, the 56 amplifiers installed deliver 30,000 watts of audio signal. This is one of the first installations of these new amplifiers anywhere in the world.

Three clusters serve the main house of the Ordway. At the heart of the clusters are Community Light & Sound M4 drivers. Each of the central clusters covers the entire audience area.

Inputs to the main house system are controlled from a 24-channel AudioArts custom mixing console. "What makes the console 'custom,'" Jim Gundlach, senior consultant for sound system design at Kirkegaard, said, "is that the sound can be channeled back and forth through the three clusters—to what essentially becomes a 'three channel discrete pan system.'"

"As far as I know, no other cluster in the country has the same capability."

"The mix position is in the center of the main floor of the house. This allows the mixer to hear what the audience hears and therefore enables him to do a better job of mixing."

According to Gundlach, it was difficult

to integrate the mix position in the architecture.

"We worked closely with the theater consultant and architects in developing seating that could be moved out and have mix sound equipment moved in."

Multiple Clark-Teknik digital delays, Rane crossovers in the main house, and Brooke Siren Systems in the small theater, and White Instruments' equalizers, which adjusted by AVC Systems, serve the main loudspeakers. "A line radiator of five inch drivers run across the lip of the stage," Gundlach said. "The function of the line radiator is to lower the apparent sound source. This allows the first few rows in the house to hear the sound as if it were coming from the stage and not from up above." There are also eight portable mahogany cabinets housing special signal processing equipment; the kind of toys that would delight the hearts of many recording studio engineers.

Few Problems

During the actual installation there were a few problems to be solved.

(continued on page 42)

Off-The-Shelf Communication System Experts



Series 3100. Modular components allow flexibility in system design for permanent installation.



Series 3200. A flexible system — fixed, portable or semi-fixed.



Series 3400. Portable, self-contained. Comes ready to connect and operate.

For over 25 years, David Clark Company has been designing communication systems to meet the needs of NASA — Industry — Theatres — Civic Centers. Let our engineers assist you with one of our off-the-shelf systems or a custom designed system to meet your specific needs.

Our Noise-Attenuating Headsets provide hearing protection while making it easy to communicate in High Noise areas.

"the quiet people"

David Clark COMPANY
INCORPORATED

370 Franklin St., Worcester, MA 01604 (617) 756-6216

Western Regional Office — Los Angeles, CA (213) 776-4571

Distributed in Canada by Levitt Safety Ltd.

Distributed in Australia by Sureguard Safety PTY. LTD.

TOA Defines "Quality"

It's not easy to do. But after 50 years of successfully dealing with concepts like system flexibility — reliability — power — and sophistication, we wound up with a proven track record of **quality**.

Our 900 Series of commercial sound and background music systems offer overload and short circuit protection. They incorporate a range of features that allow quick, clean, flexible installation and years of maintenance-free operation. TOA takes for granted the fundamentals of "good merchandise." That's because ours is **quality** merchandise.

Accordingly, TOA provides everything you need. Eight different Powered Mixers and Power Amps. 22 input modules with so many connector configurations, you can select from **46** module choices. Power Amps that double as integrated amplifiers. Choose your wattage — anywhere from 10 watts to 240 watts RMS. Choose your inputs — 2? 4? 6? Choose your outputs — transformer-coupled and balanced, or transformerless-direct? XLR or RCA, phone jack or terminal strip?

We give you tone signal generators. Mic Pre-Amps Mixer Pre-Amps with bass and treble EQ controls. A dozen features that make your job faster, easier, and more profitable. Features that will acquaint your customer with quality.

You Get What You Pay For

When purchasing the quality of TOA's 900 Series, your customer acquires the very best commercial sound system that money can buy.

So what does the customer get when paying for quality? Not just flexibility and outstanding specifications (0.1% THD, signal-to-noise of 108dB at max gain, 20-20kHz frequency response), but characteristics that cannot be measured in numbers: warmth, clarity, transparency, and definition.

You need more than specifications to define **quality**.
You need TOA.

© 1984
TOA Electronics, Inc.



TOA Electronics, Inc., 480 Carlton Court, South San Francisco, California 94080 (415) 588-2538
In Canada TOA Electronics, Inc., 10712-181 Street, Edmonton, Alberta T5S 1K8 (403) 489-5511

Reader Service #257
World Radio History

Not just another microphone.

Independent testing proves the TE10 is better!

Recently, Telex engaged Dr. Eugene Patronis, Jr., professor of Physics, Georgia Institute of Technology, to test the TE10 condenser microphone against the Electro Voice BK-1, Audio Technica ATM31R and the Shure SM87. Tests were conducted with complete objectivity without the presence of any Telex personnel. It is of further interest that the competitors' microphones were purchased randomly "off the shelf", and all had Pro Net prices that were considerably higher than the Telex TE10.

Telex ranks superior

Dr. Patronis tested the mikes by a wide variety of performance criteria and, overall, Telex ranked as a superior value. Telex fared especially well in the areas of **linearity, distortion and frequency response**. Here, Telex was either first or second in terms of performance. Put the TE10 to your own tests and you'll agree—this is a superior condenser microphone at an exceptional price.

A mike with studio precision—built to take road abuse

Even though the TE10 has all of the precision and sensitivity of expensive and fragile studio mikes, it's as rugged as they come. The condenser element resists temperature and humidity extremes and is protected from handling abuse by the exclusive Tri-Flex™ shock isolation system.

If you would like to learn more about the TE10, call or write to: Telex Communications, Inc., 9600 Aldrich Ave. So., Minneapolis, MN 55420.

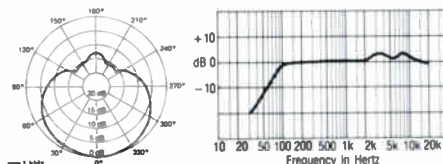

For quick information, call Toll Free

800-328-3771

or in Minnesota call (612) 887-5550.

TELEX®

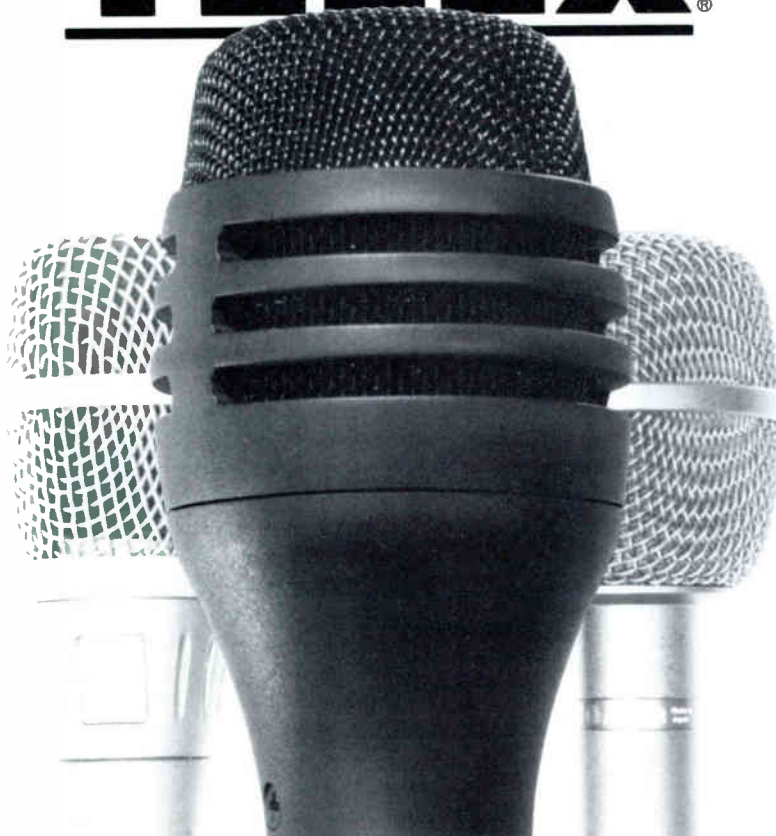

Reader Service #258

Installation Profile:

(continued from page 40)

"The architects moved the proscenium wall which in turn changed the design of the loudspeaker cluster," Olsen said. Because of the tight fit of the main speakers in their mounting locations under the catwalk, the speaker clusters had to be assembled in the shop, disassembled, individually hoisted to the catwalk, then reassembled. Some of the larger speakers had to be "trimmed" to fit in the allotted space.

In addition, Olsen added, "the AC wasn't turn on until a few days before the first performance."

Since Olsen was also asked to equalize the system, he said he only had four days "to turn it on, troubleshoot it equalize it, and test it." After the first performance, he did go back and made some adjustments.

"It was a complex system for one person to do. Particularly matching levels and maintaining same frequency and response with the clusters that were 30 feet away from some seats and 200 feet away from others.

"Since the Ordway is a multipurpose facility, we needed a signal to noise ratio to handle a wide range of levels varying from below NC 20 up to 105 dB SPL. We ended up with a 75 to 80 dB overall signal to noise ratio from mic input to speaker output," Olsen said.

"With speakers in a close area at various distances we also had a problem of maintaining the same level of arrival time. What we had to do is achieve proper level setting and proper setting of the delay. Clark Teknik delays were used in certain portions of the horns to make up the difference."

SUBSCRIBE TO *SOUND &* COMMUNICATIONS

Keep abreast of this
changing business

Every Month.

**It's Not Just
A Magazine,
It's An Industry!**

Sound & Communications

Why you should buy your next commercial sound system from the company people are listening to. Panasonic®

Before you spend thousands of dollars on a commercial sound system, make sure the one you specify can do everything Panasonic can. Whether you choose the economical 15- or 30-watt four-input amplifiers (Models WA-300P and WA-320P) or one of our deluxe five-input amplifiers (Models WA-740P and WA-750P) with up to 120 watts, Panasonic quality is heard loud and clear.



All our amplifiers offer a balanced auxiliary input for telephone paging. With additional input jacks for microphone, turntable and tape deck. Plus 25V, 70V and speaker outputs.

With our deluxe amplifiers you'll also get a built-in voice-activated priority circuit. It automatically reduces the background music level for announcements. Then gradually returns the level to normal after the announcement is completed.

A two-tone chime signals an announcement at the beginning and end of a work day.

If your specifications call for background music in lobbies, elevators or while a call is on hold, specify our series of deluxe amplifiers with an AM/FM

tuner (Models WA-735P, WA-745P and WA-755P). That way you can put the music where you want it.

But no matter which series you specify, all Panasonic Commercial Sound Systems look as good as they sound. Their compact design is eye appealing. And the deluxe models are also ideal for rack mounting.

So why buy just any commercial sound system, when you can buy Panasonic



quality, dependability and innovative excellence?

For more information on Panasonic Commercial Sound Systems, contact: Commercial Sound Systems Dept., Audio-Video Systems Group, Panasonic Industrial Company, One Panasonic Way, Secaucus, NJ 07094, or call (201) 392-4659.



Panasonic Industrial Company



SIMULTANEOUS INTERPRETATION

L'INTERPRÉTATION SIMULTANÉE

LA INTERPRETAZIONE SIMULTANEA

by **Jim Wood**
Edcom Inc.
(Formerly T.C.E. Electronics)

The rapid proliferation of international political, cultural and economic organizations has ushered in a unique new field of expertise within the audio industry and with it new opportunities for expansion for the astute sound contractor. Simultaneous interpretation facilities are now a prerequisite for any conference center, public or private, seriously courting international gatherings.

As man has progressed from clicks, grunts, and sign language to intelligible speech we have developed a need for translators. The increasing complexity of world political and economic management has necessitated the refinement of that age-old occupation within a rigid set of protocols backed up by the finest equipment the audio industry has to offer.

Although we are exposed daily to the use of interpretation services via the media, few among us have had the opportunity to gain a "behind the scenes" glimpse of these complex systems in operation.

Simultaneous interpretation—or SIT systems as they are commonly called—can vary from a simple micro-

phone input accommodating one translator in the sound room of a theater to very large multi-lingual installations such as the U.N. Seabed Authority in Kingston, Jamaica which can provide services to thousands of delegates.

When designing a SIT system, particular attention must be paid to the type of equipment suitable for a specific installation and to the rigid protocols laid down with regard to the operational characteristics of the system and the working environment of the interpreters.

Simultaneous translation is an arduous profession. The interpreter is often called upon to translate not merely from one language to another, but from one of several to a third language. Consequently, strict standards have been developed. The most widely accepted is the International Standards Organization guidelines which spells out not only the type and quality of equipment which must be provided for the interpreters' use, but also the physical parameters down to the finest detail of the enclosures within which they must work, with regard to fixed and portable booths.



The Jamaica Conference Centre, the interim headquarters for the U.N.'s International Seabed Authority.

Included are such requirements as acoustical insulation, temperature, workspace, view of the proceedings, and a myriad of other features which must be incorporated into the booth construction to permit the interpreter to successfully perform his task. The system designer must be thoroughly familiar with these requirements as failure to comply, will result in the interpreter; refusal to use the facility. There are multi-million dollar installations which have never been used for this very reason.

Three stages comprise a conference simultaneous interpretation system: the input stage, which can consist of delegate operated or centrally controlled microphone units and associated control equipment; the processing or translation stage; and the output stage

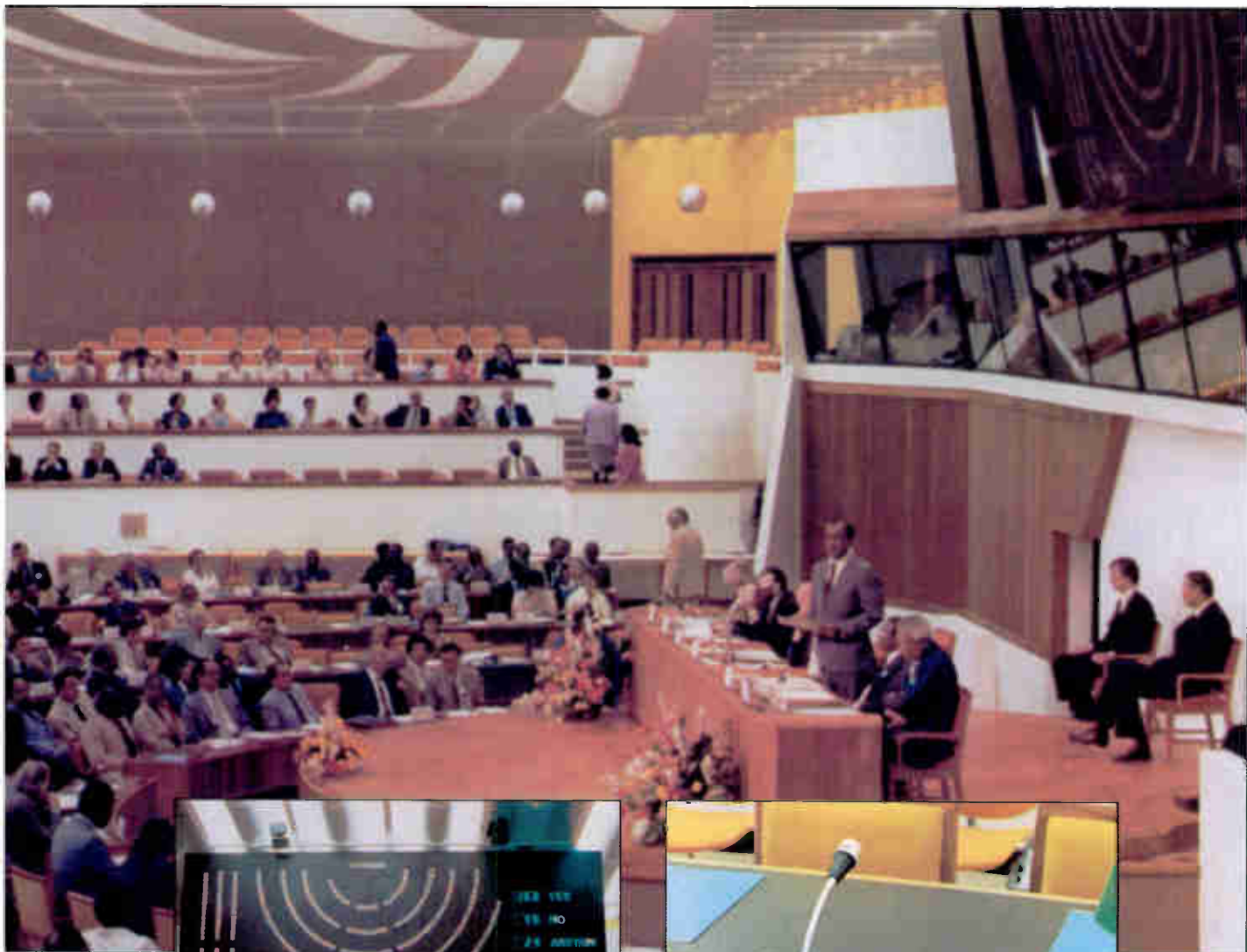

Geographical voting display panel.



Built-in dual mic unit.

whereby the translated material is distributed to the conference participants.

One system recently developed by Auditel Systems Limited consists of delegate-operated microphone units over which the chairman has priority control. It will accommodate up to 100 delegates with independent inputs for the chairman and a floor microphone. The system is capable of three modes of operation. Microphones may be switched on and off manually or can be self-cancelling, whereby open mix units will automatically switch off in the absence of audio after a pre-set adjustable hold time. The system is also capable of full VOX operation.

Access by delegates may be unrestricted or on an exclusive basis whereby only one delegate unit may be active at a time. The chairman can

control the conference by exercising momentary priority or by disabling all delegate mic units with the switch.

With this type of system, parliamentary procedure must be adhered to with the chairman acknowledging requests to speak by show of hands. When used as the input to a SIT system this type of system will invariably be used in the exclusive mode to prevent interruption of the translation procedures.

Another type of system commonly used in large conference facilities is the centrally controlled system. These may handle as few as 20 or as many as one thousand delegates. Smaller systems usually incorporate a compact control desk with illuminated switches for the microphone locations. The mic units are usually equipped with a RE-

QUEST TO SPEAK switch which annunciates the request at the control desk. The delegate's unit is then activated by the console operator at the discretion of the chairman. In larger systems, the operator's console panel may be laid out in "mimic" fashion to assist the operator in geographically locating the delegate.

Design flexibility is paramount in order to satisfy the user. For example, a system installed in the Massachusetts Legislature for over 175 legislators still uses the show of hands method of floor requests in keeping with the oral traditions of the legislature. The microphone units, brass fittings and all, are controlled by the operator located in a well behind the speaker's dais so as to be as inobtrusive as possible.

In very large systems, it is not uncommon to use computer control over the microphones. Requests are queued up, stored and displayed on a CRT located at the console in the order in which they occur with provision for the automatic recall of previous and pre-programming of frequent speakers.

In a permanently sitting congress, the delegates are normally assigned specific seating and the microphones are designated by the names of the delegates. In other than permanent situations, however, it is necessary to

program the delegate information into the computer prior to the commencement of the conference. A new system developed by Auditel provides for card access to identify the delegate and enter his appropriate seating information. This allows the programming to be done in advance while still permitting changes or additions at the time of registration. It also allows the delegates to change seats at will since inserting the card at the new position automatically updates the data pertinent to the seat.

The cabling used in the aforementioned

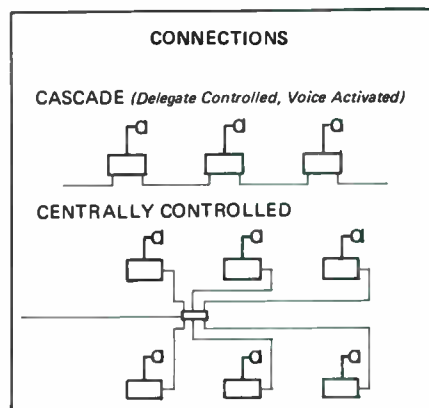

systems is simplified compared to the traditional method of home-running microphones to mixers and then to the distribution system. In the delegate operated system, each delegate unit incorporates its own amplifier as well as VOX and limiting circuitry and solid state switching circuits. AGC is provided by a self-contained power supply and audio control unit. Delegate units are daisy-chained from the audio control unit using multi-conductor shielded cable. Digital information is fed along a control cable to control priority circuits, VOX sensitivity and hold time. In addition, paths are provided to select the mode of operation and power the units. Centrally controlled systems utilize junction boxes connecting up to ten microphones via a single cable to the control desk.

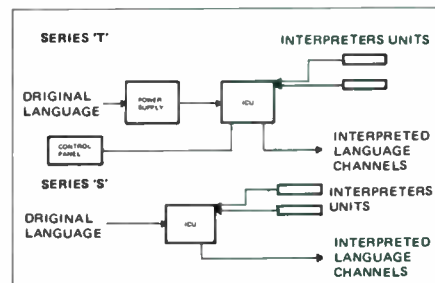

Finally, the delegate units, which may be portable or permanently fixed, may incorporate built-in loudspeakers which are automatically muted when the delegate is speaking. Alternatively, the output from the audio control unit may be fed to external sound reinforcement equipment. It is not uncommon to combine both methods when it is desired to pipe the proceedings to observation galleries and external broadcast, tape, or teleconference feeds.

Having selected the system input

The Wireless Intercom System designed for your specific needs

The Cetec Vega Q System fulfills the demanding applications of motion picture, broadcasting and stage production communications. Sound and camera crew cuing, stunt coordination, sound program monitoring, etc. can be achieved easily without running cables.

Features

- Can interface with wired intercom systems such as RTS, Clear-Com, David Clark, four wire, etc.
- Operates simplex or duplex with up to 6 walking units plus 1 plug-in unit (at the base station, which can include a wired-intercom interface).
- Operates in the VHF high band, 150 to 216 MHz, for minimal interference.
- Usable with commonly available headsets (electret or magnetic).



 **Cetec Vega**

Division of Cetec Corporation
P.O. Box 5348/El Monte, CA 91731/(213) 442-0782/TWX 910-587-3539
In Canada: A. C. Simmonds & Sons Ltd.

Reader Service #261

stage best suited to the user's requirements, we move on to the processing or actual interpretation stage of the SIT system.

There are three primary components in this portion of the system; the interpreter's console, an interpretation control (operating) unit and a services control panel, plus microphones and headsets.

The interpretation control unit is a central unit which automatically routes the floor language to unoccupied channels so that a delegate need not change the channel or remove his headset when the floor is his language. It controls the output channels as set up by the operator and blocks engaged channels to prevent interference. The channel routing is set by rotary switches and LED indicators identify the channel engaged by each booth.

The final component in the processing stage of the SIT system is the interpreters' services panel. This may be built into the central console desk or mounted separately if convenient. It contains all of the facilities required for control of the interpretation system including a VU meter and level control for the floor and each language

channel, service channel/intercom controls and monitoring facilities, both by means of a headset or built-in loudspeaker.

The final stage in the system is the output or signal distribution stage which sends the numerous language translations to the delegates.

Currently there are three methods in use to achieve this. A multi-cable hardwired cable distribution system utilizing channel selector panels mounted in the arm or adjacent to the delegates' seats offers the best audio fidelity and consequently the least listener fatigue during lengthy conferences. These are equipped with a headset socket, volume control and selector knob for up to twelve channels. Signal distribution is by 50 volt line with cable requirements determined by the number of channels to be provided. This, incidentally, is the best form of distribution with regard to both security and long-term reliability, as the channel selectors are passive devices and it is suitable for permanent installations with fixed seating.

The second common method of signal distribution incorporates a multi-channel FM induction loop transmit-

ter together with battery-powered pocket receivers equipped with lightweight headsets. The use of FM greatly diminishes the amount of power required to drive the induction loop while achieving a high degree of audio quality and freedom from interference. Since FM receivers normally operate in the "limiting" condition, reception is practically independent of position within the room. Moreover, receivers are available which are designed to switch off automatically in the absence of the magnetic field, conserving battery power and eliminating the need for daily checks of the receivers' condition during conferences.

The mainframe which houses the transmitter is capable of accepting up to eight channel-modulation cards providing crystal-controlled accuracy in the realm of 0.02 percent. Frequency response is 180 Hz to 4 kHz, voice frequency bandwidth, and inter-channel crosstalk is better than 145 dB.

Large systems generally require at least two interpreters per booth and in some cases, as many as four or five. Hence, the clearly defined work space requirements in the relevant ISO

(continued on page 73)

SOUNDSPHERES SAVE CHURCH \$10,000 !

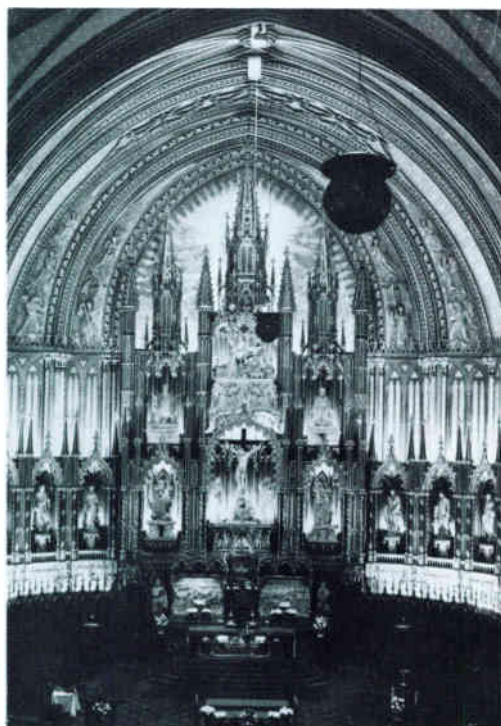

Notre Dame Basilica, Montreal, Canada

Jean-Paul Psaila, designer of the Notre Dame Basilica Sound System, remarks about the installation...

“Due to a successful demonstration and the fact that our proposed system was \$10,000 less than the competitor's system, the church accepted our proposal. In addition, the priest liked the fact that our system, using the Soundspheres, did not interfere with the fine architecture in the church. Our installation took 30 hours total using two installers (60 man-hours).

The first major use of the system was during the Pope's visit. The church was filled to capacity with 5000 children and the Pope's security people were quoted as saying that this was the only church where they could understand all that the Pope said.

The priest, Monsignor Lecavalier, has nothing but praise for the system and calls the Soundspheres his "religious satellites." During Christmas Midnight Mass the church accommodated over 4000 people

and there were no complaints except that some people very near the main entrance could not hear well. To this the Monsignor replied that there were vacant seats where the sound was perfect.”

Measurements with 2 Soundspheres Operating

0'	96.6 dB SPL (Under the Sound-sphere closest to the altar)
10'	98 dB SPL
20'	97.6 dB SPL
30'	96.8 dB SPL
40'	96.7 dB SPL
50'	96.8 dB SPL
60'	97 dB SPL
70'	99.4 dB SPL
80'	100 dB SPL
90'	97 dB SPL
100'	95 dB SPL (under first balcony)
110'	96 dB SPL
120'	93.5 dB SPL
130'	93 dB SPL

*Sound and Communications, Feb. 1985

Write or call direct for further information.

SOUNDSPHERE

A PRODUCT OF
SONIC SYSTEMS, INC.

737 CANAL STREET • BLDG. 23B • STAMFORD, CT 06902 • USA • Tel. (203) 356-1136

Reader Service #262

PRODUCTS IN REVIEW

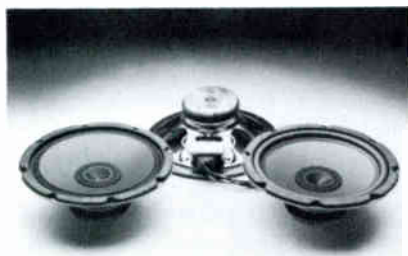

EIGHT-INCH AND 12-INCH COAXIAL LOUDSPEAKERS

Misco has introduced three new coaxial loudspeakers for high quality background and foreground music systems.

The JC80PA is an extended range eight-inch driver (10 ounce magnet) with treated paper edge. Tweeter to woofer coupling eliminates phase distortion, provides smooth midrange crossover and optimum off-axis dispersion. The JC80PA is rated for 30 watts (program) and has a frequency response of 45 Hz to 18 kHz with a sensitivity of 97 dB 1W/1M.

The JC80F eight inch coaxial contains these same features and also has a foam edge for extended bass response. It is rated at 30 watts (program) and has a frequency response of 35 Hz to 18 kHz with a sensitivity of 94 dB 1W/1M.

The LC120PA combines a 12 inch low frequency driver with a 3.5 inch high frequency dynamic tweeter. A unique phase-coupler and crossover network assures a smooth crossover. The low frequency driver features a 20 ounce magnet and a durable four layer voice coil for greater power handling and utilization of total magnetic energy. The LC120PA is rated at 24 watts RMS and has a frequency response of 35 Hz or 15 kHz with a sensitivity of 99 dB 1W/1M.

□ For further information, contact: Misco/Minneapolis Speaker Company, 3806 Grand Ave., Minneapolis, MN 55409; (612) 825-1010.

Reader Service #30

MICROVOICE ANNUNCIATOR WITH DIGITAL FORMAT

Microvoice has announced availability of its messages in digital format which can be retrieved or activated via computer, which can be contact, or

telephone interfaces.

Messages can be sequenced in up to 9,999 different combinations allowing comprehensive information dissemination under automatic, emergency or manual control. System applications include industrial and hazardous safety warning, operator training systems, simulators and preprogrammed information broadcasting via telephone, radio or paging systems.

□ For more information, contact: Microvoice Systems Corp., 23362 Peralta Dr., Suite 5, Laguna Hills, CA 92653; (714) 859-1091.

Reader Service #31



TANDBERG SEES USES FOR NEW AUDIO LOGGER

Tandberg's Peter Wellikoff is out to prove that audio logging recorders can serve a multitude of functions *outside* the broadcast studio.

The company is encouraging pro audio dealers and equipment users to explore the virtually limitless applications of the new TD20A-L series. According to Wellikoff, "There are markets for audio loggers that dealers haven't even explored. Besides the radio stations, how about taxi companies that must log all their dispatches, state or city police, courts, or even the city morgue? For the price and the sound quality there is simply no product that can come close to the TD 20A-L."

Tandberg's direct A/B comparisons between an FM source and the TD 20A-L audio logger provide FM quality audio, despite the fact that it is tracking at only 15/16 ips.

The company claims that at slow speed the TD 20A-L and the sound-activated version, the TD 20A-SA, are

both conservatively speced with a signal-to-noise ratio of 66 dB, a wow and flutter of just 0.20 percent, and a frequency response of between 80-80,000 Hz (+/-3 dB). Meanwhile, the recorder can provide over 51 hours of uninterrupted recording on a single 10½-reel of tape.

The TD 20A-L is list priced at \$1,995, while TD 20S-A is list priced at \$2,195. A four track version of the machine will soon be available for about \$2,495.

□ Contact: Tandberg of America, Labriola Court, P.O. Box 58, Armonk, NY 10504; (914) 273-9150.

Reader Service #32

JERON OFFERS NEW HP-570 TELEPHONE ENTRY SYSTEM

Jeron Electronic Systems, Inc. has introduced the HP-570 Telephone Entry System. The system is available with armored cable handset and metal button keypad designed to resist vandalism and weather, or in an economy model with a coilcord handset and plastic button keypad for indoor use. Construction is of heavy gauge aluminum, modular panels supported in a continuous frame.

Jeron HP-570 Telephone Entry Systems feature special hinge-mount of panels for installation-access to microprocessor control.

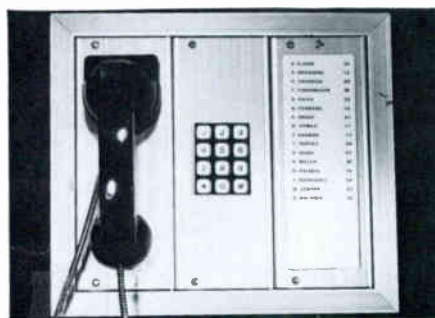

HP-570 Systems are available in four memory capacity sizes—for 50, 160, 400, or 1,000 apartment units. All systems may be ordered with or without self-contained directories. Operation is with U.L. Listed power supply, utilizing existing lines.

□ For further information, contact: Jeron, 3554 N. Clark St., Chicago, IL 60657; (312) 528-4020.

Reader Service #33

(continued on page 50)

PRODUCTS IN REVIEW

a closer look

by gary d. davis

Eddor's Great Little Mixer

Eddor has introduced the GLM (great little mixer) which features full cut and boost tone controls, voice gating, precedence control manual muting, multiple microphone inputs, and an economical price.

The GLM occupies 1¾ inches of rack space and can be rack mounted with an auxiliary rack mount kit. The microphone inputs are low impedance (balanced) or high impedance (unbalanced).

According to the company, the product was designed specially for the sound contractor market.

Comment: Mazda sells their GLC (Great Little Car) and Eddor has their GLA (Great Little Amplifier). And now they've introduced the GLM (Great Little Mixer).

The GLM accommodates three mic inputs plus an auxiliary line input. The number three mic input includes some additional circuitry which provides for voice gating action, and which can be set to take precedence over the line input. When set for precedence, any signal at the mic input will not only open the mic gate, but will also mute (override) the line input, for example, to page over background music. A pair of rear-panel switches permit the number three input to be set to the precedence function, to simple gating action (where the voice gated mic is mixed with the aux input), or to "normal" operation with no gating and no precedence.



A pair of rear-panel terminals allow for manual muting, whereby an external switch will mute the program input, and any of the three mic inputs may then be used.

There are separate high-Z unbalanced phone jack and low-Z electronically balanced XLR inputs for each of the three mic channels. The aux input is an unbalanced phone jack, as is the line output. There is also an RCA jack tape output. Performance

specifications claim under 0.1 percent THD and ± 1 dB frequency response from 20 Hz to 20 kHz, with 85 dB of CMRR at 120 Hz. Output hum and noise is speced at "greater than 50 dBm" with all controls at maximum CW position; we assume they mean less than -50 dBm output level. Similarly, "greater than 88 dBm" with all controls at minimum position.

The GLM was conceived as a control head for the GLA (or other brand) power amplifiers. With the individual level controls for the three mic and one aux line input, plus bass and treble tone controls, the GLM provides the basic mixing functions available elsewhere. Add the gated mic, precedence over line input, and manual mute of line input capability, and you have a pretty nice package for a suggested user price of under \$250.

□ Contact: Eddor, 16782 Hale Ave., Irvine, CA 92714.

Reader Service #34

Multi Channel Main Station

Clear-Com has announced its new MS-808 main/remote station. Designed specifically for aerospace, industrial, and broadcast teleproduction, the MS-808 provides up to eight intercom channels, and up to eight IFB channels, or can be configured for a point-to-point communications system with nine stations.

Featuring a modular system design, the MS-808 uses one to four plug-in "Control Modules." Each module enables the operator to program, monitor, and control four discrete intercom channels (CH-4 Module) or to access four discrete IFB channels (IFB-4 Module).

The MS-808 mainframe provides for up to 16 communication channels (eight intercom plus eight IFB) plus a dedicated line. It contains a two-amp power supply to support a system containing up to 100 standard Clear-Com remote stations and/or systems components.

Comment: The MS-808 is a rack-mount unit that includes a power supply, a gooseneck mic, headphone jack, local controls, a speaker panel, an in-



ternal switch assignment matrix, and space for one or two control modules. One or two four-channel intercom modules, or four-channel IFB (Interruptible Foldback) modules can be installed in the slots, providing up to eight intercom or eight IFB channels. If more channels are needed, the speaker can be removed, making room for two more modules. Only two of a given type module can be used, though, so the standard system will provide up to eight intercom and eight IFB channels.

IFB is a means to pipe a line-level program signal, which may be a monitor (foldback) or cue signal, to the various intercom stations that are part of the IFB system. When a specific communication is needed, and the station operator selects the talk mode, the operator's voice overrides the IFB program signal. While one or two control modules for talking to the IFB channels fit in the MS-808 mainframe, the actual controller circuitry to accomplish the IFB function does not. It is located in one or two separate rack-mount chassis (one PIC-4 IFB controller per each four IFB channels).

Each of the up to eight intercom channels serves as a party line, as does each of the eight IFB channels. A total of up to 100 intercom stations can be powered by one MS-808. There are situations, particularly in industrial applications, where the party-line concept is not as desirable as a private line. The MS-808 has "dedicated line" capability. If the internal matrix is so arranged, up to nine MS-808 units can be wired together, each fitted with two intercom modules, thereby allowing for direct, private communication with eight different parties from each of the nine stations.

□ Contact: Peter Giddings, Clear-Com Export Division, P.O. Box 302, Walnut Creek, CA 94596; (415) 932-8134.

Reader Service #35

(continued from page 48)



NEW DISTRIBUTION AMPLIFIER FROM SHURE

Shure Brothers Inc. has announced the addition to its line of professional field production (FP) products. The FP16 is said to be a 1-input, 6-output, compact, self-contained audio distribution amplifier for routing multiple audio feeds without sacrificing signal integrity or clarity.

Applications include radio and television broadcasts, ENG vans, press conferences, recording studios, and telecommunication and production facilities.

The FP16 is a compact, lightweight unit designed for on-location broadcasts such as press conferences where

multiple network hookups are required, but can also be permanently rack-mounted (with an accessory rack mount kit) in broadcast studios or ENG vans, or in recording studios for audio distribution. Its wide-range frequency response (30 to 20,000 Hz), up to 90 dB gain, extremely low noise (input: -129 dBV into 600-ohm load at full gain; output: -70 dBV at full on), and isolated outputs for signal handling make the FP16 suitable for any professional distribution application.

The FP16 features separate, front-panel gain controls on the input, as well as on each output channel. Each gain control is recessed and screwdriver-adjustable to eliminate tampering and unintentional level changes. Three LEDs indicate system status on the FP16's front panel: green indicates power-on; yellow, normal signal flow; red, overload.

User net price for the FP16 is \$350.

□ For further information, contact: Shure Brothers Inc., Customer Services Department, 222 Hartrey Ave.,

Evanston, IL 60204; (312) 866-2573.

Reader Service #36

FIRE ALARM CONTROL PANEL FOR MULTI-ZONES

The new multi-zone fire alarm control panel from Kidde is a self-contained, expandable, fire alarm system with a basic capability of monitoring two Class B input detection zones. Addition of optional snap-in dual zone boards can expand the system to eight zones.

The circuits are field selectable for Class A operation by inserting optional plug-in relays into the sockets provided on the motherboard and dual zone boards. The KAS-200 is designed to meet National Fire Protection Association Standard 72A and the cabinet can be either surfaced or flush mounted.

□ For further information, contact Samuel G. Shirley, Kidde Automated Systems, Inc., (216) 871-9900.

Reader Service #56



Williams Sound . . . the new standard in wireless microphones.

You told us you wanted a wireless microphone that worked. A hassle-free system that solved the problems of interference and drop-outs. We listened. **The result:** A programmable, diversity system, with top audio quality, for only \$895.00 Suggested Resale!

Compare these features with any wireless mic available. Then compare the price.

- **FULLY PROGRAMMABLE, HI-BAND SYSTEM**

Select any of eight operating frequencies on the 169-171 MHz band, easily and instantly! Digital Frequency Synthesis eliminates costly delays for crystal changes.

- **TRUE DIVERSITY RECEIVER**

Two complete RF sections and separate antennas provide maximum reliability, noiseless diversity switching, and freedom from "drop-outs."

- **COMPANDER DYNAMIC NOISE REDUCTION**

Compander circuitry provides noise-free operation, 90 dB of dynamic range, and excellent audio quality.

- **WILLIAMS SOUND QUALITY AND RELIABILITY**

You expect quality, we insist on it. Everything we build is backed by our TWO-YEAR WARRANTY, your assurance of satisfaction.

For more information about our affordable state-of-the-art wireless microphone, contact your local Williams Sound Rep or call:

Williams Sound Corp. Eden Prairie, MN 55344-9984
800-328-6190

Williams Wireless

4 ways to beat the system.

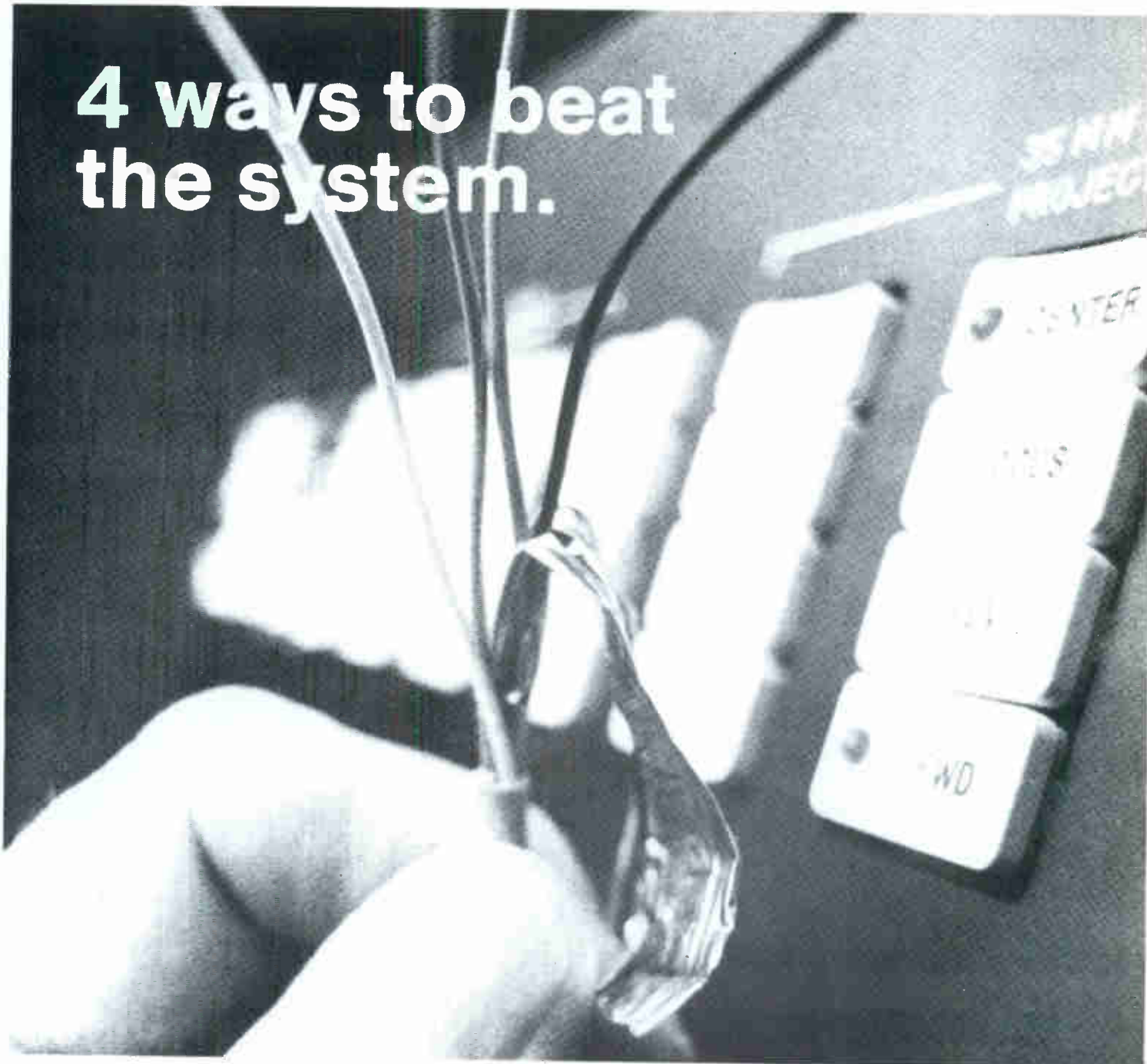

Simple: Just four wires do it all! FSR has removed the cost and error from A/V installations with its DL-64 control which reduces the number of signal wires needed from hundreds down to only four. Simple to install, no new training required.

Sophisticated: Up to 64 controllable functions with lamp feedback

can be handled by the DL-64. It is the first digital system designed exclusively for conference rooms and board rooms. Panels are small and sleek with new, modern key switches and LED lamps.

The DL-64 is a system that everyone—from the chairman of the board to the installer—can finally feel comfortable with.

The right spec: When you specify FSR's DL-64 control, you add both simplicity and sophistication to your A/V control systems.

The DL-64 system can interface with any control system although it was designed especially to work with FSR's back-of-the-rack modules.

FSR inc.

Installer-friendly control modules

40 COMMERCE ROAD CEDAR GROVE NJ 07009 (201) 783-3966

Reader Service #264
World Radio History



RLA INTRODUCES X3000A ELECTRONIC CROSSOVER

RLA's new X3000A active crossover is a special purpose electronic crossover designed for the recorded music playback club or lounge and is meant to be operated by a live disc jockey.

Functionally, the Model X3000A is

a two channel three way electronic crossover. There is a sub-bass output with a bandwidth of 30 Hz to 100 Hz; a full output with a bandwidth of 30 Hz to 65 kHz; and a tweeter output with a bandwidth of 7 kHz to 65 kHz. The sub-bass and tweeter outputs have front panel mounted level controls allowing 16 dB of boost or cut, while the full output has a front panel mounted level control allowing 6 dB of boost or 40 dB of cut. The input signal is thus divided into a buffered and sub-

sonic filtered full spectrum output that is available to feed the main system crossover, as well as two special purpose low and high end drive signals that can be used to feed additional power amplifiers connected to sub-bass bins and tweeter arrays.

With additional channels installed in the club, the music operator now has real time control over the deep bass and high frequencies.

The signal rack space X3000A has a suggested retail price of \$550.

□ For further information, contact: RLA International Ltd. 38-11 29th St., Long Island City, NY 11101; (718) 706-0766.

Reader Service #37

Performance you'll appreciate, sight unseen.

Astatic's 827 electret condenser microphone offers a low profile while providing high quality sound reproduction. These ultra thin 13" or 17" gooseneck mics stay well hidden; ideal for applications where close miking is required to produce additional system gain.

Among the "out-of-sight" features of the 827 are:

- controlled low frequency roll-off
- cardioid pattern
- permanently charged diaphragm
- built-in circuitry for phantom power
- high impact construction
- long lasting black finish
- miniature windscreen provided
- TWO YEAR WARRANTY

Not seeing the 827 is believing! But you can hear the difference that Astatic makes in a microphone. Call or write for the name of your nearest dealer. Dealer inquiries welcome.

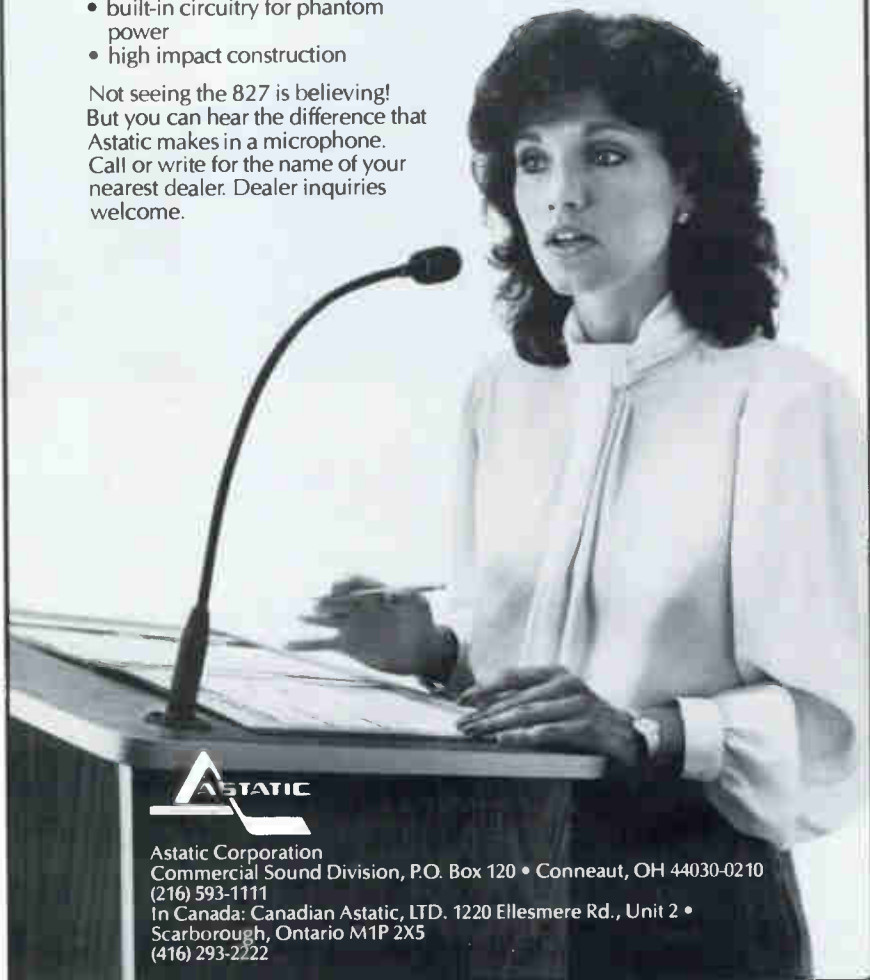

Astatic Corporation
Commercial Sound Division, P.O. Box 120 • Conneaut, OH 44030-0210
(216) 593-1111
In Canada: Canadian Astatic, LTD. 1220 Ellesmere Rd., Unit 2 •
Scarborough, Ontario M1P 2X5
(416) 293-2222



NEW HALLICRAFTERS 412 KEY TELEPHONE SYSTEM

Ma Best Telephone Products has announced the new Hallicrafters four line, twelve station key telephone system.

The system uses conventional looking six button telephones that contain all of the electronics needed for the system to function. No key service unit is required. A power supply is used to connect to telephones and to RJ11 or RJ14 jacks installed by the telephone company.

Twelve station intercom is included. Individual intercom station numbers are set on each telephone using small switches to set the number.

On the rear of each telephone is an RJ11 jack into which accessories, such as a dialer, speaker phone, and answering machine, may be connected.

Each telephone has an on/off ringer
(continued on page 54)

Reader Service #265

World Radio History

Sound & Communications

*Time-Master
keeps the music going in time
with the business.
Without changing tapes!*



We know busy people have better things to do than change tapes. And, because background music is critical to any business, we've developed our new Time-Master on-premise unit that sets the pace for business automatically. With pre-programmed, time-controlled, musical programs and announcements. □ Nothing could be easier or more reliable. Once programmed, the Time-Master turns itself on, runs continuously, changes tapes without time gaps, and shuts itself off at the end of the day. □ Operators can intermix relaxing background music with upbeat tempos; even program pre-re-

corded promotional announcements between musical tapes. Our unique endless loop tape cartridges allow playback of six different cartridges, each containing up to 10 hours of music, providing a total of 60 hours with no repeats. □ If your customers are busy business people, recommend Time-Master. The *only* background music system in the business that changes tapes *automatically!*

CPC-180
CUSTOMUSIC
SOUND SYSTEMS THAT STAND ALONE

To find out more, contact Customusic[®], Rowe International Inc., 75 Troy Hills Rd., Whippany, NJ 07981. 201-887-0400. □ Rowe International, Subsidiary of Triangle Industries, 75 Troy Hills Rd., Whippany, NJ 07981-3608. (201) 887-0400.

Reader Service #260

SOUND MASKING



Oaktron's ESP Sound Masking System is furnished completely assembled and factory wired as ordered including Teflon covered lead wire and optional suspension hanger.

HIGH TEMP

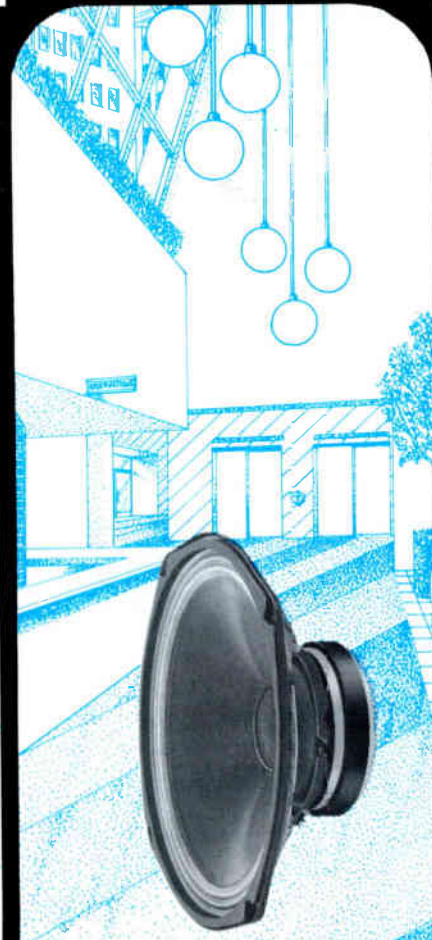

New state of the art technology allows speakers to withstand exposure to 400° ambient conditions

EXTENDED POWER



A new "off-set" driver system increases power handling and a smooth cross-over transition. 60 watt — 30 — 22,500 Hz performance makes this ideal for Foreground Speaker systems.

Intercom Speakers — Level Controls — Transformers — Hitemp Transformers — Top Hats with Plaster Ring — Ceiling Grilles — L-Pads — Wall Mounted Baffles — Ceiling Mounted Baffles.

Besides the wide variety of speakers designed for commercial sound installations, Oaktron has created special units to satisfy almost every need. 165 speaker designs are ready for off-the-shelf delivery. Why not phone today for our all new specification catalog.



YOUR BLUEPRINT TO BETTER SOUND

OAKTRON INDUSTRIES, INC.

1000 30th St., Monroe, WI 53566

1-800-356-3609 (in Wis. — 1-608-328-5560)

Reader Service #289

phone, the DAX 2800 will perform computer-controlled automatic equalization and quickly equalize your system to any memory setting. The DAX 2800 additionally possesses the ability of instantaneous automatic eq and RTA curve averaging of up to eight curves and can be weighted as much as 7:1. Sensitivity of Eq or RTA settings can be changed from 3 dB to 1 dB.

For the *sound contractor*, the DAX 2800 acts as the "master" computer to down-load into the DAX Eq POD any prescribed room equalization curve. The DAX Eq POD is a blank-panelled, third-octave equalizer for permanent sound system installations and cannot be adjusted by unauthorized personnel without the DAX 2800.

Future DAX 2800s will accept option modules for additional functions such as a printer for archiving data from the RTA section.

□ Contact: NEI, 934 N.E. 25th Ave., Portland, OR 97232; (503) 232-4445.

Reader Service #42



BLONDER-TONGUE'S NEW SAW FILTER A/V MODULATOR

Blonder-Tongue Laboratories, Inc. has announced the availability of its SAVM audio/video modulator with stereo compatibility. The SAVM is a SAW filtered heterodyne audio/video modulator used to put sound and color video on any unused channel of a CATV, MATV, or SMATV system. The unit provides a modulated visual and an aural RF carrier output on any single VHF, Midband, or Superband channel.

A heterodyne conversion system in the SAVM is designed to furnish proper vestigial sideband selectivity for adjacent channel color systems. The SAVM features field defeatable audio pre-emphasis, permitting transmission of BTSC standard composite stereo signals. The professional grade SAW filter provides flat group delay and maintenance-free bandpass character-

istics.

□ Contact: Blonder-Tongue, One Jake Brown Road, Old Bridge, NJ 08857; (201) 679-4000 ext. 297.

Reader Service #43



KOHLER INTRODUCES POWERPLAY 950 GENERATOR

Kohler's new PowerPlay 950 generator is said to offer the best power-to-weight ratio in its class. At

Matchless skill in equalisation

Klark-Teknik Research is setting a new standard for equaliser stability — and now the company's diverse experience of world markets has produced very different versions for very different needs, all using the same five-year warranted, state-of-the-art thick-film-engineered microcircuit filters.

Typical is the DN360 with thirty 1/3 octave filters to each channel for the most exacting applications, while the DN332, with sixteen 2/3 octave filters per channel, is a perfect match for many good modern sound systems — without outstretching most budgets.

Both are built to the same high standard with features such as electronically balanced inputs and subsonic filters as standard.

Frequency response $\pm 0.5\text{dB}$
20Hz-20kHz
Equivalent noise $< -90\text{dBm}$
Distortion $< 0.01\%$ THD @ 1kHz



KLARK TEKNIK



British designed, British made

"The reliability of MELT micro-electronic filters gains a 5-year solid-state parts warranty for all Series 300 equalisers."

For full colour brochure contact Klark-Teknik or your nearest distributor (list available on request).

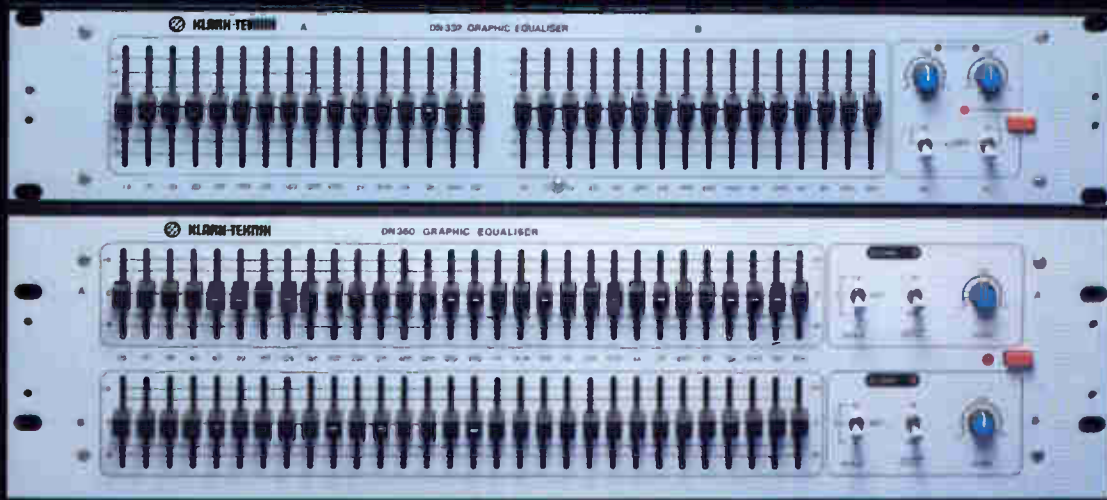

Manufactured by Klark-Teknik Research Limited
Coppice Trading Estate, Kidderminster DY11 7JJ,
England. Telephone: (0562) 741515 Telex: 339821

Klark-Teknik Electronics Inc.
262a Eastern Parkway, Farmingdale,
NY 11735, USA. Telephone: (516) 249-3660

Omnimedia Corporation Limited
9653 Cote de Liesse/Dorval, Quebec H9P 1A3,
Canada. Telephone: (514) 636 9971

WE'RE ALL TALK.

... BUT WE'RE NOT AFRAID TO LISTEN



IR-105 APARTMENT STATION

Thirty years of manufacturing intercom systems has taught us a very valuable lesson. That is, that no two systems are created equal. This means that the manufacturer must listen and be responsive to the customer's critical job requirements. How well they meet these requirements determines how professional a communications company really is.

Lee Dan listens, and responds, with custom made intercom systems for buildings from one unit to a thousand units designed to be integrated with many brands

of equipment. We're specialists in intercom and communication systems. Our design expertise enables us to utilize existing space limitations to the best possible advantage to meet your requirements (and your budget). We offer over thirty-five varieties of apartment stations and the technical assistance you need to make it work.

If your next job requires a communications system that's easy to use, easy to install and, above all, easy to afford, call or write us with your specs. When you're talking communications systems, Lee Dan is all ears.

WHY NOT GIVE US A CALL!

(516) 231-1414

(718) 886-3000

Reader Service #273

155 ADAMS AVENUE
HAUPPAUGE, N.Y. 11788
TELEX: 960020

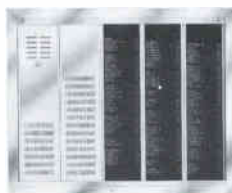

VAN GUARD LOBBY PANEL

51 pounds, the unit delivers 900 watts of continuous AC power. Battery-charging cables are provided for simultaneous DC output. The brushless generator is driven by a four-cycle 1.8 hp gasoline engine. Other Power-Play features include two 120 volt AC receptacles, fuel gauge, and low oil level warning lamp.

□ For further information, contact: Kohler Co., Kohler, WI 53044; (414) 457-4441.

Reader Service #44



WILCOM'S NEW DUAL T1 CHANNEL SIGNALING MONITOR

Wilcom Products, Inc. has introduced the Model T356 Dual T1 Channel Signaling Monitor. The unit is rack mounted and interfaces two T1 lines on a monitor basis to display signaling information of all A and B bits simultaneously.

The dual nature of the set allows the user to monitor the signaling status (on-hook, off-hook, ringing, winks, etc.) on both transmit and receive directions of a span line simultaneously, or of any two span lines. The set accepts AMI or B8ZS clear channel code and is compatible with SLC-96 format.

□ For additional information, contact: Wilcom, Inc., P.O. Box 508, Laconia, NH 03247; (603) 524-2622.

Reader Service #45

Reliability is just the beginning...



You expect an amplifier to be reliable. It has to be. We designed the Ashly MOS-FET Power Amplifiers to be rock-steady under even the most demanding conditions.

But, a reliable design is just the beginning. In addition to being inherently self-protecting, Ashly's

amplifiers are sonically superior to even the most expensive competitive products. Experience over 685 watts RMS per channel* of clean, distinct power with incredible depth. Compare the Ashly FET-500 to any of the best amps you've ever heard.

*Output power at 2 ohms at 1kHz with no more than 1% THD.

ASHLY

MOS-FET Power Amplifiers

Ashly Audio Inc., 100 Fernwood Avenue, Rochester, New York 14621
(716) 544-5191 Toll Free outside NY State (800) 828-6308

In Canada: GERRAUDIO Distribution Inc.
363 Adelaide Street East, Toronto, Ontario M5A 1N3 (416) 361-1667

Reader Service #274

SIEDLE MARKETS TWO-WIRE MODULAR INTERCOM SYSTEM

The two-wire intercom/door entry system from Siedle, the world's oldest manufacturer of intercom equipment, has been made available in the U.S.

The system uses two wires (doorbell, old intercom, or extra telephone wires) to operate the doorbell, door release, and intercom. Individual modules for doorbell buttons, speaker, digital keypad, and other system components, snap in and out of standardized frames, permitting customization of each installation.

Advanced electronics permit two-way conversation without the use of "push-to-talk" buttons. The interior

Sound & Communications

SOUND & COMMUNICATIONS

Quick Product Information Guide

COMING NEXT MONTH

Boundary Layer Mics
Specialty Paging
Lab Test Report: IRP Transversal EQ

You can quickly and easily obtain additional information about products and services featured in this issue of **Sound & Communications** by completing this card now.

SOUND & COMMUNICATIONS

QUICK PRODUCT INFORMATION CARD AUGUST 1985

NAME: _____ TITLE: _____
 COMPANY: _____
 STREET: _____
 CITY: _____
 STATE: _____ ZIP: _____
 TELEPHONE: () _____

- ① Are you a subscriber to Sound & Communications?
 Yes No
- ② Primary Job Function (only one):
 Management/Owner
 Engineering/Technical Mgt
 Sales/Marketing
 In-House Maintenance/Service
 Field Installation/Maintenance
 Consultant
 Advertising/Promotion
 Other _____
- ③ Primary business of company (only one):
 Contractor—Engineered Sound/Acoustical
 Contractor—Interconnect/Intercom
 Contractor—Fire/Alarm/Safety
 Electrical Contractor
- Pro Audio/Studio/Reinforcement
 Architect/Designer
 Engineering/Acoustical Consulting
 Maintenance/Service
 Dealer/Distributor/Rep
 Manufacturer
 Other _____
- ④ Your purchasing authority is:
 Final approval/Buyer
 Recommend/Specifier
 No Direct Authority/User
- ⑤ Intensity of your product need:
 Have salesman call
 Need within 3-6 months
 Future projects
- ⑥ Number of employees at your company:
 1-3 4-10 11-25 26-100 over 100

NEW PRODUCTS: (Please Circle)

7	8	9	10	11	12	13	14	15
16	17	18	19	20	21	22	23	24
25	26	27	28	29	30	31	32	33
34	35	36	37	38	39	40	41	42
43	44	45	46	47	48	49	50	51
52	53	54	55	56	57	58	59	60
61	62	63	64	65	66	67	68	69
70	71	72	73	74	75	76	77	78
79	80	81	82	83	84	85	86	87
88	89	90	91	92	93	94	95	96
97	98	99	100					

ADVERTISED PRODUCTS: (Please Circle)

			201	202	203	204	205	206
207	208	209	210	211	212	213	214	215
216	217	218	219	220	221	222	223	224
225	226	227	228	229	230	231	232	233
234	235	236	237	238	239	240	241	242
243	244	245	246	247	248	249	250	251
252	253	254	255	256	257	258	259	260
261	262	263	264	265	266	267	268	269
270	271	272	273	274	275	276	277	278
279	280	281	282	283	284	285	286	287
288	289	290	291	292	293	294	295	296
297	298	299	300					

CARD EXPIRES 12/31/85

SOUND & COMMUNICATIONS

QUICK PRODUCT INFORMATION CARD AUGUST 1985

NAME: _____ TITLE: _____
 COMPANY: _____
 STREET: _____
 CITY: _____
 STATE: _____ ZIP: _____
 TELEPHONE: () _____

- ① Are you a subscriber to Sound & Communications?
 Yes No
- ② Primary Job Function (only one):
 Management/Owner
 Engineering/Technical Mgt
 Sales/Marketing
 In-House Maintenance/Service
 Field Installation/Maintenance
 Consultant
 Advertising/Promotion
 Other _____
- ③ Primary business of company (only one):
 Contractor—Engineered Sound/Acoustical
 Contractor—Interconnect/Intercom
 Contractor—Fire/Alarm/Safety
 Electrical Contractor
- Pro Audio/Studio/Reinforcement
 Architect/Designer
 Engineering/Acoustical Consulting
 Maintenance/Service
 Dealer/Distributor/Rep
 Manufacturer
 Other _____
- ④ Your purchasing authority is:
 Final approval/Buyer
 Recommend/Specifier
 No Direct Authority/User
- ⑤ Intensity of your product need:
 Have salesman call
 Need within 3-6 months
 Future projects
- ⑥ Number of employees at your company:
 1-3 4-10 11-25 26-100 over 100

NEW PRODUCTS: (Please Circle)

7	8	9	10	11	12	13	14	15
16	17	18	19	20	21	22	23	24
25	26	27	28	29	30	31	32	33
34	35	36	37	38	39	40	41	42
43	44	45	46	47	48	49	50	51
52	53	54	55	56	57	58	59	60
61	62	63	64	65	66	67	68	69
70	71	72	73	74	75	76	77	78
79	80	81	82	83	84	85	86	87
88	89	90	91	92	93	94	95	96
97	98	99	100					

ADVERTISED PRODUCTS: (Please Circle)

			201	202	203	204	205	206
207	208	209	210	211	212	213	214	215
216	217	218	219	220	221	222	223	224
225	226	227	228	229	230	231	232	233
234	235	236	237	238	239	240	241	242
243	244	245	246	247	248	249	250	251
252	253	254	255	256	257	258	259	260
261	262	263	264	265	266	267	268	269
270	271	272	273	274	275	276	277	278
279	280	281	282	283	284	285	286	287
288	289	290	291	292	293	294	295	296
297	298	299	300					

CARD EXPIRES 12/31/85

SOUND & COMMUNICATIONS IS NOT JUST A MAGAZINE... IT'S AN INDUSTRY.



NO POSTAGE
NECESSARY
IF MAILED
IN THE
UNITED STATES

BUSINESS REPLY MAIL
First Class Permit No. 155 Carle Place, N.Y.

POSTAGE WILL BE PAID BY ADDRESSEE

SOUND & COMMUNICATIONS MAGAZINE
220 Westbury Ave.
Carle Place, New York 11514

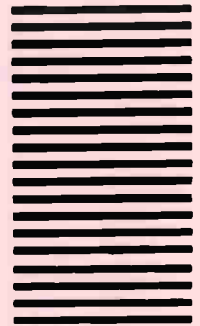

NO POSTAGE
NECESSARY
IF MAILED
IN THE
UNITED STATES

BUSINESS REPLY MAIL
First Class Permit No. 155 Carle Place, N.Y.

POSTAGE WILL BE PAID BY ADDRESSEE

SOUND & COMMUNICATIONS MAGAZINE
220 Westbury Ave.
Carle Place, New York 11514

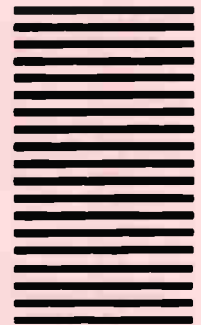

telephone is activated when the door button is pressed. The door strike is operated by pressing the "key" button on the telephone.

The interior unit can be installed for wall or desk use. The "dot" button, used in Europe to turn on lobby lights, can control intercom signals or alarm systems.

Entry units are weatherproof and vandal-resistant and are available with flush mount, surface mount and pedestal column mountings.

The system can be expanded to accommodate up to 2,000 apartments.

□ For more information, contact: Siedel Intercom/USA, One Wynnewood Road, Wynnewood, PA 19096; (800) 874-3353 or in PA. (215) 649-7722.

Reader Service #46

MOSFET POWER AMPS AVAILABLE FROM BOGEN

MOSFET power amplifiers now are available in the new Hi-Tek Professional Series from Bogen. Models



HTA-125 and HTA-250 are designed to bring the advantages of MOSFET technology to engineered sound system applications.

Bogen's new generation of power MOSFET amps' output stages are said to provide outstanding performance, higher efficiency, reduced heat, simpler over-all design, and reduced size and weight at prices comparable to those of conventional power amplifiers. This is achievable, in part, because MOSFETs allow reductions in formerly massive heat sinks and complex protective circuitry.

The 125-watt HTA-125 and 250-watt HTA-250 are capable of continuous operation at rated output power with less than 0.5 percent total harmonic distortion from 20 to 20 k

Hz. Each has a frequency response at full rated output of ± 1 dB, 20-20 k Hz and output regulation better than 2 dB from no load to full load. Residual hum and noise is at least 90 dB below rated output. Full rated output requires an input signal of only 500 mV for high impedance and 150 mV for low impedance.

□ Contact: Bogen, P.O. Box 500, Paramus, NJ 07653; (201) 343-5700, ext. 251.

Reader Service #47

OWP'S NEW WEATHERIZED THREE-WAY LOUDSPEAKER

For external or internal applications, OWP's 70/3 is a three-way mini extension speaker system said to be designed for high fidelity sound performance and easy installation.

The speaker's dimensions 7-1/8 inches high \times 4-1/2 inches wide \times 4-1/8 inches deep, and offers an input line voltage of 70.7 V. Housed in a watertight, aluminum die cast enclosure-including bracket and features such as an input power select

T H E E D G E



In pro-audio, the edge is a combination of talent and technology.

DR1 DIGITAL REVERB SYSTEM

- FULL 16-BIT TECHNOLOGY/14KHz BANDWIDTH
- FULL FUNCTION REMOTE CONTROL INCLUDED
- OVER 100 PRESETS/USER PROGRAMMABLE
- FULL MIDI CAPABILITY
- STEREO IN/OUT/FULL MIX CONTROL
- SOFTWARE BASED/UPDATEABLE



Full Function Remote Control

Our brand new software based DR1 Digital Reverb has 16-bit technology and 14KHz bandwidth, giving you wide dynamic range and frequency response. This range and response result in high definition performance.

Couple this technology with the convenience of full function remote control, over 100 user presets and full MIDI capability. Add your talent and you've got the edge in high definition.

And that's not all. We've gone several steps beyond by providing stereo in and out with full mix

control and our famous FIR programs so that all the sound you're looking for can be realized.

There's one more thing. Our powerful software is updateable. That means when you buy a DR1 today, you won't lose your edge tomorrow.



Applied Research & Technology Inc.
215 Tremont Street
Rochester, New York 14608
(716) 436-2720

■ DR1 DIGITAL REVERB ■ 01A DIGITAL REVERB ■ DR2 DIGITAL REVERB ■ 1500 DIGITAL DELAY ■ 1/3 OCTAVE EQUALIZER ■ 2/3 OCTAVE EQUALIZER ■ PITCH TRANSPOSER PACKAGE

Reader Service #282

SOUND & COMMUNICATIONS CLASSIFIEDS GET RESULTS

If you're looking for new employees, new business or just trying to sell some used equipment, then *Sound & Communications* classifieds are for you. More qualified readers look through *Sound & Communications* classifieds than any magazine in this industry.

For rates and information, please call Debbie Nappi at (516) 334-7880, or write to:
Classifieds, *Sound & Communications*,
220 Westbury Ave., Carle Place, NY 11514.

Crest PILLOW SPEAKERS



CREST manufactures pillow speakers, replacement cables and call cords to mate with the following Nurse Call & Television Systems:

Altec
American Zettler
Auth
Bunting-Steri
Couch
Crest
Edwards
Ektacom

Executone
Dictograph
DuKane
General Electric
Hill Rom
Motorola
Norelco
Philips

Picker Briggs
Rauland-Borg
RCA
Sylvania
Teletracer-Intn'l
Wells
Med & Tek
Zenith

CREST manufactures original and replacement products for:

- Annunciators
- Visual Nurse Call Systems
- Security Monitoring Systems
- Senior Citizens Emergency Call System
- Doctor's In & Out Registers
- BREATHCALL Nurse Call Devices

FREE 50 PAGE CATALOG ON REQUEST

CALL TOLL FREE
800-328-8908

CREST ELECTRONICS
Simon at Third
Dassel, MN 55325

In MN: Call
612-275-3382

Reader Service #276

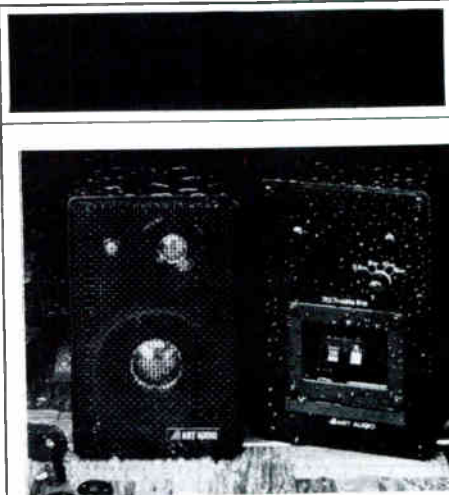

knob (2.5W, 5W, 10W, or 15W) with a built-in transformer for background/foreground music.

For more information, contact: OWI, 1160 Mahalo Place, Compton, CA 90220; (213) 638-7506.

Reader Service #49

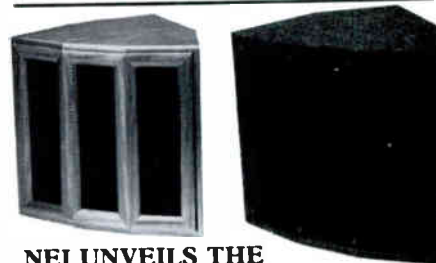

NEI UNVEILS THE 94 AND 94W LOUDSPEAKERS

NEI has announced its latest addition to its line of professional audio products: speaker models 94 and 94W. The models 94 and 94W are 39 pound, full-range loudspeakers designed for reinforcement of voices, music, and instruments. The model 94 is for applications requiring a rugged, portable enclosure, while the 94W loudspeaker is intended for use in permanent indoor sound system installations.

Both speakers employ nine, four inch, full-range drivers, mounted symmetrically in vertical columns of three. The drivers feature high linear excursion and are capable of reproducing continuous program material in excess of 200 W from 50 Hz - 18 kHz. The model 94 speaker enclosure, composed of plywood covered with rugged, industrial carpet, uses two parallel-wired one-quarter inch phone jacks as input connectors.

The models 94 and 94W are available for \$649 each.

For more information, contact: Bud Garrison, NEI, 934 N.E. 25th Ave., Portland, OR 97232; (503) 232-4445.

Reader Service #48

Aiphone has a sound you like to hear:



Profit.

AMPLIFY SALES. More and more smart sound contractors are discovering that Aiphone business and residential intercoms can turn up sales volume and boost margins.

A SOUND LINE. We have the systems for literally any business or residential application. Plus the accessories to complete the job. From horn speakers to ceiling speakers. From reflex horns

and drivers to high-performance mixer amps.

All with the same great quality as our intercoms. All in perpetual 90-day supply. Ready for same-day shipment.

BUILT TO LAST. Aiphone has the best service record in the business. That means double

profitability to you by eliminating costly call-backs.

Call or write us today and we'll show you the line of intercom systems that sells as good as it sounds.

AIPHONE
INTERCOM SYSTEMS

1700-130th Ave. N.E., Bellevue, WA 98005
(206) 455-0510

Reader Service #294

TOUCH AND GO.

It pays to be an Edstan distributor.

You've seen the news... hospitals are having to compete for patients and doctors. This competition means healthcare facilities across the country are looking for ways to cut their overhead while creating a better environment for physicians.

That's why the state-of-the-art Edstan Doctors Register is selling so well. It saves hospitals considerable time, money and errors. And doctors really appreciate it because it simplifies their day. This means profit for our distributors. (A Pennsylvania Dukane dealer sold five Edstan systems last year! Four were sold by a midwest Rauland dealer in the last ten months!)

You get total support from the nation's leader.

For over 26 years, Edstan has been the leader in Doctor's Register Systems. As a distributor you can count on us to support you in every way... sales, installation and maintenance. In addition, we presell the Edstan system with an ongoing

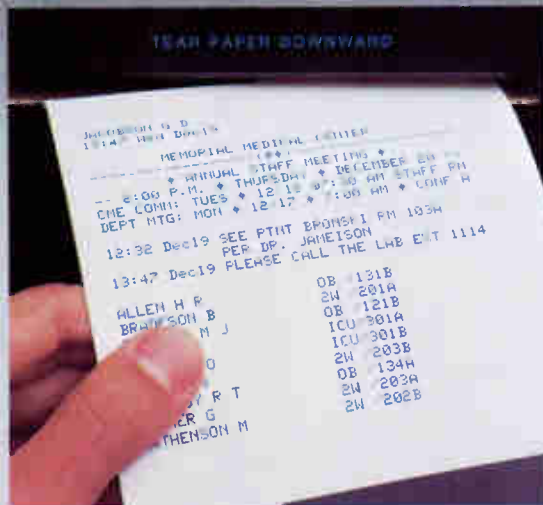

advertising program targeted at hospitals throughout the country.

Edstan has the best service record in the industry.

Edstan is completely modular. We manufacture and quality-control each component and maintain a shelf stock sufficient to react to service calls with "next morning" delivery. We

also have a 24-hour, toll-free service hot-line for your maintenance personnel and customers. On-site maintenance training is provided with each installation.

Edstan is a system you can sell without becoming an expert.

How? By using our video cassette and our demonstration personnel. A multi-level dealer plan can limit your responsibility and participation to your particular organization's capabilities.

Find out how you can become an Edstan distributor.

Take a moment to fill out and return the coupon or give us a call at **(800) 423-4765**.

EDSTAN Doctors Register
TIME AND SOUND CO., INC.

FREE DISTRIBUTOR'S INFO KIT

Please send me free information regarding a distributorship.

Name _____

Title _____

Company _____

Address _____

City/State/Zip _____

Telephone _____

MAIL TO: Time & Sound Co., Inc.
14120 Live Oak Avenue
Baldwin Park, CA 91706

Reader Service #296



BOOK REVIEW

by Ted Uzzle

RELIGIOUS INSTALLATIONS

Lubman, David, and Ewart Wetherill, *Acoustics of Worship Spaces*, American Institute of Physics, 1985.

What useful generalizations can be made about the acoustics of houses of worship? Not very many.

Worship spaces range from Gothic built with masonry to mock-Gothic built with Akustolith tile, to churches-in-the-round, to fan shaped auditoria. Ceilings range from ribbed vaults to domes to peaks to suspended office-type tiles. Reverberation times can range from a fraction to a fortnight.

To complicate things, the auditory program may include various media; pipe organs, electronic organs, small choirs, massed choirs, sung liturgies, and evangelists with tremendous dynamic ranges. It must all come out intelligible and musical and often is broadcast.

The only way to sort out this decidedly un-ecumenical diversity of architecture and acoustic effect may be with an extended casebook showing a variety of solutions in a variety of venues.

In November 1983, the Acoustical Society of America organized a poster session on worship space acoustics for its San Diego, CA, conference. Seventeen consulting organizations prepared technical information on 43 worship spaces from all over the world, of all styles: old, renovated and new. The posters included photographs, plans and sections, and descriptive data for each project.

The book which resulted includes the reproduced posters, with a page of explanation for each. The reader interested in church acoustics can sample some of the best work going on around the world.

The Chapel at Duke University in Durham, NC, is a ribbed Gothic behemoth of one million cubic feet. When a new organ was installed, its four second reverberation time (at 250 Hz) was judged too short. Consultants Bolt Beranek and Newman found much of the inner surface to be a porous absorbing material, and after four coats of sealant they achieved seven seconds of reverberation—just about satisfac-

tory for the organ builder. It took less than seven seconds for the reinforcement system to be found inadequate, however, and the consultants designed a very sophisticated system of cascaded delays and loudspeakers along the arcade at the sides of the nave. "While their appearance is hardly in the neo-Gothic spirit," they said, they achieved both intelligibility and excellent musical acoustics.

The Saint Margaret Mary Church in Winter Park, FL, poses another classic problem. The seating area (capacity 1,100) is exactly semi-circular, making earlier attempts at a central cluster loudspeaker system over the sanctuary (the center of the semicircle) a failure, compounded by distributed column loudspeakers along the rear wall, facing the sanctuary. Consultant Marshall Long found an adept solution: two loudspeaker clusters, each behind and to each side of the sanctuary, firing across each other to the far side of the pews. Thus, one main central focus of reflection was divided into two foci, both over the heads of audience.

The Randall Memorial Baptist Church in Amherst, NY, is a classic shoebox, with classically correct internal acoustics. Its problem, however, is from *above*: it is directly underneath the flight landing approach to Buffalo International Airport. Angevine Acoustical Consultants, Inc. used a reinforced roof ventilated through the eaves, combined with double glazed windows for the clerestory.

Forty other detailed examples demonstrate the variety of problems, and solutions, in worship space acoustics. Particularly interesting are three contributions from Japan.

In some cases the reinforcement loudspeakers must be altogether invisible, and in many of these cases the congregation has paid a considerable premium for pewback loudspeakers. In some cases the walls are pierced for loudspeakers, with modesty grills flush with the wall. This is a natural solution in many churches; after all, this is the way organ pipes are often handled. In some cases the central loudspeaker cluster is covered by a

CONFERENCE COMMUNICATION SYSTEMS

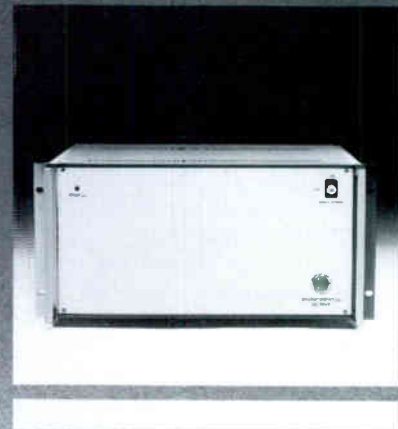

In this rapidly shrinking world, the necessity for highly sophisticated conference communication systems is becoming increasingly important. In business, industry and government.

We are proud to offer computerized conference microphone systems and simultaneous interpretation technology from the best in the world. DIS-USA.



DANISH INTERPRETATION SYSTEMS

2831 15th St. N.W.
Washington, O.C. 20009
(202) 387-7900 Telex: 64394
Reader Service #281

MOVING?

Please attach your Sound & Communications mailing label or print your address exactly as it appears on the label.

NEW ADDRESS

NAME (Please Print)

COMPANY

ADDRESS APT NO.

CITY STATE ZIP

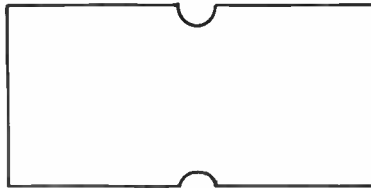

Return to:
Circulation Dept.
Sound & Communications
220 Westbury Avenue
Carle Place, NY 11514

NO MOVING PARTS—ZERO MAINTENANCE

Solid-state, Natural Voice Digital Message Repeater

MacKenzie's Digital Message Repeater is a revolutionary new concept in repetitive sound.

Our all-solid-state DMR has *no moving parts* and requires *no periodic maintenance*. It uses EPROM memory cartridges to store digitized recordings of human voices, music or sound effects. Upon demand, the digitized information is reconverted to analog, and the message is played to an audio output.

The sound is completely natural—just like a conventional tape recording—and the audio quality is excellent.

Messages are permanently stored and may be played over and over again without loss of sound quality.

Designed to handle short messages, the DMR is ideal for:

- Fire alarm announcements
- Voice evacuation
- Fireman's return
- Weather warnings
- Parking warnings
- "Watch your step" messages
- Rental car return instructions
- Sound effects
- Dark rides
- Exhibits and displays

The DMR consists of the message cartridge and the controller main frame. The complete unit is very compact—only 8 x 4.8 x 2.4 inches.



MacKenzie's new, solid-state Digital Message Repeaters use EPROM memory cartridges to play messages. The sound is excellent—and completely natural.

DMR message cartridges are recorded at the MacKenzie factory. If a message requires changing, the cartridge is returned to the factory for re-recording. An exchange service is available to eliminate down-time. Standard message time is up to 60 seconds; longer message time is available.

MacKenzie Laboratories has been manufacturing rugged, reliable message repeaters for over 25 years. Our new DMR series is built to the same exacting standards which have made our name synonymous with repetitive sound.

For more information, call MacKenzie Laboratories toll-free at 800-423-4147.

MACKENZIE

MacKenzie Laboratories, Inc.
5507 Peck Rd., Arcadia, CA 91006 USA
Telephone: (818) 579-0440

ADVERTISING TABLE OF CONTENTS

RS#	Company	Page Number
294	Aiphone	61
	AKG	12
282	ART	59
274	Ashly	58
265	Astatic	52
248	Atlas	73
288	Bi-Tronics	74
250	Bogen	31
298	Cerwin Vega	67
278	Cetec Raymer	63
261	Cetec Vega	46
234	Cornell	6
276	Crest	60
279	Crown	71
256	David Clark	40
255	J.W. Davis	38
238	dbx	27
281	Dis USA	65
299	DOD	77
252	DuKane	34
230, 291	Electro-Voice	II, 23
268	Environmental Sound	54
277	Florence	62
240	FourJay	19
264	FSR	51
292	Galaxy	30
220	Grommes Precision	70
249	HM Electronics	30
287	JBL	21
272	Klark Teknik	57
236	Knowles	13
273	Lee Dan	58
295	MacKenzie	64
239	Nady	16
241	NEI	20
283	Neutrik	35
217	Numark	76
289	Oaktron	56
246	OWI	26
244	Panasonic	43
232	Paso	5
293	Peavey	11
269	Rane	55
254	Ring	36, 37
210	Ross	75
260	Rowe	53
285	RTS	69
286	Shure	IV
262	Sonic Systems	47
253	Soundolier	68
267	Speco	54
275	TAD	III
243	Tape-Athon	22
251	Tascam	32
296	Tektone	3
245	Telephone Sales & Service	26
233, 258	Telex	7, 42
284	Time & Sound	64
257	TOA	41
280	White	74
263	Williams Sound	50
237	Yamaha	17, 18

VERSATILE.

V-43

Cerwin-Vega!

In a survival situation, there's no time to worry about how your sound system will perform. That's why the best American and European performers rely on Cerwin-Vega sound systems!

The Cerwin-Vega V-43 is a direct offspring of C-V's renowned family of full-scale touring concert systems. Featuring our brand new high-efficiency driver design, the V-43 has been engineered and built for a variety of applications.

A high sensitivity M-150 compression driver in a new throat design replaces "power hungry" cone midranges from 300Hz to 3kHz. This makes the V-43 ideal for smaller clubs, halls and theaters where you need more output per watt. High efficiency means no costly or complex bi-amping. Its versatility means musicians can use the V-43 for vocal and keyboard performance.

Compare the Cerwin-Vega V-43 to other "high performance" systems on the market. You'll appreciate the difference between using an ordinary P.A. and owning the most uncompromising music reproduction system in the world.

For more information, please write or call:

 **Cerwin-Vega!**

12250 Montague St.
Arleta, CA 91331
(818) 896-0777 Telex: 662250

Reader Service #298

frame with grill cloth stretched over it. In some cases the designers eschew fig leaves completely, and boldly hang loudspeakers directly over the altar. Some architects will call this madness; a few will call it authentic to function ("authentic" and "function" being powerful buzzwords to architects at the moment).

Acoustics of Worship Spaces begins with a series of essays on the subject. David L. Klepper, of KMK Associates, White Plains, NY, has contributed a discussion entitled: "Considerations for the Design of Worship Space Acoustics: An Acoustical Consultant's Viewpoint," which sorts out the readily identifiable types of worship halls, with comments on the relative advantages and disadvantages of each to proper sound transmission to the congregation.

David Lubman, one of the editors of the book, contributed, "Notes on Conflicting Acoustical Requirements for Speech and Music in Worship Spaces, and the Uses of Electronics for their Reconciliation." This is a history of the electronic church, a subject often insufficiently considered.

Two more essays conclude the open-

ing section of the book. Anna K. Nabelek of the University of Tennessee describes the available methods of "Accommodating Listeners with Special Needs in Worship Spaces," by means of individual listening devices

The designer is certain to find something like his next project in these pages, together with a solution that worked in the original circumstances.

fed via induction loops, broadcast, or infrared. The treatment of this subject here is apparently aimed at convincing architects and acoustical designers of the utility of including such systems in churches. There is no "how to do it"

information, and for this Dr. Nabelek could usefully have cited a series of recent papers in the *Journal of the Audio Engineering Society* assembled by Rollins Brook of Bolt Beranek and Newman.

Finally, there is an unsigned outline of "The Use of Acoustical Consultants for Worship Space Projects," which advocates the employment of acoustical consultants and describes their trade association, the National Council of Acoustical Consultants.

Those who design worship spaces, or design their acoustics or sound systems, will find *Acoustics of Worship Spaces* both unique and valuable. It provides a broad insight into the diversity of modern design challenges and responses. The designer is certain to find something like his next project in these pages, together with a solution that worked in the original circumstances. As a gift for an uncooperative architect or client it can apply a needed corrective to those who insist acoustical excellence doesn't matter, can't be achieved, or isn't worth the money.

Acoustics of Worship Spaces may be purchased for \$15, from the Acoustical Society of America, 335 E. 45th St., New York, NY 10017.

soundolier® we're all around you



Whether in the ceiling, on the wall, standing, suspended or flange-mounted, millions of aesthetically styled loudspeaker assemblies prove that Soundolier is the commercial sound products manufacturer to supply your communications needs.

We pioneered the cost-efficient pre-assembled system of high quality baffles, speakers and transformers 30 years ago. Our U.S.-made acoustic enclosures are available in an extensive range of designs to satisfy the most demanding requirements of architects, decorators, and consulting engineers.

Sizes for 4", 8" and 12" loudspeakers come in round, square, torsion-spring, and hardware-mounted, and offer many choices of finishes and colors.

For offices, hotels, factories, schools, hospitals, shopping centers and recreational facilities, choose the best and contact: Soundolier, Division of American Trading and Production Corporation, 9380 Watson Industrial Park, St. Louis, MO 63126. Tel.: (314) 962-9870.

soundolier®

SERIES 2500 AMPLIFIER SYSTEM

Introducing a series of super high-performance audio amplifiers designed to be part of a versatile three rack-unit card-frame system. The Series 2500 will offer a variety of 20 plug-in amplifiers. The first four are featured in this bulletin.

Thorough circuit design coupled with industrial high-grade components assure unconditional stability and long-term reliability. A full-frame steel housing surrounds each amplifier for structural support and electrical shielding.

Some of the exceptional specifications common to 2500 Amplifiers are: +28 dBm into 600 ohm loads from 30 Hz to 20 kHz all outputs driven; +32 dBV max input level; SNR > 100 dB; input CMRR typ 75 dB @ 50 Hz; 4 μ s rise time; max phase shift +22.5° @ 20 Hz, -22.5° @ 20 kHz; output source impedances of 80 ohms or less.

Interconnection to external equipment is simple and reliable via .025 square post terminations. This universally accepted technology is inexpensive and easy to install or modify.

MODEL 2510 1 X 6 Audio Distribution Amplifier. Isolation between outputs typ 70 dB @ 1 kHz. Maximum output level with $\leq 0.1\%$ THD from 30 Hz to 20 kHz into 150 ohms is +25 dBu and +28 dBm into 600 ohms. The output transformers do not require termination and do allow less than 1% overshoot.

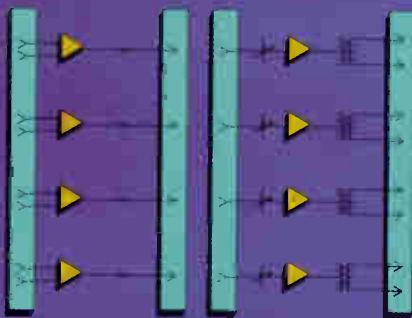
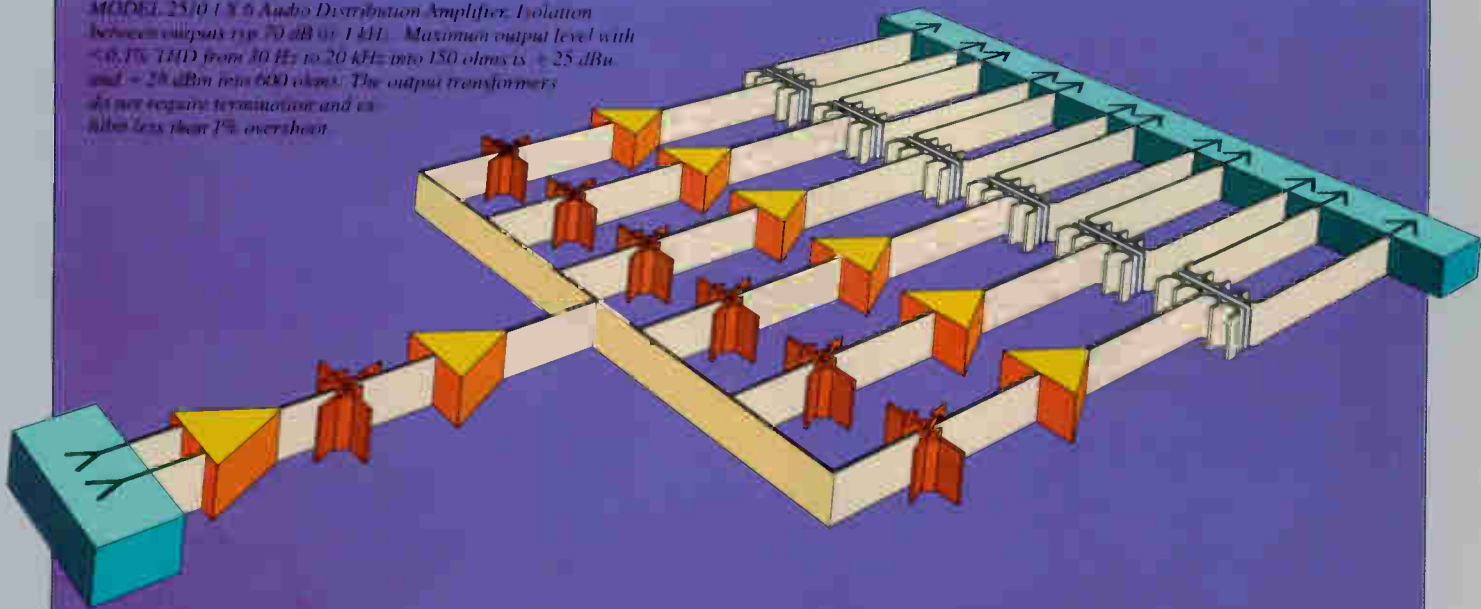

MODEL 2516 Quad Buffer Amplifier is primarily designed to interface unbalanced 10 dBV IHF level equipment to balanced +4 +8 dBm professional equipment.

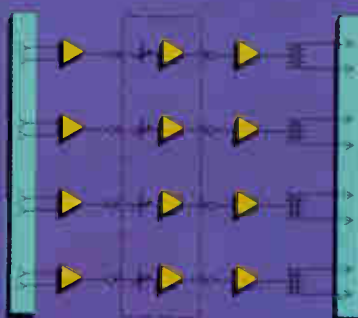

MODEL 2514 Quad Line Amplifier can be used as four discrete amplifiers or two stereo pairs. Optional remote gain VCA circuitry is available.

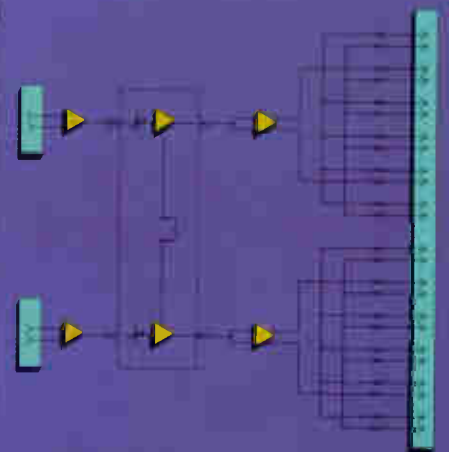

MODEL 2512 Stereo 1 X 6 Audio Distribution Amplifier can be used as a single 1 X 12 or a dual 1 X 6 distribution amplifier. Optional remote gain VCA circuitry is available.

RTS SYSTEMS

INCORPORATED

A Compact Video Company

For more information on the Series 2500 call or write

RTS SYSTEMS, INC. PROFESSIONAL INTERCOMMUNICATIONS • PROFESSIONAL AUDIO PRODUCTS
1100 West Chestnut Street, Burbank, California 91506 • Phone 818 843-7022 • Telex 194855

Reader Service #285
World Radio History

FACES AND PLACES

Crown International Names Smith Purchasing Agent

Crown International, Inc. has appointed Patti Smith to the position of Purchasing Agent. In the position, Smith will be responsible for the scheduling, ordering and expediting of passives, electromechanical devices, molded plastics, labels and nameplates, and packaging materials.



PATTI SMITH



BRUCE E. HEEB

Given additional departmental responsibilities, Smith will also be

assisting the purchasing manager in the development of long range plans for the purchasing department.

Switchcraft Appoints Heeb VP of Engineering

William C. Jones, president, Switchcraft, announced the appointment of Bruce E. Heeb as vice-president of engineering. Heeb replaces Eric Long who moved to the Caloric Corp.

Heeb joins Switchcraft from Federal Signal Corp. of University Park, IL, where he was vice president of engineering. During his tenure with Federal Signal, Heeb had previously held the posts of director of manufacturing and manager of electro-mechanical products.

In related news, Ed Larrabee, vice president of marketing and sales, announced the appointment of William Kysiak as product manager for connectors and audio accessories and Wendy Malisoff as applications engineer for Din connectors and cable assemblies.

Audio-Technica Appoints Wehrmann To Advertising Staff

The appointment of Rock Wehrmann to the newly-created position of assistant advertising manager was announced by Don Kirkendall, director of marketing communications, Audio-Technica, U.S., Inc.

Prior to the appointment, Wehrmann was marketing and advertising manager at Moog Music, Inc., Buffalo NY.



ROCK WEHRMANN



HOWARD A. LAFFLER

Laffler Named President of Walker Telecommunications

Burt Walker, chairman and chief executive officer of Walker Telecommunications Corporation announced the appointment of Howard A. Laffler as president of the company, a position previously occupied by Walker.

Prior to joining the company, Laffler served as president and general manager of national distribution and sales for ITT's Business and Consumer Communications Division where he had direct responsibility for annual sales, service, and distribution of more than \$300 million of telecommunications equipment. He also served as president of ITT Business Communications Corporation, a major sales and interconnect company.

Holmes Named Houston VP for Centel Business Systems

J. B. Holmes, a 25-year veteran of the telecommunications industry, was appointed vice president of the Houston region of Centel Business Systems. His supervisory responsibilities include marketing, installation and service of Centel business communications systems in southeast Texas, including Houston, Beaumont, and Galveston.



GROMMES PRECISION BACKGROUND MUSIC AND PAGING RECEIVER



PR-540 FM-AM FEATURES

- ★ Super-sensitive FM-AM tuner section—(1 9uV IHF sensitivity on FM)
- ★ 40 watts RMS power
- ★ Microphone input can be blended with music
- ★ Microphone precedence mutes music for paging
- ★ Bass treble and loudness controls for music only
- ★ Output for voice coil as well as 25 or 70 volt line
- ★ Booster amplifier output for adding more power output
- ★ Output for telephone music on hold amplifier
- ★ 600 ohm line input or telephone page with separate control
- ★ High or low impedance balanced microphone input
- ★ Built in antenna for AM or FM and provision for external antennas
- ★ Signal strength tuning meter
- ★ Fly wheel tuning
- ★ Silent tuning for FM
- ★ Separate off-on power switch
- ★ Monitor speaker and main speaker switch
- ★ Auxiliary inputs for tape

AUDIO SECTION

Power Output 40 watts RMS with 0.25% or less harmonic distortion
 Frequency Response ± 1dB 20 to 20,000Hz 4 or 8 ohm output
 ± 1dB 50 to 15,000Hz 25 or 70 volt output

PR-510 FM-AM PR-513FM FEATURES

- ★ Super-sensitive FM-AM tuner section—(1 9uV IHF sensitivity on FM)
- ★ High or low (switchable) input Impedance
- ★ Microphone input can be blended with music
- ★ Microphone precedence mutes music for paging
- ★ Output for voice coil as well as 25 or 70 volt line
- ★ Booster amplifier output for adding more power output
- ★ Output for telephone music on hold amplifier
- ★ 600 ohm line input or telephone page
- ★ Built in antenna for AM or FM and provision for external antennas
- ★ Signal strength tuning meter
- ★ Silent tuning for FM
- ★ Loudness contour control
- ★ Auxiliary input for tape
- ★ Separate off-on power switch

AUDIO SECTION

Power Output 14 Watts RMS with 0.5% or less harmonic distortion
 Frequency Response ± 1dB 20 to 20,000Hz 8 ohm output
 ± 1dB 50 to 15,000Hz 25 or 70 volt output

PRECISION ELECTRONICS INC., FRANKLIN PARK, ILLINOIS 60131
 Reader Service #220

REP NEWS

Two **Audio-Technica** sales representative firms, one from Hollywood, CA, and another from Catonsville, MD received special honors at the national sales meeting recently held at the de la Poste Hotel, New Orleans, LA. Winner of the **Order of the Samurai** was **New West Audio** which represents Audio-Technica in southern California, Arizona, and southern Nevada. Present to receive the glass-encased hand-made Samurai warrior symbolizing the achievement were **James Murray** and **Tim Schaeffer**, both of New West Audio.

Cited as the representative firm in the "**Most Improved Territory**" was **Audio Associates**, Audio-Technica's product representative for Delaware, Pennsylvania, West Virginia, and New Jersey. An engraved plaque commemorating the most improved representative territory was presented to **Joe Blacker**, president of Audio Associates.

Shure Brothers' Silver Cup Award for outstanding sales achievement was presented to **Peter E. Schmitt** president of **Peter E. Schmitt Co.**, Shure's sales representative in the New York City area.

Signal Cable Company, the manufacturers of wire and cable for the commercial sound and telephone interconnect industries, has announced the appointment of **Austin Associates**, of Willingboro, NJ, as their representatives in eastern Pennsylvania, Maryland, southern New Jersey, Delaware, Virginia, and Washington, D.C.

MISCO/Minneapolis Speaker Company has announced the appointment of the following companies to represent its commercial sound product line: **Austin Associates**, Mid-Atlantic region; **Alby Currant Sales**, upstate New York; **W. A. Hendrickson Company**, New England; **Lichtenauer and Associates**, northern California and northern Nevada; **Murphy and Cota**, southern region; and **World Wide Electronics**, Florida.

To have your rep news listed, please send your information to: Rep News, Sound & Communications, 220 Westbury Ave., Carle Place, NY 11514.

If it's worth doing, it's worth doing right.



We did it right.

It's no surprise that when the key engineers of our PZM® microphone technology set their sights on combining the benefits of the boundary effect with unidirectionality, the fruits of their efforts would be nothing less than superior.

After all, Crown has been leading the way in boundary technology longer than anyone in the industry. And, like the PZM project, our commitment to developing the "premiere" unidirectional, surface-mounted microphone rings true.

Introducing the PCC™-160 Phase Coherent Cardioid™ from Crown.

Designed for easy mounting on a boundary surface, the PCC-160 utilizes a sub-miniature supercardioid mic capsule to create a directional pattern which im-

proves gain-before-feedback, reduces unwanted room noise and rejects sounds from the rear.

For stage reinforcement, podiums, news desks, or for hiding in sets, the PCC-160 offers superior performance.

And because the microphone is mounted on a boundary, direct and reflected sounds arrive at the diaphragm in-phase. The result...wide, smooth frequency response free of tonal coloration or unnatural sound which can occur with conventional microphones.

Self-contained electronics eliminate the need for a sometimes awkward in-line preamp box. The PCC-160 can be powered directly from the console or other remote power source. Or if battery power is convenient, a battery supply unit can be inserted anywhere in the mike line...right up to the console or mixer.

For maximum flexibility, the PCC-160 features an exclusive three-way "bass tilt" switch which allows you to tailor, up or down, the low-end response for special applications or unusual boundary sizes.

Due to its low profile and "go away gray" finish, the PCC-160 microphone becomes nearly invisible in use, making it ideal for the stage, newsroom or lectern top.

But beneath its cloak of dark gray, the PCC-160 is protected by a heavy-gauge, all-steel body, tough enough to stand up to even the most severe abuse.

The PCC-160. A microphone meeting the needs of today's sound professional with today's most advanced technology.

We did it right.

Call or write for more information and complete specifications.



Crown International, 1718 W. Mishawaka Rd., Elkhart, IN 46517 (219) 294-8000.

Reader Service #279



NEW KIT FEATURES FIXED HANDLE FASTENERS

Jensen's new JTK-55 Electronic Field Engineer's Kit is designed for service technicians who prefer fixed handled fastening tools rather than interchangeable blades and handles.

The kit's full range of handled tools includes 11 screwdrivers, nine nut drivers, and nine hexdrivers. The kit is said to save time on the job by ending the need to continually switch blades in and out of a handle to match the work.

The JTK-55 also contains a complete assortment of additional tools such as pliers, wrenches, measuring tools, and soldering equipment and is available in three case styles with removable gate-swing pallets.

Contact: Jensen Tools Inc., 7815 S. 46th St., Phoenix, AZ 85040; (602) 968-6231.

Reader Service #50

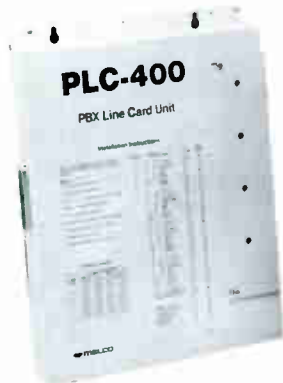

NEW LINE CARD FROM MELCO OFFERS VERSATILITY

The PLC-400 from Melco is a key system line card which enables standard 1A1 or 1A2 type key system telephones to be used with a Melco MAX Communication System or a similar PABX system. The line card allows four additional central office (C.O.) lines to be added to the PABX installation for use by the key telephone stations. Provisions are

made to allow the PABX stations controlled access to the C.O. lines used by the key telephone stations.

In addition, the key telephones may be configured to allow access to all stations, lines and features available through the PABX system.

The PLC-400 provides the key telephones with lamp control, bell or buzzer ringing, line hold and optional music-on-hold. Incoming calls received on a C.O. line added through the PLC-400 can be assigned to ring the key telephone stations only, or to ring both the key telephone stations and the PABX.

Contact: Melco Labs, Inc., 14408 N.E. 20th St., Bellevue, WA 98007; (206) 643-3400.

Reader Service #51

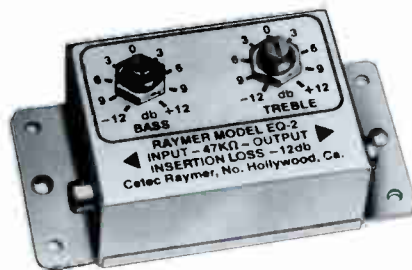

NEW CETEC RAYMER IN-THE-LINE TONE CONTROL

Cetec Raymer's EQ-2 Equalizer is designed for installation in series into any high impedance audio system to enhance music and speech. Weighing less than one pound and measuring $3\frac{3}{8} \times 2 \times 1$ inches, it has RCA phono jack input and output connections at either end. Two screwdriver adjustments on the face provide bass and treble compensation of ± 12 dB to -12 dB at 50 Hz and 15,000 Hz with crossover at 700 Hz.

Contact: Cetec Raymer, 7315 Fulton Ave., N. Hollywood, CA 91605; (213) 875-0423.

Reader Service #52



NEW COMPACT CABLE BENDERS FROM KLEIN TOOLS

Klein Tools' new compact cable benders are forged from one solid piece of steel which is said to assure strength and reliability.

The bender #50400 measures 12 inches in length for ample leverage; and is compact enough to afford easy access into tight places. The bender head has a $7/8$ -inch wide opening to easily insert cables up to its 300 MCM capacity. The head is angled at 22 degrees to facilitate bending cables in tight or restricted areas.

Bender #50402 is slightly longer, measuring $14\frac{1}{2}$ inches in length. This bender has a $1\frac{1}{4}$ inch opening for use in bending cables up to 500 MCM.

Contact: Linda Srill, Klein Tools, Inc., 7200 McCormick Blvd., Chicago, IL 60645-4431; (312) 677-9500.

Reader Service #53

ELECTRONIC SPECIALISTS EXPANDS ITS PRODUCT LINE

Electronic Specialists' expanded product line includes the Klein Line PDS-21 secondary phone security system. Used for office and factory installations, models can be obtained tailored for either phone, data, or remote-control applications. One through 25 pair can be accommodated.

Intended for secondary suppression of damaging transients or hi-voltage spikes, the PDS-21 system also incorporates RF interference filtering technology.

Model PDS-21 with three pair guarded security is \$191.

Contact: Electronic Specialists, Inc., 171 S. Main St., P.O. Box 389, Natick, MA 01760; 1-(800)-225-4876.

Reader Service #54



NEW SERIES OF SCREWDRIVERS FROM VERTRON INT., INC.

Vertron International Inc. has announced a new series of screwdrivers.

The series of screwdrivers have an extended neck which is said to assure grip and balance. The fingers can be brought close to the tip for guiding into the screw slot, allowing for quick tightening with only fingertips. The screwdrivers are available with slotted, phillips, and pozidrive tips.

Contact: Vertron International Inc., 20906 Higgins Court, Torrance, CA 90501; (213) 320-6952.

Reader Service #55

SIMULTANEOUS INTERPRETATION

(continued from page 47)

standards. It can get mighty crowded during a busy session. The interpreter's unit is manufactured in dual form mounted in a compact console to serve two interpreters in a signal booth, with single units also available.

The language which the interpreters are translating is referred to as the "floor language." The floor languages in which the delegates are permitted to address the conference are always determined in advance. Early SIT systems generally provided interpretation facilities for four languages, however, with the expansion of U.N. facilities and the European Common Market, six to nine language systems have become common with 12 language systems anticipated in the very near future.

It is sometimes necessary for an interpreter to translate from a language other than the floor language by monitoring the translation into a second language which he understands. For example, an interpreter who may not understand Chinese but understands

French may monitor the French translation and translate it into German. This is called "relay language."

Although often used interchangeably, there is a significant difference between the words interpret and translate from a linguistic standpoint. To interpret is to convey the meaning of the spoken word in another language, whereas a translation may be a literal substitution of words or phrases of one language for another. As an example of what can go wrong, the common English expression "out of sight, out of mind" can easily be rendered in Chinese as "invisible idiot." Take that translation into a third language and watch the sparks fly!

The interpreter's unit contains a headset socket with volume and tone controls to reduce listening fatigue, a switch to select the floor or relay language, relay channel selector switches, a microphone ON/OFF switch, a PAUSE or COUGH switch to momentarily mute the microphone, an output channel selector switch to send the translation down the channel designated for the booth or an alternate pre-set Channel B, a CALL OPERATOR button to signal opera-

tor to engage the service channel which is inhibited if the interpreter's microphone is live, a SPEAK SLOWLY switch which activates a warning lamp on the chairman's unit and finally, a floor language loudspeaker and volume control which is automatically muted when a microphone is switched on in the booth.

User controls include channel fault indication if the channel frequency is not correct, modulation depth control, a loop drive ON/OFF switch to turn off the loop but not the transmitter, loop voltage and current meters, a rotary control to vary the loop current and a loop matching facility for matching the transmitter output the smaller loops. In a fixed installation, these controls are normally pre-set during commissioning and do not require further attention. In a portable system, they are necessary to enable maximum performance to be achieved.

The induction loop method of distribution enjoys advantages over other methods in that it involves a minimum of installation cost in large permanent facilities, primarily the cost of installing the loop. Advice should always be sought from the manufacturer when

SPEAKERS THAT GET THE MESSAGE ACROSS



AP SERIES

The world's most popular omni-purpose high efficiency loudspeakers for application with commercial sound, intercom, protective signaling and public address systems. Compact size, weatherproof construction, all-metal, baked epoxy finish. 15 or 30 watts power handling; wide angle, bi-directional or radial dispersion-emphasis; surface, recessed, flange mounting; built-in vari-tap for 70V. and 25V. line matching.



DR, BIA and CJ SERIES

Directional reflex sound projectors for uniform and controlled coverage, and optimum penetration over distance and ambient noise. Weatherproof, vibration-free construction. Sound dispersion options of 95°, 85°, 75°, 65°, and wide angle 120° x 60°. For use with all ATLAS SOUND compression drivers.

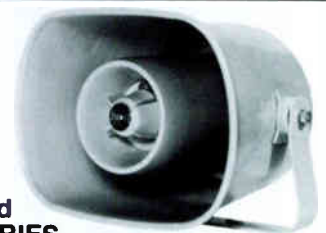

WR and WT SERIES

Re-entrant, element-resistant loudspeakers with extended frequency response ideally suited for music, intercom, and paging systems in recreational, commercial, industrial, church and educational facilities. All-metal, beige, housings harmonizing with outdoor and indoor surroundings. Choice of high efficiency 5, 10, 15 or 30 watts continuous power handling; integral line transformer-equipped models.

ATLAS SOUND, DIVISION OF AMERICAN TRADING AND PRODUCTION CORPORATION
10 POMEROY ROAD, PARSIPPANY, NJ 07054 • (201) 887-7800

82A

SHOP BI-TRONICS!

Now there are Custom-Fabricated Cable Assemblies for all your needs... from Bi-Tronics.

- For installations and replacement cabling—made to exact specifications on Sony, JVC, Panasonic, Ikegami and other equipment. Any quantity or length. *Fast turnaround.*
- For video, audio, data, telecommunications system applications.
- Plus full line of high quality cable, connectors, adapters and accessories in stock—for immediate delivery... at prices you like.
- MOGAMI superflexible and ultra-miniature cables. • Video camera, monitor and control • Microphone and snake •

CALL TODAY! 800-522-7377; in NY 212-585-1645 for engineering assistance and quotes plus catalog and price list. ALL FREE without obligation!

The One-Stop Cable Shop.
Our 19th Year!



BI-TRONICS, INC.
Box 125, Tuckahoe, NY 10707

Reader Service: #288

designing a loop to guarantee the best configuration for a particular enclosure. In any event, in installations where the seating is not fixed, it would be necessary to use a distribution method other than a cabled system.

This leads us to the third method which is the most recent development in the area of language distribution, infra-red FM transmission. In this type of system, the composite FM multiplexed signal is routed from the transmitter via a co-axial cable to a number of radiator panels mounted along the walls or ceiling of the enclosure. These panels emit the radiation which is detected by an IR receptor on the receiver which effectively replaces the antenna in an induction receiver.

The biggest advantage of an infra-red transmission system is its portability. Radiators can be moved and set up in a reasonably short period of time and do not require the wiring used in multi-channel cabled or induction loop systems.

Disadvantages of this method include the susceptibility due to the IR content of natural sunlight or other thermal sources such as tungsten

lamps which also emit some infra-red in their spectrum. Also, they are basically line of sight devices which will not work if the receiver is placed in the pocket or the delegate is outside the radiation pattern of the panels.

One final component often incorporated into larger conference and SIT systems is electronic voting capability. By means of switches located on the delegate units, delegates can vote "yes," "no," or "abstain." The voting period is selectable from 90, 60, or 30 seconds and is automatically controlled by an integral countdown clock. If no time is selected, the period can be controlled manually. Voting may be "Open" whereby votes are continually updated or "Secret" where results are only displayed at the end of the period, when voting is finished. Individual votes are not disclosed and only final totals are shown.

As we approach the final decade of the 20th century we can see that great strides have been made toward increasing our ability to cross the barriers of language towards the goal of increasing communications and efficiency in world affairs. The opportunities which this presents to sound contractors, large and small, should not go unnoticed.

SPECIFY EXCELLENCE!

from the company who pioneered equalization

• ACTIVE AND PASSIVE EQUALIZERS

18 different Models to choose from

• REAL TIME ANALYZERS

Octave Band, one-third and one-sixth octave

• BI-AMP AND TRI-AMP CROSSOVERS

Low-level at any frequency and slope

• NARROW BANDWIDTH NOTCH FILTERS

Control of room feedback and ring modes

• CUSTOM FILTERS FOR AUDIO APPLICATIONS

High-pass low-pass band-pass notch

SEND FOR OUR COMPLETE PRODUCT CATALOG

White

Instruments Division of C Van R Inc.
P.O. BOX 698
AUSTIN, TX 78767
(512) 892-0752
TELEX 776409 WHITE INST AUS

THEORY & APPLICATION

(continued from page 12)

distorted, "harmonics" (also known as "overtones" of the original signal, called the fundamental) are produced which are on frequencies that are whole number multiples of the original signal frequency. The signal at twice the original frequency is called the second harmonic; at three times, the third harmonic, etc. All of these harmonics added together are called the total harmonic distortion (THD). Harmonic distortion is closely related to the overtones produced by musical instruments.

Intermodulation distortion comes from a different kind of electronic or physical imperfection, and produces new signals on frequencies which are the sum or difference of the original signal frequencies. Since these new frequencies are not harmonically related (and thus not musical) this form of distortion sounds very unnatural and is much more irritating than harmonic distortion.

SERVICING TODAY

(continued from page 38)

troubled board ourselves. Basically, they call us up and tell us what piece went down over the phone and we immediately ship out a replacement. Then they ship us the damaged piece back and we fix it while their system is back up and working. It eliminates down time while we fix it.

"Customer service can often make the difference in a sale. It's like buying a car, you may find the same car a few hundred dollars cheaper across the street, but you'll drive to the other side of town if you hear he has better service. Often, we can work closely with sales as a sales contact. We get very little walk-in business, though we do a lot of prime installations. When these companies have relationships with us that they are happy with, such as good service, they can come back with future needs."

While Tony Leto, president of Sound & Signal Systems in Tampa, FL, feels it has been years since his people have really made field repairs. "The days of changing tubes are long gone," he said, adding that modular construction and removable PC boards have simplified the repair process.

"The business itself hasn't really changed that much over the years, though the technology has," he said. "You have to be able to service whatever comes along, and we've had to change people at times to keep up. Also, you need more sophisticated equipment."

He said replacement of bad circuits is still the main idea, once they've been located. But, today it is often less expensive to replace the entire unit.

"That is the case more and more. But in a lot of the more sophisticated equipment, the cost of a single chip or PC card is insignificant to the overall cost of the unit. That's not so in most products under \$100. It doesn't pay to fix them. And today you can't afford too much down time or too much time looking for the problem. You can't justify a lengthy search while your customer's system is down," Leto said.

"Service really isn't a major part of our business. That is, we wouldn't survive on service alone if it weren't for all the new contracts we get. The knowledge that we're going to stand behind a system once we install it, and that we can keep it operational pays off in increased new business."

Leto agreed with Hessing's observation that computer technology can be a double-edged sword. The same technology which simplifies old functions, adds new complexity as it adds new system capabilities. Leto said that this often negates the increase of reliability as systems have more opportunities to go awry.

"Just like everything else, sophisticated systems today have so many more parts and pieces that could malfunction, it just increases the odds. I would have to say that on this level, reliability has actually deteriorated in recent years."

—Elliot Luber

SUBSCRIBE TO *SOUND &* **COMMUNICATIONS**

Keep abreast of this
changing business

Every Month.

**It's Not Just
A Magazine,
It's An Industry!**

SOUND SHAPERS

By
ROSS
SYSTEMS

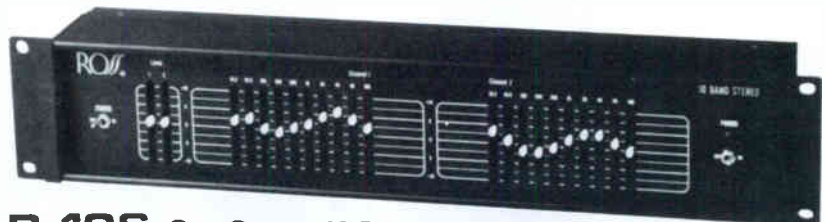

R-10S -One Octave 10 Band Stereo Graphic **\$189.95**



R-15S - $\frac{2}{3}$ Octave 15 Band Stereo Graphic **\$199.95**



R-31M - $\frac{1}{3}$ Octave 31 Band Mono Graphic **\$199.95**

Ross presents the "Sound Shaper Series." Three precision equalizers which give you total control of your sound reinforcement needs.

"The Quality Line at an Affordable Price"



P.O. Box 2344 FORT WORTH, TEXAS 76113 (817) 336-5114
A DIVISION OF INTERNATIONAL MUSIC CO.

Reader Service #210

DATE BOOK

DATE	EVENT/COMMENT	LOCATION	CONTACT
September 26-27	Sound Engineering Seminars Two-Day Seminar in Audio and Acoustics by Syn-Aud-Con.	Ramada-The O'Hare Inn Chicago, IL	Synergetic Audio Concepts Don Davis (714) 728-0245
September 30-October 1	Electronic Sound & Systems Conferences, Inc. Regional educational conference and product exhibit sponsored by the NSCA and the ERA.	Michigan Inn Detroit, MI	ESSC Bob Barba (313) 781-2010 NSCA (312) 593-8360
October 1-2	National Telecommunications Educational Conference sponsored by NATA.	Denver, CO	John Buescher (202) 296-9800 Adam Kernan-Schloss (202) 887-5900
October 1-2	Sound Engineering Seminars Two-Day Seminar in Audio and Acoustics by Syn-Aud-Con.	Cleveland Airport Marriot Cleveland, OH	Synergetic Audio Concepts Don Davis (714) 728-0245
October 3-4	Electronic Sound & Systems Conferences, Inc. Regional educational conference and product exhibit sponsored by the NSCA and the ERA.	Ramada-The O'Hare Inn Chicago, IL	ESSC Bob Barba (313) 781-2010 NSCA (312) 593-8360
October 10-11	Sound Engineering Seminars Two-Day Seminar in Audio and Acoustics by Syn-Aud-Con.	The Hilton at Harmon Meadow, NY	Synergetic Audio Concepts Don Davis (714) 728-0245
October 14-17	The 79th Audio Engineering Society's Convention	New York, NY	Ann Smythe (212) 661-2355

GO WITH THE PRO!



The DM 1900 is Numark's top-of-the-line stereo audio mixer: an easy to operate studio quality console with built-in six band equalizer, designed to meet every professional need.

Its outstanding features include complete front-panel operation, a fast-acting 12 segment, multi-colored peak reading LED output meter and easy mixing of sound-on-sound recordings for making video and movie sound tracks. There's a switchable sound processor loop facility for adding effects

devices. Three phono/one tape or two phono/two tape stereo capability. Independent left and right channel volume controls. The DM 1900 matches any power amplifier with its variable output selector. A two-position "talk over" switch provides smooth professional voiceovers. Easy-access headphone input comes with separate volume control.

The DM 1900 is available at select Numark Professional Products Division Dealers. **Suggested retail \$615.00.**

For more information about the DM 1900 or Numark's complete line of professional products, please write or call Paul Friedman, National Sales Manager.

PPD **Numark**
By Numark Electronics Corporation

503 Raritan Center, Edison, NJ 08837 • (201) 225-3222

TRUE EQUALITY

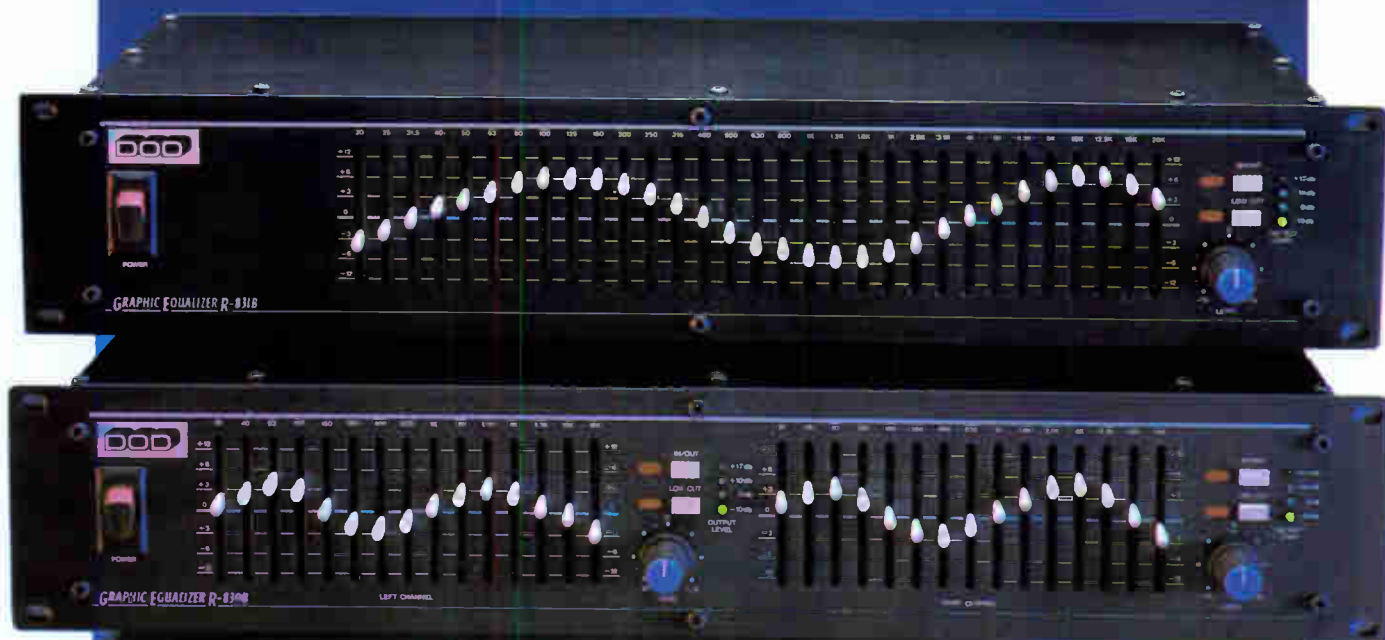

In the past, low price has often been equated with low quality. No longer!

DOD's R-830B and R-831B EQ's feature computer aided design, low noise, high slew rate, low distortion, and extremely accurate controls. Add to this DOD's low prices, and the result is two of the most popular EQ's on the market today.

- Modular PC board construction
- Center detented, linear potentiometers
- All metal chassis
- Four-level LED output indicators
- Low cut filter
- Bypass switch
- 12 dB boost or cut
- Signal to noise greater than 95 dB
- IM distortion less than 0.01%
- One year warranty

If you haven't yet discovered the true equality, you owe yourself a visit to your nearest DOD dealer for a demonstration.



5639 South Riley Lane Salt Lake City, Utah 84107 Telephone (801) 268-8400

CLASSIFIEDS

FOR SALE
Phillips M30 5 masters,
outlets, central cabinet.
Call Chico (608) 274-3003.

Reader Service #201

BUSINESS WANTED

Own own business, would like to expand by purchasing a sound communication company in the New York, New Jersey or Connecticut areas. I have been in this type business and active for the past thirty years. I possess a heavy background in managerial leadership, sales with technical ability. Will furnish a good down payment. If interested write to: P.O. Box 129, Garnerville, NY 10923

Reader Service #202

Current Cable Company, Inc.

1801 W. Diversey Parkway
Chicago, IL 60614
Suppliers of quality sound, intercom
and telephone cable.

For Prompt service call Toll Free

1-800-821-2432

In Illinois: 312-472-7790

Reader Service #203

Background Music for SCA-CATV-Telephone DCM INTERNATIONAL

A Division of
F. T. C. BREWER COMPANY
P.O. Box 8057
Pensacola, Florida 32505
904 433-7932

Reader Service #204

RJ31X JACKS & CORDS

from
cabletronix
800-432-WIRE
(Nationwide)
800-942-WIRE
(New York State)

in stock now!
WIRE & CABLE
UL-PLENUM-FIRE
"B" CONNECTORS
TIE WRAPS
DRIVE RINGS & PINS
ARROW STAPLERS
FASTENERS
toll free
call today

Reader Service #205

TIME SAVERS

MUSIC SUPPLY CO. - SC
800 N. MADISON

- PUSH-PULL RODS Get Cable through tight places.
 - TEST-SET. For the Audio Serviceman
 - EASY-KARY™ Wire Reel Holders - 3 sizes
 - SPEAKER SUPPORT TRUSS (T-Bar Bridge)
Prevent ceiling sag. Speed Installation.
 - SPEAKER GRILLES For 8" Speakers
 - EXTENSION CORDS 3 ft. and 10 ft. U.L. Listed
- CALL - WRITE - 30 DAY FREE TRIAL
Tex. Call Collect (214)946-8450, All Other 1-800-527-1522

DALLAS, TEXAS 75208

INSTALLATION & SERVICE AIDS

Reader Service #206

FREE 32pg Catalog & 50 Audio/Video Applc.

PWR SUPP. EQ.
PHONO. MIC.
TRANS. A.C.M.
TAPE, VIDEO,
LINE, OSC

Stereo Mono Pur Ampl.
8-in 2-out, 12-in 4-out, 16-in 4-out
Video & Audio Dist Amps
TV Audio & Recd Prod Consoles

OPAMP LABS INC (213) 934-3566
1033 N Sycamore Av LOS ANGELES CA, 90038

Reader Service #207

10rum Street Teaksbury Mass 01876
Tel (617) 851-6544

Manufacturers of quality sound & communications cable.
Stock & price list mailed on request

Reader Service #208

CLASSIFIEDS

- Regular Classified — \$52 per column inch.
- Marketplace Display — 25 percent off rate card (up to 1/3 page).

Classified listings are accepted up to the 25th of the month preceding publication.

Name _____

Address _____

City _____ State _____

Zip _____ Telephone _____

Credit Card # _____

Check Heading You Want

- SERVICES
- MISCELLANEOUS
- FOR SALE
- SITUATIONS WANTED
- FOR RENT
- BUSINESS OPPORTUNITIES
- HELP WANTED

Please send copy & payment to:

Sound & Communications Classifieds
220 Westbury Avenue Carle Place, New York 11514
TELEPHONE: (516) 334-7880



SESCOM, INC.
1111 Las Vegas Blvd. North
Las Vegas, NV 89101 U.S.A.

"the audio source" FOR ALL OF YOUR AUDIO NEEDS
CALL OR SEND FOR A COPY OF OUR CATALOG
CATALOG REQUESTS & ORDERS: (800)834-3457
OTHER BUSINESS: (702)384-0993 TWX (810)397-8998

Reader Service #209

POSITIONS



GULFTRONICS, INC.
ELECTRONIC SYSTEMS CONTRACTORS

SALES ENGINEER

Houston-based alarm & communication systems contractor seeks experienced individual to market fire alarm, school & healthcare communications, CCTV & related electronic systems. Edwards & Rauland distributor. Attractive compensation plan includes draw against commissions, fringe benefits & car allowance. Responsibilities include calling on specifying engineers, electrical contractors & end users. Interested career-oriented individuals should submit a detailed resume including salary history to:

GULFTRONICS INC.

8520 Sweetwater, Suite F-55
Houston, TX 77037

All inquiries will be held in strict confidence.

Reader Service #210

THE BLUE BOOK

Sound & Communications is not just a magazine, it's an industry.

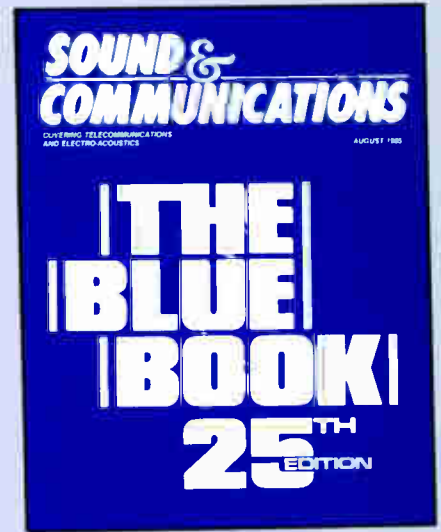

The Best Editorial . . .

The team of Chris Foreman, Editorial Director, Jerry Brookman, Editorial Consultant, Elliot Luber, Managing Editor and Nancy Peterson, Assistant Editor, supported by a staff of over 30 people have the **RESPECT** of every important writer and reader in this business.

The Best Graphic Design . . .

Compare for yourself. The All-New Sound & Communications not only **LOOKS BETTER** than ever, it is the best designed, most colorful magazine in this market today.

The Most Important Readership . . .

Let's stop kidding around now, we know there aren't 20,000 people in the sound and/or video contracting industry. Not unless we start sending "free," "unrequested" copies to every recording studio, production house, electrical contractor and distant relative we know.

Remember . . . we also are the publishers of **Pro Sound News**, **The Daily** for the AES, **Music & Sound Output**, and **The Music & Sound Electronics Retailer**, so if we wanted to, we could send **Sound & Communications** to over 40,000 people . . . but why, if they are not qualified customers.

Sound & Communications remains the only magazine whose circulation is **PAID, TOTALLY REQUESTED**, and **QUALIFIED**.

The Most Important Issue In This Industry

The 25th Edition of the **Sound & Communications Blue Book**, a complete sourcebook of products, suppliers and manufacturers.

It is **The Purchasing Directory** for the entire Sound Contracting Community.

To buy additional Blue Book copies, at \$10 each, contact:
Circulation Department
Sound & Communications
220 Westbury Ave.
Carle Place, NY 11514
(516) 334-7880

**SOUND &
COMMUNICATIONS**

For advertising information call Cliff Capone,

(516) 334-7880

PRODUCT INDEX

Alarm, Security & Life-Safety	
Systems.....	6
Antenna Systems	9
Apartment House/Hi-Rise	
Intercoms.....	9
Audio Amplifiers	11
Audio Signal Processors.....	15
Audio Visual Equipment &	
Systems	18
Background/Foreground Music	
Systems	19
Bells, Buzzers, Gongs	21
Cabinets & Consoles	22
Church Carillons & Chimes.....	22
CCTV Systems & Products.....	23
Disco Systems & Supplies.....	24
Encoders & Decoders	25
Engineered Sound Systems.....	25
Hardware & Tools	29
Headphones/Headsets	31
In & Out Registers	32
Intercom Systems—Institutional	33
Intercom Systems—Duplex.....	36

Intercom Systems—Simplex	37
Loudspeakers & Accessories	39
Magnetic Tape Systems &	
Supplies	45
Message Repeaters/Storecasters.	45
Microphones	46
Nurse-Patient Intercom Systems.	48
Paging Systems.....	50
Pro Audio Sound Systems/	
Portable Sound.....	53
School Communication Systems .	57
Sound Masking.....	59
Telephone Systems—Keyphones	60
Telephone Systems—PBX.....	61
Telephone Systems Peripherals..	62
Telephone System Replacement	
Products.....	65
Test Equipment & Tools	65
Tuners	67
Used/Rebuilt Telephone	
Equipment.....	67
Wire & Cable	68
TRADE NAME INDEX	72

EVERY PRECAUTION HAS BEEN TAKEN BY THE EDITORS TO MAKE THIS DIRECTORY COMPLETE AND ACCURATE. THEY CANNOT BE HELD RESPONSIBLE FOR ANY OMISSIONS OR ERRORS IN LISTINGS.

THE PUBLISHER

MANUFACTURER'S INDEX

AB Systems.....	11, 15, 24, 39, 53
Accusonics Systems Corp.....	31, 39, 46
ACS Communications.....	31
ADC Telecommunications.....	29, 62
A.E. Electronics Corp.....	50
AES Corporation.....	6
Aiphone Intercom Systems.....	6, 9, 11, 25, 33, 36, 37, 40, 48, 50, 54, 57, 60
AKG Acoustics.....	15, 31, 46
Alarm Control Corp.....	6
Alarm Supply Co.....	6
Altec Lansing Corp.....	11, 15, 26, 40, 59
Alternative Telecom Corp.....	36
Altronic Co. Ltd.....	9
American Acoustics.....	40
American Zettler Corp.....	48
Amp Telecom.....	31
Anphenol Products.....	65
Amplivox Comm. Products/Security Intercom.....	9
Anixter Brothers Inc./Anixter Comm. Supply.....	9
The Antenna Specialists.....	9
Argos Products.....	18, 19, 26, 40, 50
ART.....	15, 26, 54
Ashly Audio.....	54
Astatic Corpa.....	46
ATC Supply.....	36
Atkinson Dynamics.....	33, 37, 50
Atlas Sound.....	6, 21, 40, 46
Audio Accessories.....	18
Audio ± Design/Calrec.....	15
Audio Environments Inc.....	19
Audiosears.....	31
Audio-Technica U.S., Inc.....	15, 31, 46, 54, 68
Audiovisual Systems.....	15
Audisar.....	11, 40
Auditel Systems.....	26
The Auth Company.....	6
Automation Devices Inc.....	59
Automation Electronics Corp.....	62
Auto Page.....	50
AVA Electronics & Machine Corp.....	30
Belden Electronics Wire & Cable.....	68
Floyd Bell Inc.....	62
Berk-Tek, Inc.....	68
BES.....	18, 40, 50, 54, 59
Beyer Dynamics.....	31, 46
BGM International.....	19
BGW Systems.....	11
Bi-Tronics Inc.....	68
Blonder-Tongue Labs Inc.....	9
Bogen.....	11, 19, 33, 37, 40, 46, 51, 58, 67
Bonneville Media Communications.....	12
Bose Corp.....	41, 54
Bozak, Inc.....	24
Brim Electronics Corp.....	30, 68
Bruel & Kjaer Instruments.....	65
Burlington Audio Tapes.....	45
Buscom Systems.....	25, 63
Business Communications Inc.....	67
Cabletronix.....	30, 68
Calrad Engineered Electronic Products.....	6, 12, 31, 46, 51, 65
Cal Switch & Signal.....	68
Canare Cable, Co.....	68
Capitol Background Music.....	26
Carver Corp.....	12
Caseco Background Sound.....	19
Ceac, Inc.....	63

Celestion Industries.....	41
Corwin Vega.....	54
Cetec Gauss.....	26, 41, 45, 54
Cetec Ivie.....	12, 15, 26, 65
Cetec Raymer.....	12, 19, 47, 51, 63, 66, 67
Cetec Vega.....	47
David Clark Company.....	31, 38
Clear-Com Intercom Systems.....	31, 33, 36
Clifford, Inc.....	6, 30, 63, 68
Columbia Scientific Inc.....	36
Command Communications Inc.....	60, 63
Communications Equipment Brokers.....	67
Communications Co.....	18, 33, 36, 38, 58, 66
Communications Equipment Co.....	6, 22, 26, 32, 33, 38, 49, 58
Communications Products.....	51
Communitron Corp.....	51
Community Light & Sound.....	27, 41, 54
Connecronics Corp.....	15, 68
Conquest Sound USA.....	68
Consolidated Electronics.....	9, 67
Contech Inc.....	63
Control Electronics.....	59
Controlonics Corp.....	27
Cornell Electronic Products.....	6, 9, 32, 33, 49, 58
CP Communications.....	33
Crest Electronics.....	49
Crest Electronics Inc.....	6, 23
Crown International.....	12, 47, 66
Current Cable Co.....	69
Daburn Electronics.....	69
Dacon Electronics.....	63
J.W. Davis & Co.....	12, 19, 23, 27, 33, 36, 41, 47, 49, 58, 59
dbx.....	15
Delta Communications.....	58
Delta Magnetics.....	27
Delta Wire & Cable.....	33, 69
DOD Electronics.....	54
DuKane Corporation.....	12, 16, 18, 19, 22, 36, 38, 49
Dynair Electronics.....	23
Dynamic Sound Industries.....	19, 51, 59
Dyna-Systems.....	59
Edeom, Inc.....	6, 12, 27, 41, 45, 49, 51, 58
Edeor.....	12, 16, 27, 47, 54
Eden Electronics.....	24, 27, 54
Edstan Doctor's Registers.....	32
Ektacom-Fisher Berkeley.....	9, 32, 34, 36, 38, 49
Elbex America.....	23
Electrical Conductors.....	69
Electro-Comm.....	6, 9, 49
Electronic Specialists.....	63
Electro-Voice.....	23, 27, 41, 47, 51, 54
Electro-Vox Industries.....	7
Eltrex International.....	16, 27, 45, 51
Emergency Products Corp.....	7
Emilar.....	41
EMS/Music.....	19
Encom Products.....	36
Engineered Electronics.....	49
Environmental Sound.....	27, 41, 55
Equipto Electronics.....	22
Eventide.....	16
Famous Telephone Supply.....	30, 51, 60, 61, 63, 69
Fane.....	41
Fanon.....	38
Faraday.....	7, 10, 21, 32, 34, 36, 38, 49
Florence.....	7, 10, 34, 49

Fourjay Industries.....	7, 41	Music Supply Co.....	30, 42, 66, 69	Siedle Intercom/USA.....	10, 24, 35, 39, 53, 59
FSR.....	23, 27, 55	Music Theatre Network.....	20	Siemens.....	62
Furnian Sound.....	16	Nady Systems.....	37, 38, 47	Signacorn Corp.....	53
Gai-tronics.....	51	Nakamichi USA.....	55	Simpson Electric Company.....	66
Galaxy Audio.....	55	National Electric Cable.....	69	Solid State Systems.....	62, 64
GBC Closed Circuit TV Corp.....	23	NEC America.....	52	Sonic Systems.....	44
Gemco Electronics.....	19	NEI (Neptune Electronics, Inc.).....	16	SonoMask Systems.....	60
Gencom Products.....	30	Neotek Corporation.....	22	Sony Corp—Pro Audio.....	56
General Electric.....	23	Non-Linear Systems.....	66	Sound-Craft Systems.....	14, 45
Gold Line.....	55	Norcon Electronics.....	34	Soundcraft Electronics.....	11, 56
Goldstar.....	60	North Supply Company.....	60	Sound Masters.....	39
Gollehon Industries.....	42	Nortronics Company.....	45	Soundolier.....	8, 21, 22, 35, 44, 50, 60
Gronimes Precision Electronics.....	12, 20, 27, 42, 51, 67	Numark Electronics.....	13, 16, 25, 31, 47, 55	Sound Powered Communications Corp.....	32, 35
Gyrr Products.....	45	Oaktron Industries.....	42	Sound Products/3M.....	14, 21, 39, 44, 46, 48
Hammond Manufacturing Co.....	22	O'Brien Partition Co.....	56	Spantel Corp.....	53
Harris Corporation, Dracon 20.....	22, 30, 42, 52, 63, 66	Omnimount Systems.....	30, 56	Speco Div. 8.....	14, 21, 35, 37, 39, 44, 48, 53, 59, 66, 67
Harris Digital Telephone Systems.....	61	Opamp Labs.....	14, 16, 24, 28	Spectra Sonics.....	71
Heil Ltd.....	13, 31, 47, 55	Orban Associates.....	16	Standard Wire & Cable.....	70
HM Electronics.....	36, 47	Otari Corporation.....	56	Stentofon Communications.....	35, 37, 39
House of Metal Enclosures.....	22	OWI Inc.....	20	Strom Electronics.....	59
Ideal Wire Products.....	69	Paladin Corp.....	31	Studer Revox America.....	56
IGM Communications.....	20, 45, 46	Panasonic Industrial Co.....	14, 24, 25, 56	Swintek.....	48
IMC.....	13, 25, 42, 55	Panasonic/Ramsa.....	56	Switchcraft.....	29
Industrial Research Products.....	13, 16, 28	Paramount Sound Systems.....	43	TAD.....	44
Information Dynamics.....	63	Pasc. Sound Products.....	10, 14, 25, 28, 34, 37, 39, 43, 47, 52, 58, 67	Talk-A-Phone.....	11, 35, 37, 39, 48, 59
Insul-Art Acoustics.....	59	Peavey Electronics Corp.....	56	Tamco Systems.....	18
ITT Data Equipment & Systems.....	34, 36	Pentagon Industries.....	20	Tape-Athon.....	21, 23, 46
ITT Pomona Electronics.....	30	Perma Power Electronics.....	28	TASCAM.....	17, 45, 57
ITT Telecom.....	60	P/H Electronics, Inc.....	18, 32	Tektone Sound & Signal.....	8, 11, 35, 39, 50
ITW Linx Communications.....	30	PHI Technologies.....	8, 20, 45, 46	Tele-Assemblies.....	64
Iwatsu America.....	60	Philips Microphones.....	43	Telecourier.....	53
Javelin Electronics.....	23	Phonic Ear.....	28	Teledial Devices.....	62, 64, 65
JBL Professional.....	13, 25, 28, 42	Plant Equipment Inc.....	61	Teledyne Thermatics.....	70
Jensen Tools.....	30	Plantronics.....	32	Tele-path Industries.....	61
Jeron Electronics.....	7, 10, 32, 34, 38, 50	Plat Luggage.....	66	Telephone Components.....	32, 35, 65
Johnson Electronics.....	13, 67	Precision Inc.....	60	Telephone Dynamics.....	64
King Wire & Cable.....	69	Premier Metal Products.....	22	Telephone Extension.....	65
Klark-Teknik.....	16, 55	Progressive Electronics.....	66	Telephone Sales & Service.....	11, 46
Knowles Electronics.....	47	Projected Sound Inc.....	43	Telephonic Equipment Corp.....	64
Komtek Communications.....	33, 34, 50	Protech Audio Corp.....	14, 17, 29, 52, 56, 60	Televox.....	24
Kulka Smith/Neutrik Products.....	30, 66	Pyle Industries.....	43	Telex Communications.....	14, 18, 29, 32, 48, 57
LCA Sales.....	7, 10, 23, 34, 42, 69	The Q Line Corp.....	43	Teltone Corporation.....	64
Lectrosnics.....	47, 55	QSC Audio Products.....	14	Tel-Tron.....	8
Lee Dan Communications.....	7, 10, 24, 34, 38, 50, 69	Quabbin Wire & Cable.....	70	TIE Communications.....	61, 62, 64
Lexicon.....	16	Quam-Nichols Co.....	43	TH Industries.....	64
Linear & Digital Systems.....	16	Radionics.....	33, 34, 64	TN Communications.....	35
Lowell Manufacturing.....	42	Ramko Research.....	56	TOA Electronics.....	14, 17, 29, 35, 37, 44, 48, 53, 57, 67
LT Electronics.....	34, 42, 52, 63	Rane.....	17, 56	Tone Commander Systems.....	62, 64, 65
Lyntec/Technical Visuals.....	16, 20	Rauland-Borg.....	29, 34, 50, 58	Toshiba America.....	61, 62
Maas-Rowe Carillons.....	22	Raytronics.....	39, 43, 50, 56, 58	Touchplate International.....	35
MacKenzie Labs.....	7, 18, 45, 46	Reach Electronics.....	52	TSI.....	18, 29, 59
M/A Com Cable Home.....	9	Remee Products.....	70	FW Comecorp.....	70
Magnasound.....	18	Renkus-Heinz.....	43	University Sound.....	8, 29, 44, 53
Magne-Tronics.....	20	Resco.....	31	Urei.....	14, 17, 25, 29, 44, 57, 60, 67
Mallory Capacitor Co.....	21	Ring Group of North America.....	35, 37, 39, 53, 58, 61, 64	Ursa Major Inc.....	17
Marlee Electronics.....	10	Ritron.....	64	Usatco.....	24
Marshall Electronics.....	69	RMI.....	20	Valeom Inc.....	22, 35, 44, 53, 61, 62, 65
McGohan Electronics.....	13, 20, 21, 52	RME Electronics.....	9	Valley People.....	17, 57
McMartin Industries.....	13, 20, 25, 52, 67	Roarwell.....	48	V-Band Systems.....	61
Meleo Labs.....	63	Rofu International.....	35	Vortex Corporation.....	18, 24, 29, 57
Metragen Ltd.....	31, 37	Ross.....	56	Vicon Industries.....	24
Metro Tel Corp.....	8, 63, 66	Round Bidnick & Assoc.....	14, 29	VIF International.....	21
MG Electronics.....	8, 20, 42, 52	Rowe International.....	21	Walker Telecom.....	61
Midwest Electronic Industries.....	13, 52	RTS Systems.....	17, 32, 35, 37, 39	Westell, Inc.....	64
Millbank Electronic Group.....	8, 13, 20, 28, 52, 58	Samson Products.....	48	Westpark Communications.....	24, 39
Mirtone Industries.....	8, 10	San Diego Sound & Communications.....	17	West Penn Wire Corp.....	70
Mitel, Inc.....	61	Sanming Electronic Sound Equipment.....	8, 44, 53	Wheelock Inc.....	22, 64
Modular Audio Products.....	55	Saxton Wire & Cable Products.....	70	Whelen Engineering.....	8
Modular Sound Systems.....	25, 28, 55	S.C.V. Inc.....	56	Bob White Associates.....	18, 25, 57
Monroe Electronics.....	25	Schulmerich Carillons, Inc.....	23	White Instruments.....	15, 17, 60, 67
Montgomery Mfg. Co. Inc.....	25	Security Intercom.....	10	Williams Sound Corp.....	29
Mountain West.....	8	Seeburg Music Satellite Network.....	21	Wireworks Corp.....	70
MTX Loudspeakers.....	42	Sennheiser Elec. Corp.....	32, 48	Workman Electronic Products.....	44
Multi-VOX Ltd.....	38	Sequential Circuits.....	17	Wren Company.....	65
The Music People.....	55	Sescom Inc.....	14	X-tel Corp.....	15, 36, 37, 53, 61, 62, 65
Music Programming.....	20, 52	Setcom Corporation.....	32	Yamaha International.....	57
		Shure Brothers Inc.....	14, 48	Yesco Foreground Music.....	21

ALARM, SECURITY & LIFE-SAFETY SYSTEMS

AES CORP., 285 Newbury St., P.O. Box 2093, Peabody, MA 01960 Tel.: 617-535-7310

President: Michael J. Sherman
Chief Engineer: Stanley P. Watts
Products: alarm and signal systems including supervised wireless systems, controls, annunciators, medical alert equipment, sirens, delay timers, test timers, power supplies, access control systems, and RF telemetry systems.

AIPHONE INTERCOM SYSTEMS, 1700 130th Ave. N.E., Bellevue, WA 98005 Tel.: 206-455-0510

President: Hiko Shinoda
Sales Manager: Jim Morrison
Chief Engineer: Jun Matsumoto
Products: industrial, business, residential, loudspeaking, telephone, video intercom/security systems with paging talk-back, six microprocessor systems available, mixer amplifiers, paging speakers, horns, drivers, ceiling speakers.

ALARM CONTROLS CORP., 19 Brandywine Dr., P.O. Box 280, Deer Park, NY 11729
Tel.: 516-586-4220

President: Howard Berger
Sales Manager: John Benedetto
Products: alarm controls, apartment alarms, remote station plates, power supplies, accessories.

ALARM SUPPLY COMPANY, INC., 12551 Globe Rd., Livonia, MI 48150 Tel.: 313-591-9100

President: Mike Sliman
Sales Manager: Jim Granowicz
Chief Engineer: Mike Crumley
Products: burglar and fire alarm equipment, CCTV, and automotive security. Catalog available.
District Offices:
1033 State Parkway, Schaumburg, IL 60195
3912 Shirley Dr., S.W., Atlanta, GA 30336
7819 N.W. 15th St., Miami, FL 33126
2550 Blvd. of Generals, Valley Forge, PA 19403

ATLAS SOUND, 10 Pomeroy Rd., Parsippany, NJ 07054 Tel.: 201-887-7800

Vice President, Marketing: Herbert M. Jaffe
National Sales Manager: David A. Chambers
Chief Engineer: Bob Greulich
Products: U.L.-listed re-entrant loudspeakers for indoor and outdoor installation in conjunction with life-safety, fire alarm signaling, audio detection and communications systems.
See full listings under **Loudspeakers & Accessories**.

THE AUTH COMPANY, 505 Acorn St., Deer Park, NY 11729 Tel.: 516-667-9000

President: Michael Gioseffi
Sales Manager: John R. Charczuk
Chief Engineer: Michael Marro
Products: intercom, nurse call, fire alarms, telephone access intruder, all needs for the multihousing market.

CALRAD ENGINEERED ELECTRONIC PRODUCTS
819 No. Highland Ave., Los Angeles, CA 90038
Tel.: 213-465-2131

President: Joseph Shupper
Vice President: Robert Shupper
Sales Manager: Fred Crown
Chief Engineer: Wes Black
Products: microphones, headphones, public address amplifiers, power supplies, speakers, connecting cables, telephone accessories, potentiometers, connectors, switches, meters, control knobs.
See full listing under **Audio Amplifiers**.

CLIFFORD INC., 83 Main St., Bethel, VT 05032
Tel.: 800-451-4381 Toll Free, 802-234-9921 Collect

President: Richard L. Huntley
Sales Manager: Martha McKinney
Products: UL-labeled cables and wires per NEC including air plenum cables and wires. Accessory cable materials (terminals, connectors, etc.) also furnished.

COMMUNICATIONS EQUIPMENT CO., INC.
6443 Western Ave., Glen Arbor, MI 49636
Tel.: 616-334-3081

President: Hugh I. Morris
Sales Manager: Thomas A. Garmhausen
Products: audio surveillance systems, detecting and locating crashes, screams, etc. in public buildings, parking garages, penal institutions. Large rack-mounted systems for station capacities in 25-station increments; smaller units in 5-station increments. Intercom and all-call features.
See full listing under **Engineered Sound Systems**.

CORNELL ELECTRONIC PRODUCTS, INC., 4911 W. Good Hope Rd., P.O. Box 23411, Milwaukee, WI 53223 Tel.: 414-351-4660

President: Donald J. Glaubitz
Vice President, Engineering: Gary Butler
Sales Manager: Pauline Haack
Products: audio-visual nurse-call systems and door security systems. Apartment intercom systems. In-and-out registers. Institutional intercom systems. Printer/recorder systems.
See full listing under **Nurse-Patient Intercom Systems**.

CREST ELECTRONICS, INC., 4921 Exposition Blvd., Los Angeles, CA 90016
Tel.: 213-731-1105

President: Hope Borows
Sales Manager: Dennis Castelli
Chief Engineer: Ken Fukui
Products: CCTV cameras, video monitors, time lapse recorders, modulators, lenses, switchers, housings, mounts, tubes, pan and tilts, scanners, dummy cameras, quad split-screen systems.
See full listing under **CCTV Systems & Products**.

EDCOM, INC., 755 Center St., Lewiston, NY 14092-0506
Tel.: 716-754-7130

President: J. D. Breedon
Sales Manager/Vice President Marketing: James K. Wood
Director of Engineering: Peter Jova
Products: fully supervised amplifier and line surveillance systems for industrial installations, automatic announcement machines, tape and digitized speech, zone selection, choice of 15 tone generator modules.
See full listing under **Engineered Sound Systems**.

ELECTRO-COMM SYSTEMS INC., 7915 N. 81st St. Milwaukee, WI 53223 Tel.: 414-354-0202

President and Chief Engineer: Angelo Balistreri
Sales Manager: Jim Ippolite
Products: audio and audio-visual nurse-call systems, door-monitoring devices, apartment intercoms and personnel registers. Emergency call systems for nursing homes and housing for the elderly; custom signaling and communications systems.

ELECTRO-VOX INDUSTRIES, INC. (Santel Group),
2626 Bates Rd., Montreal, Que. H3S 1B2
Tel.: 514-731-3771

President: D. Lafreniere
Sales Manager: G. Senechal
Engineering: A. Dorion
Products: voice-alarm systems, all-transistorized school, industrial, commercial sound and hospital systems; intercoms, transistorized amplifiers 5 to 230 watts; apartment intercom.



FIRE PRODUCTS

EMERGENCY PRODUCTS CORPORATION

EMERGENCY PRODUCTS CORP., 10 Bloomfield Ave., Pinebrook, NJ 07058
Tel.: 201-882-8010 1-800-631-8054

President: Joel Cohen
Sales Manager: Howard M. Avin
Chief Engineer: Tom DeLalla
Products: full line of quality fire alarm products to service the sound industry from basic systems to sophisticated.

District Offices:
Bidwell Sales Assoc. of Arizona, 2329 E. Jasmine, Mesa, AZ 85203
Bidwell Sales Associates, 443 East Alondra Blvd., Box 2160, Gardena, CA 90247

Bi-State Marketers, Inc., 753 Bergen Blvd., Ridgely, NJ 07657
Chuck Olson Associates, 17003 S. E. 136th St., Renton, WA 98056
Henry W. Phillips Co., Inc., 110 Mansell Circle, Roswell, GA 30075
Henry W. Phillips Co., Inc., 6909 Holly Court, Matthews, NC 28705
Silver Peak Marketing, Ltd., 2700 Youngfield, Suite 100, Lakewood, CO 80215

W. B. Pray Sales, Inc., 362 Davis St., Box 691, No. Borough, MA 01532
Warren Associates, 2338 Calle Del Mundo, Santa Clara, CA 95050
Burcaw Sales & Associates, 30642 Dequindre St., Warren, MI 48092
William M. Linz Assoc., Inc., 821 Skokie Blvd., Northbrook, IL 60062

Unirep, Inc., Box 16876, Ft. Lauderdale, FL 33318
Unirep, Inc. (Ship To), 7481 N.W. 7th Court, Plantation, FL 33317
Unirep, Inc. (Branch Office), 3306 Little Road, Valrico, FL 33594
Graham/Davis, Inc., 22410 Provincial Blvd., Katy, TX 77450
Graham/Davis, Inc., 1610 North 135, Suite 213, Carrollton, TX 75006

Nevco, Inc., Suite 221, 2701 Rockcreek Pky., N. Kansas City, MO 64117

Nevco, Inc., 10132 Glenfield Terrace, St. Louis, MO 63126
Forti Associates, 3519 Ragmoor Road, Kensington, MD 20895
Kingston Sales Corp., 6115 N. Guion Road, Indianapolis, IN 46254
RW Sales, 1563 Como Avenue, St. Paul, MN 55108

FARADAY, INC., 805 S. Maumee St., Tecumseh, MI 49286
Tel.: 517-423-2111

President: G. Rummel
Sales Manager: J. Frankow
Chief Engineer: R. Miller
Products: intercom & sound distribution systems, public address systems, nurse call systems, fire alarm, annunciator, clock and hospital life safety systems, full range of signaling products.

District Offices:
Standard Electric Time (unit of Faraday), 4740 N. Austin Ave., Chicago, IL 60630

Standard Electric Time (unit of Faraday), 15721 Texaco Ave., Paramount, CA 90723

Standard Electric Time (unit of Faraday), 357 Cottage St., Springfield, MA 01104

Standard Electric Time (unit of Faraday), 193 Fairfield Rd., Fairfield, NJ 07006

Standard Electric Time (unit of Faraday), Bldg. 11, Suite 101, 3569 Bristol Pike, Bensalem, PA

Standard Electric Time (unit of Faraday), 360 West Office Bldg., 7206 Hull St. Rd., Richmond, VA

Standard Electric Time (unit of Faraday), 1485 Bayshore Blvd., San Francisco, CA 94124

Standard Electric Time (unit of Faraday), 100 Decker Court, Suite 280, Irving, TX

FLORENCE CORPORATION, 2101 N. Elston Ave., Chicago, IL 60614
Tel.: 312-384-3310

President: Lloyd A. Schooley
Vice President & General Manager: John Martino
Sales Manager: George Jans
Chief Engineer: Ray Cozzens
Vice President/Sales: Don Cannella
Products: designers and manufacturers of nurse calls, emergency calls, mail boxes and apartment communication systems.

FOURJAY INDUSTRIES, INC., 2801 Ontario Ave., Dayton, OH 45414
Tel.: 513-278-9416

President: J. M. Fulkerson II
Director of Sales: M. W. (Bud) Frawley
Products: ceiling white recessed baffles, time-saving baffle mounting devices, protective covers, wall baffles and music speakers. Horn speakers for paging/talkback, intercom, telephone and security systems.

JERON ELECTRONIC SYSTEMS, INC., 3554 N. Clark St., Chicago, IL 60657
Tel.: 312-528-4020, 800-621-1903

President: Jerome Chesnul
Sales Manager: David Hayes
Products: Visual and audio-visual emergency call systems for apartments, elderly housing.. Door surveillance systems. Tenant controlled security. Nursing home, hospital, institutional, dormitory communications and signaling systems.
See full listing under **Apartment House/Hi-Rise Intercoms.**

LCA SALES CO., 76 Main St., Tuckahoe, NY 10707
Tel.: 914-961-4700 800-522-7377 (Outside NY)

President: Joel H. Schwartz
General Manager: R. R. Sherwood
Products: manufacturers' representatives for: Blonder-Tongue, BES, Carol Cable, Easton/Dekor, Centex, Harrington, M/A-Com Video/Data, N.I.T., Panasonic CCTV, Reliable Security, Siedle, University, Videoscope/QuadraVision.
District Offices:
Steve Keech, C-320 Media Sta., Media, PA 19063
Brian K. Dolan, 8709 Second Ave., Silver Spring, MD 20910
James Johnson, Rte. 3, Box 106, Front Royal, VA 22630

LEE DAN COMMUNICATIONS, INC., 155 Adams Ave., Hauppauge, NY 11788
Tel.: 516-231-1414

President: Leon Goldberg
Sales Manager: Lawrence J. Goldberg
Chief Engineer: Ted Jurgens
Products: audio/visual communications systems providing effective security with our DS-100 door-sentry intrusion annunciators. Tek-Care emergency call systems for health care facilities.
See full listing under **Apartment House/Hi-Rise Intercoms.**

MACKENZIE LABORATORIES, INC., 5507 Peck Rd., Arcadia, CA 91006
Tel.: 818-579-0440 800-423-4147

President: A. R. Taylor
Chief Engineer and Vice President: N. Khattar
Products: solid-state digital audio message repeaters for life safety, voice evacuation and security applications. UL component recognized.
See full listing under **Magnetic Tape Systems & Supplies.**

METRO TEL CORP., 15 Burke Lane, Syosset, NY
11791 Tel.: 516-364-3377

President: Venerando J. Indelicato
Sales Manager: Phil Johnson
Chief Engineer: Bob Grastataro
Products: tel aid emergency dialing system with tone or taped message source capability.

MG ELECTRONICS, 32 Ranick Rd., Hauppauge,
NY 11787 Tel.: 516-582-3400

President: Louis Maltz
Vice President: Elliott Maltz
Sales Manager: Stan Grey
Products: full line of paging speakers and electronic sirens 5"-12" for P.A. and security applications.

MILLBANK ELECTRONICS GROUP LTD., Bell-
brook Industrial Estate, Uckfield, Sussex,
TN22 1QL England Tel.: Uckfield 825-4811

Chairman and Marketing Director: Tony Walker
Director and General Manager: Brian Evans
Director C.T.S.D. Systems: Bernard Skinner
Engineering Manager (Sales): Doug Edworthy
Products: custom engineered sound systems; public address, tele-conference, life-safety. Sound reinforcement systems: amplifiers, pre-amplifiers, background music, FM/AM tuners, alarm and tone signal generators, loudspeakers, microphones.
See full listing under **Engineered Sound Systems**.

MIRTONE INDUSTRIES LTD., 2225 Kenmore Ave.,
Tonawanda, NY 19207 Tel.: 716-875-0600

President: Tony Falbo
Vice President Sales and Marketing: B. Ruscoe
Director of Communications: R. Brighty
Director of Engineering: L. E. Eisner
Products: fire alarm and fire fighters' communication systems, apartment and industrial intercom, home radio intercom, paging and background music, and security systems.
District Offices:
Los Angeles, Chicago, New York, Vancouver, Edmonton, Calgary, Winnipeg, London, Montreal.

MOUNTAIN WEST 4215 N. 16th St., Phoenix, AZ
85016 Tel.: 602-263-8831

President: Richard Schultz
Marketing Manager: Jeanne Barry
Products: burglar and fire security alarm systems, parts and supplies. Professional quality systems for business, industry, homes, government.

PHI TECHNOLOGIES, INC., 4605 N. Stiles, Oklahoma
City, OK 73105 Tel.: 405-521-9000

President: Henry E. Juskiewicz
Sales Manager: Gary A. Zebrowski
Chief Engineer: Larry Debell
Products: heavy-duty cassette tape transports, random-access message systems, cassette playback units for background music, message repeaters and digital audio message systems.

**SANMING ELECTRONIC SOUND EQUIPMENT CO.,
LTD.**, 12715 Western Ave., Garden Grove, CA
92641 Tel.: 714-891-2252

President: Hugh C. Hsieh
Sales Manager: Leon C. Hsieh
Chief Engineer: S.W. Hsu
Products: 60 watt and 100 watt siren speakers for emergency vehicles and stations; 10 watt, 15 watt and 30 watt siren speakers for security systems; 15 and 30 watt paging horns for voice transmission.

SOUNDOLIER, 9380 Watson Industrial Park, St. Louis,
MO 63126 Tel.: 314-962-9870

Vice President/Director of Marketing: Herbert M. Jaffe
Director of Sales: Paul Grote
Chief Engineer: John Saller
National Sales Manager: Tony Dalba
Products: high quality, commercial sound loudspeakers, enclosures and accessories for music, alarm and public address systems, baffles for ceilings and walls, matching transformers and backbox enclosures.
See full listing under **Loudspeakers & Accessories**.

SPECO DIV., (Components Specialties, Inc.)
1172 Rt. 109, P.O. Box 624, Lindenhurst, NY
11757 Tel.: 516-957-8700 (in NY)
1-800-645-5516 (outside NY)

President: Louis W. Keller
Vice President: Stan Hulkower
Chief Engineer: James Ganci
Dir. Sales and Marketing: Mel Hulkower
Products: PA horns, amplifiers, tuners, loudspeakers, wall baffles, speaker assemblies, outdoor speakers, sound columns, ceiling grilles, transformers, L-pads, attenuators, accessories, microphones, intercoms, alarm sirens, multitestors, oscilloscopes.

TEKTONE SOUND & SIGNAL MFG., 1331 S. Killian
Dr., Lake Park, FL 33403 Tel.: 305-844-2383

President: M. Mira
Sales Manager: Carlos Mira
Chief Engineer: J. Switzer
Products: intercom systems for home, apartment, commercial/industrial, institutional—telephone, loudspeaking and door answering. Nurse call, security/alarm and AM/FM radio intercom systems.
See full listing under **Apartment House/Hi-Rise Intercoms**.

TEL-TRON (Div. Radio Manufacturers Inc.), 220
Fentress Blvd., Daytona Beach, FL 32014
Tel.: 904-255-1921 800-874-5622

President: N. Rick Dawson
Sales Manager: Herman Dawson
Products: electronic systems for the hotel industry; room status, energy saving systems, message waiting, T.V. theft alarm, central smoke detector systems.

UNIVERSITY SOUND (Altec Div.), 10500 W. Reno
Ave., Oklahoma City, OK 73126
Tel.: 405-324-5311

President: F. Davis Merrey
Sales Manager: David Jetzke
Vice President, Marketing: Gary Rilling
Products: complete line of horns, drivers, speakers, mounting and transformer accessories.
See full listing under **Loudspeakers & Accessories**.

WHELEN ENGINEERING CO., INC., Rte. 145,
Winthrop Rd., Chester, CT 06412
Tel.: 203-526-9504

President: John F. Olson
Sales Manager: Howard Berke
Products: complete line of audible and visual alarm devices. High powered electronic outdoor siren and public address systems.

ANTENNA SYSTEMS (CCTV, ETV, MATV)

ANIXTER BROTHERS, INC./ANIXTER COMMUNICATIONS SUPPLY, 4711 Golf Road, Skokie, IL 60076 Tel.: 312-677-2600

President (Anixter Brothers, Inc.): John Pigott
President (Anixter Communications Supply): John Egan
Products: total inventory for MATV, SMATV, MDS, STV industries.
District Offices:
321 Richard Mine Road, Wharton, NY 07885
4303 Pleasantdale Road, Atlanta, GA 30340
1401 Morse Ave., Elk Grove, IL 60007
1400 Allec St., Unit C, Anaheim, CA 92805
4650 Lake Forest Drive, Blue Ash, OH 45202

THE ANTENNA SPECIALISTS CO., 12435 Euclid Ave., Cleveland, OH 44106 Tel.: 216-791-7878

President: Robert G. Paul
Vice President Sales: L. H. Kline
Chief Engineer: Dale Horn
Products: radio communications antenna systems and electronic emergency personnel alerting devices.

BLONDER-TONGUE LABORATORIES, INC., 1 Jake Brown Rd., Old Bridge, NJ 08857 Tel.: 201-679-4000

President: Ben H. Tongue
Sales Manager: Glenn H. Tongue
Chief Engineer: Ben H. Tongue
Products: complete line of SMATV equipment to meet a wide range of individual requirements. CATV equipment, complete line of TV modulators. Off premises pay TV line.
District Offices:
Glenn Stawicki, Blonder-Tongue Labs, 1 Jake Brown Rd., Old Bridge, NJ 08857
George Freeman, Blonder-Tongue Labs, 1 Jake Brown Rd., Old Bridge, NJ 08857
Charles Fitzer, 981 DeCaen Ct., Livermore, CA 94550
Ed Curreri, 9435 Gale Crest Drive, Cincinnati, OH 45231

CONSOLIDATED ELECTRONICS, 20 Celestial Way, #205, Juno Beach, FL 33408 Tel.: 305-626-1126

President: Leonard L. Jezorek
Products: antenna systems, tuners, etc.

M/A-COM CABLE HOME GROUP, 1375 Lenoir Rhyne Blvd., P.O. Box 1729, Hickory, NC 28601 Tel.: 800-438-3331

President: Frank Drendel
Executive Vice President Marketing and Sales: E.S. "Bill" Barbour
Executive Vice President Operations and Engineering: Larry Nelson
Products: compression molded fiberglass satellite antennas for home and commercial applications. Full selection from small DBS to 6,8,10,12 feet sizes. Individual components, reflectors, mounts, feeds, receivers, LNA's, polarizers. Complete operating systems.

RMS ELECTRONICS, INC., 50 Antin Place, Bronx, NY 10462 Tel.: 212-892-6700

Chairman of the Board: Arthur A. Fink
Sales Manager: Seymour Goldberg
Chief Engineer: Gunther Diefes
Products: systems equipment for MATV, CATV, CCTV including passive and active devices, antennas, hardware, hook-up cables, video accessories.

APARTMENT HOUSE/ HI-RISE INTERCOMS

AIPHONE INTERCOM SYSTEMS, 1700 130th Ave. N.E., Bellevue, WA 98005 Tel.: 206-455-0510

President: Hiko Shinoda
Sales Manager: Jim Morrison
Chief Engineer: Jun Matsumoto
Products: industrial, business, residential, loudspeaking, telephone, video intercom/security systems with paging talk-back; six microprocessor systems available, mixer amplifiers, paging speakers, horns, drivers, ceiling speakers.

ALTRONIC CO. LTD., 1390 Sherbrooke St. W., #28, Montreal, Quebec, H3G 1J9 Tel.: 514-849-5243

President and Chief Engineer: A. D. Grunberg
Sales Manager: T. Pohoryles
Products: apartment house telephones with door-answering facilities. Directory panels. Speaker systems. Video intercom systems with privacy — specially designed for apartment houses.

AMPLYVOX COMM PRODUCTS/SECURITY INTERCOM, INC., 1833 N. 105th, Seattle, WA 98133 Tel.: 206-523-6170

President: Gerard H. Mooyman
Sales Manager: John Burnard
Chief Engineer: Phil Van Oppen
Products: apartment house intercoms video/audio, sound distribution systems, P.A. systems, F.M. intercoms, home video/audio door-answering intercom systems, background music systems, speakers, microphones w/preamps.
District Offices:
The Corrigan Agency, Inc., Unit E, 4 Lovers Lane, Mandeville, LA 70448
Pinz Sales Corp., 570 Yonkers Ave., Yonkers, NY 10704

CORNELL ELECTRONIC PRODUCTS, INC., 4911 W. Good Hope Rd., Milwaukee, WI 53233 Tel.: 414-351-4600

President: Donald Glaubitz
Vice President and Chief Engineer: Gary Butler
Sales Manager: Pauline Haack
Products: audio-visual nurse-call systems, door security and apartment intercom systems, in-and-out registers.
See full listing under Nurse-Patient Intercom Systems & Supplies.

EKTACOM-FISHER BERKELEY CORP., 5800 Christie Ave., Emeryville, CA 94608 Tel.: 415-655-9696

President: Robert S. Fisher
Chief Engineer: Robert Shipley
Products: duplex and simplex intercom systems, annunciator and voice call-in; audio-visual and visual-only nurse-call systems; manual and automatic personnel registers, apartment signaling systems.
See full listing under Intercom Systems—Simplex.

ELECTRO-COMM SYSTEMS INC., 7915 N. 81st St. Milwaukee, WI 53223 Tel.: 414-354-0202

President and Chief Engineer: Angelo Balistreri
Sales Manager: Jim Ippolite
Products: audio and audio-visual nurse-call systems, door-monitoring devices, apartment intercoms and personnel registers. Emergency call systems for nursing homes and housing for the elderly, custom signaling and communications systems.

FARADAY, INC., 805 S. Maumee St., Tecumseh, MI
49286 Tel.: 517-423-2111

President: G. Rummell
Sales Manager: J. Frankow
Chief Engineer: R. Miller

Products: intercom & sound distribution systems, public address systems, nurse call systems, fire alarm, annunciator, clock and hospital life safety systems, full range of signaling products.

See full listing under Alarms, Security & Life Safety Systems.



LEE DAN COMMUNICATIONS, INC., 155 Adams
Ave., Hauppauge, NY 11788
Tel.: 516-231-1414

President: Leon Goldberg
Sales Manager: Lawrence Goldberg
Chief Engineer: Ted Jergens

Products: apartment house intercom from two units up. Custom made lobby panels and apartment stations for retrofit applications. Tek-View combination audio/visual intercom. Government approved mailboxes.

District Offices:
Jack Mesnick Sales, 13 Juneberry Lane, Liverpool, New York 13088

FLORENCE CORP., 2101 N. Elston Ave., Chicago,
IL 60614 Tel.: 312-384-3310

President: L. A. Schooley
Vice President, Sales: D.A. Cannella
Sales Manager: George Jans

Chief Engineer: Ray Cozzens

Vice President, General Manager: John Martino

Products: designers and manufacturers of nurse calls, emergency calls, mail boxes and apartment communication systems.



JERON

electronic systems, inc.

JERON ELECTRONIC SYSTEMS, INC., 3554 N.
Clark St., Chicago, IL 60657
Tel.: 312-528-4020, 800-621-1903

President: Jerome Chesnul
Sales Manager: David Hayes

Products: intercom-security systems for apartment buildings, townhouses, offices. Combination emergency call/intercom systems for elderly housing. Hospital, nursing home, institutional, dormitory communications and signaling systems.

District Offices

Central Marketing Group, P.O. Box 12191, Kansas City, MO 64152

Gregg N. Cloos Co., 1201 Madison St., Denver, CO 80206

Steve Fisher Associates, P.O. Box 14896, Phoenix, AZ 85063

Russ Gerde, 9223 Hyland Creek Circle, Bloomington, MN 55437

Hollingsworth & Still, Inc., 6577 Peachtree Industrial Dr., Norcross,
GA 30092

J. W. Lehner Co., 1221 Temple Trail, Stow, OH 44224

Maish Sales, 500 S. Madison, Mulberry, IN 46058

Manufacturers Agents Corp., 510 Landmark Two, Cherry Hill, NJ
08034

Miller & Associates, Inc., 1710 Firman Dr., Richardson, TX 75081

New West Agency, 3103 Falcon St., San Diego, CA 92103

R. G. Associates, P.O. Box 396, Millis, MA 02054

Mike Schlarman, 208 Crescent Rd., Wanague, NJ 07465

John S. Wilkin & Assoc., Inc., 115 Meadow Lane, Hillboro, OH
45133

LCA SALES CO., 76 Main St., Tuckahoe, NY 10707
Tel.: 914-961-4700 800-LCA-REPS (Outside NY)

President: Joel H. Schwartz
General Manager: R. R. Sherwood

Products: manufacturers' representatives for: Blonder-Tongue, BES, Carol Cable, Eaton/Dekorin, Gentex, Harrington, M/A-Com Video/Data, N.I.T., Panasonic CCTV, Reliable Security, Siedle, University, Videoscope/Quadravision.

See full listing under Alarm Security & Life Safety Systems.

MARLEE ELECTRONICS CORP., 3965 Landmark
St., Culver City, CA 90230 Tel.: 213-204-5045

President: B. Scott Holloway
Sales Manager: John Stanley
Chief Engineer: Barbara Mauch

Products: Entraguard — tenant-controlled security entry system for apartment and office buildings that operates over telephone lines; single, multi-entry, handset and hands-free. Keyboard systems for restricted areas.

MIRTONE INDUSTRIES, LTD., 2225 Kenmore Ave.,
Tonawanda, NY 14207 Tel.: 716-875-0600

President: T. Falbo
Vice President/Sales and Marketing: B. Ruscoe
Director of Communications: R. Brighty
Director of Engineering: L. E. Eisner

Products: fire alarm and fire fighters' communication systems, apartment and industrial intercom, home radio intercom, paging and background music and security systems.

See full listing under Alarm, Security & Life-Safety Systems.

PASO SOUND PRODUCTS, INC., 14 First St.,
Pelham, NY 10803 Tel.: 914-738-4800

Vice President, Engineering: Paul Mastrangelo
Sales Manager: David Moore

Operations Manager: Anthony Sgueglia

Products: two (2) wire systems for duplex communications between entrance and apartment, multiple switchboard systems, microprocessor based systems from 1-999 stations, video intercom, custom manufactured lobby panels and directories. Apartment phones.

See full listing under Engineered Sound Systems.

SECURITY INTERCOM INC., 1833 No. 15th, Seattle,
WA 98133 Tel.: 206-523-6170

President: Gerard Mooyman

Products: voice and video systems for security applications in low and hi-rise apartment houses.

SIEDLE INTERCOM/USA, 1 Wynnewood Rd., Wynne-
wood, PA 19096 Tel.: 1-800-874-3353

Sales Director: Earl Zausmer

Products: 2-wire apartment house intercoms for duplex communications between front door and apartment, chime announcement and door release operation from handset. Decentralized microprocessor intercom for all applications plus page with talkback. Modular mailbox systems. Video intercom systems. CCD ultra miniaturized camera for banks and special surveillance.

SOUNDCRAFT ELECTRONICS, INC., 1517 20th St.,
Santa Monica, CA 90404 Tel.: 213-453-4591

President: Betty Bennett
Vice President Sales: Wayne Freeman
Products: audio mixing consoles and multi-track tape machines. Applications include live recording, sound reinforcement, studio recording, remote recording, broadcast and post production. Full range of power amplifiers.
See full listing under **Pro Audio Sound Systems**.

TALK-A-PHONE CO., 5013 N. Kedzie Ave., Chicago,
IL 60625 Tel.: 312-539-1100

President: Z. Liberman
Sales Manager: Daniel Kagan
Products: intercom systems — manual and hands-free equipment — for industrial, institutional, commercial, home, self-service gas station and apartment house use; wireless and cable connected models.

TEKTONE SOUND & SIGNAL MFG., 1331 S. Killian
Dr., Lake Park, FL 33403 Tel.: 305-844-2383

President: M. Mira
Sales Manager: Carlos Mira
Chief Engineer: J. Switzer
Products: intercom systems for home, apartment, commercial/industrial, institutional—telephone, loudspeaking and door answering. Nurse call, security/alarm and AM/FM radio intercom systems.
District Offices:
Alvan Chaney, 117 NE 54th St., Miami, FL 37137
Dardon & Assoc., 24520 Bagley Rd., Olmsted Township, OH 44138
Howard Golenpaul & Assoc., Crystal Place 949 N., Arlington, VA 22202
Lee Dan Communications, 155 Adams Ave., Hauppauge, NY 11788
Klump Sales Co., 507 Fruit Cover Rd., Jacksonville, FL 32223
Lichtenauer & Assoc., 155 Riverway Dr., Pittsburgh, CA 94565
Majestic Sales, 4058 W. 63rd St., Chicago, IL 60629
Mountain Representatives, 1301 W. 3rd Ave., Denver, CO 80223
Chuck Olson Assoc., 17003 SE 136th, Renton, WA 98055
Universal Agents & Assoc., 3800 W. Highway 13, #200, Burnsville, MN 55337

TELEPHONE SALES & SERVICE CO., 25 DeForest
St., Amityville, NY 11701
Tel.: 516-842-4800

President: Harry F. Bradley
Products: electronic PAX; Select-O-Phone II to 64 stations with 100% trunkage. Comtrac EPAX 64 to 4000 stations. Electronic code-call with telephone access. Message repeater.

AUDIO AMPLIFIERS

AB SYSTEMS DESIGN, INC., 11480 Sunrise Gold
Circle, Rancho Cordova, CA 95670
Tel.: 916-635-0890

President: Robert Bird
Sales Manager: Robert Bird
Chief Engineer: Randy Bisher
Products: professional power amplifiers, mixer amplifiers, and dual and mono bi-amplifiers. Commercial accessories provide full sound reinforcement and distributed system capabilities.

District Offices:
Hanoud & Assoc., 2 Gorham St., Rehoboth, MA 02769
Radon & Assoc., 34 Sunnyside Ave., Mill Valley, CA 94941
Rancilio Assoc., Inc., P.O. Box 28869, 84 Grasso Plaza, St. Louis, MO 63123

Dick Bellew Sales, Inc., 5635 Yale Blvd., #201, Dallas, TX 75206
Wes Alderson Co., 8548 Washington Blvd., Culver City, CA 90230
Wilson Audio Sales, 6602 Hwy. 100, #205, Nashville, TN 37202
Sproch Sales, 3350 W. Broward Blvd., Ft. Lauderdale, FL 32803
Wes-tech marketing, 8548 Washington Blvd., Culver City, CA 90230
MBT, 425 Cochran Rd., Pittsburg, PA 15228

AIPHONE INTERCOM SYSTEMS, 1700 130th Ave.
N.E., Bellevue, WA 98005 Tel.: 206-455-0510

President: Hiko Shinoda
Sales Manager: Jim Morrison
Chief Engineer: Jun Matsumoto
Products: industrial, business, residential, loudspeaking, telephone, video intercom/security systems with paging talk-back; six microprocessor systems available, mixer amplifiers, paging speakers, horns, drivers, ceiling speakers.



ALTEC LANSING CORPORATION, A Gulton Co.,
Box 26105, Oklahoma City, OK 73126-0105
Tel.: 405-324-5311

President: F. Davis Merrey
Vice President of Marketing: Gary Rilling
Sales Manager: Gayle Campbell
Products: professional electronic and acoustic sound products of all types.
District Offices:
Gayle Campbell, Ext. M-266, So. CA, AZ, NM, HI, MI, IN, OH, KY, WV
William Sparling, Ext. M-267, No. CA, OR, WA, ID, MT, WY, UT, CO, AK
Nick Botz, Ext. M-268, ND, SD, NE, MN, IA, WI, IL
Frank Dutreil, Ext. M-269, TX, OK, KS, MO, AR, LA, MS
Mike Sturgeon, Ext. M-271, So. VA, NC, SC, TN, AL, GA, FL
George Solti, Ext. M-273, DC, PA, NY, NJ, DE, CT, RI, MA, NH, VT, ME

AUDISAR, Box 1561, Bellevue, WA 98009
Tel.: 206-454-2040

President: Robert E. Munger
Products: industrial audio and broadcast equipment, audio transformers, loudspeakers, power amplifiers, mixers, sound projector interface device, test equipment, specials and engineered sound systems.
See full listing under **Engineered Sound Systems**.

BGW SYSTEMS, INC., 13130 S. Yukon Ave., Hawthorne, CA 90250 Tel.: 213-973-8090

President: Brian Gary Wachner
Products: five complete lines of audio power amplifiers including: professional, commercial, broadcast, Proline II and professional mobile audio power amplifiers. Also includes professional electronic crossovers.
District Offices:
Platinum Marketing Network, 817 Brock Road #9, Ontario, Canada L1w 3L9

Hustling Enterprises, 1434 Suffolk St. N, St. Petersburg, FL 33710
Givan-Flanagan Assoc., 107 Pierce St., W. Boylston, MA 01583
Gemini Electronics Marketing, 115 4th Ave. S, Edmonds, WA 98020
Graham/Davis, 14925-A Memorial Dr., Houston, TX 77079
Lienau Associates, 5501 Twin Knolls #103, Columbia, MD 21045
Peter E. Schmitt Co., 240 Grand Ave., Leonia, NJ 07605
Sound Marketing, 12023 S. 73rd Ave., Palos Heights, IL 60463
Burcaw Co. & Assoc., 30642 Dequindre, Warren, MI 48092
Evans Sales & Marketing, 4103 Vailwood Dr., Nashville, TN 37215
CL Pugh and Assoc., 2144 Riverside Dr., Columbus, OH 43221
Meyer & Ross, 1485 Rollins Road, Burlingame, CA 94010

BOGEN, A Lear Siegler Company, Box 500, Paramus,
NJ 07653 Tel.: 201-343-5700

President: John H. Ochtera
Vice President, Marketing: Carl C. Dorwaldt
Vice President, Engineering: Mark Koller
National Sales Manager: Art Arlow

Products: professional, industrial & commercial amplifiers, 2W to 100W. Public address, background music, music-on-hold, utility; telephone paging; telephone paging/talk-back. Conventional and MOSFET power amplifiers, 60W to 250W. Amplified speakers. Automatic and modular mixer-preamplifiers.
See full listing under **Engineered Sound Systems**.

BONNEVILLE MEDIA COMMUNICATIONS, 130 Social Hall Ave., Salt Lake City, UT 84111
Tel.: 801-237-2400

Sales Manager: Michael F. Collett
Chief Engineer: Brian Gallagher
Products: audio distribution amplifiers for both rack-mount installations and for portable press-corps use.

CALRAD ENGINEERED ELECTRONIC PRODUCTS,
819 N. Highland Ave., Los Angeles, CA 90038
Tel.: 213-465-2131

President: Joseph Shupper
Vice President: Robert Shupper
Sales Manager: Fred Crown
Chief Engineer: Wes Black
Products: microphones, headphones, public address amplifiers, power supplies, speakers, connecting cables, telephone accessories, potentiometers, connectors, switches, meters, control knobs.
Sales Representatives:
Shamrock Electronic Sales, 1071 Patterson Road, Dayton, OH 45420
Forti Associates, 3519 Raymoor Road, Kensington, MD 20895
B & R Electronic Sales, 2101 Florence Dr., Plano, TX 75075
Your Rep (Charles Muse), 24318 7th Ave. West, Bothell, WA 98011
Bruce Gordon, 970 Folsom St., San Francisco, CA 94107

CARVER CORP., 19210 33rd Ave., P.O. Box 1237,
Lynnwood, WA 98036 206-775-1202

President: Robert Carver
Chief Engineer: Colleen McNaur
Sales: Milton McNalley
Products: high quality consumer electronics featuring magnetic field amplifiers, sonic holography, asymmetrical charge, coupled FM decoders and the digital time lense.

CETEC IVIE, 1366 W. Center St., Orem, UT 84057
Tel.: 801-224-1800

President: Craig Berry
Sales Manager: Glen Meyer
Chief Engineer: Greg Greenwood
Products: 5000 modular sound system comprised of a mainframe and various plug-in modules including 70-volt, 140-volt, and 4/8-ohm amplifier combinations capable of producing power from 100 to 900 watts into various loads. There is also a dual 50-watt amplifier module.
See full listing under **Audio Signal Processors**.

CETEC RAYMER, 7315 Fulton Ave., N. Hollywood,
CA 91605 Tel.: 213-875-0423

President: Richard P. Drake
Chief Engineer: Clifford L. Kogge Jr.
Products: background/foreground equipment: wall and shelf mount amplifiers, AM/M tuners and paging receivers, microphone mixers, installation accessories and transformers, M-O-H and telephone interconnect devices, and test equipment.
See full listing under **Background/Foreground Music Systems**.

CROWN INTERNATIONAL, 1718 W. Mishawaka
Road, Elkhart, IN 46517 Tel.: 219-294-8000

President: Max Scholfeld
Marketing Manager: Charles W. Gushwa
Engineering Manager: Verne E. Searer
Products: power amplifiers, preamplifiers, tuners, equalizers, active crossovers, microphones, real-time analyzers, audio computer/analyzers.

J. W. DAVIS & CO., 3215 Canton St., Dallas, TX
75226 Tel.: 214-651-7341
800-442-1564 Tex. WATS
800-527-5705 National WATS

President: M. H. Earp
Executive Vice President: W. A. Hevron
Chief Engineer: J. E. Mitchell
Products: integrated and booster power amplifiers in various sizes to 250 watts including separate mixers and equalizers or combination packages for custom or engineered sound reinforcement.

**DUKANE CORPORATION, Communication Systems
Division**, 2900 Dukane Dr., St. Charles, Il 60174
Tel.: 312-584-2300

General Manager: William B. Clark
Marketing Manager: Craig E. Lyons
Chief Engineer: Paul D. Graham
Products: communications systems including intercom, public address and background music, professional sound, radio paging, nurse-patient communications, personnel registers and master clock systems.

EDCOM, INC., 755 Center St., Box 506, Lewiston,
NY 14092-0506 Tel.: 716-754-7130

President: J. D. Breedon
Marketing Manager: James K. Wood
Director of Engineering: Peter Jova
Products: amplifier mainframes, mixers, distribution amplifiers, line surveillance and zone selection equipment, modular plug-in preamplifiers, tone and signal generators, teleconference equipment, multiple cassette systems, simultaneous interpretation systems.
See full listing under **Engineered Sound Systems**.

EDCOR, 16782 Hale Ave., Irvine, CA 92714
Tel.: 714-863-1529

President: Larry Weston
Chief Engineer: Harold Keeling
Products: modular mixer & power amplifiers, GLA mixer & booster amplifiers, mic/line & voice gated mixers, automatic mixers. Wireless microphone systems. Transformers audio custom and standard, power transformers.

GROMMES PRECISION ELECTRONICS, INC.,
9101 King St., Franklin Park, IL 60131
Tel.: 312-678-5350

President: W. S. Grommes
Sales Manager: W. Stow
Chief Engineer: A. A. Hart
Products: integrated audio amplifiers. Amps for mono and stereo power, line, music-on-hold. Mixer preamplifiers, graphic equalizers, 2 CH. limiters or compressors, AM-FM tuners, background music receivers and systems, public address systems, custom engineered sound reinforcement systems, sound columns, trumpets, driver units, baffles, speakers, microphones and microphone stands.
District Offices:
Associated Systems, P.O. Box 5211, Manchester, NH 03108
SAGA, 59 W. Mohawk St., Oswego, NY 13126
Reich & Bernstein, Inc., 1121 Yonkers Ave., Yonkers, NY 10704
George Conneen Co., Inc., P.O. Box #251, Springfield, PA 19064
George Conneen Co., Pricewood M176, Harleysville, PA 19438
Emil Kirik, 5300 E. 141st St., Cleveland, OH 44137
Joe Wilson, P.O. Box 12191, Kansas City, MO 64152
Hollingsworth & Still, Inc., 6577 Peachtree Industrial Blvd., Norcross, GA 30092
Hollingsworth & Still, Inc., P.O. Box 336, Kernersville, NC 27284
Hollingsworth & Still, Inc., 4429 Pleasant Garden Rd., Greensboro, NC 27406
Hollingsworth & Still, Inc., P.O. Box 384, Huntsville, AL 35804
Larry Stone, 8825 W. Cornell Pl., Lakewood, CO 80227
Lintern Assocs., P.O. Box 477, Warrenville, IL 60555
F. P. Yarussi Co., Inc., 312 Rockfield Rd., Pittsburgh, PA 15243
Hawaii Electronics Sales & Service, 1305 Hart St., Honolulu, HI 96817

Tortech Marketing Corp., 1594 Dundas St. W., Toronto, ON, Canada M6K 1T8

Morhan Exporting Corp., 270-78 Newton Rd., Plainview, NY 11803
White Radio Ltd., 940 Gateway Dr., Burlington, ON L7L 5K7, Canada

HEIL LTD., 2 Heil Drive, Marissa, IL 62257
Tel.: 618-295-3000

President: Bob Heil

Chief Engineer: John Rutter

Products: mixing consoles power amplifiers, parametric EQ, crossovers, satellite TV antennas, amateur radio and communication microphones.

IMC, 1316 E. Lancaster, Ft. Worth, TX 76102
Tel.: 817-336-5114

President: Jerry Freed

Sales Manager: Claude Boyd

Chief Engineer: Jim Cowser

Products: Akai—multitrack recorder, synthesizers. Studiomaster—recording and live mixing consoles. Ross—multitrack recorders, PA systems, guitar amps and effects. Fane—professional loudspeakers and compression drivers.

INDUSTRIAL RESEARCH PRODUCTS, INC., 321 Bond St., Elk Grove Village, IL 60007
Tel.: 312-439-3600

President: Hugh S. Knowles

Sales Manager: Roger Carroll

Sales Engineer: Jack Read

Products: Voice-matic* microphone mixers, digital delays, transversal equalizers, power amplifiers, automatic level controllers.

JBL PROFESSIONAL, 8500 Balboa Blvd., Northridge, CA 91329 Tel.: 818-893-8411

President: Ron Means

Vice President, Sales: Ken Lopez

Applications Engineer: Drew Daniels

Products: high quality loudspeakers and loudspeaker systems of all kinds; special loudspeakers for musical instruments; automatic microphone mixer; electronic crossover.

See full listing under **Loudspeakers & Accessories**.

JOHNSON ELECTRONICS, INC., P.O. Box 4728, Winter Park, FL 32793-4728
Tel.: 305-677-4030

Chief Executive Officer: Ralph L. Weber

President: J. M. Lutz

Chief Operating Officer: Charles Gabrielson

Vice President, Engineering: Kenneth St. John

Director of Marketing: Mel Kelch

Products: complete line of solid state SCA multiplex tuners, tuner/amplifiers, solid state audio amplifiers and accessories. Datavox™ data transmission equipment.

McGOHAN ELECTRONICS, INC., 1033 Fairway Dr., Bensenville, IL Tel.: 312-595-2342

President: James M. McGohan

Products: solid state amplifiers for commercial sound and background music-mic mixers, zone pagers, mic and telephone line transformers and other accessories—off the shelf stock.

District Offices:

Austin Associates, 50 Windsor Lane, Willingboro, NJ 08046

Irv Brown Co., 401 Kingston Ave., Brooklyn, NY 11225

Ted Firaneck Sales Co., 2685 Lapeer Road, Pontiac, MI 48057

Givan-Flanagan Assoc., Inc. 107 Pierce St., P.O. Box 254, W. Boylston, MA 01583

Maish Sales Co., 500 S. Madison St., Mulberry, IN 46058

J. W. Lehner Co., 1221 Temple Trail, Stow, OH 44224

Miller Associates, P.O. Box 851685, Richardson, TX 75081-1823

Chuck Olson Assoc., 17003 S.E. 136th, Renton, WA 98055

Henry W. Phillips Co., Inc., 110 Mansell Cir., Roswell, GA 30075

Rancilio Assoc., Inc., 84 Grasso Plaza, St. Louis, MO 63123

Stan Sliz & Assoc., 1021 S. Boulder Rd., #D, Louisville, CO 80027
Sunrise Sales Co., 620 Palmer Ave., Romeoville, IL 60441

Brian Trankle & Assoc., 820 Black Mountain Rd., Hillsborough, CA 94010

Wes-Tech Marketing, 8548 Washington Blvd., P.O. Box 206, Culver City, CA 90230-0206

McMARTIN INDUSTRIES, INC., 4500 S. 76th St., Omaha, NE 68127 Tel.: 402-331-2000

President: Ray B. McMartin

Vice President, Sales: Jay B. McMartin

Products: transistor-engineered and commercial sound amplifiers/mixers/accessories, background music amplifiers and sound systems, SCA and loudspeaker test sets, AM/FM monitors, and transmitters, AM/FM single channel receivers, audio consoles, emergency broadcast systems. Satellite communication products.

District Offices:

Eastern Regional Sales Manager: Carol Mayer, 13124 Pennerview Lane, Fairfax, VA 22033

Bill Newman & Co., 3805 Marshall St., #302, Wheatridge, CO 80033

Yore Co., 3564 Rolling View Dr., White Bear Lake, MN 55110

Forti Assocs., 3519 Raymoor Rd., Kensington, MD 20895

SRT Marketing, 7107 Larimer Ct. N., Tampa, FL 33615

Murphy & Cota, Inc., 500 Plasamour Dr., N.E., Atlanta, GA 30324

Willgold Electronics Sales Corp., 50 Washington Terr., E. Orange, NJ 07017

Burcaw Co., 18236 W. McNichols, Detroit, MI 48219

Harry J. Lang & Assocs., 1371 Hillcrest Dr., Anchorage, AK 99503

B C Electronic Sales, Inc., P.O. Box 12485, Shawnee Mission, KS 66212

Technical Sales, Assocs., 1485 Bayshore Blvd., San Francisco, CA 94124

McKinney Sales Co., 1303 Chemical St., P.O. Box 10451, Dallas, TX 75207

Al Waxman Sales, Inc., 990 Kenmore Ave., Buffalo, NY 14216

MIDWEST ELECTRONIC INDUSTRIES, INC., 4945 W. Belmont, Chicago, IL 60641
Tel.: 312-685-3500

Vice President/General Manager: H. D. Vicinus

Sales Manager: C. L. Madonia

Chief Engineer: L. Chimel

Products: producers of the "Mobilpage" system for indoor or outdoor publicasting, including solid state amplifiers in models up to 100 watts, and matched accessories including horns, microphones, radio and tape reproducing equipment, specialized for transportation industry.

MILLBANK ELECTRONICS GROUP LTD., Bellbrook Industrial Estate, Uckfield, Sussex, TN22 1QL England Tel.: Uckfield 825-4811

Chairman and Marketing Director: Tony Walker

Director and General Manager: Brian Evans

Director C.T.S.D. Systems: Bernard Skinner

Engineering Manager (Sales): Doug Edworthy

Products: custom engineered sound systems; public address, teleconference, life-safety. Sound reinforcement systems; amplifiers, preamplifiers, background music. FM/AM tuners, alarm and tone signal generators, loudspeakers, microphones.

See full listing under **Engineered Sound Systems**.

NUMARK ELECTRONICS, 503 Raritan Center, Edison, NJ 08837 Tel.: 201-225-3222

President: Harry Kotovsky

Sales Manager: Paul Friedman

Products: power amplifiers, mixers, equalizers, noise reduction, expansion system, video sound processors.

See full listing under **Pro Audio Sound Systems**.

OPAMP LABS, INC., 1033 N. Sycamore Ave., Los Angeles, CA 90038 Tel.: 213-934-3566

Sales Manager: B. Losmandy

Products: audio consoles (kits and wired); amplifiers, DC, mic preamp; E.Q., magnetic tape, oscillators, power supplies, transformers, reverbs, graphic equalizers, electronic matrices. Video distribution amplifiers. Audio-video switches rack-fitted.

PANASONIC INDUSTRIAL CO., Audio-Video Systems Division, One Panasonic Way, Secaucus, NJ 07094 Tel.: 201-348-7000

President: Ken Kurahashi

General Manager: Steve Yuhas

Sales Manager: Ted Conboy

Products: complete line of 4-input and 5-input mixer power amplifiers. A series of 5-input power amplifiers with AM-FM tuners, relay boxes, video projection systems, and a complete line of accessories. See full listing under **CCTV Systems Products**.

PASO SOUND PRODUCTS, INC., 14 First St., Pelham, NY 10803 Tel.: 914-738-4800

Vice President, Engineering: Paul Mastrangelo

Operations Manager: Anthony Sgueglia

Distributor Sales Manager: David Moore

Products: full line of integrated and booster amplifiers. AC/DC for emergency and audio evacuation systems, DC amplifiers for mobile applications.

See full listing under **Engineered Sound Systems**.

PROTECH AUDIO CORP., Flowerfield, Bldg. #1, St. James, NY 11780 Tel.: 516-584-5855

President: William Murphy

Chief Engineer: Joseph Giambone

Products: amplifiers—power, medium level, distribution, compressor/limiters, preamplifiers modular, automatic level, controls, remote level controls, switching modules, line amplifiers, mixing/summing modules, audio transformers, hardware.

QSC AUDIO PRODUCTS, INC., 1926 Placentia Ave., Costa Mesa, CA 92627 Tel.: 714-645-2540

President: Barry Andrews

Sales Manager: Greg Hockman

Chief Engineer: P. H. Quilter

Products: professional power amplifiers and electronic crossovers.

ROUND & BIDNICK ASSOCS., 2631 Rocky Trail Rd., Diamond Bar, CA 91765 Tel.: 714-861-3928

President and Sales Manager: Charles W. Round

Chief Engineer: Ron S. Bidnick

Products: mixer/power amplifiers with AM/FM radio, Selectzone™ paging, chime-siren signaling, AC/24v DC operations; power amplifiers; mixers; tuners; cassette decks, battery chargers.

District Offices:

Graham/Davis, Inc., 4805 Keller Road, Dallas, TX 75248

Murphy & Cota, Inc., 500 Plasamoor Dr. N.E., Atlanta, GA 30324

SRT Marketing, 7107 Larimer Ct., Tampa, FL 33685

Burcaw Company, 1324 Burton St., Grand Rapids, MI 49507

Lichtenauer & Associates, 155 Riverway Dr., Pittsburg, CA 94565

SESCOM, INC., 1111 Las Vegas Blvd. No., Las Vegas, NV 89101 Tel.: 702-384-0993

President: Franklin J. Miller

Products: amplifiers, complete line of audio interfacing components. Audio transformers, audio modules. Signal processing equipment.

SHURE BROTHERS INCORPORATED, 222 Hartrey Ave., Evanston, IL 60202 Tel.: 312-866-2200

President: Jim Kogen

Sales Manager: Dick Murphy

Chief Engineer: Bernie Jakobs

Products: microphone and circuitry products for broadcast, recording and general sound reinforcement applications. See full listing under **Microphones**.

SOUND-CRAFT SYSTEMS, INC., Petit Jean Mountain, Morrilton, AR 72110 Tel.: 501-727-5476

President: Earle Love

Sales Manager: Hank Shaw

Chief Engineer: Hugh Donnell

Products: portable lecterns with built-in sound; wireless microphone equipment; solid wood lecterns.

SOUND PRODUCTS/3M, 3M Center 225-3N-04, St. Paul, MN 55144 Tel.: 612-733-0447

Marketing Manager: Don Rada

Sales Manager: Jack Dingley

Products: music libraries for all purposes. Reliable player. Industrial quality intercoms. Top-line message repeater. Speaker assemblies for distributed systems. Microphones, amplifiers and other sound system components.

SPECO DIV., COMPONENTS SPECIALTIES INC., 1172 Rt. 109, P.O. Box 624, Lindenhurst, NY 11757 Tel.: 516-957-8700 (New York) 1-800-645-5516 (Outside NY)

President: Louis W. Keller

Vice President: Stan Hulkower

Sales Manager: Mel Hulkower

Chief Engineer: James Ganci

Products: P.A. horns, amplifiers, tuners, loudspeakers, wall baffles, speaker assemblies, outdoor speakers, sound columns, ceiling grilles, transformers, L-pads, attenuators, accessories, microphones, intercoms, alarm sirens, multitesters, oscilloscopes.

TELEX COMMUNICATIONS, INC., 9600 Aldrich Ave. S., Minneapolis, MN 55420 Tel.: 612-887-5550, 612-884-4051

President: John Howe

Director Marketing, Communication Products: Donald Merein

Products: open-reel and cartridge tape recorders/reproducers, tape transports, record and reproduce electronics, intercoms, broadcast, communications and specialty headphones, headsets and accessories, closed circuit intercoms, microphones.

See full listing under **Pro Audio Sound Systems**.

TOA ELECTRONICS, INC., 480 Carlton Ct., S. San Francisco, CA 94080 Tel.: 415-588-2538

President: Sam Sakata

Sales Manager, Sound and Communications Products:

Joe Green/Gail Martin, Sr.

Sales Manager, Distributor Products: Joe Green

Chief Engineer: Tad Inui

Products: engineered VMS series sound systems, micro-computerized EXES intercom systems, commercial sound systems, amplifiers, dual amplifiers, equalizers, multifunctional preamplifiers, mixing consoles, horns, drivers, speakers, wireless systems, microphones.

See full listing under **Engineered Sound Systems**.

UREI, 8500 Balboa Blvd., Northridge, CA 91329 Tel.: 818-893-8411

President: Ron Means

Vice President: Ken Lopez

Applications Engineer: Drew Daniels

Products: power amplifiers, limiters, compressors, equalizers, filters Time Aligned™ speakers, direct boxes, electronic crossover, digital metronome, transcription preamplifier, disco mixers, broadcast consoles.

See full listing under **Audio Signal Processors**.

BOB WHITE ASSOCIATES, P.O. Box 39104, Solon,
OH 44139 Tel.: 216-248-1317

President: Bob White
Sales Manager: Tod White
Chief Engineer: George White
Products: professional sound products, audio.
See full listing under **Pro Audio Sound Products**.

XTEL CORPORATION, 4301 Will Rogers Pkwy., Suite
900, Oklahoma City, OK 73108
Tel.: 405-946-1500

President: J. William Patterson
Vice President: Glen Patterson
Products: "Voicepac 10-75 stations:" handsfree response behind
PBX/Centrex or key systems. "All-Call," splash and privacy tones,
power paging. Compact speaker/microphones mount inside telephones.

AUDIO SIGNAL PROCESSORS

AB SYSTEMS DESIGN, INC., P.O. Box 754, Folsom,
CA 95630 Tel.: 916-635-0890

President: Robert Bird
Marketing Manager: Mark Engebretson
Chief Engineer: Dennis Cash
Products: professional power amplifiers, mixer amplifiers, and dual
and mono bi-amplifiers. Commercial accessories provide full sound rein-
forcement and distributed system capabilities.
See full listing under **Audio Amplifiers**.

AKG ACOUSTICS, INC., 77 Selleck St., Stamford,
CT 06902 Tel.: 203-348-2121

Vice President/General Manager: S. R. Ravich
Sales Manager: D. Talbot
Tech Manager: D. Pilkington
Products: studio condenser microphones; prepolarized condenser
microphones; professional dynamic microphones; cardioid dynamic
microphones; special purpose microphones; stereo headphones; boom
sets; accessories, reverb units, phonocartridges, digital delays.
See full listing under **Microphones**.

ALTEC LANSING CORPORATION, A Gulton Co.,
Box 26105, Oklahoma City, OK 73126-0105
Tel.: 405-324-5311

President: F. Davis Merrey
Vice President of Marketing: Gary Rilling
Sales Manager: Gayle Campbell
Products: professional electronic and acoustic sound products of all
types.
See full listing under **Audio Amplifiers**.

ART — Applied Research & Technology Inc.,
215 Tremont St., Rochester, NY 14608
Tel.: 716-436-2720

President: Philip A. Betette
Sales Manager: Peter Beverage
Chief Engineer: Richard Neatrou
Products: digital signal processors including the DR1 digital reverbera-
tion system, other digital reverbs, equalizers and our 1500 digital delay.
All ART reverbs are software updateable.
District Office:
Peter Beverage, 2 Willard Way, RD#1, Berlin, NJ 08009

AUDIO + DESIGN/CALREC, INC., P.O. Box 786,
Bremerton, WA 98310 Tel.: 206-275-5009,5010

President/Sales Manager: Nigel Branwell
Chief Engineer: Tom Gandy

Products: audio signal processing, microphones, miking consoles, com-
pressors, limiters, expanders, gates, equalizers, distribution amps, de-
essers, Ambisonic Surround Sound equipment.

District Offices:

Dick Swettenham, Audio & Design/Calrec, P.O. Box 25456, W. Los
Angeles, CA 90025

AUDIO-TECHNICA U.S., INC., 1221 Commerce Dr.,
Stow, OH 44224 Tel.: 216-923-0376

President: Jon R. Kelly
Sales Manager: Charlie Winkler
Chief Engineer: Bob Herrold
Products: microphones and microphone accessories, recorder/mixers,
cables, direct boxes, headphones.
See full listing under **Microphones**.

AUDIOVISUAL SYSTEMS, 725 Lorraine Blvd., Los
Angeles, CA 90005 Tel.: 213-934-3006

President and Chief Engineer: Orrin Charm
Products: PB289G patch bay system. Ground plane construction,
switchable normals, PCB construction, switches audio and video.
Pyramount™ ceiling suspension system designed for hanging
loudspeakers, PZM™ mics, etc.

CETEC IVIE, 1366 W. Center St., Orem, UT 84057
Tel.: 801-224-1800

President: Craig Berry
Sales Manager: Glen Meyer
Chief Engineer: Greg Greenwood
Products: modular signal processing systems. A common main frame
accepts mixers, crossovers, equalizers, digital delays, compressors, noise-
making generators, and power amplifiers. A programmable audio buss
system provides all interconnects.

District Offices:

Northshore Marketing, 11000 Lake City Way N.E., Suite 310, Seattle,
WA 98125

Kodo Associates, 8314 Pillsbury Ave. So., Minneapolis, MN 55420
Riley & Petchell Sales, Inc., 25700 Plymouth Road, Detroit, MI
48239

Upstate Marketing, 542 Swaggertown Road, Glenville, NY 12302
VF Sales, 181 Worrester Road, Natick, MA 01760

Roy Colen Sales, 169 Stadium Ave., Mill Valley, CA 94941

Marcus Johnson & Associates, 217 North Main St., St. Charles, MO
63301

Sunrise Sales Company, 620 Palmer Ave., Romeoville, IL 60441

CL Pugh & Associates, 2144 Riverside Drive, Columbus, OH 43221

Sphere Associates, 11250-7 Roger Bacon Drive, Reston, VA 22090

Pusecker Sales, 372 Upper Mountain Ave., Upper Montclair, NJ
07043

Marshank Sales Company, 3940 Higuera Street, Culver City, CA 90232

Dimension/Point IX, 11020 Audelia Rd. B106, Dallas, TX 75243

Applied Audio, 26 Audubon Drive, Asheville, NC 28804

Sproch Sales, Inc., 3520 West Broward Blvd., Fort Lauderdale, FL
33312

CONNECTRONICS CORPORATION, 652 Glenbrook
Rd., Stamford, CT 06906 Tel.: 203-324-2889
800-322-2537

President: Stephen G. Ash

Vice President: Richard J. Chilvers

Products: ultra-flexible, colored wire and cable from mic cable to 32
pr. foil shielded. Also audio signal processors, portable mixing con-
soles, low-cost XLR connectors.

See full listing under **Wire & Cable**.

dbx INCORPORATED, 71 Chapel St., Newton, MA
02195 Tel.: 617-964-3210

Vice President for Marketing and Sales: Stanley S. Peters

Sales Manager: Greg Green

Products: Over-Easy™ compressor/limiters; soft clippers; noise gates;
equalizers; de-essers; pro and consumer tape noise reduction; all for
recording, broadcast, and sound reinforcement.

**DUKANE CORPORATION, Communications
Systems Division, 2900 Dukane Dr., St. Charles,
IL 60174 Tel.: 312-584-2300**

General Manager: William B. Clark
Marketing Manager: Craig E. Lyons
Chief Engineer: Paul D. Graham
Products: communications systems including intercom, public address and background music, professional sound, radio paging, nurse-patient communications, personnel registers and master clock systems.

**EDCOR, 16782 Hale Ave., Irvine, CA 92714
Tel.: 714-863-1529**

President: Larry Weston
Chief Engineer: Harold Keeling
Products: automatic mixers, mic/line level mixers, voice gated microphone mixers. Four and eight channel phantom power supplies for electret or condenser microphones with step attenuator on each channel.

**ELTREX INTERNATIONAL, 2 Columbia Dr., Amherst,
NH 03031 Tel.: 603-886-3500
Telex: 953016**

President: T. H. Sullivan
Sales Manager: Bill Ryan
Products: complete line of radio paging encoders, terminals, test equipment for two-tone and five-tone sequential solid state voice recorders and digital delay units for the broadcast industry.

**EVENTIDE, INC., One Alsan Way, Little Ferry,
NJ 07643 Tel.: 201-641-1200**

President: Richard Factor
Sales Manager: Joseph Shapiro
Products: digital audio delays, with delay up to two seconds, in two ms steps, SP2016 audio effects processor/reverb, Harmonizer® pitch change/effects units, time compression/expansion systems. Real-time third octave spectrum analyzers with RT-60 and spectral surface analysis capabilities.
District Offices:
John B. Anthony Co., 992 High Ridge Road, Stamford, CT 06905
Audio Resources, 778 Burr Oak Drive, Westmont, IL 60559
GMI/New England, 65 Maguire Ave., Avon, MA 02322
Loppnow & Associates, 16141 Redmond Way, Suite 174, Redmond, WA 98052

**FURMAN SOUND, INC., 30 Rich St., Greenbrae, CA
94904 Tel.: 415-927-1225**

President and Chief Engineer: Jim Furman
Sales Manager: Diane Poole
Chief Engineer: Jim Murphy
Products: rack-mounted audio signal processing: equalizers, crossovers, reverberation systems, limiter/compressors, noise gates, patch bays, power conditioners, microphone mixers.

**INDUSTRIAL RESEARCH PRODUCTS, INC.,
321 Bond St., Elk Grove Village, IL 60007
Tel.: 312-439-3600**

President: Hugh S. Knowles
Sales: Roger M. Carroll, Jack L. Read
Products: Voice-matic® microphone mixers, digital delays, transversal equalizers, power amplifiers, automatic level controllers.

**KLARK-TEKNIK ELECTRONICS, 262A Eastern
Pkwy., Farmingdale, NY 11735
Tel.: 516-249-3660**

President: John P. Kelly, Jr.
Sales Manager: Keith Worsley
Chief Engineer: Jim Jacobelli
Products: digital reverberation systems, digital delay lines, 1/3 octave and 2/3 octave graphic equalizers, 1/3 octave R.T.A. with R.T.60

measurement capabilities, Brooke Siren Systems crossovers, compressor/limiters.
See full listing under **Pro Audio Sound Systems**.

**LEXICON, INC., 60 Turner St., Waltham, MA 02154
Tel.: 617-891-6790**

President: Ronald Noonan
Director of Sales: Joel Silverman
Advanced Products Sales Manager: Brian Zolner
Broadcast Sales Manager: Lawrence Rich
Products: digital audio delay and reverberation systems. Several basic models allow cost effective use in sound reinforcement, studio and live entertainment applications; broadcast quality audio time compressor/expansion, digital audio/video delay compensators.
District Offices:
Gexco International Inc., American Industrial Center, 317 St. Paul's Ave., 8th Floor, Jersey City, NJ 07306

**LINEAR & DIGITAL SYSTEMS INC., 46 Marco Lane,
Centerville, OH 45459 Tel.: 513-439-1758**

President: Dale Beard
Secretary/Treasurer: Jerry Gabbard
Product: noise suppression and power protection system for most sound reinforcement equipment.

**LYNTEC/TECHNICAL VISUALS, 7030 Grandview,
Merriam, KS 66204 Tel.: 913-722-4047**

President: Lynn J. Poiter
Product: programmable audio controller generates 1-2 channels of time of day/level controlled pink noise. Controls up to 5 paging/music channels. Weekend control. Battery backup.

**NEI (Neptune Electronics, Inc.), 934 N.E. 25th Ave.,
Portland, OR 97232
Tel.: 503-232-4445**

President and Sales Manager: H. C. (Bud) Garrison
Chief Engineer: Robert Popham
Products: microprocessor controlled equalizer/real time analyzer, mixing consoles, powered mixers, graphic equalizers, parametric equalizers, real time analyzers, reverberation units, electronic crossovers, audio amplifiers.
District Offices:
David H. Brothers Company, 19 Old Court Road, Baltimore, MD 21208-4063
S. F. Marketing, 312 Benjamin Hudon, Montreal, Quebec H4N 1J4 Canada
Professional Sound & Lighting, 9241 West Virginia Place, Lakewood, CO 80226
Bob White Associates, P.O. Box 29104, Solon, OH 44139
El Rep Sales Company, P.O. Box 266, Tucker, GA 30084

**NUMARK ELECTRONICS, 503 Raritan Center, Edison,
NJ 08837 Tel.: 201-225-3222**

President: Harry Kotovsky
Sales Manager: Paul Friedman
Products: power amplifiers, mixers, equalizers, noise reduction, expansion system, video sound processors.
See full listing under **Pro Audio Sound Systems**.

**OPAMP LABS, INC., 1033 N. Sycamore Ave., Los
Angeles, CA 90038 Tel.: 213-934-3566**

Sales Manager: B. Losmandy
Products: audio consoles (kits and wired); amplifiers, D.C., mic preamp; E.Q., magnetic tape, oscillators, power supplies, transformers, reverbs, graphic equalizers, electronic matrices. Video distribution amplifiers. Audio-video switches rack-fitted.

**ORBAN ASSOCIATES, INC., 645 Bryant St., San
Francisco, CA 94107 Tel.: 415-957-1067**

President: John Delantoni
Sales Manager: Sid Goldstein
Chief Engineer: Robert Orban

Products: signal processing for sound reinforcement, parametric and graphic/parametric equalizers, spring reverb, de-essers, limiter/compressors, and universal security cover for 19" rack mount units.

PROTECH AUDIO CORP., Flowerfield Bldg. #1,
St. James, NY 11780 Tel.: 516-584-5855

President: William Murphy
Chief Engineer: Joseph Giambone
Products: amplifiers—power, medium level, distribution, compressor/limiters, preamplifiers modular automatic level controls, remote level controls, switching modules, line amplifiers, mixing/summing modules, audio transformers, hardware.

RANE CORP., 6510 216th SW, Mountainlake Terr., WA
98043 Tel.: 206-774-7309

President: Steve Brakken
Sales Manager: Larry Winter
Chief Engineer: Dennis Bohn
Products: constant Q equalizers, realtime analyzers, 6-channel amplifiers (900w), distribution amps, 70 volt systems, headphone amplifiers, crossovers.

RTS SYSTEMS, INC., 1100 W. Chestnut St., Bur-
bank, CA 91506 Tel.: 213-843-7022

President: Vicki Bertrand
Vice President, Marketing: Douglas Leighton
Sales Manager: Bob Tourkow
Chief Operating Officer: Ethan Bush
Chief Engineer: Stan Hubler
Products: professional intercom systems, conference-line and dedicated-line, IFB systems. Pro audio amplifier-phono-preamp, 10-watt monitor amp and buffer amp.

SAN DIEGO SOUND & COMMUNICATIONS CO.,
4950 Waring Rd., #2A, San Diego, CA 92120
Tel.: 619-265-2551

President: Lowell D. Johnson
Sales Manager: Lee Carter
Chief Engineer: Ken Britsch
Products: noise operated volume controls.

SEQUENTIAL CIRCUITS, INC., 3051 N. First St.,
San Jose, CA 95134 Tel.: 408-946-5240

Sales Manager: Kevin Talmant
Products: Pro-FX programmable signal processors: DDLs, flangers, reverbs, phasers, stereo mixers, distortion devices, parametric equalizers.

TASCAM, Teac Professional Division, 7733 Telegraph
Road, Montebello, CA 90640 Tel.: 213-726-0303

President: Noria Tamura
National Sales Manager: William Mohrhoff
Director of Product Planning: Dave Oren
Product/Service Manager: Jon Bliese
Advertising Manager: Anders Madsen
Products: manufacturer of a full line of rack mountable signal processing equipment from meter bridges to parametric equalizers, including headphone amplifiers, mic/line mixers and a dual reverb amplifier.
See full listing under **Pro Audio Systems**.

TOA ELECTRONICS, INC., 480 Carlton Ct., S. San
Francisco, CA 94080 Tel.: 415-588-2538

President: Sam Sakata
Sales Manager, Sound and Communication Products: Joe Green/
Gail Martin, Sr.
Sales Manager, Distributor Products: Joe Green
Chief Engineer: Tad Inui
Products: engineered VMS series sound systems, microcomputerized EXES intercom systems, commercial sound systems, amplifiers, dual amplifiers, equalizers, multifunctional preamplifiers, mixing consoles, horns, drivers, speakers, wireless systems, microphones
See full listing under **Engineered Sound Systems**.

UREI, 8500 Balboa Blvd., Northridge, CA 91329
Tel.: 818-893-8411

President: Ron Means
Vice President: Ken Lopez
Vice President, Marketing: Mark Gander
Applications Engineer: Drew Daniels
Products: power amplifiers, limiters, compressors, equalizers, filters, Time Aligned™ speakers, direct boxes, electronic crossover, digital metronome, transcription preamplifier.
District Offices:
Steve Armstrong, 8500 Balboa Blvd., P.O. Box 2200, Northridge, CA 91329
Neil Conley, 3117 Murphy, Bedford, TX 76021
Bill Hamilton, 615 7th Ave., Folsom, PA 19033
Tom Roseberry, 3040 Charlevoix Dr. S.E., Grand Rapids, MI 49506
E.S. Gould Marketing Ltd., 6445 Cote de Liesse, Montreal, Que. H4T 1E5 Canada

URSA MAJOR, INC., P.O. Box 28, New Town Branch,
Boston, MA 02258 Tel.: 617-924-7697

President: Christopher Moore
Director of Marketing: Gerard Abeles
Chief Engineer: Christopher Moore
Products: digital reverberation systems: Space Station SST-282, 8X32-MKII, StarGate 323, StarGate 626 and MSP-126 Multi-Tap stereo processor.

VALLEY PEOPLE, INC., P.O. Box 40306, 2817 Erica
Pl., Nashville, TN 37204 Tel.: 615-383-4737

President: Norman Baker
Sales Manager: Ray Updike
Chief Engineer: Michael Morgan
Products: peak, averaging, RMS limiters, compressors, voice-over devices, expanders, keyable noise gates, de-essers, equalizers, transformerless mic preamps, line amplifiers/attenuators, voltage controlled amplifiers, gain cells, transistor arrays.
District Offices:
Allied Broadcast Equipment, 635 South E. Street, Richmond, IN 47374-8487
Martin Audio, 423 W. 55th St., 6th Floor, New York, NY 10019
Valley Audio, 2821 Erica Place, Nashville, TN 37204
J-Mar Electronics, Ltd., 6 Banigan Drive, Toronto, Ontario, M4H1E9 Canada
Westlake Audio, 2765 Santa Monica Blvd., Los Angeles, CA 90046

WHITE INSTRUMENTS, INC., P.O. Box 698, Austin,
TX 78767 Tel.: 512-892-0752
Telex 776409 White INST AUS

President: Thomas H. White
Sales Manager: Emory E. Straus
Chief Engineer: Carl Van Ryswyck
Products: real-time analyzers; active and passive equalizers (broad band and narrow band); filters; low level crossover networks; masking noise generators and equalizers.
District Offices:
Audio Marketing Assocs., 9470 Whitewood Rd., Brecksville, OH 44141
Bencsik Assocs., 3730 N.E. 42nd Lane, Ocala, FL 32670
LSM, 27 Orchard Park, Phelps, NY 14532
Richard S. Pass Assocs., Inc., 27 Oxford Dr., Langhorne, PA 19047
Metrorep Sales, Inc., 57 South St., Freehold, NJ 07728
Dick Schnepf Assocs., 15649 Kalisher St., Granada Hills, CA 91344
Gemini Electronics Marketing, 115 4th Ave., S. #B, Edmonds, WA 98020
Pro Marketing Systems, Inc., 9628 Day Dr., Indianapolis, IN 46280
Rancilio Assocs., 84 Grasso Plaza, St. Louis, MO 63123
Rep Tech Inc., Rt. 4, Box 326, Terrell, TX 75160
Shalco Inc., 570 Livernois Ave., Ferndale, MI 48220
Steve Fisher Assocs., 3726 W. Roanoke Ave., Phoenix, AZ 85009
The Smith Co., 85 Prospect Ave., Hartford, CT 06106
Warren Assocs., 2338 Calle Del Mundo, Santa Clara, CA 95050
Wilson Audio Sales, 6602 Hwy. 100, #205, Nashville, TN 37205
Wes Alderson Co., 8548 Washington Blvd., Culver City, CA 90230
Ziskind Assocs., 5420 Newport Dr. #52, Rolling Meadows, IL 60008

BOB WHITE ASSOCIATES, P.O. Box 39104, Solon,
OH 44139 Tel.: 216-248-1317

President: Bob White
Sales Manager: Tod White
Chief Engineer: George White
Products: professional sound products, audio.
See full listing under **Pro Audio Sound Systems**.

AUDIO-VISUAL EQUIPMENT & SYSTEMS

ARGOS PRODUCTS CO., 600 S. Sycamore St., Genoa,
IL 60135 Tel.: 815-784-5118

President: D. C. MacLaughlin
Sales Manager: Ron Evers
Chief Engineer: Loren Shroder
Products: indoor, outdoor sound columns, packaged sound systems,
portable PA systems, lecterns, baffle/speaker combinations, baffles,
speaker systems and enclosures.
See full listing under **Loudspeakers & Accessories**.

AUDIO ACCESSORIES, INC., Mill St., Marlow,
NH 03456 Tel.: 603-446-3335

President: M. B. Hall
Sales Manager: David Hall
Plant Manager: T. J. Symonds
Products: jack panel assemblies and accessories; patch cords; panels,
bakelite; phone plugs and phone jacks; wired jack panels. All miniature
and full-size.

BES, Bertagni Electroacoustical Systems, 12753
Moore St., Cerritos, CA 90701
Tel.: 213-926-0201

President: Lynn Morrison
Sales Manager: Irv Weisman
Chief Engineer: Alex Bertagni
Products: high performance line of hemispherically radiating ceiling
speakers that closely resemble ceiling tiles. Because of their 180° disper-
sion pattern, these speakers can replace conventional cone type ceiling
speakers by as much as 8 to 1, drastically reducing installation and
material cost; also omni-directional outdoor sound reinforcement
speakers. See full listing under **Loudspeakers & Accessories**.

COMMUNICATIONS CO., INC., 3490 Noell St., San
Diego, CA 92110 Tel.: 619-297-3261

President and Sales Manager: Peter T. Jordan
Chief Engineer: David Johnson
Products: programmable two-way intercom amplifier w/vox., media
distribution amplifier, projector patch, room combining systems, record
patch, RT-60 reverberation measuring device, burst octave noise
generator, 1/3 octave real time analyzer, 27 B.I.T. oscilloscope adap-
tor, audio inductive loop receivers.
See full listing under **Intercom Systems Institutional**.

**DUKANE CORPORATION, Communications
Systems Division**, 2900 Dukane Dr., St. Charles,
IL 60174 Tel.: 312-584-2300

General Manager: William B. Clark
Marketing Manager: Craig E. Lyons
Chief Engineer: Paul D. Graham
Products: communications systems including intercom, public address
and background music, professional sound, radio paging, nurse-patient
communications, personnel registers and master clock systems.

MACKENZIE LABORATORIES, INC., 5507 Peck Rd.,
Arcadia, CA 91006 Tel.: 818-579-0440
800-423-4147

President: A. R. Taylor
Vice President and Chief Engineer: N. Khattar
Products: Z-Mac audio visual control systems for boardrooms and com-
munications centers. Customized control panels. Control modules for
volume, 16mm, slide, video, screens, drapes, houselight dimmers.
See full listing under **Magnetic Tape Systems & Supplies**.

MAGNASOUND, Div. of UXL Corp., 108-02 Otis
Ave., Corona, NY 11368 Tel.: 718-271-5200

President: B. Frank
Sales Manager: J. Miner
Chief Engineer: S. Guardì
Products: Portacaster — portable, battery-powered, self-contained PA
system with half-mile range. Campaigner — removable, car-top PA
system. Amplifiers. FM tuner for background music. Voice Beamer
— amplified sound lectern series.

P/H ELECTRONICS, INC., 117 E. Helena St., Dayton,
OH 45404 Tel.: 513-461-5898

President: N. G. Anderson
Sales Manager: D. C. Martin
Chief Engineer: V. M. Pantelic
Products: multi-channel wireless simultaneous interpretation systems.
Single channel wireless listing systems and wireless language laboratories.

TAMCO SYSTEMS, INC., 2020 Jericho Turnpike,
New Hyde Park, NY 11040 Tel.: 516-437-8200

Director of Marketing: Glenn C. Kern
Products: custom A/V system design, fabrication and installation for
conference, board and training rooms. Teleconferencing systems. Video
projection. Remote control of VCR, film, slides, microphones, environ-
ment. Computer interfacing.

TELEX COMMUNICATIONS, INC., 9600 Aldrich Ave.
S., Minneapolis, MN 55420 Tel.: 612-887-5531
612-884-4051

President: John Howe
Vice President, Marketing: Pat Gillette
Marketing Director: Dan Paulnock
Products: language laboratories, headsets, tape duplicators, 35mm slide
and filmstrip projectors, 16mm film projectors
See full listing under **Pro Audio Sound Systems**.



TSI, 393 Jericho Turnpike, Mineola, NY 11501
Tel.: 516-294-5390

Director of Marketing: Glenn C. Kern
Products: custom AV system design, assembly, installation and service
for conference, board and training rooms. Teleconferencing systems.
Video projection. Remote control of VCR, film, slides, microphones,
room lighting, draperies, environment. Computer interfacing.

VERREX CORPORATION, 1130 Route 22 West,
Mountainside, NJ 07092 Tel.: 201-232-7000

Sales Manager: Richard Krochmal
Chief Engineer: David G. Butz
Products: supplier of engineered audio-visual systems world wide, since
1946. Systems supplied to contractors and end users such as boardrooms,
telecommunications, theater and audio-visual systems.

BACKGROUND/ FOREGROUND MUSIC SYSTEMS

ARGOS PRODUCTS CO., 600 S. Sycamore St., Genoa, IL 60135 Tel.: 815-784-5118

President: D. C. MacLaughlin

Sales Manager: Ron Evers

Chief Engineer: Loren Shroder

Products: indoor, outdoor sound columns, packaged sound systems, portable PA systems, lecterns, baffle speaker combinations, baffles, speaker systems and enclosures.

See full listing under **Loudspeakers & Accessories**.

AUDIO ENVIRONMENTS INC., 900 E. Pine St., Seattle, WA 98122 Tel.: 206-329-1400
Product inquiries only: 800-831-8001

President: Michael J. Malone

Director, National Dealer Sales: Jack Craig

Chief Engineer: Tom Carpenter

Products: programs of contemporary music; tape playback units (amplified and non-amplified). Package service/system (including monthly tape-exchanges).

District Offices:

230 Northland Blvd., Cincinnati, OH 45246

8163 Melrose Ave., W. Hollywood, CA 90046

126 Madison Ave., New York, NY 10016

1500 N. Halstead, Chicago, IL 60622

BGM INTERNATIONAL, P.O. Box 8057, Pensacola, FL 32505 Tel.: 904-434-1953

Owner: Frederic T. C. Brewer

Products: background music programs for SCA, central studio telephone, CATV, on premise; general, up-tempo, beautiful music; associated studio equipment also available.

BOGEN, A Lear Siegler Company, Box 500, Paramus, NJ 07653 Tel.: 201-343-5700

President: John H. Ochtera

Vice President, Marketing: Carl C. Dorwaldt

Vice President, Engineering: Mark Koller

National Sales Manager: Art Arlow

Products: background music/P.A. amplifiers with built-in paging precedence. Speakers, FM/AM tuners, receivers, tape players, microphones and their accessories, multiple-tone generator for complete background music system with public address.

See full listing under **Engineered Sound Systems**.

CASCO BACKGROUND SOUND, INC., P.O. Box 115, 50 Terminal St., Charlestown, MA 02129
Tel.: 617-242-2983

President: Samuel J. Blengs

Products: direct drive tape player, 1 7/8 ips, 32 hours continuous music, loop cartridge with sealed heads; cartridges exchanged every 90 days; custom, jingles, seasonal music available. Sales, rentals, leases.

CETEC RAYMER, 7315 Fulton Ave., N. Hollywood, CA 91605
Tel.: 213-875-0423

President: Richard P. Drake

Chief Engineer: Clifford L. Kogge, Jr.

Products: background/foreground equipment: wall and shelf mount amplifiers, AM/M tuners and paging receivers, microphone mixers, installation accessories and transformers, M-O-H and telephone interconnect devices and test equipment.

District Offices:

Adams & Assocs., 1300 Westover Terr., Greensboro, NC 27408

William C. Allison, 7315 Fulton, No. Hollywood, CA 91605
Mike Berman Sales, 8631 E. Prairie Rd., Skokie, IL 60076
Ray Colen Sales Inc., 169 Stadium Ave., Mill Valley, CA 94941
Engineered Sound Systems, 3078 Jarrow Ave., Mississauga, Ont. Canada

Steve Fisher Assocs., P.O. Box 14896, Phoenix, AZ 85063

Lewis E. Jones, 6233 Haddington Dr., Memphis, TN 38138

McMillan Electronics, 16679 S.W. Maple Circle, Lake Oswego, OR 97034

Midstates Marketing, 1122 E. Washington St., #100, Indianapolis, IN 46202

Gilbert E. Miller Assocs., 28 Knollwood Ave., Stamford, CT 06905

Nevo Inc., 2701 Rockcreek Pkwy., #221, N. Kansas City, MO 64117

Northland Assocs., 1012 19th Ave. S., Moorhead, MN 56560

John O. Olsen Co., 3604 Coral Gables Rd., Cincinnati, OH 45248

Richard S. Pass Assocs., 27 Oxford Dr., Langhorne, PA 19047

The Smith Co., 599 New Park Ave., W. Hartford, CT 06110

T. A. Electronic Sales Co., 4626 1/2 Walton Blvd., Drayton Plains, MI 48020

Techno Assocs., 2324 Shorecrest Dr., Dallas, TX 75220

World Wide Electronics, P.O. Box 840207, Pembroke Pines, FL 33084

Norris and Warren Assocs., 2030 Roca Roja Cir., Colorado Springs, CO 80906

J. W. DAVIS & CO., 3215 Canton St., P.O. Box 26177, Dallas, TX 75226 Tel.: 214-651-7341
1-800-442-1564 WATS Texas
1-800-527-5705 (outside Texas)

President: M. H. Earp

Executive Vice President: W. A. Hevron

Chief Engineer: J. E. Mitchell

Products: ceiling speakers, wall baffles, transformers, controls and power amplifiers including AM-FM tuners, microphones, etc. for all background and foreground music applications.

DUKANE CORPORATION, Communications Systems Division, 290 Dukane Dr., St. Charles, IL 60174 Tel.: 312-584-2300

General Manager: William B. Clark

Marketing Manager: Craig E. Lyons

Chief Engineer: Paul D. Graham

Products: communications systems including intercom, public address and background music, professional sound, radio paging, nurse-patient communications, personnel registers and master clock systems.

DYNAMIC SOUND INDUSTRIES, P.O. Box 1395, LaBelle, FL 33935 Tel.: 813-675-0100

Chief Engineer: U. L. Lahti

Products: products manufactured under patented pressure velocity formula for symmetrical dispersion. Speaker systems for ceiling, plenum, partition and floor custom designs for music paging and sound masking.

Sales Representative:

Don Heavenor, 7936 Comino Circle, Miami, FL 33143

EMS/MUSIC, 2264 15th Ave. W., Seattle, WA 98119
Tel.: 206-281-8686

President: R. K. Hughes

Sales Manager: Richard D. Bothell

Chief Engineer: R. K. Hughes

Products: complete foreground music tape library and is the original manufacturer of six tape cartridge players for music play, message insertion and systems amplification.

GEMCO ELECTRONICS, P.O. Box 993, Gallatin, TN 37066
Tel.: 615-452-5960

President: Jerry Graves

GROMMES, PRECISION ELECTRONICS, INC.,
9101 King St., Franklin Park, IL 60131
Tel.: 312-678-5350

President: W. S. Grommes
Sales Manager: W. Stow
Chief Engineer: A. A. Hart
Products: integrated audio amplifiers, amps for mono or stereo power, line, music-on-hold. Mixer preamplifiers, 2 CH. limiters or compressors, graphic equalizers, FM-AM tuners, background music receivers and systems, public address systems, custom engineered sound reinforcement systems, sound columns, trumpets, driver units, baffles, microphones and microphone stands.
See listing under **Audio Amplifiers**.

HARRIS CORP., DRACON DIV., 809 Calle Plano,
Camarillo, CA 93010 Tel.: 805-987-9511

Vice President, General Manager: John R. Mason
Sales Manager: Tom Erdmann
Chief Engineer: Joe Mader
Products: FM Music Source which provides music for various applications, such as music-on-hold for telephone systems or background music for a paging system.
See full listing under **Paging Systems—All Types**.

IGM COMMUNICATIONS, INC., 282 West Kellogg
Road, Bellingham, WA 98226
Tel.: 206-733-4567

President: Jim Wells
Sales Manager: Nick Solberg—Custom Systems
Sales Manager: Fred Harkness—Standard Systems
Chief Engineer: Jim Wolniakowski
Products: Go Cart random access cartridge playback unit. Instacart—instant access cartridge playback unit. IGM-SC—a system controller.

MAGNE-TRONICS, INC., 93 Broad St., Matawan,
NJ 07747 Tel.: 201-566-9600

President: John H. Bolendz
Products: subscription service featuring many formats of taped music programs for background music services via FM, SCA, phone lines, on premise and cable.

McGOHAN ELECTRONICS, INC., 1033 Fairway Dr.,
Bensenville, IL 60106 Tel.: 312-595-2342

President and Sales Manager: James M. McGohan
Products: solid state amplifiers for commercial sound and background music/mic mixers, zone pagers, mic and telephone line transformers and other accessories—off the shelf stock.
See full listing under **Audio Amplifiers**.

McMARTIN INDUSTRIES, INC., 4500 S. 76th St.
Omaha, NE 68127 Tel.: 402-331-2000

President: Ray B. McMartin
Vice President, Sales: Jay B. McMartin
Products: transistor engineered and commercial sound amplifiers/mixers/accessories, background music amplifiers and sound systems, SCA and loudspeaker test sets, AM/FM monitors, transmitters, AM/FM single channel receivers, audio consoles, emergency broadcast systems.
See full listing under **Audio Amplifiers**.

MG ELECTRONICS, 32 Ranick Rd., Hauppauge, NY
11787 Tel.: 516-582-3400

President: Louis Maltz
Vice President: Elliott Maltz
Sales Manager: Stan Grey
Products: 8" PA speakers with and without transformers, dual cone speakers, coaxial speakers, etc. Full line of mini speaker systems with hang-on mounting brackets.

MILLBANK ELECTRONICS GROUP LTD., Bell-
brook Industrial Estate, Uckfield, Sussex, TN22
1QL England Tel.: Uckfield 825-4811

Chairman and Marketing Director: Tony Walker
Director and General Manager: Brian Evans
Director C.T.S.D. Systems: Bernard Skinner
Engineering Manager (Sales): Doug Edworthy
Products: custom engineered sound systems; public address, tele-conference, life-safety. Sound reinforcement systems: amplifiers, preamplifiers, background music, FM/AM tuners, alarm and tone signal generators, loudspeakers, microphones.
See full listing under **Engineered Sound Systems**.

MUSIC PROGRAMMING INC., 265 Concord St.,
Framingham, MA 01701 Tel.: 617-875-3530

President: Ray Regis
Sales Manager: Dutch Blue
Chief Engineer: Jon Rhind
Products: programs for background, midground and foreground music
Unlimited hours with no repeats. For central studio distribution cable and/or on premise.

MUSIC THEATRE NETWORK INC., 83 Chapel St.,
Newton, MA 02195 Tel.: 617-244-5440
Telex: 200080 (MTN1)

Vice President: Georges Tcherkassky
Sales Manager: Patrick Merlino
Products: sealed continuous loop cartridge operating at 3¼ ips holding up to 24 hours with twenty-eight different categories of music, including all types of ethnic music.

OWI INC., 1160 Mahalo Pl., Compton, CA 90220
Tel.: 213-638-4732

President and Sales Manager: Ned Morioka
Chief Engineer: Hiro Okayama
Products: hi fidelity mini speakers w/built in 70 volt and 25 volt line transformer and weatherized/standard systems for foreground and background applications.

PENTAGON INDUSTRIES, INC., 5115 N. Sheridan
Road, Chicago, IL 60640 Tel.: 1-800-621-3867

President: Lateef M. Khan
Sales Manager: Gopal Muntha
Products: auto-reverse cassette changer. Four servo drive, sequentially operated, auto reverse cassette decks. Provides over 8 hours of continuous background music. Response to over 12,000 Hz.
District Offices:
Encore Marketing, P.O. Box 386, Kenilworth, IL 60043
Raleigh Perry & Associates, P.O. Box 542, Buford, GA 30518
Evans Marketing, 655 Skyway Road, San Carlos, CA 94070
Pusecker Sales, 372 Upper Mountain Ave., Upper Montclair, NJ 07043
Richard Pass & Associates, 27 Oxford Dr., Langhorne, PA

PHI TECHNOLOGIES, INC., 4605 N. Stiles, Oklahoma
City, OK 73105 Tel.: 405-521-9000

President: Henry E. Juskiewicz
Sales Manager: Gary A. Zebrowski
Chief Engineer: Larry Debell
Products: heavy-duty cassette tape transports, random-access message systems, cassette playback units for background music, message repeaters, and digital audio message systems.

RMI, 5142 Bolsa Ave., #103, Huntington Beach, CA
92647 Tel.: 714-891-5302

Owner: Edward S. Cleland
Products: tape cartridge playback equipment. Beautiful general background music programs including largest variety of specialty tapes. Subscriber given unlimited tape exchange privileges.

ROWE INTERNATIONAL, INC., Customusic Div.,
75 Troy Hills Road, Whippany, NJ 07981
Tel.: 201-887-0400

National Sales Manager: Ted Lloyd
Sales Coordinator: Beverly LaForte
Products: Customusic Programasters in 3 modes with accessories.
Customusic® programs: two 60-hour libraries with refresher program every 120 days. Atmosphere - commercial and one 24-hour library with refresher program every 30 days, foreground.

SEEBURG MUSIC SATELLITE NETWORK, 5706 New
Chapel Rd., Raleigh, NC 27607
Tel.: 919-851-5823

General Manager: William E. Fox
Distributor Relations Manager: Sherrill Williams, Sr.
Products: background and foreground music for all industrial and commercial applications.
See full listing under **Loudspeakers & Accessories.**

SOUNDOLIER, 9380 Watson Industrial Park, St. Louis,
MO 63126 Tel.: 314-962-9870

Vice President/Director of Marketing: Herbert M. Jaffe
Director of Sales: Paul Grote
National Sales Manager: Tony Dalba
Chief Engineer: John Saller
Products: high quality, commercial sound loudspeakers, enclosures and accessories for music, alarm and public address systems, baffles for ceilings and walls, matching transformers and backbox enclosures.
See full listing under **Loudspeakers & Accessories.**

SOUND PRODUCTS/3M, 3M Center 225-3N-04,
St. Paul, MN 55144 Tel.: 612-733-0447

Marketing Manager: Don Rada
Sales Manager: Jack Dingley
Products: music libraries for all purposes. Reliable player. Industrial quality intercoms. Top-line message repeater. Speaker assemblies for distributed systems. Microphones, amplifiers and other sound system components.

SPECO DIV., Components Specialties, Inc., 1172 Rt.
109, P.O. Box 624, Lindenhurst, NY 11757
Tel.: 516-957-8700 (in NY)
1-800-645-5516 (outside NY)

President: Louis W. Keller
Vice President: Stan Hulkower
Chief Engineer: James Ganci
Director Sales and Marketing: Mel Hulkower
Products: P.A. horns, amplifiers, tuners, loudspeakers, wall baffles, speaker assemblies, outdoor speakers, sound columns, ceiling grilles, transformers, L-pads, attenuators, accessories, microphones, intercoms, alarm sirens, multitestors, oscilloscopes.

TAPE-ATHON CORP., 13633 Crenshaw Blvd., Haw-
thorne, CA 90250 Tel.: 213-676-6752

President: Lee Tate
Director of Sales: Robert Mayfield
General Manager: Bob Haller
Chief Engineer: Bernard Sayers
Products: reel-to-reel, dual cassette on-premise systems, rack-mounted or portable, complete automated central studio systems, chimes and carillon systems, message insertion units, full audio-master amplifier line, customized background/foreground libraries.
District Offices:

Chuck Olson Assocs., 17003 S.E. 136th, Renton, WA 98055
Warren Assocs., 2338 Calle Del Mundo, Santa Clara, CA 95050
Pinz Sales Corp., 570 Yonkers Ave., Yonkers, NY 10704
Emarcon, Inc., 8811 Manderley Dr., Indianapolis, IN 46240
John E.M. Anderson Co., 5231 Humbolt Ave., S., Minneapolis, MN 55419

R.L. Graham Assocs., 9201 Belinder Rd., Leawood, KS 66206
Murphy & Cota, 500 Plasamour Dr. N.E., Atlanta, GA 30324

AV West Inc., 17181 Kirk Lane, Fountain Hills, AZ 85268
Associated Sales Reps, 403 Fieldstone Ct., Fallston, MD 21047
Bencsik Assocs., 3730 N.E. 42nd Lane, Ocala, FL 32670
Avcom Inc., 27733 Lorain Rd., N. Olmsted, OH 44070
Ken Levy & Assoc., 6430 N. Central Ave., Chicago, IL 60646
Design Factors, 355 E. Canada Sombre, La Habra Heights, CA 90631

VIF INTERNATIONAL, P.O. Box 1555, Mountain
View, CA 94042 Tel.: 408-739-9740

President: N. L. Mackechnie
Products: background music tape reproducers (manufacture and service); accessories and spare parts for pro audio tape recorders. Background music leasing services.

YESCO FOREGROUND MUSIC, 915 Yale Ave. N.,
Seattle, WA 98109 Tel.: 206-682-3737
800-426-9248

President: Mark Torrance
Sales Manager/Marketing: Ken Heim
National Dealer Director: Julie McCullough
Products: full service audio and video company. Foreground and background music programs nationally distributed, playback units (amplified and non amplified) on premise and central studio formats.
District Offices:
Yesco Systems, 123 West Harrison, Seattle, WA

BELLS, BUZZERS, GONGS

ATLAS SOUND, 10 Pomeroy Rd., Parsippany, NJ
07054 Tel.: 201-887-7800

Vice President Marketing: Herbert M. Jaffe
National Sales Manager: David A. Chambers
Chief Engineer: Bob Greulich
Products: signaling components both audio and visual for indoor and outdoor installation including life-safety, fire alarm signaling, telephone communications and audio detection.
See full listing under **Loudspeakers.**

FARADAY, INC., 805 S. Maumee St., Tecumseh, MI
49286 Tel.: 517-423-2111

President: G. Rummell
Sales Manager: J. Frankow
Chief Engineer: R. Miller
Products: intercom and sound distribution systems, public address systems, nurse call systems, fire alarm, annunciator, clock and hospital life safety systems, full range of signaling products.
See full listing under **Alarm, Security & Life-Safety Systems.**

MALLORY CAPACITOR CO., 3029 E. Washington St.,
P.O. Box 372, Indianapolis, IN 46206
Tel.: 317-636-5353

President: S. Murray
Vice President Sales and Marketing: R. Patrick
Products: Sonalert® electronic audible signals, fast pulse; slow pulse; continuous pulse—with no arcing, no moving parts and no mechanical wear.

MCGOHAN ELECTRONICS, INC., 1033 Fairway Dr.,
Bensenville, IL 60106 Tel.: 312-595-2342

President: James M. McGohan
Products: solid state amplifiers for commercial sound and background music/mic mixers, zone pagers, mic and telephone line transformers and other accessories—off the shelf stock.
See full listing under **Audio Amplifiers.**

VALCOM, INC., 1111 Industry Ave., Roanoke, VA
24013 Tel.: 703-982-3900

President: J.W. Mason
Sales Manager: Donald Buck
Chief Engineer: D. Lynch

Products: telephone integrated paging and intercom systems, talkback, bell-buzzer, code call, PBX adapters, key telephone system ancillaries, loud ringers, power supplies, amplified and talkback speakers. Single line and feature telephones.

See full listing under **Paging Systems — All Types.**

WHEELOCK, INC., 273 Branchport Ave., Long Branch,
NJ 07740 Tel.: 201-222-6880

President: Peter W. Tarlton
Sales Manager: Harry J. Foster

Products: audible/visual signaling devices for life safety and alarm systems and for telephone systems. Bells, horns, speakers, strobes, chimes and combinations.

Sales Representatives:

Gerry Ross, 51 Hartford Ave. E., Mendon, MA 01756
Tom Ryan, 14605 S.E. 266th St., Kent, WA 98042
Frank Malloy, P.O. Box 88962, Dun Woody, GA 30338
Peter Koehler, 2552 Royal Lane, Dallas, TX 75229

CABINETS & CONSOLES

COMMUNICATIONS EQUIPMENT CO., INC., 6443
Western Ave., Glen Arbor, MI 49636
Tel.: 616-334-3081

President: Hugh I. Morris

Sales Manager: Thomas A. Garmhausen

Products: standard steel and Formica laminated consoles, turrets and housings for mounting 19" rack panels. Custom enclosures for electro-mechanical instrumentation and equipment.

See full listing under **Engineered Sound Systems.**

**DUKANE CORPORATION, Communications
Systems Division**, 2900 Dukane Dr., St. Charles,
IL 60174 Tel.: 312-584-2300

General Manager: William B. Clark
Marketing Manager: Craig E. Lyons
Chief Engineer: Paul D. Graham

Products: communications systems including intercom, public address and background music, professional sound, radio paging, nurse-patient communications, personnel registers and master clock systems.

EQUIPTO ELECTRONICS CORP., 351 Woodlawn
Ave., Aurora, IL 60507 Tel.: 312-897-4691

President: Robert Golz
Sales Manager: Larry Suggett
Chief Engineer: Ken Gazarek

Products: sheet steel cabinets, consoles and desks for housing electronic instrumentation and electro mechanical devices.

HAMMOND MANUFACTURING CO., INC., 1690
Walden Ave., Buffalo, NY 14225
Tel.: 716-894-5710

Sales Manager: Raymond C. Shatzel

Products: complete line of enclosure products for the commercial sound contractor. Racks, cases, cabinets, baffles, a wide range of mounting accessories and complete line of audio transformers.

HARRIS CORP., DRACON DIV., 809 Calle Plano,
Camarillo, CA 93010 Tel.: 805-987-9511

Vice President/General Manager: John R. Mason
Sales Manager: Tom Erdmann
Chief Engineer: Joe Mader

Products: telephone integrated loudspeaker paging systems; linemen's test sets; craft tools; power supplies; DC-DC converters and extensive line of relay racks. Special order cabinets and consoles.
See full listing under **Paging Systems—All Types.**

HOUSE OF METAL ENCLOSURES, INC., P.O. Box
225, Hermann, MO 65041 Tel.: 314-486-3114

President: A. P. Brigham

Marketing Manager: R. L. Kastel

Products: standard, modified, custom-designed electronic enclosures. Racks, wall-mounted and desk-top cabinets, turrets, consoles, panels and accessories for 19" equipment.

District Offices:

Associated Sales Reps, 908 Mill Grove Dr., Audobon, PA 19403
David H. Brothers Co., 19 Old Court Rd., Baltimore, MD 21208
Givan-Flanagan Assocs., 107 Pierce St., W. Boylston, MA 01583
Hutmacher Assocs., 1014 Busse Hwy., Park Ridge, IL 60068
Northland Assocs., Box 429, Moorehead, MN 56560
Chuck Olson Assocs., 17003 S.E. 13th, Renton, WA 98055
Peregrine S.W. Reps, Inc., 5800 Corp. D-5, Houston, TX 77036
Rohr-Wanger-Roberts, Inc., 1169-D W. Oakland Ave., Rock Hill,
SC 29730

Weller Electronics, 5274 Sinclair Rd., Columbus, OH 43229

Ted Firaneck Sales, 2685 LaPeer, Pontiac, MI 48057

Hutto, Hawkins, Peregoy, 139 Candace Dr., Maitland, FL 32751

Marcus Johnson, 217 N. Main St., St. Charles, MO 63301

Kingston Sales, 6115 Guion Rd., Indianapolis, IN 46254

Paul Pusecker Sales, 372 Upper Mountain Ave., Upper Montclair,
NJ 07043

Silver Peak Marketing, 2700 Youngfield, Lakewood, CO 80215

S.L.K./Tech Rep, 2301 Industrial Pkwy. W., Hayward, CA 94545

Waxman Sales, 990 Kenmore Ave., Buffalo, NY 14216

White Radio Ltd., 940 Gateway Dr., Burlington, Ont. L7L 5K7
Canada

NEOTEK CORPORATION, 1154 W. Belmont Ave.,
Chicago, IL 60657 Tel.: 312-929-6699

President: Craig Connally

Sales Manager: Greg Braithwaite

Chief Engineer: Craig Connally

Products: "built to order" audio control consoles for 4 or 8 track recording, multi-track recording, broadcast production, theater effects and sound reinforcement, TV/film production and sophisticated sound reinforcement.

PREMIER METAL PRODUCTS CO., 381 Canal Pl.,
Bronx, NY 10451 Tel.: 212-993-9200

President: Stanley Kwasnicki

Sales Manager: Anthony Bozza

Chief Engineer: Frank Soranno

Products: cabinets, racks, cases, chassis, fans, slides and blowers for electronic equipment.

SOUNDOLIER, 9380 Watson Industrial Park, St. Louis,
MO 63126 Tel.: 314-962-9870

Vice President/Director of Marketing: Herbert M. Jaffe

Director of Sales: Paul Grote

National Sales Manager: Tony Dalba

Chief Engineer: John Saller

Products: high quality, commercial sound loudspeakers, enclosures and accessories for music, alarm and public address systems, baffles for ceilings and walls, matching transformers and backbox enclosures.
See full listing under **Loudspeakers & Accessories.**

CHURCH CARILLONS & CHIMES

MAAS-ROWE CARILLONS, 2255 Meyers Ave.,
Escondido, CA 92025 Tel.: 619-743-1311

President: Paul H. Rowe

Product: complete line of church bells and carillons from pre-recorded to digitally operated systems.

SCHULMERICH CARILLONS, Carillon Hill, Sellersville, PA 18960 Tel.: 215-257-2771

President: Ronald O. Beach
Vice-President/Sales: Creed Freeman
Sales Managers: Frank Keating and Jack O'Brien
Chief Engineer: Charles Vaccaro
Products: bells and carillons.

TAPE-ATHON CORP., 13633 Crenshaw Blvd., Hawthorne, CA 90250 Tel.: 213-676-6752

President: Lee Tate
General Manager: Bob Haller
Sales Manager: Bob Mayfield
Products: complete line reel-to-reel play back from on-premise through completely automated central studio systems, portable and rack mount, chimes line; all speed - customized music library — sale or lease.
See full listing under **Background/Foreground Music Systems**.

CCTV SYSTEMS & PRODUCTS

CREST ELECTRONICS INC., 4921 Exposition Blvd., Los Angeles, CA 90016 Tel.: 213-731-1105

President: Hope Borows
Sales Manager: Dennis Castelli
Chief Engineer: Ken Fukui
Products: CCTV cameras, video monitors, time lapse recorders, modulators, lenses, switchers, housings, mounts, tubes, pan and tilts, scanners, dummy cameras, quad split screen systems.
District Offices:
Irv Brown, 401 Kingston Ave., Brooklyn, NY 11225
Mike Bermann, 8631 E. Prairie Road, Skokie, IL 60076
Pacnor Marketing, 21026 67th St. West, Lynnwood, WA 98036
Honeypole Enterprises, 9837J Folsom Blvd., Sacramento, CA 95827
Forti Associates, 3519 Raymoor Road, Kensington, MD 20895

J. W. DAVIS & CO., 3215 Canton St., Dallas, TX 75226
Tel.: 214-651-7341 Texas WATS: 800-442-1564
National WATS: 800-527-5705

President: M. H. Earp
Sales Manager: W. A. Wadkins
Chief Engineer: J. E. Mitchell
Products: closed circuit television cameras with a wide assortment of lenses and accessories including mounts, enclosures, switches, controls and monitors. Available with intercom capabilities if required.

DYNAIR ELECTRONICS, INC., 5275 Market St., San Diego, CA 92114 Tel.: 619-263-7711

President: E. G. "Garry" Gramman
Sales Manager: Robert A. Jacobs
Chief Engineer: Robert Wincentsen, V.P.
Products: audio and video switching and distribution systems designed for aerospace, broadcast, CATV, communications, CCTV and other related markets.
District Office:
88 Summit Pl., Pleasantville, NY 10570

ELBEX AMERICA, 20630F S. Leapwood Ave., Carson, CA 90746 Tel.: 213-515-0854

Secretary/Treasurer: Ken Rock
Chief Engineer: Cam Cotrill
Products: completely integrated CCTV system utilizing single-cable installation.

ELECTRO-VOICE, INC., 600 Cecil St., Buchanan, MI 49107 Tel.: 616-695-6831

President: Robert D. Pabst
Vice President, Marketing and Sales Manager: Paul McGuire
Director of Marketing, Professional Sound Reinforcement
Products: Jim Long
Chief Engineer: Earl Harris
Products: broadcast, recording, communications and PA microphones; public address and component high-fidelity loudspeakers, systems and enclosures; sound reinforcement products.
See full listing under **Microphones**.

FSR, INC., 40 Commerce Rd., Cedar Grove, NJ 07009
Tel.: 201-783-3966

Sales Manager: Janice Sandri
Products: conference room control systems, teleconferencing systems, remote control modules for: audio attenuation, ramp generators, microphone switching, slide and 16mm projectors, video switchers, floor boxes.

GBC CLOSED CIRCUIT TELEVISION CORP., 315 Hudson St., New York, NY 10013
Tel.: 212-989-4433

President: Stephen Lefkowitz
Sales Manager: Gary Perlin
Chief Engineer: Edward Ickowski, V.P.
Products: closed circuit TV cameras, monitors and all hardware such as outdoor weatherproof housings and lenses, video sensors, low light and solid state cameras.
District Offices:
GBC CCTV California Corp., 20620 S. Leapwood Ave., Carson, CA 90746
GVC CCTV Washington Corp., Riggs Rd. at 1st Pl., N.E. Washington, DC 20011

GENERAL ELECTRIC CO., 316 E. 9th St., Owensboro, KY 42301 Tel.: 502-685-6200

Sales Manager: Gene Olszewski
Products: closed circuit TV systems and products — including tubes, lenses (fixed focal, zoom and auto); monitors; scanners and pan & tilts; video switching and controls; brackets and video transmission, including microwave. For surveillance in commercial, government and industrial establishments.
District Offices:
For nearest sales representative or dealer call 1-800-438-2583 or write.

JAVELIN ELECTRONICS, INC., 19831 Magellan Dr., Torrance, CA 90502 Tel.: 213-327-7440

President: Donald T. Heckel
Vice President, Engineering: Raymond Payne
National Sales Manager: Bill Walters
Products: complete CCTV security systems including cameras, monitors, video tape recorders, lenses, cable, pan/tilts, video signal equipment and other accessories. Also, night viewing equipment.
District Offices:
Givan-Flanagan Assocs., 107 Pierce St., W. Boylston, MA 01583
Bencsik & Assocs., 3730 N.E. 42nd Lane, Ocala, FL 32670
Bi-State Marketers, Inc., 753 Bergen Blvd., Ridgefield, NJ 07657
Mets Lerwill, P.O. Box 698, Elk Grove, CA 95624

LCA SALES CO., 76 Main St., Tuckahoe, NY 10707
Tel.: 914-961-4700

Partner: Joel H. Schwartz
General Manager: R. R. Sherwood
Products: manufacturers' representatives for: Blonder-Tongue, BES, Carol Cable, Eaton/Dekorion, Gentex, Harrington, M/A-C Video/Data, N.I.T., Panasonic CCTV, Reliable Security, Siedle, University, Videoscope/Quadravision.
See full listing under **Alarm, Security & Life-Safety Systems**.

LEE DAN COMMUNICATIONS, INC., 155 Adams Ave., Hauppauge, NY 11788 Tel.: 516-231-1414

President: Leon Goldberg
Sales Manager: Lawrence Goldberg
Chief Engineer: Ted Jurgens
Products: Tek-View combination audio/visual intercom and door control systems for private homes, commercial applications and multi-unit housing.
See full listing under **Apartment House/Hi-Rise Intercoms**.

OPAMP LABS, INC., 1033 N. Sycamore Ave., Los Angeles, CA 90038 Tel.: 213-934-3566

Sales Manager: B. Losmandy
Products: audio consoles (kits and wired); amplifiers, D.C., mic preamp; E.Q., magnetic tape, oscillators, power supplies, transformers, reverbs, graphic equalizers, electronic matrices. Video distribution amplifiers. Audio-video switches rack-fitted.

PANASONIC INDUSTRIAL CO., Audio-Video Systems Division, One Panasonic Way, Secaucus, NJ 07094 Tel.: 201-348-7000

President: Ken Kurahashi
General Manager: Steve Yuhas
Sales Manager: Ted Conboy
Products: complete line of Vidicon and Newvicon CCTV cameras, single cable compact CCTV camera systems, high resolution and low light cameras, CPD solid state cameras, color and black/white monitors, time lapse recorders, time date generators, lenses, passive and sequential switches, remote control switches, relay boxes, video projection switches, and a complete line of accessories.
District Offices:
425 E. Algonquin Rd., Arlington Heights, IL 60005
6550 Katella Ave., Cypress, CA 90630
333 Meadowlands Pkwy., Secaucus, NJ 07094
1825 Walnut Hill Lane, Irving, TX 75062
1854 Shackelfort Court, Norcross, GA 30093
4060 Lind Ave. SW, Renton, WA 98055

SIEDLE INTERCOM/USA, 1 Wynnewood Rd., Wynnewood, PA 19096 Tel.: 800-874-3353

Sales Director: Earl Zausmer
Products: 2-wire apartment house intercoms for duplex communications between front door and apartment, chime announcement and door release operation from handset. Decentralized microprocessor intercom for all applications plus page with talkback. Modular mailbox systems. Video intercom systems. CCD ultra miniaturized camera for banks and special surveillance.

TELEVOX SYSTEMS (div. National Telesystem Ltd.), 438 Papin Ave., Ste-Foy, Quebec G1P 3T9 Canada Tel.: 418-659-3565

President: Charles Sirois
Sales Manager: Leopold Lambert
Chief Engineer: Marcel Langlois
Products: systems and equipment for audio-visual, CCTV/video, intercom (institutional), nurse/patient intercom, paging, school communication. Headphones and headsets, wire and cable, loudspeakers and accessories, microphones.

USATCO (Universal Satellite Corp.), 300 E. 59th St., New York, NY 10022 Tel.: 718-786-1510

President: Henry Schwartz
Sales Manager: Steve Emspak
Products: videomate large screen video and data projectors, computer interfaces.

VERREX CORPORATION, 1130 Rt. 22W, Mountainside, NJ 07092 Tel.: 201-232-7000

President: Thomas G. Berry
Sales Manager: Richard Krochmal
Chief Engineer: David G. Butz

Products: supplier of engineered CCTV/video systems world wide since 1946. Systems supplied to contractors and end users such as casinos, manufacturing and chemical plants, schools, hospitals, etc.

VICON INDUSTRIES, INC., 525 Broad Hollow Rd., Melville, NY 11747 Tel.: 516-293-2200

President: Donald N. Horn
Executive Vice President: Arthur V. Wallace
Vice President, Sales: Ronald Klein
Vice President, Engineering: Ivar Segalowitz
Products: CCTV systems and accessories for security and surveillance for application in bank security, casinos, education, traffic control, hospitals, retail and industrial plants.
District Offices:
Marv Harlan, Eastern Region, 525 Broad Hollow Rd., Melville, NY 11747
Dennis Beeskov, Central Region, 400 Bonnie Brae St., River Forest, IL 60305
Barry Gavrich, Western Region, 950 West Central Ave., Unit C, Brea, CA 92621
Tom Nash, Southeastern Region, 3010 Business Park Dr., Ste. B, Norcross, GA 30071

WESTPARK COMMUNICATIONS INC., 2408 Superior Dr., Arlington, TX 76013 Tel.: 817-469-1144

President: Gene Ware
Sales Manager: Jim Burke
Chief Engineer: Larry Norris
Products: drive-thru communication systems for the fast-food restaurant industry, stocking distributor for Ikegami CCTV and accessories.

DISCO SYSTEMS & SUPPLIES

AB SYSTEMS DESIGN, INC., 11480 Sunrise Gold Circle, Rancho Cordova, CA 95670
Tel.: 916-635-0890

President: Robert Bird
Sales Manager: Irwin Laskey
Chief Engineer: Randy Bisher
Products: professional power amplifiers, mixer pre-amplifiers, and dual and mono bi-amplifiers. Commercial accessories provide full sound reinforcement and distributed system capabilities.
See full listing under **Audio Amplifiers**.

BOZAK, INC., 68 Holmes Rd., Newington, CT 06111
Tel.: 203-666-2536

President: Donald D. Bowers
Sales Manager: William J. Kieltyka
Chief Engineer: Sheldon Glick
Products: loudspeakers and electronics for use in both home and professional applications.
District Offices:
Gilbert E. Miller Assocs., P.O. Box 7667, Greenwich, CT 06836
Forti Assocs., Inc., 3519 Raymoor Rd., Kensington, MD 20895
Monford Electronics Marketing, 5158 E. 65th St., P.O. Box 40905, Indianapolis, IN 46240
Burcaw Co., 18236 W. McNichols, Detroit, MI 48219-4190
Don Forth Assocs., 226 S. Glendora, W. Covina, CA 91790

EDEN ELECTRONICS INC., Box 338, First St., Montrose, MN 55363 Tel.: 612-675-3650

President: David D. Nordschow
Products: high quality commercial sound systems, mobile PA systems, stage monitors, constant directivity horns, crossovers, cabinets, fiberglass horns for O.E.M. application, horn-loaded bass systems.
See full listing under **Engineered Sound Systems**.

IMC, 1316 E. Lancaster, Ft. Worth, TX 76102
Tel.: 817-336-5114

President: Jerry Freed
Sales Manager: Claude Boyd
Chief Engineer: Jim Cowser
Products: Akai—multitrack recorder synthesizers. Studiomaster—recording and live mixing consoles. Ross—multitrack recorders, PA systems, guitar amps and effects. Fane—professional loudspeakers and compression drivers.

JBL PROFESSIONAL, 8500 Balboa Blvd., Northridge, CA 91329 Tel.: 818-893-8411

President: Ron Means
Vice President, Sales: Ken Lopez
Applications Engineer: Drew Daniels
Products: high quality loudspeakers and loudspeaker systems of all kinds; automatic microphone mixer; electronic crossover; special loudspeakers for musical instruments.
See full listing under **Loudspeakers and Accessories**.

MODULAR SOUND SYSTEMS, INC., P.O. Box 488, Barrington, IL 60010 Tel.: 312-382-4550

President: Jim Wischmeyer
Sales Manager: Will Warnock
Chief Engineer: Henry Heine
Products: BAG END loudspeaker systems, custom cabinetry, and rack mount enclosures.

NUMARK ELECTRONICS, 503 Raritan Center, Edison, NJ 08837 Tel.: 201-225-3222

President: Harry Kotovsky
Sales Manager: Paul Friedman
Products: power amplifiers, mixers, equalizers, noise reduction, expansion systems, video sound processors.
See full listing under **Pro Audio Sound Systems**.

PANASONIC INDUSTRIAL CO., Audio-Video Systems Group, One Panasonic Way, Secaucus, NJ 07094 Tel.: 201-348-7000

President: Ken Kurahashi
General Manager: Steve Yuhas
Sales Manager: Ted Conboy
Products: Ramsa[®] professional power amplifiers, mixing consoles, portable and stationary audio recording mixers and post production and recording consoles. Combination mixers for sound reinforcement and recording, compact high power speakers, integrated amplifiers, including mixer power amplifiers and mixer power amplifiers with AM/FM tuner and full line of accessories.
See full listing under **CCTV Systems & Products**.

PASO SOUND PRODUCTS, INC., 14 First St., Pelham, NY 10803 Tel.: 914-738-4800

Vice President, Engineering: Paul Mastrangelo
Operations Manager: Anthony Sgueglia
Sales Manager: David Moore
Products: power amplifiers, mixers, microphones, full range horn loaded bass reflex loudspeaker systems, stage monitors, microphone floor stands, booms, anti-shock holders, turntables and cassette decks.
See full listing under **Engineered Sound Systems**.

UREI, 8500 Balboa Blvd., Northridge, CA 91329
Tel.: 818-893-8411

President: Ron Means
Vice President, Sales: Ken Lopez
Application Engineer: Drew Daniels
Vice President, Marketing: Mark Grandner
Products: power amplifiers, limiters, compressors, equalizers, filters, Time Aligned[™] speakers, direct boxes, electronic crossover, digital metronome, transcription preamplifier, disco mixers, broadcast consoles.
See full listing under **Audio Signal Processors**.

BOB WHITE ASSOCIATES, P.O. Box 39104, Solon, OH 44139 Tel.: 216-248-1317

President: Bob White
Sales Manager: Tod White
Chief Engineer: George White
Products: professional sound products, audio.
See full listing under **Pro Audio Sound Products**

ENCODERS & DECODERS

(communication signaling devices)

BUSCOM SYSTEMS, INC., 490 Gianni St., Santa Clara, CA 95054 Tel.: 408-988-5200

President: Thomas F. Hood
Sales Manager: Tom Eisenhart
Chief Engineer: Dr. Donald M. Bellenger
Products: single/2-line smart telephones, automatic dialers, tone encoders, replacement handsets, call diverters in tone/pulse/remote, line/WATS extenders.

McMARTIN INDUSTRIES, INC., 4500 S. 76th St., Omaha, NE 68127 Tel.: 402-331-2000

President: Ray B. McMartin
Vice President, Director of Sales: Jay B. McMartin
Products: transistor engineered and commercial sound amplifiers/mixers/accessories, background music amplifiers and sound systems, SCA multiplex receivers, SCA and loudspeaker test sets, AM/FM/TV broadcast consoles, monitors, and transmitters, AM/FM single channel receivers. Satellite communication products.
See full listing under **Audio Amplifiers**.

MONROE ELECTRONICS, INC., 100 Housel Ave., Lyndonville, NY 14098 Tel.: 716-765-2254

Sales Manager: Donald L. Pritchard
Chief Engineer: Karl J. Miller
Products: DTMF remote control and status monitoring systems, DTMF encoders and decoders, FCC registered telephone couplers, audio amplifiers, hybrid couplers, timers, video switchers, audio switchers.

MONTGOMERY MANUFACTURING CO., INC., 202 S. Main St., Owensville, IN 47665

Tel.: 812-724-2505
President and General Manager: W. B. Davis
Products: clock and program systems, automatic operation 1 to 5 separate schedules on 1 to 5 groups of signals; 12- or 24-hour models.
Applications: schools, hospitals, institutions, business and commerce.

ENGINEERED SOUND SYSTEMS

AIPHONE INTERCOM SYSTEMS, 1700 130th Ave. N.E., Bellevue, WA 98005 Tel.: 206-455-0510

President: Hiko Shinoda
Sales Manager: Jim Morrison
Chief Engineer: Jun Matsumoto
Products: industrial, business, residential, loudspeaking, telephone, video intercom/security systems with paging talk-back; six microprocessor systems available; mixer amplifiers, paging speakers, horns, drivers, ceiling speakers.

ALTEC LANSING CORPORATION, A Gulton Co.,
Box 26105, Oklahoma City, OK 73126-0105
Tel.: 405-324-5311

President: F. Davis Merrey
Vice President of Marketing: Gary Rilling
Sales Manager: Gayle Campbell
Products: professional electronic and acoustic sound products of all types.
See full listing under **Audio Amplifiers**.

ARGOS PRODUCTS CO., INC., 600 S. Sycamore
St., Genoa, IL 60135 Tel.: 815-784-5118

President: D. C. MacLaughlin
Vice President: Ron Evers
Products: indoor/outdoor sound columns, package sound systems, PA portable sound, lecterns, baffle/speaker combinations, baffles, speaker systems and enclosures.
See full listing under **Loudspeakers & Accessories**.

ART—Applied Research & Technology Inc.,
215 Tremont St., Rochester, NY 14608
Tel.: 716-436-2720

President: Philip A. Betette
Sales Manager: Peter Beverage
Chief Engineer: Richard Neatroux
Products: digital signal processors including the DR1 digital reverberation system, other digital reverbs, equalizers and our 1500 digital delay. All ART reverbs are software updateable.
See full listing under **Audio Signal Processors**.

AUDISAR®, Box 1561, Bellevue, WA 98009
Tel.: 206-454-2040

President: R. E. Munger
Products: industrial audio and broadcast equipment, audio transformers, loudspeakers, power amplifiers, mixers, sound projector interface device, test equipment, specials and engineered sound systems.
District Offices:
Northwest Area: Gemini Electronics, Dean Nordquist, 115 4th Ave. So. #B, Edmonds, WA 98020
Northern CA: Meyer & Ross, Mordy Foodym, 1485 Rollins Road, Burlingame, CA 94010
Southern CA: Allwest Electronics, Larry Lupo, 350 N. Lantana #705, Camarillo, CA 93010
Midwest: Marketing Insights, Frank Luppino, 1445 Sunset Ridge Road, Glenview, IL 60025
Southeast: Huatling Ent., Shirley Munger, 1434 Suffolk St. N., St. Petersburg, FL 33710
Northeast: Saga Assoc., Shelly Goodman, 59 W. Mohawk St., Oswego, NY 13126

AUDITEL SYSTEMS LIMITED, 78 Asheridge Road,
Chesham, Bucks., England HP5 2PY
Tel.: (0494) 778043

President: David Langtry
Chief Engineer: Mike White
Products: central and delegate controlled conference systems, computer-controlled conference consoles, simultaneous interpretation systems, multi-channel FM induction loop transmitters and receivers, electronic voting systems.
District Office:
Edcom, 755 Center St., Lewiston, NY 14092-0506

BOGEN, A Lear Siegler Co., Box 500, Paramus, NJ
07653 Tel.: 201-343-5700

President: John H. Ochtera
Vice President, Marketing: Carl C. Dorwaldt
Vice President, Engineering: Mark Koller
National Sales Manager: Art Arlow
Products: professional, industrial, commercial and institutional sound equipment and application-engineered systems. Amplifiers, mixer-preamplifiers, power amplifiers, graphic equalizers. Speakers, microphones, intercoms, telephone paging equipment, FM/AM tuners,

receivers & tape players. Microprocessor-based time control and administrative communications.

District Office:
Southeastern Regional Manager: E. P. Draney, P.O. Box 2512, Peachtree City, GA 30269

Sales Representatives:
Atlas Electronics Ltd., 50 Wingold Ave., Toronto, Ont. M6B 1P7
Bi-State Marketers, Inc., 753 Bergen Blvd., Ridgefield, NJ 07657
EESCO, Inc., 5301 N. Exchange Blvd., Los Angeles, CA 90039
Kingston Sales Corp., 5410 Hampton Ct., Indianapolis, IN 46268
R. W. Kunz & Assocs., Inc., 460 W. 90th Terr., Prairie Village, KS 66207

R. W. Kunz & Assocs., Inc., 11906 Manchester Rd., #303, St. Louis, MO 63131

Wm. Linz Assocs., 821 Skokie Blvd., Northbrook, IL 60062
L. D. Lowery Inc., 2801 W. Chester Pike, Broomall, PA 19008
J. R. Morgan Agency, 3411A E. Corona Ave., Phoenix, AZ 85040
Mountain Representatives, Inc., 1301 W. 3rd Ave., Denver, CO 80223
Pacnor Marketing, Inc., 39320 Gary St., Sandy, OR 97055
Pacnor Marketing, Inc., 21026 E. 67th W., #E, Lynnwood, WA 98036
Paston-Hunter Co., Inc., 2002 Teall Ave., Syracuse, NY 13206
R. G. Assocs., P.O. Box 396, Millis, MA 02054
R. W. Sales Inc., 1563 Como Ave., St. Paul, MN 55108
Riley & Petchell Sales, Inc., 25700 Plymouth Rd., Detroit, MI 48239
Rohr-Wanger-Roberts Inc., 40 Williams Dr., Alabaster, AL 35007
Rohr-Wanger-Roberts Inc., 3182 Peachtree Rd., N.E., #204, Atlanta, GA 30305

Rohr-Wanger-Roberts Inc., P.O. Box 2842, Rock Hill, SC 29731
Schoonmaker Co., Inc., P.O. Box 38150, Dallas, TX 75238
Shamrock Electronic Sales, P.O. Box A, Dayton, OH 45420
Unirep, Inc. P.O. Box 16876, Ft. Lauderdale, FL 33594
Warren Assocs., 2338 Calle Del Mundo, Santa Clara, CA 95050
Warren Assocs., 3778 Putak Creek Rd., Winter, CA 96594
Martin Weinberg Assocs., 222 S. Easton Rd., Glenside, PA 19038
Foreign Representative: Singer Products Co., Inc., 875 Merrick Ave., Westbury, NY 11590

CAPITOL BACKGROUND MUSIC, INC., d/b/a See-
burg Sound Systems, 5706 New Chapel Hill
Road, Raleigh, NC 27607 Tel.: 919-851-5823

General Manager: William E. Fox
Sales Manager: Charles Anderson
Products: engineer, custom design, install and service: foreground/background music for all industrial and commercial applications.

CETEC GAUSS, 9130 Glenoaks Blvd., Sun Valley,
CA 91352 Tel.: 213-875-1900

President: W. Mort Fujii
Sales Managers: J. Fleischmann, P. Horsman
Chief Engineer: J. Williams
Products: musical component loudspeakers, precision components for sound reinforcement, custom systems, high-speed tape duplicating equipment.

CETEC IVIE, 1366 W. Center St., Orem, UT 84057
Tel.: 801-224-1800

President: Craig Berry
Sales Manager: Glen Meyer
Chief Engineer: Greg Greenwood
Products: 5000 modular sound system comprised of a mainframe and various plug-in modules including auto mixers, crossovers, equalizers, delays, notch filter, 70-V and 8-ohm amplifiers. Room combiners.
See full listing under **Audio Signal Processors**.

COMMUNICATIONS EQUIPMENT CO., INC., 6443
Western Ave., Glen Arbor, MI 49636
Tel.: 616-334-3081

President: Hugh I. Morris
Sales Manager: T. A. Garmhausen
Products: centralized sound systems for institutional applications including selective program distribution and intercommunication, manual or dial access, emergency call, light or digital annunciation, and audio surveillance.

District Offices:

Carey & Assocs., Inc., 324 N. Central, Richmond, TX 75080
Carey & Assocs., Inc., P.O. Box 40280, Houston, TX 77240
Bidwell Sales Associates, P.O. Box 2160, 443 E. Alondra Blvd.,
Gardena, CA 90247
Bill Newman & Company, 5500 W. 44th Street, Denver, CO 80212
John O. Oleson Co., Inc., 3604 Coral Gables, Cincinnati, OH 45211

**COMMUNITY LIGHT & SOUND, INC., 333 E. 5th St.,
Chester, PA 19013 Tel.: 215-876-3400**

President and Chief Engineer: Bruce Howze
Sales Manager: Thomas C. Walter
Products: high efficiency loudspeakers, radial, straight and pattern control horns, and full range enclosures for high level sound reinforcement and monitoring. Voice warning systems. OEM products.
See full listing under **Pro Audio Sound Systems**.

**CONTROLONICS CORPORATION, 5 Lyberty Way,
Westford, MA 01886 Tel.: 617-692-3000**

President: David S. Howell
National Sales Manager: Robert Birch
Marketing Manager: John Ela
Product: Infrared Professional Sound System for church, classroom, theater and large public areas to assist people with hearing loss. System is compatible with most sound distribution systems.

**J. W. DAVIS & CO., 3215 Canton St., Dallas, TX 75226
Tel.: 214-651-7341 Texas WATS: 800-442-1564
National WATS: 800-527-5705**

President: M. H. Earp
Sales Manager: W. A. Wadkins
Chief Engineer: J. E. Mitchell
Products: speakers, baffles, transformers, sound columns, mixers, amplifiers, intercom systems, school systems, microphones, CCTV, paging systems, background and foreground music systems. pro sound systems, nurse call systems.

**DELTA MAGNETICS, 16782 Hale Ave., Irvine, CA
92714 Tel.: 714-863-1537**

General Manager: Vince Piraino
Products: standard and custom audio and power transformers for the contractor or OEM. Cross to major hard to get transformers. Short run and design a specialty.

**EDCOM, INC., 755 Center St., Lewiston, NY 14092-0506
Tel.: 716-754-7130**

President: J. D. Breedon
Vice President, Marketing: Jim Wood
Director of Engineering: Peter Jova
Products: amplifier mainframes, mixers, distribution amplifiers, line surveillance and zone selection equipment, modular plug-in preamplifiers, tone and signal generators, teleconference equipment, multiple cassette systems, simultaneous interpretation systems.

District Offices:
Forristal-Young Sales Co., Box 9520, 9010 E. 350 Hwy., Kansas City, MO 64133

Forristal-Young Sales, 11312 Martha, Box 14373, Omaha, NE 68124
Henry W. Phillips Co., 110 Mansell Circle, Roswell, GA 30075
J. W. Lehner Co., 115 Marlin Drive E., Pittsburgh, PA 15216
J. W. Lehner Co., 1221 Temple Trail, Stow, OH 44224

Jim Church Marketing, 6410 E. Cox Dr., P.O. Box 5127, Bloomington, IN 47402

Lichtenauer & Assoc., 155 Riverway Drive, Pittsburgh, CA 94565
Miller & Associates Inc., 1710 Firman Dr., Suite 200, Richardson, TX 75085

Miller & Associates, 8552 Katy Freeway, Ste. 128, Houston, TX 77024
Northland Associates, 1012 19th Ave. S., P.O. Box 429, Moorhead, MN 56560

R. P. Moses & Co. Inc., 2648 Grand Ave., Box 1102, Bellmore, NY 11710

Roger Ponto Assoc. Inc., 12816 N. E. 125th Way, Kirkland, WA 98034
Sproch Sales, 3520 W. Broward Blvd., Ft. Lauderdale, FL 33312
The Smith Company, 85 Prospect St., Hartford, CT 06106

**EDCOR, 16782 Hale Ave., Irvine, CA 92714
Tel.: 714-863-1529, 800-854-0259**

President: Larry Weston
Chief Engineer: Harold Keeling
Products: a complete line of contractor equipment including amplifiers, mixers, automatic mixers, wireless microphone systems, audio and power transformers.

**EDEN ELECTRONICS, INC., P.O. Box 338, First St.,
Montrose, MN 55363 Tel.: 612-675-3650**

President: David D. Nordschow
Products: high quality commercial sound systems, mobile PA systems, stage monitors, constant directivity horns, crossovers, cabinets, fiberglass horns for O.E.M. application, horn-loaded bass systems.

District Offices:
Ron Tunks Sales, 8560 Northwest 48th St., Fort Lauderdale, FL 33321

MCM Marketing, 40R Church St., Winchester, MA 01850
Joe Martin, 15502 Rock Creek, Austin, TX 78734
Mark Tarshis, 425 Cochran Rd., Pittsburgh, PA 15228
DMC, Inc., 28947 Thousand Oak Blvd., Suite 234, Agoura Hills, CA 91301

Hawkeye Sales, 825 Sherburn, St. Paul, MN 55104

**ELECTRO-VOICE, INC., 600 Cecil St., Buchanan, MI
49107 Tel.: 616-695-6831**

President: Robert D. Pabst
Vice President, Sales and Marketing: Paul McGuire
Chief Engineer: Earl Harris
Director of Marketing, Professional Sound Reinforcement Products:
James Long

Products: broadcast, recording, communications and PA microphones; public address and component high-fidelity loudspeakers, system and enclosures; sound reinforcement products.

**ELTREX INTERNATIONAL, 2 Columbia Dr., Amherst,
NH 03031 Tel.: 603-886-3500 Telex: 953016**

President: T. H. Sullivan
Sales Manager: Bill Ryan
Products: complete line of radio paging encoders, terminals, test equipment for 2-tone and 5-tone sequential, solid state voice recorders and digital delay units for the broadcast industry.

**ENVIRONMENTAL SOUND, 31220 La Baya Dr., Bld.
110, Westlake Village, CA 91362
Tel.: 818-706-0228 TX: 299353 POST UR**

President: Pascal Delbuck
Sales Manager: Jean Pierre
Chief Engineer: Pascal Delbuck
Products: drop ceiling monitors that fit directly into a standard T-bar or grid ceiling. Pro Drop I 8-inch 2 way, Pro Drop II dual 10-inch 2 way, ES-801 8 inch full range, ES-602 6 inch two-way. ES-801 and ES-602 are flush mount (12x12).

**FSR, INC., 40 Commerce Rd., Cedar Grove, NJ 07009
Tel.: 201-783-3966**

Sales Manager: Janice Sandri
Products: conference room control systems, teleconferencing systems, remote control modules for: audio attenuation, ramp generators, microphone switching, slide and 16mm projectors, video switchers, floor boxes.

**GROMMES PRECISION ELECTRONICS, INC.,
9101 King St., Franklin Park, IL 60131
Tel.: 312-678-5350**

President: W. S. Grommes
Sales Engineer: W. Stow
Chief Engineer: A. A. Hart

Products: integrated audio amplifiers. Amps for mono or stereo power, line, music-on-hold. Mixer preamplifiers, 2 CH. limiters or compressors, graphic equalizers, FM-AM tuners, background music receivers and systems, public address systems, custom engineered sound reinforcement systems, sound columns, trumpets, driver units, baffles, microphones and microphone stands.
See full listing under **Audio Amplifiers**.

**INDUSTRIAL RESEARCH PRODUCTS, INC., 321
Bond St., Elk Grove Village, IL 60007
Tel.: 312-439-3600**

President: Hugh S. Knowles
Sales Manager: Roger Carroll
Sales Engineer: Jack Read
Products: Voice-matic® microphone mixers, digital delays, transversal equalizers, power amplifiers, automatic level controllers.

**JBL PROFESSIONAL, 8500 Balboa Blvd., Northridge,
CA 91329 Tel.: 818-893-8411**

President: Ron Means
Vice President, Sales: Ken Lopez
Applications Engineer: Drew Daniels
Products: high quality loudspeakers and loudspeaker systems of all kinds; automatic microphone mixer; electronic crossover; special loudspeakers for musical instruments.
See full listing under **Loudspeakers & Accessories**.

**MILLBANK ELECTRONICS GROUP LTD., Bell-
brook Industrial Estate, Uckfield, Sussex, TN 22
1QL England Tel.: Uckfield 825-4811**

Chairman and Marketing Director: Tony Walker
Director and General Manager: Brian Evans
Director C.T.S.D. Systems: Bernard Skinner
Engineering Manager: Doug Edworthy
Products: custom engineered sound systems; public address, teleconference, life-safety. Sound reinforcement systems; amplifiers, preamplifiers, background music, FM/AM tuners, alarm and tone signal generators, loudspeakers, microphones.
District Office:
Len Finkler & Co., 80 Alexdon Rd., Downsview, Ont. M3J 2B4, Canada
Edcom, 755 Center St., Lewiston, NY 14092-0506

**MODULAR SOUND SYSTEMS, INC., P.O. Box 488,
Barrington, IL 60010 Tel.: 312-382-4550**

President: Jim Wischmeyer
Sales Manager: Will Warnock
Chief Engineer: Henry Heine
Products: BAG END loudspeaker systems, custom cabinetry, and rack mount enclosures.

**OPAMP LABS, INC., 1033 N. Sycamore Ave., Los
Angeles, CA 90038 Tel.: 213-934-3566**

Sales Manager: B. Losmandy
Products: audio consoles (kits and wired); amplifiers, D.C. mic preamp; E.Q., magnetic tape, oscillators, power supplies, transformers, reverbs, graphic equalizers, electronic matrices. Video distribution amplifiers. Audio-video switches rack-fitted.



**PASO SOUND PRODUCTS, INC., 14 First St., Pel-
ham, NY 10803 Tel.: 914-738-4800**

Executive Vice President: Paul Mastrangelo

Operations Manager: Anthony Sgueglia
Sales Manager: David Moore
Products: (indoor, outdoor, portable, mobile) amplifiers, preamplifiers, mixers, booster amplifiers, AC/DC integrated amplifiers and boosters, intercom systems, multi-residential systems, microphones, wireless microphones, industrial grade auto reverse cassette machines, tuners, sound columns, speakers, baffles, driver units, trumpets, horns, full range loudspeaker systems, stage monitors, stands accessories, equipment racks.
District Offices:
Anderson Sales, Robert Anderson, Sr., 405 Washington St., Braintree, MA 02184
Brainard-Wilson Marketing, Paul Nielson, 415 West Golf Road, Arlington Heights, IL 60005
De Witt Austin Company, De Witt Austin, 1409 East Blvd., Charlotte, NC 28203
Electronic Sales, A. F. Howard, 5960 Briardale Cove, Memphis, TN 38119
Don Forth Associates, Don Forth, P.O. Box 2226, West Covina, CA 91793
Lichtenauer & Associates, Stephen Lichtenauer, 155 Riverway Dr., Pittsburg, CA 94565
Jack Mesnick Sales, Jack Mesnick, 13 Juneberry Lane, Liverpool, NY 13088
Miller Associates, Ltd., Irwin Miller, P.O. Box 7667, Greenwich, CT 06836
Northland Associates, Erwin Wolter, P.O. Box 429, Moorhead, MN 56560
Piper Marketing, Vic Piper, 633 East Main Street, D7, Moorestown, NJ 08057
James H. Podolny Company, James Podolny, P.O. Box 565, Medina, OH 44258
World Wide Electronics, Robert Gale, P.O. Box 840207, Pembroke Pines, FL 33084
Miguel Lopez, 825 West 31st Street, Hialeah, FL 33012
Paco Electronics, Ltd., William Cohen, 20 Steelcase Road, Unit 10, Markham, Ont., Canada L3R1B2

**PERMA POWER ELECTRONICS, INC., 5615 W.
Howard Ave., Chicago, IL 60648
Tel.: 312-647-9414**

President: Norman Ackerman
Sales Manager: Michael Shatz
Products: portable public address sound systems; solid state, portable rostrums; sound column lecterns; mobile sound; paging systems; hailers.
District Offices:
Teqni-Rep, 7664 San Fernando Rd., Sun Valley, CA 91352
Dick Bellew Sales, Inc., 5635 Yale Blvd., Dallas, TX 75206
Fahy Marketing, 235 Taunton Blvd., Marlton, NJ 08053
Stan Sliz Assocs., 1017 Boulder, Louisville, CO 80007
Carmine Vignola & Assocs., 1001C Southwest Blvd., Jefferson City, MO 65101
Adams & Assocs., 1300 Westover Terr., Greensboro, NC 27408
Berthold Sales Co., 9777 Ferguson Rd., Dallas, TX 75228
J. Malcolm Flora & Assocs., 165W Liberty, Plymouth, MI 48170
Green-Wissler Co., 8770 Commerce Park Place, Suite G, Indianapolis, IN 46268
Northmar, Inc., 1011 N.E. 69th St., Seattle, WA 98115
LSM & Assocs., 27 Orchard Park, Phelps, NY 14532
Landau & Mack, Inc., 29 Cain Dr., Plainview, NY 11803
The Smith Co., 85 Prospect Ave., Hartford, CT 06110
Technical Sales Inc., 1485 Bayshore Blvd., San Francisco, CA 94124
Morhan Export, 27-78 Newtown Rd., Plainview, NY 11803
R W Sales, 1563 Como Ave., St. Paul, MN 55108
Markal Sales Corp., 7284 West Devon Ave., Chicago, IL 60631
J. W. Lehner, 1221 Temple Trail, Stow, OH 43213

**PHONIC EAR INC., 250 Camino Alto, Mill Valley, CA
94941 Tel.: 415-383-4000**

President: James C. Mulford
Vice President: Richard Pimentel
Product: wireless FM system to serve the needs of hearing impaired. Compatible with in-place equipment requiring minimum installation.

PROTECH AUDIO CORP., Flowerfield, Bldg. #1,
St. James, NY 11780 Tel.: 516-584-5855

President: William Murphy
Chief Engineer: Joseph Giambone
Products: amplifiers—power, medium level, distribution, compressor/limiters, preamplifiers modular, automatic level, controls, remote level controls, switching modules, line amplifiers, mixing/summing modules, audio transformers, hardware.

RAULAND-BORG CORP., 3535 W. Addison St.,
Chicago, IL 60618 Tel.: 312-267-1300,

President: William Krucks
Vice-President, Sales and Marketing: Kenneth T. James
Vice-President, Field Sales: William C. Zophy
Chief Engineer: Lawrence Gleason
Products: amplifiers, preamplifiers; mixers; equalizers, intercoms, telephone systems, school communications systems, health care systems; professional sound systems; paging systems; AM-FM tuners; loudspeaker systems.

District Offices:
David D. Weeden, 1712 E. Sheridan Bridge Ln., Olathe, KS 66062
Walter D. Erskine, P.O. Box 10031, Atlanta, GA 30319
Harold Devaney, P.O. Box 789, Dickinson, TX 77539
Hank Plaisier, 8201 Maureen Dr., Midway City, CA 92655
Milton Rick Blunt, Suite 101, 15127 Northeast 24th C3, Redmond, WA 98052
Rauland-Borg Canada Inc., 6535 Millcreek Dr. Unit 5, Mississauga, Ont., Canada L5N 2M2
John Hoover, 114 Harvest Road, Cherry Hill, NJ 08002
William S. Lewis, 7614 Charron Road, Louisville, KY 40220
Patrick Flannery, 13802 Timber Trails, Orland Park, IL 60462
Ronald J. Rosen, 12 Gifford Road, Somerset, NJ 08873
Vince Ward, Apt. 356, 7293 Moffatt Road, Richmond, BC V6Y 3E4
James Welch, 26 Parkington Crescent, Scarborough, Ont., Canada M1H 2T7

ROUND & BIDNICK ASSOCS., 2601 Rocky Trail Road,
Diamond Bar, CA 91765
Tel.: 714-861-3928

President and Sales Manager: Charles W. Round
Chief Engineer: Ron S. Bidnick
Products: mixer/power amplifiers with FM/AM radio; Selectizone paging, chime-siren signaling, power amplifiers; mixers and other signaling equipment.
See full listing under **Audio Amplifiers**.

SWITCHCRAFT INC., 5555 N. Elston Ave., Chicago,
IL 60630 Tel.: 312-792-2700

President: William C. Jones
Sales Manager: Keith Bandolik
Chief Engineer: Bruce Heeb
Products: audio and general purpose connectors and receptacles, phone and phono jacks and plugs, molded cable assemblies, jack panels and jack fields, switches and audio accessories.

TELEX COMMUNICATIONS, INC., 9600 Aldrich
Ave. S., Minneapolis, MN 55420
Tel.: 612-887-5550, 612-884-4051

President: John Howe
Director Marketing, Communication Products: Donald Merein
Products: open-reel and cartridge tape recorders/reproducers, tape transports, record and reproduce electronics, intercoms, broadcast, communications and specialty headphones, headsets and accessories, closed circuit intercoms, microphones.
See full listing under **Pro Audio Sound Systems**.

TOA ELECTRONICS, INC., 480 Carlton St., S. San
Francisco, CA 94080 Tel.: 415-588-2538

President: Sam Sakata
Sales Manager, Sound and Communication Products: Joe Green/
Gail Martin, Sr.
Sales Manager, Distributor Products: Joe Green

Chief Engineer: Tad Inui
Products: engineered VMS series sound systems, microcomputerized EXES intercom systems, commercial sound systems, amplifiers, dual amplifiers, equalizers, multifunctional preamplifiers, mixing consoles, horns, drivers, speakers, wireless systems, microphones.
District Offices:
5800 Corporate Dr., #D-5, Houston, TX 77036
8969 Yellow Brick Rd., Baltimore, MD 21237



TSI, 393 Jericho Turnpike, Mineola, NY 11501
Tel.: 516-294-5390

Director of Marketing: Glenn C. Kern
Products: custom AV system design, assembly installation and service for conference, board and training rooms. Teleconferencing systems. Video projection. Remote control of VCR, film, slides, microphones, room lighting, draperies, environment. Computer interfacing.

UNIVERSITY SOUND, (Altec Div.), 10500 W. Reno
Ave., Oklahoma City, OK 73126
Tel.: 405-324-5311

President: F. Davis Merrey
National Sales Manager: David Jetzke
Vice President, Marketing: Gary Rilling
Products: commercial sound, public address and high fidelity speaker systems, paging/talk-back speakers, sound columns, weatherproof high fidelity speaker systems, high power speakers, microphone stands and accessories.
See full listing under **Loudspeakers & Accessories**.

UREI, 8500 Balboa Blvd., Northridge, CA 91329
Tel.: 818-893-8411

President: Ron Means
Vice President, Sales: Ken Lopez
Applications Engineer: Drew Daniels
Products: power amplifiers, limiters, compressors, equalizers, filters, Time Aligned™ speakers, direct boxes, electronic crossover, digital metronome, transcription preamplifier, disco mixers, broadcast consoles.
See full listing under **Audio Signal Processors**.

VERREX CORPORATION, 1130 Route 22 West, Moun-
tainside, NJ 07092 Tel.: 201-232-7000

President: Thomas G. Berry
Sales Manager: Richard Krochmal
Chief Engineer: David G. Butz
Products: supplier of engineered pro-audio sound systems worldwide since 1946. Sales, engineering, fabrication, installation and service departments.

WILLIAMS SOUND CORP., 6844 Washington Ave.,
S., Eden Prairie, MN 55344
Tel.: 800-328-6190

President: Gerald I. Williams
Sales Manager: Paul Ingebrigtsen
Chief Engineer: Richard B. Holmes
Products: AM and FM wireless hard of hearing systems, programmable wireless microphone system, wireless four guide and cueing systems.

HARDWARE & TOOLS

ADC PRODUCTS, 4900 W. 78th St., Minneapolis,
MN 55435 Tel.: 612-835-6800

President: C. M. Denny
Division Manager: Dennis Leese
Chief Engineer: Jay Deitch

Products: fused, bi-directional and WDM fiber optic couplers, RF connectors, telephone test and access components, insulation displacement terminal blocks, cross connect products for customer premise and central office.

See full listing under **Telephone System Peripherals**.

AVA ELECTRONICS & MACHINE CORP., 4000
Bridge St., Drexel Hill, PA 19026
Tel.: 215-284-2500

President: Dr. Mario Rafalin

Sales Manager: Bill Cooper

Chief Engineer: Howard Lomax

Products: RF and computer connectors, BNC, Twinax, F, UHF connectors, cable assemblies, computer switches, computer panel and wall plates, adapters.

BRIM ELECTRONICS, INC., 120 S. Home Pl., Lodi,
NJ 07644 Tel.: 201-796-2886

President: B. Danziger

Sales Manager: B. Brown

Products: wire, cable (including shielded braiding, retractile cords); tubing, sleeving; ceramic insulators; adhesive-backed fastening devices; nylon, brass hardware; solderless terminals; plugs, jacks, switches.

See full listing under **Wire & Cable**.

CABLETRONIX, Div. Storm King Industries, Inc.,
366 Washington St., P.O. Box 3003, Newburgh,
NY 12550 Tel.: 914-565-7570,
800-431-W.I.R.E. (outside NY)
800-942-W.I.R.E. (inside NY)

President: Stephen L. Roth

Vice President: Leonard Ellentuch

Products: "Amp," 3M connectors; staplers, staples; "B" connectors; bridging clips; D-rings; tie wraps; drive pins; electrical, masking and packing tape; molly & toggle bolts; pan head screws and plastic anchors, pole-line hardware, modular blocks (flush and base mount) modular cords and RG 31X jacks, adhesive cable duct.

CLIFFORD INC., 83 Main St., Bethel, VT 05032
Tel.: 800-451-4381 Toll-Free
802-234-9921 Call Collect

President: Richard L. Huntley

Sales Manager: Martha McKinney

Products: all accessory materials needed to install and maintain inter-connecting cable and wire system. (Terminals, connectors, splices, tapes, tools, hardware, protectors, closures, etc.)

FAMOUS TELEPHONE SUPPLY CO., P.O. Box
2172, Akron, OH 44309 Tel.: 216-762-8811,
800-321-9122

President: J. Blaushild

General Manager: William Brannon

Products: wire and cable; general hardware; apparatus; paging equipment; power equipment; protection devices; tools; splicing equipment; closures; compounds; couplers and peripheral devices; plenum cable. Key systems and PABX's.

GENCOM PRODUCTS LTD., P.O. Box 2335,
Newburgh, NY 12550 Tel.: 914-565-2072

President: S. L. Roth

Products: complete line of cable ties and mounts, communication and electrical ducting, cable clamps, wire markers, wire nuts, stand-offs, RF connectors, spade lugs.

HARRIS CORP., DRACON DIV., 809 Calle Plano,
Camarillo, CA 93010 Tel.: 805-987-9511

Vice President/General Manager: John R. Mason

Sales Manager: Tom Erdmann

Chief Engineer: Joe Mader

BB-30

Products: telephone integrated loudspeaker paging systems; linemen's test sets; craft tools; power supplies; DC-DC converters and extensive line of relay racks.

See full listing under **Paging Systems—All Types**.

ITT POMONA ELECTRONICS/Div. ITT Corp., 1500 E.
Ninth St., P.O. Box 2767, Pomona, CA 91766
Tel.: 714-623-3463

Sales Manager: Carl W. Mussarra

Chief Engineer: Raymond Mix

Products: connectors — XLR, XLB, XLA series — for audio, electronics and other low level circuit applications, patch cords, gold plated banana plugs and accessories.

District Offices:

William M. Linz, Assoc., Inc., 821 Skokie Blvd., Northbrook, IL 60062

Al Appell Associates, Inc., 199 E. Foxboro St., Sharon, MA 02067

Carelli/EMA, Inc., 320 Lang Road, Burlingame, CA 94010

DeAngelo, Rothman & Company, 12069 W. Jefferson Blvd., Culver City, CA 90230

David S. Linz, Inc., 238 Shelmire Street, Philadelphia, PA 19111

ITW LINX INSTALLER PRODUCTS/Illinois Tool Works, Inc., 195 Algonquin Rd., Des Plaines, IL
60016 Tel.: 312-296-5469

General Manager: Russell Duggan

Sales Manager: Dan Heck

Products: metal and plastic components for installers that simplify routing, fastening and assembly of cable networks.

JENSEN TOOLS, INC., 7815 S. 46th St., Phoenix,
AZ 85044 Tel.: 602-968-6231

General Manager: Uma Nandan

Sales Manager: Tom Fenzel

Products: hand tools and scientific supplies for electronic installation; assembly, repair, tool kits, instruments, soldering tools, cases, relay tools, lamps, etc.

KULKA SMITH INC./NEUTRIK PRODUCTS, 1913
Atlantic Ave., Manasquan, NJ 08736
Tel.: 201-223-9400

President: Harry Miller

Sales Manager: Jim Cowan

Chief Engineer: Fred Kaufman

Products: 3,4,5,6-pin XLR connectors, panel and P.C.

MUSIC SUPPLY CO., INC., 809 N. Madison, Dallas,
TX 75208 Tel.: 1-800-527-1522

President: W. E. Brown

Products: Push-Pull rods. Set of twenty, lightweight, aluminum alloy, 5½ oz. per rod. Joins together for 45 ft. span. Pushes or pulls wire or cable through impossible places. 30 days free trial.

MUSIC SUPPLY CO., INC., 809 N. Madison, Dallas,
TX 75208 Tel.: 1-800-527-1522
Texas Collect: 214-946-8450

President: W. E. Brown

Products: extension cords, 3 feet and 10 feet, 3-conductor wire with grounding plugs. UL-listed. EASY-KARY™ wire reel holders. Holds spools of wire and cable for easy reeling off on job site. All components stow in hollow frame. Takes up no room in truck. 30 days free trial.

OMNIMOUNT SYSTEMS, 10850 Van Owen St.,
N. Hollywood, CA 91605 Tel.: 818-766-9000

President and Chief Engineer: Alexander Cyrell

Sales Manager: Susan Michelson

Products: industrial quality mounts. Unique ebonite ball joint design adjustability, security features, invisible wiring capability. #100WA maximum recommended load 70 lbs. New models to 300 lbs. and more.

Sound & Communications

PALADIN CORP., 3543 Old Conejo Road, Suite #102,
Newbury Park, CA 91320 Tel.: 805-499-0318

President: E. L. Jones
Sales Manager: Ronald J. Vogel
Products: crimper, strippers, heat guns, desoldering tools, ergonomically designed screw drivers.

District Offices:
Dunn & Bryan, Inc., 40 Journal Square, Jersey City, NJ 07306
Classen-Doolittle Assoc., 2230 Dandridge Drive, York, PA 17403
Bradley Representatives, 71 Gordon Street, Elk Grove Village, IL 60007
Shattuck-Hagen Mktg., 586 Weddell Drive, Ste. #4, Sunnyvale, CA 94089

Ray-Mar & Associates, 6718 Keswick Drive, Dallas, TX 75232

RESCO, INC., P.O. Box 2244, Newburgh, NY 12550
Tel.: 914-565-7583

President: Stephen L. Roth
Vice President: Leonard Ellentuch
Products: "B" connectors. Modular accessories for large volume manufacturers; computer cable assemblies. Import and export agents of components, devices and special requirements.

HEADPHONES/HEADSETS

ACS COMMUNICATIONS, 250 Technology Circle,
Scotts Valley, CA 95066 Tel.: 408-438-3883

President: Al Butcher
Executive Vice President: Kevin Larkin
Products: telephone headsets.

ACCUSONIC SYSTEMS CORP., (Subsidiary of
Design Atronics Inc.), 2101 Jericho Turnpike, New
Hyde Park, NY 11040 Tel.: 516-328-3300

President: Sol Schwartz
Sales Manager: Dennis Goodman
Products: military and severe environment microphones, speakers and headsets.

AKG ACOUSTICS, INC., 77 Selleck St., Stamford,
CT 06902 Tel.: 203-348-2121

Vice President: S. R. Ravich
Sales Manager: D. Talbor
Tech Manager: D. Pilkington
Products: studio condenser microphones; prepolarized condenser microphones; professional dynamic microphones; cardioid dynamic microphones; special purpose microphones; stereo headphones; boom sets; accessories; reverb units, phono cartridges, digital delays.
See full listing under **Microphones**.

AMP-TELECOM DIVISION, P.O. Box 1776, South
Eastern, PA 19399 Tel.: 215-647-1000

Marketing Manager: Bill Russo
Products: telephone wiring devices.

AUDIOSEARS CORP., 2 South St., Stamford, NY
12167 Tel.: 607-652-7305

President and Sales Manager: G. V. Mahler
Sales Manager: David Hartwell
Chief Engineer: Fred Rosscoe
Products: telephone handsets; telephone operators' headsets; headsets; carbon microphones; magnetic earphones; headbands; booms; special cordsets; push-to-talk switches.

August, 1985

AUDIO TECHNICA U.S. INC., 1221 Commerce Dr.,
Stow, OH 44224 Tel.: 216-923-0376

President: Jon R. Kelly
Sales Manager: Charlie Winkler
Chief Engineer: Bob Herrold
Products: microphones and microphone accessories, recorder/mixers, cables, direct boxes, headphones.

BEYER DYNAMIC, INC., 5-05 Burns Ave., Hicks-
ville, NY 11801 Tel.: 516-935-8000

National Sales Manager: Tony Hawkins
Products: full line of headphones and accessories for consumer audio, broadcasting, studio, film and TV application.

CALRAD ENGINEERED ELECTRONIC PRODUCTS,
819 No. Highland Ave., Los Angeles, CA 90038
Tel.: 213-465-2131

President: Joseph Shupper,
Vice President: Robert Shupper
Sales Manager: Fred Crown
Chief Engineer: Wes Black
Products: microphones, headphones, public address amplifiers, power supplies, speakers, connecting cables, telephone accessories, potentiometers, connectors, switches, meters, control knobs.
See full listing under **Audio Amplifiers**.

DAVID CLARK CO., INC., 360 Franklin St., Worces-
ter, MA 01604 Tel.: 617-756-6216

President: John E. Flag
Sales Manager: George R. Conlon
Products: portable and fixed communication systems featuring noise attenuating (reducing) headsets for use in high-noise areas. VOX systems for portable radios with throat microphones.

CLEAR-COM INTERCOM SYSTEMS, 1111 17th St.,
San Francisco, CA 94107 Tel.: 415-861-6666
TWIX 910-371-1087

President: Robert Cohen
Sales Manager: Robert Cohen
Vice President, Export Marketing: Peter Giddings
Products: high noise level intercom systems for theaters, arenas, broadcast, industrial. Interconnects with microphone cable. Interfaces with RTS type two wire systems, telephone lines, cameras, etc.
See full listing under **Intercom Systems—Duplex**.

HEIL LTD., #2 Heil Dr., Marissa, IL 62257
Tel.: 618-295-3000

President: Bob Heil
Chief Engineer: John Rutter
Products: mixing consoles power amplifiers, parametric EQ, crossovers, satellite TV antennas, amateur radio and communication microphones.

METRAGEN, 3701 Chesswood Dr., #208, Downsview,
Ont. M3J 2P6, Canada Tel.: 416-635-9212

President: E. Wigdor
Products: self-amplified interphones with built-in buzzers, self-amplified communications headsets with buzzers.
District Offices:
Cambridge Communications, 325 Huron St., Chicago, IL 60610

NUMARK ELECTRONICS, 503 Raritan Center, Edison,
NJ 08837 Tel.: 201-225-3222

President: Harry Kotovsky
Sales Manager: Paul Friedman
Products: power amplifiers, mixers, equalizers, noise reduction, expansion system, video sound processors.
See full listing under **Pro Audio Sound Systems**.

P/H ELECTRONICS, INC., 413 E. Helena St., Dayton,
OH 45404 Tel.: 513-461-5898

President: E.R. Hazlett
Sales Manager: Donna Martin
Chief Engineer: V.M. Pantelic
Products: multi-channel wireless simultaneous interpretation systems. Single channel wireless listening systems. Desk top, belt pack, or self-contained headphone/receiver. General purpose headphones and headsets.

PLANTRONICS, INC., 345 Encinal St., Santa Cruz,
CA 95060 Tel.: 408-426-5858

President: Neil Hynes
General Manager: Tom Blinn
Chief Engineer: Bob Bernardi
Products: Starset and Supra headsets (quick disconnect) provide 10% more productivity through lightweight and mobility features. Jacksets provide immediate interconnection for Starsets with any telco phone without interface devices. PhoneBeam, speaker phones.

RTS SYSTEMS, INC., 1100 W. Chestnut St., Burbank,
CA 91506 Tel.: 818-840-7119

President: Bob Ringer
Vice President, Marketing: Douglas Leighton
Sales Manager: Shelley Brown
Chief Engineer: Stan Hubler
Products: professional intercom systems, conference-line and dedicated-line, IFB systems. Pro audio amplifier, phono preamp, 10-watt monitor amp and buffer amp.

SENNHEISER ELEC. CORP. (N.Y.), 48 W. 38th St.,
New York, NY 10018 Tel.: 212-944-3440

President: Andrew Brakhan
Sales Manager: Tony Tudisco
Chief Engineer: Horst Ankermann
Products: full line of professional microphones including dynamics, electrets and condenser series as well as UHF and VHF wireless units. Sealed and open-air headphones available.

SETCOM CORP., 1400 Stierlin Rd., Mountain View,
CA 94043 Tel.: 415-965-8020

President: Kent Schwartzman
Sales Manager: Steve Kilczewski
Products: headsets and headphones for all applications including TV cameras with Western Electric circuitry. Single or dual speaker units.

SOUND POWERED COMMUNICATIONS CORP.,
335 Robbins Ave., P.O. Box 5569, Trenton, NJ
08638 Tel.: 609-883-1180

Sales Manager: Harry Mosle
Products: sound-powered communications equipment including intercom stations, field telephones, handsets, noise-attenuating headsets, hook-up cable, reel systems and accessories.

TELEPHONE COMPONENTS, INC., 3180 Express-
way Dr., S., Central Islip, NY 11722
Tel.: 516-582-4745

President: P. Crescentini
Sales Manager: James Costa
Products: telephone handsets, hangers, hook switches, cradles; operator headsets; plugs and jacks; for standard and special applications, such as mobile, interconnect, etc. Retractable and straight telephone cords.

TELEX COMMUNICATIONS, INC., 9600 Aldrich
Ave. S., Minneapolis, MN 55420
Tel.: 612-887-5550, 612-884-4051

President: John Howe
Director Marketing, Communication Products: Donald Merein

Products: broadcast, communications and specialty headphones, headsets and accessories, intercoms, microphones.

Marketing Director, Audio/Visual Products: Tom Johnson
Products: headphones, headsets, listening centers, cordless listening systems and accessories.

See full listing under **Pro Audio Sound Systems**.

IN & OUT REGISTERS

COMMUNICATIONS EQUIPMENT CO., INC., 6443
Western Ave., Glen Arbor, MI 49636
Tel.: 616-334-3081

President: Hugh I. Morris
Sales Manager: Thomas A. Garmhausen
Products: personnel in-and-out registers, including message waiting, door monitoring and annunciator panels.
See full listing under **Engineered Sound Systems**.

CORNELL ELECTRONIC PRODUCTS, INC., 4911 W.
Good Hope Rd., Milwaukee, WI 53223
Tel.: 414-351-4600

President: Donald Glaubitz
Vice President and Chief Engineer: Gary Butler
Sales Manager: Pauline Haack
Products: audio-visual nurse call systems, door security systems and apartment intercom systems. In-and-out registers, printer/recorder systems.
See full listing under **Nurse-Patient Intercom Systems**.

**EDSTAN DOCTORS' REGISTERS by TIME &
SOUND CO. INC.**, 14120 Live Oak Ave., Baldwin
Park, CA 91706 Tel.: 818-960-7781
800-423-4765

President: David Verner
Sales Manager: Ray Keddington
Products: computerized staff register systems with video displays, smart entrance stations, visual paging option, message printer option now offers flush wall mounting printers for doctors' messages and patient location.

EKTACOM-FISHER BERKELEY CORP., 5800 Chris-
tie Ave., Emeryville, CA 94608
Tel.: 415-655-9696

President: Robert S. Fisher
Chief Engineer: Robert T. Shipley
Products: duplex and simplex intercom systems, annunciator and voice call-in; audio-visual and visual-only nurse-call systems; manual and automatic personnel registers, apartment signaling systems.
See full listing under **Intercom Systems—Simplex**.

FARADAY, INC., 805 S. Maumee St., Tecumseh, MI
49286 Tel.: 517-423-2111

President: G. Rummell
Sales Manager: J. Frankow
Chief Engineer: R. Miller
Products: intercom and sound distribution systems, public address systems, nurse call systems, fire alarm, annunciator, clock and hospital life safety systems, full range of signaling products.
See full listing under **Alarm, Security & Life-Safety Systems**.

JERON ELECTRONIC SYSTEMS, INC., 3554 N.
Clark St., Chicago, IL 60657
Tel.: 312-528-4020, 800-621-1903

President: Jerome Chesnul
Sales Manager: David Hayes
Products: in-out registers. Clinic call systems. Audio-visual nurse call. Communications and signaling systems for hospitals, nursing homes, institutions, elderly housing, apartment buildings, offices.
See full listing under **Apartment House Intercoms**.

KOMTEK CORPORATION, 11 White Lakes Rd.,
Stanley, NM 87056 Tel.: 505-832-6236

President: Bill Patterson

Products: plugable light intercom message and paging systems; room status systems. Light lenses can be either colors or numerals for any intercom/message system.

RADIONICS, INCORPORATED, 920 Holt Rd.,
Webster, NY 14580 Tel.: 716-872-2100

President: A. J. Ozminkowski

Sales Manager: Daniel McKinley

Chief Engineer: Fred B. Cupp

Products: Tel Trak 2—doctor's register and messaging system. Easy In/Out/Availability information, plus effective message center capability.

INTERCOM SYSTEMS — INSTITUTIONAL

AIPHONE INTERCOM SYSTEMS, 1700 130th Ave.,
N.E., Bellevue, WA 98005 Tel.: 206-455-0510

President: Hiko Shinoda

Sales Manager: J. M. Morrison

Chief Engineer: Jun Matsumoto

Products: industrial, business, residential, loudspeaking, telephone, video intercom/security systems with paging talk-back; six microprocessor systems available; mixer amplifiers, paging speakers, horns, drivers, ceiling speakers.

ATKINSON DYNAMICS, 10 W. Orange Ave., S. San
Francisco, CA 94080 Tel.: 415-583-9845

Operations Manager: E. M. Watson

Sales Manager: Asa Bullock

Products: heavy duty intercom units engineered specifically for high-noise areas. Clear communications under most difficult conditions guaranteed. Weatherproof, sealed, transistorized.

BOGEN, A Lear Siegler Company, Box 500, Paramus,
NJ 07653 Tel.: 201-343-5700

President: John H. Ochtera

Vice President, Marketing: Carl C. Dorwaldt

Vice President, Engineering: Mark Koller

National Sales Manager: Art Arlow

Products: microprocessor-controlled Communitel™ administrative communication systems include emergency priority, six-zone paging. Multi-Graphic™ modular control centers (2 or 3 channels), staff stations and satellite systems, for intercom, program distribution, paging. Loudspeaking and telephone intercom systems, single- or multiple-channel.

See full listing under **Engineered Sound Systems**.

CLEAR-COM INTERCOM SYSTEMS, 1111 17th St.,
San Francisco, CA 94107 Tel.: 415-861-6666,
TWIX 910-371-1087

President: Robert Cohen

Sales Manager: Robert Cohen

Vice President, Export Marketing: Peter Giddings

Products: high noise level intercom systems for theaters, arenas, broadcast, industrial. Interconnects with microphone cable. Interfaces with RTS type two wire systems, telephone lines, cameras, etc.

See full listing under **Intercom Systems-Duplex**.

COMMUNICATIONS CO., INC., 3490 Noeli St., San
Diego, CA 92110 Tel.: 619-297-3261

President and Sales Manager: Peter T. Jordan

Chief Engineer: David Johnson

Products: programmable two-way intercom amplifier w/vox., media distribution amplifier, projector patch, room combining systems, record patch, RT-60 reverberation measuring device, burst octave noise generator, 1/3 octave real time analyzer, 27 B.I.T. oscilloscope display adaptor.

District Offices:

Austin Assocs., 50 Windsor Lane, Willingboro, NJ 08046

Secom Systems, 5241-F New Peach Tree Rd., Chamblee, GA 30341

Bencsik Assocs., 3730 NE 42nd Lane, Ocala, FL 32670

Audio Marketing Assoc., 9470 Whitewood Rd., Brecksville, OH 44141

Pro Marketing, 9628 Day Dr., Indianapolis, IN 46280

Burcaw Co., 18236 W. McNichols, Detroit, MI 48219

Ziskind Assocs., 5420 Newport Dr., Rolling Meadows, IL 60008

Jack Mesnick Sales, 13 Juneberry Lane, Liverpool, NY 13088

Irv Brown Company Inc., 401 Kingston Ave., Brooklyn, NY 11225

Forristal-Young Sales Corp., 9010 E. 50 Highway, Kansas City, MO 64133

Peregrine S.W. Reps., 5800 Corporate (D5), Houston, TX 77036

Mountain Reps. Inc., 1301 West 3rd Ave., Denver, CO. 80223

Western Audio Sales, 1535 Riverside Drive, Glendale, CA 91201

Bryan Trankle, 820 Black Mountain Rd., Hillsborough, CA 94010

Fleethart & Sullivan, 10109 Aurora Ave. North, Seattle, WA 98133

COMMUNICATIONS EQUIPMENT CO., INC., 6443
Western Ave., Glen Arbor, MI 49636

Tel.: 616-334-3081

President: Hugh I. Morris

Sales Manager: T. A. Garmhausen

Chief Engineer: E. C. Wilcox

Products: selective signal, common talk telephone systems; including multiple talk channels, paging access, internal speakers for hands-free answering; other special features.

See full listing under **Engineered Sound Systems**.

CORNELL ELECTRONIC PRODUCTS, INC., 4911 W.
Good Hope Road, Milwaukee, WI 53223
Tel.: 414-351-4660

President: Donald J. Glaubitz

Vice President and Chief Engineer: Gary Butler

Sales Manager: Pauline Haack

Products: audio-visual nurse-call systems and door security systems.

Apartment and institutional intercom systems; in-and-out registers, printer/recorder systems.

See full listing under **Nurse-Patient Intercom Systems**.

CP COMMUNICATIONS, P.O. Box 530, 1141 Pleasant-
ville Road, Briarcliff Manor, NY 10510
Tel.: 914-762-4254, 800-762-4254 (outside NY)
212-496-9111 (New York City)

President: Tim Fisher

Sales Manager: David Goldsmith

Products: CP Communications specializes in the rental of walkie-talkies, intercoms, wireless headset systems and cellular telephones by the day, week, or month.

J. W. DAVIS & CO., 3215 Canton St., Dallas, TX
75226 Tel.: 214-651-7341
Texas WATS: 800-442-1564
National WATS: 800-527-5705

President: M. H. Earp

Sales Manager: W. A. Wadkins

Chief Engineer: J. E. Mitchell

Products: intercom products for industrial institutional, school, office or home. Products include the simplest form to the latest microprocessor control, electronic door lock control and TV monitoring.

DELTA COMMUNICATIONS CO., 7852 78th Ave.,
S.W., Tacoma, WA 98498 Tel.: 206-582-2201

President: Sid C. Flothe

Sales Manager: Sid C. Flothe

Products: school and institutional intercommunication systems. Features include: room handsets, two channels of telecommunications, voice intercom, programming from radio/cassette, compact size, time tone signals, etc.

EKTACOM-FISHER BERKELEY CORP., 5800 Christie Ave., Emeryville, CA 94608
Tel.: 415-655-9696

President: Robert S. Fisher
Chief Engineer: Robert Shipley
Products: duplex and simplex intercom systems, annunciator and voice call-in; audio-visual and visual-only nurse-call systems; manual and automatic personnel registers, apartment signaling systems.
See full listing under **Intercom Systems—Simplex**.

FARADAY, INC., 805 S. Maumee St., Tecumseh, MI 49286
Tel.: 517-423-2111

President: G. Rummell
Vice President, Marketing: G. Rummell
Sales Manager: J. Frankow
Chief Engineer: R. Miller
Products: intercom and sound distribution systems, public address systems, nurse call systems, fire alarm, annunciator, clock and hospital life safety systems, full range of signaling products.
See full listing under **Alarm, Security & Life-Safety Systems**.

FLORENCE CORP., 2101 N. Elston Ave., Chicago, IL 60614
Tel.: 312-384-3310

President: L. A. Schooley
Vice President, Sales: D.A. Cannella
Sales Manager: George Jans
Chief Engineer: Ray Cozzens
Vice President, General Manager: John Martino
Products: designers and manufacturers of nurse call, emergency calls, mail boxes and apartment communication systems.

ITT DATA EQUIPMENT & SYSTEMS DIV., 20 Mayfield Ave., Edison, NJ 08837
Tel.: 201-225-6121

Vice President: Donald Duthaler
National Sales Manager: William Couture
Chief Engineer: Jeffrey Stellman
Products: ELS microprocessor based duplex intercom—8-4000 lines, 4 wire installation, variety of stations, handy free/handset operation, desk/wall equipped, odors. Simple operation, easily expandable.

JERON ELECTRONIC SYSTEMS, INC., 3554 N. Clark St., Chicago, IL 60657
Tel.: 312-528-4020, 800-621-1903

President: Jerome Chesnul
Sales Manager: David Hayes
Products: communication and signaling systems for hospitals, psychiatric wards, nursing homes, elderly housing and care facilities, jails, dormitories, military, institutions. Door surveillance systems. Room status systems.
See full listing under **Apartment House/Hi-Rise Intercoms**.

KOMTEK CORPORATION, 11 White Lakes Road, Stanley, NM 87056
Tel.: 505-832-6236

President: Bill Patterson
Products: pluggable light intercom message and paging systems; room status systems. Light lenses can be either colors or numerals for any intercom/message system.

LCA SALES CO., 76 Main St., Tuckahoe, NY 10707
Tel.: 914-961-4700, 800-522-7377 (outside NY)

Partners: Joel H. Schwartz
General Manager: R.R. Sherwood
Products: manufacturers' representatives for: Blonder-Tongue, BES, Carol Cable, Eaton/Dekorion, Gentex, Harrington, M/A-Com

Video/Data, N.I.T., Panasonic CCTV, Reliable Security, Siedle, University, Videoscope/QuadraVision.
See full listing under **Alarm, Security & Life-Safety Systems**.



LEE DAN COMMUNICATIONS, INC., 155 Adams Ave., Hauppauge, NY 11788
Tel.: 516-231-1414

President: Leon Goldberg
Sales Manager: Lawrence Goldberg
Chief Engineer: Ted Jurgens
Products: Tek-Care emergency call systems for multi-dwelling senior citizen housing. U.L. nurse-call systems. Intercom systems for dormitories.
See full listing under **Apartment House/Hi-Rise Intercoms**.

LT ELECTRONICS LTD., 2535 Gerrard St. East, Scarborough, Canada M1N 1W9
Tel.: 416-691-9406

President: Jim Breedon
Sales Manager: Jim Breedon
Chief Engineer: J. Hesse
Products: school intercoms, cone speakers, sound columns, packaged amplifiers, telephone amplifiers, speaker baffles, bass reflex speaker systems.
See full listing under **Paging Systems**.

NORCON ELECTRONICS INC., 1260 Ralph Ave., Brooklyn, NY 11236
Tel.: 718-451-1112

President: Norman Schlaff
Chief Engineer: Simon Kleyner
Products: Norcon Talk-Thru communicator.

PASO SOUND PRODUCTS, INC., 14 First St., Pelham, NY 10803
Tel.: 914-738-4800

Vice President, Engineering: Paul Mastrangelo
Operations Manager: Anthony Sguiglia
Sales Manager: David Moore
Products: microprocessor controlled "Compucom" intercoms with full trunkage, assured privacy, 8 conductor max, parallel wiring with interface to door entry. Selective ring common talk telephone and open voice intercom systems with paging.
See full listing under **Engineered Systems**.

RADIONICS INC., 920 Holt Road, Webster, NY 14580
Tel.: 716-872-2100

President: A. J. Ozminkowski
Sales Manager: Daniel McKinley
Chief Engineer: Fred B. Cupp
Products: DisplayCom: silent two-way intercom/custom messaging system for use between executives and secretary or receptionist. Connects to existing AC wiring.

RAULAND-BORG CORP., 3535 W. Addison St., Chicago, IL 60618
Tel.: 312-267-1300
TWX: 910 221 1290

President: William Krucks
Vice President, Sales and Marketing: Kenneth T. James
Vice President, Field Sales: William C. Zophy
Chief Engineer: Lawrence Gleason
Products: intercoms, telephone systems, administrative intercom, dormitory and retirement home intercom; health care systems; school systems, Philips M100 direct speech intercom system.
See full listing under **Engineered Sound Systems**.

RING GROUP OF NORTH AMERICA, 230 Community Dr., Great Neck, NY 11021 Tel.: 516-487-0250

President: Ron Stone

Vice President: Peter McLean

Assistant Vice President: Stan Davis

Chief Engineer: Jim Small

Products: Ring-Master "Tridex" intercom series— fully electronic, handsfree, microprocessor controlled duplex systems. Field programmable; paging, telephone, radio, alarm interfaces. 5000 station capacity with variety of stations.

See full listing under **Intercom Systems—Duplex**.

ROFU INTERNATIONAL CORP., 5531G Hempstead Way, Springfield, VA 22151 Tel.: 800-762-7638

Products: BPT video-intercom, BPT intercom, BPT CCTV systems.

RTS SYSTEMS, INC., 1100 W. Chestnut St., Burbank, CA 91506 Tel.: 818-840-7119

President: Bob Ringer

Vice President, Marketing: Douglas Leighton

Sales Manager: Shelley Brown

Chief Engineer: Stan Hubler

Products: professional intercom systems, conference-line and dedicated-line, IFB systems. Pro audio amplifier-phono-preamp, 10-watt monitor amp and buffer amp.

SIEDLE INTERCOM / USA, 1 Wynnewood Road, Wynnewood, PA 19096 Tel.: 800-874-3353

Sales Director: Earl Zausmer

Products: 2-wire apartment house intercoms for duplex communications from front door and apartment, chime announcement and door release operation from handset. Decentralized microprocessor intercom for all applications plus page with talkback. Modular mailbox systems. Video intercom systems. CCD ultra miniaturized camera for banks and special surveillance.

SOUNDOLIER, 9380 Watson Industrial Park, St. Louis, MO 63126 Tel.: 314-962-9870

Vice President, Director of Marketing: Herbert M. Jaffe

Director of Sales: Paul Grote

National Sales Manager: Tony Dalba

Chief Engineer: John Saller

Products: high quality, commercial sound loudspeakers, enclosures and accessories for music, alarm and public address systems, baffles for ceilings and walls, matching transformers and backbox enclosures.

See full listing under **Loudspeakers & Accessories**.

SOUND POWERED COMMUNICATIONS CORP., 335 Robbins Ave., P.O. Box 5569, Trenton, NJ 08638 Tel.: 609-883-1180

Sales Manager: Harry Mosle

Products: sound-powered communications equipment including intercom stations, field telephones, handsets, noise-attenuating headsets, hook-up cable, reel systems and accessories.

SPECO DIV., Components Specialties Inc., 1172 Rt. 109, P.O. Box 624, Lindenhurst, NY 11757 Tel.: 516-957-8700 (in NY)

President: Louis W. Keller

Vice President: Stan Hulkower

Sales Manager: Mel Hulkower

Chief Engineer: James Ganci

Products: PA horns, amplifiers, tuners, loudspeakers, wall baffles, speaker assemblies, outdoor speakers, sound columns, ceiling grilles, transformers, L-pads, attenuators, accessories, microphones, intercoms, alarm sirens, multimeters, oscilloscopes.

STENTOFON COMMUNICATIONS, INC., 6012 Parretta Dr., Kansas City, MO 64120 Tel.: 816-231-7200

President and Sales Manager: Ken Jensen

Chief Engineer: James A. Pierce

Products: duplex intercom systems 2-2000 stations, easily expandable; microprocessor based simplex and duplex systems for all applications including paging and program distribution.

District Offices:

S.C.I. West, 554 E. Foothill Blvd. #117, San Dimas, CA 91773

S.C.I. East, 7927 Jones Branch Drive, McLean, VA 22102

TALK-A-PHONE CO., 5013 N. Kedzie Ave., Chicago, IL 60625 Tel.: 312-539-1100

President: Z. Liberman

Sales Manager: Daniel Kagan

Products: intercom systems — manual and hands free equipment — for industrial, institutional, commercial, home, self-service gas station and apartment house use; wireless and cable connected models.

TEKTONE SOUND & SIGNAL MFG., 1331 S. Killian Dr., Lake Park, FL 33403 Tel.: 305-844-2383

President: M. Mira

Sales Manager: Carlos Mira

Chief Engineer: J. Switzer

Products: intercom systems for home, apartment, commercial/industrial, institutional—telephone, loudspeaking and door answering. Nurse call, security/alarm and AM/FM radio intercom systems.

See full listing under **Apartment House/Hi-Rise Intercoms**.

TELEPHONE SALES & SERVICE CO., 25 DeForest St., Amityville, NY 11701 Tel.: 516-842-4800

President: Harry F. Bradley

Products: electronic PAX; Select-O-Phone II to 64 stations with 100% trunkage. Contrac EPAX 64 to 4000 stations. Electronic code-call with telephone access. Message repeater.

TN COMMUNICATIONS CORPORATION, 42-15 Crescent Ave., Long Island City, NY 11101 Tel.: 718-729-9400

President: Paul C. Roche

Sales Manager: Reginald Humphrey

Chief Engineer: Walter Strauss

Products: intercom and interconnect telephone systems, both key and PABX.

TOA ELECTRONICS, INC., 480 Carlton Ct., S. San Francisco, CA 94080 Tel.: 415-588-2538

President: Sam Sakata

Sales Manager, Sound and Communication Products: Joe Green

Products: micro-computerized intercom systems EXES-5000, EXES-1000, EX-16. Full electronic exchange, all types stations — hands-free, handset, auto-dialer, talk-back unit.

See full listing under **Engineered Sound Systems**.

TOUCH-PLATE INTERNATIONAL, INC., 16530 Garfield Ave., Paramount, CA 90723 Tel.: 213-636-8171

President: R. G. Martinson

Sales Manager: William Paulin

Chief Engineer: William Wright

Products: all-master intercom systems, low-voltage light switching, signal, and room-status systems. Flushplate line of wall plates, speaker baffles and accessories.

VALCOM, INC., 1111 Industry Ave., Roanoke, VA 24013 Tel.: 703-982-3900

President: J. W. Mason

Sales Manager: Donald Buck

Chief Engineer: D. Lynch

Products: telephone integrated paging and intercom systems, talkback, bell-buzzer, code call, PBX adapters, key telephone system ancillaries, loud-ringers, power supplies, amplified and talkback speakers. Single line and feature telephones.
See full listing under **Paging Systems—All Types.**

XTEL CORPORATION, 4301 Will Rogers Pkwy., Suite 900, Oklahoma City, OK 73108
Tel.: 405-946-1500

President: J. William Patterson
Vice President: Glen Patterson
Products: "Voicepac 10-75 stations:" hands free response behind PBX/Centrex or key systems. "All-Call," splash and privacy tones, power paging. Compact speaker/microphones mount inside telephones.

INTERCOM SYSTEMS— DUPLEX

AIPHONE INTERCOM SYSTEMS, 1700 13th Ave. N.E., Bellevue, WA 98005 Tel.: 206-455-0510

President: Hiko Shinoda
Sales Manager: Jim Morrison
Chief Engineer: Jim Matsumoto
Products: home intercom systems, commercial/industrial telephone and loudspeaking intercom, apartment house intercom, hospital systems, paging systems with talkback.

ALTERNATIVE TELECOMMUNICATIONS CORP., 80 8th Ave., N.Y., NY 10011 Tel.: 212-691-0800

President: Alan R. Fitzpatrick
Products: hands-free intercom systems manufactured by L.M. Ericsson.

ATC SUPPLY CORP., 265 W. 14th St., New York, NY 10011 Tel.: 212-929-2045

President: Alan R. Fitzpatrick
Sales Manager: Steven M. Ryan
Chief Engineer: Alex Katzko
Products: wholesale supplier of hands-free intercom systems manufactured by L.M. Ericsson.

CLEAR-COM INTERCOM SYSTEMS, 1111 17th St., San Francisco, CA 94107 Tel.: 415-861-6666

President: Robert Cohen
Sales Manager: Robert Cohen
Vice President, Export Marketing: Peter Giddings
Products: high noise level intercom systems for theaters, arenas, broadcast, industrial. Interconnects with microphone cable. Interfaces with RTS type two wire systems, telephone lines, cameras, etc.
District Office:
Export Div., P.O. Box 302, Walnut Creek, CA 94596, Telex 176340 ClearCom WNCK

COLUMBIA SCIENTIFIC INDUSTRIES CORP., P.O. Box 203190, Austin, TX 78720
Tel.: 512-258-5191

President: E. Haddad
Sales Manager: Jim Cotton
Chief Engineer: John Rhodes
Products: multi-channel VOX intercom systems for bank drive-ins, self service gas stations, security stations, cashiers, etc.

COMMUNICATIONS CO., INC., 3490 Noell St., San Diego, CA 92110 Tel.: 619-297-3261

President and Sales Manager: Peter T. Jordan
Chief Engineer: David Johnson

BB-36

Products: programmable two-way intercom amplifier w/vox., media distribution amplifier, projector patch, room combining systems, record patch, RT-60 reverberation measuring device, burst octave noise generator, 1/3 octave real time analyzer, 27 B.I.T. oscilloscope display adaptor.
See full listing under **Intercom Systems — Institutional**

J. W. DAVIS & CO., 3215 Canton St., Dallas, TX 75226
Tel.: 214-651-7341 Texas WATS: 800-442-1564
National WATS: 800-527-5705

President: M. H. Earp
Sales Manager: W. A. Wadkins
Chief Engineer: J. E. Mitchell
Products: duplex intercom systems including telephone type, microprocessor controlled or hands free. Paging talkback type systems also available for office, warehouse applications including telephone interconnect.

DUKANE CORPORATION, Communications Systems Division, 2900 Dukane Dr., St. Charles, IL 60174 Tel.: 312-584-2300

General Manager: William B. Clark
Marketing Manager: Craig E. Lyons
Chief Engineer: Paul D. Graham
Products: communications systems including intercom, public address and background music, professional sound, radio paging, nurse-patient communications, personnel registers and master clock systems.

EKTACOM-FISHER BERKELEY CORP., 5800 Christie Ave., Emeryville, CA 94608
Tel.: 415-655-9696

President: Robert S. Fisher
Chief Engineer: Robert Shipley
Products: duplex and simplex intercom systems, annunciator and voice call-in; audio-visual and visual-only nurse-call systems; manual and automatic registers, apartment signaling systems.
See full listing under **Intercom Systems—Simplex.**

ENCOM PRODUCTS CO., INC., P.O. Box 300, 502 Lower Hopewell Road, Oxford, PA 19363-0300
Tel.: 215-932-9600

Sales Manager: Bob Mallalieu
Products: commercial/industrial interphone equipment to fit applications ranging from retail stores to offshore drilling rigs.

FARADAY, INC., 805 S. Maumee St., Tecumseh, MI 49286 Tel.: 517-423-2111

President: G. Rummell
Sales Manager: J. Frankow
Chief Engineer: R. Miller
Products: intercom and sound distribution systems, public address systems, nurse call systems, fire alarm, annunciator, clock and hospital life safety systems, full range of signaling products.
See full listing under **Alarm, Security & Life-Safety Systems.**

HM ELECTRONICS, INC., 9675 Business Park Ave., San Diego, CA 92131 Tel.: 619-578-8300

President: H. Y. Miyahira
Sales Manager: John F. Kenyon
Chief Engineer: Ken Fasen
Products: professional wireless microphone systems, handheld or body pac transmitters with 115dB dynamic range, full duplex wireless intercom systems, complete line of cabled intercom products.
See full listing under **Microphones.**

ITT DATA EQUIPMENT & SYSTEMS DIV. 20 Mayfield Ave., Edison, NJ 08837 Tel.: 201-225-6121

Vice President: Donald Duthaler
National Sales Manager: William Couture
Chief Engineer: Jeffrey Stellman

Sound & Communications

Products: ELS microprocessor based duplex intercom—8-4000 lines, 4 wire installation, variety of stations, handy free/handset operation, desk/wall equipped, colors. Simple operation, easily expandable.

METRAGEN, 3701 Chesswood Dr., #208, Downsview, Ont. M3J 2P6, Canada Tel.: 416-635-9212

President: E. Wigdor
Products: self-amplified interphones with built-in buzzers, self-amplified communications headsets with buzzers.
See full listing under **Headphones & Headsets**.

NADY SYSTEMS, INC., 1145 65th St., Oakland, CA 94608 Tel.: 415-652-2411

President: John Nady
Sales Manager: Peter Kalmen
Chief Engineer: John Nady
Products: wireless microphones, infrared listening systems, wireless intercoms, and portable sound systems.

PASO SOUND PRODUCTS, INC., 14 First St., Pelham, NY 10803 Tel.: 914-738-4800

Vice President, Engineering: Paul Mastrangelo
Operations Manager: Anthony Sgueglia
Sales Manager: David Moore
Products: microprocessor based telephone type. Full duplex, 100% trunkage, assured privacy with paging, 8 conductors, all wiring in parallel and may be interfaced with door entry system. Selective ring common talk telephone type with paging.
See full listing under **Engineered Sound Systems**.

RING GROUP OF NORTH AMERICA, 230 Community Dr., Great Neck, NY 11021 Tel.: 516-487-0250
800-645-9690

President: Ron Stone
Vice President: Peter McLean
Asst. Vice President: Stan Davis
Chief Engineer: Jim Small
Products: Ring-Master "Tridex" intercom series—fully electronic, hands-free, microprocessor controlled duplex systems. Field programmable; paging, telephone, radio, alarm interfaces. 5000 station capacity with variety of stations.
District Offices:
West Coast Office; 111 Anza Blvd., Suite 300, Burlingame, CA 94010
Canada: Protek Electronics Ltd., 1145 Fife St., Winnipeg, Manitoba, R2X 2N2
Mexico: Grupo Sit, Av. Lomas de Sotelo N° 1112-2° Piso, C.P. 11200 Mexico, D. F.

RTS SYSTEMS, INC., 1100 W. Chestnut St., Burbank, CA 91506 Tel.: 213-843-7022

Vice President: Bob Ringer
Vice President, Marketing: Douglas Leighton
Sales Manager: Shelley Brown
Chief Engineer: Stan Hubler
Products: professional intercom systems, conference-line and dedicated-line, IFB systems. Pro-audio amplifier-phono-preamp, 10-watt monitor amp and buffer amp.

SPECO DIV., Components Specialties, Inc., 1172 Rt. 109, P.O. Box 624, Lindenhurst, NY 11757
Tel.: 516-957-8700 (New York)
1-800-645-5516 (Outside NY)

President: Louis W. Keller
Vice President: Stan Hulkower
General Manager: James Ganci
Director of Sales and Marketing: Mel Hulkower
Products: P.A. horns, amplifiers, tuners, loudspeakers, wall baffles, speaker assemblies, outdoor speakers, sound columns, ceiling grilles,

transformers, L-pads, attenuators, accessories, microphones, intercoms, alarm sirens, multimeters, oscilloscopes.

STENTOFON COMMUNICATIONS, INC., 6012 Parretta Drive, Kansas City, MO 64120
Tel.: 816-231-7200

President and Sales Manager: Ken Jensen
Chief Engineer: Jim Pierce
Products: duplex intercom systems 2-2000 stations, easily expandable; microprocessor based simplex and duplex systems for all applications, including paging and program distribution.
See full listing under **Intercom Systems/Institutional**.

TALK-A-PHONE CO., 5013 N. Kedzie Ave., Chicago, IL 60625 Tel.: 312-539-1100

President: Z. Liberman
Sales Manager: Dan F. Kagan
Products: intercom systems—manual and hands-free equipment—for industrial, institutional, commercial, home, apartment house, self-service gas station, and fast food drive-thru use; wireless and cable connected models.

TOA ELECTRONICS, INC., 480 Carlton Ct., S. San Francisco, CA 94080 Tel.: 415-588-2538

President: Sam Sakata
Sales Manager, Sound and Communication Products: Joe Green/
Gail Martin, Sr.
Chief Engineer: Tad Inui
Products: micro-computerized intercom systems EXES-5000, EXES-1000, EX-16. Full electronics exchange, all types stations—hands-free and set, auto-dialer, talk-back unit.
See full listing under **Engineered Sound Systems**.

XTEL, 4301 Will Rogers Parkway, Suite 900, Oklahoma City, OK 73108 Tel.: 405-946-1500

President: J. William Patterson
Vice President: Glen Patterson
Products: "Voicepac 10-75 stations": hands free response behind PBX/Centrex or key systems. "All-Call", splash and privacy tones, power paging. Compact speaker/microphones mount inside telephones.

INTERCOM SYSTEMS— SIMPLEX

AIPHONE INTERCOM SYSTEMS, 1700 13th Ave. N.E., Bellevue, WA 98005 Tel.: 206-455-0510

President: Hiko Shinoda
Sales Manager: J.M. Morrison
Chief Engineer: Jun Matsumoto
Products: industrial, business, residential, loudspeaking, telephone, video intercom/security systems with paging talk-back; six microprocessor systems available; mixer amplifiers, paging speakers, horns, drivers, ceiling speakers.

ATKINSON DYNAMICS, 10 W. Orange Ave., S. San Francisco, CA 94080 Tel.: 415-583-9845

Operations Manager: E. M. Watson
Sales Manager: Asa Bullock
Products: heavy-duty intercom units engineered specifically for high-noise areas. Clear communications under most difficult conditions guaranteed. Weatherproof, sealed, transistorized.

BOGEN, A Lear Siegler Company, Box 500, Paramus, NJ 07653 Tel.: 201-343-5700

President: John H. Ochtera
Vice President, Marketing: Carl C. Dorwaldt
Vice President, Engineering: Mark Koller
National Sales Manager: Art Arlow

Products: telephone, loudspeaking, high power and wireless-type intercom systems. All-masters or masters & choice of remotes; common-line or multiple-channel; privacy or monitoring; tone & light annunciators; hands-free replay. Paging and talkback options. See full listing under **Engineered Sound Systems**.

DAVID CLARK CO., INC., 360 Franklin St., Worcester, MA 01604 Tel.: 617-756-6216

President: John E. Flagg
Sales Manager: George R. Conlon
Products: portable and fixed communication systems featuring noise attenuating (reducing) headsets for use in high-noise areas. VOX systems for portable radios with throat microphones.

COMMUNICATIONS CO., INC., 3490 Noell St., San Diego, CA 92110 Tel.: 714-297-3261

President and Sales Manager: Peter T. Jordan
Chief Engineer: David Johnson
Products: specialized audio test equipment, 1/3 octave real time analyzer. 27 B.I.T. oscilloscope display adaptor, RT-60 reverberation measuring device. Programmable two-way intercom amplifier w/vox. See full listing under **Intercom Systems — Institutional**.

COMMUNICATIONS EQUIPMENT CO., INC., 6443 Western Ave., Glen Arbor, MI 49636
Tel.: 616-334-3081

President: Hugh I. Morris
Sales Manager: Thomas A. Garmhausen
Products: commercial industrial telephone and loudspeaking intercom systems, self-contained intercom masters for service windows, fast-food restaurants, self-serve gas stations. See full listing under **Engineered Sound Systems**.

DUKANE CORPORATION, Communications Systems Division, 2900 Dukane Dr., St. Charles, IL 60174 Tel.: 312-584-2300

General Manager: William B. Clark
Marketing Manager: Craig E. Lyon
Chief Engineer: Paul D. Graham
Products: communications systems including intercom, public address and background music, professional sound, radio paging, nurse-patient communications, personnel registers and master clock systems.



ETKACOM-FISHER BERKELEY CORP., 5800 Christie Ave., Emeryville, CA 94608
Tel.: 415-655-9696

President: Robert S. Fisher
Chief Engineer: Robert T. Shipley
Products: simplex and duplex intercom systems, annunciator and voice call-in; audio-visual and visual-only nurse-call systems; manual and automatic registers, apartment signaling systems.

District Offices:
Midwestern Region Office: Box 292, Westfield Center, OH 44251
Eastern Region Office: Box 205, Fayetteville, PA 17222
Metrocom System Sales, 32-56 57th St., Woodside, NY 11377
Strassner Sales Co., 5301 N. Exchange St., Los Angeles, CA 90039
Northland Assocs., 1012-19th Ave. S., P.O. Box 429, Moorhead, MN 56560
Firanck Sales, 2685 Lapeer Rd., Pontiac, MI 48057
Electronic System Sales, 1244 Kenilworth Dr., Palatine, IL 60067
The Corrigan Agency, P.O. Box 39, Mandeville, LA 70448
Avwest, Inc., P.O. Box 17479, Fountain Hills, AZ 85268

FANON COURIER CORP., 15300 San Fernando Mission Blvd., Mission Hills, CA 91345
Tel.: 818-365-2531, 800-423-5656

President: Jay Steinbeck
Sales Manager: Murray Trotiner
Products: intercoms, loudspeaking wired and wireless; corded and cordless telephones, speakerphones, PA amplifiers, paging horns, trumpets and drivers, megaphones, FM scanning monitors, satellite stereo receivers.

FARADAY, INC., 805 S. Maumee St., Tecumseh, MI 49286 Tel.: 517-423-2111

President: G. Rummell
Sales Manager: J. Frankow
Chief Engineer: R. Miller
Products: intercom and sound distribution systems, public address systems, nurse call systems, fire alarm, annunciator, clock and hospital life safety systems, full range of signaling products. See full listing under **Alarm, Security & Life-Safety Systems**.

JERON ELECTRONIC SYSTEMS, INC., 3554 N. Clark St., Chicago, IL 60657
Tel.: 312-528-4020, 800-621-1903

President: Jerome Chesnut
Sales Manager: David Hayes
Products: intercom systems for apartment buildings, townhouses, offices. Combination emergency call/intercom systems for elderly housing. Hospital, nursing home, institutional, dormitory communications and signaling systems. See full listing under **Apartment House Intercoms**.



LEE DAN COMMUNICATIONS, INC., 155 Adams Ave., Hauppauge, NY 11788
Tel.: 516-231-1414

President: Leon Goldberg
Sales Manager: Lawrence Goldberg
Chief Engineer: Ted Jurgens
Products: communication and security systems for apartment house, home and industry. Intercom, music and paging systems, mailboxes, directories, annunciators, signaling devices, communications cable, nurse-call systems, Tek-View audio/visual intercom systems. See full listing under **Apartment House/Hi-Rise Intercoms**.

MULTI-VOX LTD., 9967 St. Michel Blvd., Montreal H1H 5G7, Quebec, Canada
Tel.: 514-321-3131

President: Claude Girard
Sales Manager: George Morissette
Chief Engineer: E. Williot
Products: solid state nurse-call systems, modular amplifiers to 200 watts, commercial/industrial/apartment/school intercom systems.

NADY SYSTEMS, INC., 1145 65th St., Oakland, CA 94608 Tel.: 415-652-2411

President: John Nady
Sales Manager: Peter Kalmen
Chief Engineer: John Nady
Products: wireless microphones, infrared listening systems, wireless intercoms and portable sound systems.

PASO SOUND PRODUCTS, INC., 14 First St., Pelham, NY 10803 Tel.: 914-738-4800

Vice President, Engineering: Paul Mastrangelo
Operations Manager: Anthony Sgueglia
Sales Manager: David Moore
Products: selective ring common talk system for institutions, industry, residential and business.
See full listing under **Engineered Sound Systems**

RAYTRONICS, 7392 Trade St., San Diego, CA 92121
Tel.: 619-566-7515

President: Dennis Berglund
Chief Engineer: Don Foley
Sales Manager: Carol Thada
Products: solid state intercom for drive-thru in high noise level applications; vehicle sensing equipment with repeat chime; high quality amplifiers, horns, speech processing equipment; drive-thru visual ordering systems.

RING GROUP OF N. AMERICA, 230 Community Dr., Great Neck, NY 11021 Tel.: 516-487-0250
800-645-9690

President: Ron Stone
Vice President: Peter McLean
Chief Engineer: Jim Small
Products: Ring-master "Tridex" 100% electronic handsfree, microprocessor controlled duplex systems. 5 to 5000 lines, superior linkage, 4 wires, variety of stations, colors. Field programmable.
See full listing under **Intercom Systems-Duplex**.

RTS SYSTEMS, INC., 1100 West Chestnut St., Burbank, CA 91506 Tel.: 818-840-7119

President: Bob Ringer
Vice President, Marketing: Douglas Leighton
Sales Manager: Shelley Brown
Chief Engineer: Stan Hubler
Products: professional intercom systems, conference-line and dedicated-line, IFB systems. Pro audio amplifier, phono preamp, 10-watt monitor amp and buffer amp.

SIEDLE INTERCOM/USA, 1 Wynnewood Rd., Wynnewood, PA 19096 Tele.: 800-874-3353

Sales Director: Earl Zausmer
Products: 2-wire apartment house intercoms for duplex communications between front door and apartment, chime announcement and door release operation from handset. Decentralized microprocessor intercom for all applications plus page with talkback. Modular mailbox systems. Video intercom systems. CCD ultra miniaturized camera for banks and special surveillance.

SOUND MASTERS, INC., Rte. 3 W., Morrilton, AR 72110 Tel.: 501-727-5401

President: John McVey
Products: portable amplified lecterns and accessories. Industrial intercom systems. Solid wood floor lecterns.

SOUND PRODUCTS/3M, 3M Center 225-3N-04, St. Paul, MN 55144 Tel.: 612-733-0447

Marketing Manager: Don Rada
Sales Manager: Jack Dingley
Products: music libraries for all purposes. Reliable player. Industrial quality intercoms. Top-line message repeater. Speaker assemblies for distributed systems. Microphones, amplifiers and other sound system components.
See full listing under **Pro Audio Sound Systems**.

SPECO DIV., Components Specialties, Inc., 1172 Rt. 109, P.O. Box 624, Lindenhurst, NY 11757
Tel.: 516-957-8700 (New York)
1-800-645-5516 (Outside NY)

President: Louis W. Keller
Vice President: Stan Hulkower
General Manager: James Ganci
Director Sales and Marketing: Mel Hulkower
Products: P.A. horns, amplifiers, tuners, loudspeakers, wall baffles, speaker assemblies, outdoor speakers, sound columns, ceiling grilles, transformers, L-pads, attenuators, accessories, microphones, intercoms, alarm sirens, multitestors, oscilloscopes.

STENTOFON COMMUNICATIONS, INC., 6012 Parretta Dr., Kansas City, MO 64120
Tel.: 816-231-7200

President and Sales Manager: James W. Lerch
Chief Engineer: James A. Pierce
Products: duplex intercom systems 2-2000 stations, easily expandable; microprocessor based simplex and duplex systems for all applications including paging and program distribution.
See full listing under **Intercom Systems/Institutional**.

TALK-A-PHONE CO., 5013 N. Kedzie Ave., Chicago, IL 60625 Tel.: 312-539-1100

President: Z. Liberman
Sales Manager: Dan F. Kagan
Products: intercom systems—manual and hands-free equipment—for industrial, institutional, commercial, home, apartment house, self-service gas station, and fast food drive-thru use; wireless and cable connected models.

TEKTONE SOUND & SIGNAL MFG., 1331 S. Killian Dr., Lake Park, FL 33403 Tel.: 305-844-2383

President: M. Mira
Sales Manager: Carlos Mira
Chief Engineer: J. Switzer
Products: intercom systems for home, apartment, commercial/industrial, institutional—telephone, loudspeaking and door answering. Nurse call, security/alarm and AM/FM radio intercom systems.
See full listing under **Apartment House/Hi-Rise Intercoms**.

WESTPARK COMMUNICATIONS INC., 2408 Superior Dr., Arlington, TX 76013 Tel.: 817-469-1144

President: Gene Ware
Sales Manager: Jim Burke
Chief Engineer: Larry Norris
Products: drive-thru communication systems for the fast-food restaurant industry, stocking distributor for Ikegami CCTV and accessories.

LOUDSPEAKERS & ACCESSORIES

AB SYSTEMS DESIGN, INC., 11480 Sunrise Gold Circle, Rancho Cordova, CA 95670
Tel.: 916-635-0890

President: Robert Bird
Sales Manager: Irwin Laskey
Chief Engineer: Randy Bisher
Products: professional power amplifiers, mixer preamplifiers, and dual and mono bi-amplifiers. Commercial accessories provide full sound reinforcement and distributed system capabilities.
See full listing under **Audio Amplifiers**.

ACCUSONIC SYSTEMS CORP., (Subsidiary of Design Atronics Inc.), 2101 Jericho Turnpike, New Hyde Park, NY 11040 Tel.: 516-328-3300

President: Sol Schwartz
Sales Manager: Dennis Goodman
Products: military and severe environment microphones, speakers, and headsets.

AIPHONE INTERCOM SYSTEMS, 1700 13th Ave.,
N.E., Bellevue, WA 98005 Tel.: 206-455-0510

President: Hiko Shimoda
Sales Manager: Jim Morrison
Chief Engineer: Jun Matsumoto
Products: industrial, business, residential, loudspeaking, telephone, video intercom/security systems with paging talk-back; six microprocessor systems available; mixer amplifiers, paging speakers, horns, drivers, ceiling speakers.

ALTEC LANSING CORPORATION, A Gulton Co.,
Box 26105, Oklahoma City, OK 73126-0105
Tel.: 405-324-5311

President: F. Davis Merrey
Vice President of Marketing: Gary Rilling
Sales Manager: Gayle Campbell
Products: professional electronic and acoustic sound products of all types.
See full listing under **Audio Amplifiers**.

AMERICAN ACOUSTICS, One Mitek Plaza, Winslow,
IL 61089 Tel.: 815-367-3811

President: Loyd Ivey
Sales Manager: Rob Landsberg
Chief Engineer: Nick Leindecker
Products: D-Series digital loudspeakers: state-of-the-art technology; ideal for commercial and industrial applications where aesthetics and true hi-fidelity are key considerations.

ARGOS PRODUCTS CO., INC., 600 S. Sycamore
St., Genoa, IL 60135 Tel.: 815-784-5118

President: D. C. MacLaughlin
Vice President, Marketing Manager: Ron Evers
Products: indoor/outdoor sound columns, packaged sound systems, PA portable sound lecterns, baffle/speaker combinations, baffles, speaker systems and enclosures.
District Offices:
Ted Firanek Sales, Pontiac, MI
Nevco Inc., Kansas City, MO
W. A. Hendrickson Co., N. Scituate, MA
Maish Sales, Mulberry, IN
TMC Sales, Fort Lee, NY
Shamrock Sales, Dayton, OH
Packnor Marketing, Lynwood, WA
Murphy & Cota, Atlanta, GA
Mel Foster-Technical Sales, Edina, MN
Peregrine Southwest Reps., Houston, TX
Stinson Associates, Wynnewood, PA

ATLAS SOUND (Div. American Trading & Production Corp.), 10 Pomeroy Road, Parsippany,
NJ 07054 Tel.: 201-887-7800

Vice President, Marketing: Herbert M. Jaffe
National Sales Manager: David A. Chambers
Chief Engineer: Bob Greulich
Products: reflex, radial, sectoral column, explosion-proof, marine, mobile loudspeakers and components for communications, alarm, intercom and sound systems. Desk, table, boom floor stands. Microphone stand accessories.

District Offices:
Ellard E. Strassner Co., Inc., 5301 N. Exchange St., Los Angeles, CA 90039
J. Y. Schoonmaker Co., Inc., 10710 Sand Hill Rd., Dallas, TX 75238
Warren Assocs., 2338 Calle del Mundo, Santa Clara, CA 95050
Atlas Electronics Ltd., 50 Wingold Ave., Toronto, Ont., M6B 1P7 Canada

AUDISAR, Box 1561, Bellevue, WA 98009
Tel.: 206-454-2040

President: Robert E. Munger
Products: industrial audio and broadcast equipment, audio transformers, loudspeakers, power amplifiers, mixers, sound projector interface device, test equipment, specials and engineered sound systems.
See full listing under **Engineered Sound Systems**.

BES/Bertagni Electroacoustical Systems, 12753
Moore St., Cerritas, CA 90701
Tel.: 213-926-0201

President: Lynn Morrison
Sales Manager: Ivan Weisman
Chief Engineer: Alex Bertagni
Products: high performance line of hemispherically radiating ceiling speakers that closely resemble ceiling tiles with 180° dispersion pattern. High performance omni-directional outdoor sound reinforcement speakers.
Main Offices:
Dan Speegle, Peregrine Southwest Reps., 5800 Corporate (D-5) Houston, TX 77036
Carl Schwartz, Powerline, 409 Custer Street, Evanston, IL 60202
Ron Forristal, Forristal-Young Sales Co., 9010 E. 350 Highway, Kansas City, MO 64133
Jim Hager, Steve Gramig, Stewart Pitchford, Gary Dunaway; McFadden Sales Inc., 1093, Fishinger Road, Columbus, OH 43221
Joel Schwartz, L.C.A. Sales, 76 Main Street, Tuckahoe, NY 10707
George Smith, The Smith Company, 85 Prospect Ave., Hartford, CT 06106
Bob Gale, World-Wide Electronics, P.O. Box 840207, Pembroke Pines, FL 33084
Mel Foster, Mel Foster Technical Sales Inc., 7611 Washington Ave. So., Edina, MN 55435
Henry Phillips, Jim Light, Mark Winchester, Dave Pergantis; Henry Phillios Co., 110 Mansell Circle, Roswell, GA 30075-3789
Roger Ponto, Roger Ponto Assoc., Inc., P.O. Box 3365, Bellevue, WA 85268
Jim Umstead, Avwest Inc., P.O. Box 17479, Fountain Hills, AZ 85268
Geoffrey W. Keleher, Design Factors, P.O. Box 5236, Hacienda Heights, CA 91745-0236
James Chang, JC Electronics, P.O. Box 27185, Honolulu, HI 96827
Branch Offices:
Steve Simmons, Doran Bryson; Peregrine Southwest Reps., 4804 Havenhood Lane, Apt. 413, Dallas, TX 75252
Larry Hilgers, Forristal-Young Sales Co., 11312 Martha St., Omaha, NE 68144
Steve Holtkamp, Forristal-Young Sales Co., 8986 Manchester Road, St. Louis, MO 63144
Brian K. Dolan, L.C.A. Sales, 8709 2nd Ave., Silver Springs, MD 20910
Ivan M. Fried, L.C.A. Sales, 340 East 80th Street, Apt. 12H, New York, NY 10021
Sol. M. Goldstein, L.C.A. Sales, 399 Ocean Parkway, Apt. 2B, Brooklyn, NY 11218
James B. Johnson, L.C.A. Sales, Rte. 3-Box 213, Front Royal, VA 22630
Steve Keech, L.C.A. Sales, C-320 Media Station, Media Station Road, Media, PA 19063
John Picciallo, L.C.A. Sales, 9 Doric Avenue, Parsippany, NJ 07054
Joel H. Schwartz, L.C.A. Sales, 36 Frederick Lane, Scarsdale, NY 10583
Robert R. Sherwood, L.C.A. Sales, 10 Mead Street, Apt. 1, Springdale, CT 06907
Chet Flynn, The Smith Company, 28 Mt. Blue, Norwell, MA 02061
Sandy Duffy, The Smith Company, 231 Spring Street, Meriden, CT 06450
Kevin White, The Smith Company, 112 Hunt Road, Columbia, CT 06237

BOGEN, A Lear Siegler Company, Box 500, Paramus,
NJ 07653 Tel.: 201-343-5700

President: John H. Ochtera
Vice President, Marketing: Carl C. Dorwaldt
Vice President, Engineering: Mark Koller

National Sales Manager: Art Arlow

Products: cone speakers, transformers, wall and ceiling baffles. Sound columns. Amplified speakers and horns. Paging and talkback double-reentrant speakers; all-weather horns and drivers. Power megaphones. See full listing under **Engineered Sound Systems**.

BOSE®

BOSE CORPORATION, The Mountain, Framingham,
MA 01701 Tel.: 617-879-7330

President: Dr. Amar G. Bose

Chief Engineer: John Carter

Sales Manager: John Stiernberg

Products: professional loudspeakers for installed and portable applications, include the full range 802 Series II, 302 bass system, 402 line source system, CLS-2 commercial loudspeakers system and 102 foreground music system.

Sales Representatives:

Rome Baily, 3770 West Barstow #155, Fresno, CA 93711

Tim Dorwart, 2118 Main St., Whitehall, PA 18052

Barry Luz, 8539 Henry St., Highland, IN 46322

Bruce Myers, 1501 18th Ave., Longmont, CO 80501

CELESTION INDUSTRIES, INC., Kuniholm Dr., Hol-
iston, MA 01746 Tel.: 617-429-6706

Chief Executive Officer: William G. McGrane

Marketing Manager: Mary Warbasse

Products: professional sound reinforcement loudspeakers. Bullet and rectangular horn tweeters, compression drivers, horns and low frequency cambric edge speakers, 8, 10, 12, 15 and 18.

CETEC GAUSS, 9130 Glenoaks Blvd., Sun Valley,
CA 91352 Tel.: 213-875-1900

President: W. Mort Fujii

Sales Managers: J. Fleischmann, P. Horsman

Chief Engineer: J. Williams

Products: musical component loudspeakers, precision components for sound reinforcement, custom systems, high-speed tape duplicating equipment.

COMMUNITY LIGHT & SOUND, 333 E. 5th St.,
Chester, PA 19013 Tel.: 215-876-3400

President and Chief Engineer: Bruce Howze

Sales Manager: Thomas C. Walter

Products: high efficiency loudspeakers, radial, straight & pattern control horns, and full range enclosures for high level sound reinforcement and monitoring. Voice warning systems. OEM products.

See full listing under **Pro Audio Sound Systems**.

J. W. DAVIS & CO., 3215 Canton St., Dallas, TX 75226
Tel.: 214-651-7341 Texas Wats: 800-442-1564
National Wats: 800-527-5705

President: M. H. Earp

Sales Manager: W. A. Hevron

Chief Engineer: J. E. Mitchell

Products: all types of loudspeakers, baffles, transformers, including wall and ceiling mount. Special patio and underwater speakers also available. Types include horns, columns and vented enclosures for commercial or professional applications.

EDCOM, INC., 755 Center St., Lewiston, NY 14092-0506
Tel.: 716-754-7130

President: J. D. Breedon

Vice President, Marketing: Jim Wood

Director of Engineering: Peter Jova

Products: commercial sound loudspeakers, 4-15"; baffles, back-boxes, transformers, mounting hardware; sound columns, bass-reflex speaker assemblies, wall baffles and assemblies.

See full listing under **Engineered Sound Systems**.

ELECTRO-VOICE, INC., 600 Cecil St., Buchanan,
MI 49107 Tel.: 616-695-6831

President: Robert D. Pabst

Vice President, Sales and Marketing: Paul McGuire

Director of Marketing, Professional Sound Reinforcement: James Long

Chief Engineer: Earl Harris

Products: broadcast, recording, communications and PA microphones; public address and component high-fidelity loudspeakers, systems and enclosures, sound reinforcement products.

See full listing under **Microphones**.

EMILAR CORP., (Electra Marketing Limited), 1365
McCan St., Anaheim, CA 92806
Tel.: 714-632-8500

President: Manny Mohageri

Vice President: Algis Renkus

Chief Engineer: Jonas Renkus

Products: mid & hi frequency compression drivers, horns, bass loudspeakers, passive networks for professional applications.



ENVIRONMENTAL SOUND®

ENVIRONMENTAL SOUND, 31220 La Baya Dr., Bld.
110, Westlake Village, CA 91362
Tel.: 818-706-0228 TX: 299353 POST UR

President: Pascal Delbuck

Sales Manager: Jean Pierre

Chief Engineer: Pascal Delbuck

Products: drop ceiling monitors that fit directly into a standard T-bar or Grid ceiling. Pro Drop I 8-inch 2 way, Pro Drop II dual 10-inch 2 way, ES-801 8 inch full range, ES-602 6 inch two-way. ES-801 and ES-602 are flush mount (12X12).

FANE, 1316 East Lancaster St., Forth Worth, TX 76179
Tel.: 817-336-5114

President: Jerry Freed

Sales Manager: C. F. Boyd

Chief Engineer: Jim Cowser

Products: Ross PA systems, EQ's, speaker enclosures, power amplifiers and Studiomaster professional mixers and power amplifiers.

FOURJAY INDUSTRIES, INC., 2801 Ontario Ave.,
Dayton, OH 45414 Tel.: 513-278-9416

President and General Manager: J. M. Fulkerson II

Director of Sales: M. W. (Bud) Frawley

Products: ceiling white recessed baffles, time-saving baffle mounting devices, protective covers, wall baffles and music speakers. Horn speakers for paging/talkback, intercom, telephone and security systems.

GOLLEHON INDUSTRIES, INC., 3105 Madison Ave.
SE, Grand Rapids, MI 49509 Tel.: 616-247-8231

President and Chief Engineer: John T. Gollehon
Sales Manager: Don A. Drown
Products: sound reinforcement speakers for installation in nightclubs, show rooms, churches, and auditoriums. Exceptionally high power handling, constant directivity dispersion, and full-range response. Product line includes the popular Penetrator Series of horn-loaded cone drivers.

GROMMES PRECISION ELECTRONICS, INC.,
9101 King St., Franklin Park, IL 60131
Tel.: 312-678-5350

President: W. S. Grommes
Sales Manager: W. Stow
Chief Engineer: A. A. Hart
Products: integrated audio amplifiers. Amps for mono or stereo power, line, music-on-hold. Mixer preamplifiers, 2 CH. limiters or compressors, graphic equalizers, FM-AM tuners, background music receivers and systems, public address systems, custom engineered sound reinforcement systems, sound columns, trumpets, driver units, baffles, microphones and microphone stands.
See full listing under **Audio Amplifiers**.

HARRIS CORP., DRACON DIV., 809 Calle Plano,
Camarillo, CA 93010 Tel.: 805-987-9511

Vice President/General Manager: John R. Mason
Sales Manager: Tom Erdmann
Chief Engineer: Joe Mader
Products: telephone integrated paging systems for PBX, PABX and key systems.
See full listing under **Paging Systems—All Types**.

IMC, 1316 E. Lancaster, Ft. Worth, TX 76102
Tel.: 817-336-5114

President: Jerry Freed
Sales Manager: Claude Boyd
Chief Engineer: Jim Cowser
Products: Akai—multitrack recorder, synthesizers. Studiomaster—recording and live mixing consoles. Ross—multitrack recorders, PA systems, guitar amps and effects. Fane—professional loudspeakers and compression drivers.

JBL PROFESSIONAL, 8500 Balboa Blvd., North-
ridge, CA 91329 Tel.: 818-893-8411

President: Ron Means
Vice President, Sales: Ken Lopez
Applications Engineer: Drew Daniels
Products: high quality loudspeakers and loudspeaker systems of all kinds; automatic microphone mixer; electronic crossover; special loudspeakers for musical instruments.
District Offices:
Tom Roseberry, 3040 Charlevoix Dr. S.E., #101, Grand Rapids, MI 49506
Neil Conley, 3117 Murphy, Bedford, TX 76021
Bill Hamilton, 615 7th Ave., Folsom, PA 19033
Steve Armstrong, 8500 Balboa Blvd., Northridge, CA 91329
E. S. Gould Marketing Ltd., 6445 Cote de Liesse, Montreal, Que. H4T 1E5

LCA SALES CO., 76 Main St., Tuckahoe, NY
10707 Tel.: 914-961-4700
800-LCA-REPS (outside NY)

President: Joel H. Schwartz
General Manager: R. R. Sherwood
Products: manufacturers' representatives for: Blonder-Tongue, BES, Carol Cable, Eaton/Dekoron, Gentex, Harrington, M/A-Com Video/Data, N.I.T., Panasonic CCTV, Reliable Security, Siedle, University, Videoscope/Quadravision.
See full listing under **Alarm, Security & Life-Safety Systems**.

LOWELL MANUFACTURING CO., 3030 Laclede Sta.
Road, St. Louis, MO 63143

Chairman: Ben W. Lowell
President: Dorothy H. Lowell
Sales Manager: John Lowell
Products: speakers, baffles, enclosures, mounting accessories, attenuators, pre-packaged speaker assemblies, switchpak and relay modules, sound masking equipment, microphone connector plates.

LT ELECTRONICS LTD., 2535 Gerrard St. East, Scar-
borough, Canada M1N 1W9 Tel.: 416-691-9406

President: Jim Breedon
Sales Manager: Jim Breedon
Chief Engineer: J. Hesse
Products: school intercoms, cone speakers, sound columns, packaged amplifiers, telephone amplifiers, speaker baffles, bass reflex speaker systems.
See full listing under **Paging Systems**.

MG ELECTRONICS, 32 Ranick Rd., Hauppauge,
NY 11787 Tel.: 516-582-3400

President: Louis Maltz
Vice President: Elliott Maltz
Sales Manager: Stan Grey
Products: full line of commercial sound speakers 4 1/2" to 8", foreground and background mini speaker systems, attenuators and L-pads, ceiling grilles, paging horns with and without transformers.
District Offices:
Gil Miller Assocs., 49 Greenwich Ave., Greenwich, CT 06850
DeWitt Austin Co., Box 22071, Charlotte, NC 28222
World Wide Products, 108-18 N.W. 6th Ct., Miami, FL 33168
Brian Dolan, 10902 Bucknell Dr., #724, Silver Spring, MD 20902

MTX LOUDSPEAKERS, One Mitek Plaza, Winslow, IL
61089 Tel.: 815-367-3811

President: Lloyd L. Ivey
Sales Manager: Rob Landsberg
Chief Engineer: Nick Leiendecker
Products: professional replay sound reinforcement loudspeaker systems; PA systems, speakers for commercial installations: foreground and background music systems, horns, drivers, complete line of home, automotive speakers.

MUSIC SUPPLY CO., INC., 809 N. Madison, Dallas,
TX 75208

Tel.: Texas call collect 214-946-8450
All others 1-800-527-1522

President: W. E. Brown
Products: speaker support trusses (T-bar bridge) to support 8" speakers. Prevent ceiling sag. For 2x4 and 2x2 and 4x4 lay-in type ceiling. Lightweight — 12 oz. — save freight.

MUSIC SUPPLY CO., INC., 809 N. Madison, Dallas,
TX 75208 Tel.: 1-800-527-1522,
Texas Collect 214-946-8450

President: W. E. Brown
Products: speaker enclosure (Black Box-Top Hat) one piece, drawn construction. All Steel. U.L. listed.

OAKTRON INDUSTRIES, INC., 1000 30th St., Mon-
roe, WI 53566 Tel.: 800-356-3609

President: William L. Rollins
Sales Manager: Jerry Disch
Engineering: Pat Ochs
Products: general, automotive, home entertainment, government, musical instrument and commercial sound. OEM research and development. Sound masking, transformers, ceiling grilles, metal stamping, auto speaker kits and accessories.
District Offices:

Newco, Inc., 2701 Rockcreek Pkwy., Ste. 221, N. Kansas City, MO 64117

C.B. Electronic Marketing, 6429 Iris Way, Arvada, CO 80004
Millar Electronics, Inc., 3110 Maple Dr. NE, Ste. 110, Atlanta, GA 30305

Kendall Assocs., 220 Bliss Lane, Great Falls, VA 22066
Lessing Assocs., 2432 San Fernando Rd., Ste. 203, Newhall, CA 91321
Leo Barker Co., 12 Houston Dr., N. Little Rock, AR 72116

Jack Brown Elect. Sales, 14-34 150th Street, Whitestone, NY 11357
Campion Sales Co., Inc., 5231 Gordon Smith Blvd., Rowlett, TX 75088
Roy Colen Sales, Inc., 169 Stadium Ave., Mill Valley, CA 94941

Electronic Specialists, Inc., 381 N. York Rd., Elmhurst, IL 60126
Steve Fisher Assoc., 5611 N. 53rd Ave., Glendale, AZ 85301

Warren Kaufman Associates, 157 Rawlinson Rd., Rochester, NY 14617
Kodo Associates, Inc., 8314 Pillsbury Ave. S, Minneapolis, MN 55420

The MacInnis Co., 106 Access Rd., Norwood, MA 02062

Maish Sales, 500 S. Madison St., Mulberry, IN 46058

SRT Marketing, 7107 Larimer Court, Tampa, FL 33615

Diek Schnepf Associates, 15649 Kalisher St., Granada Hills, CA 91344

Shamrock Electronics, Inc., 1071 Patterson Road, Dayton, OH 45420

RG Associates, 11 Brandywine Terrace, Millis, MA 02054

Vector Corp., 2401 10th Avenue E., Seattle, WA 98102

**PARAMOUNT SOUND SYSTEMS, 5555 Melrose Ave.,
Los Angeles, CA 90038 Tel.: 213-468-4601**

President: Earl Lestz

Sales Manager: Jerry Barnett

Product: GS-3 Omnispeaker, a direct burial outdoor speaker in shrub green color. It houses an 8" driver, optional 70-volt transformer.

**PASO SOUND PRODUCTS, INC., 14 First St., Pel-
ham, NY 10803 Tel.: 914-738-4800**

Vice President, Engineering: Paul Mastrangelo

Operations Manager: Anthony Sgueglia

Distributor Sales Manager: David Moore

Products: wall baffles and ceiling baffles, all available with speakers, line transformers and volume control. Corridor speakers, trumpets, horns, weatherproof speakers, high power full range sound columns, critical application sound columns, stage monitors, full range horn loaded bass reflex loudspeaker systems, autotransformers, line transformers.

See full listing under **Engineered Sound Systems.**

**PHILIPS MICROPHONES, 77 Selleck St., Stamford,
CT 06902 Tel.: 203-348-2121**

Vice President/General Manager: S. R. Ravich

Sales Manager: D. Talbot

Technical Manager: D. Pilkington

Products: full line of backplate electret condenser microphones for professional or special purpose use. This line includes: hand-held mics w/equalization, gooseneck mics, noise-cancelling mics. Standard series include hypercardioid, ball-head mics, gooseneck, hypercardioid and gooseneck noise-cancelling w/table stand.

**PROJECTED SOUND INC., P.O. Box 112, 469 Avon
Ave., Plainfield, IN 46168 Tel.: 317-839-4111**

President: Margaret L. Hilligoss

Sales Manager: Tom Hilligoss

Chief Engineer: J. Mark Hilligoss

Products: general purpose loudspeakers for intercom, PA, background music, etc.

**PYLE INDUSTRIES, INC., 501 Center St., Huntington,
IN 46750 Tel.: 219-356-1200**

President: Frank Pyle, Jr.

Sales Manager: Mark E. Pyle

Chief Engineer: Harold Rich

Products: loudspeakers and accessories, including pro sound reinforcement/musical instrument, high fidelity, public address/commercial sound, and car stereo.

August, 1985

District Offices:

Don Forth Assocs., P.O. Box 2226, W. Covina, CA 91793

Marcus Johnson Assocs., 217 Main St., St. Charles, MO 63301

Mark Petty Assocs., 332 Iowa Ct., Carol Stream, IL 60187

Steve Fisher Electronic Sales, P.O. Box 438, Teaneck, NJ 07666

Morhan Exporting Corp., 270-78 Newtown Rd., Plainview, NY 11803

**THE Q LINE CORP., P.O. Box 20037, 2808 Lakeside
Dr., Oklahoma City, OK 73120**

Tel.:

405-751-3294

President: John W. Quade

Products: Q Liner speaker shield. Low cost speaker enclosure, matches speaker flange, protects against foreign matter, weather. Available in semi-rigid plastic/flame retardant plastic for background music and PA systems, auto radio/tape systems.

**QUAM-NICHOLS CO., 234 E. Marquette Rd., Chi-
cago, IL 60637 Tel.: 312-488-5800**

President: W. G. Little

Distributor Sales Manager: G. L. Johns

Chief Engineer: Oswald Rohrbacher

Products: loudspeakers, ceiling baffles, line matching transformers and back box enclosures for background music, public address system and other commercial sound applications.

District Offices:

Chuck Olson Assocs., 17003 S.E. 136th, Renton, WA 98056

Given-Flanagan Assocs., 107 Pierce St., W. Boylston, MA 01583

R. E. Breuer Co., 2 Haven Ave., Pt. Washington, NY 11050

Cartwright & Bean of Georgia, 3198 Cain's Hill Pl., Atlanta, GA 30305

The Lewis & Dunnigan Co., Inc., 104 Jamesville Rd., Syracuse, NY 13214

Mandabach-Lehner Co., 155 S. Hamilton Rd., Columbus, OH 43213

McBride Loudspeaker Source Inc., 440 Phillip St., Waterloo, Ont. N2L 5R9

Thomas L. Dowell & Assocs., Inc., 7810 Foster St., Overland Park, KS 66204

Foster Technical Sales Co., 7611 Washington Ave. S., Edina, MN 55435

Robert Milsk Co., Box 2290, Southfield, MI 48037

Mouthrop Sales, Inc., 7080 Commerce Dr., Pleasanton, CA 94566

Bidwell Sales Assocs., P.O. Box 2032, Gardena, CA 90247

J. Y. Schoonmaker Co., Inc., 10710 Sand Hill Rd., Dallas, TX 75238

Ken Levi & Associates, 6430 N. Central Ave., Chicago, IL 60616

Lowery Associates, 2801 W. Chester Pike Rd., Broomall, PA 19008

**RAYTRONICS, 4901 Morena Blvd., San Diego, CA
92117 Tel.: 619-270-4000**

President: Dennis Berglund

Vice President, Manufacturing: Don Foley

Sales Manager and Marketing Director: Keith Goldstein

Products: solid state intercom for drive-thru in high noise level applications; vehicle sensing equipment and with repeat chime; high quality amplifiers, horns; speech processing equipment; drive-thru visual ordering systems.

**RENKUS-HEINZ, INC., 17851 AB Sky Park Circle,
Irvine, CA 92714 Tel.: 714-250-0166**

President: H. Heinz

Director of Marketing: Jason Larson

Chief Engineer: Bill Gelow

Products: high frequency compression drivers, horns, networks and professional speaker systems.

District Offices:

M.B.T., 560 Sanda Dr., Pittsburgh, PA 15243

Musonic, 15 Eastway, Asheville, NC 28804

Metro Rep., 57 South St., Freehold, NJ 07728

PAA, 104 Drake, Burlington, MA 01803

SANMING ELECTRONIC SOUND EQUIPMENT CO., LTD., 12715 Western Ave., Garden Grove, CA 92641 Tel.: 714-891-2252

President: Hugh C. Hsieh
Sales Manager: Leon C. Hsieh
Chief Engineer: S. W. Hsu
Products: 60 watt and 100 watt siren speakers for emergency vehicle and stations; 10 watt, 15 watt and 30 watt siren speakers for security systems; 15 watt and 30 watt paging horns for voice transmissions.

SOUNDSPHERE

SONIC SYSTEMS INC., 737 Canal St., Bldg. 23B, Stamford, CT 06902 Tel.: 203-356-1136

President: Peter Hamilton
Sales Manager: John Karamon
Products: various models of Soundsphere omnidirectional loudspeakers are used in live entertainment, churches, gymnasiums, airports, shopping malls and other locations that require sound reinforcement.

SOUNDOLIER, 9380 Watson Industrial Park, St. Louis, MO 63126 Tel.: 314-962-9870

Vice President/Director of Marketing: Herbert M. Jaffe
Director of Sales: Paul Grote
National Sales Manager: Tony Dalba
Chief Engineer: John Saller
Products: commercial sound loudspeakers, enclosures and accessories for music, alarm and public address systems, baffles for ceilings and walls, matching transformers and backbox enclosures.
District Offices:
Secom Systems, 5241-F New Peachtree Road, Atlanta, GA 30341
Bencsik Associates, 3730 N.E. 42nd Ave., Ocala, FL 32670
Monfort Electronic Marketing, P.O. Box 40905, Indianapolis, IN 46240
Ziskind Associates, 5420 Newport Drive, Ste. 52, Rolling Meadows, IL 60008
Miller & Associates, Inc., P.O. Box 340028, Dallas, TX 75234

SOUND PRODUCTS/3M, 3M Center 225-3N-04, St. Paul, MN 55144 Tel.: 612-733-0447

Marketing Manager: Don Rada
Sales Manager: Jack Dingley
Products: music libraries for all purposes. Reliable player. Industrial quality intercoms. Top-line message repeater. Speaker assemblies for distributed systems. Microphones, amplifiers and other sound system components.
See full listing under **Pro Audio Sound Systems.**

SPECO DIV., (Components Specialties, Inc.)
1172 Rt. 109, P.O. Box 624, Lindenhurst, NY 11757 Tel.: 516-957-8700 (in NY)
1-800-645-5516 (outside NY)

President: Louis W. Keller
Vice President: Stan Hulkower
General Manager: James Ganci
Director Sales and Marketing: Mel Hulkower
Products: PA horns, amplifiers, tuners, loudspeakers, wall baffles, speaker assemblies, outdoor speakers, sound columns, ceiling grilles, transformers, L-pads, attenuators, accessories, microphones, intercoms, alarm sirens, multitestors, oscilloscopes.

TAD (Technical Audio Devices), 5000 Airport Plaza Dr., Long Beach, CA 90815 Tel.: 213-420-5700

President: Sho Yamada
Sales and Marketing Manager: Randy Dowis
Product Planner: Mark Makabe
Products: loudspeakers, raw speakers, drivers, and a stabilized dispersion.

TOA ELECTRONICS, INC., 480 Carlton Ct., S. San Francisco, CA 94080 Tel.: 415-588-2538

President: Sam Sakata
Sales Manager, Sound and Communication Products: Joe Green/Gail Martin, Sr.
Chief Engineer: Tad Inui
Products: engineered VMS series sound systems, microcomputerized EXES intercom systems, commercial sound systems, amplifiers, dual amplifiers, equalizers, multifunctional preamplifiers, mixing consoles, horns, drivers, speakers, wireless systems.
See full listing under **Engineered Sound Systems.**

UNIVERSITY SOUND, (Altec Div.), 10500 W. Reno Ave., Oklahoma City, OK 73126 Tel.: 405-324-5311

President: F. Davis Merrey
National Sales Manager: David Jetzke
Vice President, Marketing: Gary Rilling
Products: complete line of horns, drivers, speakers, mounting and transformer accessories, microphone stands and accessories.
District Offices:
Avcom, Inc., 27733 Lorain Rd., N. Olmsted, OH 44070
Nevco, Inc., 2701 Rockcreek Pkwy., #221, N. Kansas City, MO 64117
C B Marketing, 6429 Iris Way, Arvada, CO 80004
Austin Assocs., 50 Windsor Lane, Willingboro, NJ 08046
W. B. Pray Sales Inc., 362 Davis St., Northboro, MA 01532
Henry W. Phillips Co., Inc., 110 Mansell Cir., Roswell, GA 30075-3789
Brian Trankle & Assocs., 820 Black Mountain Rd., Hillsboro, CA 94010
Chuck Olson Assocs., 17003 S.E. 136th, Renton, WA 98055
Avwest, Inc., P.O. Box 17479, Fountain Hills, AZ 85268
L.C.A. Sales Co., 76 Main St., Tuckahoe, NY 10707
Hutto/Hawkins/Peregoy Inc., 139 Candace Dr., Maitland, FL 32751
Elmarcon Inc., 8811 Manderley Dr., Indianapolis, IN 46240
Upstate Marketing, 542 Swaggerton Rd., Glenville, NY 12302
Ken Levy Associates, 6430 N. Central, Chicago, IL 60646
Miller & Associates, 1710 Firman Drive, Suite 200, Richardson, TX 75085
Dick Schnepf Assoc., 15649 Kalisher St., Granada Hills, CA 91344
Edcom, Inc., 755 Center St., Lewistown, NY 14092-0506
HMR Incorporated, 9065 Lyndale, Ave., S. Minneapolis, MN 55420

UREI, 8500 Balboa Blvd., Northridge, CA 91329 Tel.: 818-893-8411

President: Ron Means
Vice President, Sales: Ken Lopez
Application Engineer: Drew Daniels
Products: power amplifiers, limiters, compressors, equalizers, filters, Time Aligned™ speakers, direct boxes, electronic crossover, digital metronome, transcription preamplifier, disco mixers, broadcast consoles.
See full listing under **Audio Signal Processors.**

VALCOM, INC., 1111 Industry Ave., Roanoke, VA 24013 Tel.: 703-982-3900

President: J. W. Mason
Sales Manager: Donald Buck
Chief Engineer: D. Lynch
Products: telephone integrated paging and intercom systems, talkback, bell-buzzer, code call, PBX adapters, key telephone system ancillaries, loud-ringers, power supplies, amplified and talkback speakers. Single line and feature telephones.
See full listing under **Paging Systems.**

WORKMAN ELECTRONIC PRODUCTS, P.O. Box 3828, 75 Packinghouse Rd., Sarasota, FL 33578 Tel.: 813-371-4242

President: Robert Goldstein
Product Sales Manager: Aubra L. Houston
Products: speakers, baffles, grilles, line transformers, L-pads, grilles and speakers and transformer combinations, baffles, speakers and trans. combinations any combinations available.

District Offices:

Electronic Reps. Inc., P.O. Box 49797, Sarasota, FL 33578
Mid Central Sales, 8613 Graydon Dr., Fern Creek, KY 40291
Lectro Reps. Inc., P.O. Box 336, Liberty, MO 64068
Don Forth Assoc., P.O. Box 2226, West Covina, CA 91793
Hank Miller Assoc., 643 Allison Dr., Cleveland, OH 44143

MAGNETIC TAPE SYSTEMS & SUPPLIES

BURLINGTON AUDIO TAPES, INC., 106 Mott St.,
Oceanside, NY 11572 Tel.: 516-678-4414

Director of Marketing: David J. Schwartz
Products: all major brands of audio and video tapes, reels, cassettes
and related supplies. Empty reels, hubs, boxes, etc.

CETEC GAUSS, 9130 Glenoaks Blvd., Sun Valley,
CA 91352 Tel.: 213-875-1900

President: W. Mori Fujii
Sales Managers: J. Fleischmann, P. Horsman
Chief Engineer: J. Williams
Products: musical component loudspeakers, precision components for
sound reinforcement, custom systems, high-speed tape duplicating
equipment.

GYRR PRODUCTS, 1515 S. Manchester Ave., Anaheim,
CA 92802 Tel.: 714-772-1000

President: Crandall Gudmondson
Director of Marketing, Audio Products: Robert Hagemann
Director of Marketing, Video Products: Terry Tetirick
Products: multi-track audio tape recorders for conference and court-
room use; video cassette time lapse recorders for security use.

IGM COMMUNICATIONS, INC., 282 W. Kellogg Road,
Bellingham, WA 98226 Tel.: 206-733-4567

President: Jim Wells
Sales Manager: Nick Solberg—Custom Systems
Sales Manager: Fred Harkness—Standard Systems
Chief Engineer: Jim Wolniakowski
Products: Go Cart random access cartridge playback unit. Instacart—
instant access cartridge playback unit IGM-SC system controller.

MACKENZIE LABORATORIES, INC., 5507 Peck Rd.,
P.O. Box 3029, Arcadia, CA 91006
Tel.: 800-423-4147 818-579-0440

President: A. R. Taylor
Sales: Joe M. Vitale
Vice President and Chief Engineer: N. Khattar
Products: solid-state, digital audio message repeaters, heavy-duty,
endless-loop message repeaters, voice alarm and evac. equipment, voice
security equipment, boardroom AV equipment control systems.
District Office:

Avwest, Inc., 16919 Nicklaus Dr., Fountain Hills, AZ 85268
Lex Lawson Assocs., 12343 E. Northwest Hwy. #2, Dallas, TX 75228
Avcom, Inc., 27733 Lorain Road, No. Olmstead, OH 44070
Rancilio Assocs., 84 Grasso Plaza, St. Louis, MO 63123
Warren Assocs., 2338 Calle Del Mundo, Santa Clara, CA 95054
Piper Assocs., 33 Marsh Road, Needham, MA 02192
Bencsik Assocs., 3730 NE 42nd Lane, Ocala, FL 32670
The Media Man, 313 Rutland Ave., Teaneck, NJ 07666
Raleigh Perry & Assocs., 3963 Magnolia Lane, Buford, GA 30518
Ken Levy & Assocs., 6430 No. Central Ave., Chicago, IL 60646
Design Factors, P.O. Box 5236, Hacienda Heights, CA 91745-0236
Austin Assocs., 2527 Quebec School Road, Middletown, MD 21769

NORTRONICS CO., INC., 8101 Tenth Ave. No.,
Minneapolis, MN 55427 Tel.: 612-545-0401

President: John A. Yngve
Marketing Manager: Ed Bedell
Engineering Manager: Mike Drees
Products: magnetic tape heads for reel-to-reel and cartridge tape
recorders for the replacement and original equipment marketplace.

PHI TECHNOLOGIES, INC., 4605 N. Stiles, Oklahoma
City, OK 73105 Tel.: 405-521-9000

President: Henry E. Juskiewicz
Sales Manager: Gary A. Zebrowski
Chief Engineer: Larry DeBell
Products: heavy-duty cassette tape transports, random-access message
systems, cassette playback units for background music, message
repeaters and digital audio message systems.

SOUNDCRAFT ELECTRONICS, INC., 1517 20th St.,
Santa Monica, CA 90404 Tel.: 213-453-4591

President: Betty Bennett
Vice President, Sales: Wayne Freeman
Products: audio mixing consoles and multi-track tape machines. Ap-
plications include live recording, sound reinforcement, studio record-
ing, remote recording, broadcast and post production. Full range of
power amplifiers.
See full listing under **Pro Audio Sound Systems**.

TASCAM, Teac Professional Division, 7733 Telegraph
Road, Montebello, CA 90640 Tel.: 213-726-0303

President: Noria Tamura
National Sales Manager: William Mohrhoff
Director of Product Planning: Dave Oren
Product/Service Manager: Jon Bliese
Advertising Manager: Anders Madsen
Products: a manufacturer committed to stereo, stereo plus cue and four-
channel cassette and two-track up to 16 track open reel
recorder/reproducers. Features include single-connector SMPTE in-
terlock capability.
See full listing under **Pro Audio Systems**.

MESSAGE REPEATERS/ STORECASTERS

EDCOM, INC., 755 Center St., Lewiston, NY 14092-0506
Tel.: 716-754-7130

President: J. D. Breedon
Sales Manager: James K. Wood, V.P. Marketing
Director of Engineering: Peter Jova
Products: automatic announcement tape machines, digitized speech
system with on site recording facility, up to 256 messages, 50 minutes
compressed speech storage capacity. Full remote control capability.
See full listing under **Engineered Sound Systems**.

ELTREX INTERNATIONAL, 2 Columbia Dr., Amherst,
NH 03031 Tel.: 603-886-3500 Telex: 953016

President: T. H. Sullivan
Sales Manager: Bill Ryan
Products: complete line of radio paging encoders, terminals, test equip-
ment for 2-tone and 5-tone sequential solid state voice recorders and
digital delay units for the broadcast industry.

IGM COMMUNICATIONS, INC., 282 West Kellogg Road, Bellingham, WA 98226
Tel.: 206-733-4567

President: Jim Wells
Sales Manager: Nick Solberg—Custom Systems
Sales Manager: Fred Harkness—Standard Systems
Chief Engineer: Jim Wolniakowski
Products: Go Cart random access cartridge playback unit. Instacart— instant access cartridge playback unit. IGM-SC system controller.

MACKENZIE LABORATORIES, INC., 5507 Peck Rd., Arcadia, CA Tel.: 818-579-0440
800-423-4147

President: A. R. Taylor
Sales: Joe M. Vitale
Vice President and Chief Engineer: N. Khattar
Products: solid-state digital audio message repeaters and heavy duty single and multiple cartridge endless-loop message repeaters.
See full listing under **Magnetic Tape Systems & Supplies**.

PHI TECHNOLOGIES, INC., 4605 N. Stiles, Oklahoma City, OK 73105 Tel.: 405-521-9000

President: Henry E. Juskiewicz
Sales Manager: Gary A. Zebrowski
Chief Engineer: Larry DeBell
Products: heavy-duty cassette tape transports, random-access message systems, cassette playback units for background music, message repeaters and digital audio message systems.

SOUND PRODUCTS/3M, 3M Center 225-3N-04, St. Paul, MN 55144 Tel.: 612-733-0447

Marketing Manager: Don Rada
Sales Manager: Jack Dingley
Products: music libraries for all purposes. Reliable player. Industrial quality intercoms. Top-line message repeater. Speaker assemblies for distributed systems. Microphones, amplifiers and other sound system components.

TAPE-ATHON CORP., 13633 Crenshaw Blvd., Hawthorne, CA 90250 Tel.: 213-676-6752

President: Leon Tate
Sales Manager: Robert Mayfield
Chief Engineer: Bernard Sayers
Products: complete line reel-to-reel play back from on-premise through completely automated central studio systems, portable and rack mount, chimes line; all speed - customized music library — sale or lease.
See full listing under **Background/Foreground Music Systems**.

TELEPHONE SALES & SERVICE CO., 25 DeForest St., Amityville, NY 11701 Tel.: 516-842-4800

President: Harry F. Bradley
Products: electronic PAX; Select-O-Phone II to 64 stations with 100% trunkage. Comtrac EPAX 64 to 4000 stations. Electronic code-call with telephone access. Message repeater.

MICROPHONES

ACCUSONIC SYSTEMS CORP., (Subsidiary of Design Atronics Inc.), 2101 Jericho Turnpike, New Hyde Park, NY 11040 Tel.: 516-328-3300

President: Sol Schwartz
Sales Manager: Dennis Goodman
Products: military and severe environment microphones, speakers and headsets.

AKG ACOUSTICS, INC., 77 Selleck St., Stamford, CT 06902 Tel.: 203-348-2121

Vice President: S. R. Ravich
Sales Manager: D. Talbot
Tech Manager: D. Pilkington
Products: studio condenser microphones; prepolarized condenser microphones; professional dynamic microphones; cardioid dynamic microphones; special purpose microphones; stereo headphones; boom sets; accessories, reverb units, phonocartridges, digital delays.

ASTATIC CORP., Harbor & Jackson Sts., P.O. Box 120, Conneaut, OH 44030 Tel.: 216-593-1111

Chairman of the Board and President: Michael Chait
Corp. Manager, Sales & Marketing: Harry Hahn
Chief Engineer: Stanley Maire
Products: microphones — dynamic, ceramic, crystal, carbon for public address, recording, entertainment, communications; magnetic phonograph cartridges and needles, pickups, headsets, audio accessories.
Sales Representative:
Canadian Sales Mgr., Robert Harvey, 1220 Ellesmere Rd., Scarborough, Ont. M1P 2X5

ATLAS SOUND, 10 Pomeroy Rd., Parsippany, NJ 07054 Tel.: 201-887-7800

Vice President, Marketing: Herbert M. Jaffe
National Sales Manager: David A. Chambers
Chief Engineer: Bob Greulich
Products: functional modern and widest selection of floor, boom, desk stands for all applications. Complete selection of microphone accessories, adaptors and fittings.
See full listing under **Loudspeakers & Accessories**.

AUDIO TECHNICA U.S. INC., 1221 Commerce Dr., Stow, OH 44224 Tel.: 216-923-0376

President: Jon Kelly
Sales Manager: Charlie Winkler
Chief Engineer: Bob Herrold
Products: microphones and microphone accessories, recorder/mixers, cables, direct boxes, headphones.

BEYER DYNAMIC, INC., 5-05 Burns Ave., Hicksville, NY 11801 Tel.: 516-935-8000

National Sales Manager: Tony Hawkins
Products: full line of headphones and accessories for consumer audio, broadcasting, studio, film and TV application.

BOGEN, A Lear Siegler Company, Box 500, Paramus, NJ 07653 Tel.: 201-343-5700

President: John H. Ochtera
Vice President, Marketing-Sales: Carl C. Dorwaldt
Vice President, Engineering: Mark Koller
National Sales Manager: Art Arlow
Products: dynamic and condenser; omni-directional, cardioid, supercardioid; desk-top, hand-held, lavalier, subminiature, gooseneck. Accessories include transformers, attenuator, windscreen, floor and desk stands, boom attachments.
See full listing under **Engineered Sound Systems**.

CALRAD ENGINEERED ELECTRONIC PRODUCTS, 819 No. Highland Ave., Los Angeles, CA 90038
Tel.: 213-465-2131

President: Joseph Shupper
Vice President: Robert Shupper
Sales Manager: Fred Crown
Chief Engineer: Wes Black
Products: microphones, headphones, public address amplifiers, power supplies, speakers, connecting cables, telephone accessories, potentiometers, connectors, switches, meters, control knobs.
See full listing under **Audio Amplifiers**.

CETEC RAYMER, 7315 Fulton Ave., N. Hollywood,
CA 91605 Tel.: 213-875-0423

President: Richard P. Drake
Chief Engineer: C. L. Kogge, Jr.
Products: background/foreground equipment: wall and shelf mount amplifiers, AM/FM tuners and paging receivers, microphone mixers, installation accessories and transformers, M-O-H and telephone interconnect devices, and test equipment.
See full listing under **Background/Foreground Music Systems**.

CETEC VEGA, 9900 Baldwin Pl., El Monte, CA
91731 Tel.: 818-442-0782

General Manager: Gary J. Stanfill
National Sales Manager: Paul Baughman
Director of Marketing: Kenneth M. Bourne
Products: wireless microphone systems with very low noise receivers and transmitters (pocket and hand-held) and switchable DYNEX® II audio processing; full-duplex walkaround wireless intercom systems; tone signaling equipment.

CROWN INTERNATIONAL INC., 1718 W. Mishawaka
Rd., Elkhart, IN 46517 Tel.: 219-294-8000

President: Max W. Scholfield
Marketing Manager: Charles W. Gushwa
Engineering Manager: Verne E. Searer
Products: full line of Pressure Zone Microphones® (PZM®) for use on surfaces. Eliminates phase interference and off-axis coloration. Excellent clarity and reach. PCC™ 160 Phase Coherent Cardiod™ surface mounted supercardiod microphone.

J. W. DAVIS & CO., 3215 Canton St., P.O. Box 26177,
Dallas, TX 75226 Tel.: 214-651-7341

1-800-442-1564 (Texas)
1-800-527-5705 (outside Texas)

President: M. H. Earp
Executive Vice President: W. A. Hevron
Chief Engineer: J. E. Mitchell
Products: microphones for the professional entertainer and commercial sound installation. Dynamic and condenser types, both available including both wired and wireless configurations. Stands, cable and other accessories.

EDCOR, 16782 Hale Ave., Irvine, CA 92714
Tel.: 714-863-1529

President: Larry Weston
Chief Engineer: Harold Keeling
Products: wireless microphones on "high" or "low" band. Tour Kits, diversity systems, multi channel systems. Four and eight channel phantom power supplies for electret or condenser microphones.

ELECTRO-VOICE, INC., 600 Cecil St., Buchanan, MI
49107 Tel.: 616-695-6831

President: Robert D. Pabst
Vice President, Sales and Marketing: Paul McGuire
Chief Engineer: Earl Harris
Director of Marketing, Professional Sound Reinforcement Products: James Long
Products: broadcast, recording, communications and PA microphones; public address and component high-fidelity loudspeakers, systems and enclosures, sound reinforcement products.

HEIL LTD., #2 Heil Drive, Marissa, IL 62257
Tel.: 618-295-3000

President: Bob Heil
Chief Engineer: John Rutter
Products: mixing consoles, power amplifiers, parametric EQ, crossovers, satellite TV antennas, amateur radio and communication microphones.

HM ELECTRONICS, INC., 9675 Business Park Ave.,
San Diego, CA 92120 Tel.: 619-280-6050

President: H. Y. Miyahira
Sales Manager: John F. Kenyon
Chief Engineer: Ken Fasen
Products: professional wireless microphones, handheld or bodypack transmitters with 115dB dynamic range, full duplex wireless intercom systems and a complete line of cabled intercom products.
District Offices:
John B. Anthony Co., 992 High Ridge Road, Stamford, CT 06905
Sunwest Marketing, 818 E. Riverview, Orange, CA 92665
Applied Audio Marketing, 26 Audubon Dr., Asheville, NC 28804
Radon & Associates, 34 Sunnyside Ave., Mill Valley, CA 94941
Silver Peak Marketing, 6280 W. 38th Ave., Wheat Ridge, CO 80033

KNOWLES ELECTRONICS, INC., 3100 N. Mannheim Rd., Franklin Park, IL 60131
Tel.: 312-455-3600

President: Hugh S. Knowles
Vice President, Marketing: Reg. G. Garratt
Products: subminiature transducers — magnetic, ceramic and condenser — electret microphones; microphone/speaker products; "beeper" speakers; vibration transducers.

LECTROSONICS, INC., 2100 Atrisco Dr., N.W., P.O.
Box 12617, Albuquerque, NM 87195
Tel.: 505-831-1010

President: John Arasim, Jr.
Sales Manager: Bruce C. Jones/J. D. Madden
Chief Engineer: Larry Fisher
Products: VHF wireless microphone systems for all applications; ultra miniature VHF receiver for video/intercom; multiple input transmitters; 19" rack mount receiver systems, unique no-interference guarantee.
See full listing under **Pro Audio Systems & Products**.

NADY SYSTEMS, INC., 1145 65th St., Oakland, CA
94608 Tel.: 415-652-2411

President: John Nady
Sales Manager: Peter Kalmen
Chief Engineer: John Nady
Products: wireless microphones, infrared listening systems, wireless intercoms and portable sound systems.

NUMARK ELECTRONICS, 503 Raritan Center, Edison,
NJ 08837 Tel.: 201-225-3222

President: Harry Kotovsky
Sales Manager: Paul Friedman
Products: power amplifiers, mixers, equalizers, noise reduction, expansion system, video sound processors.
See full listing under **Pro Audio Sound Systems**.

PASO SOUND PRODUCTS, INC., 14 First St., Pelham, NY 10803
Tel.: 914-738-4800

Vice President, Engineering: Paul Mastrangelo
Operations Manager: Anthony Sgueglia
Sales Manager: David Moore
Products: base station with multiple zone, pre-amplified with integrated tone generator, The "Handler" series; hand held low impedance type for general PA and professional application, incorporating Paso's doubly redundant synthetic rubber isolators which reduce handling noise by 90%. Momentary push to talk microphones for fast forward drive-thru systems. Low impedance hand held type with push to talk, multi channel wireless microphone systems.
See full listing under **Engineered Sound Systems**.

ROANWELL CORPORATION, 180 Varick St., New York, NY 10014 Tel.: 212-989-1090

President: James Foley

Sales Manager: C. Carl Hilsdorf

Chief Engineer: Lech Poradowski

Products: noise-cancelling microphones for headset, handset and hand-held applications; noise-attenuating headsets; cord sets and switchbox assemblies. Manufacturers of the patented Confidencer noise-cancelling microphone.

District Offices:

Jewett Company, 1311 Ventura Blvd., No. Hollywood, CA 91604

Hykes Point Inc., P.O. Box 2261, Dayton, Ohio 45429

Tortech Marketing, 43 Creekwood Drive, Scarborough, Ontario M1E 4L6

Sullivan Associates, 1003-218 MacLaren Street, Ottawa, Ontario K2P 0L7

SAMSON PRODUCTS, 124 Fulton Ave., Hempstead, NY 11550 Tel.: 516-489-2203

Sales Manager: Scott Goodman

Chief Engineer: Doug Bryant

Products: wireless systems including hand held microphones, lavalier microphones and instrument models. VHF in concert series (fixed channel receivers) and broadcast series (true diversity, switchable channel receivers).

SENNHEISER ELECTRONIC CORP., 48 W. 38th St., New York, NY 10018 Tel.: 212-944-3440

President: Andrew Brakhan

Sales Manager: Tony Tudisco

Chief Engineer: Horst Ankermann

Products: full line of professional microphones including dynamics, electrets and condenser series as well as UHF and VHF wireless units. Sealed and open-air headphones available.

SHURE BROTHERS INCORPORATED, 222 Hartrey Ave., Evanston, IL 60202 Tel.: 312-866-2200

President: James Kogen

Vice President, Marketing and Sales: Dick Murphy

Chief Engineer: Bernie Jakobs

Products: microphone and circuitry products for broadcast, recording and general sound reinforcement applications.

Sales Representatives:

Berman-Gravley Co., 350-B Fischer Ave., Costa Mesa, CA 92626

Peter E. Schmitt Co., 240 Grand Ave., Leonia, NJ 07605

S. K. MacDonald Inc., 1531 Spruce St., Philadelphia, PA 19102

Key Marketing, 4194 Joy Road, Plymouth, MI 48170

Millar Electronics, P.O. Box 12137, Atlanta, GA 30355

SOUND PRODUCTS/3M, 3M Center 225-3N-04, St. Paul, MN 55144 Tel.: 612-733-0447

Marketing Manager: Don Rada

Sales Manager: Jack Dingley

Products: music libraries for all purposes. Reliable player. Industrial quality intercoms. Top-line message repeater. Speaker assemblies for distributed systems. Microphones, amplifiers and other sound system components.

See full listing under **Pro Audio Sound Systems**.

SPECO DIV., Components Specialties, Inc., 1172 Rt. 109, P.O. Box 624, Lindenhurst, NY 11757 Tel.: 516-957-8700 (in NY) 1-800-645-5516 (outside NY)

President: Louis W. Keller

Vice President: Mel Hulkower

Chief Engineer: James Ganci

Products: PA horns, amplifiers, tuners, loudspeakers, wall baffles, speaker assemblies, outdoor speakers, sound columns, ceiling grilles, transformers, L-pads, attenuators, accessories, microphones, intercoms, alarm sirens, multitestors, oscilloscopes.

SWINTEK ENTERPRISES, INC., 587 Division St., Campbell, CA 94086 Tel.: 408-249-5594

President: William Swintek

Sales Manager: Darisa Hill

Products: radio microphones, VHF/UHF utilizing companding modulation techniques and RF switching diversity. Radio headsets and intercoms, RF antenna systems.

District Offices:

W3 Marketing, 4301 Pleasantdale Road, Doraville, GA

Pass Associates, 27 Oxford Dr., Langhorne, PA

Vide Components, 601 S. Main St., Spring Valley, NY

Wallace Comm., 3805 Candlelight Dr., Jefferson City, MO

R&H Associates, P.O. Box 364, Safety Harbor, FL

TALK-A-PHONE CO., 5013 N. Kedzie Ave., Chicago, IL 60625 Tel.: 312-539-1100

President: Z. Liberman

Sales Manager: Dan F. Kagan

Products: intercom systems—manual and hands free equipment—for industrial, institutional, commercial, home, apartment house, self-service gas station, and fast food drive-thru use; wireless and cable connected models.

TELEX COMMUNICATIONS, INC., 9600 Aldrich Ave. S., Minneapolis, MN 55420 Tel.: 612-887-5550, 612-884-4051

President: John Howe

Director Marketing, Communication Products: Donald Meeen

Products: open-reel and cartridge tape recorders/reproducers, tape transports, record and reproduce electronics, intercoms, broadcast, communications and specialty headphones, headsets and accessories, closed circuit intercoms, microphones.

See full listing under **Pro Audio Sound Systems**.

TOA ELECTRONICS, INC., 480 Carlton Ct., S. San Francisco, CA 94080 Tel.: 415-588-2538

President: Sam Sakata

Sales Manager, Sound & Communication Products: Joe Green/Gail Martin, Sr.

Chief Engineer: Tad Inui

Products: engineered VMS series sound systems, micro-computerized EXES intercom systems, commercial sound systems, amplifiers, dual amplifiers, equalizers, multifunctional preamplifiers, mixing consoles, drivers, speakers, wireless systems, microphones.

See full listing under **Engineered Sound Systems**.

NURSE-PATIENT INTERCOM SYSTEMS

AIPHONE INTERCOM SYSTEMS, 1700 130th Ave., N.E., Bellevue, WA 98005 Tel.: 206-455-0510

President: Hiko Shinoda

Sales Manager: Jim Morrison

Chief Engineer: Jun Matsumoto

Products: industrial, business, residential, loudspeaking, telephone, video intercom/security systems with paging talk-back; six microprocessor systems available, mixer amplifiers, paging speakers, horns, drivers, ceiling speakers.

AMERICAN ZETTLER CORP., 16881 Hale Ave., Irvine, CA 92714 Tel.: 714-660-1670

Sales Manager: Michael E. Nathanson

Products: nurse-call systems including computerized, direct selection, centralized and decentralized.

COMMUNICATIONS EQUIPMENT CO., INC., 6443
Western Ave., Glen Arbor, MI 49636
Tel.: 616-334-3081

President: Hugh I. Morris
Sales Manager: T. A. Garmhausen
Products: five different nurse-call systems including audio-visual, visual only and doctors' in-out registers. Included are emergency call systems for nursing homes and elderly housing, both new construction and rehabilitation.
See full listing under **Engineered Sound Systems**.

CORNELL ELECTRONIC PRODUCTS, INC., 4911
W. Good Hope Rd., Milwaukee, WI 53223
Tel.: 414-351-4660

President: Donald Glaubitz
Vice President and Chief Engineer: Gary Butler
Sales Manager: Pauline Haack
Products: systems for audio/visual nurse-call, door security, apartment intercom, in-and-out register.
District Offices:
Pinz Sales Corp., 570 Yonkers Ave., Yonkers, NY 10704
Avcom, Inc., 27733 Lorain Rd., N. Olmsted, OH 44070
LSM Assocs., 27 Orchard Pk., Phelps, NY 14532
Richard S. Pass Assocs., 27 Oxford Dr., Langhorne, PA 19047
Cavendish Assocs., Inc., 6735 Industrial Blvd., #107, Atlanta, GA 30360
Kingston Sales Corp., 6115 N. Guion Rd., Indianapolis, IN 46254
Riley & Petchell Sales, Inc., 25700 Plymouth Rd., Detroit, MI 48239
Rancilio Assocs., 84 Grasso Plaza, P.O. Box 28869, St. Louis, MO 63123

Russ Bidwell Sales, P.O. Box 2032, Gardena, CA 90247
CB Electronic Marketing, 6429 Iris Way, Arvada, CO 80004
Cartwright & Bean, Inc., 200 E. Marks St., Orlando, FL 32803
Dick Bellew Sales, Inc., 5635 Yale Blvd., #201-2, Dallas, TX, 75206
Piper Assocs., Inc., 33 Marsh Rd., Needham, MA 02192
Avwest Inc., 16919 Nicklaus Dr., Fountain Hills, AZ 85268
Technical Sales Assocs., 1485 Bayshore Blvd., San Francisco, CA 94124
Mel Foster Technical Sales, Inc., 7611 Washington Ave., S., P.O. Box 35216, Edina, MN 55435
Ken Levy & Associates, Ltd., 6340 North Central Ave., Chicago, IL 60646
McLaughlin-Long Marketing Inc., 16301 197th Ave. N.E., Woodinville, WA 98072
Southeast Region: William A. Ellinger, 88 Florida Park Dr., Palm Coast, FL 32027

CREST ELECTRONICS, Simon at Third, Dassel,
MN 55325 Tel.: 612-275-3382, 800-328-8908

President: Howard K. Page
Sales Manager: H. Kelsey Page
Products: pillow speakers, nurse-call cords, bed controls, annunciators, security control systems, doctors' registers, patient lighting, audio and visual nurse-call systems, clinic systems.

J. W. DAVIS & CO., 3215 Canton St., P.O. Box 26177,
Dallas, TX 75226 Tel.: 214-651-7341
1-800-442-1564 (Texas)
1-800-527-5705 (outside Texas)

President: M. H. Earp
Executive Vice President: W. A. Hevron
Chief Engineer: J. E. Mitchell
Products: nurse call systems available for hospitals, nursing homes and doctors offices. Systems may include ceiling or wall speakers, corridor lights, push button pendants, emergency call and voice intercom.

DUKANE CORPORATION, Communications
Systems Division, 2900 Dukane Dr., St. Charles,
IL 60174 Tel.: 312-584-2300

General Manager: William B. Clark
Marketing Manager: Craig E. Lyons
Chief Engineer: Paul D. Graham

Products: communications systems including intercom, public address and background music, professional sound, radio paging, nurse-patient communications, personnel registers and master clock systems.

EDCOM, INC., 755 Center St., Lewiston, NY 14092-0506
Tel.: 716-754-7130

President: J. D. Breedon
Sales Manager: James K. Wood, V. P., Marketing
Director of Engineering: Peter Jova
Products: new micro-processor nurse-call system, 1000 bed capacity, 8 levels of priority, 64 character aloha-numeric LCD display, many user-programmable function, printer port, background music, full line of accessories.
See full listing under **Engineered Sound Systems**.

EKTACOM-FISHER BERKELEY CORP., 5800 Chris-
tie Ave., Emeryville, CA 94608
Tel.: 415-655-9696

President: Robert S. Fisher
Chief Engineer: Robert Shipley
Products: duplex and simplex intercom systems, annunciator and voice call-in; audio-visual and visual-only nurse-call systems; manual and automatic personnel registers, apartment signaling systems.
See full listing under **Intercom Systems—Simplex**.

ELECTRO-COMM SYSTEMS, INC., 7915 N. 81st St.,
Milwaukee, WI 53223 Tel.: 414-354-0202

President and Chief Engineer: Angelo Balistreri
Sales Manager: Jim Ippolite
Products: audio and audio-visual nurse-call systems, door-monitoring devices, apartment intercoms and personnel registers. Emergency call systems for nursing homes and housing for the elderly; custom signaling and communication systems.

ENGINEERED ELECTRONICS, INC., 4301 Industrial
Access Rd., Douglasville, GA 30134
Tel.: 404-949-3290

President: Roy J. Caviness
Sales Manager: Larry A. Fortner
Products: visual and audio-visual nurse-call systems with all associated accessories.

FARADAY, INC., 805 S. Maumee St., Tecumseh, MI
49286 Tel.: 517-423-2111

President: G. Rummell
Sales Manager: J. Frankow
Chief Engineer: R. Miller
Products: intercom and sound distribution systems, public address systems, nurse call systems, fire alarm, annunciator, clock and hospital life safety systems, full range of signaling products.
See full listing under **Alarm, Security & Life-Safety Systems**.

FLORENCE CORP., 2101 N. Elston Ave., Chicago,
IL 60614 Tel.: 312-384-3310

President: Lloyd A. Schooley
Vice President and General Manager: John Martino
Vice President, Sales: Don Cannella
Sales Manager: George Jans
Chief Engineer: Ray Cozzens
Products: nurse calls, emergency calls, mail boxes and apartment communication systems.



JERON

electronic systems, inc.

JERON ELECTRONIC SYSTEMS, INC., 3554 N.
Clark St., Chicago, IL 60657
Tel.: 312-528-4020, 800-621-1903

President: Jerome Chesnul
Sales Manager: David Hayes
Products: audio-visual nurse call. Communication and signaling systems for hospitals, nursing homes, elderly care facilities, institutions. Visual call systems. Clinic call systems. In-out registers.
See full listing under **Apartment House/Hi-Rise Intercoms**.

KOMTEK COMMUNICATIONS, 11 White Lakes Rd.,
Stanley, NM 87056 Tel.: 800-545-7000

President: Bill Patterson
Sales Manager: Doug Fletcher
Chief Engineer: Don Elibee
Products: custom and standard design light signaling systems, including nurse call, doctor message, room status and patient sequencing functions.

LEE DAN COMMUNICATIONS, INC., 155 Adams
Ave., Hauppauge, NY 11788
Tel.: 516-231-1414

President: Leon Goldberg
Sales Manager: Lawrence J. Goldberg
Products: U.L. 1069 listed nurse call systems. Tek-Care emergency call system for multi-dwelling senior citizen housing. Intercom systems for doctors' offices and examining rooms.
See full listing under **Apartment House/Hi-Rise Intercoms**.

RAULAND-BORG CORP., 3535 W. Addison St.,
Chicago, IL 60618 Tel.: 312-267-1300
TWX: 910 221 1290

President: William Krucks
Vice President, Sales and Marketing: Kenneth T. James
Vice President, Field Sales: William C. Zophy
Chief Engineer: Lawrence Gleason
Products: nurse-call systems ("TeleNurse" and "Responder").
See full listing under **Engineered Sound Systems**.

RAYTRONICS, 4901 Morena Blvd., San Diego, CA
92117 Tel.: 619-270-4000, 800-854,1085

President: Dennis Berglund
Vice President, Manufacturing: Don Foley
Sales Manager and Marketing Manager: Keith Goldstein
Products: solid state intercom for drive-thru in high noise applications; vehicle sensing equipment with repeat chime; high quality amplifiers, horns; speech processing equipment; drive-thru visual ordering systems.

SOUNDOLIER, 9380 Watson Industrial Park, St. Louis,
MO 63126 Tel.: 314-962-9870

Vice President/Director of Marketing: Herbert M. Jaffe
Director of Sales: Paul Grote
Chief Engineer: John Saller
National Sales Manager: Tony Dalba
Products: high quality, commercial sound loudspeakers, enclosures and accessories for music, alarm and public address systems, baffles for ceilings and walls, matching transformers and backbox enclosures.
See full listing under **Loudspeakers & Accessories**.

TEKTONE SOUND & SIGNAL MFG. INC., 1331 S.
Killian Dr., Lake Park, FL 33403
Tel.: 305-844-2383

President: M. Mira
Sales Manager: Carlos Mira
Chief Engineer: J. Switzer
Products: intercom systems for home, apartment, commercial/industrial, institutional—telephone, loudspeaking and door answering. Nurse call, security/alarm and AM/FM radio intercom systems.
See full listing under **Apartment House/Hi-Rise Intercom Systems**.

PAGING SYSTEMS

A. E. ELECTRONICS CORPORATION, 111 West 27
St., New York, NY 10001 Tel.: 212-924-1225

President: Arthur S. Rich
Sales Manager: Daniel Arthur
Products: colored lights, flasher and delayed tone display discretely, repetitive messages requiring immediate action. Additional white lights represent the individuals involved in each communication.

AIPHONE INTERCOM SYSTEMS, 1700 130th Ave.
N.E., Bellevue, WA 98005 Tel.: 206-455-0510

President: Hiko Shinoda
Sales Manager: J. M. Morrison
Chief Engineer: Jun Matsumoto
Products: industrial, business, residential, loudspeaking, telephone, video intercom/security systems with paging talk-back; six microprocessor systems available; mixer amplifiers, paging speakers, horns, drivers, ceiling speakers.

ARGOS PRODUCTS CO., INC., 600 S. Sycamore
St., Genoa, IL 60135 Tel.: 815-784-5118

President: D. C. MacLaughlin
Vice President, Marketing Manager: Ron Evers
Products: indoor/outdoor sound columns, packaged sound systems, PA portable sound, lecterns, baffle/speaker combinations, baffles, speaker systems.
See full listing under **Loudspeakers & Accessories**.

ATKINSON DYNAMICS, 10 W. Orange Ave., S. San
Francisco, CA 94080 Tel.: 415-583-9845

Operations Manager: E. M. Watson
Sales Manager: Asa Bullock
Products: heavy-duty intercom units engineered specifically for high noise areas. Clear communications under most difficult conditions guaranteed. Weatherproof, sealed, transistorized.

AUTO PAGE, INC., 1815 W. 205th St., #101, Torrance,
CA 90501 Tel.: 213-328-2911

President: Yoshiniko Nagata
Sales Manager: Ned Morika
Chief Engineer: H. Shima
Products: radio selective tone and voice paging, incorporating 6-channel encoder/transmitter with a 4-watt output to provide sufficient range and penetration; tone/voice one-way.

BES/Bertagni Electroacoustical Systems, 12753
Moore St., Cerritos, CA 90701
Tel.: 213-926-0201

President: Lynn Morrison
Sales Manager: Irv Weisman
Chief Engineer: Alex Bertagni

Products: hemispherically radiating ceiling speakers that closely resemble ceiling tiles. Because of their 180° dispersion pattern, these speakers can replace conventional cone type ceiling speakers by as much as 8 to 1, reducing installation and material cost. High performance omnidirectional outdoor sound reinforcement speakers.
See full listing under **Loudspeakers & Accessories**.

BOGEN, A Lear Siegler Company, Box 500, Paramus,
NJ 07653 Tel.: 201-343-5700

President: John H. Ochtera
Vice President, Marketing: Carl C. Dorwaldt
Vice President, Engineering: Mark Koller
National Sales Manager: Art Arlow
Products: amplifiers, mixer-preamplifiers, power amplifiers, mixers, equalizers; loudspeakers, horns, drivers, columns & baffles; FM/AM tuners & receivers; telephone and zone paging modules; microphones; multiple-tone generator; intercoms; application-engineered systems.
See full listing under **Engineered Sound Systems**.

CALRAD ENGINEERED ELECTRONIC PRODUCTS,
819 No. Highland Ave., Los Angeles, CA 90038
Tel.: 213-465-2131

President: Joseph Shupper
Vice President: Robert Shupper
Sales Manager: Fred Crown
Chief Engineer: Wes Black
Products: microphones, headphones, public address amplifiers, power supplies, speakers, connecting cables, telephone accessories, potentiometers, connectors, switches, meters, control knobs.
See full listing under **Audio Amplifiers**.

CETEC RAYMER, 7315 Fulton Ave., N. Hollywood,
CA 91605 Tel.: 213-875-0423

President: Richard P. Drake
Chief Engineer: Clifford L. Kogge Jr.
Products: background/foreground equipment: wall and shelf mount amplifiers, AM/FM tuners and paging receivers, microphone mixers, installation accessories and transformers, M-O-H and telephone interconnect devices, and test equipment.
See full listing under **Background/Foreground Music Systems**.

COMMUNICATIONS PRODUCTS INC., 13667 Floyd
Circle, Dallas, TX 75243 Tel.: 214-238-9596,
800-527-4596

President: Perry W. Easterling
Marketing Manager: Monty Frierson
Products: accessories for commercial 2-way radios. Remote controls, extended local controls, radiophone patch and termination panels, signaling equipment.
District Offices:
Melby Communications, 10727 Zenith Ave. S., Minneapolis, MN 55431
Secom Systems, 5241-F New Peachtree Rd., Chamblee, GA 30341
Electro-Tek Sales, 14552 E. 12th, Aurora, CA 80011
Johnson Associates, 148 Linden St., Wellesley, MA 02181
Communications Marketing, P.O. Box 270, Monrovia, CA 91016

COMMUNITRON CORP., 912 Enterprise Way, Bdg. A,
Napa, CA 94558 Tel.: 707-226-2003
Calif. WATS: 800-423-8526
Nat'l. WATS: 800-835-2256

President: Paul Bascom
Products: paging telephone systems, telephones, amplifiers and control equipment. "Stor-Com" systems. Modular telephone accessories.

DYNAMIC SOUND INDUSTRIES, P.O. Box 1395
La Belle, FL 33935 Tel.: 813-675-0100,
Chief Engineer: U. L. Lahti

Products: products manufactured under patented pressure velocity formula for symmetrical dispersion. Speaker systems for ceiling, plenum, partition and floor. Custom designs for music paging and sound masking.
See full listing under **Background/Foreground Music**.

EDCOM, INC., 755 Center St., Lewiston, NY 14092-0506
Tel.: 716-754-7130

President: J. D. Breedon
Sales Manager: James K. Wood, Vice President, Marketing
Director of Engineering: Peter Jova
Products: amplifier mainframes, mixers, distribution amplifiers, line surveillance and zone selection equipment, modular plug-in preamplifiers, tone and signal generators, teleconference equipment, multiple cassette systems, simultaneous interpretation systems.
See full listing under **Engineered Sound Systems**.

ELECTRO-VOICE, INC., 600 Cecil St., Buchanan, MI
49107 Tel.: 616-695-6831

President: Robert D. Pabst
Vice President, Marketing and Sales Manager: Paul McGuire
Chief Engineer: Earl Harris
Director of Marketing, Professional Sound Reinforcement Products:
Jim Long
Products: broadcast, recording, communications and PA microphones; public address and component high-fidelity loudspeakers, systems and enclosures; sound reinforcement products.
See full listing under **Microphones**.

ELTREX INTERNATIONAL, 2 Columbia Dr., Amherst,
NH 03031 Tel.: 603-886-3500 Telex: 953016

President: T. H. Sullivan
Sales Manager: Bill Ryan
Products: complete line of radio paging encoders, terminals, test equipment for 2-tone and 5-tone sequential, solid state voice recorders and digital delay units for the broadcast industry.

FAMOUS TELEPHONE SUPPLY CO., P.O. Box 2172,
Akron, OH 44309 Tel.: 216-762-8811
800-321-9122

President: J. Blaushild
General Manager: William Brannon
Products: wire and cable; general hardware; apparatus; paging equipment; power equipment; protection devices; tools; splicing equipment; closures; compounds; couplers and peripheral devices, plenum cable.
Key systems and PABX's.

GAI-TRONICS, P.O. Box 31, Reading, PA 19603
Tel.: 215-777-1374

President: William Moore
Sales Manager: Don Mall
Products: communications systems for use in high noise areas, corrosive atmospheres, extremes of temperature, dust, humidity and hazard areas.

GROMMES PRECISION ELECTRONICS, INC., 9101
King St., Franklin Park, IL 60131
Tel.: 312-678-5350

President: w. S. Grommes
Sales Manager: W. Stow
Chief Engineer: A. A. Hart
Products: integrated audio amplifiers. Amps for mono or stereo power, line, music-on-hold. Mixer preamplifiers, 2 CH. limiters or compressors, graphic equalizers, FM-AM tuners, background music receivers and systems, public address systems, custom engineered sound reinforcement systems, sound columns, trumpets, driver units, baffles, microphones and microphone stands.
See full listing under **Audio Amplifiers**.

HARRIS CORP., DRACON DIV., 809 Calle Plano,
Camarillo, CA 93010 Tel.: 805-987-9511

Vice President, General Manager: John R. Mason
Sales Manager: Tom Erdmann
Chief Engineer: Joe Mader

Products: telephone integrated loudspeaker paging systems; linemen's test sets; craft tools; power supplies; DC-DC converters and extensive line of relay racks.

District Offices:

John Muller, 7787 C Street, Chesapeake Beach, MD 20732

Dave Forcey, 205 Hilltop Circle, Weatherford, TX 76086

Manny Garcia, 3363 Antler Way, Salt Lake City, UT 84121

Gary Foster, P.O. Box 858, Lake Ozark, MO 65049

LT ELECTRONICS, LTD., 2535 Gerrard St. East, Scarborough, Canada M1N 1W9 Tel.: 416-691-9406

President and Sales Manager: Jim Breedon

Chief Engineer: J. Hesse

Products: school intercoms, cone speakers, sound columns, packaged amplifiers, telephone amplifiers, speaker baffles, bass reflex speaker systems.

District Offices:

Trans Canada Electronics Ltd., Scarborough, Canada

Edcon, Inc., Lewiston, NY

McGOHAN ELECTRONICS, INC., 1033 Fairway Dr., Bensonville, IL 60106 Tel.: 312-595-2342

President: James M. McGohan

Products: solid state amplifiers for commercial sound and background music/mic mixers, zone pagers, mic and telephone line transformers and other accessories—off the shelf stock.

See full listing under **Audio Amplifiers**.

McMARTIN INDUSTRIES, INC., 4500 S. 76th St., Omaha, NE 68127 Tel.: 402-331-2000

President: Ray B. McMartin

Vice President, Sales: Jay B. McMartin

Products: transistor engineered and commercial sound amplifiers/mixers/accessories, background music amplifiers and sound systems, SCA and loudspeaker test sets, AM/FM monitors, and transmitters, AM/FM single channel receivers, audio consoles. Satellite communications products.

See full listing under **Audio Amplifiers**.

MG ELECTRONICS, Ranick Rd., Hauppauge, NY 11787 Tel.: 516-582-3400

President: Louis Maltz

Vice President: Elliott Maltz

Sales Manager: Stan Gray

Products: full line of paging horns, 5" through 12" with and without transformers.

MIDWEST ELECTRONIC INDUSTRIES, INC., 4945 W. Belmont, Chicago, IL 60641
Tel.: 312-685-3500

Vice President, General Manager: H. D. Vicinus

Sales Manager: C. L. Madonia

Chief Engineer: L. Chimel

Products: producers of the "Mobilpage" system for indoor or outdoor publicizing, including solid state amplifiers in models up to 100 watts, and matched accessories including horns, microphones, radio and tape reproducing equipment. Specialize for transportation industry.

MILLBANK ELECTRONICS GROUP LTD., Bellbrook Industrial Estate, Uckfield, Sussex, TN22 1QL England Tel.: Uckfield 825-4811

Chairman and Marketing Director: Tony Walker

Director and General Manager: Brian Evans

Director C.T.S.D. Systems: Bernard Skinner

Engineering Manager (Sales): Doug Edworthy

BB-52

Products: custom engineered sound systems; public address, teleconference, life-safety. Sound reinforcement systems: amplifiers, preamplifiers, background music, FM/AM tuners, alarm and tone signal generators, loudspeakers, microphones.

See full listing under **Engineered Sound Systems**.

MUSIC SUPPLY CO., INC., 809 N. Madison, Dallas, TX 75208

Tel.: Texas call collect 214-946-8450

All others 1-800-527-1522

President: W. E. Brown

Products: speaker support trusses (T-bar bridge) to support 8" speakers. Prevent ceiling sag. For 2x4 and 2x2 and 4x4 lay-in type ceiling. Lightweight — 12 oz. — save freight. All steel. U.L. listed.

MUSIC SUPPLY CO., INC., 809 N. Madison, Dallas, TX 75208

Tel.: Texas call collect 214-946-8450

All others 1-800-527-1522

President: W. E. Brown

Products: speaker enclosure (black box-top hat) one piece, drawn construction. All Steel. U.L. listed.

N E C AMERICA INC., 4936 Rosecrans Ave., Hawthorne, CA 90250 Tel.: 213-973-2071

President: K. Muroga

General Manager: S. Wantanabe

Chief Engineer: T. Horikoshi

Products: radio pagers, hand-held 2-way radio, mobile and associated equipment.

District Office:

National Marketing Inc., 113300 Rodney Parham Dr., Little Rock, AK 72212

PASO SOUND PRODUCTS, INC., 14 First St., Pelham, NY 10803 Tel.: 914-738-4800

Vice President, Engineering: Paul Mastrangelo

Operations Manager: Anthony Sgueglia

Sales Manager: David Moore

Products: amplifiers—integrated and booster type—AC/DC for emergency and audio evacuation systems. DC amplifiers for mobile applications. Mixers, microphones, horns, trumpets, driver units, sound columns, baffles with speaker and equipment racks.

See full listing under **Engineered Sound Systems**.

PROTECH AUDIO CORP., Flowerfield, Bldg. #1, St. James, NY 11780 Tel.: 516-584-5855

President: William Murphy

Chief Engineer: Joseph Giambone

Products: amplifiers—power, medium level, distribution, compressor/limiters, preamplifiers modular, automatic level controls, remote level controls, switching modules, line amplifiers, mixing/summing modules, audio transformers, hardware.

REACH ELECTRONICS, INC., 1600 W. 13th St., P.O. Box 308, Lexington, NE 68850
Tel.: 308-324-6661

President: Russel Duvall

Sales Manager: Michael Sutton

Chief Engineer: Gary Gefford

Product: pocket radio pagers and manual and dial access paging terminals. Pagers feature Lifeguard® circuitry for long battery life, with no chargers.

Sound & Communications

RING GROUP OF NORTH AMERICA, 230 Community Dr., Great Neck, NY 11021
Tel.: 516-487-0250; 800-645-9690

President: Ron Stone
Vice President: Peter McLean
Assistant Vice President: Stan Davis
Chief Engineer: Jim Small
Products: "Scanpager," pocket pager with full alpha-numeric message display, tieline, built-in memory, printer connection and out of range indicator.
See full listing under **Intercom Systems—Duplex**.

SANMING ELECTRONIC SOUND EQUIPMENT CO., LTD., 12715 Western Ave., Garden Grove, CA 92641 Tel.: 714-891-2252

President: Hugh C. Hsieh
Sales Manager: Leon C. Hsieh
Chief Engineer: S.W. Hsu
Products: 60 watt and 100 watt siren speakers for emergency vehicle and stations; 10 watt, 15 watt and 30 watt siren speakers for security systems; 15 watt and 30 watt paging horns for voice transmissions.

SIEDLE INTERCOM/USA, 1 Wynnewood Rd., Wynnewood, PA 19096 Tel.: 1-800-874-3353

Sales Director: Earl Zausmer
Products: 2-wire apartment house intercoms for duplex communications between front door and apartment, chime announcement and door release operation from handset. Decentralized microprocessor intercom for all applications plus page with talkback. Modular mailbox systems. Video intercom systems. CCD ultra miniaturized camera for banks and special surveillance.

SIGNACOM CORP., 1032 Edwards Rd., Burlingame, CA 94010 Tel.: 415-348-1188

President: W. Yee
Sales Manager and Chief Engineer: V. Lain
Products: light signaling paging systems, wireless and wired systems. Simple to computer controlled systems with integrated telephone and hands-free voice.

SPANTEL CORP. 301 S. 68th St., Lincoln, NE 68510
Tel.: 402-483-7518

President: Jon Canaday
Sales Manager: Lynette Green
Chief Engineer: Don Naber
Products: pagers — four-year battery life, no re-charging; manual encoders, dial access computer memory paging terminals. SCA pagers tone and voice, digital display. Extreme reliability — minimum maintenance.

SPECO DIV., Components Specialties, Inc., 1172 Rt. 109, P.O. Box 624, Lindenhurst, NY 11757
Tel.: 516-957-8700 (inside NY)
1-800-645-5516 (outside NY)

President: Louis W. Keller
Vice President: Stan Hulkower
Sales Manager: Mel Hulkower
Chief Engineer: James Ganci
Products: PA horns, amplifiers, tuners, loudspeakers, wall baffles, speaker assemblies, outdoor speakers, sound columns, ceiling grilles, transformers, L-pads, attenuators, accessories, microphones, intercoms, alarm sirens, multitestors, oscilloscopes.

TELE-COURIER INC., 1500 Gehman Rd., Harleysville, PA 19438 Tel.: 215-362-5085

Products: radio pocket paging systems, one way voice, digital display, can be activated manually, remotely, telephone, or RS232. Wireless security alarm.
Sales Representative:
Lars Lindeman, 708 Nina Lane, Foster City, CA 94404

TOA ELECTRONICS, INC., 480 Carlton Ct., S. San Francisco, CA 94080 Tel.: 415-588-2538

President: Sam Sakata
Sales Manager, Distributor Products: Joe Green
Sales Manager, Sound and Communications Products: Joe Green/Gail Martin, Sr.
Chief Engineer: Tad Inui
Products: engineered VMS series sound systems, microcomputerized EXES intercom systems, commercial sound systems, amplifiers, dual amplifiers, equalizers, multifunctional preamplifiers, mixing consoles, horns, drivers, speakers, wireless systems.
See full listing under **Engineered Sound Systems**.

UNIVERSITY SOUND (Altec Div.), 10500 W. Reno Ave., Oklahoma City, OK 73126
Tel.: 405-324-5311

President: F. Davis Merrey
National Sales Manager: David Jetzke
Commercial Marketing: Gary Rilling
Products: commercial sound, public address and high fidelity speaker systems, paging/talk-back speakers, sound columns, weatherproof high fidelity speaker systems, high power speakers, microphone stands and accessories.
See full listing under **Loudspeakers**.

VALCOM, INC., 1111 Industry Ave., Roanoke, VA 24013 Tel.: 703-982-3900

President: J. W. Mason
Sales Manager: Donald Buck
Chief Engineer: D. Lynch
Products: telephone integrated paging and intercom systems, talkback, bell-buzzer, code call, PBX adapters, key telephone system ancillaries, loud-ringers, power supplies, amplified and talkback speakers. Single line and feature telephones.
District Offices:
Kristi Olsen, 2174 Cambridge Ave., Cardiff By the Sea, CA 92007
Rich Perrigo, Terminal Sales, Bldg. 919, 1932 1st Ave., Seattle, WA 98101
James F. Somers, 527 E. Main St., Geneva, NY 14456
Charles De Croes, 5422 Bay Center Dr., #221, Tampa, FL 33609
Diana Cohler, 1480 Terrill Mill Rd., Suite 705, Atlanta, GA 30067
Sandra Sheppard, 2002 Chalfont, Carrollton, TX 75007
Bill H. Bailey, 2300 Atlantic St., Hopewell, VA 23860

XTEL, 4301 Will Rogers Parkway, Suite 900, Oklahoma City, OK 73108 Tel.: 405-946-1500

President: J. William Patterson
Vice President: Glen Patterson
Products: telephones and related products such as Voicepac paging/intercom systems, Keyflex 1A2 telephones, stand alone line status monitors, and PBX/Centrex answering positions.

PRO AUDIO SOUND SYSTEMS

(and Portable Sound Systems)

AB SYSTEMS DESIGN, INC., 11480 Sunrise Gold Circle, Rancho Cordova, CA 95670
Tel.: 916-635-0890

President: Robert Bird
Sales Manager: Irwin Laskey
Chief Engineer: Randy Bisher
Products: professional power amplifiers, mixer pre-amplifiers, and dual and mono bi-amplifiers. Commercial accessories provide full sound reinforcement and distributed system capabilities.
See full listing under **Audio Amplifiers**.

ALTEC LANSING CORPORATION, A Gulton Co.,
Box 26105, Oklahoma City, OK 73126-0105
Tel.: 405-324-5311

President: F. Davis Merry
Vice President of Marketing: Gary Rilling
Sales Manager: Gayle Campbell
Products: professional electronic and acoustic sound products of all types.
See full listing under **Audio Amplifiers**.

ART—Applied Research & Technology Inc., 215
Tremont St., Rochester, NY 14608
Tel.: 716-436-2720

President: Philip A. Bette
Sales Manager: Peter Beverage
Chief Engineer: Richard Neatrou
Products: digital signal processors including the DR1 digital reverberation system, other digital reverbs, equalizers and 1500 digital delay. All reverbs are software updateable.
See full listing under **Audio Signal Processors**.

ASHLY AUDIO INC., 100 Fernwood Ave., Rochester,
NY 14621 Tel.: 716-544-5191 800-828-6308

President: Bill Thompson
Sales Manager: Bob French
Chief Engineer: Jon Gaines
Products: Ashly has been producing signal processing equipment since 1972 and started producing power amplifiers 5 years ago. Our line of products include: graphic equalizers, parametric equalizers, limiter compressors, noise gates, electronic crossovers and instrument preamplifiers.

AUDIO-TECHNICA U.S., INC., 1221 Commerce Dr.,
Stow, OH 44224 Tel.: 216-923-0376

President: Jon R. Kelly
Sales Manager: Charlie Winkler
Chief Engineer: Bob Herrold
Products: microphones and microphone accessories, recorder/mixers, cables, direct boxes, headphones.
See full listing under **Microphones**.

BES/Bertagni Electroacoustical Systems, 12753
Moore St., Cerritos, CA 90701
Tel.: 213-926-0201

President: Lynn Morrison
Sales Manager: Irv Weisman
Chief Engineer: Alex Bertagni
Products: hemispherically radiating ceiling speakers that closely resemble ceiling tiles with 180° dispersion pattern. High performance omnidirectional outdoor sound reinforcement speakers.
See full listing under **Loudspeakers & Accessories**.

BOSE CORPORATION, The Mountain, Framingham,
MA 01701 Tel.: 617-879-7330

President: Dr. Amar G. Bose
Chief Engineer: John Carter
Sales Manager: John Stiernberg
Products: professional loudspeakers for installed and portable applications, include the full range 802 Series II, 302 bass system, 402 line source system, CLS-2 commercial loudspeaker system and 102 foreground music system.
See full listing under **Loudspeakers & Accessories**.

CERWIN-VEGA!, 12250 Montague St., Arleta, CA 91331
Tel.: 818-896-0777

Sales Manager: Rich Mandella
Chief Engineer: Dr. Marshall Buck
Products: consumer audio, musical instrument products, sound reinforcement, theater sound & electronics, primarily speaker and cabinet systems.

CETEC GAUSS, 9130 Glenoaks Blvd., Sun Valley, CA
91352 Tel.: 213-875-1900

President: W. Mort Fujii
Sales Manager: J. Fleischmann, P. Horsman
Chief Engineer: J. Williams
Products: musical component loudspeakers, precision components for sound reinforcement, custom systems, high-speed tape duplicating equipment.

COMMUNITY LIGHT & SOUND, INC., 333 E. 5th St.,
Chester, PA 19013 Tel.: 215-876-3400

President and Chief Engineer: Bruce Howze
Sales Manager: Thomas C. Walter
Products: high efficiency loudspeakers, radial, straight and pattern control horns, and full range enclosures for high level sound reinforcement and monitoring. Voice warning systems. OEM products.
Sales Representatives:
George Markunas Industries, 65 Maguire Ave., Avon, MA 02322
Metrorep Sales, 57 South Street, Freehold, NJ 07728
Audio Marketing Assoc., 9470 Whitewood Pl., Brecksville, OH 44141
Key Marketing, 41940 Joy Road, Plymouth, MI 48170
Pro Marketing Co., 9628 Day Dr., Indianapolis, IN 46280
Applied Audio Marketing, 26 Audubon Dr., Asheville, NC 28804
Bencsik Associates, 3730 42nd Lane, Ocala, FL 32670
Mel Foster Tech Sales, 7611 Washington Ave. S., Edina, MN 55435
R. J. Throckmorton Sales, 124 Manchester Rd., Ballwin, MO 63011
Gemini Electronics, 115 4th Avenue, Suite B, Edmonds, WA 98020
Tom Aye, 385 Chateau LaSalle Drive, San Jose, CA 95111
Sunwest Marketing, 818 E. Riverview, Orange, CA 92665

DOD ELECTRONICS CORP., 5639 South Riley Lane,
Salt Lake City, UT 84107 Tel.: 801-268-8400

President: David D. Francesco
Sales Manager: John Johnson
Chief Engineer: David D. Francesco
Products: sound reinforcement equalizers; 5 models of graphic equalizers including the 430 stereo signal space graphic equalizer and stereo 15 band single space graphic equalizer with 12 DB of cut and boost featuring low cut switch and available with XLR connectors
District Offices:
Wayne Morris, Ken Sindy Dr., Nashua, NH 03062
New England Reps.—Hanovd and Associates, 617-252-3735
New York Rep.—Gary Castelluccio, 201-278-2500

EDCOR, 16782 Hale Ave., Irvine, CA 92714
Tel.: 714-863-1529

President: Larry Weston
Chief Engineer: Harold Keeling
Products: a complete line of pro sound contractor equipment including amplifiers, mixers, automatic mic mixers, wireless microphones systems.

EDEN ELECTRONICS INC., Box 338, First St., Mon-
trose, MN 55363 Tel.: 612-675-3650

President: David D. Nordschow
Products: high quality commercial sound systems, mobile PA systems, stage monitors, constant directivity horns, crossovers, cabinets, fiberglass horns for O.E.M. application, horn-loaded bass systems.
See full listing under **Engineered Sound Systems**.

ELECTRO-VOICE, INC., 600 Cecil St., Buchanan, MI
49107 Tel.: 616-695-6831

President: Robert D. Pabst
Vice President, Sales and Marketing: Paul McGuire
Chief Engineer: Earl Harris
Director of Marketing, Professional Sound Reinforcement Products:
James Long
Products: broadcast, recording, communications and PA microphones; public address and component high-fidelity loudspeakers, system and enclosures, sound reinforcement products.

ENVIRONMENTAL SOUND, 31220 La Baya Dr., Bld.
110, Westlake Village, CA 91362
Tel.: 818-706-0228 TX: 299353 POST UR

President and Chief Engineer: Pascal Delbuck

Sales Manager: Jean Pierre

Products: drop ceiling monitors that fit directly into a standard T-bar or Grid ceiling. Pro Drop I 8-inch 2 way, Pro Drop II dual 10-inch 2 way, ES-801 8 inch full range, ES-602 6 inch two-way. ES-801 and ES-602 are flush mount (12x12).

FSR, INC., 40 Commercial Rd., Cedar Grove, NJ 07009
Tel.: 201-783-3966

Sales Manager: Janice Sandri

Products: conference room control systems; teleconferencing systems; remote control modules for: audio attenuation; ramp generators; microphone switching; slide and 16mm projectors; video switchers; floor boxes.

GALAXY AUDIO, 625 East Pawnee, Wichita, KS 67211
Tel.: 316-263-2852

President: Brock M. Jabara

Sales Manager: R. D. Moneyhun

Chief Engineer: Brock M. Jabara

Products: "Hot Spot" personal monitors, including a powered model; "Pro Spot" speakers for installed or portable P.A. and monitors; eight, twelve, and sixteen channel mixing consoles.

GOLD LINE, P.O. Box 115, W. Redding, CT 06896
Tel.: 203-938-2588

President: Martin E. Miller

Products: audio spectrum analyzers both 10-band hand-held and 30-band rack mountable, digital $\frac{1}{2}$ octave RTA. Pink plus white noise generators.

District Offices:

William B. Ray Assocs., 125 Simpson St., N.W., Atlanta, GA 30313

New Horizons, 2211-B Lakeside Dr., Bannockburn, IL 60015

Richard Lewis Sales, 222 S. Easton Rd., Glenside, PA 19038

John B. Anthony, 992 Highridge Rd., Stamford, CT 06905

HEIL LTD., #2 Heil Drive, Marissa, IL 62257
Tel.: 618-295-3000

President: Bob Heil

Chief Engineer: John Rutter

Products: mixing consoles, power amplifiers, parametric EQ, crossovers, satellite TV antennas, amateur radio and communication microphones.

IMC/INTERNATIONAL MUSIC COMPANY, 1316 E.
Lancaster, Ft. Worth, TX 76179
Tel.: 817-336-5114

President: Jerry Freed

Sales Manager: Claude Boyd

Chief Engineer: Jim Cowser

Products: Akai—multitrack recorder, synthesizers. Studiomaster—recording and live mixing consoles. Ross—multitrack recorders, PA systems, guitar amps and effects. Fane—professional loudspeakers and compressor drivers.

KLARK-TEKNIK ELECTRONICS INC., 262 A Eastern
Parkway, Farmingdale, NY 11735
Tel.: 516-249-3660

President: Jack Kelly

Sales Manager: Keith Worsley

Chief Engineer: Jim Jacobelli

Products: digital reverberation systems, digital delay lines, $\frac{1}{4}$ octave and $\frac{1}{2}$ octave graphic equalizers, $\frac{1}{4}$ octave R.T.A. with R.T. 60 measurement capabilities, Brooke Siren Systems crossovers, compressor limiters.

District Offices:

Clark-Teknik West, 415-482-1800

Derek Allen, P.O. Box 2229, Toluca Lake, CA 91602

Professional Audio Marketing, P.O. Box 765, Melville, NY 11747

Audio Resources, 778 Burr Oak Drive, Westmont, IL 60559

LECTROSONICS, INC., 2100 Atrisco Dr., N.W., P.O.
Box 12617, Albuquerque, NM 87195
Tel.: 505-831-1010

President: John Arasim, Jr.

Sales Manager: Bruce C. Jones/J. D. Madden

Chief Engineer: Larry Fisher

Products: ultra portable rechargeable PA systems; over shoulder, lecterns, one-piece wireless sound systems, wireless microphone systems for all applications — miniature professional UHF wireless receiver.

District Offices:

Mid-Atlantic Representatives, 5800 Andrews Rd., Suite 201, Mentor, OH 44060

Magnetic Communications Systems, 2600 Gross Point Rd., Evanston, IL 60201

Zeeco Sales & Marketing, 729 Bedford Euless Rd., Suite 106, Hurst, TX 76053

PMP Marketing, Inc., 1901 Prospector Avenue, Park City, UT 84060

MODULAR AUDIO PRODUCTS, 50 Orville Dr.,
Bohemia, NY 11716 Tel.: 516-567-9620

President: Steve Summer

Sales Manager: Chris Lipton

Chief Engineer: Gary Pendola

Products: mic preamps, line amps, solid state switchers, distribution amps, equalizers, compressors, op-amps, power supplies, monitor amplifiers, oscillators, noise generators, VU meter boards, VCAs.

MODULAR SOUND SYSTEMS, INC., P.O. Box 488,
Barrington, IL 60010 Tel.: 312-382-4550

President: Jim Wiselmeyer

Sales Manager: Will Warnock

Chief Engineer: Henry Heine

Products: BAG END loudspeaker systems, custom cabinetry, and rack mount enclosures.

THE MUSIC PEOPLE, INC., P.O. Box 648, West Hart-
ford, CT 06107 Tel.: 800-243-2888

President: Thomas J. Fay

Sales Manager: Earl Goodwin

Chief Engineer: J. R. Hennessey

Products: pro audio accessories, speakers, horn and drivers, microphones, Hot Wires cable, in line effects pedals, in line audio direct boxes and splitters.

NAKAMICHI U.S.A. CORPORATION, 19701 South
Vermont Avenue, Torrance, CA 90502
Tel.: 213-538-8150

President: Yas Yamazaki

Sales Manager: Jett Logan

Chief Engineer: Stephen Mascenik

Products: MR-1 discrete head, rack mount, balanced/unbalanced professional cassette deck.

NUMARK ELECTRONICS, 503 Raritan Center, Edison,
NJ 08837 Tel.: 201-225-3222

President: Harry Kotovsky

Sales Manager: Paul Friedman

Products: power amplifiers, mixers, equalizers, noise reduction, expansion systems, video sound processors.

District Office:

750 Alabama Ave., Canoga Park, CA 91304

O'BRIEN PARTITION CO., INC., 5301 E. 59th Street,
Kansas City, MO 64130 Tel.: 816-361-2334

Vice President/General Manager: Stephen R. Nichols
Sales Manager: Tim Hoiting
Chief Engineer: Bob McGuire
Products: Sound Sorbic® acoustical wall panels. Available fabric covered, Class A fire rated, in a number of shapes, sizes, and acoustical ratings.

OMNIMOUNT SYSTEMS, 10850 Van Owen St., N.
Hollywood, CA 91605 Tel.: 818-766-9000

President and Chief Engineer: Alexander Cyrell
Sales Manager: Susan Michelson
Products: industrial quality mounts. Unique ebonite ball joint design, adjustability, security features, invisible wiring capability. #100WA maximum recommended load 70 lbs. New models available to 300 lbs. or more.

OTARI CORPORATION, 2 Davis Dr., Belmont, CA
94002 Tel.: 415-592-8311

President: Jack Soma
Sales Manager: John Carey
Chief Engineer: Phil Son
Products: open reel, multi-channel professional tape recorder/reproducers, cassette duplicators and synchronizers.

**PANASONIC INDUSTRIAL CO., Audio-Video
Systems Division**, One Panasonic Way, Secaucus,
NJ 07094 Tel.: 201-348-7000

President: Ken Kurahashi
General Manager: Steve Yuhas
Sales Manager: Milton Landau
Products: Ramsa® professional power amplifiers, mixing consoles, portable and stationary audio recording mixers and post production and recording consoles. Combination mixers for sound reinforcement and recording, compact high power speakers, integrated amplifiers, including mixer power amplifiers and mixer power amplifiers with AM/FM tuner and full line of accessories.
See full listing under **CCTV Systems & Products**.

PANASONIC / RAMSA, One Panasonic Way, Secaucus,
NJ 07094 Tel.: 201-348-7464

Manager: Gene Juall
Product Specialist: Joseph Crocco
Products: pro line of sound reinforcement, recording, post-production mixing console. Compact high-powered speakers, power amplifiers, portable wireless microphone systems.

PEAVEY ELECTRONICS CORP., 711 A Street,
Meridian, MI 39301 Tel.: 601-483-5365

President: Hartley Peavey
Sales Manager: Melia Peavey
Chief Engineer: Jack Sondermeyer
Products: PA systems, mixing consoles, rack mount mixers, power amps, equalizers, digital checks processors, monitor system, sound reinforcement, rawhorn speaker and other components.

PROTECH AUDIO CORP., Flowerfield, Bldg. #1, St.
James, NY 11780 Tel.: 516-584-5855

President: William Murphy
Chief Engineer: Joseph Giambone
Products: amplifiers—power, medium level, distribution, compressor/limiters, preamplifiers modular, automatic level controls, remote level controls, switching modules, line amplifiers, mixing/summing modules, audio transformers, hardware.

RAMKO RESEARCH, INC., 11355 "A" Folsom
Blvd., Rancho Cordova, CA 95670
Tel.: 916-635-3600 1-800-821-2545

President: Ray Kohfeld
Sales Manager: Jim Lucy
Products: audio consoles, audio DAs, mic/line amps, TT preamps, monitor amps, audio router/amps, turntables, R/R recorders, cassette and cart decks and portable mixers.

RANE CORP., 6510 216th SW, Mountainlake Terr., WA
98043 Tel.: 206-774-7309

President: Steve Brakken
Sales Manager: Larry Winter
Chief Engineer: Dennis Bohn
Products: constant Q equalizers, realtime analyzers, 6-channel amplifiers (900w), distribution amps, 70 volt systems, headphone amplifiers, crossovers.

RAYTRONICS, 4901 Morena Blvd., San Diego, CA
92117 Tel.: 619-270-4000, 800-854-1085

President: Dennis Berglund
Vice President, Manufacturing: Don Foley
Sales Manager and Marketing Director: Keith Goldstein
Products: solid state intercom for drive-thru in high noise level applications; vehicle sensing equipment with repeat chime; high quality amplifiers, horns; speech processing equipment; drive-thru visual ordering systems.

ROSS, 1316 East Lancaster St., Forth Worth, TX 76179
Tel.: 817-336-5114

President: Jerry Freed
Sales Manager: C. F. Boyd
Chief Engineer: Jim Cowser
Products: Ross PA systems EQ's, speaker enclosures, power amplifiers and Studiomaster professional mixers and power amplifiers.

S. C. V. INC., 414 Norm Sparks St., Burbank CA 91506
Tel.: 818-843-7567

President: Ron Fuller
Sales Manager: Hendri Smith
Products: line of signal processing equipment.

SONY CORP.—PRO AUDIO PRODUCTS, Sony Dr.,
Park Ridge, NJ 07656 Tel.: 201-930-1000

National Sales Manager: Phil DeSantis
Product Manager: Michael Feniello
Products: Sony conference system, professional microphones, wireless microphones, mixers, tape recorders, and digital audio equipment.
District Offices:
Scott Spector, Sony Corp. of America, 700 W. Artesia Blvd., Compton, CA 90220
Graeme Goodall, Sony Corp., 2608 Elm Hill Pike, #N, Nashville, TN 37214
Mike Faulkner, Sony Corp., 15 Essex Rd., Paramus, NJ 07652
Gareth Nelson, Sony Corp., 500 Park Blvd., Hamilton Lakes, Itasca, IL 60143

SOUNDCRAFT ELECTRONICS, INC., 1517 20th St.,
Santa Monica, CA 90404 Tel.: 213-453-4591

General Manager: Betty Bennett
Vice President, Sales Manager: Wayne Freeman
Products: audio mixing consoles and multi-track tape machines. Applications include live recording, sound reinforcement, studio recording, remote recording, broadcast and post production. Full range of power amplifiers.
District Offices:
Soundcraft Electronics NY, 1841 Broadway, #511, New York, NY 10023
Soundcraft Electronics Canada, 1444 Hymus Blvd., Dorval, Quebec, Canada H9P 1J6
Soundcraft Electronics, Ltd., 5-8 Great Sutton St., London, EC1V 0BX England
Soundcraft Japan, Ltd., 4F Yoyogi-Living 12-21 Sendagaya 5, Shibuya-ku Tokyo 151 Japan

STUDER REVOX AMERICA, INC., 1425 Elm Hill Pike,
Nashville, TN 37210 Tel.: 615-254-5651

President: Bruno Hochstrasser

Sales Manager: Lawrence Jaffe

Chief Engineer: G.T. Sanford III

Products: full range of professional audio equipment, including open reel and cassette recorders, amplifiers, mixers, CD players, and language labs.

TASCAM, Teac Professional Division, 7733 Telegraph
Road, Montebello, CA 90640 Tel.: 213-726-0303

President: Noria Tamura

National Sales Manager: William Mohrhoff

Director of Product Planning: Dave Oren

Product/Service Manager: Jon Bliese

Advertising Manager: Anders Madsen

Products: The world's broadest line of tape recorders and professional mixing consoles, used in sound reinforcement, post production and professional audio recording applications.

District Offices:

Marketraton, 4 Crestmill Ct., Phoenix, MD 21131

Western Hi Tech/Solomon, 14737 Lull St., Van Nuys, CA 91405

Dobbs Stanford, 2715 Electronic La., Dallas, TX 75220

Steffey Marketing, 1995 Raymond Dr., Suite 103, Northbrook, IL 60662

JND, Post Office Box 606, Fairfax, CA 94930

TELEX COMMUNICATIONS, INC., 9600 Aldrich
Ave. S., Minneapolis, MN 55420
Tel.: 612-887-5550, 612-884-4051

President: John Howe

Director Marketing, Professional Audio and Broadcast Products:
Donald Merein

Products: open reel and cartridge tape recorders/reproducers, tape transports, record and reproduce electronics, background music systems.

Director of Marketing, Audio/Visual Products: Dan Paulnock

Sales Manager: Jerry Hines

Products: cassette recorders, players, trainers, slide sync recorders, portable and fixed teaching labs, high speed reel and cassette tape duplicating systems and cassette copiers.

District Offices:

Wes Alderson, Jr., Wes-Tech Marketing, P.O. Box 206, Culver City,
CA 90230-0206

Bill Bencsik, Bencsik Assocs., 3730 N.E. 42nd Lane, Ocala, FL 32670

Tony Monfort, Monfort Electronic Marketing, 5158 E. 65th St.,
Indianapolis, IN 46220

Pier Vidoni, Mountain Representatives, Inc., 1301 W. 3rd Ave.,
Denver, CO 80223

Jack Cota, Murphy & Cota, Inc., 500 Plasamour Dr., N.E., Atlanta,
GA 30324

Erv Wolter, Northland Assocs., P.O. Box 429, 1012-19 Ave. S.,
Moorhead, MN 56560

Paul Pusecker, Pusecker Sales, 372 Upper Mountain Ave., Upper
Montclair, NJ 07043

Chuck Rancilio, Rancilio Assocs., Inc., 84 Grasso Plaza, P.O. Box
28869, St. Louis, MO 63123

SAGA, 59 W. Mohawk St., Oswego, NY 13126

Signal Marketing, Inc., 237 Lancaster Ave., #245, Devon, PA 19333

Jess Spoons, J.Y. Schoonmaker Co., P.O. Box 38150, 10710 Sand
Hill Rd., Dallas, TX 75238

Ralph Wright, Weller Electronic Sales, 5274 Sinclair Rd., Columbus,
OH 43229

Burt Ziskind, Ziskind Assocs., 5420 Newport Dr., #52, Rolling
Meadows, IL 60008

Trans-Canada Electronics, 2535 Gerrard St., E., Scarborough, OT M1N
1W9 Canada

Lynn Toussaint, Burcaw Company & Associates, 30642 Dequindre
Road, Warren, MI 48092

Earl Fleehart, Fleehart & Sullivan, Inc., 10109 Aurora Avenue North,
Seattle, WA 98133

Steve Lichtenauer, Lichtenauer & Associates, 155 Riverway Drive,
Pittsburg, CA 94565

TOA ELECTRONICS, INC., 480 Carlton Ct., S. San
Francisco, CA 94080 Tel.: 415-588-2538

President: Sam Sakata

Sales Manager, Distributor Products: Joe Green

Sales Manager, Pro Audio: Terry Taylor

Sales Manager, Sound and Communications: Carl Dorwaldt

Chief Engineer: Tad Inui

Products: micro-computerized intercom systems EXES-5000,
EXES-1000, EX-16. Full electronics exchange, all types stations-hands-
free handset, auto-dialer, talk-back unit.

See full listing under **Engineered Sound Systems**.

UREI, 8500 Balboa Blvd., Northridge, CA 91329
Tel.: 818-893-8411

President: Ron Means

Vice President, Sales: Ken Lopez

Director of Marketing: Mark Gander

Products: power amplifiers, limiters, compressors, equalizers, filters,
Time-Aligned™ speakers, direct boxes, electronic crossover, digital delay
line, digital metronome, transcription preamplifier, disco mixers, broad-
cast consoles.

See full listing under **Audio Signal Processors**.

VALLEY PEOPLE, INC., P.O. Box 40306, 2817 Erica
Place, Nashville, TN 37204 Tel.: 615-383-4737

President: Norman Baker

Sales Manager: Ray Updike

Chief Engineer: Mike Morgan

Products: peak, averaging, RMS limiters, compressors, voice-over
devices, expanders, keyable noise gates, de-essers, equalizers,
transformerless mic preamps, line amplifiers/attenuators, voltage con-
trolled amplifiers, gain cells, transistor arrays.

District Offices:

Allied Broadcast Equipment, 635 South E. Street, Richmond, IN
47374-8487

Martin Audio, 423 W. 55th St., 6th Floor, New York, NY 10019

Valley Audio, 2821 Erica Place, Nashville, TN 37204

J-Mar Electronics, Ltd., 6 Banigan Drive, Toronto, Ontario, M4H 1E9
Canada

Westlake Audio, 2765 Santa Monica Blvd., Los Angeles, Ca 90046

VERREX CORPORATION, 1130 Route 22 West, Moun-
tainside, NJ 07092 Tel.: 201-232-7000

President: Thomas G. Berry

Sales Manager: Richard Krochmal

Chief Engineer: David G. Butz

Products: supplier of engineered pro-audio sound systems worldwide
since 1946. Sales, engineering, fabrication, installation and service
departments.

BOB WHITE ASSOCIATES, P.O. Box 39104, Solon,
OH 44139 Tel.: 216-248-1317

President: Bob White

Sales Manager: Tod White

Chief Engineer: George White

Products: professional sound products, audio.

District Offices:

Tod White, #15 Point Dr., Brooklyn, MI

Jay Pill, 6730 Caroline Ave., Indianapolis, IN

**YAMAHA INTERNATIONAL CORP., Professional
Products Division**, 6600 Orangethorpe, Buena
Park, CA 90620 Tel.: 714-522-9011

Sales Manager: Bob Shomaker

Products: full line of audio mixing consoles, power amplifiers, speaker
systems, and analog and digital signal processing equipment.

SCHOOL COMMUNICATION SYSTEMS

AIPHONE INTERCOM SYSTEMS, 1700 13th N.E.,
Bellevue, WA 98005 Tel.: 206-455-0510

President: Hiko Shinoda
Sales Manager: Jim Morrison
Chief Engineer: Jun Matsumoto
Products: industrial, business, residential, loudspeaking, telephone, video intercom/security systems with paging talk-back; six microprocessor systems available; mixer amplifiers, paging speakers, horns, drivers, ceiling speakers.

BOGEN, A Lear Siegler Company, Box 500, Paramus,
NJ 07653 Tel.: 201-343-5700

President: John Ochtera
Vice President, Marketing: Carl C. Dorwaldt
Vice President, Engineering: Mark Koller
National Sales Manager: Art Arlow
Products: Communitel™, microprocessor-based administrative communication systems; Multi-Graphic™, school communications control centers; master program clock. Gymnasium and auditorium sound reinforcement, satellite systems, accessories.
See full listing under **Engineered Sound Systems**.

COMMUNICATIONS CO., INC., 3490 Noell St., San
Diego, CA 92110 Tel.: 714-297-3261

President and Sales Manager: Peter T. Jordan
Chief Engineer: David Johnson
Products: programmable two-way intercom amplifier w/vox., media distribution amplifier, projector patch, room combining systems, record patch, RT-60 reverberation measuring device, burst octave noise generator, 1/3 octave real time analyzer, 27 B.I.T. oscilloscope display adaptor.
See full listing under **Intercom Systems — Institutional**.

COMMUNICATIONS EQUIPMENT CO., INC., 6443
Western Ave., Glen Arbor, MI 49636
Tel.: 616-334-3081

President: Hugh I. Morris
Sales Manager: Thomas A. Garmhausen
Products: complete school central sound consoles for program, intercom, and signal distribution. Configurations include full desk, desktop, upright and flush wall consoles.
See full listing under **Engineered Sound Systems**.

CORNELL ELECTRONIC PRODUCTS, INC., 4911
W. Good Hope Rd., Milwaukee, WI 53223
Tel.: 414-351-4660

President, Management and Engineering: Donald Glaubitz
Vice President and Chief Engineer: Gary Butler
Sales Manager: Pauline Haack
Products: audio-visual nurse-call systems, door security systems and apartment intercom systems. In-and-out registers. Permanent, printed record of the time and response of an event. Intercom systems/institutional.
See full listing under **Nurse-Patient Intercom Systems**.

J. W. DAVIS & CO., 3215 Canton St., Dallas, TX
75226 Tel.: 214-651-7341
Texas WATS: 800-442-1564
National WATS: 800-527-5705

President: M. H. Earp
Sales Manager: W. A. Wadkins
Chief Engineer: J. E. Mitchell
Products: console, consolette or desk top mounting with telephone handsets for privacy if desired. Room call in available and privacy features to prevent monitoring without notification. Any number of rooms may be accommodated.

DELTA COMMUNICATIONS CO., 7852 78th Ave.
S.W., Tacoma, WA 98498 Tel.: 206-582-2201

President: Sid C. Flothe
Sales Manager: Sid C. Flothe
Products: school and institutional intercommunication systems. Features include: room handsets, two channels of telecommunications, voice intercom, programming from radio/cassette, compact size, time tone signals, etc.

EDCOM, INC., 755 Center St., Lewiston, NY 14092-0506
Tel.: 716-754-7130

President: J. D. Breedon
Sales Manager: James K. Wood, V. P., Marketing
Director of Engineering: Peter Jova
Products: complete line of school intercom systems and accessories, manual and microprocessor controlled, 1,500 room and 32 master capability. Built-in time programs, multiple priority, multiple tones, multiple zones.
See full listing under **Engineered Sound Systems**.

MILLBANK ELECTRONICS GROUP LTD., Bell-
brook Industrial Estate, Uckfield, Sussex, TN22
1QL England Tel.: Uckfield 825-4811

Chairman & Marketing Director: Tony Walker
Director and General Manager: Brian Evans
Director C.T.S.D. Systems: Bernard Skinner
Engineering Manager (Sales): Doug Edworthy
Products: custom engineered sound systems; public address, teleconference, life-safety. Sound reinforcement systems: amplifiers, pre-amplifiers, background music, FM/AM tuners, alarm and tone-signal generators, loudspeakers, microphones.
See full listing under **Engineered Sound Systems**.

PASO SOUND PRODUCTS, INC., 14 First St., Pel-
ham, NY 10803 Tel.: 914-738-4800

Vice President, Engineering: Paul Mastrangelo
Operations Manager: Anthony Sgueglia
Sales Manager: David Moore
Products: telephone and open voice systems with paging and talkback, program distribution and selective zone paging. Sound systems for gymnasiums, auditoriums, general purpose rooms and cafeterias.
See full listing under **Engineered Sound Systems**.

RAULAND-BORG CORP., 3535 W. Addison St., Chi-
cago, IL 60618 Tel.: 312-267-1300
TWX: 910 221 1290

President: William Krucks
Vice President, Sales and Marketing: Kenneth T. James
Chief Engineer: Lawrence Gleason
Products: administrative telephone systems (Telecenter™); school communications system (Director™ series); sound reinforcement systems for auditoriums and gymnasiums; microprocessor-based user program-mable master clock systems.
See full listing under **Engineered Sound Systems**.

RAYTRONICS, 4901 Morena Blvd., San Diego, CA
92117 Tel.: 619-270-4000, 800-854-1085

President: Dennis Berglund
Vice President, Manufacturing: Don Foley
Sales Manager and Marketing Manager: Keith Goldstein
Products: solid state intercom for drive-thru in high noise level applica-tions; vehicle sensing equipment with repeat chime; high quality amplifiers, horns; speech processing equipment; drive-thru visual order-ing systems.

RING GROUP OF NORTH AMERICA, 230 Community Drive, Great Neck, NY 11021
Tel.: 516-487-0250; 800-645-9690

President: Ron Stone
Vice President: Peter McLean
Assistant Vice President: Stan Davis
Chief Engineer: Jim Small
Products: Ring 3000 School System, two-channel system capable of serving in excess of 200 classrooms. Provides all-call/selective announcements, time, music, emergency communications. Retrofits existing consoles.
See full listing under **Intercom Systems—Duplex**.

SEIDLE INTERCOM/USA, 1 Wynnewood Rd., Wynnewood, PA 19096 Tel.: 1-800-874-3353

Sales Director: Earl Zausmer
Products: 2-wire apartment house intercoms for duplex communications between front door and apartment, chime announcement and door release operation from handset. Decentralized microprocessor intercom for all applications plus page with talkback. Modular mailbox systems. Video intercom systems. CCD ultra miniaturized camera for banks and special surveillance.

SPECO DIV., COMPONENTS SPECIALTIES, INC., 1172 Rt. 109, P.O. Box 624, Lindenhurst, NY 11757 Tel.: 516-957-8700 (inside NY)
1-800-645-5516 (outside NY)

President: Louis W. Keller
Vice President: Stan Hulkower
General Manager: James Ganci
Director Sales and Marketing: Mel Hulkower
Products: PA horns, amplifiers, tuners, loudspeakers, wall baffles, speaker assemblies, outdoor speakers, sound columns, ceiling grilles, transformers, L-pads, attenuators, accessories, microphones, intercoms, alarm sirens, multitestors, oscilloscopes.

STROM ELECTRONICS, P.O. Box 56, 617 Grant Rd., Folcroft, PA 19032 Tel.: 215-586-3000

President: Herbert Seidel
Chief Engineer: Warren Gregory
Products: commercial, industrial and institutional communication systems and equipment.

TALK-A-PHONE CO., 5013 N. Kedzie Ave., Chicago, IL 60625 Tel.: 312-539-1100

President: Z. Liberman
Sales Manager: Dan F. Kagan
Products: intercom systems—manual and hands-free equipment—for industrial, institutional, commercial, home, apartment house, self-service gas station, and fast food drive-thru use; wireless and cable connected models.



TSI, 393 Jericho Turnpike, Mineola, NY 11501
Tel.: 516-294-5390

Director of Marketing: Glenn C. Kern
Products: custom AV system design, assembly, installation and service or conference, board and training rooms. Teleconferencing systems. Video projection. Remote control of VCR, film, slides, microphones, room lighting, draperies, environment. Computer interfacing.

August, 1985

SOUND MASKING

ALTEC LANSING CORPORATION, A Gulton Co., Box 26105, Oklahoma City, OK 73126-0105
Tel.: 405-324-5311

President: F. Davis Merrey
Vice President of Marketing: Gary Rilling
Sales Manager: Gayle Campbell
Products: professional electronic and acoustic sound products of all types.
See full listing under **Audio Amplifiers**.

AUTOMATION DEVICES, INC., Automation Park, Box AD, Fairview, PA 16415-0904
Tel.: 814-474-5561

President: W. E. Walker
Chief Engineer: Don Miller
Products: noise-masking equipment.

BES/Bertagni Electroacoustical Systems, 12753 Moore St., Cerritos, CA 90701
Tel.: 213-926-0201

President: Lynn Morrison
Sales Manager: Ian Weisman
Chief Engineer: Alex Bertagni
Products: hemispherically radiating ceiling speakers that closely resemble ceiling tiles with 180° dispersion pattern. High performance omnidirectional outdoor sound reinforcement speakers.
See full listing under **Loudspeakers & Accessories**.

CONTROL ELECTRONICS, 107 Allen Blvd., Farmingdale, NY 11735 Tel.: 516-694-0125

President: Jack Leonard
Products: noise-masking equipment.

J.W. DAVIS & CO., 3215 Canton St., Dallas, TX 75226
Tel.: 214-651-7341 Texas WATS: 800-442-1564
National WATS: 800-527-5705

President: M. H. Earp
Sales Manager: W. A. Wadkins
Chief Engineer: J. E. Mitchell
Products: loudspeakers, baffles, noise generators and equalizers for a total sound masking installation. Power amplifiers, mixers and exclusive SBA systems are also available.

DYNAMIC SOUND INDUSTRIES, P.O. Box 1395, LaBelle, FL 33935 Tel.: 813-675-0100

Chief Engineer: U. L. Lahti
Products: products manufactured under patented pressure velocity formula for symmetrical dispersion. Speaker systems for ceiling, plenum, partition and floor. Custom designs for music paging and sound masking.
See full listing under **Background/Foreground Music**.

DYNA-SYSTEMS INC., 5371 Tennyson St., Denver, CO 80212 Tel.: 303-455-5400

President: Dr. Robert C. Chanaud
Vice President, Marketing: Doug Miller
Chief Engineer: A. Afyoni
Products: masking generators, small masking systems, self-contained maskers, master/slave masking units, mixer/equalizers, time-varying mixers, plenum loudspeaker assemblies and zone amplifiers.

INSUL-ART ACOUSTICS CORP., 107 Allen Blvd., Farmingdale, NY 11735 Tel.: 516-694-0002
800-526-0908

President: Jack D. Leonard
Vice President Sales: Alfred D. Siliati
Chief Engineer: Harold Goldstein
Products: self-contained sound masking systems. Centralized sound masking systems. Paging systems. Sound and acoustical specialists.

LYNTEC/TECHNICAL VISUALS, 7030 Grandview,
Merriam, KS 66204 Tel.: 913-722-4047

President: Lynn J. Potter
Products: LynTec Programmable Audio Controller. Fully field programmable time of day/level control of up to 7 channels of any audio program material. Weekend control. Battery backup.

PRECISION INC., 3415 48th Ave., Minneapolis, MN
55429 Tel.: 612-537-9340

President: D. R. Head
Sales Manager: David Anderson
Products: noise-masking equipment.

PROTECH AUDIO CORP., Flowerfield Bldg. #1,
St. James, NY 11780 Tel.: 516-584-5855

President: William Murphy
Chief Engineer: Joseph Giambone
Products: amplifiers—power, medium level, distribution, compressor/limiters, preamplifiers modular, automatic level controls, remote level controls, switching modules, line amplifiers, mixing/summing modules, audio transformers, hardware.

SONOMASK SYSTEMS INC., 1130 Route 22 West,
Mountainside, NJ 07092 Tel.: 201-232-7000

President: Thomas G. Berry
Sales Manager: Glenn R. Berry
Chief Engineer: David G. Butz
Products: supplier of engineered sound masking systems and products since 1971. Systems and products sold to contractors and end users. Manufacturer of complete line of generators, attenuators and speakers.

SOUNDOLIER, 9380 Watson Industrial Park, St. Louis,
MO 63126 Tel.: 314-962-9870

Vice President/Director of Marketing: Herbert M. Jaffe
Director of Sales: Paul Grote
National Sales Manager: Tony Dalba
Chief Engineer: John Saller
Products: high quality, commercial sound loudspeakers, enclosures and accessories for music, alarm and public address systems, baffles for ceilings and walls, matching transformers and backbox enclosures. See full listing under **Loudspeakers & Accessories**.

UREI, 8500 Balboa Blvd., Northridge, CA 91329
Tel.: 818-893-8411

President: Ron Means
Vice President, Sales: Ken Lopez
Applications Engineer: Drew Daniels
Products: power amplifiers, limiters, compressors, equalizers, filters, Time Aligned™ speakers, direct boxes, electronic crossover, digital metronome, transcription preamplifier, disco mixers, broadcast consoles. See full listing under **Audio Signal Processors**.

WHITE INSTRUMENTS, INC., P.O. Box 698, Austin,
TX 78767 Tel.: 512-892-0752

President: Thomas H. White
Sales Manager: Emory E. Straus
Chief Engineer: Carl Van Ryswyk
Products: real time analyzers; active and passive equalizers (broad band and narrow band); filters; low level crossover networks; masking noise generators and equalizers. See full listing under **Audio Signal Processors**.

TELEPHONE SYSTEMS — KEYPHONES

AIPHONE INTERCOM SYSTEMS, 1700 130th Ave.
N.E., Bellevue, WA 98005 Tel.: 206-455-0510

President: Hiko Shinoda
Sales Manager: Jim Morrison
Chief Engineer: Jun Matsumoto
Products: industrial, business, residential, loudspeaking, telephone, video intercom/security systems with paging talk-back; six microprocessor systems available; mixer amplifiers, paging speakers, horns, drivers, ceiling speakers.

COMMAND COMMUNICATIONS, INC., 8000 E.
Girard, Suite 416, Denver, CO 80231
Tel.: 303-750-6434

President: William McClure
Products: distributors of business telephones for single line, two lines and speaker phones. Feature phones designed to work behind a PBX. Has hook-flash and headset outlet with volume control for speaker, handset and headset.

FAMOUS TELEPHONE SUPPLY CO., P.O. Box 2172,
Akron, OH 44309 Tel.: 216-762-8811,
800-321-9122

President: J. Blauschild
General Manager: William Brannon
Products: wire and cable; general hardware; apparatus; paging equipment; power equipment; protection devices; tools; splicing equipment; closures; compounds; couplers and peripheral devices; plenum cable. Key systems and PABX's.

GOLDSTAR TELECOMMUNICATIONS, INC.,
1 Madison St., E. Rutherford, NJ 07073
Tel.: 201-777-6940

President: Hye Ho Lee
Chief Engineer: M. J. Lee
Products: full-featured key systems with 10 to 40 station and 5 to 20 C.O. line capacities; DSS, paging, handsfree talkback, speakerphone, 1-button random hunting C.O. expansion (6 outgoing) unit.

ITT TELECOM, Business & Consumer Communication Div., 6131 Falls of the Neuge Rd., Raleigh,
NC 27609 Tel.: 919-878-9510

President: Dick Lindenmuth
Director of Marketing: Rich Beyer
Products: key systems, PABX's and residential telephones.

IWATSU AMERICA INC., 430 Commerce Blvd., Carl-
stadt, NJ 07072 Tel.: 201-935-8580

President: K. Kashimura
Sales Directors: Lenn Berman
Chief Engineer: Robert Beck
Products: key telephone systems ranging from 1 line, 6 stations to 36 trunks, 128 stations.

NORTH SUPPLY COMPANY, 600 Industrial Parkway,
Industrial Airport, KS 66031
Tel.: 913-791-7000

President: Stan Fisher
Sales Manager: Gerry Gleissner
Products: national distributor of telecommunications equipment and security/alarm systems including Premier™ electronic key systems, and telephones.

PLANT EQUIPMENT INC., 28075 Diaz Rd.,
Temecula, CA 92390 Tel.: 714-676-4802

President: John H. Fuller
Sales Manager: Ruth Barnett
Chief Engineer: Heinz Ross
Products: key telephone dispatch systems, 911 emergency dispatch systems, traders consoles and 1A2 key telephone systems.

TELE-PATH INDUSTRIES, INC., 3361 Melrose Ave.
N.W., Roanoke, VA 24017
Tel.: 703-982-8844

President: Leon Harris
Sales Manager: Jim Connor
Products: key system intercoms; PBX paging adapters; code-call units, complete line of 1A2 key enhancement products.

TIE/COMMUNICATIONS INC., 5 Research Dr., Shel-
ton, CT 06484 Tel.: 203-926-2000

President: Thomas L. Kelly, Jr.
Vice President, Sales: Brian Kelley
Vice President, Technology: Patrick Courtin
Products: electronic key telephone systems featuring privacy, simultaneous intercom calls with hands-free reply, multi-line conferencing, all-call paging, single button call-forwarding, automatic recall of calls placed on hold, memory dialing, camp-on, queuing, hotlines, do-not-disturb. New hybrid microprocessor based, digitally controlled communications systems.

District Offices:
350 Shuman Bl., Naperville, IL 60540
1500 W. Cape Dr., San Mateo, CA 94404
20 Technology Pkwy., #370, Norcross, GA 30092
2050 Center Ave., Ft. Lee, NJ 07024
11701 Borman Dr., St. Louis, MO 63146
6200 S. Syracuse Way, Englewood, CO 80111
4100 Alpha Rd., Dallas, TX 75244
351 Steelcase Rd. W., Markham, Ontario, Canada

TOSHIBA AMERICA, INC., Telecommunications
Div., 2441 Michelle Dr., Tustin, CA 92680
Tel.: 714-669-5197

Vice President and General Manager: Paul Wexler
Products: Strata VI, XII and XX and perception microprocessor based electronic key systems, Speakerphone, automatic dialing, toll restriction, on-hook dialing, automatic recall, and more, all standard. Perception™ electronic business communications system. (EBCS) 32 trunks and 120 line capacity.

District Office:
Toshiba Telecom, 111 Business Park Dr., Armonk, NY 10504

VALCOM, INC., 1111 Industry Ave., Roanoke, VA
24013 Tel.: 703-982-3900

President: J.W. Mason
Sales Manager: Donald Buck
Chief Engineer: D. Lynch
Products: telephone integrated paging and intercom systems, talkback, bell-buzzer, code call, PBX adapters, key telephone system ancillaries, loud ringers, power supplies, amplified and talkback speakers. Single line and feature telephone.

V BAND SYSTEMS, INC., 5 Odell Plaza, Yonkers, NY
10701 Tel.: 914-964-0900

President: John R. Cootts, Thomas E. Feil CEO
Vice President, Marketing: Ronald E. Haworsen
Chief Engineer: Leonid Shor
Products: electronic key telephone systems for the financial community, 911 applications, load control centers and military communications.

WALKER TELECOMMUNICATIONS CORP., 200 Oser
Hauppauge, NY 11788 Tel.: 516-435-1100

Chairman of the Board: Burt Walker
President: Howard Laffler
President, Telephone Systems Div.: Morton Brozinsky
Vice President, Marketing: David Lyons
Products: electronic key telephone systems from 6 lines and 16 stations to 30 lines and 96 stations, featuring off-hook hands-free answerback, speed dialing and automatic incoming call backup.

XTEL, 4301 Will Rogers Pkwy, Ste. 900, Oklahoma
City, OK 73108 Tel.: 405-946-1500

President: J. William Patterson
Vice President: Glen Patterson
Products: "Keyflex 10" 10 button 1A2 telephone. "On-Hook" dialing, 9 number speed dial plus last number redial, multi-line conferencing, LED line status.

TELEPHONE SYSTEMS—PBX

FAMOUS TELEPHONE SUPPLY CO., P.O. Box 2172,
Akron, OH 44309 Tel.: 216-762-8811
800-321-9122

President: J. Blaushild
General Manager: William Brannon
Products: wire and cable; general hardware; apparatus; paging equipment; power equipment; protection devices; tools; splicing equipment; closures; compounds; couplers and peripheral devices, plenum cable. Key systems and PABX's.

HARRIS DIGITAL TELEPHONE SYSTEMS, 1 Digital
Dr., Novato, CA 94948 Tel.: 415-472-2500

General Manager: Donald Green
Vice President, Sales: William Vandervoort
Chief Engineer: Alan Negrin
Products: complete range of computerized digital PBX's from 8 to over 1000 station lines, featuring communications cost management, redundancy and network systems capability.
District Offices:
Ron Kliever, P.O. Box 1188, Novato, CA 94948-9986
Richard Grunz, 6400 Shafer Ct., #300, Rosemount, IL 60018
V. Cahill, 675 Third Ave., NY 10017
Don Grossberndt, 875 Johnson Ferry Rd., Atlanta, GA 30342

MITEL, INC., 5400 Broken Sound Blvd. N.W., Boca
Raton, FL 33431 Tel.: 305-994-8588

Vice President, U.S. Marketing: Thomas Mayer
Chief Engineer: Gordon Turner
Assistant Vice President, Marketing Services: Charles Y. Urquhart
Products: toll diverters, toll restrictors, speed dialers, tone pulse converters, EPABX, intercom systems. Tone generators, tone receivers, paging adapters. Line event recorders, dialed number display units.

RING GROUP OF NORTH AMERICA, 230 Community
Dr., Great Neck, NY 11021
Tel.: 516-487-0250 800-645-9690

President: Ron Stone
Vice President: Paul Ruggieri
Chief Engineer: John Camello
R & D Manager: Ken Solem
Products: DCD 600 Digital Call Distributor is a PCM port-oriented switch with up to 256 ports, offering PBX access. Full MIS with a specially designed alpha-numeric agent station.

SIEMENS COMMUNICATION SYSTEMS, INC.,
5500 Broken Sound Blvd., Boca Raton, FL 33431
Tel.: 305-994-8100

President: G. Jaensch
Sales Manager: D. Tecen
Chief Engineer: D. Taylor
Products: SD series of EPABX — 12 lines to 200 lines. Saturn™ digital PABX for voice/data applications. Up to 992 available ports.
District Offices:
L. White, 767 Fifth Ave. (4th Fl.), New York, NY 10153
L. White, 1 Metro Plaza, 8100 Professional Plaza, #204, Landover, MD 20785
C. Moore, 6410 Atlantic Blvd., #185, Norcross, GA 30071
W. Poole, 5310 N. Siemens Ct., Rosemont, IL 60018
D. Willard, 2012 E. Randoll Mill, Arlington, TX 76011
J. Novak, 640 N. Diamond Bar Blvd., Diamond Bar, CA 91765

SOLID STATE SYSTEMS, INC., 1990 Delk Industrial Blvd., Marietta, GA 30067 Tel.: 404-952-2414

President: Ed Mills
Sales Manager: Jason Schloss
Chief Engineer: Joe Mehaffey
Products: CBX, CBX/ACD computerized telephone and automatic call distributor systems; electronic Message Bank™ and Watt-Shaver™ energy management/building automation system.

TELEDIAL DEVICES INC., 125 Schmitt Blvd., Farmingdale, NY 11735 Tel.: 516-293-8400

President: Paul Jacobs
Sales Manager: Sydney Rubenstein
Chief Engineer: Richard Chan
Products: PBX and centrex feature-phones, secured memory phones, restriction and courtesy phones. Automatic memory dials — DTMF and Pulse; toll restriction dials — DTMF and Pulse; Pulse dials with last number recall; solid state tone dials; automatic single number dials.
See full listing under **Telephone System Peripherals.**

TIE/COMMUNICATIONS INC., 5 Research Dr., Shelton, CT 06484 Tel.: 203-926-2000

President: Thomas L. Kelly, Jr.
Vice President, Sales: Brian Kelley
Vice President, Technology: Patrick Courtin
Products: electronic key telephone systems featuring privacy, simultaneous intercom calls with hands-free reply, multi-line conferencing, all-call paging, single button call-forwarding, automatic recall of calls placed on hold, memory dialing, camp-on, queuing, hotlines, do-not-disturb. New hybrid microprocessor based, digitally-controlled communications systems.
See full listing under **Telephone Systems — Key Phones.**

TONE COMMANDER SYSTEMS, INC., P.O. Box 1039, Redmond, WA 98052-1039
Tel.: 206-883-3600 Telex: 15-2246

President: Rod Proctor
Director of Sales and Marketing: Dennis L. Nixon
Director of Engineering: Vasco Rubio
Products: small business PBX's, multi-link intercoms and key system enhancement products.
District Offices:
4016 Clifton Dr., Omaha, NE 68134
208 E. Rocks Rd., Norwalk, CT 06851
17644 Waxwing, South Bend, IN 46635
P.O. Box 10, Lecanto, FL 32661-0110
2130 23rd St., Sacramento, CA 95818

TOSHIBA AMERICA, INC., Telecommunications
Div., 2441 Michelle Dr., Tustin, CA 92680
Tel.: 714-669-5197

Vice President and General Manager: Paul Wexler
Product: Sirata VI, XII and XX and perception microprocessor based electronic key systems. Speakerphone, automatic dialing, toll restric-

tion, on-hook dialing, automatic recall, and more, all standard. Perception™ electronic business communications system (EBCS). 32 trunks and 120 line capacity.

See full listing under **Telephone Systems — Keysets.**

VALCOM, INC., 1111 Industry Ave., VA 24013
Tel.: 703-982-3900

President: J. W. Mason
Sales Manager: Donald Buck
Chief Engineer: D. Lynch
Products: telephone integrated paging and intercom systems, talkback, bell-buzzer, code call, PBX adapters, key telephone system ancillaries, loud ringers, power supplies, amplified and talkback speakers. Single line and feature telephone.
See full listing under **Paging Systems—All Types.**

XTEL, 4301 Will Rogers Parkway, Suite 900, Oklahoma City, OK 73108 Tel.: 405-946-1500

President: J. William Patterson
Vice President: Glen Patterson
Products: "Status" telephones and stand alone LSIs; monitoring for up to 60 stations, single line/4 line, built-in paging speaker, requires no KSU, two pair wiring.

TELEPHONE SYSTEM PERIPHERALS

ADC TELECOMMUNICATIONS, INC., 4900 W. 78th St., Minneapolis, MN 55435 Tel.: 612-835-6800

President: C.M. Denny
Manager: Jack Brandmueller
Chief Engineer: J. Deitch
Products: insulation displacement, cross connect products for customer premise location, telephone test and access products, broadcast equipment.
District Offices:
V. J. Brennan, 425 Post Rd., Fairfield, CT 06430
Harold Ross, 2 Crystal Gateway, 12225 Jefferson Davis Hwy., #412, Arlington, VA 22202
Dick Van Overbeke, 6000 S. Ulster, #201, Englewood, CO 80111
Lloyd Mitchell, 5525 MacArthur Blvd., Suite 420, Irving, TX 75038
Bruce Miller, 901 Sneath Lane, Suite 200, Bruno, CA 94066

AUTOMATION ELECTRONICS CORP., 344-40th St., Oakland, CA 94609 Tel.: 415-652-6675

President: Buck Wilson
Sales Manager: Judd B. Presley
Chief Engineer: John Giordano
Products: incoming call management systems, including automatic call sequencers, telephone management information systems, and multi-line announcers.
District Offices:
George Bradley, 8090 Willow Bend Court, Boulder, CO 80301
Shirley Wright, 7412 Forrest Lane, Fort Worth, TX 76180
Judy Taylor, 1059 Abbieshire Ave., Lakewood, OH 44107
Daryl Fierce, 456 Page Avenue N.E., Atlanta, GA 30307
Bill Baume, 1130 Logan Street, Alton, IL 62002

FLOYD BELL INC., 897 Higgs Ave., Columbus, OH 43212 Tel.: 614-488-3193

President: Don Foukal
Sales Manager: Tom Shain
Chief Engineer: Ely Zofan
Products: electronic ringers for straight line, key, or PBX telephone systems. Pleasant warble tone 5 to 150 VAC/DC. Complete line of piezoelectric audio alarms.

BUSCOM SYSTEMS, INC., 490 Gianni St., Santa Clara,
CA 95054 Tel.: 408-988-5200

President: Thomas F. Hood
Sales Manager: Tom Eisenhart
Chief Engineer: Dr. Donald M. Bellenger
Products: single/2-line smart telephones, automatic dialers, tone en-
coders, replacement handsets, call diverters in tone/pulse/remote,
line/WATS extenders.

CEAC INC., 1500 E. Conecuh, Union Springs, AL 36089
Tel.: 205-738-2000

President: R. M. Pirnie
Sales Manager: William R. Drykos
Chief Engineer: Dr. M. Griswold
Products: audio audio/graphic teleconferencing bridges and room
speaker phones. Product names: Axis, Arcs.

DETEC RAYMER, 7315 Fulton Ave., N. Hollywood,
CA 91605 Tel.: 213-875-0423

President: Richard P. Drake
Chief Engineer: Clifford L. Kogge Jr.
Products: background foreground equipment: wall and shelf mount
amplifiers, AM-FM tuners and paging receivers, microphone mixers,
installation accessories and transformers, M-O-H and telephone inter-
connect devices, and test equipment.
See full listing under **Background/Foreground Music Systems**.

CLIFFORD INC., 83 Main St., Bethel, VT 05032
Tel.: 800-451-4381 Toll Free,
802-234-9921 Collect

President: Richard L. Huntley
Sales Manager: Martha McKinney
Products: all accessory materials needed to install and maintain
telephone communications cable and wire systems. (Terminals, con-
nectors, protectors, closures, splices, tapes, hand tools, etc.)

COMMAND COMMUNICATIONS INC., 8000 E.
Girard, #416, Denver, CO 80231
Tel.: 303-750-6434

President: William McClure
Products: distributors of business telephones for single line, two lines
and speakerphones. Feature phones designed to work behind a PBX.
Has hook-flash and headset outlet with volume control for speaker,
handset and headset.

CONTECH, INC., 30 Plaza Dr., Westmont, IL 60033
Tel.: 312-789-0888

President: Dan Finch
Sales Manager: Ken Bird
Chief Engineer: Mike Lathrope
Products: teleconferencing equipment, audio amplifiers for connection
to public phone network. Teleconference bridging and terminals.

DACON ELECTRONICS INC., 8 Industrial Ave.,
Upper Saddle River, NJ 07458
Tel.: 201-825-4640

President: Daniel J. Connelly
Sales Manager: James N. Taylor
Chief Engineer: Rich Van Tieghem
Products: automatic call sequencers, call concentrators, call diverters,
automatic call distributors, headsets, automatic bridging unit.
District Offices:
Tracy Clagett, 10478 Malone Ct., Fairfax, VA 22032
Larry Walthers, 8184 NW Kirkwood Dr., Kansas City, KS 64151
Russ McCarthy, 5300 Orange Ave., Ste. 101, Cypress, CA 90630
Joan Beachner, 6861 Elm St., McLean, VA 22101
Gary Low, 5300 Orange Ave., Ste. 101, Cypress, CA 90630

ELECTRONIC SPECIALISTS, INC., 171 S. Main St.,
P.O. Box 389, Natick, MA 01760
Tel.: 617-655-1532, 800-225-4876

President: Frank Stifter
Sales Manager: M. A. Kay
Products: interference filters for FM, TV, VCR, CB and stereo equip-
ment. Kleen Line® AC power interference filters and spike suppressors.

FAMOUS TELEPHONE SUPPLY CO., P.O. Box
2172, Akron, OH 44309 Tel.: 216-762-8811,
800-321-9122

President: J. Blaushild
General Manager: William Brannon
Products: wire and cable; general hardware; apparatus; paging equip-
ment; power equipment, protection devices; tools; splicing equipment;
closures; compounds; couplers and peripheral devices, plenum cable.
Key systems and PABX's.

HARRIS CORP., DRACON DIVISION, 809 Calle Plano,
Camarillo, CA 93010 Tel.: 805-987-9511

Vice President, General Manager: John R. Mason
Sales Manager: Tom Erdmann
Chief Engineer: Joe Mader
Products: telephone integrated loudspeaker paging systems; linemen's
test sets; craft tools; power supplies; DC-DC converters and extensive
line of relay racks.
See full listing under **Paging Systems—All Types**.

INFORMATION DYNAMICS CORPORATION, 1251
Exchange Drive, Richardson, TX 75081
Tel.: 214-783-8090

President: Charles L. Friedman
Chief Engineer: Daniel Power
Products: displays: busy visual displays, line status indicators, wall BVD
& Centrex LSI's.

LT ELECTRONICS LTD., 2535 Gerrard St. East,
Scarborough, Canada M1N 1W9
Tel.: 416-691-9406

President: Jim Breedon
Sales Manager: Jim Breedon
Chief Engineer: J. Hesse
Products: school intercoms, cone speakers, sound columns, packaged
amplifiers, telephone amplifiers, speaker baffles, bass reflex speaker
systems.
See full listing under **Paging Systems**.

MELCO LABS, INC., 14408 N.E. 20th St., Bellevue,
WA 98007 Tel.: 206-643-3400

Chairman & CEO: Alex McIntosh
Vice President, Marketing & Sales: Louis Champan
Executive Technical Director: Bill Blum
Products: key system intercoms, paging equipment, MAX communica-
tion systems, service observing equipment, electronic key systems, line
hold units, telephone amplifiers, off premise equipment.
District Offices:
Mike Anderson, 2435 Chimney Springs Drive, Marietta, GA 30062
Robert King, 6117 Loventree Road, Columbia, MD 21044
Tom O'Hara, Route 1, Box 96X, Union Springs, AL 36089
Bob Weckherlin, 2616 Blue Quail Drive, Arlington, TX 76017

METRO-TEL CORP., 15 Burke Lane, Syosset, NY
11791 Tel.: 516-364-3377

President: V. J. Indelicato
Sales Manager: Phil Johnson
Chief Engineer: Bob Grastataro
Products: automatic call sequencing systems, with full management data
and compatible with virtually all type telephone systems. Automatic
dialing systems providing all line, all station access.

RADIONICS INCORPORATED, 920 Holt Rd., Webster, NY 14580 Tel.: 716-872-2100

President: A. J. Ozminowski
Sales Manager: Daniel McKinley
Chief Engineer: Fred B. Cupp
Products: DIRECTORY PLUS — telecommunications management and directory system. On-line directory assistance for operators. Phone system configuration, wiring plan, equipment inventory data for communications managers.

RING GROUP OF NORTH AMERICA, 230 Community Dr., Great Neck, NY 11021
Tel.: 516-487-0250, 800-645-9690

President: Ron Stone
Vice President: Paul Ruggieri
Chief Engineer: John Camello
R & D Manager: Ken Solem
Products: ACD/5000, DCD 600, full featured, software controlled ACD systems with comprehensive MIS packages. Specially designed agent station. Emergency 911 system includes automatic number identification (ANI), Automatic Line ID (ALI).
See full listing under **Intercom Systems—Duplex**.

RITRON, INC., 148 W. Carmel Dr., P.O. Box 1998, Carmel, IN 46032 Tel.: 317-846-1201

President: E. W. Rice, III
Sales Manager: Steve Rice
Chief Engineer: Steve Henke
Products: industrial and business portable radio/telephone system, phone line extender, local area bypass products.

SOLID STATE SYSTEMS, INC., 1990 Delk Industrial Blvd., Marietta, GA 30067 Tel.: 404-952-2414

President: Ed Mills
Sales Manager: Jason Schloss
Chief Engineer: Joe Mehaffey
Products: CBX, CBX/ACD computerized telephone and automatic call distributor systems, electronic Message Bank™ and Watt-Shaver™ energy management/building automation system.

TELE-ASSEMBLIES, 4 Ferndale Ave., Miller Place, NY 11764 Tel.: 516-744-7433

President: Leon Goudikian
Products: code call unit, telephone relay control, custom telephone circuits.

TELEDIAL DEVICES INC., 125 Schmitt Blvd., Farmingdale, NY 11735 Tel.: 516-293-8400

President: Paul Jacobs
Sales Manager: Sydney Rubenstein
Chief Engineer: Richard Chan
Products: automatic memory dials — DTMF and Pulse; toll restriction dials — DTMF and Pulse; Pulse dials with last number recall; solid state tone dials; automatic single number dials, PBX and Centrex feature-phones, secured memory phones, and memory, restriction and courtesy phones.
District Offices:
North Supply, Kansas City, MO
Graybar Electric Co., Clayton, MO
Centel Supply Co., Lincoln, NE
Famous Telephone Supply, Akron, OH
Anixter Supply, Chicago, IL

TELEPHONE DYNAMICS CORP., 2473 Jerusalem Ave., Box 514, North Bellmore, NY 11710
Tel.: 516-221-9470

President: Leonard Young
Chief Engineer: Jack Mara
Products: telephone answering systems — from 1-to-48 lines — telephone recorders — handsets — operators headsets — automatic answering dial-to-page.

TELEPHONIC EQUIPMENT CORP., 17401 Arm-Strong Ave., Irvine, CA 92714
Tel.: 714-250-9400

President: H. U. McNulty
Sales Manager: John Meeer
Chief Engineer: Chris Kast
Products: ACD's, PBX-EKS - 1A2 key system sequencers, conferencing systems, toll restrictors, remote access, on-net off-net access, amplifiers, dispatch consoles, radio/telephone manual terminals.

TELTONE CORPORATION, 10801 120th Ave. NE, Kirkland, WA 98036 Tel.: 206-827-9626

President: Pat Welker
Sales Manager: Mike Arndt
Chief Engineer: Jim Carefoot
Products: T-310 telephone access unit—RS-232-C compatible controller for telephone lines, allowing computers to answer/originate calls, send/receive DTMF signals, couple audio sources onto lines.
Sales Representatives:
Lauren Pearson, Teltone, 10801 120th Ave. NE, Kirkland, WA 98033
Steve Walker, Teltone, 10801 120th Ave. NE, Kirkland, WA 98033
Jerry Pagel, Teltone, 2557 Bishop Estates Rd., Jacksonville, FL 32223

TIE/COMMUNICATIONS INC., 5 Research Dr., Shelton, CT 06484 Tel.: 203-926-2000

President: Thomas L. Kelly, Jr.
Vice President, Sales: Brian Kelley
Vice President, Technology: Patrick Courtin
Products: electronic key telephone systems featuring privacy, simultaneous intercom calls with hands-free reply, multi-line conferencing, all-call paging, single button call-forwarding, automatic recall of calls placed on hold, memory dialing, camp-on, queuing, hotlines, do-not-disturb. New hybrid microprocessor based, digitally-controlled communications systems.
See full listing under **Telephone Systems — Key Phones**.

TII INDUSTRIES, INC., 1375 Akron St., Copiague, NY 11726 Tel.: 516-789-5020

President: Timothy J. Roach
Director, Business Development: Donald M. Worden
Chief Engineer: Jack Cawley
Products: AC power-line surge suppressors, AC line filter and surge suppressor, AC line monitor and surge suppressor.
District Offices:
Anixter Communications
Graybar Electric
North Supply
GTE Supply
Texocom

TONE COMMANDER SYSTEMS, INC., 4320 150th N.E., Redmond, WA 98052
Tel.: 206-883-3600

President: Maurice I. Smith
Vice President, Sales: Michael Millikin
Chief Engineer: Vasco Rubio
Products: small business PBX's, multi-link intercoms and key system enhancement products, residential equipment.
See full listing under **Telephone Systems—PBX**.

WESTELL, INC., 7630 Quincy St., Willowbrook, IL 60521 Tel.: 312-789-0888

President: Dan Finch
Vice President: Ronald Brust
Director of Marketing: Ken Bird
Products: terminals and bridges for telecommunications industry.

WHELOCK SIGNALS, INC., 273 Branchport Ave., Long Branch, NJ 07740 Tel.: 201-222-6880

President: Peter W. Tarlton
Sales Manager: Harry J. Foster

Chief Engineer: Steve W. Andrews

Products: audible/visual signaling devices for life safety and alarm systems and for telephone systems. Bells, horns, speakers, strobes, chimes and combinations.

See full listing under **Bells, Buzzers, Gongs.**

WREN COMPANY, 880 Reynard St., Cincinnati, OH 45231 Tel.: 513-931-7160

Marketing Dept.: 3413 Ardis Ave., Rowlett, TX 75088 Tel.: 214-475-0721

President: David M. Stoner

Marketing Director: William Fowle

Chief Engineer: Joseph Kappes

Product: "Computerfone"—a call costing and accounting system for smart PABX's or Key systems having an SMDR output. Software for hotel/motel, business, and client bill back.

District Offices:

39839 Paseo Padre Pkwy., Fremont, CA 94538

5231 Gordon Smith Dr., Rowlett, TX 75088

XTEL, 4301 Will Rogers Pkwy., Suite 900, Oklahoma City, OK 73108 Tel.: 405-946-1500

President: J. William Patterson

Vice President: Glen Patterson

Products: "HVP 700" hazardous voltage protection for grandfather and registered telephone equipment. Eliminates letter of agency and accompanying insurance ticket. "Voicepac" intercoms, "Status" stand alone line monitors.

TELEPHONE SYSTEM REPLACEMENT PRODUCTS

AMPHENOL PRODUCTS, 4300 Commerce Court, Lisle, IL 60532 Tel.: 312-983-3500

President: P. W. Arneson

Sales Manager: W. Mango

Chief Engineer: R. Price

Products: electrical, electronic and fiber optic connectors, cable and cable assemblies and related accessories.

District Offices:

Chicago, New York, Los Angeles, Dallas, San Francisco.

CALRAD ENGINEERED ELECTRONIC PRODUCTS, 819 No. Highland Ave., Los Angeles, CA 90038 Tel.: 213-465-2131

President: Joseph Shupper

Vice President: Robert Shupper

Sales Manager: Fred Crown

Chief Engineer: Wes Black

Products: microphones, headphones, public address amplifiers, power supplies, speakers, connecting cables, telephone accessories, potentiometers, connectors, switches, meters, control knobs.

See full listing under **Audio Amplifiers.**

TELEDIAL DEVICES INC., 125 Schmitt Blvd., Farmingdale, NY 11735 Tel.: 516-293-8400

President: Paul Jacobs

Sales Manager: Sydney Rubenstein

Chief Engineer: Richard Chan

Products: automatic memory dials — DTMF and Pulse; toll restriction dials — DTMF and Pulse; Pulse dials with last number recall; solid state tone dials; automatic single number dials, PBX and Centrex feature-phones, secured memory phones, restriction and courtesy phones.

August, 1985

TELEPHONE COMPONENTS, INC., 3180 Expressway Dr. S., Islip, NY 11722 Tel.: 516-582-4745

President: P. Crescentini

Sales Manager: James Costa

Products: telephone handsets, hangers, hook switches, cradles; operator headsets; plugs and jacks; for standard and special application, such as mobile, interconnect etc. Retractable and straight telephone cords.

TELEPHONE EXTENSION CORP., 83 E. Central Ave., Pearl River, NY 10965 Tel.: 914-735-7877

President: Irving Gudin

Sales Manager: Howard Harris

Chief Engineer: Jean St. Fleur

Products: telephones, telephone accessories, bells, buzzers, wire, gongs.

TONE COMMANDER SYSTEMS, INC., 4320 150th N.E., Redmond, WA 98052 Tel.: 206-883-3600

President: Maurice I. Smith

Vice President, Sales: Michael Millikin

Chief Engineer: Vasco Rubio

Products: small business PBX's, multi-link intercoms and key system enhancement products, residential equipment.

See full listing under **Telephone Systems PBX.**

VALCOM, INC., 1111 Industry Ave., Roanoke, VA 24013 Tel.: 703-982-3900

President: J. W. Mason

Sales Manager: Donald Buck

Chief Engineer: D. Lynch

Products: telephone integrated paging and intercom systems, talkback, bell-buzzer, code call, PBX adapters, key telephone system ancillaries, loud ringers, power supplies, amplified and talkback speakers. Single line and feature telephones.

See full listing under **Paging Systems — All Types.**

TEST EQUIPMENT & TOOLS

BRUEL & KJAER INSTRUMENTS, INC., 185 Forest St., Marlborough, MA 01752 Tel.: 617-481-7000

President: W. van Barneveld

Products: manufacturers of studio microphones, audio transducer and telephone measuring systems, time delay spectrometry, real time analyzers, sound level meters, other acoustic test instrumentation.

District Offices:

Bruel & Kjaer Instruments, Inc., 1140 Bloomfield Ave., W. Caldwell, NJ 07006

Bruel & Kjaer Instruments, Inc., 15944 Shade Grove Rd., Gaithersburg, MD 20877-1375

Bruel & Kjaer Instruments, Inc., 12878 Farmington Rd., Livonia, MI 48150

Bruel & Kjaer Instruments, Inc., 555 W. Central Rd., Hoffman Estates, IL 60195

Bruel & Kjaer Instruments, Inc., 1542 E. Katella, Anaheim, CA 92805

CETEC IVIE, 1366 Center St., Orem, UT 84057 Tel.: 801-224-1800

President: Craig Berry

Sales Manager: Glen Meyer

Chief Engineer: Greg Greenwood

Products: audio spectrum real-time analyzers and SPL meters, laboratory precision air condenser measurement microphones, microprocessor, acoustic and reverberation analysis systems, pink and white noise generators.

See full listing under **Audio Signal Processors.**

CETEC RAYMER, 7315 Fulton Ave., No. Hollywood,
CA 91605 Tel.: 213-875-0423

President: Richard P. Drake

Chief Engineer: Clifford L. Kogge, Jr.

Products: background/foreground equipment: wall & shelf mount amplifiers, AM/FM tuners & paging receivers, microphone mixers, installation accessories & transformers, M-O-H & telephone interconnect devices and test equipment.

See full listing under **Background/Foreground Music**.

COMMUNICATIONS CO., INC., 3490 Noell St., San
Diego, CA 92110 Tel.: 714-297-3261

President and Sales Manager: Peter T. Jordan

Chief Engineer: David Johnson

Products: programmable two-way intercom amplifier w/vox., media distribution amplifier, projector patch, room combining systems, record patch, RT-60 reverberation measuring device, burst octave noise generator, 1/2 octave real time analyzer, 27 B.I.T. oscilloscope display adaptor.

See full listing under **Intercom Systems — Institutional**.

CROWN INTERNATIONAL INC., 1718 W. Mishawaka
Rd., Elkhart, IN 46517 Tel.: 219-294-8000

President: Max W. Scholfield

Marketing Manager: Charles W. Gushwa

Engineering Manager: Verne E. Searer

Products: RTA-2 real-time analyzer, BDP-2 computer spectrum analyzer, TEF System 10 portable computer using time delay spectrometry to measure room acoustics and loudspeakers.

HARRIS CORP., Dracon Division, 809 Calle Plano,
Camarillo, CA 90310 Tel.: 805-987-9511

Vice President, General Manager: John R. Mason

Sales Manager: Tom Erdmann

Chief Engineer: Joe Mader

Products: telephone integraged loudspeaker paging systems; linemen's test sets; craft tools; power supplies; DC-DC converters and extensive line of relay racks.

See full listing under **Paging Systems — All Types**.

KULKA SMITH INC., NEUTRIK PRODUCTS, 1913
Atlantic Ave., Manasquan, NJ 08736
Tel.: 201-223-9400

President: Harry Miller

Sales Manager: Jim Cowan

Chief Engineer: Fred Kaufmann

Products: 3, 4, 5, 6-pin XLR connectors, panel and P.C.

METRO-TEL CORP., 15 Burke Lane, Syosset, NY
11791 Tel.: 516-364-3377

President: V. J. Indelicato

Sales Manager: Phil Johnson

Chief Engineer: Bob Grastataro

Products: linemen's test sets, cable locators, power supplies, splicers test sets, volt/ohm meters, explorin, coils, headsets.

MUSIC SUPPLY CO., INC., 809 N. Madison, Dallas,
TX 75208 Tel.: Texas call collect 214-946-8450
All others 1-800-527-1522

President: W. E. Brown

Products: Testset, Model TS-1 for use in all audio work. Ideal for background music and sound equipment service and installation. Its usefulness is up to your ingenuity. No batteries or switches. Pictorial instruction sheet included. 30 days free trial.

NON-LINEAR SYSTEMS, Division of Kaypro Corp.,
533 Stevens Ave., Solana Beach, CA 92075
Tel.: 619-481-3900

President: Andrew Kay

BB-66

Regional Field Sales: Jeanne Simmons

Chief Engineer: Kurt Bilinski

Products: portable oscilloscopes, digital multimeters, frequency meters, temperature meters, digital panel meters.

PLATT LUGGAGE, INC., 2301 S. Prairie Ave., Chi-
cago, IL 60616 Tel.: 1-800-222-1555

President: Paul Platt

Sales Manager: Dennis Platt

Chief Engineer: Joseph March

Products: tool cases.

PROGRESSIVE ELECTRONICS, INC., 325 S.
El Dorado, Mesa, AZ 85202
Tel.: 602-966-2931, 800-528-8224

Products: cable and pipe locators, cable fault locators, test sets for cable installation and repair, tone generators, voltage, resistance, capacitance, testsets, inductive amplifier probe.

SIMPSON ELECTRIC CO., 853 Dundee Ave., Elgin,
IL 60120 Tel.: 312-697-2260

President: G. N. Goldberger

Director, Sales: M. O. Buehring

Chief Engineer: H. Washburn

Products: electrical/electronic, analog and digital, measuring, controlling and recording test equipment. VOM's, DMM's, frequency counters; and sound level measurement equipment, oscilloscopes and communication equipment testers.

District Offices:

Simpson Instrument Sales, 33 Great Neck Road, Great Neck, L.I., NY 11021

Simpson Electric Company, 10630 Downey Ave., Suite 202, Downey, CA 90241

Seacom Sales Company, 3500 N. State Rd. #7, Suite 460-C, Lauderdale Lakes, FL 33319

Samuel K. Macdonald Inc., 1531 Spruce St., Philadelphia, PA 19102

J. Y. Schoonmaker Co., 10710 Sand Hill Road, Dallas, TX 75238

Leonard D. Allen Inc., 19 Eastern Avenue, Syracuse, NY 13211

Baehr-Greenleaf & Assoc., 14700 Detroit Ave., Cleveland, OH 44107

C. T. Carlberg & Assoc., 2530 Washington, N.E., Albuquerque, NM 87110

Cartwright & Bean Inc. of GA, 3198 Cain's Hill PL.N.W., Atlanta, GA 30305

Cartwright & Bean Inc. of TN, 560 S. Cooper, Memphis, TN 38104

D. Dolin Sales Co., 131 West Layton Avenue, Milwaukee, WI 53207

Earl & Brown Company, Inc., 7719 S.W. Capitol Highway, Portland, OR 97219

Mel Foster Technical Sales Inc., 7611 Washington Ave. S., Edina, MN 55435

Kathrinus-Kelly-Baumhauer & Co., 1610 Big Bend Blvd., St. Louis, MO 63117

Harry J. Lang & Assoc., 1371 Hillcrest Drive #303, Anchorage, AK 99503

R. C. Merchant & Co., Inc., 23735 Research Drive, Farmington Hills, MI 48024

Wm. J. Purdy Co., 770 Airport Blvd., Burlingame, CA 94010

Wm. J. Purdy Co., 5570 East Yale Avenue, Denver, CO 80222

Sturgeon Company, Inc., 51 Pickering Street, Needham, MA 02192

Technology Marketing Corp., 599 Industrial Drive, Carmel, IN 46032

SPECO DIV., Components Specialties, Inc., 1172 Rt.
109, P.O. Box 624, Lindenhurst, NY 11757
Tel.: 516-957-8700 (in NY)
1-800-645-5516 (outside NY)

President: Louis W. Keller

Vice President: Mel Hulkower

Chief Engineer: James Ganci

Products: PA horns, amplifiers, tuners, loudspeakers, wall baffles, speaker assemblies, outdoor speakers, sound columns, ceiling grilles, transformers, L-pads, attenuators, accessories, microphones, intercoms, alarm sirens, multitesters, oscilloscopes.

Sound & Communications

UREI, 8500 Balboa Blvd., Northridge, CA 91329
Tel.: 818-893-8411

President: Ron Means

V. P., Sales: Ken Lopez

Application Engineer: Drew Daniels

Products: power amplifiers, limiters, compressors, equalizers, filters, Time-Aligned™ speakers, direct boxes, electronic crossover, digital metronome, transcription preamplifier, disco mixers, broadcast consoles.

See full listing under **Audio Signal Processors**.

WHITE INSTRUMENTS, INC., P.O. Box 698, Austin, TX 78767 Tel.: 512-892-0752

President: Thomas H. White

Sales Manager: Emory E. Straus

Chief Engineer: Carl Van Ryswyk

Products: real time analyzers; active and passive equalizers (broad band and narrow band); filters; low level crossover networks; masking noise generators and equalizers.

See full listing under **Audio Signal Processors**.

TUNERS

BOGEN, A Lear Siegler Company, Box 500, Paramus, NJ 07653 Tel.: 201-343-5700

President: John H. Ochtera

Vice President, Marketing: Carl C. Dorwaldt

Vice President, Engineering: Mark Koller

National Sales Manager: Art Arlow

Products: FM/AM tuners, also amplifiers, receivers, speakers, accessories and application-engineering for a wide range of background music systems.

See full listing under **Engineered Sound Systems**.

CETEC RAYMER, 7315 Fulton Ave., N. Hollywood, CA 91605 Tel.: 213-875-0423

President: Richard P. Drake

Chief Engineer: C. L. Kogge, Jr.

Products: background/foreground equipment: wall and shelf mount amplifiers, AM/FM tuners and paging receivers, microphone mixers, installation accessories and transformers, M-O-H and telephone interconnect devices and test equipment.

See full listing under **Background/Foreground Music Systems**.

CONSOLIDATED ELECTRONICS, 20 Celestial Way, #205 Juno Beach, FL 33408 Tel.: 305-626-1126

President: Leonard L. Jezorek

Products: antenna systems, tuners, etc.

GROMMES PRECISION ELECTRONICS, INC., 9101 King St., Franklin Park, IL 60131 Tel.: 312-678-5350

President: W. S. Grommes

Sales Manager: W. Stow

Chief Engineer: A. A. Hart

Products: integrated audio amplifiers. Amps for mono or stereo power, line, music-on-hold. Mixer preamplifiers, 2 CH. limiters or compressors, graphic equalizers, FM-AM tuners, background music receivers and systems; public address systems, custom engineered sound reinforcement systems, sound columns, trumpets, driver units, baffles, microphones and microphone stands.

See full listing under **Audio Amplifiers**.

JOHNSON ELECTRONICS INC., P.O. Box 4728, Winter Park, FL 32793-4728 Tel.: 305-677-4030

Chief Executive Officer: Ralph L. Weber

August, 1985

President: J. M. Lutz

Chief Operating Officer: Charles Gabrielson

Vice President of Engineering: Kenneth St. John

Director of Marketing: Mel Kelch

Products: tuners, tuner/amplifiers, solid state audio amplifiers and accessories, DATAVOX™, data transmission equipment.

McMARTIN INDUSTRIES, INC., 4500 S. 76th St. Omaha, NE 68127 Tel.: 402-331-2000

President: Ray B. McMartin

Vice President, Sales: Jay B. McMartin

Products: transistor engineered and commercial sound amplifiers/mixers/accessories, background music amplifiers and sound systems, SCA multiplex receivers, SCA and loudspeaker test sets, AM/FM/TV broadcast consoles, monitors, and transmitters, AM/FM single channel receivers. Satellite communication products.

See full listing under **Audio Amplifiers**.

PASO SOUND PRODUCTS, INC., 14 First St., Pelham, NY 10803 Tel.: 914-738-4800

Vice President, Engineering: Paul Mastrangelo

Operations Manager: Anthony Sgueglia

Sales Manager: David Moore

Products: AM/FM tuners, FM tuners with Presets, digital tuners and receivers; all featuring Paso's Electrotune™ 100% solid state front end. All tuners provide a 600 ohm output to drive music on hold cards. Paso tuners are rack mountable with accessory kit.

See full listing under **Engineered Sound Systems**.

SPECO DIV., Components Specialties, Inc., 1172 Rt. 109, P.O. Box 624, Lindenhurst, NY 11757 Tel.: 516-957-8700 (in NY) 1-800-645-5516 (outside NY)

President: Louis W. Keller

Vice President: Stan Hulkower

General Manager: James Ganci

Director Sales and Marketing: Mel Hulkower

Products: PA horns, amplifiers, tuners, loudspeakers, wall baffles, speaker assemblies, outdoor speakers, sound columns, ceiling grilles, transformers, L-pads, attenuators, accessories, microphones, intercoms, alarm sirens, multitestors, oscilloscopes.

TOA ELECTRONICS, INC., 480 Carlton Ct., S. San Francisco, CA 94080 Tel.: 415-588-2538

President: Sam Sakata

Sales Manager, Distributor Products: Joe Green

Chief Engineer: Tad Inui

Products: engineered VMS series sound systems, microcomputerized EXES intercom systems, commercial sound systems, amplifiers, dual amplifiers, equalizers, multifunctional preamplifiers, mixing consoles, horns, drivers, speakers, wireless systems, microphones, CCTV.

See full listing under **Engineered Sound Systems**.

USED/REBUILT TELEPHONE EQUIPMENT

BUSINESS COMMUNICATIONS INC., 1800 Ellsworth Industrial Drive, Atlanta, GA 30318 Tel.: 404-355-8040

President: Jim Alexander

Product: new and remanufactured telephone equipment.

COMMUNICATION EQUIPMENT BROKERS, INC., 1500 W. Carroll, Chicago, IL 60607 Tel.: 312-829-8810

President: John Presti

Sales Manager: Mark Hastings
Chief Engineer: Ron Jeffries
Products: repair and remanufacture all types of telephones and telephone equipment. Also repairs of amplifiers; preamplifiers; power amplifiers; mixers; equalizers; telephone intercoms; FM-AM tuners and receivers; power supplies; etc.
Sales Representatives:
Lizabeth Husko, 1500 W. Carroll, Chicago, IL 60607

WIRE & CABLE

AUDIO-TECHNICA U.S., INC., 1221 Commerce Dr.,
Stow, OH 44224 Tel.: 216-923-0376

President: Jon R. Kelly
Sales Manager: Charlie Winkler
Chief Engineer: Bob Herrold
Products: microphones and microphone accessories, recorder/mixers, cables, direct boxes, headphones.
See full listing under Microphones.

BELDEN ELECTRONIC WIRE & CABLE, P.O. Box
1980, Richmond, IN 47375 Tel.: 317-983-5200

Sales Manager: Bill Donahoe
Products: electronic wire and cable.
Sales Representatives:
2175 Park Lake Dr., Suite 120, Atlanta, GA 30345
2625 Butterfield Road, Suite 108E, Oakbrook, IL 60521
14651 N. Dallas Pkwy., Suite 144, Dallas, TX 75240
100 Pennsylvania Ave., Suite 450, Framingham, MA 01701
2955 E. Main St., Suite 300, Irvine, CA 92714

Berk-Tek

Reading, PA 

BERK-TEK, INC., Box 60 RD 1, Reading, PA 19607
Tel.: 215-376-8071

President: J. L. Bosco
Sales Manager: Sue Stefan
Products: communications and life-safety wires and cables, plenum, co-axial, interface, J/O, fiber optic, power, audio communication, computer hook-up and lead, special data, coil cords, PVC and Teflon™
District Offices:
Robert Peckrul, 1503 Muirfield Drive, Stone Mountain, GA
Jerry L. Petty, 601 Preston Road, 400 Carillon Plaza, Suite 401,
Dallas, TX 75240
Frank Smith, 3351 Horn's Road, Huntingtown, MD 20639
David Zaabel, 105 Superior Court, Schaumburg, IL 60193

BI-TRONICS, INC., P.O. Box 125, Tuckahoe, NY
10707 Tel.: 212-585-1645
800-522-7377 (outside NY)

President: J. Schwartz
Sales Manager: Ron Huppert
Products: Mogami ultra-flexible audio and video cables and connectors. Custom cable assemblies for Japanese audio and video equipment, including hard-to-find connectors and hardware.

BRIM ELECTRONICS INC., 120 S. Home Pl., Lodi,
NJ 07644 Tel.: 201-796-2886

President: B. Danziger
Sales Manager: B. Brown
Products: wire, cable (including shielded braiding, retracile cords); tubing, sleeving; ceramic insulators; adhesive-backed fastening devices;

nylon, brass hardware; solderless terminals; plugs, jacks, switches.
District Offices:
R.G. Assocs., 50 Wheeler Rd., Stow, MA 01775
R.G. Assocs., Box 396, Millis, MA 02054
DJE Assocs., 147 Lucerne, DeBary, FL 32713

CABLETRONIX, Div. Storm King Industries, Inc.,
366 Washington St., P.O. Box 3003, Newburgh,
NY 12550 Tel.: 914-565-7570
800-431-WIRE (outside NY State)
800-942-WIRE (inside NY State)

President: Stephen L. Roth
Vice President: Leonard Ellentuch
Products: wire and cable for electronics, sound, intercom, interconnect, fire and burglar alarm, control, signal, nurse-call, apartment house, computers, MATV, CCTV, CATV. Plus air plenum cable, teflon, PVC and other construction suitable for UL misc. wiring and Articles 725, 760 and 800. Connectorized telephone and computer cables.

CAL SWITCH, 13717 S. Normandie Ave., Gardena,
CA 90249 Tel.: 213-770-2330

President: Irwin Perlman
Vice President: Robert Andrade
Sales Manager: Bert Vincent
Products: audio connector from 3 to 9 pins for audio and RF circuits, Jack panels, switches, wire and cable, I.D. collars, fuses.

CANARE CABLE INC., 832 N. Victory Blvd., Burbank,
CA 91502 Tel.: 818-840-0993

President: K. Kawamopo
Sales Manager: Kim Obata
Products: low noise audio cable, cable systems, cable reels and video cable.

CLIFFORD, INC., 83 Main St., Bethel, VT 05032
Tel.: 800-451-4381 Toll Free
802-234-9921 Collect

President: Richard L. Huntley
Sales Manager: Martha McKinney
Products: inside and outside telephone communications cable and wire: aerial and duct, figure "8" self-supporting, direct earth burial, air plenum, computer cable, electronic cable, alarm wire, instrumentation cable, and more.

CONNECTRONICS CORPORATION, 652 Glenbrook
Rd., Stamford, CT 06906 Tel.: 203-324-2889
800-322-2537

President: Stephen G. Ash
Vice President: Richard J. Chilvers
Products: ultra-flexible, colored wire and cable from Mic Cable to 32 pr. foil shielded. Also audio signal processors, portable mixing consoles, low-cost XLR connectors.
District Offices:
A/V Marketing, 5978 Industrial Drive, Carmel, IN 46032
GMI, 65 Maguire Ave., Avon, MA 02322
New Horizons Electronic Marketing, 2211-B Lakeside Dr.,
Bannockburn, IL 60015
Pro Audio Marketing, P.O. Box 765, Melville, NY 11747
Sunwest Marketing, 818 E. River View, Orange, CA 92665

CONQUEST SOUND CO., 15524 S. 70th Ct., Orland
Park, IL 60462 Tel.: 312-429-1770, 800-323-7671

President: Bob Jares, Jr.
Vice President and Sales Manager: Larry Spalla
Chief Engineer: Mike Sanfilippo
Products: 2500 types of audio wiring products from instrument cords to 36 pair multi-cables. Warehouse over 500,000 switchcraft connectors and 1 million ft. Belden wire.
District Offices:
Gary Castelluccio & Assoc., 85 E. 38th St., Paterson, NJ 07514
R. S. Enterprises

Ron Tunks Sales, 8560 N.W. 48th St., Ft. Lauderdale, FL 33321
Don Chamberlin & Assoc., 15100 Germain St., Mission Hills, CA
91345
MMS Inc. (International Sales), Rt. 5, Box 1305, Hwy. 36, N. Lake
Geneva, WS 58147

CURRENT CABLE CO., INC., 1801 W. Diversey Pkwy.,
Chicago, IL 60614 Tel.: 312-472-7790
1-800-821-2432

President: Arthur Shaiman
Sales Manager: Bernard Lewis
Products: cables for burglar and fire alarm systems, communications
and control systems, direct burial and low voltage/low cost E-Series
multi conductor and zip cord cables.

DABURN ELECTRONICS & CABLE CORP., 70 Oak
St., Norwood, NJ 07648 Tel.: 201-768-5400

President: Howard Danziger
Sales Manager: Randy Hibshman
Products: wire and cable, shrink tubing, retractile cords, electronic hard-
ware, cable assemblies, shielded braid, lacing cord, insulators, plugs,
jacks, terminals, modular cords.
Sales Representatives:
Associate Marketing, 4204 High Summit, Dallas, TX 75234
Effective Marketing, P.O. Box 44180, Fulton Indust. Station,
Atlanta, GA 30336
Hendrickson Co., 766 Country Way, S. Scituate, MA 02060
Markar Sales, 325 Walnut Ave., Elgin, IL 60120
Galaxie Sales, 1340 E. Katella Ave., Anaheim, CA 92805

DELTA WIRE & CABLE, 1900 Marquette St., Box 833,
N. Chicago, IL 60064 Tel.: 312-473-4990

President: Matt Coleman
Sales: Larry Smith and Perry Stein
Products: wire and cable for audio, telephone, electronic and electric
products.

ELECTRICAL CONDUCTORS, INC., 2500 Common-
wealth Ave., North Chicago, IL 60064
Tel.: 312-689-9090

President: Allan Coleman
Executive Vice President: Jim Coleman
Vice President, Marketing: Kerry Glicken
Products: wire and cable for security, sound and electronics.

FAMOUS TELEPHONE SUPPLY CO., P.O. Box 2172,
Akron, OH 44309 Tel.: 216-762-8811
800-321-9122

President: J. Blaushild
General Manager: William Brannon
Products: wire and cable, general hardware, apparatus; paging equip-
ment; power equipment; protection devices; tools, splicing equipment;
closures; compounds; couplers and peripheral devices, plenum cable.

IDEAL WIRE PRODUCTS INC., Lorum St., Tewks-
bury, MA 01876 Tel.: 617-851-4541

President: Robert T. Leahy
Products: engineered cables for the intercom and sound contractor.

KING WIRE & CABLE CORP., 179-45 110th Ave.,
Jamaica, NY 11434 Tel.: 212-657-4422
800-221-0144

President: L. Dorfman
Sales Manager: Robert Dorfman
Products: full range of electronic and electrical wire and cable. Includes
gauges from 50 A.W.G. to 1000 MCM and constructions from single
conductor to over 100 pairs in stock in PVC, Teflon, TPR, Polyethylene,
Polypropylene and many other materials.

LCA SALES CO., 76 Main St., Tuckahoe, NY 10707
Tel.: 914-961-4700
800-LCA-REPS (outside NY)

President: Joel H. Schwartz
General Manager: R. R. Sherwood
Products: manufacturers' representatives for: Blonder-Tongue, BES,
Carol Cable, Eaton Dekoron, Centex, Harrington, M/A-Com
Video/Data, N.I.T., Panasonic CCTV, Reliable Security, Siedle,
University, Videoscope Quadravision.
See full listing under **Alarm, Security & Life-Safety Equipment**.

LEE DAN COMMUNICATIONS, INC., 155 Adams
Ave., Hauppauge, NY 11788-3699
Tel.: 212-886-3000, 516-231-1414, Telex: 960 020

President: Leon Goldberg
Sales Manager: Lawrence Goldberg
Chief Engineer: Ted Jurgens
Products: multi-conductor intercom wire and cable, including special
purpose cables for CCTV and music systems.
See full listing under **Apartment House/Hi-Rise Intercoms**.

MARSHALL ELECTRONICS INC., P.O. Box 2027,
Culver City, CA 90230 Tel.: 213-390-6608

President: Henry Shultz
Sales Manager: Leonard Marshall
Products: MOGAMI Superflexible microphone, video, audio, computer
and multi-conductor cables. TAJIMI electronic connectors for audio,
video and broadcasting communications. Video, speaker and intercon-
nect cables.

MUSIC SUPPLY CO., INC., 809 Madison, Dallas, TX
75208 Tel.: 1-800-527-1522
Texas call collect: 214-946-8450

President: W. E. Brown
Products: EASY-KARY™ wire reel holders. Holds spools of wire and
cable for easy reeling off on job site. All components stow in hollow
frame. Takes up no room in truck. 30 days free trial.

MUSIC SUPPLY CO., INC., 809 Madison, Dallas, TX
75208 Tel.: 1-800-527-1522
Texas call collect: 214-946-8450

President: W. E. Brown
Products: Push-Pull rods. Set of twenty, lightweight, aluminum alloy,
5½ oz. per rod. Joins together for 45 ft. span. Pushes or pulls wire
or cable through impossible places. 30 days free trial.

MUSIC SUPPLY CO., INC., 809 Madison, Dallas, TX
75208 Tel.: 1-800-527-1522
Texas call collect: 214-946-8450

President: W. E. Brown
Products: extension cords. Three conductor with grounding plugs, 3
feet and 10 feet, U.L. listed.

NATIONAL ELECTRIC CABLE, 1730 Elmhurst Rd.,
Elk Grove Village, IL 60007 Tel.: 312-593-8100

President: R. G. Sass
General Manager: Don McGuire
Sales Manager: Harry Reed
Products: electric and electronic cable and assemblies; custom, mold-
ed, fibre optic, coiled cords, coaxial, computer, audio/video and
custom connectors.
District Offices:
Jeff Cook, 16566 S.W. 72nd, Portland, OR 97223
Ron Sass, 4530 S. Decatur St., Englewood, CO 80110
Eric Pierce, 1414 West Belt N., #105, Houston, TX 77043
Greg Dunn, 3475 Investment Blvd., Hayward, CA 94545

**QUABBIN WIRE & CABLE, INC., 10 Maple St., Ware,
MA 01082 Tel.: 413-967-6281**

President: Paul Engel
Sales Manager: Joseph Cooper
Chief Engineer: Thomas Copp
Products: cables used in the areas of computers, instrumentation, alarm/security, communications and control systems, multi conductor and twisted pairs, shielded and unshielded.

**REEMEE WIRE PRODUCTS CORP., 41 Bridge St.,
Florida, NY 10921 Tel.: 914-651-4431**

President: Elias Muhlrud
Sales Manager: Kenneth Pimental
Products: plenum cables for all NEC codes—electronic PVC wire and cable, coax, audio, data, RS 232, instrumentation, assemblies, fiber optic cables and assemblies.

**SAXTON WIRE AND CABLE PRODUCTS, INC., 215
N. Rt. 303, Congers, NY 10920
Tel.: 914-268-6846**

President and Chief Engineer: A. Abbo
Products: wire and cable—coaxial, multi-conductor, fire alarm, burglar alarm, power limited, telephone, sound and speaker, TV-MA TV-CATV wire, and plenum cable.
District Offices:
7157 Paramount Blvd., Pico Rizer, CA 90660
P.O. Box 1623, Pleasanton, CA 94566

**STANDARD WIRE & CABLE CO., 2345 Alaska Ave.,
El Segundo, CA 90245 Tel.: 213-536-0006
800-447-0006, 800-821-5276 (Outside CA)**

Chairman of the Board: Dick Hampikian
President: Russ Skrable
Vice President: Jerry Gaither
Sales Manager: Bruce Boisvert
Products: all types of electronic, electrical and fiber optic wire and cable serving the entire security, communications and computer systems marketplace.
District Offices:
1-95 Corporate Park, 33 Plan Way, Bldg. A, Warwick, RI 02886
2200 Westchester Pike, Ste. B-5, Broomall, PA 19008
14291 East Fourth Ave., Ste. 218, Aurora, CO 80011
Landmark Bank Bldg., 2201 North Collins, Ste. 200, Arlington, TX 76011
3132 West Thomas Road, #401, Phoenix, AZ 85017
106 South Fairbank St., Addison, IL 60101
1101 San Antonio Road, #405, Mountain View, CA 94043
6320 Riverdale, Ste. A, San Diego, CA 92120
14040 N.E. Eighth Ave., Ste. 217, Bellevue, WA 98007

**TELEDYNE THERMATICS, P.O. Box 909, Elm City,
NC 27822 Tel.: 919-236-4311**

President: Roy L. Inscore
Vice President, Sales: Franklin B. Brice
Chief Engineer: William D. Strickland
Products: high-temperature fluoropolymer insulated wire and cable, UL-classified for use on telecommunications and data communications systems. Trademark Plenair®
District Offices:
Claude Booth & Associates, Inc., 1925 North Harlem Ave., Chicago, IL 60635
R. F. Carlson Co., 1520 Ringling Blvd., Sarasota, FL 33577
Rothkopf & Assocs., Inc., 8721 Manchester Rd., St. Louis, MI 63144

Carlyle Technical Sales, 1059 Andover Park East, P.O. Box 58999, Seattle, WA 98188
Elcon Michigan Sales, 28230 Orchard Lake Road, Suite 103, P.O. Box 2846, Farmington Hills, MI 48018
Paul Ericson & Assocs., Inc., 9001 E. Bloomingdale Freeway, Suite 99, Minneapolis, MI 55420
M/S Sales & Assocs., Inc., 7319 West Jefferson Blvd., Ft. Wayne, IN 46804
M/S Sales & Assocs., Inc., 1425 E. 86th St., Suite 3, Indianapolis, IN 46260
Marden Sales, 1032 Governors Road, Mt. Pleasant, SC 29464
Marden/Taylor Assocs., Inc., 105 Pickwick Road, Dewitt, NY 13214
Jet Wire & Cable, 2501 E. 28th St., Unit 117, Long Beach, CA 90806
Warren Mount Co., 4924 St. Elmo Ave., Bethesda, MD 20014
Warren Mount Co., 700-6 Fox Pavilion, Jenkintown, PA 19046
N. L. Pitch & Assocs., 1316 Motor Parkway, Hauppauge, NY 11787
R. D. Spooner Co., Inc., 2646 Andjon Drive, P.O. Box 20452, Dallas, TX 75220
R. D. Spooner Co., Inc., 13333 Chrisman-Building H, Houston, TX 77039
Southern States Agency, P.O. Box 2746, Norcross, GA 30091
Del Steffen & Assocs., Inc., 69 Alpha Park, Cleveland, OH 44143
Del Steffen & Assocs., Inc., 355 W. Main St., Lexington, OH 44904
Del Steffen & Assocs., Inc., 1201 East David Road, Dayton, OH 45429
Chet Nowasacki, 100 Grove Street, Worcester, MA 01605
Wilco Wire and Cable Co., Inc., 1921 Las Plumas Ave., San Jose, CA 95133
High Tech, 3106 W. Thomas Road, Suite 1103, Phoenix, AZ 85017
R. F. Mayo & Assocs., 1025 Mapleton Ave., P.O. Box 3223, Boulder, CO 80307
International Fasteners Ltd., 21 Constellation Court, Rexdale, Ontario, Canada M9W 1T4
Chenault & Assocs., P.O. Box 902304, Dallas, TX 75390

**TW COMCORP, 122 Cutter Mill Rd., Great Neck, NY
11021 Tel.: 516-482-8100**

President: Ed Goodstein
Sales Manager: Thomas Pazaras
Chief Engineer: Gary Martellucci
Products: wholesale distributor of communication wire and cable; installation supplies; station apparatus; telephone equipment; computer and CATV products; tools; hardware.
District Offices:
Tom Pazaras, 122 Cutter Mill Road, Great Neck, NY 11021
Charles Lilly, 11775 Dunlap Industrial Blvd., Maryland Heights, MO 63043
Rustine Rizzio, 1715 W. Cortland Ct. Unit 2, Addison, IL 60101
Barbara Mancuso, 780 Main Street, Simpson, PA 18407
Sid Lieberman, 5750 Edgewater Drive, Orlando, FL 32810

**WEST PENN WIRE CORP., P.O. Box 762, Washington,
PA 15301 Tel.: 412-222-7060, 800-245-4964**

Vice President: Donald J. Hastings
Sales Manager: Louis Valente
Products: wire and cable for the total communication systems market; specializing in plenum (non-conduit) cables, fire alarm, CCTV, co-ax for MATV and security, health case cables.

**WIREWOKS CORP., 380 Hillside Ave., Hillside,
NJ 07205 Tel.: 201-686-7400**

President: G. J. Krulowicz
Sales Manager: Larry J. Williams
Products: microphone cables and microphone multicable assemblies in a wide range of stock sizes or in any size and configuration by special order; microphone cable tester and audio accessories.

The Complete Sourcebook of Products, Suppliers, and Manufacturers

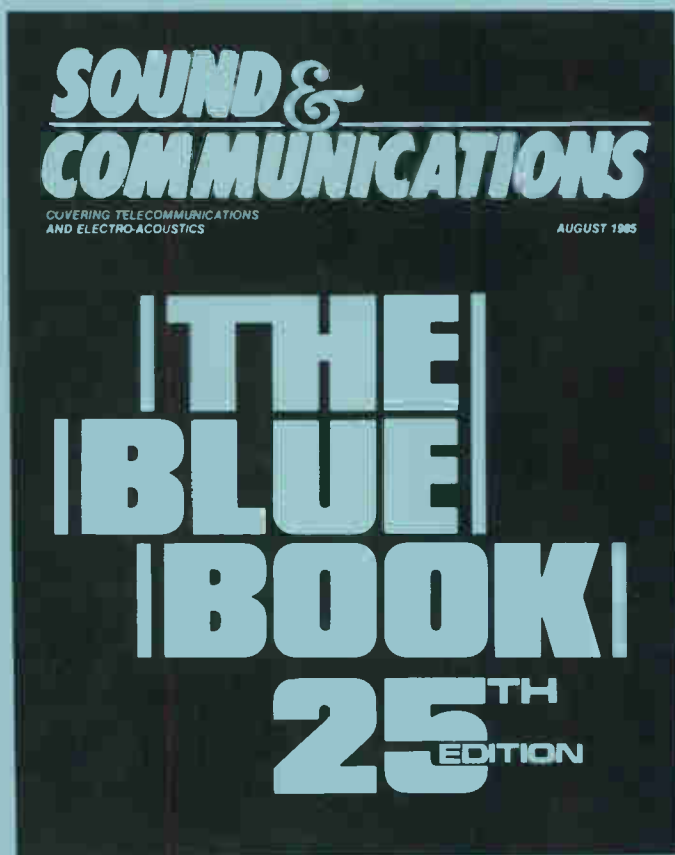

This 25th edition of the Sound & Communications Bluebook is the purchasing directory for the entire sound contracting community.

*For additional Bluebook copies at \$10 each,
Send your check or money order to:*

**Circulation Department
Sound & Communications
220 Westbury Ave.
Carle Place, NY 11514
(516) 334-7880**

***SOUND &
COMMUNICATIONS***

is not just a magazine, it's an industry.

TRADE NAME **INDEX**

The following list of trade names used by manufacturers for their products is derived from data completely supplied by the manufacturers. Trade Names are in **BOLD TYPE**. Addresses may be found in the individual Blue Book listings. See the Manufacturers' Index, on Page BB-4.

- ACCENT I**
Pyle Industries, Inc.
- ACCESSIT**
Connectronics Corporation
- ADCO INTERCOMS**
Atkinson Dynamics
- ADVANTAGE**
The Valley People
- AEI**
Audio Environments Inc.
- ALTECOM**
Altec Lansing
- AMBICON**
ProTech Audio Corporation
- AMERICAN ACOUSTICS**
American Acoustics
- AMPLICALL**
Rauland-Borg Corporation
- AMPLICOLUMN, AMPLIVOICE**
Paso Sound Products, Inc
- AMPTECH**
LT Electronics Ltd.
- AUDIO LINE**
Audio Accessories, Inc.
- AUDIO MASTER**
Tape-Athon Corporation
- AUDIO-TECHNICA**
Audio-Technica U.S., Inc.
- AUDIO VOICE**
Paso Sound Products, Inc.
- AUDITEL**
Edcom, Inc.
- AUTO TEN**
Protech Audio Corp.
- BOGEN®**
Bogen
- BOGEN-PHONE**
Bogen
- BUSINESSCOM™**
TIE Communications, Inc.
- CALL-A-NURSE**
Rauland-Borg Corporation
- CANATATA**
Sound Products/3M
- CASCADE 400**
Teltone Corporation
- COMMUNITEL™**
Bogen
- COMPACT 20**
Paso Sound Products, Inc.
- "COMPLIMITER"™**
Spectra Sonics
- COMPUCOM**
Paso Sound Products, Inc.
- DATUS™**
Reach Electronics, Inc.
- DIRECTORY PLUS**
Radionics, Inc.
- DISPLAYCOM**
Radionics, Inc.
- DMR**
Mackenzie Laboratories, Inc.
- EKTACOM**
Fisher Berkeley Corporation
- ELECTROTONE**
Paso Sound Products, Inc.
- ENHANCER**
McGohan Electronics, Inc.

EXES
TOA Electronics, Inc.

FREEDOMIKE®
Lectrosonics

GAIN BRAIN II
Valley People, Inc.

GALAXY AUDIO
Galaxy Audio

GREAT BRITISH SPRING
Connectronics Corporation

THE HANDLERS
Paso Sound Products, Inc.

HARMONIZER
Eventide, Inc.

HY-GAIN
Telex Communications, Inc.

HI-TEK
Bogen

HORIZON
Pyle Industries, Inc.

HOT SPOT
Galaxy Audio

INDESTRO
Jeron Electronic Systems, Inc.

INSTRUMAX II
Cetec Vega

INTEGRA III
Protech Audio Corporation

JERON
Jeron Electronic Systems, Inc.

KEY TECHNOLOGY
Connectronics Corporation

KIT PAGER
Spantel Corporation

KUDOS
Connectronics Corporation

LANDCOM
Telex Communications, Inc.

LEE DAN®
Lee Dan Communications, Inc.

LEKTRON
Paso Sound Products, Inc.

LIFESTYLE
Seeburg Music Satellite Network

MAGNIPHONE MAX
Melco Labs, Inc.

MEO-TEK
Engineered Electronics, Inc.

MEGAVOICE
Paso Sound Products, Inc.

MESSAGE BANK™
Solid State Systems, Inc.

MESSENGER II
Tape-Athon Corporation

MG
MG Electronics

MINI-MAC
Mackenzie Laboratories, Inc.

MOGAMI
Marshall Electronics, Inc.

MULTI-GRAPHIC™
Bogen

MUSIFLEX
Connectronics Corporation

NEWVICON
Panasonic Industrial Inc.

ORATOR III
Cetec Vega

PASO
Paso Sound Products, Inc.

PHI DECK
PHI Technologies, Inc.

PLENAIR®
Teledyne Thermatics

PRECISION ELECTRONICS
Grommes Precision Electronics Inc.

PRO, PRO PLUS
Cetec Vega

PRO SPOT
Galaxy Audio

PYLE DRIVER
Pyle Industries, Inc.

PZM®
Crown International

TRADE NAME

INDEX

- RAMSA**
Panasonic/Pro Audio Products
- RAYMER**
Cetec Raymer
- RESPONDER**
Rauland-Borg Corporation
- REVOX**
Studer Revox Inc.
- SECK**
Connectronics Corporation
- SLIMLINE**
Pyle Industries, Inc.
- SONALERT® AUDIBLE SIGNALS**
Mallory Capacitor Company
- SOUNDCASTER**
Paso Sound Products, Inc.
- SOUND DIRECTOR®**
Argos Products
- SOUND SPHERE**
Sonic Systems, Inc.
- SOURCE**
Pyle Industries, Inc.
- SPACE STATION**
Ursa Major, Inc.
- SPECTRUM MASTER**
Rauland-Borg Corporation
- SPECTRA SOUND**
Spectra Sound
- SPEECH DIRECTOR®**
Argos Products
- STUDIO 1000**
Yesco Foreground Music
- STYLE "E"™**
Lee Dan Communications, Inc.
- SUPER CABLE**
Audio-Technica U.S., Inc.
- TEK-CARE,™ TEK-COM,™**
TEK-DOOR,™ TEK-ENTRY,™
TEK-SELECT,™ TEK-SOUND,™
TEK-TRIO,™ TEK-VIEW™
Lee Dan Communications, Inc.
- TEK-LIGHT**
Berk-Tek, Inc.
- TELE HOLD**
Melco Labs, Inc.
- TEL TRAK 2**
Radionics, Inc.
- TIME ALIGNED™**
UREI
- TOUR KITS**
Edcor
- T-310**
Teltone Corporation
- TRIDEX**
Ring Communications
- TR SERIES**
Paso Sound Products, Inc.
- "TW"**
RTS Systems Inc.
- VAN-GUARD®**
Lee Dan Communications, Inc.
- V BAND**
V Band Systems, Inc.
- VECTA, VEGA**
Cetec Vega
- VIDICON**
Panasonic Industrial
- VIP® II**
Reach Electronics, Inc.
- VISACOM**
A.E. Electronics Corporation
- VOICE DIRECTOR®**
Argos Products
- VOICE-MATIC**
Industrial Research Products, Inc.
- VOICEPAC**
Xtel
- VOICE/TONE**
Atlas Sound
- Z-MAC**
Mackenzie Laboratories, Inc.

Before you choose speaker components, listen to Tom Hidley.

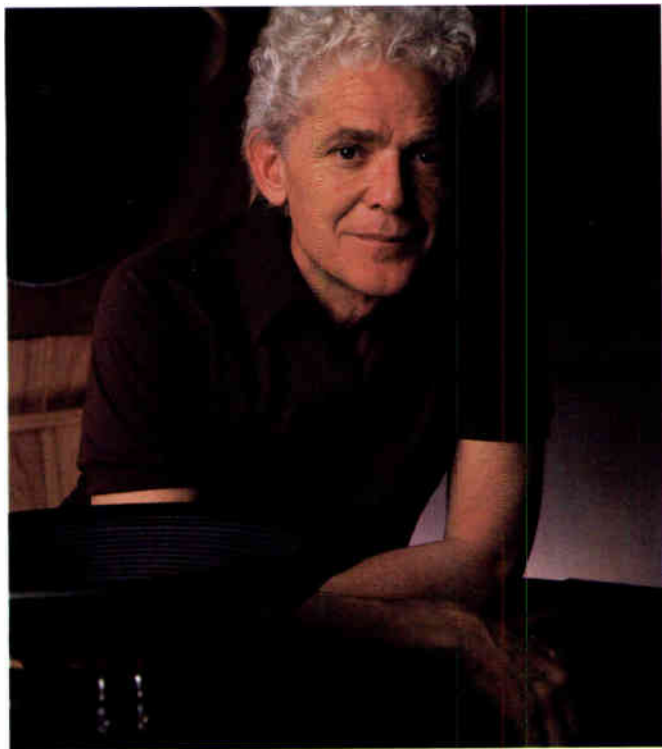

It's a good bet that of all the people reading this ad, 10 out of 10 know the name Tom Hidley.

One engineer we spoke with called him "the best engineer in the world." Another described him, a bit more colorfully, as "pretty damn hot."

But most of you know him as perhaps the foremost studio designer in the world today.

The reason we bring this up is that the speaker components Tom prefers for his clients are the ones we make.

TAD.

"I WILL USE ONLY TAD, UNLESS A CLIENT DEMANDS OTHERWISE."

In fact, he does more than prefer them. Insists Tom, "I will use only TAD, unless a client demands otherwise."

We, of course, are delighted that Tom feels so strongly. But it should also be of more

than passing interest to you, since you want the speaker components you use to be the best.

And on the subject of "best," Tom has some very definite opinions about TAD. "They are the most state-of-the-art, consistent quality products today. Nothing touches their performance, honesty, stability and transient response."

"NOTHING TOUCHES THEIR PERFORMANCE, HONESTY, STABILITY AND TRANSIENT RESPONSE."

There are some sound technological reasons for such enthusiasm. For example, we use only pure beryllium diaphragms in our compression drivers for high speed sound propagation and exceptional efficiency. We also assemble every component by hand, with tolerances as close as a millionth of an inch. And we use exhaustive and esoteric evaluation techniques — such as the Doppler laser and anechoic chamber — every step of the way, from original design right through to manufacturing.

"TAD MAKES THE BEST SOUNDING COMPONENTS I'VE EVER HEARD."

But for Tom, that's all frosting on the cake. "At the end of the day," he says, "it's what comes out of that speaker that determines success or failure. No matter what it measures, it all comes down to what it sounds like. TAD makes the best sounding components I've ever heard."

If you're in the market for professional speaker components, for yourself or a client, we hope you'll seriously consider what Tom Hidley has to say about TAD.

And thanks for listening.

TAD Technical Audio Devices

Professional Products Division of Pioneer Electronics (USA) Inc.,
5000 Airport Plaza Dr., Long Beach, CA 90815. (213) 420-5700.



legislation



deliberation



observation

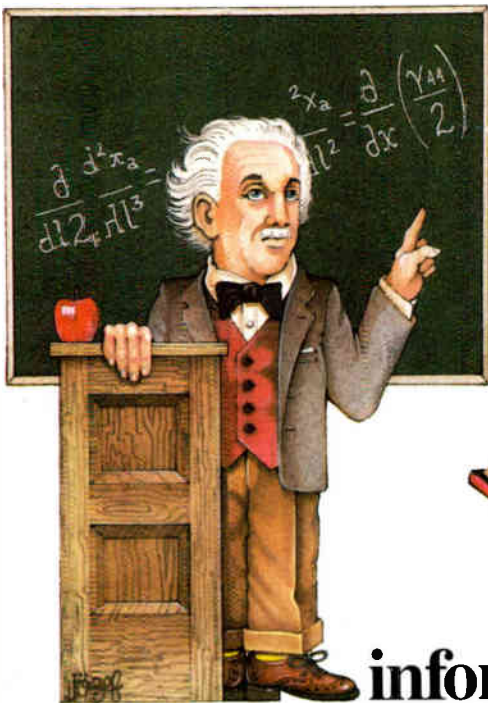

information



conversation

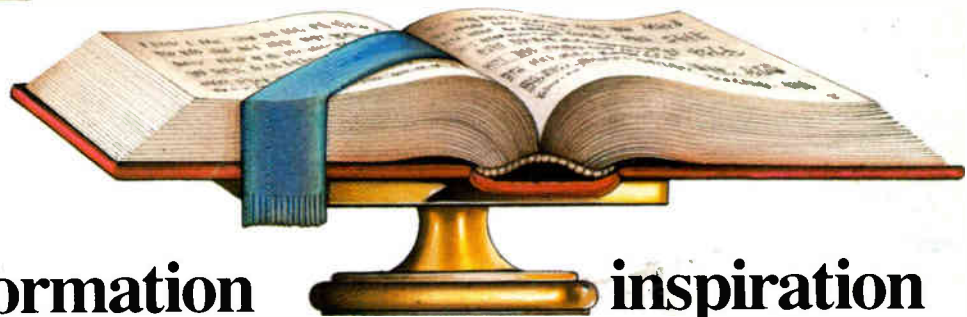

inspiration

The Shure Automatic Microphone System... wherever microphones and people gather.

AT&T World Headquarters. The Pentagon. Bally Casino. St. Peter's Cathedral. Alberta (Canada) Provincial Courts. Ft. Wayne City Council. Wherever speech-related multi-mic systems are needed, the Shure Automatic Microphone System (AMS) provides the perfect solution. It combines microphone, mixer and logic technology in a totally integrated package.

The AMS System turns on and off automatically with the sound source—smoothly, quickly and quietly. Unlike other multi-mic systems, set-up is quick and simple with no need for complicated readjustment after the initial installation. Add-on options include the AMS 880 Video Switcher

Interface. It's these features that make the Shure AMS the number one choice for multi-mic applications—from security monitoring to churches, courtrooms, conference rooms, legislative chambers and broadcast studios.

Shure's Automatic Microphone System—the right mic, wherever microphones and people gather.



For more information, write or call Shure Brothers Inc., 222 Hartrey Ave., Evanston, IL 60204, (312) 866-2553.

SHURE

THE SOUND OF THE PROFESSIONALS®...WORLDWIDE

Reader Service #286