

EDISON Phonograph Monthly

EXACT REPRODUCTION

By
Wendell Moore

First Edition
November 1977

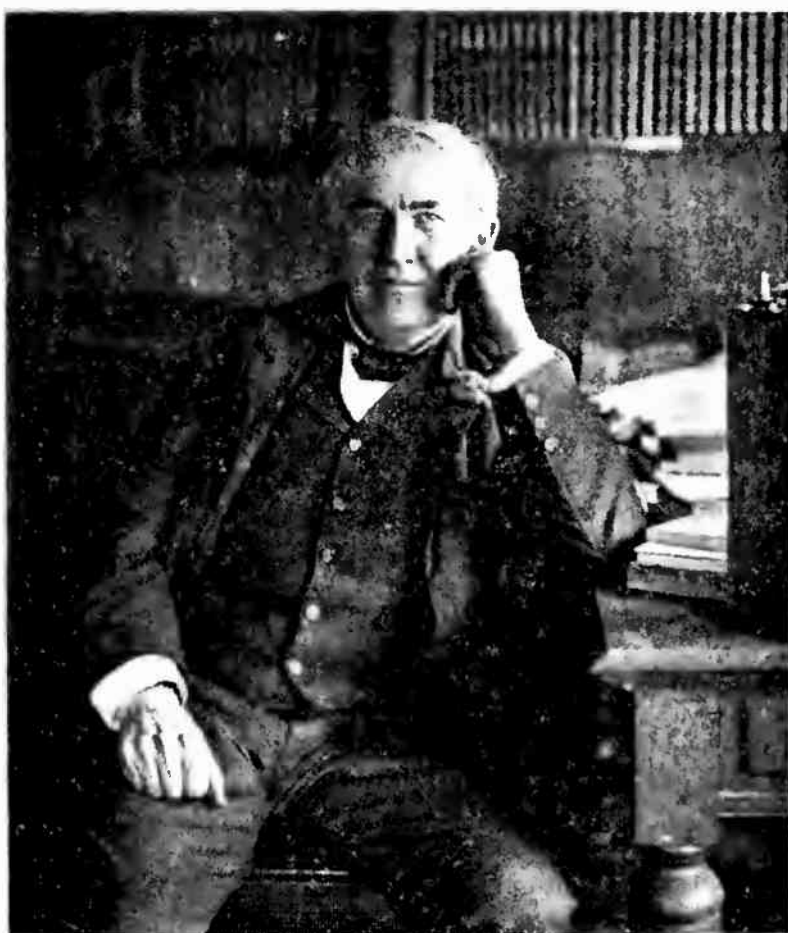

Thomas A. Edison

*Reprinted By
Pennant Litho, Inc.
Louisville, Kentucky*

1905 - 06 - VOLUME III, NUMBER I

BOOK NUMBER 500

Wendell Moore

MIL 155
. 59
. E3
RSS

PREFACE

March 1905 – Third year of the Edison Phonograph Monthly Bulletins. From all appearances, Edison is entrenched as undisputed leader in the industry and not especially worried about his competition. However, his wisdom is rubbing off on his department heads and they are refining the organization as well as improving products – just to be sure they retain this position. The Home, Standard and Gem are improved to the point that all they need is 4 minute gearing. The business machine is put on the market with its own marketing organization, records have been discontinued that are not selling, coin slot machines are a thriving section of business, phonograph clubs have been formed, large quantities of machines are being sold and grand opera records have been put on the market. In short – a foundation has been built that should last for decades. This is what we read – what we do not read, are the reversals; such as – Cal Stewart leaving to go out on his own. This made it necessary to strike 28 of his records from production. It appears that this bothered them only a little – just enough to replace him with Andrew Keefe. Keefe was not the same though, he only made a few records.

The National Phonograph Co. is comfortable now – unaware that new machines will be necessary in a very short time and also unaware of the need to consider marketing a low cost disc machine. This will be discussed at great length within the Edison gate later on, and right or wrong, Mr. Edison's decision will be final.

We are very fortunate to be able to watch the history of the phonograph unfold – and our gratitude must go out to “Mac” McMillion.

This book is dedicated to M. R. McMillion and the thousands of phonograph collectors who are active in preserving the true Edison phonograph story – historically and mechanically.

My thanks also to William R. Rawson and Edward Orbann, of Thomas A. Edison Industries, for their favorable comment in their letter of October 15th, 1965.

Wendell Moore



10241
27 JAN 78

TECHNICAL INDEX

Publication began March, 1905, so the index runs from March, 1905, through February, 1906, coinciding with the contents of book.

	MONTH	PAGE
— A —		
— B —		
Bijou Phono	Mar	4
Business Machine	Aug	3
Balmoral	Nov	3
— C —		
— D —		
— E —		
Excelsior Phono	Mar	4
— F —		
— G —		
Gem Phono	May	3
	Oct	7,13
	Nov	4
	Dec	6,7
— H —		
Home Phono	Mar	12
	April	4,6,10,12
	May	3
	June	5,13
	Aug	8
	Oct	7,10,12,13
	Nov	4
	Dec	6,7
— I —		
— J —		
— K —		
— L —		
— M —		
Majestic Phono	Mar	4
— N —		
— O —		
— P —		
Phonogram	Mar	4,5,12
	May	13
	June	12
	July	5
	Aug	4
	Sept.	6,12
	Oct	5,10
	Dec	9
	Feb	5
— Q —		
— R —		
Reproducers Model C.	June	3
Reproducers Model B.	June	3
Rookwood Finish.	Nov	13
— S —		
Standard Phono	Mar	12
	April	4,5,6,10
	May	3
	June	12

	Aug	7
	Oct	7,10,11,12,13
	Nov	4,11
	Dec	6,7
	Jan	13
	Feb	6
Sapphires.	May	4
	Dec	5
Shelf System.	Aug	5
— T —		
Triumph Phono	Mar	12
	April	4,11,12
	May	3
	Oct	7
	Dec	6,7
— U —		
Uncle Josh	Mar	6
— V —		
Vernis Martin	Nov	13
Victor (Edison)	Dec	3
— W —		
Windsor Phono	Mar	4
— X —		
— Y —		
— Z —		

HIGHLIGHTS OF E.P.M. NO. 1, 1903-1904 PUBLISHED IN LIMITED EDITION OF 1,000 COPIES

- No. 1 March First issue of E.P.M., Record list — April 1903.
Portrait of Mr. Edison — December 27, 1902.
Lambert loses suit to Edison.
The Phonogram discontinued Dec. 1902.
- No. 2 April Purpose of E.P.M.
Record list — May 1903.
Dealers surplus of 14" horns.
Solution to cure reproducer blast.
- No. 3 May Record list — June 1903,
New reproducer lift for Standard model.
- Great issue! Dealer comparison — Disc versus cylinder.
Reporter story — Edison's favorite invention.
- No. 4 June Record list — July 1903.
Editorial — What the world has lost.
Future of the Phonograph.
- No. 5 July Record list — August 1903.
New Megahorn approved — introduced in June.
Why Bill Bailey returned home ???
Worlds largest horn to date.
Patents to date — 791!
- No. 6 Aug. Record list — September 1903.
Process for making Edison Gold Moulded records.
Cut-away drawing of C reproducer and recorder.
- No. 7 Sept. Record list — October 1903.
Good! New style repeating attachment.
Edison Kineoscopes and films.
- No. 8 Oct. Record list — November 1903
Uncle Josh writes a book.
One record played 1525 times.
- No. 9 Nov. Record list — December 1903.
New style horn crane.
8 pages of advertising.
- No. 10 Dec. Record list — January 1904.
E.P.M. cancels all advertising.
Record played 3000 times.
- No. 11 Jan. Record list — February 1904.
A slap at disc machines.
A device to play the Phonograph at sea.
- No. 12 Feb. Record list — March 1904.
How about having a Phonograph party?
Queen Victoria's Phonograph message.
Cotton wrapping discontinued - peg box instead.
Mammoth Phonograph horn 21 ft long weight - 420 lbs.

**Highlights of E.P.M.
Volume II, 1904 - 1905**

- No. 1 March. Record list – April 1904.
E.P.M. – a success in its first year.
A banquet for Mr. Edison.
Concert machine can now play small records.
A new shaving machine.
- No. 2 April. Record list – May 1904.
Musicians no longer antagonistic towards Phonographs.
“My Phonograph” – A long poem.
A record incident.
- No. 3 May. Record list – June 1904.
Edison to exhibit at Louisiana Purchase Exposition.
Bicycle and Phonograph popularity compared.
- No. 4 June. Record list – July 1904
Important Triumph mounting attachment.
Triumph speed indicator introduced.
- No. 5 July. Record list – August 1904.
Title on record for first time – in new peg box.
Edison opens office in Great Britain.
- No. 6 Aug. Record list – September 1904.
Edison records reduced in price.
Photo of new box with countersunk ends.
Edison introduces Windsor and Majestic coin slots.
- No. 7 Sept. Record list – October 1904.
A novel record cabinet put on the market.
- No. 8 Oct. Record list – November and December 1904.
Model D repeating attachment for Home; etc.
The marvels of the Phonograph.
- No. 9 Nov. Record list – November and December 1904.
List of printed matter by Edison.
- Good issue! Wax records – Numbers and dates.
The start of Gold Moulded Records.
- No. 10 Dec. Record list – January 1905.
List of Special Records.
- No. 11 Jan. Record list – February 1905.
Edison declines Gold Medals at St. Louis Worlds Fair.
More on Model D repeating attachment.
Good dealer display photos.
- No. 12 Feb. Record list – March 1905.
Special Hebrew record list.
Tips on regulating speed of machines.
Story of the Phonograph Palace.
Phonograph music by telephone.
Edison proposal to exchange obsolete reproducers.

EDISON Phonograph Monthly

PUBLISHED FOR TRADE USE ONLY BY
THE NATIONAL PHONOGRAPH CO.

VOL. III.

ORANGE, N. J., MARCH, 1905.

No. 1.

NATIONAL PHONOGRAPH CO.

ORANGE, N. J.

NEW YORK: 31 UNION SQUARE.

CHICAGO: 304 WABASH AVENUE,

SAN FRANCISCO: 786 MISSION STREET.

NATIONAL PHONOGRAPH CO., LTD., 25 CLERKENWELL
ROAD, LONDON, ENG.

EDISON PHONOGRAPHS AND RECORDS.

All communications to THE PHONOGRAPH MONTHLY
should be addressed to the Advertising Department,
Orange, N. J.

C O N T E N T S

Another Great Month.....	1
Concerning Special Outfits.....	3
Notice to the Trade.....	3
Sample Records Must Not be Sold.....	3
Our New Offices in New York.....	3
Coin-Slot Catalogues.....	4
Sign Your Orders.....	4
Let the Public Know That You Carry the Goods.....	4
Printed Matter.....	5
Exchange Proposition Extended to March 15.....	5
Among the Jobbers.....	5
Records to be Cut from Catalogues.....	6
Cut on Freight Rates.....	7
Our Berlin Office.....	7
Caution Notice.....	7
Comments on April Records.....	8
Seventy-Two More Mexican Records....	10
The Phonograph—How it Helps Music Teachers.....	11
A Bellamy Dream Realized.....	11
About Record Cartons.....	11
The Phonogram.....	12
Two Years Old.....	12
Dealers' Advertisements.....	12
A Dealer's Circular.....	13
It Pleases All.....	13
List of Suspended Dealers March 1.....	14
Jobbers of Edison Phonographs and Re- cords.....	15

ANOTHER GREAT MONTH.

The advance orders for March Records again exceeded the orders for any similar month in the history of the company. So heavy were these orders that, in spite of our splendid facilities for making Records, and the fact that the plant was running day and night, we were not able to ship the March Records until a week later than the time set down in our regular schedule, and even then we were compelled to make short shipments on a number of titles for which the demand was heavier than for the average of the selections. No other evidence than this demand can be needed to show the tremendous and ever-increasing popularity of Edison Phonographs and Edison Gold Moulded Records. The orders for Phonographs, too, have kept pace with the demand for Records. All of this is shown in the orders now on file. Then reports from Jobbers and Dealers in all parts of the country tell the same story of the great increase in popularity of Edison goods. Stocks that a year or more ago were large enough to last for a period of time, are now hardly received before they are disposed of. This is causing a readjustment of the plans of Jobbers and Dealers. It has been found in the past few months that larger and more complete stocks must be carried to hold patronage and supply the demand for Edison goods. Everyone is recognizing that the larger business has come to stay, and all are planning to take care of it. All this is true of those now in the business. At the same time our correspondence is very heavy with firms writing for Jobbers and Dealers' discounts, terms and conditions. These firms have found that their competitors having the Edison line have an advantage over them, and they are anxious to handle Edison Phonographs and Records in order to get a share of the business.

THE ADVANCE LIST OF APRIL RECORDS APPEARS ON PAGE 2. ORDER FROM IT. NO OTHER ADVANCE LIST WILL BE ISSUED.

NEW EDISON GOLD MOULDED RECORDS. ADVANCE LIST FOR APRIL, 1905.

RECORDS listed below will be ready for shipment as near March 25th as possible, at which time Jobbers' stock orders, if received prior to March 10th, will be shipped. April Supplements will be forwarded to Jobbers with their stock order for Records. Retail Dealers should place stock orders with their Jobbers at once, to insure prompt shipment as soon as Jobbers' stock is received.

- | | | |
|------|---|---------------------------|
| 8953 | Al Fresco (<i>Intermezzo</i>) (<i>Victor Herbert</i>) | Edison Concert Band |
| 8954 | If Mister Boston Lawson Has His Way (<i>Cohan</i>) | Billy Murray |
| | <i>A "Frensicd Finance" topical song by the composer of "Yankee Doodle Boy,"</i>
<i>Orch. accom.</i> | |
| 8955 | Jasper, Don't You Hear Me Calling You (<i>Frantzen</i>) | Collins & Harlan |
| | <i>Coon male duct, Orch. accom.</i> | |
| 8956 | A Summer Dream (<i>Flath</i>) | Benzler & Nesbit |
| | <i>Bells and chimes duet, accompanied by the Edison Military Band.</i> | |
| 8957 | He's Me Pal (<i>Edwards</i>) | Miss Ada Jones |
| | <i>Character song, Orch. accom.</i> | |
| 8958 | In the Shade of the Old Apple Tree (<i>Van Alstyne</i>) | Irving Gillette |
| | <i>Descriptive song, Orch. accom.</i> | |
| 8959 | Panama Rag (<i>Seymour</i>) | Edison Symphony Orchestra |
| | <i>A popular Ragtime oddity.</i> | |
| 8960 | Birds of a Feather Flock Together (<i>Schwartz</i>) | Bob Roberts |
| | <i>Coon song, Orch. accom.</i> | |
| 8961 | Longing for You (<i>Morse</i>) | Byron G. Harlan |
| | <i>Sentimental song, Orch. accom.</i> | |
| 8962 | Magnet March (<i>Losey</i>) | Edison Military Band |
| 8963 | Farewell, Mister Abner Hemingway (<i>Schwartz</i>) | Murray & Roberts |
| | <i>Coon male duet, Orch. accom.</i> | |
| 8964 | Billy (<i>Barron</i>) | Harry MacDonough |
| | <i>Serio-comic song, Orch. accom.</i> | |
| 8965 | Schubert's Serenade (<i>Schubert</i>) | Hans Kronold |
| | <i>'Cello solo, Piano accom.</i> | |
| 8966 | Bunker Hill (<i>Von Tilzer</i>) | Harlan & Stanley |
| | <i>Descriptive selection, introducing a realistic Battle scene, Orch. accom.</i> | |
| 8967 | Grandfather's Clock (<i>Work</i>) | Edison Male Quartette |
| | <i>The old well-known song, Male Quartette, Orch. accom.</i> | |
| 8968 | How Can I Leave Thee (<i>Cramer</i>) | Samuel Siegel |
| | <i>Mandolin solo, with duet effect.</i> | |
| 8969 | My Little Dinah Lee (<i>Lemonier</i>) | Bob Roberts |
| | <i>Coon serenade, with Banjo accom. by Vess L. Ossman.</i> | |
| 8970 | When the Swallows Homeward Fly (<i>Abt</i>) | MacDonough & Biehling |
| 8971 | Yankee Patrol (<i>Meacham</i>) | Edison Concert Band |
| | <i>By the composer of "American Patrol," Patrol effect.</i> | |
| 8972 | Love's Sorrow (<i>Shelley</i>) | Harry Anthony |
| | <i>Sentimental song, Orch. accom.</i> | |
| 8973 | Ramblin' Sam (<i>Schwartz</i>) | Arthur Collins |
| | <i>Coon song, introducing comic descriptive effects, Orch. accom.</i> | |
| 8974 | Moonlight (<i>Serenade</i>) (<i>Moret</i>) | Edison Symphony Orchestra |
| | <i>By the composer of "Hiawatha."</i> | |
| 8975 | Parson Spencer's Discourse on Adam and Eve | Len Spencer |
| | <i>A Colored Preacher's sermon to his flock, introducing singing by the choir, and responses by the congregation.</i> | |
| 8976 | Where the Southern Roses Grow (<i>Morse</i>) | Edison Male Quartette |
| | <i>Male quartette, Orch. accom.</i> | |
| 8977 | Coax Me Medley | Edison Military Band |
| | <i>Introducing "Coax Me," "Won't You Fondle Me," "When the Harvest Moon is Shining on the River," "Can't You See My Heart Beats All For You," and "Mexico."</i> | |

Edison Gold Moulded Records are made only in Standard Size. Both Standard and Concert Records may be ordered from this list. Order by number, not title. If Concert Records are wanted, give the number and letter C.

CONCERNING SPECIAL OUTFITS.

Our present Agreement provides that where other goods, such as horns, horn-stands, carrying-cases, etc., are included with a regular Phonograph outfit, the price of the additional articles must be advertised separately and must be the same whether included with the regular-outfit or sold separately. This provision was made necessary in view of the fact that in some instances special outfits were advertised at prices only very little in excess of the list prices of the regular outfits, and a suspicion was created that in such cases the prices of the regular outfits were cut. To remedy this, it was provided that in every case the prices of the additional goods should be advertised separately. Recently a number of cases have arisen where Jobbers and Dealers have advertised special outfits in which the additional sundries have been listed far below cost, and in some instances at only a few cents. In these cases obviously there must be a considerable loss on the additional sundries. In any event, such a practice violates the Agreement in the respect that other goods are sold at less than current prices in order to induce the sale of Edison Phonographs or Records, and for this reason Jobbers and Dealers who had offended in this respect were suspended. We take this opportunity, therefore, of notifying all Jobbers and Dealers that in the event of any special outfits where it appears that the prices for the additional goods are below what would be a fair cost for the same, to thereby create a suspicion that special prices were being made to induce the sale of Edison Phonographs or Records, the Jobber or Dealer in question will be immediately suspended, pending an investigation in the matter. Where Jobbers or Dealers have any doubt as to the proper interpretation of our Agreement, or as to any question arising thereunder, we suggest that the matter be referred to us, rather than run the risk of temporary or permanent suspension. Such communications can be addressed either to the National Phonograph Company, or to our General Counsel, Mr. Frank L. Dyer, Orange, N. J.

NOTICE TO THE TRADE.**Nos. 7298 & 7333 also "Cut Out."**

The list of Records to be dropped from the catalogue, and whose manufacture is to be discontinued, as printed on pages 6 and 7, contains two more titles than given on the list mailed to the trade on February 17th. After the list had been sent out, it was found necessary to cut out No. 7298, "Daily Paper at Pumpkin Centre," and No. 7333, "The Lightning Rod Agent," by Cal Stewart. Jobbers and Dealers will note this addition to the "cut-out" list, and be governed accordingly.

SAMPLE RECORDS MUST NOT BE SOLD.

Jobbers are cautioned against allowing their sample Records each month to permanently leave their possession, or to be sold either to Dealers or to the public ahead of the receipt of their stock orders. The object in sending these samples to the trade was primarily to permit Jobbers to play them over and determine their possible selling qualities before placing their orders. Many Jobbers have, in turn, passed them from one Dealer to another for the same purpose. Although this was not part of the original plan, no objection has been made to it by us as long as the Records were only used by Jobbers and Dealers. Our attention has been called to a few cases, however, in which Jobbers have allowed the last Dealer hearing the Records to retain them and have them charged to his account. This is a distinct violation of the understanding under which the sample Records are being shipped, and any further violation of the same character will compel us to refuse to ship samples to the offending Jobber. We have no desire to be harsh in a matter of this kind, but it seems only fair to ask Jobbers to keep faith in a plan that was promulgated and is being carried out for their benefit.

OUR NEW OFFICES IN NEW YORK.

None of our Jobbers or Dealers visiting New York should fail to call at our new offices in the Metropolis Bank building at 31 Union Square, corner Broadway and 16th street. We moved into these new quarters on February 1st and are now fully settled. These new offices are more like those that we formerly occupied at Broadway and 26th street and 135 Fifth avenue. They are a great improvement over those just vacated at 83 Chambers street. The Metropolis Bank building is one of the most modern in the city and contains the finest equipments. Our offices are on the fourth floor. The fittings, furnishings and decorations are of an attractive and substantial character, the woodwork and furniture, in antique oak finish, harmonizing with the warm, rich color scheme and luxurious rugs. The rooms of the executive offices are light and pleasantly located, while the staff have ample accommodations. The city and foreign departments have also facilities denied them from lack of space in the old place on Chambers street. We are now in better shape than ever to handle the rapidly increasing demands of Edison Jobbers and Dealers.

COIN-SLOT CATALOGUE.

Copies of our new Coin-Slot Catalogue have just been mailed to all Jobbers, and copies will be mailed to Dealers in a few days. Under the new discounts on Coin-Slot Phonographs only Jobbers and Dealers who can buy in quantities can handle them to advantage. The trade has already been advised that the National Phonograph Company has decided to adopt an entirely new plan in selling the new Windsor and Majestic types of Coin-Slot Phonographs. It has been found that to instal Coin-Slot Phonographs and keep them in satisfactory operation requires more attention than the average Dealer can afford to give them. It was therefore decided that the proper exploitation of coin-slot machines could only be secured by having them handled by the company direct and a special department has been organized for that purpose. The company will solicit this class of business direct, will instal machines with its own men and will see that they are started in a proper manner. While it will not be formally responsible for the machines after they have been thus installed, and proper instructions given concerning their care and operation, it will always stand ready to remedy any serious trouble that may arise. It is intended that Edison Coin-Slot Phonographs shall have the attention that their merit warrants and the growing demand for them demands.

At the same time it was decided not to take the matter out of the hands of the trade entirely, but to allow discounts that would enable the larger Dealers to still handle them.

The Windsor type is operated by battery current and will be sold at \$80. The Majestic type is equipped for 110 volt direct current and will be sold at \$90. These prices will be subject to discounts as follows:

Less than 10 machines...	no discount
10 machines.....	10 per cent. off List
25 "	15 per cent. off List
50 "	20 per cent. off List
100 or more machines...	25 per cent. off List

Discounts on Windsor and Majestic types are not confined to Jobbers or Dealers, but are open to any purchaser. They are not cumulative nor does one purchase establish a discount on future orders. In each and every case orders must be placed for quantities above specified or discount quoted cannot be allowed.

Bijou and Excelsior Coin-Slot Phonographs, both of which are spring-motor types, will be sold at the same prices and same discounts as before.

In Canada an amount equal to the duty must be added to the selling prices of Coin-Slot Phonographs, as well as to those of all other goods.

Since but few Jobbers and Dealers can handle Coin-Slot Phonographs to advantage, only a small edition of catalogues has been printed, and only a limited number of extra copies can be supplied.

SIGN YOUR ORDERS!

The Sales Department complains that it has recently received several orders for Records from Jobbers that were not signed and the only identifying mark has been the envelope containing the order. When the envelope has been lost before the omission was discovered it has been necessary to call in the Sherlock Holmes of the department. Even he found one order too much for him last month. This order called for 2,525 Records and for the want of a clue the Sales Department was unable to acknowledge or execute it. The Jobber sending it is asked to "prove his property." Others are asked to see that their signatures are affixed to all orders before mailing them.

LET THE PUBLIC KNOW THAT YOU CARRY EDISON GOODS.

The advertising of the National Phonograph Company is now occupying full pages in most of the prominent magazines and proportionate space in a number of other publications of wide circulation. It is the most expensive and at the same time the most profitable advertising that we have ever done. We fully believe that it has had much to do with the great growth of the business in Edison Phonographs and Records in the past six months. Since the object of this advertising is to direct the attention of the public to the stores of our Dealers the latter will find it profitable and good business judgment to do such local advertising as will tell the people of their cities or towns that they are "the Dealers" and have the goods. This is now being done by many Dealers and they report that it is constantly increasing their business; others should lose no time in following their example.

In most places, space in local papers is not expensive. It is not always necessary to advertise in newspapers. Many Dealers get excellent results from mailing lists, sending out regular copies of the Record Supplement or the *Phonogram*. Others make up a list of prospective customers and mail them letters and printed matter until they get them interested. All of these methods are genuine advertising and all will be found profitable. No one nowadays disputes the statement that advertising pays.

PRICES OF EDISON RECORDS.

Edison Gold Moulded Records, standard size, are sold in the United States at 35 cents each, and in Canada at 40 cents each. The Canadian price is higher because of the duty. Edison Concert Records are sold at 75 cents each in both countries.

PRINTED MATTER.

A new colored hanger, "A Message from the Absent Lover," and a pretty little book-mark have just been mailed to the entire trade, together with the usual Record Bulletins, Record Supplements, and the *Phonogram*. Neither of these forms bear a form number, although the book-mark may be ordered as No. 205. A supply of both forms will be sent upon request to Jobbers and direct Dealers. Dealers buying through Jobbers should ask for a supply from the latter.

The spring edition of the catalogue of domestic Records will be ready for the use of the trade as soon after the shipment of April Records as circumstances will permit. It will be Form No. 670. As usual, we will edit orders for the present edition so as to make our supply last out and also so that Jobbers will not have a large number on hand when the new issue appears. The 221 titles just "cut out" will be omitted from this new catalogue.

With the appearance of the next Record catalogue we will have ready for the trade a new supply of Record Order Blanks. These are being reprinted so as to omit all the "cut out" numbers. Sheets A to D will be condensed into three sheets, A, B and C, and sheet S will be added so as to include the Mexican and Hebrew Records. The plan of assembling the sheets in sets will be abandoned, and will ask the trade, when placing orders, to state the number of each sheet required. We have found that the demand for each sheet varies considerably and causes waste.

ADVERTISING DEPARTMENT NOW AT ORANGE.

The Advertising Department is now settled in its new quarters at Orange, N. J., and rapidly recovering from the disturbing effects of tearing up at one place and locating at another thirteen miles away. As soon as plans can be perfected we expect to be able to give the trade a much more effective service in furnishing printed matter and in advertising the business. Correspondence pertaining only to advertising should be addressed direct to the department at Orange.

JULY AND AUGUST PHONOGRAMS WANTED.

Jobbers having on hand any copies of the *Phonogram* for July and August, 1904, without imprint, will confer a favor by advising the Advertising Department of the fact. We should like to buy back all the copies that can be had.

EXCHANGE PROPOSITION EXTENDED TO MARCH 15.

On page 6 is given a list of 222 Record titles that will be omitted from all future editions of the Record catalogues. The moulds of these Records are not in condition for good work, and as the demand for these selections is not sufficient to warrant the expense of making new masters and moulds, it has been decided to discontinue their manufacture.

Jobbers and Dealers having a quantity of these Records in stock may return them under the exchange proposition as contained in our letter, Form 646, to the trade, dated January 16, 1905.

Owing to additional Records which they may desire to return on account of this "cut out list," we will extend the time limit of exchange proposition, referred to in Form 646, from February 28 to March 15.

We especially desire the trade to understand that the time limit on the exchange proposition will positively close on March 15. Credit will be allowed on all return Records shipped by Jobbers or Dealers direct to us, and on all Records shipped by Dealers to Jobbers on or before March 15, provided that in all cases we are furnished with bills of lading showing that shipments were actually made on or before that date. This arrangement gives Dealers up to the last day in which to make shipments to Jobbers. It is advisable, however, to make shipments as much earlier as possible.

We also want to make it clear to the trade that this exchange proposition *docs not extend* to consumers. Dealers taking back Records on this or any other basis will be considered as violating their agreement, and will be subject to suspension.

AMONG THE JOBBERS.

The Omaha Bicycle Co., of 16th and Chicago streets, Omaha, Neb., have succeeded H. E. Fredrickson as Edison Jobbers in that city. The Troy Automobile Exchange has succeeded James Lucey as Edison Jobbers, at 359 Fulton street, Troy, N. Y. Cummings, Shepherd & Co., Fort Worth, Texas, have become Edison Jobbers during the past month. James K. O'Dea, Jobber at Paterson, has opened a branch store at Passaic, N. J. Theodore F. Bentel Co., of Pittsburg, have removed from 433 Wood street to 632 Liberty street.

W. W. Warner, a Dealer at Madison, Wis., recently sold an Edison Phonograph to the Hon. Robert M. LaFollette, three times Governor of Wisconsin, and at present United States Senator-elect of Wisconsin.

RECORDS TO BE CUT FROM CATALOGUES.

The following 222 Records will be omitted from the April edition and all future editions of the Catalogue of American selections. They should be erased from all copies of the Numerical Catalogue now in use by the trade:

- 537 Frolics in a Hen Coop (Edison Orch.)
 555 Musical Deceptions (Peerless Orch.)
 619 Bride Elect March (Edison Orch.)
 629 Under the Polar Star March (Edison Orch.)
 661 Trolley Galop (Edison Orch.)
 692 Dinah Polka (Edison Orch.)
 1020 Drill ye Tarriers Drill (Collins)
 1131 Father, Won't You Speak to Sister Mary (Dudley)
 1568 Let Me Kiss Your Tears Away (Harlan)
 2030 Lullaby from Erminie (MacDonough)
 2203 The Bridge (Edison Quar.)
 2211 Mamma's Black Baby Boy (Edison Quar.)
 2212 Hot Corn Medley (Edison Quar.)
 2227 Every Day Will be Sunday (Edison Quar.)
 2234 Sunshine Will Come Again (Edison Quar.)
 2236 Imitation Medley (Edison Quar.)
 2619 King Cotton March (Brooks)
 2631 Sounds from Africa (Ossman)
 3875 Uncle Josh's Arrival in New York (Stewart)
 3876 Uncle Josh in a Street Car (Stewart)
 3877 Uncle Josh at the Opera (Stewart)
 3878 Uncle Josh's Trip to Coney Island (Stewart)
 3879 Uncle Josh in a Department Store (Stewart)
 3880 Uncle Josh's Trip Home to His Farm (Stewart)
 3881 Uncle Josh Playing Base Ball (Stewart)
 3882 Uncle Josh on the Signs of New York (Stewart)
 3886 Uncle Josh's Trouble in a Hotel (Stewart)
 3887 Uncle Josh at the Stock Exchange (Stewart)
 3888 Uncle Josh at the Circus (Stewart)
 3889 Uncle Josh at the Museum (Stewart)
 3890 Uncle Josh at Delmonico's (Stewart)
 3891 Meeting of School House Directors (Stewart)
 3892 Pumpkin Centre Railroad (Stewart)
 3893 Baptism at Hickory Corners Church (Stewart)
 3895 Uncle Josh in a Police Court (Stewart)
 3896 Uncle Josh at the Camp Meeting (Stewart)
 3898 Uncle Josh on a Bicycle (Stewart)
 3900 Uncle Josh and the Bunco Steerers (Stewart)
 3902 Uncle Josh in a Chinese Laundry (Stewart)
 3904 There Ain't a Word (Stewart)
 3907 Three Little Owls and the Naughty Little Mice (Stewart)
 4021 Hush-a-Bye Baby (Watson)
 4028 Sleep, Baby Sleep (in German) (Watson)
 4036 Rock-a-Bye Baby (Watson)
 5406 Handicap March Song (Collins)
 5800 Answer (Schneider)
 6511 My Creole Sue (MacDonough)
 6600 Parody on Family Troubles (Denny)
 6603 Parody on Just One Girl (Denny)
 7112 You Can't Think of Everything (Denny)
 7123 Miss Helen Hunt (Denny)
 7178 Yuba Dam (Dudley)
 7181 Soldiers of the King (Schneider)
 7199 Man Took a Girl (Denny)
 7205 Different Styles of Singing (Denny)
 7278 I'd Leave My Happy Home for You (Collins)
 7298 Daily Paper at Pumpkin Centre (Stewart)
 7302 Always (MacDonough)
 7333 Lightning Rod Agent (Stewart)
 7371 My Old Green Mountain Home (MacDonough)
 7393 Glorious Beer (Quinn)
 7404 Mandy Lee (Collins)
 7457 Old Bill Jones (Collins)
 7544 Vaudeville Specialty, No. 2 (Quinn)
 7548 Vaudeville Specialty, No. 3 (Dudley)
 7549 Vaudeville Specialty, No. 4 (Collins)
 7574 Gems from Faust (D'Almaine)
 7580 Every Race Has a Flag but the Coon (Collins)
- 7688 Tick, Tack, Tocking of the Clocking (Denny)
 7693 Just Because She Made Them Goo-goo Eyes (Collins)
 7698 Selections from Les Huguenots (Wormser)
 7704 On Duty March (Peerless Orch.)
 7750 Coon, Coon, Coon (Collins & Natus)
 7752 Day by Day (Natus)
 7754 Marooney and His Bike (Collins & Harlan)
 7763 Speedway March (Edison Band)
 7783 Second Company March (Edison Band)
 7789 Hearts and Flowers (MacDonough)
 7802 Its the Man Behind the Gun, etc. (Stanley)
 7805 March from Foxy Quiller (Peerless Orch.)
 7816 I Never Trouble Trouble, etc. (Collins & Harlan)
 7821 Mamie, Don't You Feel Ashamie (Myers)
 7843 Tact (Denny)
 7846 Meeting of the Ananias Club at Pumpkin Centre (Stewart)
 7847 Jim Lawson's Horse Trade with Deacon Weatherspoon (Stewart)
 7850 I Must a Been a Dreamin' (Collins & Harlan)
 7905 Tell Us Pretty Ladies (Collins & Natus)
 7923 Go 'way Back and Sit Down (Denny)
 7935 Love Me Lize (Collins & Natus)
 7969 Wedding of Reuben and Maid (Collins & Harlan)
 7983 Adelina, the Yale Boola Girl (Edison Quar.)
 8000 Tell Me Dusky Maiden (Collins & Harlan)
 8003 Fire Department (Stewart)
 8009 Schultz on Trusts (Kennedy)
 8011 Heart of a Sailor (Kenney)
 8015 Rip Van Winkle Was a Lucky Man (Denny)
 8016 I'm the Man Who Makes the Money, etc. (Denny)
 8019 Song the Soldiers Sang (Libby)
 8025 Blaze Away (Van Epps)
 8026 Koonville Koonlets (Van Epps)
 8044 In the Moonlight With the Girl You Love (Thompson)
 8050 Meaning of U. S. A. (Thompson)
 8052 Let Me Dream Again (Thompson)
 8064 When I Think of You (Harlan)
 8071 Good Morning, Carrie (Quinn)
 8073 Nightingale and the Frog (Edison Orch.)
 8082 Jenny Lee (Harlan)
 8087 Blooming Lize (Collins)
 8091 Aladdin and His Lamp (Denny)
 8094 My Castle on the Nile (Collins)
 8098 Rip Van Winkle Was a Lucky Man (Edison Band)
 8106 Frolic of the Coons (Peerless Orch.)
 8110 Nancy Brown (Redmond)
 8113 Selection from The Chaperons (Peerless Orch.)
 8116 We're All Good Fellows (Thompson)
 8120 In a Cosey Corner (Peerless Orch.)
 8122 Josephine My Joe (Favor)
 8123 My Sambo (Collins)
 8124 Way Down in Old Indiana (Thompson)
 8148 Oh, I've Lost It (Favor)
 8161 Could You Be True to Eyes of Blue (Natus)
 8162 Come Out, Dinah, on the Green (Thompson)
 8163 You Couldn't Hardly Notice It at All (Collins & Natus)
 8164 I'll be There, I'll be There, Mary Dear (Harlan)
 8167 Barbecue in Old Kentucky (Invincible Quar.)
 8170 Those Things Cannot Be Explained (Favor)
 8174 I'll Be Your Rain-Beau (Quinn)
 8178 Down in the Depths (Stanley)
 8179 Rosalie, My Royal Rosie (Natus)
 8180 Little Gypsy Maid (Thompson)
 8182 Bill Bailey, Won't You Please, etc. (Edison Band)
 8186 Meet Me When the Sun Goes Down (Thompson)
 8188 We Won't Go Home Until Morning (Quinn)
 8196 Marion (Collins & Natus)
 8199 I Just Can't Help from Loving, etc. (Collins)
 8205 Have You Seen My Sweetheart, etc. (Natus)
 8212 Tale of the Sea Shell (Thompson)
 8216 I'm a Lady (Favor)
 8220 Shirt-Waist Band (Collins & Natus)
 8225 The Last Wish (Stanley)

- 8226 Selection from The Prince of Pilsen (Peerless Orch.)
 8239 Troubles of Reuben and the Maid (Collins & Harlan)
 8262 Good Night, Beloved, Good Night (Thompson)
 8263 I'm Unlucky (Collins & Harlan)
 8269 Eva (MacDonough)
 8272 At the Bottom of the Deep Blue Sea (Stanley)
 8273 In Dear Old Illinois (Thompson)
 8277 Our United Emblem March (Edison Band)
 8278 Pretty Molly Shannon (MacDonough)
 8281 Nellie Was a Lady (Lotus Quar.)
 8284 Everybody's Awfully Good to Me (Favor)
 8286 Under the Rose (Clifford)
 8287 On Broadway in Dahomey, etc. (Collins & Harlan)
 8291 When It's All Goin' Out, etc. (Quinn)
 8292 Just a Line From Jennie (Harlan)
 8299 New Mown Hay (Peerless Orch.)
 8300 In the Sweet Bye and Bye (Libby)
 8302 I'm Getting Quite American, etc. (Denny)
 8306 There's No Place Like Home (Harlan)
 8309 I'm So Tired of Livin' I Don't Care, etc. (Collins)
 8312 He Ought to Have a Tablet, etc. (Favor)
 8313 Strike Out McCracken (Collins & Harlan)
 8314 Nationality Medley (Invincible Quar.)
 8315 Katie My Southern Rose (Thompson)
 8316 What's the Matter with Sarah (Denny)
 8318 Thy Beaming Eyes (Clifford)
 8319 Trouble (Collins & Harlan)
 8323 No One But You (Lenox)
 8324 Didn't Know Exactly What to Do (Favor)
 8329 My Own United States (Thompson)
 8344 Message of the Rose (Lenox)
 8345 Gambling Man (Collins)
 8348 In Silence (Clifford)
 8350 Since I First Met You (Thompson)
 8353 Two Eyes of Blue (MacDonough)
 8355 Pearl of the Harem (Van Epps)
 8357 Just for To-night (Campbell)
 8371 Sly Musette (MacDonough)
 8372 O'Brien (Collins & Harlan)
 8377 Selections from the Sultan of Sulu (Peerless Orch.)
 8378 Song Bird of Melody Lane (Thompson)
 8384 It's the Man in the Soldier Suit (Thompson & Campbell)
 8385 Heidelberg (MacDonough)
 8386 When the Winter Time Comes Round (Collins & Harlan)
 8390 When Our Lips in Kisses Met (Morgan & Stanley)
 8393 My Little Pansy (Collins)
 8399 I Wonder if Your Love Will Last (Thompson & Campbell)
 8402 Waltz Me Down the Alley Sally (Collins & Harlan)
 8406 Up the Street March (Edison Band)
 8407 If I But Knew (Thompson)
 8408 Mississippi Bubble (Ossman)
 8411 Julie (Favor)
 8413 Long Ago (Clifford)
 8414 Cupidietta (Peerless Orch.)
 8415 Down at Lover's Roost (MacDonough)
 8421 Ma Starlight Sue (Thompson & Campbell)
 8429 Marriage is Sublime (Collins & Harlan)
 8430 Mighty Lak' a Rose (Clifford)
 8440 I'm a Jonah Man (Collins)
 8442 Selections from Peggy from Paris (Edison Orch.)
 8445 I Could Love You in a Steam Heat Flat (West)
 8446 Farewell Beloved (Chapell & Stricklett)
 8447 Hurrah for Baffins Bay (Collins & Harlan)
 8448 Hebrew Vaudeville Specialty (Rose)
 8453 Alec Busby, Don't Go Away (Murray)
 8459 Lucky Duck (Edison Orch.)
 8466 My Emmaleen (Collins)
 8471 Ephasafa Dill (Collins & Harlan)
 8472 Girl Who Comes in from the West (MacDonough)
 8479 The Chapel (Edison Quar.)
 8483 My Little Coney Isle (Tally)
 8485 Scarecrow Dance (Edison Orch.)
 8489 Bungalow (Edison Band)
 8494 Though It Was Within This Hour We Met (Morgan & Stanley)
 8497 Drink to Me Only With Thine Eyes (Wheatley)

- 8508 Budget of Short Stories (Spencer)
 8542 Four-Leaf Clover (Clifford)
 8545 My Alamo Love (MacDonough)
 8639 Beautiful Birds Sing On (Harlan & Belmont)
 12875 Under the Deodar (Barry)
 12891 La Gobinois (Harmant)
 12892 Je M'Suis Roule (Harmant)

OUR BERLIN OFFICE.

The Edison Gesellschaft G. m. b. H. of Berlin, the company who are controlling the Edison products in Germany, are making great headway. They have been established only twelve months. yet during that short time have made such excellent progress as to warrant the expectation that they will soon be rivalling the enormous output of the British company. We learn that the Berlin company recently received a visit from sixty of the most influential members of the German press, who have given testimony in the leading German papers as to the magnificent plant that has been installed.—*Phono Trader, London.*

CUT ON FREIGHT RATES.

The railroads on the Pacific coast have made a cut on transcontinental freight rates on talking machines of from \$4.50 to \$2.25 per 100 pounds, on carload lots of 20,000 pounds, and \$3.24 on carload lots open freight.

If any Record were as good as the Edison Gold Moulded Record or if any other Record were so good as to be almost as good, we would sell that other Record, but as yet we are unable to find that other Record. Until we do we will sell Edison's Gold Moulded Records exclusively. To get the best results the Edison Phonograph must be used with the Edison Record.—*Extract from Advertisement of Griggs' Music House, Des Moines, Ia.*

CAUTION NOTICE.

Here is a paragraph that should be carefully read by every Jobber and Dealer. When Standard Phonographs are packed for shipment at the Edison factories, a strip of wood is fastened to the lower part of the cabinet, under the spring barrel, for the purpose of protecting the latter from injury. This strip of wood takes the place of the paper and excelsior packing formerly used and must be removed when the machine is unpacked. Otherwise the machine will not operate properly. It would seem as if all Dealers should know that this strip was to be removed, and yet several cases have been reported where it was not taken out, causing purchasers much trouble.

COMMENTS ON EDISON GOLD MOULDED RECORDS FOR APRIL.

The twenty-five Edison Gold Moulded Records included in the April list issued by the National Phonograph Company will provide a most enjoyable evening's entertainment to those who purchase the entire list. It is splendidly balanced in instrumental and vocal selections, and both departments include something to suit all tastes.

No. 8953, "Al Fresco" (Intermezzo), by the Edison Concert Band, is one of Victor Herbert's compositions and more on the popular order than Mr. Herbert usually writes. A sprightly, tuneful selection and one being played by the best instrumental organizations everywhere.

No. 8954, "If Mr. Boston Lawson Has His Way," sung by Billy Murray, is George M. Cohan's latest composition and recently introduced in his musical play, "Little Johnny Jones." It deals facetiously with Thomas A. Lawson's ideas on frenzied finance. It is a topical song of decided merit in both words and music. Mr. Cohan, the composer, is also responsible for the cyclonic hit, "Yankee Doodle Boy," our Record No. 8910, which was also sung by Billy Murphy. The Record is made with orchestra accompaniment.

No. 8955, "Jasper, Don't You Hear Me Calling You," by Collins & Harlan, tells of Jasper Johnson, who was a sleepy coon, and his wife's troubles in getting him up in the morning. Sung in an excellent manner by these well-known duettists and accompanied by the orchestra. The music of this song was written by Henry Frantzen and the words by Bert Fitzgibbon.

No. 8956, "A Summer Dream," a bells and chimes duet, by Benzler & Nesbit, accompanied by the Edison Military Band. This composition is appropriately styled by its composer a "morceau characteristic." A high standard was set by our chimes and bells Record "Monastery Bells," No. 8912, and one difficult to equal. "A Summer Dream," however, will prove equally popular. Both are fine Records and it will only be a matter of individual taste between them. P. Hans Flath is the composer of this selection.

No. 8957, "He's Me Pal," sung by Miss Ada Jones, is a characteristic song having a tuneful waltz chorus. Made with orchestra accompaniment. This is very different in character from Miss Jones' offering last month. The selection shows her versatility in essaying character roles. "He's Me Pal" is of the Bowery and is typical of that famous locality. Miss Jones brings out the meaning finely—in dialect and style. The music of this song was written by Gus Edwards and the words by Vincent Bryan.

No. 8958, "In the Shade of the Old Apple Tree," by Irving Gillette, is a composition of more popular character than Mr. Gillette's former selections, and shows that he can make as much of this class of music as that of the higher order. The music of this song is by

Egbert Van Alstyne and the words by Harry H. Williams. The chorus:

"In the shade of the old apple tree,
When the love in your eyes I could see;
When the voice that I heard, like the song of the bird,
Seemed to whisper sweet music to me;
I could hear the dull buzz of the bee,
In the blossoms as you said to me,
With a heart that is true
I'll be waiting for you
In the shade of the old apple tree."

No. 8959, "Panama Rag," is a fine Record by the Edison Symphony Orchestra. Not in a long time has our Symphony Orchestra made a selection of this character. Numbers of a heavier nature have seemed to be more appropriate for an organization of its excellence. We think, however, that the bright catchiness of this selection will appeal to all, including those who prefer music of a higher order. "Panama Rag" is of a ragtime character and introduces castanets and orchestra bells.

No. 8960, "Birds of a Feather Flock Together," by Bob Roberts, is a study in coon philosophy, ranging from the assertion "When you've got money your friends will flock to you" to "De eagles on de dollah bill is gwine to chum with me." It follows that Mr. Roberts make an excellent Record of the selection. The music of this composition was written by Jean Schwartz and the words by Harry Williams.

No. 8961, "Longing for You," sung by Byron G. Harlan, is a new and pretty composition, the music for which was written by Theodore F. Morse and the words by Jack Drislane. Mr. Harlan was never in better voice than when he made the Record of this sentimental song. He was accompanied by the orchestra. To an unusually pretty melody the following words of the chorus are set:

"Longing for you, yes, only you,
My heart is aching if you but knew.
Those eyes of blue have pierced me through
That's why I'm longing, longing for you."

No. 8962, "Magnet March," played by Edison Military Band, is an exceptionally effective band arrangement of a very tuneful melody, the steady swing of which is admirably adapted to the uniform tempo characteristic of our Military Band. The attractive music of this march makes its title particularly appropriate. The composer of "The Magnet March" is F. H. Losey, who also wrote "The Waldmere March," our Record No. 8538.

No. 8963, "Farewell, Mr. Abner Hemingway," by Murray & Roberts, is a coon song with orchestra accompaniment. Written by Jean Schwartz (music), and William Jerome (words). "Missus" Hemingway explains to her negligent better half the necessity for saying farewell to him. She says "Just cut out 'babe' and 'turtle dove.' I can't exist on bankrupt love. I've read that book on 'Simple Life,' and from this time on I'm going to pass you by like as though you was a dose of poison."

No. 8964, "Billy," sung by Harry MacDonough, is something on the order of "Sammy," our Record No. 8565, and destined to become just as popular. The music of "Billy" was written by Edgar Malone and the words by Ted S. Barron. Mr. MacDonough makes the

Record with his usual clear enunciation and has the assistance of the orchestra.

No. 8965, "Schubert's Serenade" is another remarkably fine 'cello Record by Hans Kronold, and a fitting companion to Mr. Kronold's Record of "Evening Star," from Tannhauser, listed last month and pronounced by musicians one of the most artistic pieces of recording ever made. Mr. Kronold's skill as a 'cello player of the first rank is again shown in this Record of "Schubert's Serenade." No lover of string music can afford to be without this Record.

No. 8966, "Bunker Hill," is a descriptive and patriotic Record by Harlan and Stanley, telling of the Battle of Bunker Hill. Sung with orchestra accompaniment. It introduces a very realistic battle scene, with bugle, fife and drum effects, boom of cannon and rattle of musketry. It pictures vividly the memorable assault and repulse of the English in this early battle of the Revolutionary War. Albert Von Tilzer wrote the music and Sam Ehrich the words.

No. 8967, "Grandfather's Clock," by the Edison Male Quartette, is the old and well-known song, and is put out in response to repeated demands from all over the country. It makes a splendid Record in quartette form, a form in which it has never before been listed. Particularly realistic is the ticking of the old clock. We predict great popularity for this Record, not only with those whose earliest recollections are associated with it, but also with those of the younger generation who will perhaps now hear it for the first time. Henry C. Work wrote the music and words of this old-time song.

No. 8968, "How Can I Leave Thee," is an unaccompanied mandolin solo played very artistically by Samuel Siegel. The theme is played in duet effect, giving the impression of more than one mandolin. This form is a specialty of Mr. Siegel's. This composition is by C. Cramer.

No. 8969, "My Little Dinah Lee," sung by Bob Roberts, is a coon serenade written by James J. Burriss (music) and Tom Lemonier (words). For a change, and on account of appropriateness, a banjo accompaniment has been provided for this song, played by Vess L. Ossman. The words follow:

"Mong the pines of Tennessee I've a coon girl dear to me,
Every night it's my delight to call on Dinah,
With my banjo on my arm, den I creeps up by de barn
In a voice so sweet and low I sing dis song to please her:
Oh, Oh, Oh, Oh, Oh, Oh, my Dinah Lee
Oh, Oh, Oh, Oh, Oh, Oh, please listen to me;
Dinah Lee, come out and see
Who's singing this song to you."

No. 8970, "When the Swallows Homeward Fly," by MacDonough & Biehling, is a well-made Record of this song which is too well known to need description. It is one of Franz Abt's most popular ballads and has never before been listed as a duet. Very popular with German people and well known by its German title "Wenn die Schwalben heimwärts ziehn." The Record is made with orchestra accompaniment.

No. 8971, "Yankee Patrol," by the Edison Concert Band, is performed in the exact manner of a patrol. The instruments that are first heard in the band approaching from a distance are also heard first in the Record, the music swelling until the whole band is heard in one volume. It then gradually diminishes in volume, the reverse of the beginning, until the music dies away in the distance. F. W. Meacham wrote this composition. He is also the composer of "The American Patrol," in our Record No. 8424.

No. 8972, "Love's Sorrow," sung by Harry Anthony, is one of the best known compositions by Harry Rowe Shelly and is popular with everybody. In the hands of Mr. Anthony full justice is done to it. We think it is one of the best Records yet made by Mr. Anthony. The orchestra accompanies the singer.

No. 8973, "Ramblin' Sam," sung by Arthur Collins, tells of a coon who has been rambling in and out of difficulties all his life. Two of Sam's rambles are made clear in this Record, one where he was mixed up with the explosion of a barrel of nitro-glycerine and another where a quickly speeding auto overtakes him. Both of these situations are added to with humorous dialogue and realistic effects by Mr. Collins. It is quite different from any coon song we have heretofore listed. The Record is made with orchestra accompaniment. The music of this song was written by Jean Schwartz and the words by Harry Williams.

No. 8974, "Moonlight" (a serenade), is an excellent Record by the Edison Symphony Orchestra. Like "Hiawatha," the popularity of this composition has begun in the West. The music has a Spanish or Mexican flavor about it, added to by the effect of castanets in one of the strains. It shows up all the instruments of the orchestra to good advantage, with a pizzicato effect for the strings in the beginning, the cornets in a pretty duet passage, followed by a G string strain for the violins. The coda introduces a recurrence of the prominent theme in the selection played by the wood wind, bringing the Record to a very effective close. The music was written by Neil Moret, who also composed "Hiawatha."

No. 8975, "Parson Spencer's Discourse on Adam and Eve," by Len Spencer, is a colored preacher's sermon to his flock, with characteristic responses by enthusiastic members and singing by the choir "De Gospel Train Am a-Coming."

No. 8976, "Where the Southern Roses Grow," sung by the Edison Male Quartette, is a descriptive selection by Theodore F. Morse, composer of "Blue Bell" and numerous other successes. The words are by Richard H. Buck. Made with orchestra accompaniment. Part of the words follow:

"Where the Suwanee River's twining,
I can see the home lights shining,
Like stars of hope they glimmer
In the valley far below.
And as twilight time comes stealing,
I can see my sweetheart kneeling,
And I know she's praying for me
Where the Southern Roses grow."

No. 8077. "Coax Me Medley," by the Edison Military Band, introduces five popular songs previously listed by us, as follows: No. 8907, "Coax Me;" No. 8944, "Won't You Fondle Me;" No. 8950, "When the Harvest Moon is Shining on the River;" No. 8942, "Can't You See My Heart Beats All For You," and No. 8936, "Mexico."

SEVENTY-TWO MORE MEXICAN RECORDS.

Listed below are 72 additional Mexican selections, making 143 issued to the present time. A supplement has been printed, including the entire list, and small quantities will be furnished to jobbers. Except in the States close to Mexico, we do not anticipate any large demand for these selections. Consequently we have made no provision for supplying large quantities of these supplements. These Records are made in the same splendid manner as the first 71 issued, and cannot fail to be popular among Spanish speaking people. In Mexico they have achieved a tremendous popularity, and have awakened a widespread interest in the Edison Phonograph. The list is printed in a combined English and Spanish arrangement in order to afford non-Spanish speaking dealers an opportunity of knowing something about them.

BARITONE SOLOS BY R. HERRERA ROBINSON (Guitar Accompaniment).

18536 Los Chamacos, Polka

TRIOS BY SEÑORES ROSETE, LLERA & LOPEZ (Orchestra Accompaniment).

18567 La Gran Via, Jota de los Tres Ratas

BANDA DE ZAPADORES DE MEXICO.

18568 Honradez, Paso Doble
18570 Fuentes, Paso Doble Flamenco
18571 Los Negritos, Polka
18609 Himno Nacional Mexicano
18610 Promesas Y Ventanazos, Dos Danzas
18612 Lazos de Amor, Schottisch
18614 Granada, Paso Doble
18615 Sangre Espanola, Paso Doble
18616 Primaverales, Tres Danzas
18617 La Tortolita, Polka
18701 Para Siempre, Vals

ORQUESTA TIPICA LERDO.

18584 El Gran Presidente, Marcha
18586 Amorosa, Vals
18588 Segundo Alegro en la Obertura Guillermo Tell
18589 Los Tres Pecados, Danzas
18591 Buenavista, Cake Walk Mexicano
18627 Mi Delirio, Vals
18630 Baile De Sopreso, Schottisch
18631 Angela, Vals

DUETS BY SENORA HERRERA & SENOR ROSETE (Orchestra Accompaniment).

18603 El Hombre Es Debil, Habanera
18604 La Alegria de la Huerta, Jota
18605 El Santo de la Isidra
18606 Quien Fuera Libre, Guaracha
18607 La Fiesta de San Anton
18608 Las Grandes Cortesanas, Dua de Las Campanillitas

BANDA DE ESTADO MAYOR DE MEXICO.

18622 Himno Nacional Cubano
18623 Un Vuelo de la Fantasia, Schottisch
18624 Patria Feliz, Marcha
18626 Jota en la Zarzuela Cadiz
18709 Mi Amor, Polka

BARITONE DUETS BY SEÑORES ROBINSON & PICAZO (Guitar Accompaniment).

18632 Te Amo en Secreto, Danza
18633 La Rumba o el Amor Y el Desafio, Jota Mexicana
18634 El Sitio de Queretaro, Cancion Popular
18635 La Feria, Pieza imitativa
18636 La Paloma Azul, Danza Tapatia
18639 Cancion del Camaron
18640 Lamentos de un Crudo, Cancion Popular

SOLO BY SENORA ZAMUDIO. (Guitar Accompaniment.)

18641 El Palomo Errante, Cancion Tapatia

SOLOS BY SENORA SOLEDAD GOYZUETA. (Orchestra Accompaniment.)

18644 Un Cuento de Boccaccio, Serenata
18645 Traviata, Romanza del 4o acto
18646 Traviata, Final del aria del 1er acto
18647 El Anillo de Hierro, Romanza del 3er acto
18648 Cavalleria Rusticana, Romanza

SOLOS BY SENORA MATILDE HERRERA. (Orchestra Accompaniment.)

18650 De Madrid a Paris, Vals de Los Golondrinas
18654 La Torre del Oro, Tango del Lapice
18659 Gigantes Y Cabezudos, Jota Si las Mujeres Mandasen
18663 Las Grandes Cortesanas, Coplas

DUETS BY SENORA HERRERA & SENORITA BERAUD (Orchestra Accompaniment).

18651 La Fiesta de San Anton
18652 La Tempestad
18653 La Viejecita
18660 Boccaccio, Duo La Nina Florentina

TRIOS BY SENORAS HERRERA AND SEDANO AND SENORITA BERAUD. (Orchestra Accompaniment.)

18655 Los Cocineros, Jota
18656 Instantaneas, Gavota Las Mariposas
18657 De Madrid A Paris, Terceto de Las Cigarreras
18658 Dona Juanita, Serenata

SOLO BY SENORITA BERAUD. (Orchestra Accompaniment.)

18661 La Ensenanza Libre, Coplas del Ratoncito

TRIOS BY SEÑORES ROSETE, LOPEZ & HERMOSA (Piano Accompaniment).

18664 La Parranda Llanesca

TRIOS BY SENORA HERRERA, SENORITA BERAUD & SENOR ROSETE. (Orchestra Accompaniment.)

18666 San Juan de Luz, Tango La Cacerola

TRIOS BY SENORA SEDANO, SENORITA BERAUD & SENOR ROSETE. (Orchestra Accompaniment.)

18667 De Vuelta del Vivero, Terceto del Pajarito

TENOR SOLOS BY SENOR BRAULIO ROSETE (Orchestra Accompaniment).

18670 El Tambor de Granaderos, Coplas de Los Milagros

18671 El Anillo de Hierro, Romanza
18672 Los Cocineros, Coplas de Serapio

TENOR AND BARITONE DUETS BY SEÑORES ABREGO & PICAZO. (Guitar Accompaniment.)

18673 La Rancherita, Cancion Popular

BARITONE SOLOS BY JOSE MARIA PALMA. (Guitar Accompaniment.)

18678 La Farruca de Juan Torres, Cancion Espanola
18679 Jota Rabalera, Cancion Espanola

MIXED QUARTETTES. (Piano Accompaniment.)

18696 Agua, Azucarillos Y Aguardiente, Pasacalle
18697 Marina, Tango Final
18699 Los Sobrinos del Capitan Grant, Zamacueca

MANDOLIN AND GUITAR DUET BY SEÑORES OBSCURA & ARRIAGA.

18747 Serenata Morisca de Chapi

CHORUS.

18799 O Salutaris Hostia, Chorus Coro Religioso

THE PHONOGRAPH—HOW IT MAY HELP MUSIC TEACHERS.

(BY NIMMO CHRISTIE.)

The Phonograph of to-day is a very different thing from the Phonograph of a few years back. Vast improvements have been made. What was formerly a pain to listen to has now become a source of almost artistic pleasure. Of this probably most people are aware. The purpose of the present remarks is to indicate one or two ways in which the instrument, or machine, may be useful to the musician, especially to the teacher of vocal music.

The most obvious way is by reproducing the voices of singers of reputation—singers who may be regarded as models. An Andrew Black, a Ben Davies, a Kirkby Lunn cannot be heard every day. Students who are tied to country places may never be able to hear them at all. But the possessor of a Phonograph, and the proper "Record" may enjoy, appreciate or criticise, a wonderfully accurate Phonograph of either singer's voice at any time. It may be too much to say that a voice is reproduced in all its beauty. Professor McKendrick when lecturing to the I. S. M., at Glasgow University, pointed out that the material composing the Phonographic recorder and "reproducer" had tendencies of its own which no doubt modified the pure effects of the vocal sounds. But there is quite enough of a singer's voice registered to serve purposes both of pleasure and art. When we hear a singer in a concert-room there is after all but a brief opportunity for studying his style and method—even with encores thrown in. Let us possess that singer's "record," however, and we can have him at our leisure for as long or as short a time as we may desire. We can note his reading of a song, his phrasing, his *crecendos* and *diminuendos*, his variations in speed, the quality of his voice, and the manner in which high and low notes are produced, the pronunciation of vowels and consonants, and other points of importance. Sometimes we may learn what to avoid. For instance, the melodramatic emphasis of a certain eminent "record" in "Abide-a with-a me;" and the peculiar guttural "r" of another. Example is better than precept; a Phonograph may sometimes save a teacher's tired throat, and much tedious verbal instruction.

There is another way in which the machine may aid a teacher.

"O wad some power the giftie gie us,

"To see oursel's as ithers see us."

sings the poet. Is anything more difficult? All of us cherish such fond illusions concerning our personal qualities. We may even be too modest about them. Let the teacher sing into his Phonograph, and then listen to the result—preferably at a future time. He may feel surprise. Dispassionately he will be able to regard himself from the outside—as others see him, or hear him, rather. All his own perfections and imperfections he will be in a position to set in a note-book, con, and learn by rote. And all the while his conscience will

not permit him to deny the identity of what he hears with the tones and accents of his own voice. This is no slight service. So distinguished a man as Saint Saens admits that by means of the Phonograph he made the discovery that he was in the habit of playing incorrectly a passage in his *Valse Canariote*. In consequence he advises musicians to make use of it.

If the Phonograph reveals the teacher to himself, it is obvious it may be used in a similar manner for the pupil's benefit. Professor McKendrick showed by means of magnified photographs of air-wave forms how accurately vowel sounds are recorded. Pure vowels are often a difficulty with pupils. Custom has so dulled their senses to their own deficiencies. A student listening to his own voice as if it were the voice of some one else can hardly fail to perceive its defects when the teacher draws attention to them. Similarly other errors may be pointed out, and thus language and argument (to which some pupils are prone) may be avoided.

Further, the gradual progress of a pupil from his first feeble efforts to his final state of perfection may be recorded with precision, for the pupil's own gratification and for the encouragement of his successors in their moments of despondency.

One word more. There are Phonographs and Phonographs. Only the best makes and finest "records" are here written of.—*Musical Herald, London.*

A BELLAMY DREAM REALIZED.

Edward Bellamy, in his story "Looking Backward," which created a sensation nearly twenty years ago, outlined an apparatus which furnished music to suit the desires of a patron in response to a touch upon an electric button. Opera and concerts, vocal and instrumental, could be enjoyed by one sitting at his fireside. No standing in line to procure tickets; no cab-hire in stormy nights; no getting home fagged out in the wee small hours. Just draw up your comfortable chair in your favorite library corner, touch a button and drink in the sweet sounds. If the selection is displeasing to you, just turn it off—no waiting till the curtain goes down for fear of a conspicuous departure from the theatre.—*New York Evening Journal.*

An up-to-date Edison Phonograph comes very close to fulfilling Mr. Bellamy's dream.

ABOUT RECORD CARTONS.

We are still unable to fill orders from Jobbers and Dealers for Record cartons for the reason that the manufacturer has been unable at any time since the new box was adopted to make more cartons than were required to fill orders for Records. It will still be some time before we can consider the matter, unless the manufacturer in the meantime should be able to increase his output. When feasible to fill orders the trade will be advised of the fact.

THE PHONOGRAM.

Orders for the *Phonogram*, either blank or imprinted, must be filed in advance, five weeks ahead for imprinted lots and four weeks ahead for blanks. We cannot agree to fill orders unless this is done.

The success of the *Phonogram* has been phenomenal. The March edition was 190,000 copies, an increase of 110,000 over that of the first issue last July. Dealers are crediting it with being an effective medium for increasing business, chiefly on account of the matter describing the new Records each month.

Following is a schedule of prices at which *Phonograms* may be obtained by the trade:

DELIVERED WITH GOODS.

Blank, per 1000 copies	\$2.50
Smaller quantities pro rata.	
Imprinted, per 500 copies.....	1.50
Imprinted, per 1000 copies.....	2.75

No orders filled for less than 500 copies requiring imprint, and all imprinting orders must be for multiples of 500.

Most Jobbers will be glad to supply Dealers on the above basis.

BY MAIL.

Single copies, per year	\$.20
Five copies to one address, per year....	.40
Twenty-five copies to one address, per year	1.80
Fifty copies to one address, per year....	3.60

Unless they have open accounts on our books, Dealers ordering *Phonograms* sent by mail are requested to send cash or stamps with their orders. The amounts are too small to handle in any other way.

TWO YEARS OLD.

With this issue the EDISON PHONOGRAPH MONTHLY begins its third year. It has served in the past two years to keep the trade informed concerning various matters of interest and profit and it has aided in knitting the Edison organization more closely together than before. We hope to make it even more useful along these lines.

SOLD FIVE PHONOGRAPHS TO ONE CUSTOMER.

An Australian Dealer recently wrote to our Foreign Department as follows:

"As a cheering sign of the times, we take pleasure in telling you that in the past three weeks we have sold no less than five Standard Phonographs and outfits, with two gross of Records, to a leading gentleman here. Two he has retained for his own use, one for his town house and one for his country home, and the other three he has presented to friends. This sale of five machines retail to one client is, we think, a record for this state, and speaks volumes for the superiority of Edison goods over all others."

DEALERS ADVERTISEMENTS.

We desire to acknowledge the receipt of newspapers and other mediums containing the advertisements of the following: Knoxville Typewriter and Phonograph Exchange, Knoxville, Tenn.; Hartford Phonograph Co., Hartford, Conn.; M. B. Willis, Jr., Auburn, Ind.; Peter Bacigalupi, San Francisco; Eastern Talking Machine Co., Boston; Steinhauser & Eaton, Watsonville, Cal.; C. C. Mellor Co., Pittsburg; Emil Gardnier; Scott's Novelty Store, Menominee, Wis.; Fiske & Co., Los Angeles, Cal.; Joseph B. Cohen, Providence, R. I.; O. K. Houck Piano Co., St. Louis; Currie Motor and Cycle Co.; Nobes' Drug Store, Flora, Ind.; Roanoke Cycle Co., Roanoke, Va.; H. M. Holleman Co., Houston, Texas; R. E. Snipes, Selma, N. C.; S. K. Hamburger, Harrisburg, Pa.; L. C. Hartzell, Holyoke, Mass.; Palace Phonograph Co., Newark, N. J.; Spratt & Corcoran, Watertown, N. Y.

PUT HIS DISC BUSINESS "TO THE BAD"

The H. M. Holleman Co., Edison Jobbers at Houston, Texas, recently sent us the following letter from one of their Dealers:

"Please send me by return express one Standard Phonograph, with 36-inch horn and stand; one Home Phonograph, with 36-inch horn and stand, and list of Gold Moulded Records enclosed. The Phonograph (Standard) is gone and has put our disc business to the bad. Am going to push the Edison."

"When our Mr. Lewis visited Mr. H——, who is the disc dealer of ——," continued Holleman & Co., "he induced him to listen to the Edison, in competition to his machines, resulting in an initial order, but being temporarily out of Triumphs and Homes, we were unable to send him anything except a Standard, but had our man to go there and properly adjust it for them. Result is that Mr. H—— is going to close out his disc business, and push the Edison. Mr. H—— is mayor of ——, and a very influential man."

CANNOT GET RID OF THEM.

I notice in the Monthly of a Dealer wanting his Jobber to sell his machines of another make. I have two—— machines listing at \$20.00 and I cannot sell them, placing them beside the Edison. I have offered them at about one half price to close out, and one of my customers said to me: "Do you think I would even pay you that much when I can get that Edison Standard at \$20? Not much." Regarding premium machines. We have just had a run of them here and we find that the people who wish a good thing, come in and trade their scratchy machine in and buy an Edison.—J. H. Lepper, Mason City, Ia.

A DEALER'S CIRCULAR LETTER.

Have you heard the Phonograph as it is today?

Almost everyone has heard some sort of a machine, but few have heard the latest improved one at its best, and comparatively few appreciate its value as an entertainer.

With a Phonograph in the home you have the singing or speaking voice, instrumental solos, or full brass band, just as sweet, just as clear, as the original tones and of just the sufficient volume.

It makes it possible for you to hear the finest talent in the land, and is superior to all other instruments because of its endless variety, and stands absolutely alone as an entertainer.

You have the choice of all the latest and best music, (and it can be obtained while it is new,) as well as all the old favorites.

When the long winter evenings make home-staying dull the Phonograph helps to pleasantly pass the hours. Your family and friends are entertained, and the fireside has an added interest.

There are four popular styles of the Phonograph, and the enclosed catalogue gives description and prices.

The Phonograph now has a Moulded Record, much harder than the old-fashioned one; does not wear out, and can be handled without fear of scratching or finger-marks. The price is only 35 cents each.

Make the whole family a present of a Phonograph. As a pleasure-giving gift you could make no wiser choice.

For any further information write me, or better still, call at the store, see the assortment of latest models, and hear a few Records.

We sell on easy terms if you wish.

GEORGE A. LEWIS,
Ridgewood, Conn.

BEST STEP THEY EVER TOOK.

Herewith is an extract from letter received at our Chicago office from the Ainsworth Music Co., Watertown, S. D., bearing date of January 18th, 1905:

"Our business in your line has been good of late. We have sold since the first of December thirteen machines, and two or three hundred Records. This is about three times as much as this firm has sold in any six months of its history in talking machines. The Edison is a winner, and people are coming to see it. We advertise persistently, and it is telling. They often come in to trade scratchophones—which, by the way, is becoming quite a designation of the disc type of machine in this town through our use of it—but no, we cannot handle them. They are even raffling them off, and we hope they will then come in here and buy a real talking machine. We hear nothing but compliments of your goods, and do not regret the step we took in selling out our line of other goods and handling yours straight. Best step we ever took."

IT PLEASES ALL.

About a week before Christmas, early one cold December morning, I started out to show the Edison Phonograph to some prospective buyers in a small near-by town. My first call was at the home of an old violinist, whose "fiddle and bow" had become covered with dust but whose ear was as keen as ever for sweet strains. I set up the machine, put on "Pop Goes the Weasel Medley" (violin Record) and at once "old times" were recalled. Next I played a song which captivated the household. Bentley, the three-year-old baby, who had been left "tucked under the covers," suddenly called "Mamma, take me down, I want to hear man sing." He was brought down in his nightclothes, and it would have done anyone good to see how he enjoyed it. The father immediately became interested and soon decided to purchase one. After leaving a good selection of Records with it, I left. Bentley was so taken up with it that he would not let them stop playing; that night he begged to hear "just one more" until at 1 o'clock he fell asleep.

About a week afterward I called to play a few new Records. The baby immediately began to cry and could not be comforted. I asked what was wrong? His mother informed me that he remembered I had left the machine there and was afraid I had come to take it away. I learned also that every member of the family was "carried away" with the harmonious strains. Relatives and neighbors dropped in to hear it and as a result have sold four machines within a stone's throw of the house.

GEORGE H. MUHLENBERG,
Morgantown, Pa.

PHONOGRAPH AMONG RUSSIAN PRISONERS.

Following is an extract from a letter recently received from the Rev. James H. Pettes, a missionary in Japan:

"It occurred to me that you may be interested to learn that last month I spent a few days at Hiroshima and Matsupama, two of the great military centres of Japan.

"I carried my Phonograph, and used it for the benefit of wounded Japanese soldiers and Russian prisoners. When at the Matsuyama Barracks, in the presence of a large group of Russian officers and men, I let the "Edison Grand Concert Band" strike up unannounced, the Russian Hymn; it was a moving sight. Every man was on his feet in an instant, and tears as well as smiles bespoke the deep emotion felt by these men from Russia.

"After an hour's entertainment, during which I heard many such expressions as: 'It was very kind of you to bring your Phonograph so far for our benefit;' 'That was the best treat we have had since we left Russia;' 'I could shut my eyes and think I was in Moscow or St. Petersburg at the opera,' etc., etc.

"I came away thankful for the Edison invention, which could give such solid comfort to these homesick captives in a distant land."

SUSPENDED LIST, MARCH 1, 1905.

SUPERSEDING ALL PREVIOUS LISTS.

COLORADO.

Boulder—BENTLEY & CRAIG.

ILLINOIS.

Ottawa—*Edward Hayne.

Wheaton—*E. Irving.

INDIANA.

Marion—BUTLER MUSIC CO.; also Wabash, Ind.

South Bend—EUGENE MARSH, 126 Vistula avenue.

SOUTH BEND BOOK BINDERY,
Robert Lebolt, Prop., 203 North
Michigan street.

Wabash—BUTLER MUSIC COMPANY; also Marion,
Ind.

IOWA.

Burlington—JOHN P. WEISS, 711 Jefferson street.

Sioux City—HATTENBACH BROS. CO.

KANSAS.

Clay Centre—E. M. GOWENLOCK.

Lawrence—BELL BROS.

MAINE.

Biddeford—W. H. FIELD.

MASSACHUSETTS.

Boston—T. SINGER, 60 Leverett street.

Lawrence—LORD & CO., 314 Essex street.

E. O. MOSHER, 420 Essex street.

Lynn—ELIAS DEYOUNG.

Malden—A. T. FULLER.

Nantucket—ARTHUR M. TAYLOR.

New Bedford—H. B. DEWOLFF.

Somerville—E. J. WINCHESTER, 32 Summit avenue.

Woburn—OSBORN GILLETTE, or THE BOLTON
JEWELRY CO., L. F. Maloney, Manager.

MICHIGAN.

Detroit—F. J. SCHWANKOVSKY.

Saginaw—GEO. W. EMENDORFER.

JAMES V. CALAHAN, 217 Genessee st.

TIERNEY BROS., 217 Genessee st.

MISSOURI.

Kansas City—THE WITTMANN CO.

NEBRASKA.

Lincoln—THE WITTMANN CO.

Omaha—THE WITTMANN CO.

NEW HAMPSHIRE.

Hillsboro Bridge—E. M. BARNES.

Manchester—A. E. DUMAS

Nashua—F. A. MCMASTER & CO.

NEW JERSEY.

Atlantic City—SAM'L D. WOLF, 32-34 Arkansas ave.

Bayonne—I. WIGDOR, 450 Avenue D.

Jersey City—W. L. HOFFMAN, 151 Montgomery st.

Newark—R. L. CORWIN; also New York City.

Passaic—I. HURWITZ.

Paterson—CHAS. H. KELLY, 25 N. Main street.

Plainfield—S. W. FRUCHT, or R. FRUCHT; also
New York City.

ELSTON M. LEONARD.

West Hoboken—EMIL HOLLANDER, or THE WEST
HOBOKEN BICYCLE & PHONO-
GRAPH CO., 619 Spring street.

NEW YORK.

Albany—G. LINDE, 353 S. Pearl street.

Bedford Park—GEO. H. TYRRELL.

Hobart—F. H. MARSHALL.

New York City—A. T. ARMSTRONG, or AMERI-
CAN PHONOGRAPH CO., 106
Wall street.

BERN BEARWALD, 373 W. 11th st.

BRONX PHONOGRAPH CO. or

DAVID SWITKY, 506 Willis ave.

CENTRAL PHONOGRAPH CO.,
160 E. 42d street.

R. L. CORWIN; also Newark, N. J.

EAGLE PHONOGRAPH CO., or C.

LOWENTHAL, 83 Nassau street.

EMPIRE PHONOGRAPH CO., 2 W.
14th street.

S. W. FRUCHT, or R. FRUCHT, 7
Barclay street, or 68 Cortlandt
street; also Plainfield, N. J.

O. HACKER, 2 Murray street.

HAWTHORNE & SHEBLE, 297

Broadway; also Philadelphia, Pa.

HOLOBER BROS., 350, 421 and 491
West st.

N. HORN, 148 E. 58th street.

W. L. ISAACS, 114 Fulton street.

S. LEMBURG & CO., 194 Broadway.

J. MCELLYNNE, 202 Broadway.

RICHMOND PEASE, 44 W. 132d st.

F. M. PRESCOTT, 44 Broad st.

WINTHROP CYCLE CO., 2212 Sev-
enth avenue.

Rome—CHARLES TUTTLE.

Saratoga—W. J. TOTTEEN.

Saratoga Springs—MARVIN A. COTE.

Syracuse—SPALDING & CO.

OHIO.

Cincinnati—J. L. ANDEM.

Coshocton—BURNS & GOSSER.

Springfield—D. & M. VANDERPOOL.

Uhrichsville—F. A. MAZURIE.

PENNSYLVANIA.

Philadelphia—A. R. CASSIDY, 2783 Emerald street.

HAWTHORNE & SHEBLE, 604 Chest-
nut street, or Oxford and Mascher
streets; also New York City.

A. KROUSE, 832 Arch street.

PENN NOVELTY CO., 15 South 9th st.

Phoenixville—KEINARD BROS.

Pittsburg—A. LIPPARD, 615 Wylie ave.

RHODE ISLAND.

Providence—F. P. MOORE.

WISCONSIN.

Milwaukee—J. C. BLATZEK.

*Added Since February 1, 1905.

Jobbers and Dealers are asked to co-operate with us, FOR OUR MUTUAL GOOD, by being careful that they do not supply any of the above named firms with our apparatus, either at addresses given or any other address.

JOBBER'S OF EDISON PHONOGRAPHS AND RECORDS.

ALABAMA.

Birmingham—The Ray Co., 2027 Second avenue.
The Talking Machine Co.
Mobile—W. H. Reynolds, 167 Dauphin street.

CALIFORNIA.

San Francisco—Peter Bacigalupi, 786-788 Mission street.

COLORADO.

Denver—Denver Dry Goods Co., 619 16th street.

CONNECTICUT.

Middletown—Caulkins & Post Co., 406-408 Main street.
Hartford—Harry Jackson, 300 Asylum street.
New Haven—Pardee-Ellenberger Co., 155 Orange st.

DISTRICT OF COLUMBIA.

Washington—E. F. Droop & Sons Co., 925 Pennsylvania avenue, N W
S. Kann, Sons & Co., 8th and Pennsylvania avenues.

GEORGIA.

Atlanta—Atlanta Phonograph Co., 49 Peachtree St.

ILLINOIS.

Chicago—James I. Lyons, 73 Fifth avenue.
Siegel-Cooper Co., State and Congress sts.
Talking Machine Co., 107 Madison street.
The Vim Co., 68 E. Lake street.
Montgomery Ward & Co., 111 Michigan ave.
Rudolph Wurlitzer Co., 302 Wabash ave.
Peoria—Peoria Phonograph Co., 222 Bridge street.

INDIANA.

Indianapolis—Craig-Jay Co., 234 Massachusetts ave.
Kipp Bros. Co., 37 S. Meridian street.
A. B. Wahl Co., 119 S. Illinois street.
Lafayette—A. B. Wahl Co., 304 Main street.

IOWA.

Des Moines—Hopkins Bros. Co., 620 Locust street.
The Vim Co., 704 West Walnut street.
Fort Dodge—Early Music House, 822 Central ave.

KENTUCKY.

Louisville—The Ray Co., 640 Fourth street.

LOUISIANA.

New Orleans—William Bailey, 600 Frenchman street.
National Automatic Fire Alarm Co.,
614 Gravier street.
The Ray Co., 111 Camp street.

MAINE.

Bangor—S. L. Crosby Co., 186 Exchange street.
Portland—W. H. Ross & Son, 207 Commercial street.

MASSACHUSETTS.

Boston—Boston Cycle & Sundry Co., 48 Hanover street.
Eastern Talking Mach. Co., 177 Tremont st.
Iver Johnson Sptg. Goods Co., 163 Washington street.
Read & Read, 558 Washington street.
Fitchburg—Iver Johnson Sptg. Goods Co., 247 Main st.
Lowell—Thomas Wardell, 111 Central street.
Worcester—Iver Johnson Sptg. Goods Co., 304 Main st.

MICHIGAN.

Detroit—American Phono. Co., 106 Woodward ave.
Grinnell Bros. 219 Woodward ave.
The Ray Co., 252 Woodward avenue.
Saginaw—Morley Bros.

MINNESOTA.

Minneapolis—Thomas C. Hough, 714 Hennepin ave.
St. Paul—W. J. Dyer & Bro., 21-23 West 5th street.
Minnesota Phonograph Co., 37 E. 7th street.
Thomas C. Hough, 302 Wabasha street.

MISSOURI.

Kansas City—J. W. Jenkins' Sons Music Co., 1013-1015 Walnut street.
The Ray Co., 1021 Grand avenue.
St. Louis—Conroy Co., 1115 Olive street.
O. K. Houck Piano Co., 1118 Olive street.
The Ray Co., 923 Olive street.

NEBRASKA.

Lincoln—H. E. Sidles Cycle Co., 1317 O street.
Omaha—Nebraska Cycle Co., 15th and Harney streets.
Omaha Bicycle Co., 16th & Chicago sts.

NEW JERSEY.

Hoboken—Eclipse Phono. Co., 205 Washington st.
Newark—A. O. Petit, New and Halsey streets.
Pateron—James K. O'Dea, 117 Ellison street.
Trenton—Stoll Blank Book and Stationery Co., 30 E. State street.

NEW YORK.

Albany—Finch & Hahn, 92 State street.
Brooklyn—Chapman & Co., Fulton and Duffield streets.
A. D. Matthews' Sons, 394 Fulton street.
Price Phonograph Co., 1258 Broadway.
Buffalo—P. A. Powers, 643 Main street.
Elmira—Elmira Arms Co., 117 Main street.
Gloversville—American Phono, Co., 99 W. Fulton st.
Kingston—Forsyth & Davis, 307 Wall street.
New York City—Bettini Phono. Co., 80 Chambero street.
Blackman Talking Machine Co., 19 Beekman street.
J. F. Blackman & Son, 2654 3d avenue.
I. Davega, Jr., 802 Third avenue.
S. B. Davega, 32 E. 14th street.
Douglas Phono. Co., 89 Chambers st.
H. S. Gordon, 139 Fifth avenue.
Harry Jackson, 219 Bowery.
Jacot Music Box Co., 39 Union Square.
Victor H. Rapke, 1661 Second avenue.
Siegel-Cooper Co.
John Wanamaker.

Poughkeepsie—Price Phonograph Co., 203 Main st.
Rochester—A. J. Deninger, 347 North street.
Mackie Piano, O. & M. Co., 100 State street.
Giles B. Miller, 63 State street.
Talking Machine Co., 29 Clinton avenue, S.
Schenectady—Finch & Hahn, 456 State street.
Jay A. Rickard & Co., 253 State street.
Syracuse—W. D. Andrews, 216 E. Railroad street.
Troy—Finch & Hahn, 7 Third street.
Troy Automobile Exchange, 359 Fulton street.
Utica—Clark-Horrocks Co., 54 Genesee street.
Arthur F. Ferriss, 89 Washington street.
William Harrison, 41 Columbia street.
Utica Cycle Co., 31 Columbia street.

OHIO.

Canton—Klein & Heffelman Co., 216 N. Market street.
Cincinnati—Ilsen & Co., 25 W. 6th street.
The Ray Co., 143 West 5th street.
A. B. Wahl Co., 805 Vine street.
Rudolph Wurlitzer Co., 10-12 W. 4th st.
Cleveland—W. J. Roberts, Jr., Erie and Huron streets.
Columbus—Perry B. Whitsit Co., 213 S. High street.
Dayton—Niehaus & Dohse, 35 E. 5th street.
East Liverpool—Smith & Phillips Music Co.
Newark—Hoover-Ball Co., Inc.
Toledo—Hayes Music Co., 608 Cherry street.

PENNSYLVANIA.

Allegheny—Henry Braun, 500 Federal street.
Allentown—G. C. Aschbach, 539 Hamilton street.
Easton—William Werner, 401 Northampton street.
Philadelphia—C. J. Heppe & Son, 1117 Chestnut street.
Lit Bros., Market and 8th streets.
Penn Phonograph Co., 19 S. 9th street.
John Wanamaker.
Wells Phonograph Co., 41 N. 9th street.
Western Electric Co., 931-933 Market st.
H. A. Weymann & Son, 923 Market st.
Harrisburg—S. K. Hamburger, 12-14 N. Market sq.
Pittsburg—Theo. F. Bentel Co., Inc., 632 Liberty street.
Kaufmann Bros., Fifth avenue.
H. Kleber & Bro., 221 Fifth avenue.
C. C. Mellor Co., 319 Fifth avenue.
Pittsburg Phono. Co., 937 Liberty avenue.
Reading—Reading Phonograph Co., 809 Penn street.
Scranton—Ackerman & Co., Coal Exchange Building.
Technical Supply Co.

RHODE ISLAND.

Pawtucket—Pawtucket Furniture Co., 39 N. Main St.
Providence—J. M. Dean Co., 785-795 Westminster street.
J. A. Foster Co., Weybosset st.
Household Furniture Co.
J. Samuels & Bro., 154 Weybosset street.
A. T. Scattergood & Co., 106 N. Main st.

TENNESSEE.

Knoxville—Knoxville Typewriter and Phonograph Exchange, 311 Clinch street.
Memphis—O. K. Houck Piano Co., 359 Main street.
The Ray Co., Lyceum Building.
Nashville—Nashville Talking Mach. Co., 510 Church st.
The Ray Co., 13-15 The Arcade.

TEXAS.

Dallas—C. B. Harris, Agt., 347 Main street.
Fort Worth—Cummings, Shepherd & Co., 700 Houston st.
Houston—H. M. Holleman Co., 612 Fannin street.

VIRGINIA.

Richmond—The Ray Co., 720 E. Main street.

WISCONSIN.

Milwaukee—McGreal Bros., 173 3d street.

CANADA.

Toronto—R. S. Williams & Sons Co., Limited,
143 Yonge street.

DOUBLE SERVICE

Language Study

Amusement

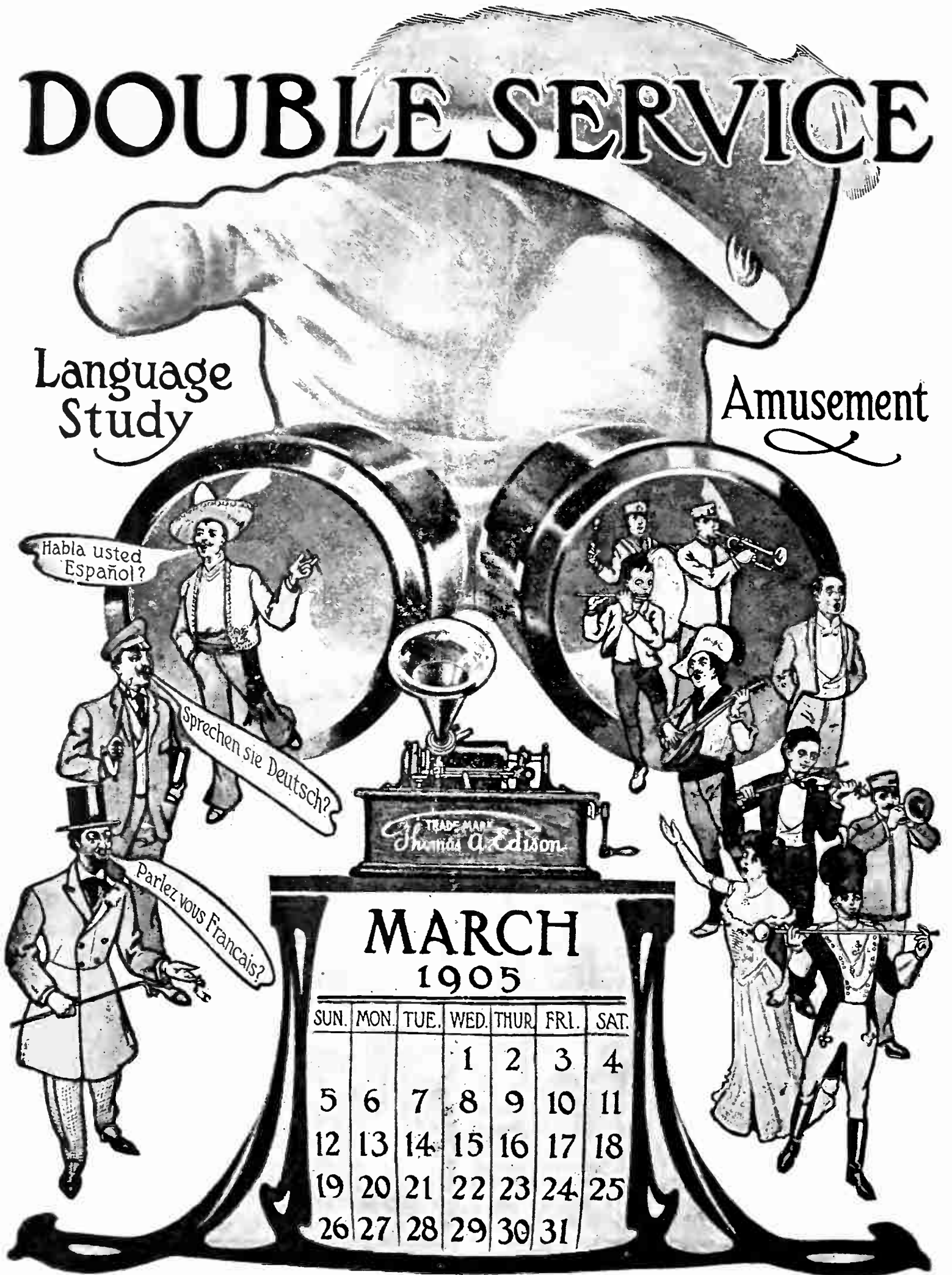

MARCH
1905

SUN.	MON.	TUE.	WED.	THUR.	FRI.	SAT.
			1	2	3	4
5	6	7	8	9	10	11
12	13	14	15	16	17	18
19	20	21	22	23	24	25
26	27	28	29	30	31	

The Edison Trade are the only merchants allowed to sell I. C. S. Language Outfits. Send \$2.00 for Agent's Sample Outfit and instructions for representing "Double Service," including sample moulded records in French, German, Spanish, and English. **Write today!** Address:

LANGUAGE DEPARTMENT
INTERNATIONAL CORRESPONDENCE SCHOOLS
SCRANTON, PA.

FOR FOREIGN SALES, ADDRESS: { Foreign Dept., National Phonograph Co., 31 Union Square, New York City.
European Headquarters, National Phonograph Co., Ltd., 25 Clerkenwell Rd., London, E.C.

EDISON Phonograph Monthly

PUBLISHED FOR TRADE USE ONLY BY
THE NATIONAL PHONOGRAPH CO.

VOL. III.

ORANGE, N. J., APRIL, 1905.

No. 2.

NATIONAL PHONOGRAPH CO.

ORANGE, N. J.

NEW YORK: 31 UNION SQUARE.

CHICAGO: 304 WABASH AVENUE.

SAN FRANCISCO: 786 MISSION STREET.

NATIONAL PHONOGRAPH CO., LTD., 25 CLERKENWELL
ROAD, LONDON, ENG.

EDISON PHONOGRAPHS AND RECORDS.

All communications to THE PHONOGRAPH MONTHLY
should be addressed to the Advertising Department,
Orange, N. J.

C O N T E N T S

Why the Edison Business Grows.....	1
Cannot Make Special Records.....	3
Figure it Out.....	3
For Future Growth.....	3
No Longer a Side Line Only.....	4
April Advertising.....	4
Personal	4
Printed Matter.....	5
Must Place Initial Order.....	5
Danced to Phonograph Records.....	5
A Good Circular.....	6
The Phonogram.....	6
Lew Fields' First Speech.....	6
Circulate Printed Matter.....	7
The Exchange Proposition.....	7
New Year's in Jamaica.....	7
Comments on May Records.....	8
Recognized as a Musical Industry.....	10
Doings of the Jobbers.....	10
A Western Dealer's Advertisement.....	10
National Phono. Co.'s New Offices.....	11
A Follow-Up Letter.....	11
Brought Back Sad Memories.....	11
Both Equally Good.....	11
I. C. S. Language System.....	12
Moulded Records.....	12
Come and See Us.....	12

WHY THE EDISON BUSINESS GROWS.

"To what do you attribute the unusual growth of your Edison business in the past year," was a question that we put to one of our large Jobbers when visiting in the East recently. This Jobber also handles other makes of talking machines. "Has it been due to the lower price of Edison Records, a greater amount of advertising, the prosperity of the country, or what?" we continued.

"All of these have had an effect, of course," was the reply, "but I think the real reason is the fact that the public are realizing to a greater degree than before the marked superiority of the Edison Phonograph over all other kinds of talking machines. This is not new. The superiority has always existed and this fact has been known to thousands. People, however, are becoming better posted on the talking machine question, and this knowledge is helping Edison goods more and more all the time."

These remarks probably represent the real reason for the phenomenal growth of Edison business in the past year. The efforts of all manufacturers of talking machines to sell goods is causing people to buy, and once the owner of any kind of a machine, no matter how cheap or poor, it becomes a simple matter to discover which are good and which are indifferent. Like the toy camera, the possession of one soon causes a desire for something better. The owner of a cheap talking machine is ready to discard it after a few days and he then begins to look around for another. Before he buys, however, he gathers in all the information he can, and this leads him straight to the Edison Phonograph. So, too, with even the expensive machines of other makes. If he gets one, it is because he has not had an oppor-

(Continued on Page 3.)

THE ADVANCE LIST OF MAY RECORDS APPEARS ON PAGE 2. ORDER FROM IT. NO OTHER ADVANCE LIST WILL BE ISSUED.

NEW EDISON GOLD MOULDED RECORDS. ADVANCE LIST FOR MAY, 1905.

RECORDS listed below will be ready for shipment as near April 25th as possible, at which time Jobbers' stock orders, if received prior to April 10th, will be shipped. May Supplements will be forwarded to Jobbers with their stock order for Records. Retail Dealers should place stock orders with their Jobbers at once, to insure prompt shipment as soon as Jobbers' stock is received.

- | | | |
|------|--|-----------------------------|
| 8978 | Always Forward March (<i>Missud</i>) | Edison Military Band |
| 8979 | Tammany (<i>Edwards</i>) <i>Topical Male duet, Orch. accom.</i> | Collins & Harlan |
| 8980 | Just Like the Ivy, I'll Cling to You (<i>Castling</i>)
<i>Descriptive song, Orch. accom.</i> | Harry MacDonough |
| 8981 | Selection from Woodland (<i>Luders</i>)
<i>Introducing "If You Love Me Lindy," "Dainty Little Ingenue," and "The Tale of a Turtle Dove."</i> | Edison Symphony Orchestra |
| 8982 | Heinie (<i>Vaudeville Specialty</i>)
<i>With orchestral incidental music.</i> | Ada Jones and Len Spencer |
| 8983 | 'Taint de Kind o' Grub I've Been Gettin' Down Home (<i>Smith & Brown</i>)
<i>Coon song, Orch. accom.</i> | Bob Roberts |
| 8984 | Professor and the Musical Tramp (<i>Vaudeville Musical Act</i>)
<i>Introducing humorous dialogue, Ocarina duet, Mandolin and Banjo duet, Trombone and Cornet duet, and orchestral incidental music.</i> | Spencer and Hunter |
| 8985 | Excelsior (<i>Balfe</i>)
<i>Tenor and Baritone duet set to Longfellow's poem, Orch. accom.</i> | Anthony and Harrison |
| 8986 | I've Set My Heart on You (<i>Von Tilzer</i>)
<i>Descriptive Waltz song, Orch. accom.</i> | Byron G. Harlan |
| 8987 | Belle of the Philippines March (<i>Stone</i>) | Edison Concert Band |
| 8988 | Two Rubes and the Tramp Fiddler
<i>Talking and singing male duet.</i> | Harlan and Stanley |
| 8989 | You Ain't the Man I Thought You Was (<i>Helf</i>)
<i>Coon song, Orch. accom.</i> | Miss Ada Jones |
| 8990 | He's Me Pal. Medley
<i>Xylophone solo, with Orch. accom., introducing "He's Me Pal," "Down at the Baby Store," "Daddy Dear," and "In the Shade of the Old Apple Tree."</i> | Albert Benzler |
| 8991 | I've Got a Little Money and I've Saved It All for You (<i>Silver</i>)
<i>Coon duet, Orch. accom.</i> | Murray and Roberts |
| 8992 | Murphy (<i>Von Tilzer</i>) <i>Serio-comic Irish song, Orch. accom.</i> | Edward M. Favor |
| 8993 | Garry Owen Medley
<i>Violin solo, Orch. accom., introducing "Garry Owen" Jig, "17th of March" Reel, "Haste to the Wedding" Country Dance, "Reilly's Own Reel, "Champion" Jig, and "Killarney."</i> | Eugene A. Jaudas |
| 8994 | Leaf by Leaf the Roses Fall (<i>Bishop</i>)
<i>Male quartette, Orch. accom.</i> | Edison Male Quartette |
| 8995 | Good Night, Little Girl, Good Night (<i>Macy</i>) <i>Song, Orch. accom.</i> | Irving Gillette |
| 8996 | Religioso March (<i>Chambers</i>)
<i>Introducing "Onward Christian Soldiers" and "Adeste Fideles."</i> | Edison Concert Band |
| 8997 | Just My Style (<i>Hubbell</i>)
<i>Contralto and Baritone duet from the musical comedy "Fantana," Orch. accom.</i> | Miss Morgan and Mr. Stanley |
| 8998 | When Father Laid the Carpet on the Stairs <i>Comic song, Orch. accom.</i> | Billy Murray |
| 8999 | Yankee Land (<i>Hoffman</i>)-
<i>March from "The Rogers Bros. in Paris," Banjo solo, Orch. accom.</i> | Vess L. Ossman |
| 9900 | Preacher and the Bear (<i>Arzoma</i>) <i>Coon song, Orch. accom.</i> | Arthur Collins |
| 9901 | Oh, Oh, Sallie Medley
<i>Introducing "Oh, Oh, Sallie," "Farewell, Mr. Abner Hemingway," "When the Bees Are in the Hive," "Jasper, Don't You Hear Me Calling You," and "Billy."</i> | Edison Military Band |

Edison Gold Moulded Records are made only in Standard Size. Both Standard and Concert Records may be ordered from this list. Order by number, not title. If Concert Records are wanted, give the number and letter C.

(Continued from Page 1.)

tunity to hear the Phonograph, and before long he realizes that his machine does several things besides reproduce music. He becomes dissatisfied, and even if he cannot afford to discard his machine and buy a Phonograph he is free to advise his friends on the subject. In this way the whole people are becoming better informed on the talking machine question, and thus the demand for Edison Phonographs and Edison Gold Moulded Records grows greater day by day.

Every resource was used at the factory of the National Phonograph Co., Orange, N. J., in the past month to meet the demand for Edison goods, but it was not successful. We turned out more Phonographs and more Records than in any previous month and yet we failed to make much of a gain on orders, the number on file at the close of the month being practically as large as at the beginning. The demand for Edison Phonographs and Records would make it appear as if the whole country had been seized with determination to have a Phonograph, or, having one, to buy a large stock of new Records. The advance orders for April Records again exceeded the advance orders for any month since the organization of the company, being nearly fifty per cent. greater than the combination list for November-December. Nor is there any apparent diminution in the situation, each day bringing its full quota of new orders.

CANNOT MAKE SPECIAL RECORDS.

Requests are occasionally made by Dealers to have special Records made of subjects or songs selected by them. They do not seem to be aware that the moulded process of making records is a much more expensive one than when soft wax originals were made and sold. Under present conditions, it is practically impossible to consider making Records of special subjects. Our Recording Department is always glad to know the opinions of Dealers as to what class of Records are salable in their locality, and will do whatever it can to meet this demand. At the same time the trade does not want to have us make a large number of new selections each month, twenty-five a month, or three hundred a year, with special supplements, being about as many as they care to have added to the Catalogue. With this limitation we are practically compelled to put out only such selections as will be in general demand throughout the entire country. Every Jobber

and every Dealer carrying a full stock of our Records would be put to an inconvenience, if not loss, if we listed titles not salable in his territory. Records, for instance, that glorify one city or one small section of the country may seem desirable in those places, but they could not be sold to any extent elsewhere. For this reason, we frequently feel compelled to refuse to list what may seem to the senders as desirable and good selling subjects. Still the business cannot fail to be benefited by an exchange of opinions and we welcome any suggestions from Dealers as to desirable subjects for Records that they may desire to offer.

FIGURE IT OUT.

Judging from the little attention that some Jobbers pay to the jobbing end of their end of their business it would seem as if they did not regard it as profitable. This is possibly because they think the profits small. The difference between 'Jobbers' and Dealers' discounts may not seem large, and yet they yield an excellent profit upon the capital invested. Any Jobber who has not thought the Jobbing end worth pushing will be surprised if he figures out the average jobbing profits on the entire Edison line. The cost, too, of handling goods on a jobbing basis is much less proportionately than a retail business.

FOR FUTURE GROWTH.

Deeds were recorded in March for a large plot of ground, nearly equal in size to a city block, which has been purchased by the National Phonograph Co., at Orange, N. J. The present factory occupies an entire block bounded by Valley Road, Lakeside Avenue, Alden Street and Watchung Avenue. The new plot is on the opposite side of Alden Street from the present factory and runs from Valley Road nearly to Watchung Avenue. This new plot of ground will be used by the company for future extensions of its business. Its plans in this respect are not ready for publication.

PRICES OF EDISON RECORDS.

Edison Gold Moulded Records, standard size, are sold in the United States at 35 cents each, and in Canada at 40 cents each. The Canadian price is higher because of the duty. Edison Concert Records are sold at 75 cents each in both countries.

NO LONGER A SIDE LINE ONLY.

In the early days of the Phonograph business, few Dealers did more than carry Phonographs as a side line. They bought a few machines, a few Records and made it an incidental part of their business. It was regarded as a filler for dull seasons. Bicycle men took up the line to tide them over the winter months. Musical merchandise firms carried a small stock to help out the volume of their general business for the year and others handled the goods on much the same principles. Within the past year or two, this plan of selling Phonographs has given way to an entirely different method of handling them. Hundreds of Dealers have now made it the most important part of their business, some of them handling nothing else but talking machine goods, and even where other goods are also sold, the Phonograph end is the largest, most profitable and most important. Hundreds of others are finding out that it will pay them to give more attention to pushing the sale of Edison Phonographs, and are rapidly reaching a point where they will follow in the footsteps of their most progressive competitors, and devote most of their time and attention to the Phonograph end of their business. In small towns where the opportunities for sales are limited, it is not, of course, possible for Dealers to devote much of their time to the sale of Phonographs. The opportunities are probably too limited to make it worth while. At the same time there is not a Dealer in Edison Phonographs to-day who could not with advantage give more attention to the sale of these goods. A little more advertising, a little more personal solicitation, and the sending out of a little more printed matter to people likely to be interested, would have an effect that would surprise him at the end of the year. While the sale of Edison Phonographs and Edison Gold Moulded Records is little short of phenomenal at the present time, it is still far from what it will be when the public fully realizes the opportunities for amusement and entertainment afforded by a Phonograph, and when it realizes the difference in quality between the Edison Phonograph and other music reproducing devices. Any Dealer, no matter where located, can go over the names of people in his locality who are in a position to own a Phonograph and he will find that practically only a small proportion of them have a Phonograph. Those who can afford to buy one need only to be convinced of the delightfully entertaining powers

of the Phonograph to have one of them in their homes. What proportion of the homes in any locality, whether in city or country, have music of any kind in their homes? A comparatively small percentage may have pianos, but in many cases these instruments are only pieces of furniture, because no one can play them. In such homes and in all others where there are no other musical instruments, the Phonograph would fill every want. In fact, in many ways, it is superior to the piano because of the almost infinite variety of amusement afforded by it. The object of this article is to suggest to Dealers the advisability of giving more attention to pushing Edison goods in their localities, and those who give attention to the subject will thank us for the suggestion within a few months.

APRIL ADVERTISING.

On page 13 of this issue we reprint our full page magazine advertisement for April. This appears in about twenty of the leading publications of the country, publications with an aggregate circulation of several million copies. The feature of this advertisement is the use for the first time of the list of new Records. Since the April publications begin to appear as early as March 15, the March list was incorporated in the advertisement instead of the April. It was considered more advisable to advertise a list of Records that could be had when the publication appeared, rather than to print a list and tell the public that they could be had at some future time.

The special proposition referred to in this advertisement is to suggest to owners of old style Standard, Home and Triumph Phonographs that they get their Dealer to exchange a Model C Reproducer for their Model B on the usual exchange basis for reproducers. This, in most cases, will make their machines work as good as an up-to-date Phonograph.

The present advertising of the National Phonograph Co. is the most adequate we have ever done and shrewd Dealers are supplementing it with advertisements in their local papers and thereby getting a direct return from this magazine advertising. An advertisement in a local paper, a neatly worded circular letter, or one of the folders or cards issued by this company, reaching a man when his interest has been secured by reading our magazine advertising, is very apt to cause him to drop in at a Dealers' store and at least give the Phonograph a trial. The list of new Records will probably be made a feature of our magazine advertising if we find that it has an effect upon the sale of Records.

PRINTED MATTER.

The first copies of the Record Catalogue for April, Form 670, will be sent out bound with the present cover. Having a limited number of these on hand, and the new cover not being quite ready, we have decided to put out the new Catalogue in this way rather than ask the trade to wait for the new cover. Form 670 will not contain any of the titles cut out by the circular letter of February 18, and it will contain all new titles to and including April. The orders already received from Jobbers for this Catalogue will be filled as rapidly as possible, partial shipments being made in most cases in order that no one will be compelled to wait for a supply. We trust, however, that Jobbers will use up their supply of the present edition before sending out the new one.

The little bookmark mailed a month ago has proved to be so popular a Form that the edition is already nearly exhausted. We regret that we did not order a much larger quantity of these.

The omission of two hundred and twenty-one titles from the Catalogue has, naturally, created a demand for a new Numerical Catalogue. The work of getting one out has been begun, but it will probably be several weeks before it is ready for trade use. When ready a copy will be mailed to every one in the trade.

The demand for Record Supplements continues to grow with the increased demand for Records, showing quite clearly that this form is being advantageously used by Jobbers and Dealers in getting business. The plan of getting up mailing lists is being more and more adopted by Dealers, who report that they find it well worth the trouble and expense. Every Dealer should make such a list of people in his locality who own Phonographs or any other style of machine upon which Edison Records can be played, and see that such owners get a list of the new Edison Records each month.

PERSONAL.

J. R. Schermerhorn, Assistant General Manager of the National Phonograph Co., returned on March 20 from a six weeks' tour of the branch offices of the company at London, Paris, Berlin and Brussels.

Edgar W. Dennison, of Orange, has been elected Secretary of the National Phonograph Co.

The National Phonograph Co. will have an exhibit for advertising purposes only at the Lewis & Clark Exposition to be held at Portland, Oregon, June to November. It will be in charge of Peter Bacigalupi, our San Francisco Jobber.

MUST PLACE INITIAL ORDER.

The attention of Jobbers is especially called to the following paragraph printed at the foot of the first page of the Retail Dealers Agreement Form, No. 590.

"Any Dealer desiring to handle our apparatus must place an initial order for at least three machines, each of a different style, and one hundred and fifty (150) Records. In addition, he must have an established store suitable to display and handle our goods, and at all times carry a sufficient stock for exhibition and sale purposes."

This means that before anyone can become a Dealer in Edison goods he must place an initial order for three machines and 150 Records. It does not mean that because he sells other talking machine goods he can get Dealers' discounts on Phonographs and Records. The latter was allowed under the previous Agreement, Form No. 440, but it was changed to the above, when No 590 went into effect.

DON'T HIDE YOUR LIGHT.

Dealers should understand that the talking machine light should not be hidden under the bushel of indifference. They must advertise so that their wares are intelligently presented to the people in their vicinity. A house that advertises itself persistently is bound to win, and advertising when well constructed and well placed is the best investment that can be made by a live talking machine agent. It should be particularly emphasized that the new things of to-day will be the old things of to-morrow, for the onward march of progress never halts. There is no business in which all that can be done has been done. When we study the development of this industry, it furnishes evidence of a progressive spirit behind the manufacturing department. The makers of talking machines are marching to the quick-step of progress. They go on from one victory to another; they never step backward.—*Talking Machine World.*

DANCED TO PHONOGRAPH RECORDS.

Wanatah, Ind., Feb. 20, 1904.

I wish to kindly inform you that I tried a Standard Phonograph and some of your Dance Records for dancing in a hall 24x52 feet in size last evening, and it proved a decided success. In fact the dancers, of whom there were twelve couples, were perfectly delighted with the results, saying it was the best music that they ever danced to. This is a place of about 700 population, and it has always been a hard matter to secure good music, as we have not efficient talent in town for such purposes. The Edison Phonograph will hereafter fill the bill. I used only a 36-inch horn and secured excellent results, but will hereafter use a 56-inch horn, which I think will prove even more satisfactory.

WILLIAM F. HUNT.

A GOOD CIRCULAR.

One of the notable bits of advertising literature of the past few months was sent in by the American Phonograph Co., Gloversville, N. Y. It was a four-page folder of large size and was an excellent medium for the sale of Edison goods. For the benefit of Dealers who may desire material for a similar advertisement we print the following:

EDISON PHONOGRAPHS.

Every lover of music should own a Phonograph. Nearly every one has heard these wonderful sound producing machines, but very few have heard them at their best.

To be able to have in your own home, at your command, the best music, whether it be instrumental, vocal or band, is the pleasure and privilege of a Phonograph owner.

A child can operate the machine as well as a grown person. It does not require an expert; in five minutes you can master it. The Phonograph takes up no room—it stands on the table when playing, and under it when idle.

Many new and distinguishing improvements have appeared on the Edison machines and Records during the past year and a half, which, without a doubt, places them nearer to perfection than any other talking machine or Record made.

The scratching and the shrill notes of the old-time Records and machines have been done away with by the Gold Moulded process by which all Edison Records are now made. A reproducer has been invented that is exactly adapted to these marvelous Records and with which every Edison Standard and Home Phonograph is equipped. This improvement can be fitted to any Phonograph however old, and on which we offer an exchange proposition.

The Phonograph is superior to all other instruments because of its endless variety. It is a tireless entertainer which brings the greatest of all pleasures to the home. It takes the place of a piano where there is none, or no one to play it. Beside, what would be a first installment on a piano will buy the sweetest Phonograph that ever played, with dozens of Records. It will let you dance in your own home, take you to the theatre or the minstrels, play rag-time, sing songs that will touch the heart and play marches that rouse the soul—all between supper and bed time.

One of the greatest pleasures and by far the most entertaining feature of the Phonograph is the making of Records yourself. That song your friend sings so well or the quartette of jolly fellows, or your musical friends with the banjo, violin or other musical instrument. The Phonograph stops at nothing, all are safely stowed away to be played over thousands of times. There is always a chance that some day this will be all you have. Then, how much would that Record be worth?

The Edison Phonograph is the only machine that you can make Records with.

THE PHONOGRAM.

Dealers desiring to get a supply of *Phonograms* to mail to their customers must order them of Jobbers four weeks in advance, and we cannot agree to fill Jobbers' orders unless placed with us a similar period in advance. We ran out of April *Phonograms* before they were shipped to the trade, although the edition was 200,000, and were unable to fill several orders received after March 20. We plan to print about 10,000 more than we have orders for when we go to press, five weeks in advance of the month of issue, but frequently these are soon used up with extra orders. Such was the case with the April issue.

Following is a schedule of prices at which *Phonograms* may be obtained by the trade:

DELIVERED WITH GOODS.

Blank, per 1000 copies..... \$2.50
Smaller quantities pro rata.
Imprinted, per 500 copies..... 1.50
Imprinted, per 1000 copies..... 2.75

No orders filled for less than 500 copies requiring imprint, and all imprinting orders must be for multiples of 500.

Most Jobbers will be glad to supply Dealers on the above basis.

BY MAIL.

Single copies, per year.....\$.20
Five copies to one address, per year..... .40
Twenty-five copies to one address, per year 1.80
Fifty copies to one address, per year..... 3.60

Unless they have open accounts on our books, Dealers ordering *Phonograms* sent by mail are requested to send cash or stamps with their orders. The amounts are too small to handle in any other way.

LEW FIELDS' FIRST SPEECH MADE WITH THE AID OF A PHONOGRAPH.

Lew Fields made the first speech of his life at the professional matinees given at the Lew Fields Theatre yesterday afternoon. Mr. Fields has been on the stage for twenty-seven years, but never in all that period has he dared address to an audience other than the lines written for him by the librettist. Yesterday, however, when the curtain fell on the first act of "It Happened in Nordland," he apologized for his inability to talk and then said, "My friend on the right will talk for me." Immediately a powerful Phonograph proclaimed to the audience the pleasure which Mr. Fields and his company experienced in playing this special engagement. The Phonograph ended the speech, as do all speakers, by saying, "I thank you, I thank you. I thank you."—*New York Sun*, March 24, 1905:

CIRCULATE PRINTED MATTER.

The ambition of every Jobber in Edison goods should be to sell \$2 worth of Phonographs where last year he sold but \$1 worth. One of the easiest and yet most effective ways of doing this is to see that Dealers are kept supplied with every new catalogue or other form gotten out by this company. It is not necessary to send large quantities of these and thereby waste them, but every Dealer should be kept up-to-date in this respect. We get letters from Dealers complaining that their latest Record Catalogue is a year old, and that they cannot get printed matter from their Jobbers. If we look into the matter we find that the Jobber who has signed the Dealer is one who does not make a systematic effort to send printed matter to his Dealers, and we also find that he makes no effort to keep up his own stock of advertising literature. We also find under scrutiny that the Jobber is one who is doing a limited business. We find that the largest users of printed matter per Dealer are those who are doing the largest business per Dealer. These Jobbers are careful to see that their Dealers get a share of all new forms. They find that this not only increases the business of these Dealers, but it brings other Dealers whose Jobbers have not taken proper care of them in this respect. That the careful distribution of printed matter brings business to everyone is no mere theory. We know that it does. The quantity of catalogues and other forms printed by this company in the past year far exceeded that of any previous year, and the business increased in the same proportion. Any Jobber who will give this part of his business proper attention will find it profitable beyond his expectation.

THE EXCHANGE PROPOSITION.

The three for one exchange Record proposition terminated on March 15. All Records shipped by Dealers to Jobbers on that day, or by Jobbers to us were accepted for credit. This return proposition was the cause of considerable trouble to Dealers, Jobbers and ourselves, especially ourselves; but it has been voted by the entire trade a most excellent thing for clearing out the stocks of least salable Records. Every Dealer or Jobber who has fully availed himself of the proposition has been able to get rid of his surplus stock and replace it with better selling and more up-to-date selections. In this way it has enabled every one to practically begin his spring business with a brand new stock of Records. The effect of this clearing out of surplus stock will benefit the entire trade. It has been a popular move on the part of this company and has furnished an additional evidence that the trade may always rely upon our taking care of them in the best possible manner.

NEW YEAR'S IN JAMAICA.

[The article printed below was published in "The Message," issued by the First Universalist Church, Worcester, Mass.]

The following is an extract from a recent letter received from Charles M. Harrington, who has been for nearly a year past following his profession of architect in Jamaica. His many friends in our church will be glad to hear again his breezy words:

"'Eight hands around—forward and back—right and left,' these are the sounds to-night, for one of the painters who arrived to-day brought a large Phonograph with him, and the men are all gathered in Mr. Mitchell's room, directly over me, to enjoy it. A Record has just been started playing 'Miss McLeod's Reel,' and instantly they formed a set. One is calling off. It is a rollicking dance, I can tell you, and the shuffling of feet on the tile floor, the shouts of laughter, the shrill sound of the piccolo playing the air, form a care-free combination I am glad to hear. Tired muscles, lazy negroes, longings for home are forgotten by the men. They are happy to-night.

"Now it is 'Good Old Summer Time,' and they are singing with the Phonograph. Some of them have very good voices. Every one knows that old melody and sings it with a will.

"Ah! here is one that brings me to my feet, I can hear them rising, too; 'The Star-Spangled Banner.' God bless it. Who says we are 1,500 miles from home? Not while that air is ringing in our ears. There it comes, I expected it. Bert Ray, one of our carpenters, has a beautiful high tenor; he is singing clear and sweet; his voice rings out; now every one is singing with him; and as the last note dies away, Murphy calls for 'three cheers for it, boys, it's ours.' Do they give them? Well!

"And now, is it accident or fate that selects the next tune, 'Lead, Kindly Light.' Twice it is played and then they sing it, softly and reverently.

"The night is dark and I am far from home,
Lead Thou me on."

"Rough, profane, coarse—men may be all of these, but that old hymn, the comfort of so many, will touch a tender responsive chord. No laughter nor jest in this. And then as though to relieve the serious side—a bit away—they all join in 'Bill Bailey.' There goes a rattling Sousa two-step, and again the tiles echo dancing feet. Bless the fellow who brought that Phonograph.

"Oh, Edison, in your wildest dreams you never imagined the pleasure your toy would give. And of the thousands who listen to the Records of voice and instrument, none is enjoying to the full extent like the little group gathered around the one upstairs, with the tropical night around us all and the murmur of the surf sounding from the rocks of coral. And I guess I am enjoying it too."

EDISON GOLD MOULDED RECORDS FOR MAY.

Up to the usual high standard and full of variety is the list of Edison Gold Moulded Records for May. Phonograph owners could buy the entire list with advantage and have at their disposal the means of entertaining a company of guests no matter how varied their tastes might be.

No. 8978, "Always Forward March," by the Edison Military Band, is a good, snappy, bright march composed by Jean M. Missud, Director of the Salem Cadet Band of Salem, Mass., several of whose compositions have already been listed in our Record catalogue.

No. 8979, "Tammany," by Collins and Harlan, is a topical song that deals humorously with New York's famous political organization in a way interesting to the whole country. The warwhoops of the "braves" add quite a striking bit of realism to the performance. The music of this composition is full of ginger and in keeping with the character of the words and meaning of the song. The composer is Gus Edwards and the words are by Vincent Bryan. The singers are accompanied by the orchestra.

No. 8980, "Just Like the Ivy, I'll Cling to You," by Harry MacDonough, is a pretty descriptive composition by A. J. Mills and Harry Castling. It is sung with orchestra accompaniment. 'Some day you'll be leaving me for a sweetheart,' said Grandad to the young maiden nestling beside him near the ivy-covered old garden wall. "Some day you'll be forgetting me." But with a smile the maid replied, in the chorus:

"Just watch the ivy on the old garden wall,
Clinging so tightly whate'er may befall;
As you grow older I'll be constant and true;
And just like the ivy, I'll cling to you."

No. 8981, "Selection from 'Woodland,'" by the Edison Symphony Orchestra, is a selection from the musical fantasy "Woodland," introducing "If You Love Me, Lindy," "Dainty Little Ingenue" and "The Tale of a Turtle Dove." These compositions are written by Gustav Luders and are among the most popular airs in this operetta. Companies are now playing "Woodland" in New York and throughout the country.

No. 8982, "Heinie," by Ada Jones and Len Spencer, is a Dutch vaudeville specialty introducing the song "Heinie." The scene is in the theatre with orchestra, and all the incidental effects are introduced realistically. The music of this song was written by Ted Snyder and the words by Edward Rose. The Record is cleverly made by Miss Jones and Mr. Spencer and cannot fail to achieve wide popularity.

No. 8983, "Taint de Kind o' Grub I've Been Gettin' Down Home," by Bob Roberts, is a coon song that tells about Sam Green, who just came up from the South and stepped in a small cafe to get a bite to eat. The dainties set before him did not appeal to his appetite. He said: "When I am hungry I likes to get

something; dat ain't de kind o' grub I've been gettin' down home. I likes my ham wid de marrow bone; kidney stew or possum sweet. I heard a heap of talk about 'Champion' wine. Fancy food I lets alone, 'cause 'taint de kind o' drub I been gettin' down home.'"

No. 8984, "Professor and the Musical Tramp," by Spencer and Hunter, is a vaudeville musical specialty of a unique character. It introduces an ocarina duet, a mandolin and banjo duet and concludes with a cornet and trombone duet, all accompanied by the orchestra. The scene is laid in a vaudeville theatre. The orchestra plays the opening to the act. The professor's partner has disappointed him. A musical tramp arrives on the scene and helps out the professor in the duets as above. A humorous dialogue between the professor and the tramp adds to the attractiveness of the Record.

No. 8985, "Excelsior," by Anthony and Harrison, is the famous musical setting by M. W. Balfe of Longfellow's poem. It introduces a new team of duettists in Anthony and Harrison, who sing tenor and baritone respectively. This is a remarkably fine Record of "Excelsior," known to the entire world by the refrain:

"The shades of night were falling fast,
As thro' an Alpine village passed," etc.

The singers are accompanied by the orchestra. The Record is one that will be wanted by every lover of high class music.

No. 8986, "I've Set My Heart on You," another delightful Record by Mr. Harlan. It is sung with orchestra accompaniment. The music of this song was written by Albert Von Tilzer, composer of "Tell Me With Your Eyes," (our Record No. 8945), "Teasing," (our Record No. 8804), and numerous other hits of the past season. The words are by Maurice Stonehill.

No. 8987, "Belle of the Philippines March," by the Edison Concert Band, is a characteristic selection with a catchy and tuneful melody. Written by Fred J. S. Stone and played with splendid expression and fine execution.

No. 8988, "Two Rubes and the Tramp Fiddler," by Harlan and Stanley, is described by our Recording Department as "ruralistic pastoralissimo." The two Rubes are discussing topics in their usual way when along comes a tramp fiddler. An amusing conversation takes place between the three. The tramp plays on the fiddle for them and accompanies the two Rubes while they sing "Handsome Julia." An excellent addition to our series of Rube Records.

No. 8989, "You Ain't the Man I Thought You Was," by Ada Jones, tells of the domestic troubles of a "cullud" lady whose better half has not provided for her wants to her satisfaction. The verse enumerates her numerous causes for complaint, climaxing in the chorus when she declares, "You ain't the man I thought you was," and "for me soon you won't do." Miss Jones' coon dialect will be found

very entertaining, equalled only by her conception of this class of songs. The rendition throughout shows the trained artist. The orchestra accompanies the singer. A coon dialect by the female voice is something new in our recent supplements. This coon song was written by Fred Helf and Lou Sully.

No. 8990, "He's Me Pal Medley," by Albert Benzler, is a xylophone solo with orchestra accompaniment, introducing "He's Me Pal" (our Record No. 8957), "Down at the Baby Store" (our Record No. 8845), "Daddy Dear" (our Record No. 8923), and "In the Shade of the Old Apple Tree" (our Record No. 8958). The orchestration is very effective in this Record, particularly the variation for cornet in the last song. This same effect was appreciated greatly in our last xylophone solo, Record No. 8931.

No. 8991, "I've Got a Little Money and I've Saved it All for You," by Murray and Roberts, is a coon song by Max Silver (music) and Edward Farrell (words), and sung with orchestra accompaniment. When he came to tell her that "all of his affection goes in her direction," he told her also that he's saved a little money all for her, and how he'd got a job as chambermaid in a livery stable at a salary of four dollars a week. He was very much disconcerted when she replied: "Four dollars a week! Why, man, that wouldn't pay for the cheese to feed the rat in my pompadour."

No. 8992, "Murphy," by Edward M. Favor, is an Irish serio-comic love song, with a very clever and catchy melody and an Irish flavor which grows upon the hearer each time the Record is played. Mr. Favor's especial forte is Records of this character, and "Murphy" is up to his usual standard. He is accompanied by the orchestra. Albert Von Tilzer wrote the music of this song and Sam Ehrlich the words. The chorus tells how Mrs. Murphy replied when he asked her to be his:

"Murphy, sure I can't resist your eyes,
Murphy, you have got me hypnotized,
Murphy, I'm as proud as I can be,
Mrs. Murphy is the name for me."

No. 8993, "Garry Owen Medley," by Eugene A. Jaudas, is a violin solo with orchestra accompaniment, introducing a medley of Irish jigs and reels. These include "Garry Owen" jig, "17th of March" reel, "Haste to the Wedding" country dance, "Reilly's Own" reel, "Champion" jig and "Killarney." The popularity of our Record No. 8678, "Pop Goes the Weasel" Medley, (violin solo with orchestra accompaniment), prompts us to offer another made on somewhat similar lines. Each Record is made by a different artist, Mr. D'Almaine having played the first, and Mr. Jaudas the present one.

No. 8994, "Leaf by Leaf the Roses Fall," by the Edison Male Quartette, is a very popular old song by T. B. Bishop (music) and Carolina Dana Howe (words). The verse alternates in the arrangement between a duet for first and second tenor and baritone and bass,

followed by the chorus with all four voices. The chorus:

"Leaf by leaf the roses fall,
Drop by drop the spring runs dry,
One by one beyond recall,
Summer roses droop and die."

No. 8995, "Good Night, Little Girl, Good Night," by Irving Gillette, is a song of the better grade, being unusually well written both in words and music. Its composer is J. C. Macy. Mr. Gillette's fine tenor voice renders the song in a thoroughly satisfying manner.

"May all the world's gladness be yours, dear,
And ev'ry day glorious and bright;
Is the wish that I'm always making,
When I say 'Little girl, good night.'"

No. 8996, "Religioso March," by the Edison Concert Band, introduces "Onward, Christian Soldiers" and "Adeste Fideles," two favorite religious hymns. The composition as played in this Record is admirably adapted to show off the different instruments in the band. The arrangement of the music is by W. Paris Chambers. This will be found a splendid band Record by those partial to music of a religious character.

No. 8997, "Just My Style," by Miss Morgan and Mr. Stanley, is a contralto and baritone duet with orchestra accompaniment, of this popular song from "Fantana," now being presented by the Jefferson De Angelis Co. This musical comedy had an extensive run in New York city, and is now being presented in the principal cities. Raymond Hubbell wrote the music of this song and Robert B. Smith the words. The characters in the song are Fantana and Sinclair.

SINCLAIR—

"Since first your radiant eyes met mine,
And gazed into their depths so blue,
I could plainly see you were meant for me,
And I was meant for you."

FANTANA—

"I knew at that time by right divine,
As well as I know it now,
That do what I might, I was yours all right,
Yet I can't explain just how."

No. 8998, "When Father Laid the Carpet on the Stairs," by Billy Murray, is an exceedingly ludicrous story of father's difficulties when attempting to lay the stair carpet. It also tells of the amusement of mother and the little ones as father's troubles grew. When father struck his thumb instead of the tack and said frightful things, why "Mother laid the carpet on the stairs." The fun in this Record and Mr. Murray's popularity will make it one of the big sellers of the month.

No. 8999, "Yankee Land March," by Vess L. Ossman, is an artistic banjo Record, with orchestra accompaniment, of this selection from "The Rogers Brothers in Paris," now en tour throughout the country. Mr. Ossman is so well known as a banjo player of the first rank that his Records are in great demand.

No. 9000, "Preacher and the Bear," by Arthur Collins, is a coon song written by Joe Arzoma and sung with orchestra accompaniment. A colored preacher went hunting on Sunday. Returning he met a grizzly bear. The

preacher climbed a persimmon tree and the bear took up a position underneath. The bear seemed in no hurry to depart so the preacher resorted to prayer, concluding with "Good Lord, if you can't help me, for goodness sake don't help that bear."

No. 9001, "Oh, Oh, Sallie Medley," by the Edison Military Band, introduces "Oh, Oh, Sallie" (our Record No. 8935), "Farewell, Mr. Abner Hemingway" (our Record No. 8963), "When the Bees are in the Hive" (our Record No. 8926), "Jasper, Don't You Hear Me Calling You" (our Record No. 8955), and "Billy" (our Record No. 8964).

RECOGNIZED AS A MUSICAL INDUSTRY.

The Phonograph and talking machine industry has now been regarded by the *Music Trade Review*, of New York City, as of sufficient importance to warrant the publication of a paper entirely devoted to this rapidly growing business. This new publication is called the *Talking Machine World*. It made its first appearance in January and its third issue was published on March 15. It includes twenty-four large pages, full of interesting trade notes, and its modest subscription price of fifty cents a year makes it possible for every dealer to become a subscriber. Its publication office is 1 Madison Avenue, New York City.

The *Music Trades*, one of the most important trade papers of the country, has also deemed the Phonograph business as worth a place in its pages, and has created a new department called "Talking Machine News." *Music Trades* treats of nothing else but musical instruments and musical merchandise.

DOINGS OF THE JOBBERS.

Among the visitors at our New York office during March were: G. L. Ackerman, of Ackerman & Co., Scranton, Pa.; E. J. Heffelman, of Klein & Heffelman, Canton, Ohio.; N. D. Griffin, of the American Phonograph Co., Gloversville, N. Y.; J. A. Rickard, Schenectady, N. Y.; C. J. Andrews, Boston Cycle & Sundry Co., Boston, Mass.; E. F. Taft, Eastern Talking Machine Co., Boston, Mass.; William Werner, Easton, Pa.; W. D. Andrews, Syracuse, N. Y.; John Rogers, Knoxville Typewriter & Phonograph Co., Knoxville, Tenn.; J. N. Willys, Elmira Arms Co., Elmira, N. Y.; Mr. Pardee and Mr. Ellenberger, of the Pardee-Ellenberger Co., New Haven, Con.; L. E. McGreal, of M. Greal Bros., Milwaukee, Wis.

New Edison Jobbers for March are the C. E. Osgood Co., Boston; Frank E. Bolway,

Oswego, N. Y.; R. L. Penick, Montgomery, Ala., and the Household Furnishing Co., New Bedford, Mass.

The Talking Machine Co., Rochester, N. Y., will remove April 1 from 29 Clinton Avenue S. to 97 Main Street E.

TRADE ADVERTISEMENTS.

Acknowledgment is made of the receipt during March of advertisements from the trade as follows: Judd R. Miller, East Springfield, Pa.; M. B. Willis, Jr., Auburn, Ind.; J. E. Jerd, Randolph, Vt.; Malhiot & Guillot, Thibodaux, La.; A. L. Thompson, Mayville, N. D.; Hartford Phonograph Co., Hartford, Conn.; Harry Jackson, Hartford, Conn.; John P. Dougherty, Chester, Pa.; J. H. Lepper; Spratt & Corcoran, Watertown, N. Y.; Texas Phonograph Co., Houston, Texas.; J. W. Jenkins Sons Music Co., Kansas City, Mo.; Alonzo Wilkes, Amsterdam, N. Y.; Marlboro Rubber Co., Marlboro, Mass.

A WESTERN DEALER'S ADVERTISEMENT.

SAID MR. A TO MR. B AND B SAID SOMETHING TO MR. A:

Mr. B lives in the country and while in town the other day was urged by Mr. A to come in and hear the band concert and bring his family. "What's the use?" said Mr. B. "I have at home a Standard Edison Phonograph, and every evening Mrs. B and I and the children enjoy a band concert that is far ahead of anything you will hear in an opera house, and we don't have to drive several miles to hear it. When we get tired of band music we can have songs, trios, quartets and everything else that's good."

THIS MAN BOUGHT HIS MACHINE OF
M. B. WILLIS, JR., AUBURN, IND.

A PHONOGRAPH AT A FUNERAL.

A well-known merchant belonging to the city of Cork is probably the first man to sing at his own funeral. A Phonograph was placed on the lid of the coffin. When the religious ceremonies were over the Phonograph was turned on, and the mourners in the church listened to the dead man singing the final Requiem of the Absolution. The Record is to be preserved, and it is intended to commemorate each anniversary of his death in a similar manner. The dead man had a fine baritone voice, and gave his services at many a public entertainment in the south of Ireland.—*London daily*.

NATIONAL PHONOGRAPH CO.'S NEW OFFICES.

The National Phonograph Co., who manufacture the Edison Phonographs and Records, have moved their sales department to the new building of the Bank of the Metropolis at No. 31 Union Square, where they occupy the entire fourth floor.

The new offices, besides being very much more advantageous, from a business standpoint, and more convenient to the trade that go there to order goods, are a great relief to those who have to use them. They are modern in every particular and are handsomely furnished. The private offices of the manager and his assistants are in the front, and back of these are the railed, partitioned compartments of the clerical force. The number of employees in this department is larger than it has ever been before, and the amount of business that is transacted there is very great.

"The Edison Phonograph business is at its height," said C. H. Wilson, who is in charge of the Sales Department and head of the new offices that overlook Union Square. "It is simply that we have never since this corporation has been established had so many and such large orders to fill. It would seem that no matter how frequently we enlarge our plant and increase our facilities we cannot keep up with the public demand for Edison Phonographs and Records. We are behind now, and the greatest effort that we can make is not enough to keep up with our orders.

"We find the offices up town to be in every way superior to the old quarters. The light was deficient in our old establishment, and here it is all we could wish. Besides this, the advantage to those who have business with us is very great, and they seem to appreciate it. We are seeing more of our friends, and we are glad of it. Altogether we can say the change has been a success."—*Music Trades*.

A "FOLLOW-UP" LETTER.

The following letter was sent by a Harrisburg Dealer to the address of an inquirer mailed by this company. It is reprinted for the benefit of those who may want to write a letter of the same kind:

We received a letter this morning from the National Phonograph Co., advising us of your inquiry in reference to a Phonograph or Gold Moulded Records. They appreciate the courtesy of your communication and advised us to treat you in a way that would add another happy customer to their long list of patrons throughout the United States and the world. Our store is at 28 South Fourth Street, Harrisburg, Pa., very close to the Pennsylvania depot, also the Chestnut Street Market, so that it is very convenient, should you make a call to our city. Or we shall take great pleasure in sending you an Edison Phonograph and a two

or three dozen record case, filled or partly so, with any of the famous Edison Records that may please you, you to send us a list either by name of piece or by number. If you choose to state your preference as to song, spoken pieces or band music, we will be pleased to pick you out a small collection, which we know will give you entire satisfaction. We will send these to the nearest express or railroad depot, not asking you for any money until the goods reach you, so that you may not be deprived of the pleasure which the great singers and bright lights of our country afford you, which is practically an up-to-date theatre at your own home. We don't think anything better could be invested which would afford you and your numerous friends as much pleasure as an Edison outfit, to which you can add the best Records produced by this great company, monthly, as they come out. This you can accomplish by placing an order with us to send you each month a certain number of Records that are in line with your own good taste.

Thanking you for your order in advance, and trusting to be favored with your valued patronage, and a call at our establishment when in our city, we beg to remain.

MCKENNA BANK SAFE Co.

BROUGHT BACK SAD MEMORIES.

"Last Friday evening we gave a concert with a Triumph Phonograph at the Derryfield lodge of Grangers, P. of H., and something remarkable happened during the entertainment," wrote Dean & Hebert, of Manchester, Vt., under date of March 3. "When we played No. 8872, 'Just Before the Battle, Mother,' a man rose from his seat with tears in his eyes. He said that his father was buried down South on the battlefield and that the song was so realistic it brought back sad memories of the past. It all goes to show that the Edison machine is the best on the market, and with us is increasing our sales right along."

BOTH EQUALLY GOOD.

The following letter was received by Thomas C. Hough, Edison Jobber at Minneapolis, Minn., who sent it to us with the following comment: "Inclosed you will find a letter from the North Star Lodge, I. O. O. F., which explains itself. As I am not a member of the lodge and the letter was unsolicited, it certainly speaks very highly for your machines. However, as they have no equal it would be difficult with any fair minded persons to decide otherwise."

Mr. Thomas C. Hough, Minneapolis:—

As you are the agent for the Edison Phonograph for this city and St. Paul, I thought you would be interested in a contest that was held in our lodge last evening.

Brothers Meyer and Wolcott, both being

owners of Edison Home Phonographs and a number of Edison Gold Moulded Records, entered into a contest as to which of the machines was the best. The N. G. appointed two judges and each contestant was to play six Records, Brothers Crist and Floerkey acting as the judges of the contest. About 100 members of the lodge and a large number of visitors from different parts of the United States were in attendance. After playing the six Records each, the judges were unable to decide, as both machines worked to perfection, and the selections were well chosen by Brothers Meyer and Wolcott. The judges then asked that each play three Records. After the playing of these the judges were still unable to render a decision, and required two more to be played. The judges pronounced both machines perfect in every way, and as they were still unable to render a decision, they declared the contest a draw. This announcement was received with long and loud applause. Every member present voted the Edison machines the best on the market, and every one expressed the wish that the contest would be repeated at some future date. Our lodge room is 48x60 feet, with a ceiling 20 feet high, and the machines could be distinctly heard in all parts of the hall.

A WORLD'S FAIR GRAND PRIZE FOR I.C.S. LANGUAGE SYSTEM

WITH
Thomas A. Edison
PHONOGRAPH

Undoubtedly the highest compliment ever paid to a talking machine was given to the Edison Phonograph when the Grand Prize for a language method was awarded to the I. C. S. Language System at St. Louis. No effort was made with the judges to obtain this recognition; but seven months of language demonstrations to thousands of visitors at the I. C. S. BUILDING brought the success of the method to the attention of Dr. Guido Biagi, of the Educational Committee. It was a surprise to know that Dr. Biagi had examined the Edison Phonograph unannounced, and was prepared to award the Grand Prize, as he afterwards did, to the I. C. S. method.

Every dealer in the Edison trade should have an I. C. S. lesson at hand to prove these qualities of sound reproduction that won the Grand Prize at St. Louis. "Double Service"—Amusement and Language Study—is the latest and best argument for the perfect talking machine in the Edison Phonograph.

QUIT TRYING TO SELL OTHERS.

Edison goods are more in demand every day in this locality. The coming of spring does not seem to lessen the interest, and the tendency is to the larger sized machines, Homes and Triumphs, with some sales of special finish machines. Have sold one Triumph machine with mahogany case and nickled top. Have quit trying to sell anything but Edison goods.
Cerro Gordo, Ill. E. T. GOSSETT.

MOULDED RECORDS.

Another advantage that the moulded, high-speed Records undoubtedly possess over their predecessors is their long wearing qualities. It seems quite impossible to wear them out by ordinary usage. This is because the wax composition contains ingredients that make it very hard. That the high-speed Records are louder than the old style is conceded by everyone. They have driven the large concert Records out of the market. The expectations raised by the invention of the machines with large cylinders, that they would revolutionize the entire talking machine industry, though perhaps in course of partial realization, were shattered completely when the principle of increased surface velocity, which they taught, was applied to record-making on the small stand and cylinders. Thereupon the small cylinder Record jumped further to the front than ever, and, notwithstanding the increasing competition of the disc variety, it remains even yet the leading factor in the consideration of those most familiar with the industry.—*Talking Machine News*, London.

BUSINESS FINE.

Frederick, Md., Feb. 27, 1905.

I sold four Home Phonographs and one Triumph last week, with 150 Records. I thought I would write and let you know that the business is getting fine. I am certainly pleased with the outlook for spring. The Records are all fine, and no end to magnificent comments. People are pleased beyond description with the monthly Records.

W. H. DYER.

COME AND SEE US.

We are so proud of our new offices at 31 Union Square, New York, that we hope no Jobber or Dealer visiting New York from a distance will fail to call and inspect them. It matters not if you don't know any of us personally. Just say that you are an Edison Dealer and someone will always find time to show you around and talk shop for a while.

OTHERS NOTHING IN COMPARISON.

Mexico, Feb. 13, 1905.

I am in receipt of the Phonograph, Records, etc., which were ordered a couple of weeks ago. I am glad to make use of this opportunity to show my satisfaction with the Edison Phonograph. I have heard many other talking machines * * * but all these machines are nothing when compared with the Edison Phonograph. The Edison Records have been improved greatly; they are loud enough, and free from that disagreeable noise which is the characteristic of the other machines.
EUG. M. OLAGUIBEL.

What Would Make You Want A Phonograph?

D ID you ever leave the theatre possessed by a charming air you could not recall? Did the concert ever leave a haunting memory of delight gone forever? Did you ever hear an orchestra play a beautiful melody, that you would like to hear again and again? Did you ever hear a passing band play a striking march, and regret that you could not master it and be able to whistle it at will?

Perhaps you "Don't know music"—"Don't play," and lacking these talents you abandon the gratification of these desires.

Don't give up.

Own an EDISON PHONOGRAPH.

Possessing one, you can have a Record of the lost music, and in the quietness of your home, play it over and over until you have mastered both music and words. The fleeting pleasure is made permanent.

An EDISON PHONOGRAPH and EDISON GOLD MOULDED RECORDS give this music with all the naturalness and pleasing quality of the original. Thomas A. Edison's many improvements now in his PHONOGRAPH have made it a delightfully entertaining instrument—a treat that asks only trial.

Here are the 25 EDISON GOLD MOULDED RECORDS for March. Edison Dealers throughout the country have them. Whatever your taste you will find some pleasing selections.

Make a choice, go to an Edison Dealer and ask him to play them for you on an EDISON PHONOGRAPH.

If you cannot reach a dealer, fill in the coupon below the list and mail to us, checking the catalogue you want.

If you have an old Phonograph not in use, send us its number. We have a special proposition for you.

NATIONAL PHONOGRAPH CO., Orange, N. J.
New York Chicago San Francisco London

I. C. S. Language Courses Taught by EDISON PHONOGRAPH.



New Records for MARCH

- 8928 A Sprig o' Shillalah Edison Concert Band
- 8929 Oh Promise Me, *Tenor Solo* Irving Gillette
- 8930 Never, *Comic Song* Bob Roberts
- 8931 Come Take a Trip in My Air Ship Medley, *Xylophone Solo* Albert Benzler
- 8932 It Makes Me Think of Home, Sweet Home, *Tenor Solo* Byron G. Harlan
- 8933 The Troubadour Edison Concert Band
- 8934 The White Swan Edison Symphony Orchestra
- 8935 Oh, Oh, Sallie, *Coon Duets* Collins & Harlan
- 8936 Mexico, from "Humpty Dumpty," Harry MacDonough
- 8937 Darkie Tickle Edison Military Band
- 8938 Marguerite, *Duet* MacDonough & Biehling
- 8939 The Bingville Band, *Comic Song* Arthur Collins
- 8940 Evening Star, Tannhauser, *Cello Solo* Hans Kronold
- 8941 Hans Krausmeyer and His Dog Schneider, *Coon Duets* Len Spencer & Alf Holt
- 8942 Can't You See My Heart Beats All for You, *Coon Duets* Murray & Roberts
- 8943 The Wren Polka, *Piccolo Solo* Frank S. Mazziotta
- 8944 Won't You Fondle Me, *Coon Love Song*, Arthur Collins
- 8945 Tell Me With Your Eyes Edison Male Quartette
- 8946 Ye Ancients March Edison Concert Band
- 8947 Tommy (Tell Me True), *Sentimental Duets*, Harlan & Stanley
- 8948 My Carolina Lady, *Sentimental Song*, Miss Ada Jones
- 8949 Mildred, *Bells Solo* Albert Benzler
- 8950 When The Harvest Moon is Shining on the River, *Tenor Solo*, Harry Anthony
- 8951 Tennessee Minstrels Minstrels
- 8952 There's a Dark Man Coming With a Bundle Medley, Edison Military Band

Fill out and mail this coupon, checking the catalogue you want.

NATIONAL PHONOGRAPH CO.,
No. 22 Lakeside Avenue, Orange, N. J.

Mail to my Address
Phonograph Catalogue
Complete Catalogue of Edison Records
Sample Copy of the Phonogram

Name.....

Street & No.....

City..... State.....

My Phonograph is No.....

SUSPENDED LIST, APRIL 1, 1905.

SUPERSEDING ALL PREVIOUS LISTS.

COLORADO.

Boulder—BENTLEY & CRAIG.

ILLINOIS.

Ottawa—Edward Hayne.

Wheaton—E. Irving.

INDIANA.

Marion—BUTLER MUSIC CO.; also Wabash, Ind.

South Bend—EUGENE MARSH, 126 Vistula avenue.

SOUTH BEND BOOK BINDERY,
Robert Lebolt, Prop., 203 North
Michigan street.Wabash—BUTLER MUSIC COMPANY; also Marion,
Ind.**IOWA.**

Burlington—JOHN P. WEISS, 711 Jefferson street.

Sioux City—HATTENBACH BROS. CO.

KANSAS.

Clay Centre—E. M. GOWENLOCK.

Lawrence—BELL BROS.

MAINE.

Biddeford—W. H. FIELD.

*Monmouth—G. H. STETSON.

MASSACHUSETTS.

Boston—T. SINGER, 60 Leverett street.

Lawrence—LORD & CO., 314 Essex street.

E. O. MOSHER, 420 Essex street.

Lynn—ELIAS DEYOUNG.

Malden—A. T. FULLER.

Nantucket—ARTHUR M. TAYLOR.

New Bedford—H. B. DEWOLFF.

Somerville—E. J. WINCHESTER, 32 Summit avenue.

Woburn—OSBORN GILLETTE, or THE BOLTON
JEWELRY CO., L. F. Maloney, Manager.**MICHIGAN.**

Detroit—F. J. SCHWANKOVSKY.

Saginaw—GEO. W. EMENDORFER.

JAMES V. CALAHAN, 217 Genessee st.

TIERNEY BROS., 217 Genessee st.

MISSOURI.

Kansas City—THE WITTMANN CO.

NEBRASKA.

Lincoln—THE WITTMANN CO.

Omaha—THE WITTMANN CO.

NEW HAMPSHIRE.

Hillsboro Bridge—E. M. BARNES.

Manchester—A. E. DUMAS

Nashua—F. A. MCMASTER & CO.

NEW JERSEY.

Atlantic City—SAM'L D. WOLF, 32-34 Arkansas ave.

Bayonne—I. WIGDOR, 450 Avenue D.

Jersey City—W. L. HOFFMAN, 151 Montgomery st.

Newark—R. L. CORWIN; also New York City.

Passaic—I. HURWITZ.

Paterson—CHAS. H. KELLY, 25 N. Main street.

Plainfield—S. W. FRUCHT, or R. FRUCHT · also
New York City.

ELSTON M. LEONARD.

West Hoboken—EMIL HOLLANDER, or THE WEST
HOBOKEN BICYCLE & PHONO-
GRAPH CO., 619 Spring street.**NEW YORK.**

Albany—G. LINDE, 353 S. Pearl street.

Bedford Park—GEO. H. TYRRELL.

Hobart—F. H. MARSHALL.

New York City—A. T. ARMSTRONG, or AMERI-
CAN PHONOGRAPH CO., 106
Wall street.

BERN BEARWALD, 373 W. 11th st.

BRONX PHONOGRAPH CO. or

DAVID SWITKY, 506 Willis ave.

CENTRAL PHONOGRAPH CO.,
160 E. 42d street.

R. L. CORWIN; also Newark, N. J.

EAGLE PHONOGRAPH CO., or C.

LOWENTHAL, 83 Nassau street.

EMPIRE PHONOGRAPH CO., 2 W.
14th street.S. W. FRUCHT, or R. FRUCHT, 7
Barclay street, or 68 Cortlandt
street; also Plainfield, N. J.

O. HACKER, 2 Murray street.

HAWTHORNE & SHEBLE, 297

Broadway; also Philadelphia, Pa.

HOLOBER BROS., 350, 421 and 491
West st.

N. HORN, 148 E. 58th street.

W. L. ISAACS, 114 Fulton street.

S. LEMBURG & CO., 194 Broadway.

J. MCELLYNNE, 202 Broadway.

RICHMOND PEASE, 44 W. 132d st.

F. M. PRESCOTT, 44 Broad st.

WINTHROP CYCLE CO., 2212 Sev-
enth avenue.

Rome—CHARLES TUTTLE.

Saratoga—W. J. TOTTEN.

Saratoga Springs—MARVIN A. COTE.

OHIO.

Cincinnati—J. L. ANDEM.

Coshocton—BURNS & GOSSER.

Springfield—D. & M. VANDERPOOL.

Uhrichsville—F. A. MAZURIE.

PENNSYLVANIA.

Philadelphia—A. R. CASSIDY, 2783 Emerald street.

HAWTHORNE & SHEBLE, 604 Chest-
nut street, or Oxford and Mascher
streets; also New York City.

A. KROUSE, 832 Arch street.

PENN NOVELTY CO., 15 South 9th st.

Phoenixville—KEINARD BROS.

Pittsburg—A. LIPPARD, 615 Wylie ave.

RHODE ISLAND.

Providence—F. P. MOORE.

WISCONSIN.

Milwaukee—J. C. BLATZEK.

*Added Since March 1, 1905.

Jobbers and Dealers are asked to co-operate with us, FOR OUR MUTUAL GOOD, by being careful that they do not supply any of the above named firms with our apparatus, either at addresses given or any other address.

JOBBER'S OF EDISON PHONOGRAPHS AND RECORDS.

ALABAMA.

Birmingham—Talking Machine Co., 2007 Second ave.
Mobile—W. H. Reynolds, 167 Dauphin street.
***Montgomery**—K. L. Penick, 119 Dexter ave.

CALIFORNIA.

San Francisco—Peter Bacigalupi, 786-788 Mission street.

COLORADO.

Denver—Denver Dry Goods Co., 619 16th street.

CONNECTICUT.

Middletown—Caulkins & Post Co., 406-408 Main street.
Hartford—Harry Jackson, 300 Asylum street.
New Haven—Pardee-Ellenberger Co., 155 Orange st.

DISTRICT OF COLUMBIA.

Washington—E. F. Droop & Sons Co., 925 Pennsylvania avenue, N W
 S. Kann Sons & Co., 8th and Pennsylvania avenues.

GEORGIA.

Atlanta—Atlanta Phonograph Co., 49 Peachtree St.

ILLINOIS.

Chicago—James I. Lyons, 73 Fifth avenue.
 Siegel, Cooper & Co., 281 State street.
 Talking Machine Co., 107 Madison street.
 The Vim Co., 68 E. Lake street.
 Montgomery Ward & Co., 111 Michigan ave.
 Rudolph Wurlitzer Co., 302 Wabash ave.

Peoria—Peoria Phonograph Co., 222 Bridge street.

INDIANA.

Indianapolis—Craig-Jay Co., 234 Massachusetts ave.
 Kipp Bros. Co., 37 S. Meridian street.
 A. B. Wahl & Co., 119 S. Illinois street.

Lafayette—A. B. Wahl & Co., 304 Main street.

IOWA.

Des Moines—Hopkins Bros. Co., 620 Locust street.
 Vim Co., 704 West Walnut street.

Fort Dodge—Early Music House, 822 Central ave.

KENTUCKY.

Louisville—C. A. Ray, 640 Fourth street.

LOUISIANA.

New Orleans—William Bailey, 600 Frenchman street.
 National Automatic Fire Alarm Co., 614 Gravier street.

MAINE.

Bangor—S. L. Crosby Co., 186 Exchange street.
Portland—W. H. Ross & Son, 207 Commercial street.

MASSACHUSETTS.

Boston—Boston Cycle & Sundry Co., 48 Hanover street.
 Eastern Talking Mach. Co., 177 Tremont st.
 Iver Johnson Sptg. Goods Co., 163 Washington street.

*C. E. Osgood Co., 744 Washington street.
 Read & Read, 558 Washington street.

Fitchburg—Iver Johnson Sptg. Goods Co., 247 Main st.
Lowell—Thomas Wardell, 111 Central street.

***New Bedford**—Household Furnishing Co., 170 Purchase street.

Worcester—Iver Johnson Sptg. Goods Co., 304 Main st.

MICHIGAN.

Detroit—American Phono. Co., 106 Woodward ave.
 Grinnell Bros. 219 Woodward ave.

Saginaw—Morley Bros.

MINNESOTA.

Minneapolis—Thomas C. Hough, 714 Hennepin ave.
St. Paul—W. J. Dyer & Bro., 21-23 West 5th street.
 Thomas C. Hough, 392 Wabasha street.
 Minnesota Phonograph Co., 37 E. 7th street.

MISSOURI.

Kansas City—J. W. Jenkins' Sons Music Co., 1013-1015 Walnut street.

St. Louis—Conroy Co., 1115 Olive street.
 O. K. Houck Piano Co., 1118 Olive street.

NEBRASKA.

***Lincoln**—H. E. Sidles Cycle Co., 1317 O street.
Omaha—Nebraska Cycle Co., 15th and Harney streets.
 Omaha Bicycle Co., 16th & Chicago sts.

NEW JERSEY.

Hoboken—Eclipse Phono. Co., 205 Washington st.
Newark—A. O. Petit, New and Halsey streets.
Paterson—James K. O'Dea, 117 Ellison street.
Trenton—Stoll Blank Book and Stationery Co., 30 E. State street.

NEW YORK.

Albany—Finch & Hahn, 92 State street.
Brooklyn—Chapman & Co., Fulton and Duffield streets.
 A. D. Matthews' Sons, 394 Fulton street.
 Price Phonograph Co., 1258 Broadway.

Buffalo—P. A. Powers, 643 Main street.
Elmira—Elmira Arms Co., 117 Main street.
Gloversville—American Phono. Co., 99 W. Fulton st.
Kingston—Forsyth & Davis, 307 Wall street.
New York City—Bettini Phono. Co., 80 Chambero street
 Blackman Talking Machine Co., 19 Beekman street.

J. F. Blackman & Son, 2654 3d avenue.
 I. Davega, Jr., 802 Third avenue.
 S. B. Davega, 32 E. 14th street.
 Douglas Phono. Co., 89 Chambers st.
 H. S. Gordon, 139 Fifth avenue.
 Harry Jackson, 219 Bowery.
 Jacot Music Box Co., 39 Union Square.
 Victor H. Rapke, 1661 Second avenue.
 Siegel-Cooper Co.
 John Wanamaker.

***Oswego** - Frank E. Bolway, 32 Bridge street.
Poughkeepsie—Price Phonograph Co., 203 Main st.
Rochester—A. J. Deninger, 345 North street.
 Mackie Piano, O. & M. Co., 100 State street.
 Giles B. Miller, 63 State street.
 Talking Machine Co., 97 Main st., E.

Schenectady—Finch & Hahn, 456 State street.
 Jay A. Rickard & Co., 253 State street.

Syracuse—W. D. Andrews, 216 E. Railroad street.

Troy—Finch & Hahn, 7 Third street.
 Troy Automobile Exchange, 359 Fulton street.

Utica—Clark-Horrocks Co., 54 Genesee street.
 Arthur F. Ferriss, 89 Washington street.
 William Harrison, 41 Columbia street.
 Utica Cycle Co., 31 Columbia street.

OHIO.

Canton—Klein & Heffelman Co., 216 N. Market street.
Cincinnati—Ilsen & Co., 25 W. 6th street.

A. B. Wahl & Co., 805 Vine street.
 Rudolph Wurlitzer Co., 10-12 W. 4th st.

Cleveland—W. J. Roberts, Jr., Erie and Huron streets.
Columbus—Perry B. Whitsit Co., 213 S. High street.

Dayton—Niehaus & Dohse, 35 E. 5th street.

East Liverpool—Smith & Phillips Music Co.

Newark—Hoover-Ball Co., Inc.

Toledo—Hayes Music Co., 608 Cherry street.

PENNSYLVANIA.

Allegheny—Henry Braun, 500 Federal street.
Allentown—G. C. Aschbach, 539 Hamilton street.
Easton—William Werner, 401 Northampton street.
Harrisburg—S. K. Hamburger, 12-14 N. Market sq.
Philadelphia—C. J. Heppe & Son, 1117 Chestnut street.
 Lit Bros., Market and 8th streets.
 Penn Phonograph Co., 17 S. 9th street.
 John Wanamaker, 13th and Market sts.
 Wells Phonograph Co., 41 N. 9th street.
 Western Talking Mach. Co., 25 S. 9th st.
 H. A. Weymann & Son, 923 Market st.

Pittsburg—Theo. F. Bentel Co., Inc., 632 Liberty street.
 Kaufmann Bros., Fifth avenue.
 H. Kleber & Bro., 221 Fifth avenue.
 C. C. Mellor Co., 319 Fifth avenue.
 Pittsburg Phono. Co., 937 Liberty street.

Reading—Reading Phonograph Co., 809 Penn street.

Scranton—Ackerman & Co., 130 Wyoming avenue.
 Technical Supply Co.

RHODE ISLAND.

Pawtucket—Pawtucket Furniture Co., 39 N. Main St.
Providence—J. M. Dean Co., 785-795 Westminster street.
 J. A. Foster Co., Weybosset st.
 Household Furniture Co.
 J. Samuels & Bro., 154 Weybossett street.
 A. T. Scattergood & Co., 106 N. Main st.

TENNESSEE.

Knoxville—Knoxville Typewriter and Phonograph Co., 311 Clinch street.

Memphis—O. K. Houck Piano Co., 359 Main street.

Nashville—Nashville Talking Mach. Co., 510 Church st.

TEXAS.

Dallas—Southern Talking Machine Co., 347 Main st.
Fort Worth—Cummings, Shepherd & Co., 700 Houston st.

Houston—H. M. Holleman Co., 612 Fannin street.

WISCONSIN.

Milwaukee—McGreal Bros., 173 3d street.

CANADA.

Toronto—R. S. Williams & Sons Co., Limited,
 143 Yonge street.

* Added since March 1, 1905.

AMUSEMENT AND LANGUAGE STUDY



APRIL
1905

SUN	MON	TUE	WED	THUR	FRI	SAT
						1
2	3	4	5	6	7	8
9	10	11	12	13	14	15
16	17	18	19	20	21	22
23	24	25	26	27	28	29
30						

DOUBLE SERVICE

The Edison Trade are the only merchants allowed to sell I. C. S. Language Outfits. Send \$2.00 for Agent's Sample Outfit and instructions for representing "Double Service," including sample moulded records in French, German, Spanish, and English. *Write today!* Address:

LANGUAGE DEPARTMENT

INTERNATIONAL CORRESPONDENCE SCHOOLS
SCRANTON, PA.

EDISON Phonograph Monthly

PUBLISHED FOR TRADE USE ONLY BY
THE NATIONAL PHONOGRAPH CO.

VOL. III.

ORANGE, N. J., MAY, 1905.

No. 3.

NATIONAL PHONOGRAPH CO.
ORANGE, N. J.

NEW YORK: 31 UNION SQUARE.

CHICAGO: 304 WABASH AVENUE.

SAN FRANCISCO: 786 MISSION STREET.

NATIONAL PHONOGRAPH CO., LTD., 25 CLERKENWELL
ROAD, LONDON, ENG.

EDISON PHONOGRAPHS AND RECORDS.

All communications to THE PHONOGRAPH MONTHLY
should be addressed to the Advertising Department,
Orange, N. J.

C	O	N	T	E	N	T	S
Business Still Increasing.....							1
Sold Without Trying.....							3
How to Put Graphite in Phonograph Springs							4
No Local Advertising.....							4
Window Display Pictures Wanted.....							4
Fake Sapphires							4
New Record Shipments About the First..							5
Don't Send Orders to Factory.....							5
A Good Talking Point.....							5
Carry Every Edison Record.....							6
Printed Matter.....							6
Two Important Essentials.....							6
Possible New Department.....							6
Albert G. Williams.....							6
Among the Jobbers.....							7
Use Order Blanks.....							7
One of the Best Ever.....							7
Edison Gold Moulded Records for June..							8
Heard it Played and Was Convinced.....							9
Edison Eulogies in Song.....							10
An Interesting Article.....							11
Preached His Own Funeral Sermon by Phonograph							12
One Owner's Testimony.....							12
The Phonogram							13
A Dealer's Soliciting Letter.....							13
Jobbers of Edison Phonographs and Rec- ords							14
List of Suspended Dealers, May 1, 1905..							15

BUSINESS STILL INCREASING.

When the Dealers' three-for-one proposition terminated on March 15th, we thought that it would be followed by a falling off in the volume of orders for Phonographs and Records. Although this proposition did not bear in any way upon the sale of Phonographs, we still felt that in some unexplained manner it might have been a factor in the increase of orders for Phonographs. It seemed quite reasonable to suppose that the volume of the Record orders was to a more considerable extent due to this special proposition. Somewhat to our surprise, however, the number of orders received after March 15th were fully as large as at any previous time and the number of advance orders for May Records even exceeded the number for April Records, the advance orders for which were the largest for any single month in the history of the Company. The May list now leads for the greatest total number in one month. This splendid business shows that if the three-for-one proposition had any effect upon the general situation, it was to re-awaken interest throughout the entire trade. We are more inclined to think, however, that the volume of business is due to normal conditions, and these normal conditions are caused by the increasing belief of the American people that Mr. Edison's great invention is still the leader among sound producing machines.

At our factory in Orange, we are turning out as many Records to-day as it is possible to do even with our greatly increased facilities. At no time except Sunday does the Record making force stop work. From Monday morning until Saturday night, one force of hands follows another and the output is continuous. In spite of these efforts we have been unable to make much headway toward catching up with orders on hand. So regularly does the number of new orders continue to equal the output, and at times to exceed it, that we have

(Continued on Page 3.)

THE ADVANCE LIST OF JUNE RECORDS APPEARS ON PAGE 2.

NEW EDISON GOLD MOULDED RECORDS. ADVANCE LIST FOR JUNE, 1905.

RECORDS listed below will be ready for shipment as near **June 1st** as possible, at which time Jobbers' stock orders, if **received prior to May 10th**, will be shipped. June Supplements will be forwarded to Jobbers with their stock order for Records. Retail Dealers should place stock orders with their Jobbers at once, to insure prompt shipment as soon as Jobbers' stock is received.

- | | | |
|------|---|---------------------------|
| 9002 | Rienzi Overture (<i>Wagner</i>) | Edison Concert Band |
| 9003 | Rose-Marie (<i>Weatherly</i>) <i>Sentimental song, Orch. accom.</i> | Harry Anthony |
| 9004 | Down in Blossom Row (<i>Wenrich</i>) | Byron G. Harlan |
| | <i>New Summer Waltz song, introducing chorus of Girls and Boys, Orch. accom.</i> | |
| 9005 | Oh, Promise Me (<i>De Koven</i>) <i>Cornet solo, Orch. accom.</i> | Bohumir Kryl |
| 9006 | Her Boy in Blue (<i>Doty</i>) <i>March song, Orch. accom.</i> | Harry MacDonough |
| 9007 | Hey! Mister Joshua (<i>Keith</i>) <i>Rube duet, Orch. accom.</i> | Collins & Harlan |
| 9008 | First Heart Throbs (<i>Eilenberg</i>) | Edison Symphony Orchestra |
| 9009 | Paddy's Day (<i>Mullen</i>) <i>Irish song, Orch. accom.</i> | Billy Murray |
| 9010 | O Morning Land (<i>Phelps</i>) | Anthony & Harrison |
| | <i>Sacred Tenor and Baritone duet, Orch. accom.</i> | |
| 9011 | Black Diamond Express March (<i>Lyon</i>) | Edison Military Band |
| 9012 | Susan Van Doozen (<i>Shepherd</i>) <i>Comic song, Orch. accom.</i> | Bob Roberts |
| 9013 | You're My Heart's Desire, I Love You, Nellie Dean (<i>Armstrong</i>) | Harlan & Stanley |
| | <i>Sentimental Tenor and Baritone duet, Orch. accom.</i> | |
| 9014 | An Autumn Evening (<i>Siegel</i>) <i>Mandolin and Guitar duet.</i> | Siegel & Wolfe |
| 9015 | What's the Matter with the Mail (<i>Wenrich</i>) <i>Coon song, Orch. accom.</i> | Arthur Collins |
| 9016 | Ev'ry Little Bit Helps | Ada Jones & Len Spencer |
| | <i>Vaudeville Specialty with Orchestral incidental music.</i> | |
| 9017 | La Cascade (<i>Caprice</i>) (<i>Garcia</i>) | Edison Concert Band |
| 9018 | Sweet Maid Divine (<i>Harris</i>) | Miss Morgan & Mr. Stanley |
| | <i>Contralto and Baritone duet, Orch. accom.</i> | |
| 9019 | Good Night, Beloved, Good Night (<i>Oliver</i>) <i>Orch. accom.</i> | Edison Male Quartette |
| 9020 | Tell Me With Your Eyes Medley | Albert Benzler |
| | <i>Bell solo, with Orch. accom., introducing "Tell Me With Your Eyes,"</i> | |
| | <i>"Heinie" and "If I Were Only You."</i> | |
| 9021 | On a Summer Night (<i>Van Alstyne</i>) | MacDonough & Biehling |
| | <i>New Summer Waltz song, male duet, Orch. accom.</i> | |
| 9022 | Beautiful Birds Sing On <i>Whistling and Singing duet, Orch accom.</i> | Harlan & Belmont |
| 9023 | She Waits by the Deep Blue Sea (<i>Morse</i>) | Irving Gillette |
| | <i>Descriptive song, Orch. accom.</i> | |
| 9024 | South Carolina Minstrels | Minstrels |
| | <i>Introducing end men Len Spencer and Billy Murray, with Coon song by the latter, "It's Allus de Same in Dixie" (Cook), with chorus by Edison Quartette and Orch. accom.</i> | |
| 9025 | Bunker Hill Medley | Edison Military Band |
| | <i>Introducing "Bunker Hill," "I've Got a Little Money and I Saved it All for You," "Tammany," "My Carolina Lady" and "The Preacher and the Bear."</i> | |

Edison Gold Moulded Records are made only in Standard Size. Both Standard and Concert Records may be ordered from this list. Order by number, not title. If Concert Records are wanted, give the number and letter C.

already taken steps toward erecting another Record moulding building. It will, of course, be some months before this can be ready for occupancy and use, and in the meantime we desire the trade to rest assured that nothing will be left undone to meet the demand for Records. At times the demand for Phonographs is heavier than we can keep up with when working our factory regular hours, but by working overtime we can make better headway when necessary. Since the Record Department already works night and day, we do not have such an opportunity to catch up with orders, and, therefore, must get a new building before we can successfully do so.

In planning for a further extension of our factory facilities, we are encouraged by the reports that come to us from Jobbers and Dealers in all parts of the country, to the effect that the demand for Edison Phonographs and Records is constantly on the increase. In fact, they report that it has increased so fast within the past year as to make it impossible to tell how to order or what stock to carry. They, too, are planning to extend their selling facilities, feeling sure that the demand for Phonographs and Records will not only continue as great as at present, but will even increase as the months go by. There can be no better test of the selling powers of Edison Phonographs and Records than the fact that many Jobbers and Dealers who have been handling other lines exclusively are now adding the Edison line, and in some cases they are dropping all others and will hereafter sell Edison goods only.

ABUSE OF SAMPLE RECORD PRIVILEGE.

Due to the abuse of sample Record privilege, we have been reluctantly compelled to refuse to furnish one Jobber with these samples in the future. The cause in this particular instance was that the Jobber in question allowed the sample Records to remain in the possession of one of his Dealers for a period of several days, thereby giving such Dealer an undue advantage over other Dealers in the same city.

Sample Records are furnished with the understanding and for the purpose of enabling Jobbers to determine such quantity as they desire to order for stock. They can also be exhibited by the Jobbers to their Dealers, in order that Dealers may determine the quantity they desire to order. They must not, however, be disposed of, either directly or indirectly, by the Jobber until his stock order has been received. Neither can they be left with any

one Dealer to be exhibited to his customers.

We trust the action we have been compelled to take in the case referred to will be a warning to other Jobbers, and that they will make sure that sample Records will only be handled in the way which we designate.

HOW TO PUT GRAPHITE IN PHONOGRAPH SPRINGS.

Since many Dealers sell Phonographs as a side line, they do not become familiar with the mechanical construction of the machines, and cannot furnish information frequently asked by their customers. One of the things not understood by such Dealers is the method of putting graphite in the springs, and yet it is one that many Phonograph owners want to know about. The proper way to put graphite in the springs of the Phonograph is to allow the machine to run down, remove it from the cabinet, stand it on end and sift dry powdered graphite into the spring barrel through the holes in the end of the same. About two teaspoonfuls will be enough. Then put plenty of oil on the spring, wind the machine up and allow it to run down two or three times so as to distribute the graphite through all the leaves of the spring. This applies to the Standard, Home and Triumph. The Gem has no spring barrel, and to graphite this spring it is only necessary to remove the base board by taking out the four screws at the bottom, turn the machine upside down and sift graphite directly on the leaves of the spring and then put in oil.

VISITORS AT NEW YORK OFFICE.

Edison Jobbers were too busy in April to visit New York City, and but few called at our offices. Among those who did call were S. K. Hamburger, of Harrisburg, Pa.; William Werner, of Easton, Pa.; Adolph Weiss, of Philadelphia; Charles Schmelzer, of Kansas City, and Mr. Pardee and Ellenberger, of New Haven, Conn.

Dealers who are doing the best business in Edison Gold Moulded Records are those who have made up a list of all Phonograph owners in their territory and are sending them every month a Record Supplement or a copy of the Phonogram. They are also getting people who have not used their Phonographs in the past three years to hear the Edison Gold Moulded Records of today.

NO LOCAL ADVERTISING.

Occasionally a Dealer makes a request to have some special local advertising done for his particular benefit, pointing out that the retail store of some other company is doing business in the same field and is advertising considerably. They seem to feel that we should make an appropriation for their special benefit. They sometimes also get the publisher of a local paper to solicit us to give him a contract for advertising. To all of these requests we have but one reply; namely, that such advertising is too expensive to consider. If we did it for a few we must do it for every Dealer and this means about 5,500 different appropriations. Then, too, local advertising is expensive because the rates are much higher in proportion to circulation than the magazines and other publications of general circulation, in which we are liberal advertisers. If it would pay us to advertise our goods in a town for the benefit of a Dealer in that town, it would pay the Dealer himself equally well. In fact, this is one of the reasons why many Dealers do not make a real success of selling Edison goods. If, in addition to putting in an adequate stock of goods, they would advertise in their local papers, they would find that advertising paid handsomely.

WINDOW DISPLAY PICTURES WANTED.

We would like to publish in the PHONOGRAPH MONTHLY each month, one or two pictures of window displays made by Edison Dealers. Will not some of our enterprising Dealers send us photographs of such window exhibits? To be used in the MONTHLY they must, of course, be exhibits of Edison goods only. In every case that we use such photographs, we will give full credit to the Jobber or Dealer sending them. The publication of such photographs will, we believe, be valuable to other Dealers as furnishing ideas for window displays. The more unique the displays are made, the more valuable will be the photographs. Who will be the first Dealer to see his store in print?

AS GOOD AS A 50 CENT SHOW.

One of our Western salesmen called upon a merchant in Ponca City, Okla., on April 13th and gave a demonstration of the Phonograph. This is the way the local paper commented upon the incident:

"A representative of the Edison Phonograph Co. entertained a crowd this rainy afternoon in Koller's hardware store. He had the finest instrument we ever saw or heard, and his entertainment was better than most fifty cent shows."

FAKE SAPPHIRES.

We take this opportunity of warning Jobbers and Dealers and the public generally, from using imitation sapphires which have recently been surreptitiously put upon the market. These imitations are made by at least two concerns against whom we have complete evidence on which to base actions for infringement of the Edison patents. We have also the names of Jobbers who have dealt extensively in these imitation goods, and propose to proceed against them. The imitation sapphires in question are rough, unpolished, irregular in shape and size, and their use would result in the quick destruction of any Record. In fact, under the microscope, the bearing surface of these sapphires which engages the wax Record has the appearance of emery or sand stone, instead of being perfectly polished, as with a genuine Edison stylus. In one case, we find that sapphire reproducer balls were made of ordinary soft glass, having no durability whatever, and in use quickly wearing out and cutting the Records. Our friends will, of course, realize that the use of these imitation sapphires can only harm the Phonograph business. Genuine Edison sapphires are manufactured for and sold by the National Phonograph Company, and the prices therefor are fixed and definite. Should any sapphires be offered to Jobbers or Dealers at materially lower prices than those quoted by us, they may be reasonably sure that the sapphires in question are fraudulent, and to acquire them would subject the purchaser to the liability of an infringement suit. Should any sapphires be offered to Jobbers or Dealers at special prices, we would be glad to be notified of the fact, in order that the matter can be promptly investigated, as we consider that the continued success of the Phonograph business depends largely upon the presentation to the public of genuine goods, honestly made and of the highest possible standard of excellence.

NATIONAL PHONOGRAPH COMPANY.

"DANCE OF THE HOURS."

One of the features of the new Hippodrome, New York City, is the "Dance of the Hours," an elaborate ballet which is danced to the ballet music from "La Giaconda," by Ponchielli. This music is given on our Record No. 8749. It is remarkable for its sweetness and delightful rhythm. The popularity of this feature of the Hippodrome performance has caused an increased demand in New York and vicinity for our Record of this music.

NEW RECORD SHIPMENTS ABOUT THE FIRST.

In the February issue of the PHONOGRAPH MONTHLY we printed a paragraph to the effect that our manufacturing facilities had made it possible to establish a fixed schedule for Record shipments each month. It was stated that if orders were received by the 10th of the month, we would be able to make shipment about the 25th. This seemed quite possible at that time, but the tremendous increase in business in the past three months has made it practically impossible to live up to such a schedule. The best that we have been able to do is to ship the Records about the 1st of the month. Since the business shows no signs whatever of letting up in volume, it has been decided to advise the trade that shipment of the new Records for the month will not be promised before between the 25th and the 1st of each month hereafter. Fixing the time for shipment at the 25th and not being able to ship until about the 1st has caused have been led to believe that the Records would be shipped from Orange about the 25th of the month and have kept asking why their orders were not filled until the 1st of the month, or later. The trade will, therefore, understand that until there is a decided falling off in business, the Records of the month will not be shipped until as near the 1st of the month as circumstances will permit. This will probably make it nearly the 5th of the month before the Records will be in the hands of the Jobbers and ready for re-shipment to Dealers.

DON'T SEND ORDERS TO FACTORY.

Notwithstanding what has been printed and written from time to time many Jobbers and Dealers still occasionally send orders direct to the factory at Orange. Instead of facilitating the filling of such orders, this causes a delay. Orders sent to Orange and belonging to the New York territory are sent to New York without receiving any attention whatever. In the same way orders received from Chicago territory are sent to the Chicago office. To get the best attention, Jobbers and Dealers should send all orders to the sales offices in the territory in which they are located, that is, either New York, Chicago or San Francisco, and not send direct to the factory. This refers to telegraphic orders as well as mail orders.

The National Phonograph Co. has leased a store at 251 and 253 West Broadway, New York, which will be utilized as a warehouse and shipping depot for its export department. The new premises, ready for occupancy May 1, will greatly facilitate this rapidly-expanding branch of the company's business.

A GOOD TALKING POINT.

The Record-making possibilities of the Edison Phonograph are not given the proper attention by many Dealers. As a result, they often fail to make sales when an explanation of this feature would induce many doubtful persons to become owners of machines. Every Dealer who desires to make a success of the Edison line should study up the matter of making Records in order to be able to demonstrate it to his customers, and he should never lose an opportunity of presenting it as a selling argument. The average owners of Phonographs cannot make Records with the volume and tone of those turned out by this company, for the latter have been the result of years of work and experimentation, but they can make them so successfully as to furnish them with lots of amusement in the making and give them a series of Records that will be fully as interesting to his friends as any that he can buy. Dealers should learn how to make Records, not only to sell the Phonograph itself, but because when used for Record making a sale also includes a recording horn, shaved blanks and other accessories. Then, too, the Dealer who can give his customers points on making Records is going to have more people come to him for information and their coming will be followed by sales. Many Dealers may think that it is a troublesome matter to learn to make Records, but they will be surprised to find how little trouble it really is if they go about it in the right manner.

NO "TRADE" CONTRACTS.

Newspaper publishers frequently ask us to give them a contract for advertising and pay for the same with Edison Phonograph and Records. Our reply is to point to the clause in our Dealers' contract in which we prohibit the trade from making contracts of this character. We state that to be consistent we cannot do it ourselves, and have therefore made it a rule to make no contracts of this character. With all the advertising that we are doing, we have not a single contract on any other than a cash basis.

TRAFFIC MANAGER.

F. A. Voullaire was on April 17th appointed Traffic Manager of the National Phonograph Co. It will be Mr. Voullaire's duty to look after routing, freight rates and freight claims. He has had a long experience in this line of work with other large manufacturing companies and his knowledge of transportation matters will enable us to give the trade much better service in the matter of shipments.

CARRY EVERY EDISON RECORD.

For the benefit of new Dealers and for those who have not been sufficiently impressed by what has already been said on the subject, we would like to again refer to the advisability of Dealers carrying at least one of each domestic Record made by this company. It is the constant effort of our Sales Department to induce Dealers in towns and cities of sufficient size to increase their stock to a point where they can announce to the public that they carry every Edison Record in stock. Where there are two or more Dealers in a town, the one who can honestly make this announcement will in a very short time be the leading Dealer in the place, and will continue to do by far the largest business, unless his competitors do likewise. Our salesmen have induced many Dealers to carry a full stock of Edison Records, instead of a limited number of selections, and they all report that without exception every Dealer who has done this has made a great success in selling Edison goods. If you are a Dealer carrying limited stock, give this matter your careful consideration. To carry every Edison Record does not mean a very large outlay of capital, but it does mean a great deal larger business, and a greatly increased profit.

PRINTED MATTER.

Dealers continue to complain that they do not get printed matter from their Jobbers. Since it is practically impossible to supply them from Orange, N. J., we can only urge them to continue to ask their Jobbers for it. We would also urge Jobbers, so far as possible, to see that their Dealers have at all times a small supply of catalogues, etc. Many Jobbers take great pains in supplying Dealers with literature and we find that they are regarded by their Dealers as Jobbers who give them the best service. When a Dealer finds a Jobber solicitous concerning the increase of his business, he is naturally favorably impressed, and orders follow his impressions.

We have under way several folders and cards for use in liberal quantities by the trade. The first of these will be a four-page folder to take the place of No. 535, which is now out of print.

The edition of the little bookmarks is now entirely exhausted and no further orders can be filled.

Copies of the new Record catalogue, Form No. 670, will be mailed to the entire trade in a few days, although we have been shipping limited quantities of them to such Jobbers as were out of Record catalogues. We are still sending

these out as fast as they come from the printer and will continue to do so until all orders have been filled. This catalogue has a new lithographed cover and includes the April Records.

A POSSIBLE NEW DEPARTMENT.

One of the most interesting features of the *Phonogram* is its "Questions and Answers" column, in which we undertake to reply to such questions as owners of Phonographs may desire to ask concerning our goods or ourselves. We believe that such a department, conducted from a trade standpoint, would be a valuable and interesting feature of the PHONOGRAPH MONTHLY. There must be many points about which Dealers are in doubt, and replying to questions furnished by them would furnish useful information to other Dealers throughout the country. We should be glad to hear from Dealers on the subject and to reply to such questions along these lines as they may desire to ask.

TWO IMPORTANT ESSENTIALS.

Our salesmen report that they frequently find Dealers exhibiting machines not run at the correct speed and with the horn suspended improperly. A Phonograph running either too fast or too slow causes an unnatural reproduction of the Record, and is more apt to make an unfavorable impression on the purchaser than it is to induce him to buy. Care should be taken to see that a horn is suspended from the crane or horn support so as to be as nearly balanced as possible. In other words, the little chain connecting the two should hang perpendicularly, otherwise it is apt to cause the reproducer arm to be lifted or crowd so hard against the machine as to interfere with its easy operation.

ALBERT G. WILLIAMS.

Albert G. Williams, Manager of the Phonograph Department of the Stoll Blank Book and Stationery Company, Trenton, N. J., died at his home in Trenton on March 31st. Mr. Williams was formerly connected with the Edison Phonograph Works at Orange, N. J., and left there six years ago to take charge of the Phonograph Department of the above named company. He was thirty-one years of age and left a wife and one child. His death was much regretted by his employees and many friends in the Phonograph trade.

Don't think because summer is coming that trade is going to fall off. The Edison Phonograph sells as well in summer as in winter.

AMONG THE JOBBERS.

The J. F. Schmelzer & Sons Arms Co., of 708-710 Main street, Kansas City, Mo., have become Edison Jobbers during the past month. They intend making an aggressive campaign among the Dealers of the southwest. This company have been handling talking machines, but up to the present time have not handled the Edison line. They are among the latest converts to the general belief that no talking machine business is complete without including Edison Phonographs and Records.

Removals are in order among the New York city Jobbers. The Blackman Talking Machine Co., which has been located at 19 Beekman street for several years, removed on May 1st to 97 Chambers street, where they will have larger quarters and much better facilities for handling their rapidly growing business. The Bettini Phonograph Co., now at 80 Chambers street, will remove soon after May 1st to 156 W. 23d street. This company has recently been re-organized and is planning to do a much larger business than ever before. John F. Blackman & Son removed on May 1st from 2654 Third avenue, New York, to 2737 Third avenue.

George R. Youmans, Waycross, Ga., has become a Jobber in Edison Phonographs and Records. Waycross is one of the railroad centres of the South, and Mr. Youmans expects to do a large jobbing business in consequence of the excellent shipping facilities afforded him by the railroads.

Our list of New England Jobbers has been increased by the addition of the Flint & Brickett Co., 439 Main street, Springfield, Mass.

Alfred Weiss, who has been one of the largest Edison Dealers in New York city for some time, has now become a Jobber, with headquarters at 1525 First avenue.

The Quincy Phonograph Co., 808 Hampshire street, Quincy, Ill., have signed a Jobber's Agreement to sell Edison goods, and since there is only one other Jobber in Illinois outside of Chicago, they expect to build up an extensive business.

F. M. Atwood, of Memphis, Tenn., who has been a Dealer in Edison goods for some time, became an Edison Jobber in April.

The Talking Machine Co., Rochester, N. Y., have removed from 29 Clinton avenue to 97 Main street, E., where larger and more suitable quarters are secured. The store has been elegantly equipped as to furnishings and attractive stock.

McGreal Brothers, of Milwaukee, are giving an elaborate exhibition of Edison goods in connection with the Merchants' Exposition now being held in that city. A feature of the exhibit is the making of Records on the Phonograph by Arthur Collins and Byron G. Harlan, under the direction of an expert from the recording department of the National Phonograph Company.

E. F. Taft, the manager of the Eastern Talking Machine Co.'s store, at No. 177 Tremont street, says that trade is good for this time of the year, and that it has held up remarkably well. He says that the month of March this year was larger than for any corresponding month in the eleven years of the history of the business. Additional booths are being put in place for the playing of Edison machines, and a balcony will be constructed for the storing of a distinctly retail stock of Edison Records. This will mean an increase of 10,000 Edison Records to the stock carried. Mr. Taft says that he does a large business in packing and shipping machines for his customers, to their summer homes in the mountains and at the beach resorts. They prefer to have the machines packed properly than to take chances of damages from careless packing.—*Boston Correspondence to the Music Trades.*

USE ORDER BLANKS.

Dealers will facilitate the work of their Jobbers in handling orders if they will use the Order Blank now being mailed with the PHONOGRAPH MONTHLY for placing their monthly orders for new Records. Write in the quantity you want before each number, fill in the Jobber's name and your own name and mail the blank. Jobbers in turn will make it easier to handle their orders at the Factory by also using the Order Blank in ordering new Records. Only advance Records should be ordered on these blanks.

ONE OF THE BEST EVER

"The writer sent the enclosed letter to over 500 people along with April Supplements, and April *Phonograms*," wrote Thomas Wardell, Edison Jobber at Lowell, Mass., on April 8th. "I have sold over 300 of these Records (No. 8958) to-day. I think it is one of the best Records your company have ever put out, and it shows that a great part of the success of the business is in the hands of the recording department."

Lowell, Mass., April 1st, 1905.

Dear Sir.—Enclosed please find list of Edison Gold Moulded Records for April. I believe that No. 8958 will prove to be one of the best selling Records ever put on the market. I have bought 1,000 Records of this number alone. Call and let us play it over for you.

THOMAS WARDELL.

(The Phonograph Man.)

Buy the Best.
EDISON RECORDS
have stood the test.

If you know of anyone using the old style Reproducer on a Standard, Home, or Triumph Phonograph get him to pay you \$3 and exchange it for a Model C.

EDISON GOLD MOULDED RECORDS FOR JUNE.

Many of the titles of the twenty-four Edison Gold Moulded Records for June are suggestive of the coming summer season. At least two of the selections, "Down in the Blossom Row" and "On a Summer Night," are expected by their publishers to be very popular summer songs. The novelty for this month is a mandolin and guitar duet, this being the first Record ever made by these instruments together. The band and orchestra records are unusually well played, and Ada Jones and Len Spencer have another clever vaudeville duet.

No. 9002, "Rienzi Overture," by the Edison Concert Band, is a high class Record of this operatic composition by Richard Wagner. It is a most ambitious bit of recording and thoroughly illustrates the progress made in recent years in the art of producing Phonograph Records. This selection was previously listed in the old wax Records. In making it over it has been rendered in an entirely different manner and much improved.

No. 9003, "Rose-Marie," by Harry Anthony, is a sentimental song by F. E. Weatherly, and very popular among finished artists. Mr. Anthony's rendition of the song cannot fail to please critical Phonograph owners. Particular attention is called to the fine orchestration in the accompaniment to this Record.

No. 9004, "Down in Blossom Row," by Byron G. Harlan, is a new descriptive summer song, the music of which was written by Percy Wenrich and the words by F. J. Hamill. It is written in waltz time and its publishers predict for it wide popularity in the coming season. The song introduces a chorus of boys and girls, giving a fine coloring to as pretty and catchy a little song as has been turned out in recent years. Mr. Harlan is accompanied by the orchestra.

No. 9005, "Oh, Promise Me," is a cornet solo by Bohumir Kyrl, with orchestral accompaniment, that will doubtless be in great demand, because it is played along simple lines and with none of the pyrotechnic playing that artists of Mr. Kyrl's ability are wont to indulge in. "Oh, Promise Me," was written by Reginald De Koven, and it has attained a place in musical ballads that will live for many years. The selection is listed in response to the popular demand that Mr. Kyrl should play something in the melody line. The pure tone with which he plays this beautiful song will find many enthusiastic admirers.

No. 9006, "Her Boy in Blue," by Harry MacDonough, is a descriptive march song written by Chas. W. Doty, and sung by Mr. MacDonough with orchestra accompaniment. A maiden sings of her soldier boy called to duty. She waits for him but he does not return. The song has a tuneful marching melody that has already attained considerable popularity. A feature of the orchestra accompaniment is the pretty effects by the bugle and flutes.

No. 9007, "Hey! Mister Joshua," by Collins and Harlan, is a comic male duet dealing with

the adventures of two Rubes in the city. The song is written in a tempo that starts the feet a-going at once with no let up until the finish. It is sung with orchestra accompaniment. The music of this composition was written by Lester W. Keith and the words by John Kemble.

No. 9008, "First Heart Throbs," by the Edison Symphony Orchestra, is a well-known concert number written by R. Eilenberg. It is a gavotte and admirably adapted to bring out various orchestral effects.

No. 9009, "Paddy's Day," by Billy Murray, refers incidentally to St. Patrick's Day, but it is chiefly made up of bits of different Irish melodies, all worked out very cleverly. The words also are written up with reference to a score or more of well-known Irish songs. The music is of a brilliant character, full of jingle and swing, in keeping with the idea of the lyrics. The Record is made with orchestra accompaniment. The music of this song was written by B. Mullen and the words by F. Fogarty.

No. 9010, "O Morning Land," by Anthony and Harrison, is a splendid Record of this well-known sacred composition by Edward H. Phelps. The music is melodious and of a good quality. Messrs. Anthony and Harrison render the song in an artistic manner, the orchestra accompaniment adding much to the attractiveness of the Record.

No. 9011, "Black Diamond Express March," by the Edison Military Band, is a composition by H. A. Lyon that was named for the far-famed railroad express and the character of the music is thoroughly descriptive of the title.

No. 9012, "Susan Van Doozen," by Bob Roberts, refers in a humorous vein to the methods of song writers in getting up their compositions, with plays on words. The story is given in a conversational manner and is novel in form and conception. The waltz time melody gives the Record an attractive musical setting. The Record is made with orchestra accompaniment. Henry Shepherd wrote the music of this composition and Joe Lincoln, the words.

No. 9013, "You're My Heart's Desire, I Love You, Nellie Dean," by Harlan and Stanley, is a new sentimental song, fully described in its title. Sung with orchestra accompaniment. This song was written by Harry Armstrong, and is quite as pretty a ballad as "You're the Flower of My Heart, Sweet Adeline," by the same composer, and listed on our records as No. 8677.

No. 9014, "An Autumn Evening," is a mandolin and guitar duet by Samuel Siegel (who is also the composer of the music) and M. Lloyd Wolfe. This is the first Record ever made by this combination of instruments. It is one that, we think, will please all admirers of both instruments. The music is of a serene character.

No. 9015, "What's the Matter With the Mail?" by Arthur Collins, is a coon song by Percy Wenrich (music) and Fred J. Hamill (words). Sung with orchestra accompaniment. Long after Liza's salary day, Mr. William Jackson Tagg is anxiously waiting the mail that should bring him part of her salary.

Bill spies the postman coming. Stocks are now up with Bill.

"Are you Mr. William Jackson Tagg?"

"Yes, sah."

"Well, Mr. Tagg, will you kindly deliver this letter to the family on the top floor?"

No. 9016, "Ev'ry Little Bit Helps," by Ada Jones and Len Spencer, is a realistic portrayal of a vaudeville act, introducing theatre surroundings, audience, orchestra and everything incidental to as bright and amusing little act with a story to it as one would see or hear in a first-class vaudeville house. The Record in the May list made by these artists broke all records for the sale of a single selection, and this one will probably be quite as popular. Fred Fischer wrote the music of this composition and George Whiting, the words.

No. 9017, "La Cascade," by the Edison Concert Band, is a brilliant concert number, marked by unusually clear orchestration and delightful phrases by the clarinets. Written in the caprice movement. Its composer is Donald Garcia. It is a fine Record and will be appreciated by all.

No. 9018, "Sweet Maid Divine," by Miss Morgan and Mr. Stanley, is a sentimental serio-comic song by Charles K. Harris. It is written somewhat on the order of the "Florodora Sextette" song. It is just as pretty and full of character, and has a sprightly dance played by the orchestra at the finish of the Record.

HE—"Come out, my love, into the moonlight.
And take a little stroll with me,
There's something I want to tell you,
For I love you tenderly."

SHE—"Suppose I wouldn't care to listen.
Would your heart for me then pine?
And would you buy me diamond rings,
If I'd be thine?"

No. 9019, "Good-night, Beloved, Good-night," is another fine Record by the Edison Male Quartette. Records by this Quartette have achieved a new popularity within the last few months, because of the unusually fine character of the songs rendered by them and the artistic manner in which the Records have been made. This song was recently cut from our Catalogue, and is now re-listed as a quartette Record on account of its growing popularity. It is a song of the better grade, and doubtless will be a standard one for a long time to come. James Oliver wrote the music of this song, and Jack Everett Fay, the words. The singers are accompanied by the orchestra.

No. 9020, "Tell Me With Your Eyes Medley," by Arthur Benzler, is a bell solo with orchestra accompaniment. Medleys by the bells have become very popular. This one introduces "Tell Me With Your Eyes" (our Record No. 8945), "Heinie" (our Record No. 8992) and "If I Were Only You" (our Record No. 8659). These popular songs are given with elaborate orchestration.

No. 9021, "On a Summer Night," by MacDonough and Biehling, is a new summer waltz song by Egbert Van Alstyne and Harry Williams, writers of "In the Shade of the Old Apple Tree" (our Record No. 8958) and other hits. The words refer in a clever manner to numerous summer songs of the past. The

orchestral accompaniment is a feature of the Record.

No. 9022, "Beautiful Birds, Sing On," by Harlan and Belmont, is a whistling and singing male duet with orchestra accompaniment. This beautiful selection was previously listed by us, but when we desired to make it over with the new style Record, putting the title on the end of the Record, Mr. Belmont was too far away to join with Mr. Harlan in making the Record, and we were compelled to drop it from the catalogue. Mr. Belmont has since returned to New York and has made it possible to re-list the Record. It is made better than before, and will certainly be a greater seller than ever.

No. 9023, "She Waits by the Deep Blue Sea," by Irving Gillette, is a new descriptive ballad by Theodore Morse (music) and Edward Madden (words). Mr. Morse is also well-known as the composer of "Blue Bell," "I've Got a Feeling for You" and several other of the past season's successes. For her sailor sweetheart, "she waits by the deep blue sea." There's a sob and a tear for each dreary year, As "she waits by the deep blue sea."

No. 9024, "South Carolina Minstrels," by the Edison Minstrels, introduces a comic talk between the end men, Len Spencer and Billy Murray, and the song "It's Aflus de Same in Dixie," by Billy Murray and the Edison Male Quartette. The opening overture by the orchestra is "Beneath the Starry Flag."

No. 9025, "Bunker Hill Medley," by the Edison Military Band, is arranged in march time and introduces five popular songs previously listed as follows: Bunker Hill (our Record No. 8966), "I've Got a Little Money and I Saved It All for You" (our Record No. 8991), "Tammany" (our Record No. 8979), "My Carolina Lady" (our Record No. 8948) and "The Preacher and the Bear" (our Record No. 9000).

HEARD IT PLAYED AND WAS CONVINCED.

"The other day a man stepped into my store to get a cigar and saw a Phonograph setting on the shelf," wrote Henry Halloway, an Edison Dealer, at Pamona, Wis. "He asked me to play a piece for him, saying that he had never seen a machine like that. He said he had heard lots of grindstones or discs but wouldn't have one in his house. He said he would like to see if these machines were any better. So I played Record No. 8659, 'If I Were Only You' and No. 10, 'Belle of New York March.' He said, 'Don't play any more, but just pack up that machine and a 48-inch horn and pick out two dozen good Records, your own choice, so I can take them right along with me.' It was only ten minutes before train time. When I told him that the price of the machine was only \$30 and the Records thirty-five cents each, he said 'I don't care if the price is twice that; I would have one anyway.' This man is a good musician. He was once the leader of the Darlington band and has a piano and other instruments in his home."

EDISON EULOGIES IN SONG.

Thomas A. Edison was the guest of honor at the Magnetic Club's dinner last night at the Hotel Astor. No amount of persuasion could induce Mr. Edison to make a speech, but he enjoyed himself hugely.

The Magnetic Club is made up of the officers and employees of the telegraph, telephone, electric light and electric manufacturing companies of the city. Mr. Edison's presence nearly swamped the dinner. Covers were laid originally for 200, but when people found that the Wizard was to be there everybody wanted to have a place at table. Considerably more than 300 were present.

Col. A. B. Chandler, formerly president of the Postal Telegraph and Cable Company, president of the club, was toastmaster. His speech was punctuated curiously, in a way that made Mr. Edison blush like a girl and raise his hands deprecatingly.

"I desire," said Col. Chandler, "to call attention to the most noteworthy achievements of this great old telegrapher. First, I shall mention the quadruplex transmitter."

Suddenly a busy instrument in the corner of the room set up a clicking and ticking and gave the orchestra and a strong lunged baritone their cue. To the tune of "Grandfather's Clock" everybody sang:

When they tell their stories now of the way they used
to send,
And the record breaking work they used to do;
And the way, every day, they would roast the other
end—
We are sorry that those happy days are through.

Mr. Edison was plainly delighted at the novelty of the idea, but he was a bit overcome by modesty. Col. Chandler went on: "I think that the telephone should be mentioned next."

There was a furious ringing of 'phone bells and a chorus of hellos. The members sang with much enthusiasm a stirring stanza of "Hello, My Baby."

Col. Chandler mentioned the invention of the Phonograph, and from the cavernous mouth of a megaphone came the roar of a brass band going full power. The biggest hit of the dinner was made a moment later, just after the toastmaster got through saying, "but the greatest of all, perhaps, was electric lighting."

Somebody pressed a button. Every light in the room winked out, leaving the room dimly lit by the pink petticoated candles on the tables. Then this very appropriate parody on the "Yankee Consul" song, "The Olden Days," was sung:

It was just like this in the olden days,
Which have passed beyond recall:
In the rare old, old golden days
It was just like this, that's all:
Then we studied hard by the candle light,
With our visions of future gold,
And some have realized all right
Since the days of old.

Col. Chandler finished his speech by complimenting Mr. Edison upon his recovery from a recent serious illness. The members arose at that point and started to drink a very quiet toast to the guest of honor but their enthusi-

asm got away with them and cheers broke out and rolled to the ceiling for a few minutes, bringing Mr. Edison to his feet to bow thanks.

Frederick P. Fish, president of the American Telephone and Telegraph Company, had this to say:

"Mr. Edison's greatest invention was never patented. I doubt if there are half a dozen people who know what it is. The fact that Mr. Edison is the inventor has never been disclosed to the world, even. You see, years ago, when the telephone first came into use, people used to ring a bell and then say ponderously over the wire: 'Are you there? Are you ready to talk?' Well Mr. Edison did away with that awkward, un-American way of doing things. He caught up a receiver one day and yelled into the transmitter one word, a most satisfactory, capable, soul satisfying word, 'Hello!' It has gone clear around the world. The Japs use it. It is heard in Turkey. Russia couldn't do without it. Neither could Patagonia."

Mr. Edison, leaning forward with a hand to his ear, laughed heartily.—*New York Sun*, April 14, 1905.

AN ENGLISH VIEW.

Now it can be said that the voice of the talking machine is heard in the land. The Phonograph, gramophone, or whatever name the marvelous invention of Edison and his imitators may be given, is a product of the age which fulfils many useful purposes. The talking machine does not only talk, it sings, it records, it is a witness. It may be laid under contribution for all sorts of business or private uses. It is a force, and, being so, commands the attention of our readers. The recent law case in Paris will be read with interest, but the judgment, though it may for a time disturb the Phonograph trade in France, is scarcely likely to be confirmed by a higher court, although sympathy may be felt with composers and publishers whose works are reproduced without a "by your leave!" or any payment whatsoever.

So far as Great Britain is concerned, any complaint on this score must be ineffectual, the publishers having agreed to the abolition of fees for performing rights. It is a moot point whether the talking machine vulgarizes or helps to popularize a song or piece. It is probably due to the apparatus when a good singer's voice is reproduced gracefully, and due to a bad machine when the singer's voice is unsatisfactory. Our own opinion is that the talking machine is a distinctly valuable invention with infinite potentialities. We have heard the rendering of certain songs by certain singers, by means of a reproducing instrument which opportunities have not been afforded us to hear at first hand.—*Music*.

PRICES OF EDISON RECORDS.

Edison Gold Moulded Records, standard size, are sold in the United States at 35 cents each, and in Canada at 40 cents each. The Canadian price is higher because of the duty. Edison Concert Records are sold at 75 cents in both countries.

AN INTERESTING ARTICLE.

The May issue of *Strand* contained an illustrated article on Mr. Edison, written by Francis Arthur Jones. The article treated of the life of Mr. Edison and his many inventions, and referred to Mr. Edison's work in connection with the Phonograph, as follows:

Perhaps the room having the greatest amount of interest for the general public is that presided over by A. T. E. Wangemann, and known as Room No. 13, or the Phonograph Experimental Department. Everything connected with the "talking machine" is shown here—hundreds of Records, forests of horns, ranging in length from a few inches to eighteen feet, Phonographs of all sizes and shapes, Records, etc. In this room efforts are being constantly made to obtain better all-round results and superior Records.

"All the work done in this room," Mr. Wangemann said, "is of an experimental nature, and all our efforts are centered on obtaining better apparatus for recording and reproducing, better raw materials for cylinders, and better Records, both blank and moulded, etc. In fact it is here that every effort at improving and advancing the present way of Phonograph productions and reproductions is made. We are constantly experimenting with new Records, new speakers, new compositions for blank Records, new horns or funnels, and, in fact, there is nothing we do not try in order to obtain absolute perfection of sound reproduction."

Mr. Edison has spent many weeks and months in this room, often working until two and three o'clock in the morning. He has a small room partitioned off from the experimental department, and here he sits and listens to Records for many hours at a time, scribbling on scraps of paper his opinion of the various Records. No one is allowed in this room under any consideration. Last year Mr. Edison spent the best part of seven months in this room, endeavoring to render the Phonograph more perfect. He spends much of his time finding out the reasons for poor work, for he believes that more can be learned from things going wrong than from things which go well. As readers may be aware there is no substance known which is proof against influence by sound vibrations, or which will not transmit sound at some velocity. If it were possible to find a substance which would be absolutely dead to sound, and yet solid enough to be used in mechanical construction, then one could obtain for superior reproductions of sound-waves, both vocal and instrumental. * * *

The story of how Mr. Edison came to invent the Phonograph has been told many times and with many variations, and it may not, therefore, be without interest to relate exactly how the wonderful "talking machine" came into existence. Briefly, then, the invention of the Phonograph was the result of pure reason based upon very happy inspiration. In his early work with automatic telegraphs operating at high speeds Mr. Edison had occasion to exper-

iment with embossed strips impressed with dashes and dots thereon which were moved rapidly beneath a stylus to vibrate it. It was observed that this stylus in vibrating produced audible sounds. A small thing such as this would pass unnoticed by the ordinary observer as of no interest, but to a mind that is not only intensely alert but highly analytical it was regarded as a curious phenomenon. At this time Mr. Edison was actively working on his telephone experiments, so that his attention was largely absorbed by matters connected with acoustics. Simply as a matter of *inspiration* the idea of a talking machine occurred to Mr. Edison, and, remembering his experiences with the automatic telegraph transmitter, he concluded that, if the undulations on the strip could give the proper form and arrangement, a diaphragm could be vibrated so as to reproduce any desired sounds.

The next step was to *form* the proper undulations in the strip, and the idea was then suggested to Mr. Edison's mind that these undulations could be produced by *sounds themselves*, which could be then reproduced. When this complete conception was reached the Phonograph was produced. Obviously, the change from a strip of material capable of being impressed by sound-waves to a cylinder of such material on which the sound-waves could be impressed in a spiral line was a refinement of the original conception which simply involved mechanical considerations. It is, therefore, rather an interesting fact that in the development of the Phonograph the reproduction of the sounds *preceded* the original production of the Record.

Readers may also be interested to learn that the first patent on the Phonograph was filed in the United States on December 24th, 1877, and was granted February 19th, 1878, No. 200,521. In this patent is disclosed the now historic instrument in which the sounds are recorded on a sheet of tinfoil applied to a spiral grooved cylinder. Prior to this, however, in an application filed in Great Britain on July 30th, 1877, No. 2,909, Mr. Edison disclosed not only a cylinder Phonograph, but also an apparatus embodying his original conception of an embossed strip. * * *

There seems to be a generally expressed belief that Mr. Edison dislikes the Phonograph, and some papers have gone so far as to affirm that he will not allow one in his house. Again I asked Mr. Edison to corroborate this, but he could not do so. "I am very fond of the Phonograph," he said, "and can listen to good Records by the hour. I do not, perhaps, like the records that are most popular with the public, for I am not particularly fond of comic songs or "rag-time" music. My favorite composer is Beethoven, and I never tire of listening to his symphonies."

Mr. Edison has never spoken into a Phonograph for the purpose of making a selling Record, and seemed surprised when I suggested that if he did so it would certainly have an enormous sale. But he shook his head and modestly declared that he did not think so. He might some day speak into the Phonograph the story of how he invented the talking machine, but he did not consider it very likely.

PREACHED HIS OWN FUNERAL SERMON BY PHONOGRAPH.

Probably the strangest funeral ceremony ever witnessed was performed at Rideout, Ky., on March 9th, when Rev. Henry C. Slade's voice delivered his own funeral sermon, said the *Sunday Press*, of Schenectady, N. Y., on April 23d.

The Baptist Church was thronged with members of the Rev. Mr. Slade's congregation and with the mountaineers of the Jellico district, who came for miles around to hear the minister preach his own funeral service, direct hymns, and call for prayers from certain members of the congregation.

A Phonograph with a large horn attachment stood upon the platform where for eleven years Rev. Mr. Slade stood preaching the gospel of everlasting life to the congregation of mountaineers and miners of the Cumberland Falls district. And where the men and women in homespun and butternut, in the rough attire of miners, bowed their heads, the voice of the dead pastor spoke to them from the machine. The persons who attended the strange funeral ceremony declare it was one of the most solemn and impressive services they ever attended; and even those who came from curiosity remained, awed by the strangeness of the situation and bowed with the members of the congregation.

* * * * *

Last September the "missioner" fell sick. His trouble was Bright's disease. He made a trip to Louisville, consulted with eminent physicians, and realized that there was no hope.

When he returned from Louisville he took with him a Phonograph and a lot of Records, which he intended using in church entertainments. The Phonograph brought to that remote spot of the mountains the latest music, the best of oratory, humorous selections, the greatest songs, the greatest music, and the church was crowded when, instead of the regular Wednesday prayer meetings, Rev. Mr. Slade announced a Phonograph entertainment.

His health failed steadily, and he realized that the end was near, and, by the middle of February, he knew that death was a matter of only a few weeks. Already two acute attacks prostrated him.

On the second Sunday in February he announced to his congregation that he had but a few weeks to live. He was unable to enter his pulpit the next Sunday, and, while prostrate in bed, he conceived the idea of preaching his own funeral oration—a sermon which should climax his life's work.

Drawing the Phonograph close to his bed and inserting a blank Record, he began, and during that quiet afternoon, while his bare cabin in the Kentucky hills was silent and the snow lay deep over the mountains after a storm, he raised up his voice and poured into the Phonograph the story of his life and his plea for the mountaineers.

Mr. Slade died on March 7th, and the funeral services were held in the church on Round Knob on March 9th. To his deacons the minister confided his plans, and they sent out the

word that Rev. Mr. Slade would preach his own funeral sermon. The superstitious, all too ignorant members of his congregation spread the word, and it became a thing of wonder in the mountains. The church was crowded.

The body of the minister was borne into the church and the coffin laid upon the trestles in front of the altar. Then Deacon Kerens carried the Phonograph to the platform and started it.

The voice of the dead minister spoke, saying: "The Lord giveth and the Lord taketh away."

The voice of him who lay dead in the coffin gave out the hymn, and, half frightened, the mountaineers arose and sang.

Then the funeral sermon opened.

Plainly, without effort, the voice told of the early struggles of the dead man, of his hopes, his fears, his troubles, his prayers. It told of his coming to the Pine mountains, of his reception, his striving against great odds.

And, as the climax of the sermon, the voice adjured them to be constant in well doing.

Then, suddenly the voice commanded the congregation to rise and sing, and they sang, "Jesus Lover of My Soul."

THE EXPERIENCE OF A "GEM."

"I believe it may interest you to know of the extraordinary experience of one of your Gem Phonographs," wrote William Ross, of Balham, S. W., on April 5th. "I recently had a fire at my private residence, 18 Ryde Vale road, Balham, S. W., almost everything being burnt out. The Gem machine was right through it, and although the cover was badly scorched, I was surprised to find that the machine played as well as ever. I have been thinking that this might be a useful advertisement for you, and you are at liberty to use this letter as you think fit."

AN ODD ERROR.

An error was made in printing the advance list and bulletin of May Records that illustrates how easy it is to overlook mistakes in proof-reading. When the May list was first typewritten, Nos. 9000 and 9001 were printed as Nos. 9900 and 9901. This was given to the printer as copy, and although proofs were read by several different persons, the error was not discovered till after part of the May printing had been done. It is probable, too, that few readers of the PHONOGRAPH MONTHLY detected the error.

FURNISHED MUSIC FOR A DANCE.

Following is a copy of a poster received last month from an Edison Dealer at Covington, Ky.:

SOCIAL DANCE!

To be given by the Young Men of
Fort Covington,

IN FIREMEN'S HALL, ON
FRIDAY, APRIL 28, 1905.

MUSIC FURNISHED BY

FARQUHAR'S EDISON PHONOGRAPH.

Come and bring your ladies and enjoy a grand old time. The music alone is worth the price of admission. A choice selection of New Records just out.

PRICE 50 CENTS A COUPLE.

THE PHONOGRAM.

Dealers desiring to get a supply of *Phonograms* to mail to their customers must order them of Jobbers four weeks in advance, and we cannot agree to fill Jobbers' orders unless placed with us a similar period in advance. We again ran out of May *Phonograms* before they were shipped to the trade, although the edition was over 200,000, and were compelled to print an additional supply. We plan to print about 10,000 more than we have orders for when we go to press, five weeks in advance of the month of issue, but frequently these are soon used up with extra orders.

Following is a schedule of prices at which *Phonograms* may be obtained by the trade:

DELIVERED WITH GOODS.

Blank, per 1000 copies.....\$2.50
Smaller quantities pro rata.

Imprinted, per 500 copies..... 1.50

Imprinted, per 1000 copies..... 2.75

No orders filled for less than 500 copies requiring imprint, and all imprinting orders must be for multiples of 500.

Most Jobbers will be glad to supply Dealers on the above basis.

BY MAIL.

Single copies, per year.....\$.20

Five copies to one address, per year..... .40

Twenty-five copies to one address, per year 1.80

Fifty copies to one address, per year.... 3.60

Unless they have open accounts on our books, Dealers ordering *Phonograms* sent by mail are requested to send cash or stamps with their orders. The amounts are too small to handle in any other way.

THE PRICE AGREEMENT.

A correspondent in the *Talking Machine News* of London writes as follows:

A large percentage of people do not thoroughly understand the price agreement. Many look upon it as being somewhat dictatorial or as a scheme of the strong manufacturer to coerce the shopkeeper into doing something for the sole gain of the former. I am glad to attest that this feeling has now almost entirely disappeared and the reputable Dealer now sees the price agreement in an entirely different light and knows by practical demonstration that it is an instrument designed primarily for the good of the Dealer and that he is the greater gainer by its protection. As a matter of fact the manufacturer gets comparatively little benefit, except in so far as it prevents the wholesale cutting of prices which ultimately would destroy the reputation of his product that would otherwise be maintained. Where is there a person who doubts that a manufacturer now selling his wares under price agreement principles could sell more goods (and get just as much for them wholesale) if he should lay aside the price agreement? And who is the real beneficiary under such a scheme? It must necessarily be the one who sells the article to the retail customer and gets the fair profit that the price agreement

guarantees. Where there is no price maintaining agreement covering an article it is most often, if not always, sold by the stores at a reduction in price that the shopkeeper cannot meet and still pay rent. I claim, and history proves, that the price agreement has done more good for the legitimate Dealer than anything else that has ever been discovered since price cutting became popular. Of course the benefit derived from such a measure depends largely, if not wholly, on its rigid maintenance and it is the wise dealer who sticks to the manufacturer whose agreement affords him the greatest protection.

A DEALER'S SOLICITING LETTER.

Yale, Iowa, April 13, 1905.

Dear Friends.—I have secured the agency for the justly celebrated Edison Phonograph. This is certainly the King of all machines of its kind and one that will be an ornament and a source of endless pleasure in any home.

With one of these machines you can not only reproduce selections played by the best artists in the world but you can make records that will reproduce the exact voice of any one in the home and as they last indefinitely you may some day place a value on these records that you little dreamed of when in the fullness of strength you amuse yourself in the making of them.

If you are a lover of good music, come to the store and let us play you a few Records and show you the workings of a perfect machine; one that fills a long-felt want in the home. I shall be glad to play for you any time except Saturday. I have in stock all the latest and most popular Records. Come in and see us. You are always welcome.

W. A. SHEETS.

HEARD HIMSELF AS OTHERS HEAR HIM

An amateur flutist once stopped in at a fair where a talking machine company had an elaborate exhibit, and showed such an interest in the talking machines that the attendant thought a sale was imminent, and worked very hard to effect it.

"I see you have your flute with you," he said, finally. "Suppose you play a brief selection, and I will make a record of it, and you will then be able to hear the machine reproduce it exactly."

The suggestion pleased the amateur musician, and the idea was carried out.

"Is that an exact reproduction of my music?" he asked, when the tune was finished.

"It is," replied the attendant. "Do you wish to buy the talking machine?"

"No," said the other, sadly, as he slowly moved away. "But I'll sell the flute."—*Popular Magazine*.

WILLY NILLY.

"My daughter wants a talking machine," said the man.

"Ah!" said the Dealer, "you want to buy one."—

"No, I don't," interrupted the man hastily, "but it looks as if I'd have too."—*Exchange*.

JOBBER'S OF EDISON PHONOGRAPHS AND RECORDS.

ALABAMA.

Birmingham—Talking Machine Co., 2007 Second ave.
Mobile—W. H. Reynolds, 167 Dauphin street.
Montgomery—R. L. Penick, 119 Dexter ave.

CALIFORNIA.

San Francisco—Peter Bacigalupi, 786-788 Mission street.

COLORADO.

Denver—Denver Dry Goods Co., 619 16th street.

CONNECTICUT.

Middletown—Caulkins & Post Co., 406-408 Main street.
Hartford—Harry Jackson, 300 Asylum street.
New Haven—Pardee-Ellenberger Co., 155 Orange st.

DISTRICT OF COLUMBIA.

Washington—E. F. Droop & Sons Co., 925 Pennsylvania avenue, N. W.
 S. Kann Sons & Co., 8th and Pennsylvania avenues.

GEORGIA.

Atlanta—Atlanta Phonograph Co., 49 Peachtree St.
 *Waycross—George R. Youmans.

ILLINOIS.

Chicago—James I. Lyons, 73 Fifth avenue.
 Siegel, Cooper & Co., 281 State street.
 Talking Machine Co., 107 Madison street.
 The Vim Co., 68 E. Lake street.
 Montgomery Ward & Co., 111 Michigan ave.
 Rudolph Wurlitzer Co., 302 Wabash ave.
Peoria—Peoria Phonograph Co., 222 Bridge street.
 *Quincy—Quincy Phonograph Co., 808 Hampshire st.

INDIANA.

Indianapolis—Craig-Jay Co., 234 Massachusetts ave.
 Kipp Bros. Co., 37 S. Meridian street.
 A. B. Wahl & Co., 119 S. Illinois street.
Lafayette—A. B. Wahl & Co., 304 Main street.

IOWA.

Des Moines—Hopkins Bros. Co., 620 Locust street.
 Vim Co., 704 West Walnut street.
Fort Dodge—Early Music House, 822 Central ave.

KENTUCKY.

Louisville—C. A. Ray, 640 Fourth street.

LOUISIANA.

New Orleans—William Bailey, 600 Frenchman street.
 National Automatic Fire Alarm Co.,
 614 Gravier street.

MAINE.

Bangor—S. L. Crosby Co., 186 Exchange street.
Portland—W. H. Ross & Son, 207 Commercial street.

MASSACHUSETTS.

Boston—Boston Cycle & Sundry Co., 48 Hanover street.
 Eastern Talking Mach. Co., 177 Tremont st.
 Iver Johnson Sptg. Goods Co., 163 Washington street.
 C. E. Osgood Co., 744 Washington street.
 Read & Read, 558 Washington street.
Fitchburg—Iver Johnson Sptg. Goods Co., 247 Main st.
Lowell—Thomas Wardell, 111 Central street.
New Bedford—Household Furnishing Co., 170 Purchase street.
 *Springfield—Flint & Brickett Co., 439 Main st.
Worcester—Iver Johnson Sptg. Goods Co., 304 Main st.

MICHIGAN.

Detroit—American Phono. Co., 106 Woodward ave.
 Grinnell Bros. 219 Woodward ave.
Saginaw—Morley Bros.

MINNESOTA.

Minneapolis—Thomas C. Hough, 714 Hennepin ave.
St. Paul—W. J. Dyer & Bro., 21-23 West 5th street.
 Thomas C. Hough, 392 Wabasha street.
 Minnesota Phonograph Co., 37 E. 7th street.

MISSOURI.

Kansas City—J. W. Jenkins' Sons Music Co., 1013-1015 Walnut street.
 *J. F. Schmelzer & Sons Arms Co., 710 Main street.
St. Louis—Conroy Co., 1115 Olive street.
 O. K. Houck Piano Co., 1118 Olive street.

NEBRASKA.

Lincoln—H. E. Sidles Cycle Co., 1317 O street.
Omaha—Nebraska Cycle Co., 15th and Harney streets.
 Omaha Bicycle Co., 16th & Chicago sts.

NEW JERSEY.

Hoboken—Eclipse Phono. Co., 205 Washington st.
Newark—A. O. Petit, New and Halsey streets.
Paterson—James K. O'Dea, 117 Ellison street.
Trenton—Stoll Blank Book and Stationery Co., 30 E. State street.

NEW YORK.

Albany—Finch & Hahn, 92 State street.
Brooklyn—Chapman & Co., Fulton and Duffield streets.
 A. D. Matthews' Sons, 394 Fulton street.
 Price Phonograph Co., 1258 Broadway.
Buffalo—P. A. Powers, 643 Main street.
Elmira—Elmira Arms Co., 117 Main street.
Gloversville—American Phono. Co., 99 W. Fulton st.
Kingston—Forsyth & Davis, 307 Wall street.
New York City—Bettini Phono. Co., 80 Chambers street.
 Blackman Talking Machine Co., 97 Chambers street.
 J. F. Blackman & Son, 2737 3d avenue.
 I. Davega, Jr., 802 Third avenue.
 S. B. Davega, 32 E. 14th street.
 Douglas Phono. Co., 89 Chambers st.
 H. S. Gordon, 139 Fifth avenue.
 Harry Jackson, 219 Bowery.
 Jacot Music Box Co., 39 Union Square.
 Victor H. Rapke, 1661 Second avenue.
 Siegel-Cooper Co.
 John Wanamaker.
 *Alfred Weiss, 1525 First avenue.
Oswego—Frank E. Bolway, 32 Bridge street.
Poughkeepsie—Price Phonograph Co., 203 Main st.
Rochester—A. J. Deninger, 345 North street.
 Mackie Piano, O. & M. Co., 100 State street.
 Giles B. Miller, 63 State street.
 Talking Machine Co., 97 Main st., E.
Schenectady—Finch & Hahn, 456 State street.
 Jay A. Rickard & Co., 253 State street.
Syracuse—W. D. Andrews, 216 E. Railroad street.
Troy—Finch & Hahn, 7 Third street.
 Troy Automobile Exchange, 359 Fulton street.
Utica—Clark-Horrocks Co., 54 Genesee street.
 Arthur F. Ferriss, 89 Washington street.
 William Harrison, 41 Columbia street.
 Utica Cycle Co., 31 Columbia street.

OHIO.

Canton—Klein & Heffelman Co., 216 N. Market street.
Cincinnati—Ilsen & Co., 25 W. 6th street.
 A. B. Wahl & Co., 805 Vine street.
 Rudolph Wurlitzer Co., 10-12 W. 4th st.
Cleveland—W. J. Roberts, Jr., Erie and Huron streets.
Columbus—Perry B. Whitsit Co., 213 S. High street.
Dayton—Niehaus & Dohse, 35 E. 5th street.
East Liverpool—Smith & Phillips Music Co.
Newark—Hoover-Ball Co., Inc.
Toledo—Hayes Music Co., 608 Cherry street.

PENNSYLVANIA.

Allegheny—Henry Braun, 500 Federal street.
Allentown—G. C. Aschbach, 539 Hamilton street.
Easton—William Werner, 401 Northampton street.
Harrisburg—S. K. Hamburger, 12-14 N. Market sq.
Philadelphia—C. J. Heppe & Son, 1117 Chestnut street.
 Lit Bros., Market and 8th streets.
 Penn Phonograph Co., 17 S. 9th street.
 John Wanamaker, 13th and Market sts.
 Wells Phonograph Co., 41 N. 9th street.
 Western Talking Mach. Co., 25 S. 9th st.
 H. A. Weymann & Son, 923 Market st.
Pittsburg—Theo. F. Bentel Co., Inc., 632 Liberty street.
 Kaufmann Bros., Fifth avenue.
 H. Kleber & Bro., 221 Fifth avenue.
 C. C. Mellor Co., 319 Fifth avenue.
 Pittsburg Phono. Co., 937 Liberty street.
Reading—Reading Phonograph Co., 809 Penn street.
Scranton—Ackerman & Co., 130 Wyoming avenue.
 Technical Supply Co.

RHODE ISLAND.

Pawtucket—Pawtucket Furniture Co., 39 N. Main St.
Providence—J. M. Dean Co., 785-795 Westminster street.
 J. A. Foster Co., Weybosset st.
 Household Furniture Co.
 J. Samuels & Bro., 154 Weybossett street.
 A. T. Scattergood & Co., 106 N. Main st.

TENNESSEE.

Knoxville—Knoxville Typewriter and Phonograph Co., 311 Clinch street.
Memphis—O. K. Houck Piano Co., 359 Main street.
 *F. M. Atwood, Lyceum Building.
Nashville—Nashville Talking Mach. Co., 510 Church st.
 Magruder & Co., 13 Arcade.

Continued on page 15.

JOBBER'S OF EDISON PHONOGRAPHS AND RECORDS—Continued.

TEXAS.

Dallas—Southern Talking Machine Co., 347 Main st.
 Fort Worth—Cummings, Shepherd & Co., 700 Houston st.

Houston—H. M. Holleman Co., 612 Fannin street.

VIRGINIA.

*Richmond—Magruder & Co., 729 E. Main st.

WISCONSIN.

Milwaukee—McGreal Bros., 173 3d street.

CANADA.

Toronto—R. S. Williams & Sons Co., Limited,
 143 Yonge street.

* Added since April 1, 1905.

SUSPENDED LIST, MAY 1, 1905.

SUPERSEDING ALL PREVIOUS LISTS.

ILLINOIS.

Ottawa—Edward Hayne.

Wheaton—E. Irving.

INDIANA.

South Bend—EUGENE MARSH, 126 Vistula avenue.
 SOUTH BEND BOOK BINDERY, Robert
 Lebolt, Prop., 203 North Michigan street.

IOWA.

Burlington—JOHN P. WEISS, 711 Jefferson street.

Sioux City—HATTENBACH BROS. CO.

KANSAS.

Clay Centre—E. M. GOWENLOCK.

Lawrence—BELL BROS.

MAINE.

Biddeford—W. H. FIELD.

Monmouth—G. H. STETSON.

MASSACHUSETTS.

Boston—T. SINGER, 60 Leverett street.

Lawrence—LORD & CO., 314 Essex street.

E. O. MOSHER, 420 Essex street.

Lynn—ELIAS DEYOUNG.

Malden—A. T. FULLER.

Nantucket—ARTHUR M. TAYLOR.

New Bedford—H. B. DEWOLFF.

Somerville—E. J. WINCHESTER, 32 Summit avenue.

Woburn—OSBORN GILLETTE, or THE BOLTON
 JEWELRY CO., L. F. Maloney, Manager.

MICHIGAN.

Detroit—F. J. SCHWANKOVSKY.

Saginaw—GEO. W. EMENDORFER.

JAMES V. CALAHAN, 217 Genessee st.

TIERNEY BROS., 217 Genessee st.

MISSOURI.

Kansas City—THE WITTMANN CO.

NEBRASKA.

Lincoln—THE WITTMANN CO.

Omaha—THE WITTMANN CO.

NEW HAMPSHIRE.

Hillsboro Bridge—E. M. BARNES.

Manchester—A. E. DUMAS

Nashua—F. A. MCMASTER & CO.

NEW JERSEY.

Atlantic City—SAM'L D. WOLF, 32-34 Arkansas ave.

Bayonne—I. WIGDOR, 450 Avenue D.

Jersey City—W. L. HOFFMAN, 151 Montgomery st.

Newark—R. L. CORWIN; also New York City.

Passaic—I. HURWITZ.

Paterson—CHAS. H. KELLY, 25 N. Main street.

Plainfield—S. W. FRUCHT, or R. FRUCHT; also
 New York City.

ELSTON M. LEONARD.

West Hoboken—EMIL HOLLANDER, or THE WEST
 HOBOKEN BICYCLE & PHONO. CO., 619
 Spring street.

NEW YORK.

Albany—G. LINDE, 353 S. Pearl street.

Bedford Park—GEO. H. TYRRELL.

Hobart—F. H. MARSHALL.

New York City—A. T. ARMSTRONG, or AMERI-
 CAN PHONO. CO., 106 Wall street.

BERN BEARWALD, 373 W. 11th st.

BRONX PHONO. CO. or DAVID SWITKY,
 506 Willis ave.

CENTRAL PHONO. CO., 160 E. 42d street.

R. L. CORWIN; also Newark, N. J.

EAGLE PHONO. CO., or C. LOWENTHAL,
 83 Nassau street.

EMPIRE PHONO. CO., 2 W. 14th street.

S. W. FRUCHT, or R. FRUCHT, 7 Barclay st.,
 or 68 Cortlandt st.; also Plainfield, N. J.

O. HACKER, 2 Murray street.

HAWTHORNE & SHEBLE, 297 Broadway;
 also Philadelphia, Pa.

HOLOBER BROS., 350, 421 and 491 West st.

N. HORN, 148 E. 58th street.

W. L. ISAACS, 114 Fulton street.

S. LEMBURG & CO., 194 Broadway.

J. MCELLYNNE, 202 Broadway.

RICHMOND PEASE, 44 W. 132d st.

F. M. PRESCOTT, 44 Broad st.

WINTHROP CYCLE CO., 2212 Seventh ave.

Rome—CHARLES TUTTLE.

Saratoga—W. J. TOTTEN.

Saratoga Springs—MARVIN A. COTE.

OHIO.

Cincinnati—J. L. ANDEM.

Coshocton—BURNS & GOSSER.

Springfield—D. & M. VANDERPOOL.

Uhrichsville—F. A. MAZURIE.

PENNSYLVANIA.

Philadelphia—A. R. CASSIDY, 2783 Emerald street.

HAWTHORNE & SHEBLE, 604 Chestnut st., or
 Oxford and Mascher sts.; also New York City.

A. KROUSE, 832 Arch street.

PENN NOVELTY CO., 15 South 9th st.

Phoenixville—KEINARD BROS.

Pittsburg—A. LIPPARD, 615 Wylie ave.

RHODE ISLAND.

Providence—F. P. MOORE.

WISCONSIN.

Milwaukee—J. C. BLATZEK.

* Added Since April 1, 1905.

Jobbers and Dealers are asked not to supply any of the above named firms with our apparatus, either at addresses given or any other address.



DOUBLE SERVICE



MUSIC FOR EVERY HOME

TRADE
Thomas A. Edison
MARK

I.C.S.
TEXTBOOK

FRENCH, GERMAN AND SPANISH

MAY 1905

SUN	MON	TUE	WED	THU	FRI	SAT
	1	2	3	4	5	6
7	8	9	10	11	12	13
14	15	16	17	18	19	20
21	22	23	24	25	26	27
28	29	30	31			

AMUSEMENT
EDISON
GOLD MOULDED
RECORDS

LANGUAGE
STUDY
I.C.S.
LANGUAGE
SYSTEM

The Edison Trade are the only merchants allowed to sell I. C. S. Language Outfits. Send \$2.00 for Agent's Sample Outfit and instructions for representing "Double Service," including sample moulded records in French, German, Spanish, and English. *Write today!* Address:

LANGUAGE DEPARTMENT
INTERNATIONAL CORRESPONDENCE SCHOOLS
 SCRANTON, PA.

FOR FOREIGN SALES, ADDRESS { Foreign Dept., National Phonograph Co., 31 Union Square, New York City.
 European Headquarters, National Phonograph Co., Ltd., 25 Clerkenwell Road, London, E. C.

EDISON Phonograph Monthly

PUBLISHED FOR TRADE USE ONLY BY
THE NATIONAL PHONOGRAPH CO.

VOL. III.

ORANGE, N. J., JUNE, 1905.

No. 4.

NATIONAL PHONOGRAPH CO.
ORANGE, N. J.

NEW YORK: 31 UNION SQUARE.

CHICAGO: 304 WABASH AVENUE.

SAN FRANCISCO: 786 MISSION STREET.

NATIONAL PHONOGRAPH CO., LTD., 25 CLERKENWELL
ROAD, LONDON, ENG.

EDISON PHONOGRAPHS AND RECORDS.

All communications to THE PHONOGRAPH MONTHLY
should be addressed to the Advertising Department,
Orange, N. J.

C O N T E N T S

A Prosperous Summer Assured.....	1
New Exchange Proposition.....	3
Large Portrait of Mr. Edison for Every Dealer	3
1804 new Dealers in Six Months.....	3
Reproducer Exchange Proposition.....	3
The Ideal Jobber.....	4
Foreign Selections Dropped from Cata- logues	4
Printed Matter	5
Among the Jobbers.....	5
Points for the Trade.....	6
Making Records Makes Sales.....	6
United States Law Upheld.....	6
Electros of the Monthly List.....	6
Notice to Jobbers.....	7
Notice to Dealers.....	7
Edison Gold Moulded Records for July... ..	8
160 new Mexican Selections.....	10
For Tuning Phonograph Records.....	12
Collins and Harlan at Milwaukee.....	15
Store of I. F. Eastman, Lewiston, Me.....	15
Jobbers of Edison Phonographs and Rec- ords	14
Suspended List, June 1, 1905.....	15

A PROSPEROUS SUMMER ASSURED.

The first of the summer months opens with the National Phonograph Company enjoying a volume of business greatly in excess of any similar time in the history of the company. Despite the near approach of hot weather, when the demand for all goods of an indoor amusement character falls off, there is as yet little indication of a considerable reduction in the talking machine line as represented by Edison Phonographs and Records. The May orders for both were nearly as great as in any of the three previous record-breaking months and the orders for June Records were only ten per cent. less than for May, when they reached the high-water mark for one month's list. Since the June Records will not be fairly on sale until the first week in June this great business shows that Dealers are of the opinion that trade is going to be much better this summer than in any previous year. As a rule they are shrewd buyers and they do not buy what they do not expect to sell. No one expects to sell as many Phonographs and Records in July and August as in the colder months, but every one seems to be counting on a splendid summer business, and when most men count upon doing a thing they generally come close to doing it. Enthusiasm is an important factor in business and Edison Dealers have it to a marked degree this year. An unusually fine list of Edison Records is being put out for July. Its merit will do much to keep up the volume of the business in July and should make many persons want a Phonograph in order that they may have the means of hearing these fine reproductions of instrumental and vocal music. In no previous list has the superior work of our Recording Department been more noticeable, and it is doubtful if twenty-four Records of equal merit have ever been put out in one month. The trade will not agree upon the character of the selections, but there can be no division on the question of quality of recording.

THE ADVANCE LIST OF JULY RECORDS APPEARS ON PAGE 2.

NEW EDISON GOLD MOULDED RECORDS. ADVANCE LIST FOR JULY, 1905.

RECORDS listed below will be ready for shipment as near July 1st as possible, at which time Jobbers' stock orders, if received prior to June 10th, will be shipped. July Supplements will be forwarded to Jobbers with their stock order for Records. Retail Dealers should place stock orders with their Jobbers at once, to insure prompt shipment as soon as Jobbers' stock is received.

- | | | |
|------|---|-----------------------------|
| 9026 | Second Hungarian Rhapsody (<i>Liszt</i>) | Edison Concert Band |
| 9027 | To My First Love (<i>Löhr</i>) <i>Orch. accom.</i> | Irving Gillette |
| 9028 | Come Along, Little Girl, Come Along (<i>Mullen</i>)
<i>New summer waltz song, Orch. accom.</i> | Collins and Harlan |
| 9029 | Summer Night's Dream Overture (<i>Suppe</i>) | Edison Symphony Orchestra |
| 9030 | Courting Malinda <i>Rube dialect talking selection</i> | "Cyrus Pippins" |
| 9031 | The Glory Song (<i>Great English Revival Hymn</i>)
<i>Tenor and baritone duet, Orch. accom.</i> | Anthony and Harrison |
| 9032 | Flag of Victory March (<i>F. von Blon</i>) | Edison Military Band |
| 9033 | Shame on You (<i>Smith and Larkins</i>)
<i>Coon song, Orch. accom., sung by the "White Coon."</i> | Tascott |
| 9034 | Good-bye, Sweet Marie (<i>Kerry Mills</i>)
<i>New-march song, Orch. accom.</i> | Harry MacDonough |
| 9035 | Two Little Bullfinches Polka' (<i>Kling</i>) <i>Clarinet duet, Orch. accom.</i> | Rubel and Tuson |
| 9036 | Antony and Cleopatra
<i>A Shakespearean travesty, with orchestral incidental music.</i> | Ada Jones and Len Spencer |
| 9037 | Me an' de Minstrel Ban' (<i>Vaughan</i>)
<i>Coon song, Orch. accom., introducing a minstrel band on parade.</i> | Billy Murray |
| 9038 | Alpine Violets (<i>André</i>) <i>Violin and flute duet, Piano accom.</i> | Jaudas and Rose |
| 9039 | He Looks Just Like His Mother (<i>Thornton</i>)
<i>Descriptive song, Orch. accom.</i> | Byron G. Harlan |
| 9040 | I Need Thee Every Hour (<i>Lowry</i>)
<i>Sacred male duet, Orch. accom.</i> | MacDonough and Biehling |
| 9041 | American Fantasie (<i>Victor Herbert</i>) | Edison Concert Band |
| 9042 | The Goose-Bone Man (<i>Allen</i>)
<i>Coon song, Orch. accom., introducing the Goose-Bone Man's prophesied "Storm Scene."</i> | Arthur Collins |
| 9043 | Sambo and Dinah (<i>Cole and Johnson</i>)
<i>Contralto and baritone duet, Orch. accom.</i> | Miss Nelson and Mr. Stanley |
| 9044 | Down in Blossom Row Medley
<i>Xylophone solo, Orch. accom., introducing "Down in Blossom Row," "Susan Van Doozen" and "On a Summer Night."</i> | Albert Benzler |
| 9045 | Song of the Turnkey (<i>DeKoven</i>)
<i>Basso song from "Rob Roy," Orch. accom.</i> | Frank C. Stanley |
| 9046 | Now What d'ye Think of That (<i>Mullen</i>) <i>Comic song, Orch. accom.</i> | Bob Roberts |
| 9047 | Songs My Mammy Sang to Me (<i>J. W. Kelly</i>)
<i>Descriptive song, Orch. accom.</i> | Ada Jones |
| 9048 | I Wonder if You Miss Me (<i>Snyder</i>)
<i>Male quartette, Orch. accom.</i> | Edison Male Quartette |
| 9049 | Ev'ry Little Bit Helps Medley
<i>Introducing "Ev'ry Little Bit Helps," "You're My Heart's Desire, I Love You, Nellie Dean," "Paddy's Day," "Sweet Maid Divine" and "Hey! Mister Joshua."</i> | Edison Military Band |

Edison Gold Moulded Records are made only in Standard Size. Both Standard and Concert Records may be ordered from this list. Order by number, not title. If Concert Records are wanted, give the number and letter C.

NEW EXCHANGE PROPOSITIONS.

On other pages in this issue we print in full copies of the letters that have just been mailed to Jobbers and Dealers with reference to returning cracked, broken and defective Records for credit. These letters have been specially mailed, under sealed cover, to all Jobbers and Dealers. They should be carefully read by their recipients. These exchange propositions have been carefully considered and we believe that their provisions are fair and just to the trade and ourselves. This plan will be operative until further notice.

A LARGE PORTRAIT OF MR. EDISON FOR EVERY DEALER.

We have just had made a quantity of what we consider the most attractive show card ever issued by the National Phonograph Co. It is really a steel sign, for it is made of thirty-two-gauge sheet steel. It is 13x19 inches in size and is lithographed in a handsome manner. In the center is a large and lifelike portrait of Thomas A. Edison with his characteristic signature below the portrait. The background surrounding the portrait is lithographed to imitate mahogany and is so well done as to look like the real article. At the top, above the portrait, are the words "Edison Phonographs and Edison Gold Moulded Records" in red and gold. A quantity of these signs has been shipped to all Jobbers, the number being in proportion to their Dealers. An order has been mailed to every Dealer entitling him to one of these signs upon presentation to his Jobber. We were compelled to again resort to this plan of distribution to prevent extensive duplication owing to the fact that many Dealers sign agreements with several Jobbers. No Dealer should fail to present his order and get one of these signs. They are a work of art and a credit to the Charles W. Shonk Co., of Chicago, who made them.

A PLEASSED ENGLISH DEALER.

Following is a letter received by the National Phonograph Co., Ltd., London, from one of its Dealers:

LINCOLN, April 27, 1905.

Your advertisement in the *Daily Mail* is already a success and is increasing our sales of Phonographs and Records. Once we have supplied a customer with your Records he will not have any other make. Last year we stocked 400 of your Records; this year we stock 5,000, and we are contemplating still further increasing our stock. We can say that every customer is a satisfied customer. No one could wish for greater satisfaction than this.

A. C. SMITH.

1804 NEW DEALERS IN SIX MONTHS.

On July 16, 1904, new conditions concerning Edison goods went into effect and all Dealers were required to sign a new agreement. On November 1 the names of those who had not signed were removed from our files. All those who desired to become Edison Dealers after that date were required to sign the new agreement and purchase the initial quantity. Between November 1 and May 1 of this year 1804 firms in the United States and Canada became Dealers in this manner, an average of nearly seventy a week. This is a record to be proud of. We doubt if the history of the talking machine industry has ever seen its equal. And yet the same average continues practically unchanged. To have 1804 different firms take up the Edison line in a period of six months speaks volumes for the merit and popularity of Edison Phonographs and Records. It is a further evidence of the hold that Edison goods have upon the buying public, for most of these firms went into the business because they knew that the demand existed for the Edison product and they wanted to get a share of the profits.

REPRODUCER EXCHANGE PROPOSITION.

Many Jobbers and Dealers seem to have forgotten the exchange proposition with reference to old style Reproducers. When the Model C was put out an exchange proposition was put into effect by which any owner of an old style Reproducer could return it and secure a Model C by the payment of \$3. This proposition was accepted by many owners, but for some time past the matter seems to have been overlooked by the trade generally, although old style Reproducers are still occasionally being returned for credit. Jobbers are allowed to return any old style Edison Reproducer to us at \$2 each, less usual Jobbers' discounts, and Dealers may return them to Jobbers on the same basis, less Dealers' discounts. The trade should encourage Phonograph owners to make this exchange of Reproducers, for it makes Phonographs more up-to-date and is calculated to increase the purchase of additional Records. It should be borne in mind, however, that the Model C Reproducer cannot be used on the Concert machine.

A BREEZE FROM A BREEZY COUNTRY.

CODY, Wyo., April 27, 1905.

I wish to buy an *Edison* Phonograph and no other. Have written several letters to various firms, all of whom recommend some of those dog-voiced, pie-plate machines, which I don't want at any price.

D. F. P.

THE IDEAL JOBBER.

The ideal Jobber in Edison Phonographs and Edison Gold Moulded Records possesses the following good points:

He has a store sufficiently large to carry an ample stock of machines and Records.

He studies the most advantageous and most economical methods of handling his stock so as to know where to find everything with the least loss of time and trouble, and in a way to make it possible to determine in a few minutes just what titles need replenishing.

He carries a large enough stock of every Record in the Edison catalogues and supplements to make him independent of the delays of the factory and the railroads. With such a stock he is always in a position to give his Dealers perfect service.

He makes every effort to look after the requirements of his Dealers. He gets them to carry as complete a stock as possible, and assists them in making proper selections where they cannot carry the complete line. To enable them to order intelligently he invites them to visit his store each month and hear the sample Records, or he ships them from place to place for the same purpose. He fills their orders completely, without substitutions, and as quickly as shipping facilities will permit.

He watches the literature sent him by the National Phonograph Co. and immediately orders such quantities of the various forms as will supply his Dealers. Upon its receipt he sees that some of each are sent to Dealers with their goods.

He makes up a mailing list of owners of cylinder machines and sees that a list of new Records each month and other printed matter are sent them regularly. He encourages his Dealers to do likewise.

He pays the same attention to the Jobbing end of his business as he does to selling at retail, realizing that the greater volume of jobbing orders makes up for the difference in selling profits.

Lastly, or really firstly, he keeps on such good terms with the credit manager as to make the latter look with joy upon his constantly increasing statement.

THEY KNOW A GOOD THING.

CRESCENT CITY, Cal., May 10, 1905.

I have a small stock of several other makes of talking machines, but very seldom sell any of them, because the majority of the people here know a good thing when they see and hear it, and thereby stick to the original—the Edison.

PETER DUFFY.

FOREIGN SELECTIONS DROPPED FROM CATALOGUES.

When Foreign Record Catalogue, Form 555, was superseded by Form 640, sixty-seven titles were cut out. This was done because the moulds were no longer in proper condition for this work, or to other causes which made it impossible to fill orders for these particular selections. No notice of these cut-outs was given the trade, for the reason that it was thought to be not important enough to warrant the issuance of such a notice. Some Jobbers, however, have desired to rearrange their stocks, and for the benefit of them and such Dealers as may carry a complete stock of foreign selections, the list is published as follows:

BRITISH—12833, 12834, 12845, 12851, 12872, 12875, 12922, 12926, 12929, 12933, 12958.

FRENCH—12287, 12290, 12292, 12298, 12301, 12302, 12303, 12314, 12318, 12321, 12327, 12331, 12335, 12339, 12341, 12349, 12351, 12353.

SPANISH—12562, 12563, 12564, 12565, 12567, 12569, 12570, 12571, 12572, 12574, 12577, 12578, 12579, 12581, 12582, 12583, 12584, 12586, 12587, 12588, 12589, 12590, 12591, 12592, 12593, 12594, 12595, 12596, 12597, 12598, 12658, 12659, 12660, 12661, 12663, 12789, 12790.

In addition to the above, and for the same reasons, it has been decided to drop from the next edition of the Foreign Record Catalogue, the following titles:

FRENCH.

12289	Romance de l'Etoile	Maréchal
12293	L'Oiseau s'envole	Maréchal
12310	La voix des Chênes	Bartel
12324	Toréador! en garde	Bartel

GERMAN.

12233	Sponst Spielt' ich mit Szepter	Porten
12375	Ach, ich hab sie ja nur auf die Schulter geküsst	Porten
12387	Mag der Himmel euch vergeben	Hofmann
12392	Dein gedenk' ich, Margarethe	Schumann
12401	Mein Leid	Reimann
12808	Vergiss mein nicht	Münch

ITALIAN.

12428	Canzone del Toreador	Rossi
12476	Brindisi—Cavalleria Rusticana	Mielino
12500	Serenata—Don Pasquale	Sala
12654	Dio mi potevi scagliar—Otello	Gambardello

SPANISH.

12102	La Paloma—Castenets	Vargas
12166	De tu Patria—Traviata	Vargas
12201	Tango de la Menegilda en La Gran Via	Vargas
12222	Olé Jota Española	Vargas

AND ANOTHER

FLAGSTAFF, Me., April 14, 1905.

Here is what a disc machine man recently said to me. He lately bought a disc machine. He came into my store to hear some of the Edison Gold Moulded Records and after hearing two or three said to the people assisting: "That machine is plainer than mine." He wanted to trade his for an Edison, even if he could only get half the price of his own, but I told him that I could not trade. I know I can sell him one as soon as he can dispose of his scratching machine.

JAMES PACKARD.

PRINTED MATTER.



Most Jobbers have ordered a supply of the above placard and will be glad to furnish one to their active Dealers. This placard is 14x22 inches in size and printed in blue ink on cardboard. It has been printed because of a demand for a plain show card giving the price of Edison Records. The card is Form No. 687. Dealers buying direct can have one sent with their next order by asking for it. It cannot be mailed.

With this issue of the PHONOGRAPH MONTHLY we are mailing a copy of a four-page folder, Form No. 675, printed to succeed Form No. 635, the edition of which is exhausted. This folder also shows the Gem, Standard, Home and Triumph machines and should be a useful bit of literature to mail to prospective customers. Dealers interested in using the folder may get a supply from their Jobbers, most of whom have already had a quantity shipped to them.

The phrase "Now Ready" has been added to the heading of the Record Bulletin for June with the idea of having it act as a notification to the public that the Records of the month are on sale.

Another of the colored hangers has just been mailed to the entire trade. It is Form No. 658, and shows a typical American boy playing a Home Phonograph. The caption "Never so Happy" is almost superfluous, for the boy's face fully expresses his pleasure. Jobbers may have an additional quantity sent with goods, although the edition makes it necessary to limit the size of orders.

AMONG THE JOBBERS.

P. A. Powers, Edison Jobber at Buffalo, has moved from 643 Main street to larger and much finer equipped quarters at 613 and 615 Main street.

The new Edison Jobbers for the month of May are W. C. De Forest & Son, of Newcastle and Sharon, Pa.; John Sykes, 105 N. Broad street, Trenton, N. J., and the Western Talking Machine Co., 938 Olive street, St. Louis, Mo. The latter concern has succeeded to the business formerly conducted by the Ray Company as a branch store.

George R. Youmans, Jobber at Waycross, Ga., occupies the unique position of being the only exclusively wholesale Jobber in the country. He does not sell at retail. There are, however, two good retail Dealers in Waycross, a town of 5,000 inhabitants, and they are doing an excellent business.

McGreal Bros., Jobbers at Milwaukee, have opened a retail branch store at 439 National avenue, South Milwaukee.

James K. O'Dea, Jobber at Paterson, N. J., has two unique signs as part of his window display. One is a picture of a Japanese girl, lettered as follows: "Uneda a Phonograph; Weneda a customer." The other sign shows a goat running an automobile, and is lettered as follows: "You 'auto' have a Phonograph; we 'auto' sell you one." These signs have attracted much attention.

The Eclipse Musical Co. have succeeded W. J. Roberts, Jr., as Edison Jobbers at Erie and Cleveland streets, Cleveland, Ohio.

R. S. Williams & Son's Co., Ltd., Edison Jobbers at Toronto, have opened a branch Jobbing house at Winnipeg, Manitoba.

"DADDY DEAR."

We take this opportunity of complimenting the National Phonograph Co. on the magnificent Record they made of our song, "Daddy Dear." It is fully admitted by all our customers and the trade, that this is one of the best Records ever shown to an appreciative public.—*Extract from a letter received from W. J. Deane & Son, Sydney, Australia, April*

POINTS FOR THE TRADE.

The following excellent letter was written by F. L. Fritchey, one of our Western salesmen, in response to a request from the editor of the PHONOGRAPH MONTHLY for some selling suggestions:

The arrangement of stock in a convenient manner, making the best possible display, is, I find, the best trade-getter of all—not excepting advertising. However, it certainly pays to advertise also. The Record shelving, or racks, that I have been introducing through my territory have brought lots of business to the dealers who have them. I built two of them to-day, one in Vincennes, Ind., and one in Princeton, Ind. [These racks will be made the subject of an article in the July issue.—*Editor.*]

In talking to a lukewarm Dealer, or a new Dealer, I show them where the *retail customer* can have nine and a half dozen of the Edison Records for the same price that he would have to pay for four dozen of the ten-inch disc records, and also where one Edison 35 cent Record will outwear five of the dollar disc records, or of the cheap cylinder record. No needles to change every reproduction, thus avoiding continual trouble and expense.

Retail buyers have found the Edison Phonograph to be the most economical, as well as the *only* pure *musical* tone talking machine. It permits him to have a wider variety, twice over and more, of Records for the amount invested. A Dealer's first sale to a customer is only a beginning of the profits—the following six or eight months bring a big future business, both from the purchaser and from his friends who hear his outfit and see the enthusiasm and pride with which he exhibits it to them. A great many of them in turn purchase outfits, thus starting an endless chain of profitable business.

An Edison outfit demonstrated in the home parlor, in contest with any other line, invariably ends in a sale of the Edison goods. This is owing to the agreeable, soft, lifelike tone of the Edison Records when reproduced by the Edison Reproducer. No other line has this tone.

The constant improvement in the Edison apparatus and in the purity of the tone in the Records; the up-to-date monthly lists of Records; the protection of prices afforded by the agreement; the exchange proposition policy which will be repeated at intervals; the elaborate display which can so cheaply be made of both Records and machines, with small stocks as well as large; the *fact* that Edison goods are the *only* line not found on bargain counters at cut prices and are not offered as prizes to induce the sale of other merchandise, or of newspapers; these facts all go toward making it the most desirable and sought-for line of talking machines.

Better workmanship, material, record quality, etc., because we have but one factory price and one retail price. Other concerns when they manufacture their lines of goods make them cheaply as possible because they don't know what their factory prices are to be

on the goods when sold (or consigned). An Edison Dealer who buys \$35 worth per month gets the same discounts and is accorded the same treatment as one whose account is \$350 per month. A new Dealer cannot do himself, or us, justice with less than the initial order as prescribed in agreement—cannot begin to make a creditable "trade-getter" display. The fact that a Dealer must buy full initial order, have a store and make suitable display of the goods at all times is a protection to him against the "pedler" who has no expense of store, etc., etc. The fact that we are making more Records each week than all other companies combined is pretty good evidence as to which line is the one in demand by the public.

MAKING RECORDS MAKES SALES.

"The hanger 'A Message From the Absent Lover' is quite a hit," writes H. W. Mosier, a Dealer at Stockton, Cal. "Being in a conspicuous place it never fails to attract, and we always make it our business to tell the story and then record the party's voice on the Phonograph. What is the result? The party is highly elated and brings his friends in to hear his voice and in turn we record his friends' voices. It does not take long in making a sale. Always depend upon me for hearty cooperation."

UNITED STATES LAW UPHELD.

On appeal to the High Court of Great Britain, the tribunal of last resort, the decisions of the Supreme Court of the United States relative to the sale of talking machines under restrictive conditions imposed by virtue of the patent was upheld. The decree was handed down about six weeks ago, the case involving the sale of Edison goods. The English court ruled that patentees may prescribe the price and lay down the terms of sale which their licensees shall charge and impose in selling to the general trade and patented articles covered by the patents under which the license is granted.

ELECTROS OF THE MONTHLY LIST.

J. H. Lepper, an Edison Dealer at Mason City, Ia., thinks that Dealers would appreciate it if we would furnish electrotypes of the monthly lists of new Records, for use in newspaper columns, at their cost, about 30 cents each. The list would have to be condensed to get it into a single column. If even a dozen Dealers wanted these we would have them made and mail them at 30 cents each. How many Dealers are interested?

NOTICE TO JOBBERS.

From letters received from various Jobbers, it is quite evident it was not thoroughly understood, that with the expiration of our exchange proposition, which terminated March 16, 1905, we discontinued allowing credit for or taking back in exchange, Records received in a broken or cracked condition. This is made plain by the fact that some Jobbers have returned such Records to us, all of which are being held subject to their order. It has, therefore, been decided that until further notified, this matter will be handled as follows:

BROKEN OR CRACKED RECORDS.—STANDARD SIZE ONLY.

Broken or cracked Records may be returned for credit by Jobbers to us, under the following conditions:

1st.—They must be absolutely new Records that were either broken or cracked when first unpacked, and must be returned in original cartons.

2d.—Return shipments must be made to the National Phonograph Company, Orange, New Jersey, transportation charges prepaid.

3d.—Jobbers must place with us, an order for four (4) times the quantity, at same time Records are returned.

4th.—Orders sent prior or subsequent to the return of Records cannot be applied, and unless new order is sent with the notice of return shipment of Records, those returned will **POSITIVELY** not be credited.

5th.—When return shipment is made, notice advising date and quantity returned, also bill-of-lading covering shipment, must be sent to the National Phonograph Company, 31 Union Square, New York City, and new order for four (4) times the quantity must also be enclosed.

6th.—The packing cases containing Records returned must be plainly marked with the name and address of the party returning them; and, as a further means of identification, each case must contain a packing slip showing by whom shipped and the number of Records packed in that particular case. This is imperative in order to determine who the Records are from and to whom credit should be rendered.

DEFECTIVE RECORDS.—STANDARD SIZE ONLY.

Defective Records, such as develop air holes, or some other defect which beyond question arises in manufacture are returnable for credit, provided an order for an equal number of new Records is sent us at the same time shipment is made.

Notice of return shipment and new order should be sent us in the same manner as with broken Records.

When defective Records are returned, they must be shipped in packages separate from broken or cracked Records, and the case containing same must be plainly marked with the name of the party returning them.

Broken, or cracked and defective Records must not be included in same package. If they are, we reserve the right to refuse to credit either one.

These propositions do not include surplus stock of Records, nor such Records as have been used or taken in exchange from consumers. If Records of this description are returned, credit for them will not be allowed. Concert Records cannot be returned under this proposition.

Jobbers may accept broken, cracked or defective Records from Dealers on the basis of the enclosed letter to Dealers, a copy of which is being mailed to every Dealer.

In offering these propositions, it is with the distinct understanding that they are subject to withdrawal or change at any time on five days written notice.

May 25, 1905.

C. H. WILSON,
Manager of Sales.

[Copy of a letter just mailed to all Jobbers.]

NOTICE TO DEALERS.

From letters received from various Dealers, it is quite evident it was not thoroughly understood, that with the expiration of our exchange proposition, which terminated March 16, 1905, we discontinued allowing credit for or taking back in exchange, Records received in a broken or cracked condition. This is made plain by the fact that some Dealers have returned such Records to us, all of which are being held subject to their order. It has, therefore, been decided that until further notified, this matter will be handled as follows:

BROKEN OR CRACKED RECORDS.—STANDARD SIZE ONLY.

Broken or cracked Records may be returned for credit by Dealers, under the following conditions:

1st.—They must be absolutely new Records that were either broken or cracked when first unpacked, and must be returned in original cartons.

2d.—Return shipments must be made as follows:

a.—If you are dealing through a Jobber they must be returned to such Jobber.

b.—If you are dealing through our Chicago office they must be returned to National Phonograph Company, 304 Wabash avenue, Chicago.

c.—If you are dealing with our New York office they must be returned to National Phonograph Company, Orange, N. J.

In every instance transportation charges must be prepaid.

3d.—Any Dealer returning broken or cracked Records must at the same time forward new order for four (4) times the quantity to whoever the Records are returned, viz, the Jobber, our Chicago office, or our New York office.

4th.—Orders sent prior or subsequent to the return of Records cannot be applied, and unless new order is sent with the notice of return shipment of Records, those returned will **POSITIVELY** not be credited.

5th.—When return shipment is made notice advising date and quantity returned, also bill-of-lading covering shipment, must be sent to the Jobber; or the National Phonograph Company, 304 Wabash avenue, Chicago; or the National Phonograph Company, 31 Union Square, New York City, as the case may be, and new order for four (4) times the quantity must also be enclosed.

6th.—The packing cases containing Records returned must be plainly marked with the name and address of the party returning them; and, as a further means of identification, each case must contain a packing slip showing by whom shipped and the number of Records packed in that particular case. This is imperative in order to determine who the Records are from and to whom credit should be rendered.

DEFECTIVE RECORDS.—STANDARD SIZE ONLY.

Defective Records, such as develop air holes, or some other defect which beyond question arises in manufacture, are returnable for credit, provided an order for an equal number of new Records is sent us at the same time shipment is made.

Notice of return shipment and new order should be sent us in the same manner as with broken Records.

When defective Records are returned, they must be shipped in packages separate from broken or cracked Records, and the case containing same must be plainly marked with the name of the party returning them; and, as a further means of identification, each case must contain a packing slip, showing by whom shipped and the number of Records packed in that particular case. This is imperative in order to determine who the Records are from and to whom credit should be rendered.

Broken, or cracked and defective Records must not be included in same package with defective Records. If they are, the right is reserved by Jobbers or ourselves to refuse to credit either one.

These propositions do not include surplus stock of Records, nor such Records as have been used or taken in exchange from consumers. If Records of this description are returned, credit for them will not be allowed. Concert Records cannot be returned under these propositions.

In offering these propositions, it is with the distinct understanding that they are subject to withdrawal or change at any time on five days written notice.

May 25, 1905. C. H. WILSON,
Manager of Sales.
 [Copy of a letter just mailed to all Dealers.]

EDISON GOLD MOULDED RECORDS FOR JULY, 1905.

Dealers in Edison Phonographs who pass by the twenty-four selections described in this issue, because summer is at hand and they think that trade is going to fall off in consequence, will regret it when they later learn of the unusually fine quality of the list. Seldom has one month's selections so strongly emphasized the almost phenomenal success of our recording department in making Records of a character vastly superior to anything of the kind on the market. The novelties of the month are Liszt's Second Hungarian Rhapsody, by the Edison Concert Band; Suppe's "Summer Night's Dream Overture" by the Edison Symphony Orchestra; a Rube sketch by "Cyrus Pippins;" a duet by Anthony and Harrison of Charles M. Alexander's famous "Glory Song;" a clarinet duet by Rubel and Tuson; and a Record by Tascott, the widely known vaudeville artist.

No. 9026, "Second Hungarian Rhapsody," by the Edison Concert Band, is one of the most ambitious pieces of recording that we have done in some time. This most popular of Liszt's well-known rhapsodies is a feature of the programmes of the finest musical organizations in the world. Our Record of it shows up the excellent balance of the Edison Concert Band. This Record will be a delight to those who are constantly seeking high-class music.

No. 9027, "To My First Love," by Irving Gillette, is one of Mr. Gillette's most careful renditions. This song was written by Hermann Löhr (music) and Edwin Hamilton (words). It is an encore number very popular with fine artists and their audiences.

No. 9028, "Come Along, Little Girl, Come Along," by Collins and Harlan, is another new summer waltz song that will be much sung and whistled between now and fall. It has a catchy air and is sung in a spirited manner. The music of the song was written by J. B. Mullen and the words by Alfred Bryan. The following chorus is an indication of the character of the song:

Come along, little girl, come along,
 Get you Sunday-go-to-meeting-clothes on,
 Come along, little girl, let us get in the whirl,
 They may all think they're it, but there's none like
 you, Pearl,
 Water's fine, baby mine, don't decline,
 Let us get in the swim good and fine,
 If you think you look cute in a nice bathing suit,
 Come along, little girl, come along.

No. 9029, "Summer Night's Dream Overture," by the Edison Symphony Orchestra, is a beautiful and perfectly recorded selection of

Suppe's delightful composition. No collection of Records of high-class music will be complete without this one.

No. 9030, "Courting Malinda," by "Cyrus Pippins," is a Rube dialect talking Record that is full of fun. It is made in genuine "Down East" dialect, accompanied by a laugh that is alone a feature of the Record. No better description of this selection can be given than to quote part of the Record as follows:

"I always have to laugh when I think of how I courted Malinda. I used to call around every evening and help her burn her father's coal-oil. Her folks told me to come as often as I liked; there was nothing valuable in the parlor.

"Malinda and me went out to a soda fountain place. I called for egg phosphate, she said she would take hers scrambled. Then we went to a theatre. We were sitting up in the gallery, when a fellow came out on the stage and rolled up a carpet. The boys hollered out 'Supe.' Malinda said, 'They hollered 'soup,' let's go down and get some.' I never was so blamed put out in my life. The head man put us both out just as soon as she said it. I took her home as quick as I could.

"I sailed right into the parlor and anchored right onto the sofa. The springs were all busted. The tarnation old craft was leaky. All of a sudden the whole tarnal thing went down with me in the middle. On the way down I met a pin coming up. Just then Malinda came in. She said, 'Cyrus, did you find a pin?' I said, 'Yes.' She said, 'Where have you got it?' I said, 'By Gosh, I won't tell you.' She said, 'I want it back.' I said, 'I'm glad you do, for that's where I got it.' She said, 'That pin's been in our family for years, and it pain's me to lose it.' I said, 'Well, it has just gotten into our family and it pains me to keep it.' Would you believe it when I got up off that sofa I had a new form of 'appindecitis.'"

No. 9031, "The Glory Song," by Anthony and Harrison, is at the present time the best known hymn in Great Britain. For several months past, Charles M. Alexander, of the Torrey-Alexander Mission, has been singing it at religious services throughout England. These services have been of the most popular character and have been largely attended. One of their features has been the singing of "The Glory Song" by Mr. Alexander. The popularity of the song in England has been so great that its fame has reached this country, and it promises to be equally popular here. Messrs. Anthony and Harrison have made a splendid Record of the song and the great sale that it will have will do much to make the song well known here. Those who buy the Record because of the fame of the song will be delighted with the song itself and with the manner in which Anthony and Harrison have sung it. The Record is made with an orchestra accompaniment in keeping with the character of the song.

No. 9032, "Flag of Victory March," by the Edison Military Band, is a composition by F. von Blon, and better known to musicians by its German title, "Unter dem Siegesbanner." As a composer Mr. von Blon has a style entirely his own. This is one of his best compositions. It is both musical and melodious.

No. 9033, "Shame on You!" by Tascott, introduces a new artist to Phonograph owners, although one widely known as a vaudeville artist. Mr. Tascott is featured in vaudeville programmes as "Tascott, the white coon." He is the originator of the "coon shout," and is inimitable in this particular line of work.

"Shame on You" was written by Chris Smith and John Larkins and has this chorus:

"Jasper Johnson! Shame on you!
You can't preach and rob me too!
You might fool me now and then,
But you don't buy fowl at two A. M.
I know what I'm talking about
And I wants the people here to find you out
So they can all stand up and shout 'Shame on you!'"

No. 9034, "Good Bye, Sweet Marie," by Harry MacDonough, is a new composition by Will D. Cobb, who also wrote "Good-Bye, Dolly Grey," and "Good-Bye, Little Girl, Good-Bye." The music is by Kerry Mills, composer of "Georgia Camp Meeting" and "Fare Thee Well, Molly Darling." It follows that the collaboration of two such well-known men has brought forth a sentimental ballad of unusual merit. This song has been called by many the greatest soldier song ever written. It is finely sung by Mr. MacDonough, and has an orchestra accompaniment.

No. 9035, "Two Little Bullfinches Polka," is a clarinet duet by Rubel and Tuson, and the first one ever made for the Edison Catalogue. The selection is of an entertaining character and exceptionally well rendered. Our orchestra furnishes a fine background to the soloists. This composition was written by H. Kling.

No. 9036, "Antony and Cleopatra," by Ada Jones and Len Spencer, is a talking and singing selection with orchestral incidental music and other descriptive effects. "Antony and Cleopatra" is a Shakespearean travesty. This style of humorous entertainment has been made popular by Ross and Fenton, the well-known vaudeville artists. Miss Jones and Mr. Spencer give a decidedly realistic rendition of the subject. It is entirely different from either of the two previously listed selections by these artists, and no collection of Records will be complete without it.

No. 9037, "Me an' de Minstrel Ban'," by Billy Murray, is a coon song by James Vaughan and Alexander Rogers. It sings of the darkey boy's admiration for the minstrel band and parade. A novel effect is the introduction of a regular minstrel band and parade of the minstrel troupe. Taken as a whole, the Record is quite different from other Records made by Mr. Murray.

No. 9038, "Alpine Violets," by Jaudas and Rose, with piano accompaniment, is a violin and flute duet. Something similar in character to previously listed duets by these artists and just as sweet and pretty. The steady progress of our Recording Department is evidenced in the tone and quality attained in this selection. Ludwig André is the composer.

No. 9039, "He Looks Just Like His Mother," by Byron G. Harlan, is a song by James Thornton that is full of human interest and written in the vein which Mr. Harlan has been so successful in interpreting. Mr. Thornton has written numerous successes, "When You Were Sweet Sixteen" being among the most noted. The song has this chorus:

"He looks just like his mother,
The same soft silky hair,
And when I look into his eyes,
I see her image there.

It seems as if she's watching,
Which causes me a tear,
He looks just like his mother dear
When she was living here."

No. 9040, "I Need Thee Every Hour," by MacDonough and Biehling, is a fine Record of this standard sacred selection and one that will always be in demand. The music of this hymn was written by Robert Lowry and the words by Anne S. Hawkes. It is sung with orchestra accompaniment and is an excellent addition to the Records previously made by these artists.

No. 9041, "American Fantasie," by the Edison Concert Band, is a composition by Victor Herbert that is too well known among those familiar with band music to need description. It is one of Mr. Herbert's best appreciated compositions. The music is patriotic in character.

No. 9042, "The Goose-Bone Man," by Arthur Collins, has been styled "a coon whine." The goose-bone man is a prophet. In this Record he prophesies everything down to "when to lay in your winter's coal." Mr. Collins makes much of the subject and introduces a storm scene prophesied by the goose-bone, which for fury gives the real thing cards and spades. Thomas S. Allen, who wrote this song, will be remembered as the writer of "Any Rags," and other hits.

No. 9043, "Sambo and Dinah," by Miss Nelson and Mr. Stanley, is a contralto and baritone duet with orchestra accompaniment of Cole and Johnson's well-known coon song. A very catchy and tuneful duet. Miss Nelson and Mr. Stanley give a finished rendition to the song, the orchestra contributing its full share. It is something on the order of "'Deed I Do" (our Record No. 8435) and ought to be equally popular.

No. 9044, "Down in Blossom Row Medley," by Albert Benzler, is a xylophone solo, with orchestra accompaniment, introducing "Down in Blossom Row" (our Record No. 9004), "Susan Van Doozen" (our Record No. 9012) and "On a Summer Night" (our Record No. 9021). Particular attention is called to the orchestral accompaniment, which is embellished to a high degree.

No. 9045, "Song of the Turnkey," by Frank C. Stanley, is a very fine Record of the well-known basso song from the comic opera "Rob Roy," written by Reginald De Koven. This is the first basso solo by Mr. Stanley in some time,—a line of work for which he is well fitted in both voice and style.

No. 9046, "Now What Do You Think of That?" by Bob Roberts, is a rollicking comic song written in six-eight tempo, particularly appropriate to the jingly lyrics. It has a catchy swinging tune. J. B. Mullen and Frank Fogerty are responsible for the music and words. The Record gives four verses and four choruses, the tropical character of which are shown by the first verse and chorus as follows:

"A fellow sat upon a bench, his sweetheart by his
side,
He asked her if she wouldn't like to be his little bride,

"Oh, don't get mushy," she replied, "it grates upon my ear,
Be nice, and I will always be a sister to you, dear."
CHO.—Now what d'ye think of that?
Now what d'ye think of that?
"I'll hang myself," he said, "if you refuse."
She said, "Don't do it on our ground
For pa don't want you hanging round."
So he went down a block.
Now what d'ye think of that?"

No. 9047, "Songs My Mammy Sang to Me," by Ada Jones, is a song that has been considerably used by Andrew Mack and J. W. Kelly, and is always very popular with their audiences. It has a charming, pathetic air. Miss Jones sings it in perhaps the most artistic manner of any Record that she has made for the Edison Phonograph. It is a Record that must be heard to be fully appreciated. It is made with orchestra accompaniment.

No. 9048, "I Wonder if You Miss Me," is another fine Record by the Edison Male Quartette. The Records by these artists increase in popularity every month. This new one will be quite as popular as those previously made. The first and second tenor sing the verse as a duet and then the quartette takes up the chorus. The singers are accompanied by the orchestra. This composition was written by Ted Snyder.

No. 9049, "Ev'ry Little Bit Helps Medley," by the Edison Military Band, introduces five popular songs previously listed: "Every Little Bit Helps" (our Record No. 9016), "You're My Heart's Desire, I Love You, Nellie Dean" (our Record No. 9013); "Paddy's Day" (our Record No. 9009), "Sweet Maid Divine" (our Record No. 9018) and "Hey! Mister Joshua" (our Record No. 9007).

160 NEW MEXICAN SELECTIONS.

Listed below are the remaining 160 of the 303 Mexican Records, the masters for which were made by our experts in Mexico more than a year ago. These titles will appear in the next editions of the Foreign and Numerical Record catalogues. They will also appear in a special catalogue of Mexican selections. This catalogue has been prepared especially for use in Mexico and Cuba, but a small additional supply has been printed for use in the States bordering on Mexico, which have a considerable Mexican population.

MUSICA INSTRUMENTAL

BANDAS MILITARES DE ESTADO MAYOR Y ZAPADORES DE MEXICO

AIRES NACIONALES.

18757	Primer Fragmento	} <i>(Arreglados por M. Rios Toledano)</i>	} Zapadores
18736	Segundo Fragmento		
18755	Tercer Fragmento		

DANZAS.

18575	Alcalá, dos danzas de	E. Mayor
18711	Esperanza y Margot, <i>(Josefina Serret)</i>	E. Mayor
18729	Estér, Esperanza é Irene, <i>(R. Vergara)</i>	Zapadores
18735	La Golondrina, <i>(Serradeli)</i>	Zapadores
18766	Julia, <i>(J. Segura)</i>	E. Mayor
18734	La Paloma, <i>(Iradier)</i>	Zapadores
18730	Tres Danzas de Viderrique	Zapadores

DANZONES YUCATECOS.

18791	"Azúl y Blanco" y "María Emilia"	E. Mayor
18767	"María" y "Leonorcita" <i>(J. Cuevas)</i>	E. Mayor

MARCHAS.

18618	Bernardo Reyes, <i>(Mercado)</i>	E. Mayor
18611	Colegio Militar, <i>(V. M. Presa)</i>	Zapadores
18794	Emblema de la Paz, <i>(R. Pacheco)</i>	Zapadores
18702	En La Campaña, <i>(A. Martinez)</i>	Zapadores
18703	Gran Marcha Porfirio Diaz, <i>(J. Austri)</i>	Zapadores
18795	Porfirio Diaz, <i>(Codina)</i>	Zapadores
18621	Zacatecas, <i>(G. Codina)</i>	E. Mayor
18565	El Zapador, <i>(Toledano)</i>	Zapadores

MAZURKAS.

18762	Selajes de Oro, <i>(M. G. Manzanares)</i>	E. Mayor
18758	Felicidad, <i>(J. Marinez)</i>	Zapadores
18759	Hada de Rosas, <i>(J. Chico)</i>	Zapadores
18761	Horas Felices, <i>(A. Garcia)</i>	E. Mayor

PASOS DOBLES.

18700	A los Toros, <i>(Juarranz)</i>	Zapadores
18738	La Giralda, <i>(Juarranz)</i>	E. Mayor
18740	Mazzantini, <i>(Juarranz)</i>	E. Mayor
18760	Minuto, <i>(Jordá)</i>	Zapadores
18790	El Progreso, <i>(J. Garcia)</i>	E. Mayor
18708	Puerto Real, <i>(Juarranz)</i>	Zapadores
18705	Quiebro y Requiebro, <i>(Gascón)</i>	fla-
	menco	Zapadores
18619	San Juan Hill, <i>(J. B. Fuentes)</i>	E. Mayor

POLKAS.

18765	Entre Jazmines, <i>(F. J. Navarro)</i>	E. Mayor
18739	Ojos Azules, <i>(V. M. Dell'Oro)</i>	E. Mayor
18704	Olímpica, <i>(C. Rivas)</i>	Zapadores
18710	Los Parranderos, <i>(E. Navarro)</i>	E. Mayor

SCHOTTISCH.

18733	Elvira, <i>(M. G. Manzanares)</i>	Zapadores
18574	En Alas de la Brisa, <i>(Aranda)</i>	E. Mayor
18707	Estér, <i>(Romo Vergara)</i>	Zapadores
18737	Sin Esperanza,	E. Mayor

VALSES.

18792	Los Insectos, <i>(Berruecos)</i>	E. Mayor
18620	Laurita, <i>(N. Vasquez)</i>	E. Mayor
18731	Noche Apacible, <i>(A. Martinez)</i>	Zapadores
18566	Onda Cristalina, <i>(A. Martinez)</i>	Zapadores
18742	Peonia, <i>(J. Balart)</i>	E. Mayor
18743	Souvenir de Chopin	E. Mayor
18613	Tus Ojos, <i>(E. Correa)</i>	Zapadores
18756	Tuyo Hasta la Muerte, <i>(M. D. Vargas)</i>	Zapadores

MISCELANEA.

18763	Danza Húngara No. 5, <i>(J. Brahms)</i>	E. Mayor
18764	Danza Húngara No. 6, <i>(J. Brahms)</i>	E. Mayor
18706	Hasta Otra Vista, galopa humorística, <i>(Gonzalez)</i>	Zapadores
18732	Moralba, intermezzo, <i>(E. Rosales)</i>	Zapadores
18741	Mosamala, baile peruano	E. Mayor
18582	Seguidillas de la zarzuela "El Chaleco Blanco", <i>(Caballero)</i>	E. Mayor
18754	Tarantella, <i>(J. Martinez)</i>	Zapadores
18712	Zamacueca de la zarzuela "Los Sobrinos del Capitán Grant", <i>(Caballero)</i>	E. Mayor

TRIO ARRIAGA

	Mandolinas con acompañamiento de guitarra	
18770	Angélica, danza, <i>(E. Ascorve)</i>	
18772	Bolero de la zarzuela "La Cuarta Plana", <i>(C. Curti)</i>	
18771	Guerrita, vals-jota, <i>(A. Coto)</i>	
18768	Hamburgo, mazurka, <i>(Granado)</i>	
18769	Jota de la ópera "La Dolores", <i>(Bretón)</i>	
18749	La Linda Cubana, danzón, <i>(A. Perez Rivas)</i>	
18746	Moraima, capricho español, <i>(E. de los Monteros)</i>	

SEÑORES ARRIAGA Y OSCURA

	Bandurria con acompañamiento de guitarra	
18748	A Media Noche, danza <i>(J. Aviles)</i>	

SEÑOR JOAQUIN J. ARRIAGA

18745	Schottisch para mandolina, <i>(C. Curti)</i>	
	Solos de mandolina	
18744	Souvenir de Haydn, <i>(Leonard)</i>	

ORQUESTA TIPICA LERDO

18587	Amada, vals, <i>(Lerdo de Tejada)</i>	
-------	---------------------------------------	--

QUINTEO JORDA

18782	A Fior di Labra, mazurka, <i>(Arditi)</i>	
-------	---	--

- 18780 El Amor es la Vida, danza, (*Ettonart*)
 18783 Caprichosas, danza núm. 2, (*Elorduy*)
 18777 Célebre Mandolinata, pizzicato, (*Desormes*)
 18773 Danzas Tropicales, núm. 1, (*Elorduy*)
 18774 Danzas Tropicales, núm. 2, (*Elorduy*)
 18775 Danzas Tropicales, núm. 3, (*Elorduy*)
 18776 La Doroles, paso doble, (*Bretón*)
 18779 En Sourdine, serenata, (*H. Tellam*)
 18781 Monte Cristo, vals, (*Kotlar*)
 18784 Nuages Roses, vals, (*Bergier*)
 18778 Vals Poético, (*Villanueva*)

MUSICA VOCAL

CANCIONES POPULARES MEXICANAS

SEÑORES ABREGO Y PICAZO
acompañamiento de guitarra

- 18728 Acuérdate de Mí
 18722 ¡Amigo, Amigo!
 18675 El Borrachito de Manzanares
 18724 Consejos de una Vieja
 18726 Coplas de Don Simón
 18797 Pleito en un Fonógrafo, pieza imitativa
 18725 Posadas en una Casa de Vecindad, pieza imitativa
 18674 El Ranchero de Tajimaroa
 18727 La Trigueñita
 18723 Un Paseo en Santa Anita, pieza imitativa
 18796 El Zenzontle

SEÑOR R. HERRERA ROBINSON
acompañamiento de guitarra

- 18506 A María la del Cielo, invocación
 18535 Los Amores de un Charro, danza tapatía
 18526 Carmen Carmela, danza
 18713 Los Consejos de un Viejo, danza
 18714 Danza del Pollo Inglés
 18750 El Desprecio, corrido de tierra caliente
 18524 Las Horas de Luto, danza
 18523 Horas Negras ó Penas del Alma, danza
 18507 El Huérfano
 18516 La Inundación de León, corrido
 18517 María (oye la voz)
 18529 Me Gustan tus Ojos, danza
 18538 Morir Soñando, vals
 18525 El Pajarillo, Errante, danza
 18509 Suspiros de los Angeles
 18520 Suspiros y Rosas, schottisch
 18527 Un Recuerdo á mi Madre

SEÑORES HERRERA ROBINSON Y PICAZO
acompañamiento de guitarra

- 12637 El Canto del Cisne, danza
 18638 Macario Romero, corrido

Sr. HERRERA ROBINSON Y Sra. ZAMUDIO
acompañamiento de guitarra

- 18715 En Alas de los Vientos
 18751 Glores del Pasado
 18717 Juramentos, vals
 18716 La Morena, danza

SEÑOR FELIPE LLERA
acompañamiento de guitarra

- 18689 El Amigo
 18686 Las Comadres
 18684 Los Cuicos
 18687 Las Hilachas
 18685 Las Ilusiones
 18688 Pachita la del Puente
 18690 La Reja

SEÑORA MODESTA ZAMUDIO
acompañamiento de guitarra

- 18718 La Carcajada de Cupido

CANCIONES POPULARES ESPANOLAS

SEÑOR JOSE MARIA PALMA
acompañamiento de guitarra

- 18681 Guajiras Españolas
 18679 Jota Rabalera
 18682 Tango Cádiz
 18680 Tango de los Tientos
 18683 Malagueña

DANZAS, ROMANZAS L MELODIAS

COROS

acompañamiento de piano

- 18698 Himno Nacional Mexicano, (*J. Nunó*) coro mixto

SEÑORITA BEATRIZ FRANCO, (*Mezzo-soprano.*)
acompañamiento de orquesta

- 18557 El Paje (*Jordá*) vals

SEÑOR FELIPE LLERA, (*Barítono*)

acompañamiento de piano

- 18692 El Camello, danza
 18691 Soñar Contigo, danza

SELECCIONES DE OPERA Y ZARZUELA

acompañamiento de orquesta

AGUA, AZUCARILLOS Y AGUARDIENTE. (*F. Chueca*)

- 18695 Cuarteto. (*piano*) Cuarteto Mixto
 BOCCACCIO. (*Suppé*)

- 18660 Duo—La Niña Florentina.

Herrera y Bereaud

EL CABO PRIMERO. (*Caballero*)

- 18543 Romanza.

Goyzueta

CAMPANONE. (*Mazza*)

- 18545 Rondó.

Goyzueta

CHIN-CHUN-CHAN. (*L. G. Jordá*)

- 18694 Danza.

Rosete y Coro

LOS COCINEROS. (*Valverde y Torregrosa*)

- 18560 Duo del Pelele.

Franco y Llera

LA ENSEÑANZA LIBRE. (*G. Jimenez*)

- 18649 Tango del Morongo.

Herrera, Sedano y Bereaud

- 18668 Terceto de las Ligas.

Herrera, Bereaud y Rosete

GIGANTES Y CABEZUDOS. (*Caballero*)

- 18642 Romanza.

Goyzueta

LAS HIJAS DE EVA. (*Gastambide*)

- 18803 Romanza.

Franco

JUGAR CON FUEGO. (*Barbieri*)

- 18643 Romanza.

Goyzueta

LA MASCOTA. (*Audrán*)

- 18561 Duo de Los Pavos.

Franco y Llera

PICIO, ADAN Y COMPANIA. (*Mangiagalli*)

- 18669 Coplas.

Rosete

EL REY QUE RABIO. (*Chapí*)

- 18693 Coro de Los Doctores.

Coro

- 18541 Romanza.

Goyzueta

EL TAMBOR DE GRANADEROS. (*Chapí*)

- 18662 Coplas del Tambor.

Herrera

VIVA MI NINA. (*Rubio*)

- 18556 Habanera.

Franco

MUSICA RELIGIOSA

ORFEONES

- 18800 O Santissima (*J. Mohr*)
 18801 Salve Regina, canto gregoriano
 18798 Tantum Ergo (*J. Mohr*)

RECITACIONES

Composiciones del célebre Poeta Mexicano

JUAN DE DIOS PEZA

Recitadas por el mismo

- 18788 El Fonógrafo
 18786 Fragmento de la poesia "Reir Llorando"
 18789 Mi Padre
 18785 Los Niños Héroes de Chapultepec
 18802 No Puede Decirse, melopeya
 18787 Tres poesias del libro "Hojas de Margarita"

PIEZAS IMITATIVAS

CORRIDAS DE TOROS

- 18752 Gran Corrida de Toros en la plaza "Mexico" por las Cuadrillas de Machaquito y Montes.
 18753 Gran Corrida de Toros en la plaza de Durango por la Cuadrilla de Arcadio Ramirez (a) Reverte Mexicano.

TAPADAS DE GALLOS

- 18721 Gran Tapada de Gallos en la Ciudad de Aguascalientes.
 18720 Gran Tapada de Gallos en la Ciudad de León.
 18719 Gran Tapada de Gallos en la Ciudad de México.

QUICK WORK.

ALRANY, N. Y., May 1, 1905.

Opened my new store Saturday to fine business. Sold out stock of Edison Phonographs before 8 p. m., including Triumphs, Homes and Standards.

W. J. KILLEA,

103 South Pearl street.

THE PHONOGRAM.

Dealers desiring to get a supply of *Phonograms* to mail to their customers must order them of Jobbers four weeks in advance, and we cannot agree to fill Jobbers' orders unless placed with us a similar period in advance. We plan to print about 10,000 more than we have orders for when we go to press, five weeks in advance of the month of issue, but frequently these are soon used up with extra orders.

Following is a schedule of prices at which *Phonograms* may be obtained by the trade:

Blank, per 100 copies.....\$.25

Imprinting, 25 cents additional for *each imprint*, without regard to quantity. On this basis 500 copies cost \$1.50 and 1,000 copies cost \$2.75.

No orders filled for less than 500 copies requiring imprint, and all imprinting orders must be for multiples of 500.

Most Jobbers will be glad to supply Dealers on the above basis.

BY MAIL.

Single copies, per year.....\$.20

Five copies to one address, per year..... .40

Twenty-five copies to one address, per year..... 1.80

Fifty copies to one address, per year.... 3.60

Unless they have open accounts on our books, Dealers ordering *Phonograms* sent by mail are requested to send cash or stamps with their orders. The amounts are too small to handle in any other way.

IN CUBA ALSO.

A representative of our Foreign Department now traveling in Cuba and Porto Rico, recently wrote concerning an incident of his travels as follows:

Our customer in one of the interior towns has a ——— machine, which he won in a raffle, and he wanted some friends to judge as to the merits of the two machines. So we arranged to have a little concert at his store in the evening. The disc machine and the Standard Phonograph were placed several feet apart on the counter, both facing the door, and pieces were played on each alternately. Among his friends was a gentleman who desired to purchase a machine, but was undecided as to which he preferred. After playing the machines quite a while, during which a large crowd had congregated in front of the store, reaching almost to the middle of the street, several pieces were played successively on the disc machine, when some one in the crowd outside said: "Now play some on the other machine," this demand being seconded by a little shaver who had secured a position of advantage by climbing a nearby lamp-post, who said: "Yes, that's ours—the one that says 'Etheeson.'" Both the crowd outside and those within the store had a laugh at the little fellow's expense, but the encore given the Record

played in obedience to his wish, as well as the fact that the party who was undecided ordered a Standard Phonograph, which was added to our customer's initial order, showed the little fellow's opinion to be about the same as that of the other's present."

FOR TUNING PHONOGRAPH RECORDS.

W. H. Miller, manager of the Recording Department of the National Phonograph Co., has been granted a patent for a method of tuning Phonograph Records, described as follows:

In making talking machine records for sale it is important that the masters from which duplicates are obtained should be secured at a standard surface speed, which at the present time with Edison Records is about one hundred and sixty-four revolutions per minute. In this way when the reproducing machine is properly adjusted musical selections can be reproduced in the exact key in which the original music was played in order that the best effects may be secured. If there is a relatively small difference in the surface speed of the masters, a perceptible variation in the key of the reproduction is observed, and to secure the best effect therefor a separate adjustment of the reproducing machine would be required for each selection. Consequently it is commercially important that the masters should be obtained at the same surface speed, and it is therefore necessary that some effective way should be suggested by which the tuning of any Phonograph or other talking machines can be readily effected, whether for the taking of the masters or for the reproduction of the complete record.

The present invention presents a method of this character which has been successfully used in practice for some time.

In carrying the invention into effect take a standard talking machine, for example, and adjust its regulating mechanism so that its mandrel will turn at the desired speed. This adjustment may be effected by timing the mandrel shaft in the usual way, and by carefully adjusting the regulating mechanism until the desired speed is obtained. Now place on this standard machine as so regulated an ordinary blank and record thereon a certain selected sustained note—for instance, B flat—which may be produced by a simple reed or in any other way. This note as so recorded is preferably sustained at a continuous volume and for a considerable time, and may occupy substantially the entire record in the record at any point to sound the standard note. The record so formed constitutes a key by which the tuning of other talking machines can be effected, and, if desired, it may be duplicated in any suitable way to obtain a large number of copies. When a talking machine has to be tuned, whether for recording or reproducing, one of the key records or duplicates thereof is placed on the Phonograph and a reproducer engaged therewith, so as to sound a single continuous note. A reed keyed to the same pitch—for example, B flat—is now sounded, and the adjusting mechanism of the machine is so regulated as to bring the note sounded by the

talking machine in exact equality with the note sounded by the reed. When these two notes are exactly the same, the speed of the talking machine will correspond exactly to the standard speed of the original machine. This tuning can be effected with great accuracy, owing to the delicacy of the ear, and with great rapidity. Prior to this invention the tuning of talking machines was effected by counting the revolutions of the mandrel; but such an operation was tedious and relatively uncertain.

COLLINS AND HARLAN AT MILWAUKEE.

In its report of the Merchants and Manufacturers Exposition at Milwaukee, the *Music Trades* said:

One of the most interesting features of the exposition is the making of Phonograph Records, in connection with the exhibit of the McGreal Bros., agents for the Edison line. It is an unusual opportunity to see two men whose voices have been made familiar through the medium of the Phonograph, while the men themselves were in New York, and were the original producers of the darkey laugh and negro dialect. Consequently, a large crowd surrounded Arthur Collins and Byron G. Harlan, who, with heads close together, sang into the mouth of an octagonal horn, and then stood by while the Records were placed in a Phonograph and reproduced. Both are men of splendid physique and strong voices, and their work is a practical demonstration of the statement that the Phonograph "listens as well as talks." Mr. Harlan and Mr. Collins are both employed in the Edison laboratory of New York, and are two of the most successful makers of Phonograph Records in the country. Their duets and solos are reproduced through-

out the country, Mr. Harlan having a tenor voice and Mr. Collins a baritone.

Mr. Collins, when asked how many Records he and Mr. Harlan had made, replied: "Millions of them. I have been in the business eight years and Mr. Harlan has been at it five or six. There are not many people who make a success of it, owing to the fact that it requires an iron throat, powerful lungs and a peculiar singing voice. Then, care must be given to the most minute details and every word has to be pronounced distinctly, with every vowel and consonant accurately enunciated.

"Naturally, the work which we do here is crude. In New York we have an orchestra assisting and no Record is sent out unless it is absolutely perfect. A mispronounced word or a blast throws the Record out."

THE OLD STORY.

Under date of May 13, the H. M. Holleman Co., Jobbers at Houston, Tex., wrote:

"Sometime ago you sent us address of H—S—, Houston, Tex. We communicated with him, and also sent representative to interview him, but without success. He purchased a ——— outfit for \$45. Yesterday we played a Home in competition with his machine, rendering some of the same selections he had purchased with his disc machine, with the result that he made us a proposition to exchange. We finally traded him a \$55 Edison outfit, allowing him \$20 for his machine. As a rule, we do not care to trade, and this is our first acceptance of a disc machine, but we were very anxious to take up this sale, inasmuch as the disc dealer had not given us a fair deal in landing the first sale."



STORE OF I. F. EASTMAN, LEWISTON, ME.

The above illustration shows part of the store of I. F. Eastman, Edison Dealer, at Lewiston, Me. The rack shown in this pic-

ture contains every Edison Record in the domestic list.

JOBBER'S OF EDISON PHONOGRAPHS AND RECORDS.

ALABAMA.

Birmingham—Talking Machine Co., 2007 Second ave.
Mobile—W. H. Reynolds, 167 Dauphin street.
Montgomery—R. L. Penick, 119 Dexter ave.

CALIFORNIA.

San Francisco—Peter Bacigalupi, 786-788 Mission street.

COLORADO.

Denver—Denver Dry Goods Co., 619 16th street.

CONNECTICUT.

Middletown—Caulkins & Post Co., 406-408 Main street.
New Haven—Pardee-Ehlenberger Co., 155 Orange st.

DISTRICT OF COLUMBIA.

Washington—E. F. Droop & Sons Co., 925 Pennsylvania avenue, N. W.
 S. Kann Sons & Co., 8th and Pennsylvania avenues.

GEORGIA.

Atlanta—Atlanta Phonograph Co., 49 Peachtree St.
Waycross—George R. Youmans.

ILLINOIS.

Chicago—James I. Lyons, 73 Fifth avenue.
 Siegel, Cooper & Co., 281 State street.
 Talking Machine Co., 107 Madison street.
 The Vim Co., 68 E. Lake street.
 Montgomery Ward & Co., 111 Michigan ave.
 Rudolph Wurlitzer Co., 302 Wabash ave.
Peoria—Peoria Phonograph Co., 222 Bridge street.
Quincy—Quincy Phonograph Co., 808 Hampshire st.

INDIANA.

Indianapolis—Craig-Jay Co., 234 Massachusetts ave.
 Kipp Bros. Co., 37 S. Meridian street.
 A. B. Wahl & Co., 119 S. Illinois street.
Lafayette—A. B. Wahl & Co., 304 Main street.

IOWA.

Des Moines—Hopkins Bros. Co., 620 Locust street.
 Vim Co., 704 West Walnut street.
Fort Dodge—Early Music House, 822 Central ave.

KENTUCKY.

Louisville—C. A. Ray, 640 Fourth street.

LOUISIANA.

New Orleans—William Bailey, 600 Frenchman street.
 National Automatic Fire Alarm Co.,
 614 Gravier street.

MAINE.

Bangor—S. L. Crosby Co., 186 Exchange street.
Portland—W. H. Ross & Son, 207 Commercial street.

MASSACHUSETTS.

Boston—Boston Cycle & Sundry Co., 48 Hanover street.
 Eastern Talking Mach. Co., 177 Tremont st.
 Iver Johnson Sptg. Goods Co., 163 Washington street.
 C. E. Osgood Co., 744 Washington street.
 Read & Read, 558 Washington street.
Fitchburg—Iver Johnson Sptg. Goods Co., 247 Main st.
Lowell—Thomas Wardell, 111 Central street.
New Bedford—Household Furnishing Co., 170 Purchase street.
Springfield—Flint & Brickett Co., 439 Main st.
Worcester—Iver Johnson Sptg. Goods Co., 304 Main st.

MICHIGAN.

Detroit—American Phono. Co., 106 Woodward ave.
 Grinnell Bros. 219 Woodward ave.
Saginaw—Morley Bros.

MINNESOTA.

Minneapolis—Thomas C. Hough, 714 Hennepin ave.
St. Paul—W. J. Dyer & Bro., 21-23 West 5th street.
 Thomas C. Hough, 392 Wabasha street.
 Minnesota Phonograph Co., 37 E. 7th street.

MISSOURI.

Kansas City—J. W. Jenkins' Sons Music Co., 1013-1015 Walnut street.
 J. F. Schmelzer & Sons Arms Co., 710 Main street.
St. Louis—Conroy Co., 1115 Olive street.
 O. K. Houck Piano Co., 1118 Olive street.
 *Western Talking Machine Co., 923 Olive st.

NEBRASKA.

Lincoln—H. E. Sidles Cycle Co., 1317 O street.
Omaha—Nebraska Cycle Co., 15th and Harney streets.
 Omaha Bicycle Co., 16th & Chicago sts.

NEW JERSEY.

Hoboken—Eclipse Phono. Co., 205 Washington st.
Newark—A. O. Petit, New and Halsey streets.
Paterson—James K. O'Dea, 117 Ellison street.
Trenton—Stoll Blank Book and Stationery Co., 30 E. State street.
 *John Sykes, 105 N. Broad street.

NEW YORK.

Albany—Finch & Hahn, 92 State street.
Brooklyn—Chapman & Co., Fulton and Duffield streets.
 A. D. Matthews' Sons, 394 Fulton street.
 Price Phonograph Co., 1258 Broadway.
Buffalo—P. A. Powers, 613 Main street.
Elmira—Elmira Arms Co., 117 Main street.
Gloversville—American Phono. Co., 99 W. Fulton st.
Kingston—Forsyth & Davis, 307 Wall street.
New York City—Bettini Phono. Co., 156 W. 23d street.
 Blackman Talking Machine Co., 97 Chambers street.
 J. F. Blackman & Son, 2737 3d avenue.
 I. Davega, Jr., 802 Third avenue.
 S. B. Davega, 32 E. 14th street.
 Douglas Phono. Co., 89 Chambers st.
 H. S. Gordon, 139 Fifth avenue.
 Harry Jackson, 219 Bowery.
 Jacot Music Box Co., 39 Union Square.
 Victor H. Rapke, 1661 Second avenue.
 Siegel-Cooper Co.
 John Wanamaker.
 Alfred Weiss, 1525 First avenue.
Oswego—Frank E. Bolway, 32 Bridge street.
Poughkeepsie—Price Phonograph Co., 203 Main st.
Rochester—A. J. Deninger, 345 North street.
 Mackie Piano, O. & M. Co., 100 State street.
 Giles B. Miller, 63 State street.
 Talking Machine Co., 97 Main st., E.
Schenectady—Finch & Hahn, 456 State street.
 Jay A. Rickard & Co., 253 State street.
Syracuse—W. D. Andrews, 216 E. Railroad street.
Troy—Finch & Hahn, 7 Third street.
Utica—Clark-Horrocks Co., 54 Genesee street.
 Arthur F. Ferriss, 89 Washington street.
 William Harrison, 41 Columbia street.
 Utica Cycle Co., 31 Columbia street.

OHIO.

Canton—Klein & Heffelman Co., 216 N. Market street.
Cincinnati—Ilsen & Co., 25 W. 6th street.
 Rudolph Wurlitzer Co., 10-12 W. 4th st.
Cleveland—Eclipse Musical Co., Jr., Erie and Huron sts.
Columbus—Perry B. Whitsit Co., 213 S. High street.
Dayton—Niehaus & Dohse, 35 E. 5th street.
East Liverpool—Smith & Phillips Music Co.
Newark—Hoover-Ball Co., Inc.
Toledo—Hayes Music Co., 608 Cherry street.

PENNSYLVANIA.

Allegheny—Henry Braun, 500 Federal street.
Allentown—G. C. Aschbach, 539 Hamilton street.
Easton—William Werner, 401 Northampton street.
Harrisburg—S. K. Hamburger, 12-14 N. Market sq.
 *New Castle—DeForeest & Son.
Philadelphia—C. J. Heppe & Son, 1117 Chestnut street.
 Lit Bros., Market and 8th streets.
 Penn Phonograph Co., 17 S. 9th street.
 John Wanamaker, 13th and Market sts.
 Wells Phonograph Co., 41 N. 9th street.
 Western Talking Mach. Co., 25 S. 9th st.
 H. A. Weymann & Son, 923 Market st.
Pittsburg—Theo. F. Bentel Co., Inc., 632 Liberty street.
 Kaufmann Bros., Fifth avenue.
 H. Kleber & Bro., 221 Fifth avenue.
 C. C. Mellor Co., 319 Fifth avenue.
 Pittsburg Phono. Co., 937 Liberty street.
Reading—Reading Phonograph Co., 809 Penn street.
Scranton—Ackerman & Co., 130 Wyoming avenue.
 Technical Supply Co.
 *Sharon—W. C. DeForeest & Son

RHODE ISLAND.

Pawtucket—Pawtucket Furniture Co., 39 N. Main St.
Providence—J. M. Dean Co., 785-795 Westminster street.
 J. A. Foster Co., Weybosset st.
 Household Furniture Co.
 J. Samuels & Bro., 154 Weybosset street.
 A. T. Scattergood & Co., 106 N. Main st.

TENNESSEE.

Knoxville—Knoxville Typewriter and Phonograph Co., 311 Clinch street.
Memphis—O. K. Houck Piano Co., 359 Main street.
 F. M. Atwood, Lyceum Building.
Nashville—Nashville Talking Mach. Co., 510 Church st.
 Magruder & Co., 13 Arcade.

JOBBER'S OF EDISON PHONOGRAPHS AND RECORDS—Continued.

TEXAS.

Dallas—Southern Talking Machine Co., 347 Main st.
 Fort Worth—Cummings, Shepherd & Co., 700 Houston st.
 Houston—H. M. Holleman Co., 612 Fannin street.

VIRGINIA.

Richmond—Magruder & Co., 729 E. Main st.

WISCONSIN.

Milwaukee—McGreal Bros., 173 3d street.

CANADA.

Toronto—R. S. Williams & Sons Co., Limited,
 123 Yonge street.
 Winnipeg—R. S. Williams & Sons Co., Ltd., 121 Princess street.

* Added since May 1, 1905.

SUSPENDED LIST, JUNE 1, 1905.

SUPERSEDING ALL PREVIOUS LISTS.

ILLINOIS.

Ottawa—Edward Hayne.
 Wheaton—E. Irving.

INDIANA.

South Bend—EUGENE MARSH, 126 Vistula avenue.
 SOUTH BEND BOOK BINDERY, Robert
 Lebolt, Prop., 203 North Michigan street.

IOWA.

Burlington—JOHN P. WEISS, 711 Jefferson street.
 Sioux City—HATTENBACH BROS. CO.

KANSAS.

Clay Centre—E. M. GOWENLOCK.
 Lawrence—BELL BROS.

MAINE.

Biddeford—W. H. FIELD.
 Monmouth—G. H. STETSON.

MASSACHUSETTS.

Boston—T. SINGER, 60 Leverett street.
 Lawrence—LORD & CO., 314 Essex street.
 E. O. MOSHER, 420 Essex street.
 Lynn—ELIAS DEYOUNG.
 Malden—A. T. FULLER.
 Nantucket—ARTHUR M. TAYLOR.
 New Bedford—H. B. DEWOLFF.
 Somerville—E. J. WINCHESTER, 32 Summit avenue.
 Woburn—OSBORN GILLETTE, or THE BOLTON
 JEWELRY CO., L. F. Maloney, Manager.

MICHIGAN.

Detroit—F. J. SCHWANKOVSKY.
 Saginaw—GEO. W. EMENDORFER.
 JAMES V. CALAHAN, 217 Genessee st.
 TIERNEY BROS., 217 Genessee st.

MISSOURI.

Kansas City—THE WITTMANN CO.

NEBRASKA.

Lincoln—THE WITTMANN CO.
 Omaha—THE WITTMANN CO.

NEW HAMPSHIRE.

Hillsboro Bridge—E. M. BARNES.
 Manchester—A. E. DUMAS
 Nashua—F. A. MCMASTER & CO.

NEW JERSEY.

Atlantic City—SAM'L D. WOLF, 32-34 Arkansas ave.
 Bayonne—I. WIGDOR, 450 Avenue D.
 Jersey City—W. L. HOFFMAN, 151 Montgomery st.
 Newark—R. L. CORWIN; also New York City.
 Passaic—I. HURWITZ.
 Paterson—CHAS. H. KELLY, 25 N. Main street.

Plainfield—S. W. FRUCHT, or R. FRUCHT; also
 New York City.

ELSTON M. LEONARD.

West Hoboken—EMIL HOLLANDER, or THE WEST
 HOBOKEN BICYCLE & PHONO. CO., 619
 Spring street.

NEW YORK.

Albany—G. LINDE, 353 S. Pearl street.
 Bedford Park—GEO. H. TYRRELL.
 Hobart—F. H. MARSHALL.
 New York City—A. T. ARMSTRONG, or AMERI-
 CAN PHONO. CO., 106 Wall street.
 *AUTOMATIC ZITHER CO., M. Cohen, Prop.,
 58 Second avenue.
 BERN BEARWALD, 373 W. 11th st.
 BRONX PHONO. CO. or DAVID SWITKY,
 506 Willis ave.
 CENTRAL PHONO. CO., 160 E. 42d street.
 R. L. CORWIN; also Newark, N. J.
 EAGLE PHONO. CO., or C. LOWENTHAL,
 83 Nassau street.
 EMPIRE PHONO. CO., 2 W. 14th street.
 S. W. FRUCHT, or R. FRUCHT, 7 Barclay st.,
 or 68 Cortlandt st.; also Plainfield, N. J.
 O. HACKER, 2 Murray street.
 HAWTHORNE & SHEBLE, 297 Broadway;
 also Philadelphia, Pa.
 HOLOBER BROS., 350, 421 and 491 West st.
 N. HORN, 148 E. 58th street.
 W. L. ISAACS, 114 Fulton street.
 S. LEMBURG & CO., 194 Broadway.
 J. MCELLYNNE, 202 Broadway.
 RICHMOND PEASE, 44 W. 132d st.
 F. M. PRESCOTT, 44 Broad st.
 WINTHROP CYCLE CO., 2212 Seventh ave.

Rome—CHARLES TUTTLE.

Saratoga—W. J. TOTTEN.

Saratoga Springs—MARVIN A. COTE.

OHIO.

Cincinnati—J. L. ANDEM.
 Coshocton—BURNS & GOSSER.
 Springfield—D. & M. VANDERPOOL.
 Uhrichsville—F. A. MAZURIE.

PENNSYLVANIA.

Philadelphia—A. R. CASSIDY, 2783 Emerald street.
 HAWTHORNE & SHEBLE, 604 Chestnut st., or
 Oxford and Mascher sts.; also New York City.
 A. KROUSE, 832 Arch street.
 PENN NOVELTY CO., 15 South 9th st

Phoenixville—KEINARD BROS.

Pittsburg—A. LIPPARD, 615 Wylie ave.

RHODE ISLAND.

Providence—F. P. MOORE.

WISCONSIN.

Milwaukee—J. C. BLATZEK.

*Added Since May 1, 1905.

Jobbers and Dealers are asked not to supply any of the above named firms with our apparatus, either at addresses given or any other address.

DOUBLE SERVICE



June
1905

S	M	T	W	T	F	S
				1	2	3
4	5	6	7	8	9	10
11	12	13	14	15	16	17
18	19	20	21	22	23	24
25	26	27	28	29	30	

LANGUAGE STUDY AMUSEMENT

The Edison Trade are the only merchants allowed to sell I. C. S. Language Outfits. Send \$2.00 for Agent's Demonstrating Outfit including sample moulded records in French, German, Spanish, and English, and instructions for representing "Double Service." *Write today!* Address:

LANGUAGE DEPARTMENT
INTERNATIONAL CORRESPONDENCE SCHOOLS
SCRANTON, PA.

FOR FOREIGN SALES. ADDRESS { Foreign Dept., National Phonograph Co., 31 Union Square, New York City.
 European Headquarters, National Phonograph Co., Ltd., 25 Clerkenwell Road, London, E. C.

EDISON Phonograph Monthly

PUBLISHED FOR TRADE USE ONLY BY
THE NATIONAL PHONOGRAPH CO.

VOL. III.

ORANGE, N. J., JULY, 1905.

No. 5.

NATIONAL PHONOGRAPH CO.

ORANGE, N. J.

NEW YORK: 31 UNION SQUARE.

CHICAGO: 304 WABASH AVENUE.

SAN FRANCISCO: 786 MISSION STREET.

NATIONAL PHONOGRAPH CO., LTD., 25 CLERKENWELL
ROAD, LONDON, ENG.

EDISON PHONOGRAPHS AND RECORDS.

All communications to THE PHONOGRAPH MONTHLY
should be addressed to the Advertising Department,
Orange, N. J.

C O N T E N T S

A Banner July	1
Advance List August Records	2
Advance List Swedish Records	3
Return Proposition to be Withdrawn.....	4
Record Shipping Memorandum	4
Twenty-five Swedish Records	4
Electros of Monthly List	4
No. 8274 also Cut Out	4
To Again Assure the Trade	5
Begins Its Second Year	5
Records Made Over Under New Conditions	6
Printed Matter	7
Among the Jobbers	7
Comments on August Records	8
Won over All Competitors	10
Mr. Collins not a Negro	10
Who Did It?	10
Sold Without Trying	11
Export Business	11
A Good Letter	11
Success of the O. K. Houck Piano Co....	12
New Electrotypes for Trade Use	13
Jobbers of Edison Phonographs and Records	14
Suspended List July 1, 1905	15

A BANNER JULY.

From all sides come reports of the biggest business in Edison Phonographs and Records ever known at this season of the year. The trade everywhere states that the demand for Edison goods has continued brisk, the advent of hot weather having nothing like its usual effect upon business. Dealers who usually set aside their Phonograph and Record trade in summer and devote their time to pushing goods of an out-door character, such as bicycles, sporting goods, etc., write that the demand for Phonographs and Records has been so constant they have not found it necessary or desirable to give so much attention to other lines. Orders received at our factory bear out these reports of Jobbers and Dealers. It would be idle to assert that orders are as heavy as in cooler weather, for they are not, but the falling off is nothing like that of past years, at the same season. The present volume would have been considered large business at the busiest period two years ago. The advance orders for July Records were ninety per cent. of the June orders, and the latter month has only been exceeded twice since the Phonograph was invented. The quality of the August list will do much to insure a heavy demand and the advance orders will probably equal those for July. Every selection on the list is good, and even if their patrons are away on vacations just now or will be later, no Dealer can afford to be without his usual stock of new Records. Just as soon as his people get back they will certainly want a lot of them.

It is a little early to place orders for fall goods, but it is not too early to think over the general situation and decide just how you intend pushing the business when cooler weather comes. It is just as well, too, to remember that those who place their fall orders early get better service than those who put it off later, when everybody wants goods.

THE ADVANCE LIST OF JULY RECORDS APPEARS ON PAGE 2.

NEW EDISON GOLD MOULDED RECORDS. ADVANCE LIST FOR AUGUST, 1905.

RECORDS listed below will be ready for shipment as near **August 1st** as possible, at which time Jobbers' stock orders, if **received prior to July 10th**, will be shipped. August Supplements will be forwarded to Jobbers with their stock order for Records. Retail Dealers should place stock orders with their Jobbers at once, to insure prompt shipment as soon as Jobbers' stock is received.

- | | | |
|------|--|---------------------------|
| 9050 | Oberon Overture (<i>Weber</i>) | Edison Concert Band |
| 9051 | Mariar (<i>Gumble</i>) <i>A Farmer's Serenade—Song with Orch. accom.</i> | Miss Clarice Vance |
| 9052 | The Rosary (<i>Nevin</i>) <i>Male Quintette, unaccompanied</i> | Knickerbocker Quintette |
| 9053 | Jim Bludsoe (<i>Hay</i>)
<i>Recitation of Secretary John Hay's descriptive poem.</i> | Edgar L. Davenport |
| 9054 | Dearie (<i>Kummer</i>)
<i>Sentimental song, with Orch. accom., from Frank Daniels' musical farce "Sergeant Brue."</i> | Harry MacDonough |
| 9055 | Take a Car (<i>Rose and Snyder</i>) <i>Comic male duet, Orch. accom.</i> | Collins and Harlan |
| 9056 | Bewitching Beauty—Caprice (<i>Heed</i>) | Edison Symphony Orchestra |
| 9057 | Who's There? (<i>Brown</i>) <i>Coon song, Orch. accom.</i> | Arthur Collins |
| 9058 | Saved by Grace (<i>Stebbins</i>) <i>Sacred male duet, Orch. accom.</i> | MacDonough and Biehling |
| 9059 | Cleopatra Finnegan (<i>Moret</i>) <i>An Afro-Celtic Intermezzo</i> | Edison Military Band |
| 9060 | Keep a Little Cosey Corner in Your Heart for Me (<i>Morse</i>)
<i>Sentimental song, Orch. accom.</i> | Miss Ada Jones |
| 9061 | Violette (<i>Mullen</i>)
<i>Soldier song, male duet with Orch. accom., introducing Miss Daisy Boulais as "Violette."</i> | Harlan and Stanley |
| 9062 | Peter Piper (<i>Henry</i>) <i>Xylophone solo, Orch. accom</i> | Albert Benzler |
| 9063 | My Irish Molly O (<i>Schwartz</i>)
<i>Song hit from Frank Daniels' musical farce "Sergeant Brue," Orch. accom.</i> | Billy Murray |
| 9064 | Louis and Lena at Luna Park
<i>A Coney Island scene with all the incidental effects.</i> | Ada Jones and Len Spencer |
| 9065 | Pearl of California (<i>Christie</i>) <i>Bell solo, Orch. accom.</i> | Albert Benzler |
| 9066 | Just Across the Bridge of Gold (<i>Von Tilzer</i>)
<i>Descriptive song, Orch. accom.</i> | Byron G. Harlan |
| 9067 | Every Dollar Carries Trouble of Its Own (<i>Leighton</i>)
<i>Coon song, Orch. accom.</i> | Bob Roberts |
| 9068 | Presentation March (<i>Doring</i>) | Edison Military Band |
| 9069 | In the Evening by the Moonlight (<i>Bland</i>)
<i>Male Quartette, Orch. accom.</i> | Edison Male Quartette |
| 9070 | Would You Care (<i>Harris</i>)
<i>Chas. K. Harris' new love ballad, Orch. accom.</i> | Irving Gillette |
| 9071 | Message of the Old Church Bell (<i>Leighton</i>)
<i>Descriptive song, Orch. accom.</i> | Harry Anthony |
| 9072 | Mississippi Minstrels
<i>Introducing the End Men Billy Murray and Len Spencer and "There's a Light in the Window," with Orch. accom., sung by Harry MacDonough.</i> | Minstrels |
| 9073 | Now What D'ye Think of That Medley
<i>Introducing "Now What D'ye Think of That," "Sambo and Dinak," "Good-bye Sweet Marie" and "Shame on You."</i> | Edison Military Band |

Edison Gold Moulded Records are made only in Standard Size. Both Standard and Concert Records may be ordered from this list. Order by number, not title. If Concert Records are wanted, give the number and letter C.

SPECIAL ADVANCE LIST. EDISON GOLD MOULDED RECORDS. SWEDISH SELECTIONS.

THESE twenty-five Swedish selections will be ready for shipment about **July 15th.** All orders received prior to that date will be shipped at the one time. A limited edition of Supplements, Form No. 713, has been printed of these Records and will be supplied in small quantities to Jobbers ordering Swedish Records.

18828	Finska Rytteriets Marsch	Edison militär-musikkår
18829	Mandom mod	Arvid Asplund
	<i>Tenorsång med orkesterackompanjemang från Orsa i Dalarne</i>	
18830	Här är gudagodt att vara (<i>Wernerberg</i>)	Asplund och Arveschoug
	<i>Tenor och baritonduett med orkesterackompanjemang.</i>	
18831	Fågeln visa (<i>Süderberg</i>)	Sopransång med orkesterackompanjemang Magda E. Dahl
18832	Sångaren på Vandring (<i>Naumann</i>)	Arvid Asplund
	<i>Tenorsång med orkesterackompanjemang</i>	
18833	Drick ur ditt glas (<i>Bellman</i>)	Tenorsång med orkesterackompanjemang Arvid Asplund
18834	Björneborgarnes Marsch	Edison militär-musikkår
18835	Se Movitz, hvi står du och gråter (<i>Bellman</i>)	Arvid Asplund
	<i>Tenorsång med orkesterackompanjemang</i>	
18836	Portervisan fran Martha (<i>Flotow</i>)	Albert Arveschoug
	<i>Baritonsång med orkesterackompanjemang</i>	
18837	Längtan (<i>Genser</i>)	Tenorsång med orkesterackompanjemang Arvid Asplund
18838	Du är min ro (<i>Collan</i>)	Tenorsång med orkesterackompanjemang Arvid Asplund
18839	Rhenvinets lof (<i>Peters</i>)	Tenorsång med orkesterackompanjemang Arvid Asplund
18840	Polka öfver Svenska Folkmelodier	Edison militär-musikkår
18841	Fåfång Onskan (<i>Collan</i>)	Tenorsång med orkesterackompanjemang Arvid Asplund
18842	Nattmarschen i St. Eriks gränd	Asplund och Arveschoug
	<i>Tenor och baritonduett med orkesterackompanjemang</i>	
18843	Soldatgossen (<i>Patsius</i>)	Tenorsång med orkesterackompanjemang Arvid Asplund
18844	Du gamla, du friska	Tenorsång med orkesterackompanjemang Arvid Asplund
18845	Trubadurens Dödssång (<i>Fogelberg</i>)	Arvid Asplund
	<i>Tenorsång med orkesterackompanjemang</i>	
18846	Svenska Kungssången (<i>Lindad</i>)	Edison militär-musikkår
18847	Spinn Spinn	Tenorsång med orkesterackompanjemang Arvid Asplund
18848	Bland fjellen (<i>Heland</i>)	Baritonsång med orkesterackompanjemang Albert Arveschoug
18849	Som i ungdomens år (<i>Durand</i>)	Arvid Asplund
	<i>Tenorsång med orkesterackompanjemang</i>	
18850	Wermlands-Polska	Tenorsång med orkesterackompanjemang Arvid Asplund
18851	Rose-Marie (<i>Collan</i>)	Tenorsång med orkesterackompanjemang Arvid Asplund
8641	Swedish Garde Marsch	Edison militär-musikkår

Edison Gold Moulded Records are made only in Standard Size. Both Standard and Concert Records may be ordered from this list. Order by number, not title. If Concert Records are wanted, give the number and letter C.

RETURN PROPOSITION TO BE WITHDRAWN JULY 5th, 1905.

The following letter has just been mailed to the entire trade in the United States:

NOTICE TO DEALERS.

New York, June 27, 1905.

We hereby notify you that on July 5th, 1905, the offer contained in our letter of May 25th, Form 702, relating to RETURN OF BROKEN, CRACKED OR DEFECTIVE Records will be withdrawn. After that date WE WILL NOT TAKE BACK, OR ACCEPT FOR CREDIT OR EXCHANGE, RECORDS OF ANY DESCRIPTION WHATEVER, unless it be such as are mechanically defective; and, they must not be returned until you have first written us advising the quantity to be returned, also the nature of the defects, and obtained our permission to return them.

Yours very truly,

C. H. WILSON,
Manager of Sales.

In explanation of this action we would say that it has been found necessary because of the unwillingness of the trade to comply with the provisions laid down in our letter of May 25th for the control and regulation of the matter. A return proposition is always troublesome to handle satisfactorily, and without the coöperation of all parties it is impossible. We had hoped that the plan would be a material benefit to the trade and regret that circumstances make its repeal necessary.

RECORD SHIPPING MEMORANDUM.

With every shipment of Records now made from our factory is included a memorandum, showing what numbers and how many of each make up the shipment. The advantage of this plan is apparent to every consignee. If he keeps a list of Records on order with the factory he has but to check his shipping memorandum against this list to know just what Records are due him, should his order have been shipped short.

MEDIOCRITY NO LONGER SATISFIES.

One of the encouraging signs of the times is the popular demand for good entertainment. We use the term good comprehensively. The mediocrity that has sometimes prevailed no longer satisfies. Take for instance the rapid improvement that has been made in the Edison Phonograph. Instruments can now be had as low as ten or fifteen dollars that outclass for parlor or porch amusement anything known a few years ago for ten times the price. The Gold Moulded Records can now be procured for the astounding low price of 35c. each. They reproduce all the beauties of the voice or orchestra, for which opera houses charge prices almost forbidding, if you wish to hear the same pieces rendered by the artists themselves.—*National Magazine for July*

25 SWEDISH RECORDS.

On page 3 of this issue are listed 25 Edison Gold Moulded Records of Swedish songs and Swedish instrumental music. There are 18 solos, 2 duets and 5 band selections. During the past two years we have had many requests from all parts of the country for a list of Swedish selections. Our Recording Department has been continually searching for artists of the right ability to make such a list of Records, and the opportunity came recently, when they secured Magda E. Dahl, soprano, Arvid Asplund, tenor, and Albert Arveschoug, baritone, all Swedish singers of the first rank. The instrumental selections were made by the Edison Military Band, especial care being taken to play them in the characteristic Swedish style. All of the singers were accompanied by the Edison Symphony Orchestra. The trade may offer these Records to their Swedish patrons with the assurance that they are made by splendid talent and with the usual care of our Recording Department. Shipments of Jobbers' orders will be made about July 15th. Dealers having Swedish patrons should place advance orders with their Jobbers.

Jobbers will be supplied upon request with a limited number of special supplements of these Records, which will be shipped with the Records. The edition being printed is one-tenth the edition of regular supplements and Jobbers should order in about the same proportion.

ELECTROS OF MONTHLY LIST.

A number of Jobbers and Dealers asked us to get out electros of the monthly list of Edison Records as suggested by J. H. Lepper last month, and we have had a quantity made. One will be mailed to any Dealer upon receipt of thirty cents in stamps. Those having open accounts need not remit. These electros will be made each month as long as the trade desire them.

NO. 8274 ALSO CUT FROM CATALOGUE.

Through an oversight Record No. 8274, "L'Enfante March," banjo solo by Van Epps, was not included in the list of cut out selections issued February 17, 1905, Form No. 663. It has been dropped from all catalogues and the trade is asked to accept this paragraph as a notice of the fact.

While on your summer vacation, Mr. Dealer, make up your mind to stock up early for fall business.

TO AGAIN ASSURE THE TRADE.

The following letter and copy of the stay of injunction in the case of the New York Phonograph Co. against the National Phonograph Co. have just been mailed to the trade in the United States. They explain themselves.

THE LETTER.

Orange, N. J., June 9, 1905.

Dear Sir:—

We have had our attention called to a notice which the New York Phonograph Company has sent to Jobbers and Dealers in the State of New York in reference to the suit brought by them to enjoin this company from dealing in Phonographs and supplies in that State. The notice in question has also been disseminated by other companies claiming similar rights in other localities.

The order for the injunction referred to in said notice was stayed by an order of the court, filed simultaneously with the injunction order, as appears from the copy which follows. An appeal having been taken from the decision of the lower court, *the stay is continued and all other proceedings are suspended*, pending final disposition of the case by the Circuit Court of Appeals. If the Court of Appeals should finally hold that the New York Company is entitled to an accounting, that will be a matter for the National Company to settle, and Jobbers and Dealers throughout the State of New York and elsewhere cannot be held accountable to the New York Company, or any other parties claiming similar rights, for the obvious reason that damages cannot be exacted twice for the same cause of action. So far as concerns other companies outside the State of New York claiming similar rights, it is sufficient to say that no suit has progressed beyond the mere formality of filing the usual bill of complaint. In any event, we repeat the assurance which we have always cheerfully given, that we stand back of our Jobbers and Dealers to the fullest extent, and that we hold ourselves ready to defend, at our expense, any action which may be brought against them for violation of any patent, or similar rights, in connection with our goods, and to pay any damages which may be assessed therein, provided that in the event of such a suit, the matter be immediately turned over to us, to be handled by our own attorney.

Yours very truly,

NATIONAL PHONOGRAPH COMPANY,
W. E. GILMORE, *President.*

THE STAY.

In the Circuit Court of the United States for the Southern District of New York, held in the court room in the Post Office Building in the County of New York, on the second day of May, 1905.

Present: Honorable John R. Hazel,

U. S. Judge.

New York Phonograph Co., Complainant,

vs.

Thomas A. Edison, Edison Phonograph Company, Edison Phonograph Works, and the National Phonograph Company, Defendants.

Order Staying injunction.

A decree for an injunction in favor of the

complainant, New York Phonograph Company, and against defendant, National Phonograph Company, in the above entitled suit in equity having been made and filed herewith, it is

Ordered, Adjudged and Decreed that the said injunction against the said defendant, National Phonograph Company, be and the same hereby is stayed till the first day of July, 1905; that if on or before the said first day of July, 1905, said defendant, National Phonograph Company, shall have perfected an appeal to the United States Circuit Court of Appeals for the Second Circuit, from said decree for an injunction and shall on or before that date have filed a bond in the office of the clerk of this court in an amount, and with surety approved by the complainant's counsel or fixed and approved by this court, *said bond to be conditioned upon the payment to complainant by defendant, National Phonograph Company, in case the said decree shall be affirmed by the said United States Circuit Court of Appeals of all profits which shall be made by or which accrue to said defendant, National Phonograph Company, and of all damages which shall be sustained by complainant, New York Phonograph Company, by reason of this stay of the said injunction, then this stay is continued till the first day of the next term of said United States Circuit Court of Appeals; that if then said appeal is docketed and noticed for hearing by defendant, National Phonograph Company, as a preferred cause, this stay is continued till the hearing, decision and mandate of said United States Circuit Court of Appeals.*

It is further ordered that the bond *hereinbefore referred to be in the amount of \$10,000.*

JOHN R. HAZEL,

U. S. J.

BEGINS ITS SECOND YEAR.

With the July issue the *New Phonogram* begins its second year. Notwithstanding its diminutive size, its first year has been most successful. The edition of the first issue in July, 1904, was 90,000 copies. The edition has increased every month, 230,000 copies being printed for July, 1905. We believe that the *Phonogram* has been an important factor in the remarkable increase of the demand for Edison Phonographs and Records in the past year. Its three principal features—the descriptions of new Records, its “Questions and Answers” department and the pictures of the artists who make Edison Records—have caused it to be eagerly sought by the public. These features will be continued without change through at least another volume.

Dealers who have put in the entire list of Edison Records, (domestic selections) report that it has been a profitable move. It is worth the consideration of every enterprising Edison Dealer.

RECORDS MADE OVER UNDER NEW CONDITIONS.

The new edition of the catalogue of domestic selections will show that since the issuance of the April edition, Form No. 670, a considerable number of titles have been made over under new conditions. The old moulds of these selections were either worn out or were not up to the standard. The new moulds have been made in the most up-to-date manner by our Recording Department, and Records made from them will be found equal to any made for the Monthly Supplement. Some of the new moulds are already in use and after July 15th all orders for these numbers will be filled under the new conditions. The new Record Catalogue will show the changes but the attention of the public will not be specially called to them. This will give the trade time to dispose of the stock they have on hand. This announcement will only appear in the PHONOGRAPH MONTHLY. The trade will do well to carry an increased stock of these selections and point out to their customers that they are equal to those shown on the Monthly Supplement.

BAND SELECTIONS.

Made over by the Edison Military Band instead of the Edison Concert Band.

- 63 Russian Hymn.
- 92 Star Spangled Banner.
- 142 Soldiers in the Park March.
- 7323 Dare Devil March.
- 8054 Our Director March.
- 8117 Bismarck March.

BANJO SOLOS.

Made over by same talent and orchestra accompaniment.

- 2608 Darkey Tickle.
- 2610 El Capitan March.
- 2616 Hot Stuff Patrol.
- 2623 Narcissus.
- 2635 Yankee Doodle.
- 7955 Bay State Quickstep.
- 8143 Overture to William Tell.

Made over by Van Epps instead of Brooks and with orchestra accompaniment.

- 2605 Darkies Dream.
- 2617 In Old Madrid.
- 2632 Stars and Stripes Forever March.

BUGLE CALLS.

Made over by John Hazel instead of A. L. Sweet.

- 8057 U. S. Cavalry Calls.
- 8144 Infantry Calls.

CLARINET SOLOS.

Made over by same talent but with orchestra accompaniment.

- 7253 Pol6naise Brilliant.

CORNET SOLOS.

Made over by same talent but with orchestra accompaniment.

- 8362 Therese Polka.
- 8418 Sing, Smile, Slumber.
- 8482 National Fantasia.

FIELD MUSIC.

Made over by U. S. Marine F. and D. Corps instead of N. G. N. J. Field Music.

- 8058 Forbes' Farewell.

PIANO SOLO.

Made over by Albert Benzler instead of Frank P. Banta.

- 8394 Violets.

WHISTLING SOLOS.

Made over by same talent but with orchestra accompaniment.

- 7334 Bobolink.
- 7335 Anvil Chorus.
- 7596 Independentia March.
- 7597 Over the Waves Waltz.
- 7682 Whip-Poor-Will Song.
- 8612 American Flag March.

XYLOPHONE SOLOS.

Made over by Albert Benzler instead of J. F. Hopkins.

- 8047 Messenger Boy March.
- 8335 Turkish Patrol.

SONGS.

Made over under new conditions.

- 1523 Little Alabama Coon.
By Miss Ada Jones instead of Collins and with Orchestra accompaniment.
- 4909 Warrior Bold.
By Harrison instead of Hooley.
- 4914 Heart Bowed Down.
By Harrison instead of Hooley.
- 5710 Because.
By Anthony instead of Campbell.
- 6948 Way to Kiss a Girl.
By Collins instead of Quinn, and with Orchestra accompaniment.
- 7001 All Hail the Power of Jesus' Name.
By Harrison instead of Fisher.
- 7007 In Old Madrid.
By Harrison instead of Fisher.
- 7014 What a Friend We Have in Jesus.
By Harrison instead of Fisher.
- 7118 Just as the Sun Went Down.
By Harrison instead of Fisher.
- 7163 Gypsy Love Song.
By Harrison instead of Hooley.
- 7327 Schubert's Serenade.
By Harrison instead of Hooley.
- 7484 Old Black Joe.
By Collins and Harlan instead of Collins.
- 7665 Negro Recollections.
By Collins and Harlan instead of Collins.
- 7839 Bedouin Love Song.
By John H. Duffy instead of Myers.
- 7871 I've a Longing in My Heart for You, Louise.
By Anthony instead of Natus.
- 8010 The Bridge.
By John H. Duffy instead of Myers and with Orchestra accompaniment.
- 8014 Down Where the Blue Bells Grow.
By Miss Susanne Baker instead of Miss Roberts and with Orchestra accompaniment.
- 8118 In the Good Old Summer Time.
By Murray instead of Redmond and with Orchestra accompaniment.
- 8517 Down on the Farm.
By Anthony instead of Wallace and with Orchestra accompaniment.
- 8680 In the Days of Old.
By Roberts instead of MacDonough.

Made over by same talent but with orchestra accompaniment.

- 1559 Where is My Wandering Boy To-Night.
- 4005 Laughing Coon.
- 4004 Laughing Song.
- 4023 Sauerkraut is Bully.
- 4030 Snyder Does Your Mother.
- 4031 Alpine Specialty.
- 4032 Doctor Eisenbein.
- 4035 Original Lauterbach.
- 8149 Forgotten Word.
- 8150 I Got Married This Morning.
- 8165 Stay in Your Own Backyard.
- 8193 Please Let Me Sleep.
- 8270 Santa Claus Song.
- 8365 Then I'd Be Satisfied With Life.
- 8381 Beer That Made Milwaukee Famous.
- 8438 Sweet Rose.

TRIO.

Made over by the Edison Trio instead of the Metropolitan Mixed Trio.

- 8503 Praise. Ye.

MALE QUARTETTES.

Made over by same talent but with orchestra accompaniment.

- 2222 I'se Gwine Back to Dixie.
- 7551 Mandy Lee.

DUETS.

Made over by same talent but with orchestra accompaniment.

- 7382 While the Leaves Came Drifting Down.
- 7475 Where the Sweet Magnolias Bloom.
- 7540 Baby's Prayer.
- 7997 Whoa Bill!
- 8198 Fare Thee Well, Molly Darling.
- 8203 Watching and Waiting.
- 8294 Tell Me.
- 8373 Larboard Watch.
- 8338 When the Autumn Leaves Are Falling.
- 8435 'Deed I Do.
- 8468 There's a Mother Always Waiting You at Home, Sweet Home.
- 8475 Parody on Hiawatha.

Made over under new conditions.

- 8008 McManus and the Parrot.
By Collins and Harlan instead of Collins and Natus, and with Orchestra accompaniment.

DUO-LOGUES.

Made over by Spencer and Holt instead of Spencer and Girard.

- 8034 Daybreak at Calamity Farm.
- 8061 Bouncer at the Blazing Rag.
- 8077 Auction Sale of a Bird and Animal Store.

IRISH WITTICISMS.

Made over by John Kaiser instead of James H. White.

- 8069 Casey at the Telephone.
- 8075 Casey Taking the Census.
- 8103 Casey Courting His Girl.
- 8360 Casey and His Gang of Irish Laborers.

PRINTED MATTER.

In addition to the usual number of Record supplements for July we are sending every Jobber an equal quantity of a circular referring to the July list and intended for general distribution in channels not covered by the supplements. The edition of these circulars is a million, and we hope that by July 10th they will be in a million homes in the United States, silently asking their readers who own Phonographs to hear the July list and offering an argument to non-owners why they should join the vast army who find in the Phonograph their greatest source of entertainment. A copy of this circular has just been mailed to all Dealers. Jobbers are asked to distribute the supply sent them where they will do the most good, giving their Dealers a proper share. Getting out these circulars is something of an experiment, and if they prove the assistance to the trade that we anticipate a similar one will be printed for August.

The lithographed steel sign, showing the portrait of Mr. Edison, has been received by the trade with many expressions of pleasure and numerous complimentary letters have been written concerning it.

The July Record Bulletin appears with a new design at the head, printed in black and red. The words "Now Ready" are the most striking features of the head and are intended to notify the passerby that the Records for the month are on sale.

After many delays we can now definitely promise that the new numerical catalogue,

Form 700, will be mailed to the trade within the next two weeks. This will include every Edison Record now catalogued to and including July and also including the complete Mexican list and the Swedish list printed in this issue. From it will be omitted all cut out selections. We may now explain that the principal reason for deferring the issuance of this catalogue was to get in it the entire Mexican list and the Swedish list, both of which have been in preparation for some time.

AMONG THE JOBBERS.

For the third time in three years the Price Phonograph Company, Brooklyn, has been obliged to move its Broadway store to larger quarters. The new store at 1260 Broadway, one door above the present store at 1258 Broadway, is fifty feet longer than the old store and will be the largest store of its kind in the city. There will be eight private Record testing rooms fitted up in the most luxurious manner with electric lights and fans, besides a large general testing room. Other arrangements include a private office where the details of business may be transacted quietly; a large display and stock room where at least fifty machines and over 100 different styles of horns of every description are kept constantly on hand. In the wholesale department 50,000 Edison Gold Moulded Records will be kept. This is the sixth store the Price Company has fitted up and is the finest of the lot. Their other stores are at 5318 Third avenue; 600 Grand street, Brooklyn, and 203 Main street, Poughkeepsie, N. Y. Mr. Price recently sold his sporting goods store in Jamaica to the J. B. Cooper Phonograph Co.

The H. M. Holleman Co., Houston, Texas, has been succeeded by the Texas Phonograph Co.

E. F. Droop & Sons Co., Washington, D. C., has opened a branch jobbing agency at 109 North Charles street, Baltimore.

The Conroy Company, of St. Louis, Mo., has changed the style of its name to the Conroy Piano Co.

TALKING EDISON ALL THE TIME.

SELMA, N. C., June 3, 1905.

You can at all times rest assured that your product will be well pushed and your interest carefully guarded in my hands. I have tried them all; I am yet holding on to the Edison, and talking Edison all the time. What reason would I have not to do so? Again promising you my local support, and that I will thoroughly keep your goods before the public,

ROBERT E. SNIPES.

COMMENTS ON EDISON GOLD MOULDED RECORDS FOR AUGUST, 1905.

A notable feature of the August list is the fact that it introduces some very clever talent to the many thousands of Phonograph owners. The statement that Miss Clarice Vance has been induced to sing some of her song hits for the Phonograph will delight all patrons of the leading vaudeville houses. Her first presentation is "Mariar," in which she has scored a great success. The Knickerbocker Quintette will be heard with great pleasure. Their singing of "The Rosary," in which they make their initial appearance, is delightful. Edgar L. Davenport, whose first Edison Record is given in the August list, is well known from Maine to California as a comedy actor of the first rank. His work in "The College Widow" during the past season will be recalled with pleasure by all who saw that jolly comedy. Much more might be said of the ability of all of this new Edison talent than we have space to give to it. For quality and variety the August list has never been excelled.

No. 9050, "Oberon Overture," by the Edison Concert Band, is a selection of the better class of music and a composition found on all first-class musical programmes. It was written by Weber. The Edison Concert Band has transferred the composition to our Record in an unusually fine manner.

No. 9051, "Mariar," by Miss Clarice Vance, introduces to the Phonograph public a new singer in the person of Miss Vance, who is one of the most widely known artistes in vaudeville. She is a top line feature in all vaudeville theatres, and is one of their most popular performers. Her work is always finished and never boisterous. While this Record is not as loud as many others, we feel sure that it will find many admirers. The Record shows Miss Vance in one of her big successes, and the song is given in her characteristic style. "Mariar" is a farmer's serenade. The music is by Mose Gumble and the words by Harry Williams. The Record is made with orchestra accompaniment.

No. 9052, "The Rosary," is made by the Knickerbocker Quintette, a new organization. This is its first Edison Record. It is probably the only time that a quintette Record has been made of Nevin's beautiful song "The Rosary." The Knickerbocker Quintette is known throughout the realm of vaudeville as the "Original Spook Minstrels." It is composed of: Parvin Witte, first tenor; Charles H. Bates, second tenor; G. de V. O'Hara, first baritone; Wallace C. White, second baritone; Leon Parmet, basso. The singing of this Quintette is quite different from the work of the ordinary groups of singers. It is of a character that will be found very pleasing. The music of "The Rosary" was written by Ethelbert Nevin, and the words by Robert Cameron Rogers.

No. 9053 "Jim Bludsoe" is by Edgar L. Davenport, another late addition to the talent making Edison Records. His first Record will show to the Phonograph public that he is a most valuable acquisition. "Jim Bludsoe" is a descriptive Mississippi poem written by the Hon. John Hay, Secretary of State. It is rendered by Mr. Davenport in a manner that shows he is a finished elocutionist. It has been many months since we put out a Record of this character, and we believe that the public will agree with us that we have been most fortunate in securing the service of Mr. Davenport to make it. Mr. Davenport is an actor of wide repute, having played leading parts in many plays during the past few years. His last appearance in the "legitimate" was in the "College Widow." During the summer season he is playing in vaudeville. He opened at the Empire Theatre, Boston, on May 29th, and has since been a prominent feature of the best vaudeville houses.

No. 9054, "Dearie," by Harry MacDonough, is one of the most popular numbers in Frank Daniels' musical farce, "Sergeant Brue," in which it is sung by Miss Sallie Fisher. It is a ballad of the sentimental order and is successfully sung by Mr. MacDonough with orchestra accompaniment. "Dearie" is the work of Clare Kummer.

No. 9055, "Take a Car," by Collins and Harlan, is a comic waltz song suitable to the summer season. It is sung in the usual clever manner of Messrs. Collins and Harlan, and introduces various characteristic effects which must be heard to be appreciated. This song was produced by Rose and Snyder. It is sung with orchestra accompaniment.

No. 9056, "Bewitching Beauty," by the Edison Symphony Orchestra, is a new composition by J. C. Heed. It is a light summery number, melodious, and with catchy light figures for all the instruments.

No. 9057, "Who's There," by Arthur Collins, is a new coon song by Smith and Brown, writers of "Shame on You." It tells a funny story and gives Mr. Collins a good opportunity for his particular line of work. The orchestra accompaniment adds to the attractiveness of the Record.

No. 9058, "Saved By Grace," by MacDonough and Biehling, is a Record of this well-known sacred hymn by George C. Stebbins and Fanny J. Crosby. It is given with excellent effect by these duettists. It is listed in response to many requests. Chimes are introduced into the interlude and the orchestra accompanies the Record throughout.

No. 9059, "Cleopatra Finnegan," by the Edison Military Band, was written by Neil Morlet, composer of "Hiawatha" and other well-known selections, who styles his latest effort as "an Afro-Celtic Intermezzo." It is a sparkling number and with a vein of humor running through it. The oboe is very effective in the beginning.

No. 9060, "Keep a Little Cosey Corner in Your Heart for Me," by Miss Ada Jones, is a sentimental song by Theodore Morse and Jack

Drislane. A pretty melody and story by these writers of numerous songs that have hit the popular fancy. Miss Jones, always interesting and entertaining, gives an especially fine version of the song, assisted by the orchestra.

No. 9061, "Violette," by Harlan and Stanley, is a new soldier march song that has made rapid progress in public favor during the past three months. It introduces Miss Daisy Boulais as "Violette," something new and novel in this style of selection and adding much to the effectiveness of the story, which Messrs. Harlan and Stanley tell in their usual interesting manner. This song is written by J. B. Mullen and Dolly Jardon.

No. 9062, "Peter Piper," is a xylophone solo by Albert Benzler, with orchestra accompaniment. It is one of Mr. Benzler's best efforts. Xylophone solos are always popular and "Peter Piper" is an excellent addition to those listed in our catalogue. The music is by S. R. Henry.

No. 9063, "My Irish Molly O," by Billy Murray, is another popular hit from Frank Daniels' musical farce, "Sergeant Brue." It is there sung by Miss Blanche Ring. Mr. Murray's voice is well fitted to this character of song and he renders it in good style. Jean Schwartz and William Jerome are the writers of this composition.

No. 9064, "Louis and Lena at Luna Park," by Ada Jones and Len Spencer, is a talking and singing duet which will equal if it does not exceed the popularity achieved by "Heinie," made by the same artists. It has all the attractive catchiness of "Heinie" and besides has descriptive effects of its own. As its title indicates, the scene is laid at Luna Park, Coney Island. Miss Jones and Mr. Spencer are excellent in this bit of acting and singing. Miss Jones sings "Meet Me Down at Luna Park," and Mr. Spencer joins in the chorus. The singers are accompanied by the orchestra.

No. 9065, "Pearl of California" is a bells solo by Albert Benzler, with orchestra accompaniment. The music is written in song and dance tempo, the same as the most popular of Mr. Benzler's bells solos, and the Record is made with orchestra accompaniment. The composer is Edwin Christie.

No. 9066, "Just Across the Bridge of Gold," by Byron G. Harlan, is a ballad that has rapidly come into popularity, and for which we have had a big demand. The writers, Harry Von Tilzer and Andrew Sterling, are identified with many successes in this and past seasons. Mr. Harlan gives the pathetic story, with its appealing musical setting, in a manner to win favor at once. He is accompanied by the orchestra.

No. 9067, "Every Dollar Carries Troubles of Its Own," is by Bob Roberts, and as usual, Mr. Roberts makes a lot of this coon selection, which tells a comic story. It is topical in a way, referring to a number of well-known people, on topics familiar to the public. Those familiar with Mr. Roberts' Records will realize how cleverly he can sing one with the above

title. The orchestra accompanies the singer. Leighton and Leighton wrote the words and the music.

No. 9068, "Presentation March," by the Edison Military Band, is a first-class march with good swing and melody. Its composer is E. Doring.

No. 9069, "In the Evening by the Moonlight," by Edison Male Quartette, is a popular standard old number, much called for, and one that is always heard with pleasure. It is splendidly sung by the Edison Male Quartette. The words and music of this song were written by James Bland.

No. 9070, "Would You Care?" by Irving Gillette, is Charles K. Harris's latest love ballad, and one that will probably be one of his biggest successes. It has already achieved a wide popularity and will be much sung in the coming fall and winter. Mr. Gillette makes the Record in his usual fine manner and is accompanied by the orchestra.

No. 9071, "Message of the Old Church Bell," by Harry Anthony, is a beautiful descriptive song rendered in Mr. Anthony's best vein; one that will be attractive for a long time to come. It is made with orchestra accompaniment. The music of the song was written by Manuel Romain and the words by Leighton and Leighton.

No. 9072, "Mississippi Minstrels," by the Edison Minstrels, introduces the end men, Billy Murray and Len Spencer, and a descriptive song by Harry MacDonough, "There is a Light in the Window," with quartette chorus and orchestra accompaniment.

No. 9073, "Now What D'ye Think of That Medley," by the Edison Military Band, includes four recent popular songs as follows: "Now What D'ye Think of That," (our Record No. 9046); "Sambo and Dinah" (our Record No. 9043); "Good Bye, Sweet Marie" (our Record No. 9034); "Shame on You" (our Record No. 9033).

JULY RECORDS.

We wish to compliment you on the July Records. They are fine, and each month seems to be better and better.—*J. G. Piper, Manager for Magruder & Co., Nashville, Tenn.*

While we are only one of the small "fish", still we have ordered about twice as many as we generally do from the advanced samples, and if the National Phonograph Co. would list 24 Records every month like these samples, it would not be necessary for them to do any advertising at all. I can say right here that I have been in the Phonograph business for ten years, but never before did I hear an assortment of 24 Records that could compare with those listed for the coming month.—*Thomas Clancy, Manager Phonograph Department of the Conroy Piano Co., St. Louis.*

WON OVER ALL COMPETITORS.

PORTLAND, ORE., June 6, 1905.

It gives me pleasure to write to you concerning a competition deal that I have just closed which goes to show that merit will always win out. The members of the fine new fireboat, of whom there are eighteen, decided they wanted a Phonograph, and so sent out a committee to make the rounds. They happened to call upon me first and last Friday evening I proceeded over there with a fine Edison outfit. I gave them a real enjoyable entertainment, in the meantime acquainting them with the many superior qualities and talking points positively not to be found in any other talking machine. However, after the whole affair was over they were undecided, as a few thought they might prefer something else. I did not want to take my instrument away so told them I would leave it there and for them to give it a thorough test.

(Here an account is given of an exhibition made by two other machines.)

In the meantime I stayed away, for I felt confident that my machine would never go back on me and that the more they would play it the better they would like the Edison. The result was that none of the others could hold a candle to the Edison, and the verdict was that for simplicity of operation, clearness, smoothness, material and workmanship, nothing equaled the Edison Phonograph. Consequently I closed the deal for the finest Triumph I had in stock, a large fine horn, and a large number of Records.

As I stated above, it gives me pleasure to write to you concerning this deal, for it shows that it is an indisputable fact that there is positively nothing that can equal an Edison Phonograph when each kind of a machine is put to a severe test before the others. From the fact that there were eighteen purchasing the outfit and the opinion was virtually unanimous concerning the Edison is itself conclusive evidence that the Edison has no equal.

E. B. HYATT,
Portland Phonograph Agency.

KAISER'S TRANSPARENT SIGNS.



The above is a representation of an attractive illustrated transparent sign now being gotten out for trade use by L. Kaiser, of 32 East 14th street, New York City. Its wording tells its purpose. The signs are sold in sets of

twelve—one for each month—for \$1.20, carriage prepaid. Each sign is 15x25 inches in size and can be placed in position on glass doors or windows with small gum stickers. Being transparent, they can be read from either side, day or night. The first and last lines of the signs have white letters, the second and fourth lines are red and the middle line is gold color.

MR. COLLINS IS NOT A NEGRO.

Possibly because of his great success in singing coon and rag-time songs for the Edison Phonograph some people seem to have gained the impression that Arthur Collins is a colored man. Such an impression is naturally amusing to Mr. Collins. It is complimentary, however, to imitate the colored race so closely as to be mistaken for the real article.

WHO DID IT?

"We had a lot of fun on a train going to Chicago from Minneapolis last week," said a traveling man at the Coates House yesterday. "In the Pullman were a vaudeville performer and his wife and they had with them a Phonograph. When they retired the Phonograph was played in the upper berth. Next morning about 6.30 o'clock I heard a Phonograph, I thought. It sounded like one of those barnyard selections. I stuck my head out of the berth but could see no one. Presently I heard the porter come down the aisle and stop at the berth of the vaudeville performer. "Who's running that Phonograph of mine?" asked the actor sharply, "Dey ain't nobody dat Ah knows of, sah," replied the porter. "Well, I heard it," said the actor. Then he got out of bed and looked into the upper berth. The Phonograph was there. The news that there was someone on the car who could imitate a Phonograph spread when all the berths were closed up, but no one acknowledged that it was he. As I left the car, however, I heard the Phonograph again, and, turning, discovered that the noise was coming from an old gray-haired Methodist minister who had the berth across from the actor and his wife. Now, who would have thought it?"

A SUGGESTION.

HOUSTON, TEXAS, June 3, 1905.

We tried demonstrating in a store 25x40 feet, wood floor and ceiling, but brick walls. During our entire stay therein we were unable to get satisfactory results, the density of walls evidently deadening the sounds, hence deteriorating musical quality. We have recently moved into a store T shape, with entrance on two streets, covering three times the space, yet the Phonograph sounds excellent, the acoustic properties being superb. The new store has a stone floor, but plank ceiling and walls. If other dealers are having bad results in demonstrating, they should investigate their locations.

H. M. HOLLEMAN Co.

SOLD WITHOUT TRYING.

As illustrating the ease with which a Edison Phonograph may be sold, one of our salesmen, who has just returned from the South, relates an interesting incident of his recent trip. He was exhibiting a "Standard" machine with a large-sized horn, in the store of a merchant in one of the Southern towns for the purpose of inducing the merchant to become a Dealer in Edison goods. While he was playing the Phonograph, a darkey strolled into the store, attracted by the music, and silently listened while the demonstration was being made. In a quiet moment, he broke in "That's pretty good, Boss, how much is that machine worth?" He was told that the price of the outfit was \$25. He immediately left the store and in a short time returned. Handing \$25 to our salesman he said, "I'll take that machine, Boss." He was told that that particular machine was not for sale, but that one like it would be furnished him in a week. Upon the merchant agreeing to put in the line, the darkey's money was turned over to him to make delivery when his stock was received. The ability of the Phonograph to sell itself to an apparently poor negro had much to do with inducing the merchant to become a Dealer.

EXPORT BUSINESS.

Big developments may be looked for this year in the export demand for Phonographs, according to the manager of the Export Department of the National Phonograph Co., New York. "Until a year ago," he said, "we paid little attention to export possibilities, as our home demand was about all we could attend to. Nevertheless we received quite a few orders from abroad through export commission houses and from our general advertising. During the past year we have sent agents to various foreign countries to introduce our machines, and their success has been wonderful. We are going ahead on the plan of giving our foreign customers just what they want and have introduced 'local color' where possible by having Records made by foreign bands and singers right in the countries where we expect to sell the Records. We have sold thousands of machines in Mexico and Cuba and have an agent out now who is making a grand tour of South America. The Spanish speaking people in those countries are great lovers of music, consequently we sell more band Records and such than any other kind. We now have orchestras and singers in all parts of the world turning our Records so that we are prepared to handle any foreign demand that may arise. We expect this year's foreign business to be three or four times greater than that of last year, which in turn was more than twice as great as that of the year before."—*Talking Machine World.*

A GOOD LETTER.

The following is an excellent form letter used by an Edison Dealer in the West:

We are informed that you are interested in the Phonograph matter. So is every family. In no other way can you so easily and successfully entertain yourself, your family and your neighbors as with an Edison outfit. A wonderful variety is possible: band marches, two-steps, waltzes, orchestra pieces, banjo, mandolin, bagpipe, bells, xylophone, bugles, chimes, clarinet, cornet, trombone, dulcimer, flute, piano, piccolo, violin, zither, singing, talking, whistling, etc. One can never become weary of such a change of program. You can have whatever you want whenever you want it. We have not yet seen the person who became tired of an Edison outfit. Once in your home you would never be without it. Any four-year-old child can operate it. It is a great educator of music in the home. Every one who hears the late improved machine pronounces it perfect in tone and reproduction, as well as mechanically. Every person expects to own an outfit sooner or later. Here is where we come in with our liberal proposition whereby you can own a machine at once for a very little.

We are doing the talking machine business of this part of the State. There is a reason for this. We carry the goods in stock all the time—the machines, the Records, the horns, the stands, the carrying cases, etc. The Phonographs run in price from \$10 to \$50, according to which type you choose. The \$30 type is one of the most popular. Records are 35 cents each, cash. Horns run from \$1 up to \$5 in the popular sizes for home use.

TERMS:—To any responsible adult person we will sell a machine at \$1 per week without interest until paid in full. We also permit reliable parties to take an outfit out on a week's trial free of charge. We pay all freight charges on machines, also on Records when bought in quantities of at least a dozen at a time. We allow a customer when he first purchases his machine to take an assortment of Records home with him from which to make his selections among the people directly interested and with the distinct advantage of playing them on your own machine. Such assortments may be taken out two or three times until your first choices have been made. After that there is absolutely no exchange proposition, nor do we allow Records to be taken out on approval, nor under no circumstances will we loan Records for any occasion. We do not rent outfits for any consideration; it is cheaper for you to buy than to rent. The dollar-a-week plan applies only to the Phonograph, but not to the Records, horns, stands and other accessories. Every time purchaser is asked to sign a chattel lease showing that we are the owners of the machine until paid for in full by the purchaser. This is required of us by the terms of our agreement with the factory. No Records are given with the machine. For the small 14-inch horn that comes with the machine we allow you \$1 in exchange for a larger horn of any kind. Defective Records may be returned, but not broken ones. There is positively no discount permitted for cash in any case. We mention all these little matters because they are answers to questions that are asked us every day. We are glad to reply to any queries. Correspondence is earnestly solicited and will be fully and promptly attended to by the proprietor personally.

Wherever possible we like to have the intending purchaser come into our place of business and hear for himself the best there is in the world of music. Bring your wife and children along if you are fortunate enough to possess any. If not, bring your friends with you. Come anyway; whether you are in the market for an outfit just at present or not. You will enjoy the concerts just the same. Again we invite you in to see us and hear the perfect talking machine. You will be convinced that there is but one good machine—the Edison.

It pays to make up a list of Phonograph owners and mail them a Record supplement each month.

THE SUCCESS OF THE O. K. HOUCK PIANO CO.

In May a large music house in a Western city wrote to the O. K. Houck Piano Co., at Memphis, Tenn., asking their advice in the matter of jobbing Edison goods. The letter of inquiry and the reply of the O. K. Houck Piano Co. are printed in full, with the cordial consent of the latter.

THE INQUIRY.

We are thinking of becoming a jobber of Edison Phonographs and Records. Have you increased your business since you took on the line, and from your experience would you advise us to take it up?

THE REPLY.

GENTLEMEN:—Answering your letter of the 9th inst., would state that a little over a year ago we put in a Dealer's stock of Edison Phonographs.

Our first order was very small, and if we remember aright, it did not come to over \$600. We had at that time no idea of the possibilities of the business and put in the small line mentioned purely as an experiment. Upon getting our stock arranged we inserted a small advertisement in the papers acquainting the public with the fact that we had put in a stock of the Edison goods and invited them to visit our store and hear new Records, etc. We also made a small display of the goods in one of our front windows. We were simply astonished at the way the goods sold and immediately telegraphed for more machines and sent mail orders for additional Records.

We soon began to appreciate the possibilities of the business if worked on a large scale, so our next move was to build an exclusive talking machine room with special fixtures for the accommodation of Edison Records. We put a young man in charge of the Record stock, his business being to do nothing but try over Records for either intending purchasers or patrons of our house. Up to this time we had been handling the goods only as dealers, but the demand for the Edison goods had then increased to such a point that we felt justified in becoming Jobbers in the goods, and some six months ago we took on the jobbing agency.

Our business in the Edison product has gradually grown to such proportions that a little over a month ago we leased a store at No. 160 South Second street, about two blocks from our Main street establishment, for the exclusive purpose of selling talking machines at wholesale. This wholesale department will be run entirely separate from our retail department. It will have its own office force, will find all wholesale orders and handle its own correspondence independently of our Main street house. This is what we have done in Memphis alone.

Last December we moved into our new St. Louis house, having five floors and a basement. We have devoted the entire third floor and most of the basement there to our talking machine business and carry a very large stock of the Edison product. Our St. Louis business in this line has exceeded our most sanguine expectation.

At our Little Rock house we have a large portion of one floor devoted to our talking machine department. Our Edison business at this point is proving very satisfactory.

We opened our Nashville house on March 6th last, and carry there a complete line of the Edison goods. Although the Nashville department has been running only a trifle over two months, still our talking machine business there has already reached a figure that we would have deemed satisfactory if the business had been established a year.

We have gone into this matter at considerable length and in detail because it is a part of our business over which we are all particularly enthusiastic.

We believe that there is a great future for the talking machine business and the possibilities appear to us as practically unlimited.

We would advise you most strongly to take on the jobbing agency for the Edison line, as you cannot make a mistake in doing so.

We cannot think of anything else that would interest you particularly, unless that it might be to emphasize the necessity of specializing this branch of your business. It is absolutely essential that you conduct it as a separate and distinct department, that the business be watched closely, that you see that sufficient quantities of the popular Records are always on hand, also that your advance orders for Records are large enough to supply the demands of your business.

Our experience has been that when first going into the talking machine business there is a disposition to order too sparingly of Records. While, of course, good judgment should be used not to overstock yourself, still we believe that we would rather err on the side of too much stock than not to have enough to meet the demands of our customers.

We trust that the information given will encourage you to take on the Edison line, and are confident that if you will go at it in the right way you will never regret making the move.

If we can give you any further information on the subject do not hesitate to call on us.

O. K. HOUCK PIANO Co.

THE CONSENT.

NATIONAL PHONOGRAPH Co.

JUNE 8, 1905.

GENTLEMEN:—Replying to your favor of 31st ult., beg to state that you have our cordial permission to make any use you desire of our recent letter to the _____ Co. We have no objection whatever to your using our firm name in connection with it.

In writing the _____ Co. we stated ~~only~~ facts, and as we ourselves are enthusiastic

over the commercial possibilities of the Edison machines and Records, we shall never fail to endeavor to impress our views on other dealers throughout the United States whenever the opportunity presents itself.

If our letter to the ——— Co. in any way influences them to take up the line, we shall consider that we have done them the favor rather than yourselves. We are not unmindful of the many courtesies shown us by your esteemed firm, and feel that the very least we can do is to say a good word for the Edison product whenever possible.

While our firm is young in the talking machine business, still we are greatly encouraged as to the future of same and intend to devote a goodly part of our energies in this direction.

We also take this opportunity of expressing our appreciation of the splendid protection you give to legitimate Dealers against price cutting.

We have already gotten far enough into the Phonograph business to see that the absolute one price system is the great safeguard of the business, and that without it the Jobbers' and Dealers' legitimate profits would be entirely dissipated, and besides, the pleasure of handling a business of this character would be greatly marred.

O. K. HOUCK PIANO Co.

NEW ELECTROTYPES FOR TRADE USE



No. 482. 18c.



No. 484. (Half Tone.) 26c.



No. 483. 23c.



No. 485. (Half Tone.) 33c.

Nos. 484 and 485 cannot be used in ordinary newspapers.

JOBBER'S OF EDISON PHONOGRAPHS AND RECORDS.

ALABAMA.

Birmingham—Talking Machine Co., 2007 Second ave.
Mobile—W. H. Reynolds, 167 Dauphin street.
Montgomery—R. L. Penick, 119 Dexter ave.

CALIFORNIA.

San Francisco—Peter Bacigalupi, 786-788 Mission street.

COLORADO.

Denver—Denver Dry Goods Co., 619 16th street.

CONNECTICUT.

Middletown—Caulkins & Post Co., 406-408 Main street.
New Haven—Pardee-Ellenberger Co., 155 Orange st.

DISTRICT OF COLUMBIA.

Washington—E. F. Droop & Sons Co., 925 Pennsylvania avenue, N. W.
 S. Kann Sons & Co., 8th and Pennsylvania avenues.

GEORGIA.

Atlanta—Atlanta Phonograph Co., 49 Peachtree St.
Waycross—George R. Youmans.

ILLINOIS.

Chicago—James I. Lyons, 73 Fifth avenue.
 Siegel, Cooper & Co., 281 State street.
 Talking Machine Co., 107 Madison street.
 The Vim Co., 68 E. Lake street.
 Montgomery Ward & Co., 111 Michigan ave.
 Rudolph Wurlitzer Co., 302 Wabash ave.
Peoria—Peoria Phonograph Co., 222 Bridge street.
Quincy—Quincy Phonograph Co., 808 Hampshire st.

INDIANA.

Indianapolis—Craig-Jay Co., 234 Massachusetts ave.
 Kipp Bros. Co., 37 S. Meridian street.
 A. B. Wahl & Co., 119 S. Illinois street.
Lafayette—A. B. Wahl & Co., 304 Main street.

IOWA.

Des Moines—Hopkins Bros. Co., 620 Locust street.
 Vim Co., 704 West Walnut street.
Fort Dodge—Early Music House, 822 Central ave.

KENTUCKY.

Louisville—C. A. Ray, 640 Fourth street.

LOUISIANA.

New Orleans—William Bailey, 600 Frenchman street.
 National Automatic Fire Alarm Co.,
 614 Gravier street.

MAINE.

Bangor—S. L. Crosby Co., 186 Exchange street.
Portland—W. H. Ross & Son, 207 Commercial street.

MARYLAND.

Baltimore—E. F. Droop & Sons Co., 109 N. Charles St.

MASSACHUSETTS.

Boston—Boston Cycle & Sundry Co., 48 Hanover street.
 Eastern Talking Mach. Co., 177 Tremont st.
 Iver Johnson Sptg. Goods Co., 163 Washington street.
 C. E. Osgood Co., 744 Washington street.
 Read & Read, 558 Washington street.
Fitchburg—Iver Johnson Sptg. Goods Co., 247 Main st.
Lowell—Thomas Wardell, 111 Central street.
New Bedford—Household Furnishing Co., 170 Purchase street.
Springfield—Flint & Brickett Co., 439 Main st.
Worcester—Iver Johnson Sptg. Goods Co., 304 Main st.

MICHIGAN.

Detroit—American Phono. Co., 106 Woodward ave.
 Grinnell Bros. 219 Woodward ave.
Saginaw—Morley Bros.

MINNESOTA.

Minneapolis—Thomas C. Hough, 714 Hennepin ave.
St. Paul—W. J. Dyer & Bro., 21-23 West 5th street.
 Thomas C. Hough, 392 Wabasha street.
 Minnesota Phonograph Co., 37 E. 7th street.

MISSOURI.

Kansas City—J. W. Jenkins' Sons Music Co., 1013-1015 Walnut street.
 J. F. Schmelzer & Sons Arms Co., 710 Main street.
St. Louis—Conroy Piano Co., 11th and Olive streets.
 O. K. Houck Piano Co., 1118 Olive street.
 Western Talking Machine Co., 923 Olive st.

NEBRASKA.

Lincoln—H. E. Sidles Cycle Co., 1317 O street.
Omaha—Nebraska Cycle Co., 15th and Harney streets.
 Omaha Bicycle Co., 16th & Chicago sts.

NEW JERSEY.

Hoboken—Eclipse Phono. Co., 205 Washington st.
Newark—A. O. Petit, New and Halsey streets.
Paterson—James K. O'Dea, 117 Ellison street.
Trenton—Stoll Blank Book and Stationery Co., 30 E. State street.
 John Sykes, 105 N. Broad street..

NEW YORK.

Albany—Finch & Hahn, 92 State street.
Brooklyn—Chapman & Co., Fulton and Duffield streets.
 A. D. Matthews' Sons, 394 Fulton street.
 Price Phonograph Co., 1260 Broadway.
Buffalo—P. A. Powers, 613 Main street.
Elmira—Elmira Arms Co., 117 Main street.
Gloversville—American Phono. Co., 99 W. Fulton st.
Kingston—Forsyth & Davis, 307 Wall street.
New York City—Bettini Phono. Co., 156 W. 23d street
 Blackman Talking Machine Co., 97 Chambers street.
 J. F. Blackman & Son, 2737 3d avenue
 *Sol Bloom. New Amsterdam Theatre Building.
 I. Davega, Jr., 802 Third avenue.
 S. B. Davega, 32 E. 14th street.
 Douglas Phono. Co., 89 Chambers st.
 H. S. Gordon, 139 Fifth avenue.
 Harry Jackson, 219 Bowery.
 Jacot Music Box Co., 39 Union Square.
 Victor H. Rapke, 1661 Second avenue.
 Siegel-Cooper Co.
 John Wanamaker.
 Alfred Weiss, 1525 First avenue.
Oswego—Frank E. Bolway, 32 Bridge street.
Poughkeepsie—Price Phonograph Co., 203 Main st.
Rochester—A. J. Deninger, 345 North street.
 Mackie Piano, O. & M. Co., 100 State street.
 Giles B. Miller, 63 State street.
 Talking Machine Co., 97 Main st., E.
Schenectady—Finch & Hahn, 456 State street.
 Jay A. Rickard & Co., 253 State street.
Syracuse—W. D. Andrews, 216 E. Railroad street.
Troy—Finch & Hahn, 7 Third street.
Utica—Clark-Horrocks Co., 54 Genesee street.
 Arthur F. Ferriss, 89 Washington street.
 William Harrison, 41 Columbia street.
 Utica Cycle Co., 31 Columbia street.

OHIO.

Canton—Klein & Heffelman Co., 216 N. Market street.
Cincinnati—Ilsen & Co., 25 W. 6th street.
 Rudolph Wurlitzer Co., 10-12 W. 4th st.
Cleveland—Eclipse Musical Co., Jr., Erie and Huron sts.
Columbus—Perry B. Whitsit Co., 213 S. High street.
Dayton—Niehaus & Dohse, 35 E. 5th street.
East Liverpool—Smith & Phillips Music Co.
Newark—Hoover-Ball Co., Inc.
Toledo—Hayes Music Co., 608 Cherry street.

PENNSYLVANIA.

Allegheny—Henry Braun, 500 Federal street.
Allentown—G. C. Aschbach, 539 Hamilton street.
Easton—William Werner, 401 Northampton street.
Harrisburg—S. K. Hamburger, 12-14 N. Market sq.
New Castle—W. C. DeForest & Son.
Philadelphia—C. J. Heppe & Son, 1117 Chestnut street
 Lit Bros., Market and 8th streets.
 Penn Phonograph Co., 17 S. 9th street.
 John Wanamaker, 13th and Market sts.
 Wells Phonograph Co., 41 N. 9th street.
 Western Talking Mach. Co., 25 S. 9th st.
 H. A. Weymann & Son, 923 Market st.
Pittsburg—Theo. F. Bentel Co., Inc., 632 Liberty street.
 Kaufmann Bros., Fifth avenue.
 H. Kleber & Bro., 221 Fifth avenue.
 C. C. Mellor Co., 319 Fifth avenue.
 Pittsburg Phono. Co., 937 Liberty street.
Reading—Reading Phonograph Co., 809 Penn street.
Scranton—Ackerman & Co., 130 Wyoming avenue.
 Technical Supply Co.

RHODE ISLAND.

Pawtucket—Pawtucket Furniture Co., 39 N. Main St.
Providence—J. M. Dean Co., 785-795 Westminster street.
 J. A. Foster Co., Weybosset st.
 Household Furniture Co.
 J. Samuels & Bro., 154 Weybossett street.
 A. T. Scattergood & Co., 106 N. Main st.

TENNESSEE.

Knoxville—Knoxville Typewriter and Phonograph Co., 311 Clinch street.
Memphis—O. K. Houck Piano Co., 359 Main street.
 F. M. Atwood, Lyceum Building.
Nashville—Nashville Talking Mach. Co., 510 Church st.
 Magruder & Co., 13 Arcade.

JOBBER OF EDISON PHONOGRAPHS AND RECORDS—Continued.

TEXAS.

Dallas—Southern Talking Machine Co., 347 Main st.
 Fort Worth—Cummings, Shepherd & Co., 700 Houston st.
 Houston—Texas Phono. Co., Capitol and Fannin Sts.
 Richmond—Magruder & Co., 729 E. Main st.

VIRGINIA.

Richmond—Magruder & Co., 729 E. Main st.

WISCONSIN.

Milwaukee—McGreal Bros., 173 3d street.

CANADA.

Toronto—R. S. Williams & Sons Co., Limited,
 143 Yonge street.
 Winnipeg—R. S. Williams & Sons Co., Ltd., 121 Princess street.

*Added since June 1, 1905.

SUSPENDED LIST, JULY 1, 1905.

SUPERSEDING ALL PREVIOUS LISTS.

ILLINOIS.

Chicago—*H. E. Everett, 6134 S. Halsted street.
 *Ansley Heitz, 722 W. 63d street.
 Ottawa—Edward Hayne.
 Wheaton—E. Irving.

INDIANA.

South Bend—EUGENE MARSH, 126 Vistula avenue.
 SOUTH BEND BOOK BINDERY, Robert
 Lebolt, Prop., 203 North Michigan street.

IOWA.

Burlington—JOHN P. WEISS, 711 Jefferson street.
 Sioux City—HATTENBACH BROS. CO.

KANSAS.

Clay Centre—E. M. GOWENLOCK.
 Lawrence—BELL BROS.

MAINE.

Biddeford—W. H. FIELD.
 Monmouth—G. H. STETSON.

MASSACHUSETTS.

Boston—T. SINGER, 60 Leverett street.
 Lawrence—LORD & CO., 314 Essex street.
 E. O. MOSHER, 420 Essex street.
 Lynn—ELIAS DEYOUNG.
 Malden—A. T. FULLER.
 Nantucket—ARTHUR M. TAYLOR.
 New Bedford—H. B. DEWOLFF.
 Somerville—E. J. WINCHESTER, 32 Summit avenue.
 Woburn—OSBORN GILLETTE, or THE BOLTON
 JEWELRY CO., L. F. Maloney, Manager.

MICHIGAN.

Detroit—F. J. SCHWANKOVSKY.
 Saginaw—GEO. W. EMENDORFER.
 JAMES V. CALAHAN, 217 Genessee st.
 TIERNEY BROS., 217 Genessee st.

MISSOURI.

Kansas City—THE WITTMANN CO.

NEBRASKA.

Lincoln—THE WITTMANN CO.
 Omaha—THE WITTMANN CO.

NEW HAMPSHIRE.

Hillsboro Bridge—E. M. BARNES.
 Manchester—A. E. DUMAS
 Nashua—F. A. McMASTER & CO.

NEW JERSEY.

Atlantic City—SAM'L D. WOLF, 32-34 Arkansas ave.
 Bayonne—I. WIGDOR, 450 Avenue D.
 Jersey City—W. L. HOFFMAN, 151 Montgomery st.
 Newark—R. L. CORWIN; also New York City.
 Passaic—I. HURWITZ.
 Paterson—CHAS. H. KELLY, 25 N. Main street.

Plainfield—S. W. FRUCHT, or R. FRUCHT; also
 New York City.

ELSTON M. LEONARD.

West Hoboken—EMIL HOLLANDER, or THE WEST
 HOBOKEN BICYCLE & PHONO. CO., 619
 Spring street.

NEW YORK.

Albany—G. LINDE, 353 S. Pearl street.
 Bedford Park—GEO. H. TYRRELL.
 Hobart—F. H. MARSHALL.
 New York City—A. T. ARMSTRONG, or AMERI-
 CAN PHONO. CO., 106 Wall street.
 AUTOMATIC ZITHER CO., M. Cohen, Prop.,
 58 Second avenue.
 BERN BEARWALD, 373 W. 11th st.
 BRONX PHONO. CO. or DAVID SWITKY,
 506 Willis ave.
 CENTRAL PHONO. CO., 160 E. 42d street.
 R. L. CORWIN; also Newark, N. J.
 EAGLE PHONO. CO., or C. LOWENTHAL,
 83 Nassau street.
 EMPIRE PHONO. CO., 2 W. 14th street.
 S. W. FRUCHT, or R. FRUCHT, 7 Barclay st.,
 or 68 Cortlandt st.; also Plainfield, N. J.
 O. HACKER, 2 Murray street
 HAWTHORNE & SHEBLE, 297 Broadway;
 also Philadelphia, Pa.
 HOLOBER BROS., 350, 421 and 491 West st.
 N. HORN, 148 E. 58th street.
 W. L. ISAACS, 114 Fulton street.
 S. LEMBURG & CO., 194 Broadway
 J. McELLYNNE, 202 Broadway.
 RICHMOND PEASE, 44 W 132d st
 F. M. PRESCOTT, 44 Broad st.
 WINTHROP CYCLE CO., 2212 Seventh ave.

Rome—CHARLES TUTTLE.

Saratoga—W. J. TOTTEN.

Saratoga Springs—MARVIN A. COTE.

OHIO.

Cincinnati—J. L. ANDEM.
 Coshocton—BURNS & GOSSER.
 Springfield—D. & M. VANDERPOOL.
 Uhrichsville—F. A. MAZURIE.

PENNSYLVANIA.

Philadelphia—A. R. CASSIDY, 2783 Emerald street,
 HAWTHORNE & SHEBLE, 604 Chestnut st., or
 Oxford and Mascher sts.; also New York City.
 A. KROUSE, 832 Arch street.
 PENN NOVELTY CO., 15 South 9th st

Phoenixville—KEINARD BROS.

Pittsburg—A. LIPPARD, 615 Wylie ave.

RHODE ISLAND.

Providence—F. P. MOORE.

WISCONSIN.

Milwaukee—J. C. BLATZEK.

*Added Since June 1, 1905.

Jobbers and Dealers are asked not to supply any of the above named firms with our apparatus, either at addresses given or any other address.

DOUBLE SERVICE

FOR A GOOD REPORT

PARLEZ VOUS FRANCAIS?
 HABLA USTED ESPANOL?
 YANKEE DOODLE
 THE STAR SPANGLED BANNER
 SPRECHEN SIE DEUTSCH?



AMUSEMENT AND LANGUAGE STUDY

Send Fifty Cents for the new I. C. S. Sample Language Record, containing extracts from lessons in French, German, Spanish, and English, *on one cylinder*. Delivered by express prepaid in the United States or Canada. Send today for sample record, prices, and literature. Address:

LANGUAGE DEPARTMENT
INTERNATIONAL CORRESPONDENCE SCHOOLS
SCRANTON, PA.

FOR FOREIGN SALES, ADDRESS { Foreign Dept., National Phonograph Co., 31 Union Square, New York City.
European Headquarters, National Phonograph Co., Ltd., 25 Clerkenwell Road, London, E. C.

EDISON Phonograph Monthly

PUBLISHED FOR TRADE USE ONLY BY
THE NATIONAL PHONOGRAPH CO.

VOL. III.

ORANGE, N. J., AUGUST, 1905.

No. 6.

NATIONAL PHONOGRAPH CO.

ORANGE, N. J.

NEW YORK: 31 UNION SQUARE.

CHICAGO: 304 WABASH AVENUE.

SAN FRANCISCO: 786 MISSION STREET.

NATIONAL PHONOGRAPH CO., LTD., 25 CLERKENWELL
ROAD, LONDON, ENG.

EDISON PHONOGRAPHS AND RECORDS.

All communications to THE PHONOGRAPH MONTHLY
should be addressed to the Advertising Department,
Orange, N. J.

C O N T E N T S

Don't Put It Off; Do It Now.....	1
Advance List of September Records.....	2
No Dull Summer.....	3
Edison Commercial System.....	3
Jim Bludso	3
Printed Matter	4
Among the Jobbers	4
Convenient, Economical and Inexpensive Record Shelving	5
An Important Change.....	7
The Edison on Top.....	7
Foreign Cut-Outs	7
Effective Window Display.....	8
Just the Thing for Dancing.....	8
About Premium Machines.....	8
Comments on Edison Gold Moulded Rec- ords for September, 1905.....	9
The Modern Profession of Inventing....	11
Phonograph Department of the Theo. F. Bentel Co., Pittsburg	13
Jobbers of Edison Phonographs and Rec- ords	14
Suspended List, August 1, 1905.....	15

DON'T PUT IT OFF; DO IT NOW.

Every individual or firm that has been selling Edison Phonographs and Records for any length of time and in a progressive manner, must look back over the business done in the first half of this year with much satisfaction. If such individuals or firms have carried a proper stock of goods and given their sale the attention necessary to the success of any business, then they must feel that elation and gratification which comes from doing anything successfully. Dealers in Edison goods have had in the past six months the most prosperous period since the invention of the Phonograph. Most of the business came to them with little effort on their part. Those who advertised and hustled in other ways got a larger share than a majority of Dealers, but most of them bought and sold to meet the demands of the public. This demand was caused by the quality of Edison goods and the methods being employed by the National Phonograph Company to exploit them. These features of quality and effort have caused the usual dull midsummer season to be practically eliminated. No one is selling as many Phonographs and Records now as in the first four months of this year, but every Jobber and Dealer is doing a larger business at the present time than in any month of last year. This statement is borne out by the output of our factory and by the orders that are being received with remarkable steadiness and uniformity.

With the experience of the past few months before him, and with his knowledge of the present state of trade, every Jobber and Dealer should now be revolving in his mind this question, "What shall I do to get even a greater share of this 'easy-money' business in the months to come?" The question may be answered thus: Carry a proper stock and let the people know that you have it. Call to mind the business you lost in the past six

THE ADVANCE LIST OF SEPTEMBER RECORDS APPEARS ON PAGE 2.

NEW EDISON GOLD MOULDED RECORDS. ADVANCE LIST FOR SEPTEMBER, 1905.

RECORDS listed below will be ready for shipment as near **September 1st** as possible, at which time Jobbers' stock orders, if **received prior to August 10th**, will be shipped. September Supplements will be forwarded to Jobbers with their stock order for Records. Retail Dealers should place stock orders with their Jobbers at once, to insure prompt shipment as soon as Jobbers' stock is received.

- 9074 Pique Dame Overture (*Suppe*) *Introducing flute and clarinet duet* Edison Concert Band
 9075 Down Where the Silv'ry Mohawk Flows (*Heinzman*) Harry Anthony
Descriptive song, Orch. accom.
- 9076 Making Eyes (*Von Tilzer*) *Male duet, Orch. accom.* Collins and Harlan
 9077 Swiss Boy (*Bent*) Herbert L. Clarke and John Hazel
Cornet duet, air and variations, Orch. accom.
- 9078 Waltzing with the Girl You Love (*Evans and Shields*) Harry MacDonough
Waltz song, Orch. accom.
- 9079 Chimmie and Maggie at the Hippodrome Ada Jones and Len Spencer
Descriptive talking and singing selection with Orchestra incidental music.
- 9080 Melody in F (*Rubinstein*) 'Cello solo, Piano accom. Hans Kronold
- 9081 Killarney (*Balfe*) *Irish ballad, Orch. accom.* Miss Marie Narelle
- 9082 Crucifix (*Faure*) *Tenor and baritone sacred duet, Orch. accom.* Anthony and Harrison
- 9083 Washington Greys March (*Grafulla*) Edison Military Band
- 9084 Nobody (*Williams*) *Coon song, Orch. accom.* Arthur Collins
- 9085 Just Plain Folks (*Stonehill*) *Descriptive song, Orch. accom.* Ada Jones
- 9086 Waltz of the Swallows (*Valverde*) (*Vals de las Golondrinas*)
 Edison Symphony Orchestra
- 9087 Lasca (*Desprez*) *Recitation.* Edgar L. Davenport
- 9088 Just Because I'm from Missouri (*Wenrich*) *Coon song, Orch. accom.* Bob Roberts
- 9089 Through Battle to Victory March (*v. Blon*) Edison Concert Band
- 9090 Two Little Girls Loved One Little Boy (*Mullen*) Byron G. Harlan
Descriptive song, Orch. accom.
- 9091 You Must Think I'm Santa Claus (*Silver*) *Coon song, Orch. accom.* Tascott
- 9092 The Adieu (*Nicolai*) Miss Narelle and Mr. Anthony
Soprano and tenor sentimental duet, Orch. accom.
- 9093 The Bells (*Mora*) *Bells solo, Orch. accom.* Albert Benzler
- 9094 Little Girl You'll Do (*Solman*) *Sentimental song, orch. accom.* Irving Gillette
- 9095 Give My Regards to Broadway (*Cohan*) Billy Murray
Song hit from "Little Johnny Jones," Orch. accom.
- 9096 Sing Me the Songs of Dixie Land (*Casely*) Edison Male Quartette
Descriptive quartette, Orch. accom.
- 9097 Keep a Little Cosey Corner in Your Heart for Me Medley Edison Military Band
*Introducing "Keep a Little Cosey Corner in Your Heart for Me,"
 "The Message of the Old Church Bell," "Would You Care"
 and "Violette."*

Edison Gold Moulded Records are made only in Standard Size. Both Standard and Concert Records may be ordered from this list. Order by number, not title. If Concert Records are wanted, give the number and letter C.

months because you did not have the stock, and make up your mind to guard against such losses by carrying a larger and more complete stock. If you have had trouble in handling your stock and have lost time when waiting upon customers because you could not find Records when you wanted them, spend a little extra time in planning a better way of carrying Records. If you don't know how, ask your Jobber for some assistance. If you have not been carrying the full line of Edison domestic selections, ask your Jobber about the success of the Dealers who have done so and follow their example. It is worth many dollars to an Edison Dealer to be able to announce to the public that he carries every Edison Record.

Don't wait till cool weather brings customers to your store. Get ready now. It is only August, of course, but by the time you make up your order, pass it along and get your goods, it will be from September 1st to 15th and the fall season will be at hand. Edison goods are going to be better advertised than ever before, and the demand will be proportionately greater. Then, too, there will be improvement in quality that will be a potent factor in inducing the public to fall in under the Edison banner. We know that the fall business in Edison goods will be the greatest in the history of the Phonograph, and those Dealers who do not early prepare for it will soon find that they have made a mistake.

NO DULL SUMMER.

The officials of the National Phonograph Co. looked forward to the advance orders for August Records with considerable interest. The July orders had shown no marked falling off with the advent of summer, but it was thought that August, with its discomforts and the absence of people on vacations, might tell a different story. Consequently, there was rejoicing when the August orders were footed up and the total found to equal those for July. It was then realized that the Phonograph business was not to have a dull summer season and that there was to be no break in the record of the year.

EDISON COMMERCIAL SYSTEM.

The Edison Commercial System for installing the Edison Business Phonograph was formally announced to the public on July 1st, 1905. The work of perfecting the Edison Business Phonograph has been in hand for the past three years. It was thought to be completed a year ago, but it was decided to give it a thorough and practical business trial be-

fore putting it on the market. One hundred machines were installed in the offices of a number of firms in New York city and vicinity, conducting various kinds of business, and a most complete trial was given them. These trials lasted nearly a year and the reports from each justified this company in announcing the formation of a special department, to be known as the Commercial Department, for the installation and sale of the Edison Business Phonograph.

The department is in charge of Nelson C. Durand as manager, and Charles L. Hibbard as general superintendent. Offices have been leased on the third floor of the Bank of the Metropolis building, 31 Union Square, New York, immediately under the general offices of the National Phonograph Company. This will be the headquarters of the selling force, and as fast as practicable branches will be established in other large cities. Believing that the success of the Business Phonograph depends upon the most careful installation and supervision, it has been decided not to sell machines through the trade in the same manner as the Phonograph used for amusement purposes. That many more could be sold in the first year, if sold through the trade, is not doubted, but Jobbers and Dealers could not afford the time and expense necessary to install them and look after their operation until their patrons had themselves become accustomed to them and needed no further assistance. We have decided, therefore, to handle the business in a manner that will ensure the certain success of the system, even though it may take a much longer time in which to get the same volume of business.

The Commercial Department has issued a special catalogue, in which appears the following announcement:

TO THE BUSINESS WORLD.

Mr. Edison's genius and his many successful inventions should warrant a careful investigation of the Edison Commercial System, which employs the Business Phonograph for amanuensis work.

The business man who gives his attention to this subject should carefully distinguish between the mere purchase of a Phonograph and the installation of the Edison Commercial System. Purchasing a "machine" is often only a whim or an experiment, while the installation of the Edison Commercial System is the responsible action of a company guided by the advice of commercial experts and backed by Mr. Edison's wide experience.

The Edison Commercial System makes it practicable and advisable to centralize the typewriting force of any office—a fact that alone should recommend it to office managers as a genuine economy and an excellent means for despatching business. Less apparent, perhaps, but of still greater value, is its convenience to the "brains that direct." The Phonograph makes the department heads independent of office routine, and enables them in privacy to give greater concentration, concise

and freedom of thought to business correspondence.

The necessity for a separate department to install and maintain the Edison Commercial System has been impressed upon the undersigned company, operating under Mr. Edison's patents. To that end the "Commercial Department" will establish branch offices throughout the principal business centers in this country and abroad to carry out its plans, for which the company will be fully responsible. All business, therefore, relating to this subject should be conducted with branch offices bearing the undersigned firm name, or direct with the main office at Orange, N. J.

This catalogue has been written simply and directly for business men, avoiding technical terms and descriptions. Its mission will be accomplished if the reader is prompted to ask for a practical demonstration of the system and our prices for installation.

A copy of this catalogue will be mailed upon request to any one interested. It will not, however, be furnished in quantities.

"JIM BLUDSO."

The death of Secretary John Hay lends a peculiar interest to the Edison Record in the August list of "Bludso," one of Mr. Hay's earliest literary efforts and one that has been widely published and read. Our Record is made by Edgar L. Davenport in a manner that brings out the full meaning of the poem. If Jobbers and Dealers call the attention of their patrons to these facts this Record will have a large sale.

PRINTED MATTER.

With their August Records we are sending to all Jobbers a quantity of another special circular bearing upon the August list, which we hope will prove of material assistance in aiding Jobbers and Dealers in quickly disposing of their first orders and compelling them to come back for a new stock of Records. Copies have been mailed to the entire trade. Dealers may get a supply of them from their Jobbers should the latter fail to include a quantity with their August Records. The quantity shipped to each Jobber is the same as his standing order for supplements. Additional quantities of July and August may still be supplied upon request.

A new Foreign Record Catalogue, Form No. 720, will be issued this month. Copies will be mailed in a few days and all orders now on hand will be filled with the new edition. This catalogue will contain every foreign selection for which we have moulds at Orange, including the recently listed Hebrew and Swedish titles and the complete Mexican list.

Because of the disappointment expressed by many Phonograph owners at their inability to get copies of the first issue of the *NEW PHONOGRAM*, July, 1904, we have just reprinted

a small edition of that issue and will mail copies at two cents each. Dealers having customers anxious to get copies should inform them of this fact. We cannot fill orders for quantities of this issue.

Copies of the new Record catalogue, domestic selections, are mailed herewith. It is Form No. 725 and includes all titles listed to July. This catalogue will be current until October at least.

The new Numerical Catalogue of Records, Form No. 700, was mailed to the trade last month. It gives all titles listed to and including July, 1905, both domestic and foreign, and corresponds with the new Record catalogue, Form 725. By attaching a new supplement each month, Dealers may keep the catalogue up to date.

The steel lithographed sign showing a portrait of Mr. Edison, and sent out some weeks ago, was for trade use only. In order that the public might also have a photograph of Mr. Edison we have had one lithographed on card and have just mailed copies to the entire trade. Jobbers may place orders for a quantity, both for their own and their Dealers' use. This card bears no form number. It may be ordered as No. 746.

Our printer promises delivery of the first copies of a new Phonograph Catalogue, Form No. 740, in a few days, and in two weeks we shall be filling orders for machine catalogues out of this edition. This catalogue is practically a reprint of the present catalogue, but the illustrations of the machines will be treated in a different manner and it will have a colored cover.

AMONG THE JOBBERS.

The Conroy Piano Co., of St. Louis, Mo., have opened a branch store at Dallas, Texas.

The Hoover-Ball Co., Edison Jobbers at Newark, Ohio, have been succeeded by the Ball-Fintze Co. The capital stock has been increased to \$100,000. This company has had a phenomenal success with Edison Phonographs and Records since they became Jobbers less than a year ago.

W. G. Walz & Co., of El Paso, Texas, became Edison Jobbers last month. They have been selling Edison goods for some time as Dealers and their success has warranted them in taking up this line as Jobbers. They intend making an aggressive campaign in that part of Texas and in the adjoining States.

James I. Lyons, of Chicago, has moved from 73 Fifth avenue to 194 Van Buren street.

CONVENIENT, ECONOMICAL AND INEXPENSIVE RECORD SHELVING.

One of the problems of the Dealer in Edison goods is to find a compact and economical method of carrying his stock of Records, and one, too, that will make an attractive display showing the value of his stock. The Dealer who has had no opportunity of seeing how others carry their stocks and who must depend upon his own ingenuity, is often puzzled to know just how to solve the problem. As a result, if he is busy, he puts them on ordinary shelves, losing an opportunity to make an attractive display and putting

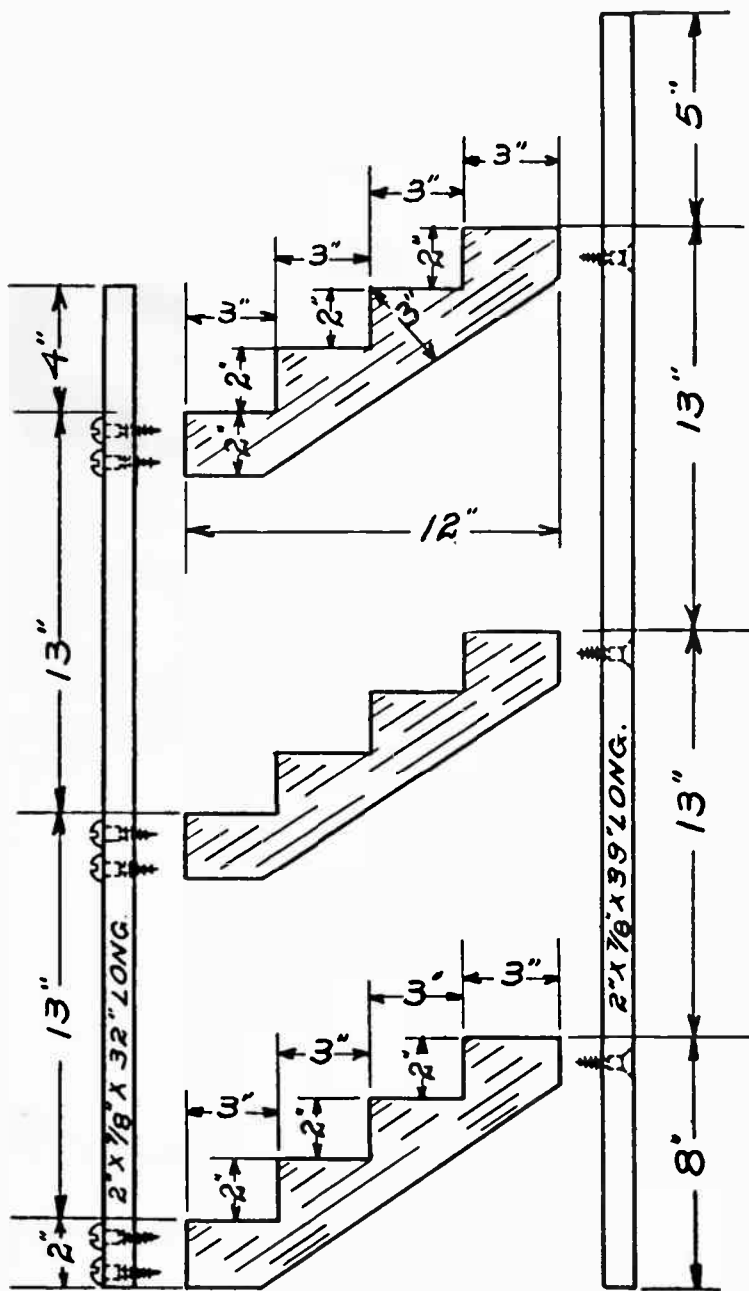

Fig. 1. Shows manner of cutting a 3-inch strip, $\frac{7}{8}$ -inch thick, so as to make a 4-step skeleton step rack, three sections high. Uprights are 2 inches wide by $\frac{7}{8}$ -inch thick—front one is 32 inches long; rear one 39 inches long.

himself to much trouble all the time in endeavoring to find Records which are generally somewhere else.

In the belief that the information will be of interest and value to not only the small Dealer, but the entire trade, we are devoting considerable space in this issue to a description, with illustrations, of a plan of putting up Record shelving.

F. L. Fritchey, one of our Western salesmen, is the originator of this plan of "step"

shelving and in the past four years has built many of these racks for Dealers in his territory. They have uniformly given satisfaction and seldom has one of them been taken out for another plan, even where Dealers carried all the Records in the domestic catalogue. As may be seen in the accompanying illustrations, the Records, when arranged on this style of shelving, present a handsome appearance, every number is plainly visible and any Record may be found in a moment. Blank spaces show when a Record is not in stock, enabling the Dealer to make up a new order for his Jobber by simply glancing at his shelves. This arrangement of shelving is also economical of floor space and is quite inexpensive.

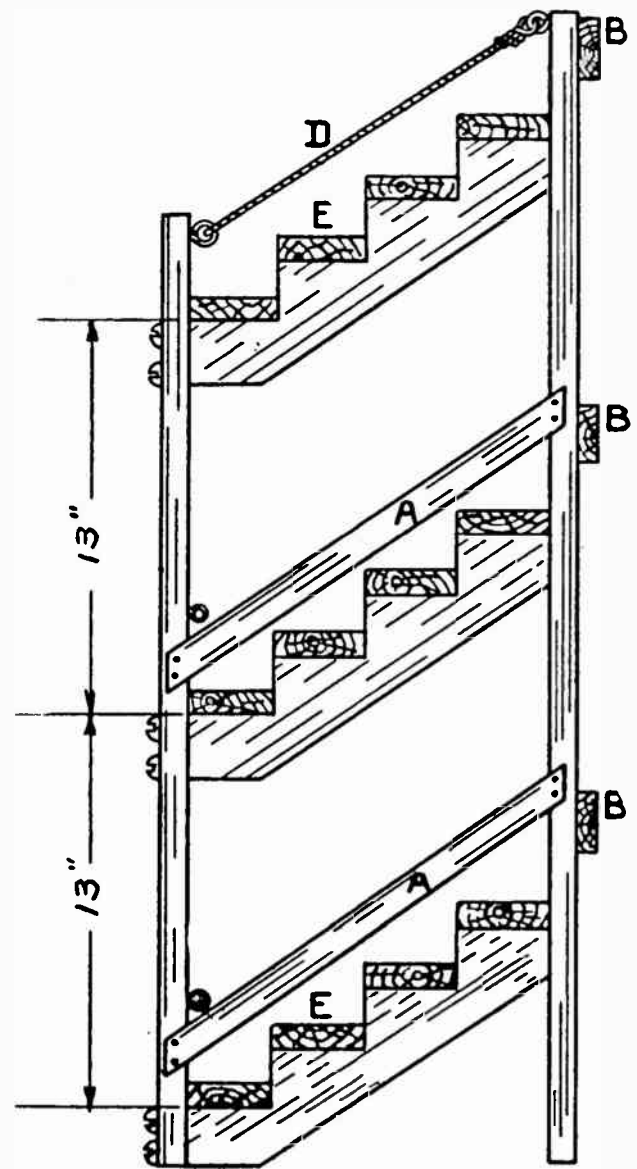

Fig. 2. Shows end view of skeleton shelving, three sections high, with shelving in their places on steps. A and B are optional ways of protecting Records from falling off the ends of shelves. B is a strip across back to prevent the back row of Records falling, where rack is built away from the wall. The picture-cord wire (D) should also be extended across in front of front rows of Records about $2\frac{1}{2}$ inches above the top surface of front shelves. The shelves (E) are 3 inches wide by $\frac{7}{8}$ -inch thick.

This rack can be suspended on the wall, placed on counter or table, or inside of jeweler's or music wall case,—built to fit any space desired.

This shelving may be built in two ways. In one case it may have open ends as shown in Figs. 1 and 2. This is called skeleton end. In the other case it may be built with solid ends, with cleats nailed to the upright boards

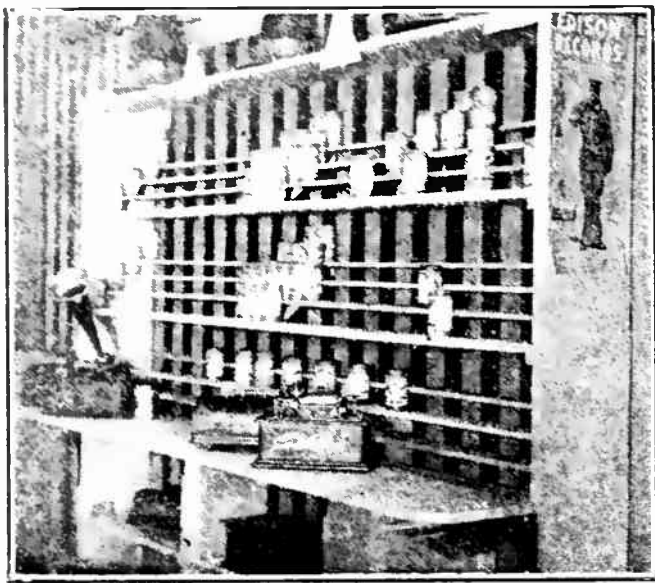

Fig. 3. Shows front view of shelving, with 3-inch slat shelves and 2 inches raise from surface to surface. The front rows are 13 inches apart, surface to surface, giving space to lift out back row of Records.

to support the slat shelves at each end. This style is shown in Figs. 3 and 7. Figs. 1 and 2 show the dimensions for shelving with four

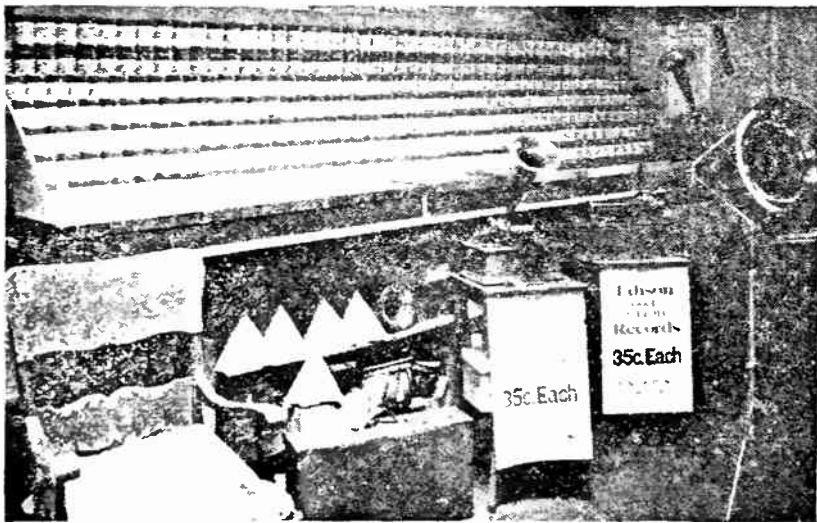

Fig. 4. Step shelving in store of J. E. Rufing, Delphi, Ind. Capacity, 528 Records (192 in peg boxes in front and 336 arranged in 7 steps above).

steps and furnish details by which almost any Dealer will be able to put up a set of these shelves. These drawings show a raise of 2

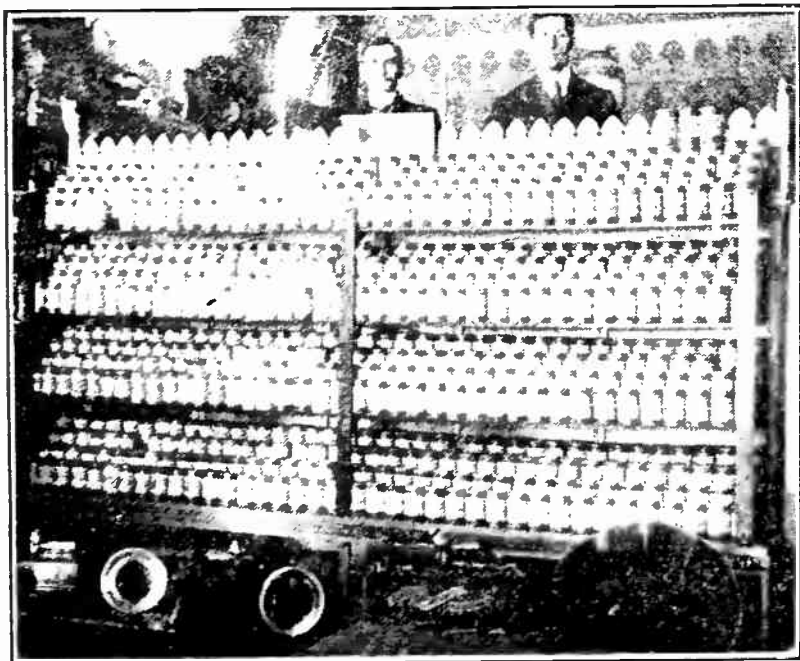

Fig. 5. Step shelving 9 feet 3 inches long in store of George E. Cook, Anderson, Ind. Capacity, 625 Records.

inches in the steps and a depth of 3 inches. Allowance of 13 inches is made between the front shelves, and the dimensions of material to be used are given.

When these shelves are built with open ends, it is necessary to have a wire stretched from front to rear upright so as to prevent the Records from falling off. (See D, Fig. 2.) Or a strip of wood may be nailed from front to rear upright to answer the same purpose. (See A, Fig. 2).

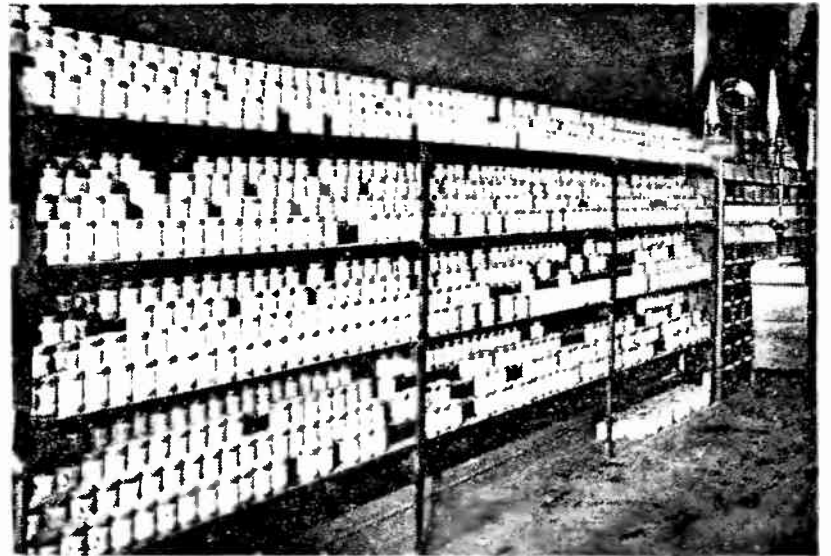

Fig. 6. Step shelving in store of Rinker Music Co., Lafayette, Ind. Capacity, 1,160 Records. Note how conspicuous the empty spaces are, showing how easy it is to ascertain what numbers are not on hand, when stock is arranged numerically.

If the shelving is built away from the wall, it is also necessary to have wire stretched across the back or a strip (D) nailed to the back to keep the boxes from falling off. The uprights can be extended upwards to hold more sets of steps if desired. Steps can also be made with more shelf surfaces. (See Figs. 4 and 8.) Illustration No. 6 shows four-



Fig. 7. Step shelving in store of the Wabash Music Co., Terre Haute, Ind. Capacity, 2,720 Edison Records (and always filled).

step shelving with the uprights six feet apart. A stretch of more than six feet for 3 inch shelves is prohibitive on account of sagging. An extra skeleton rack of steps is required for each additional six feet of shelving desired.

A section six feet long, with three tiers of

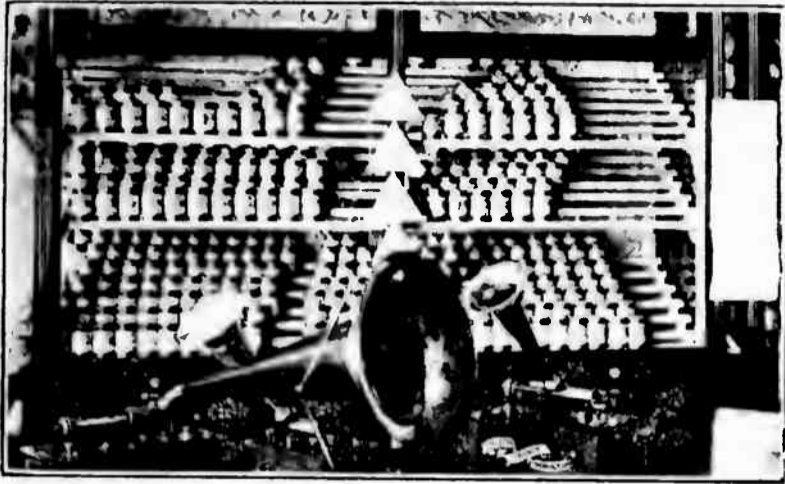

Fig. 8. Part of the Records removed to show construction of Record rack, 7 steps deep, 3 sections high, built inside jeweler's side case. Capacity, 675 Records. The two large glass slide fronts are now raised as high as they will go.

shelving, each having four steps, will hold about 300 Records.

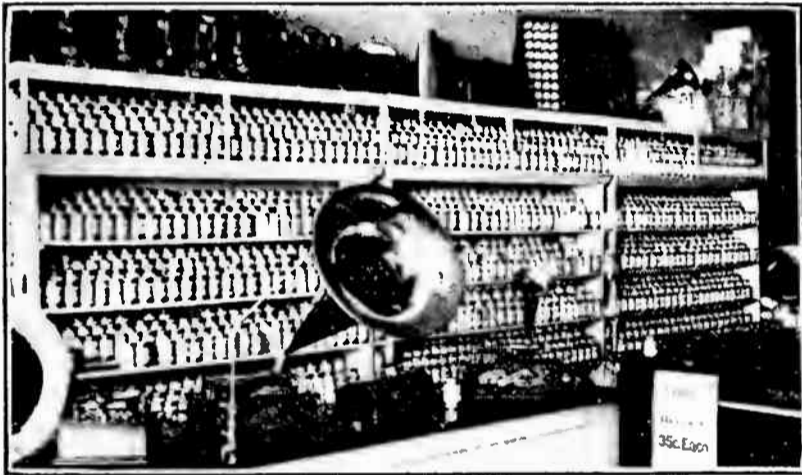

Fig. 9. Step shelving in Grinnell Bros.' branch store at Kalamazoo, Mich. Capacity, 2,000 Records. (They carry several hundred surplus also).

AN IMPORTANT CHANGE.

The following notice was on June 30 mailed to all Edison Jobbers:

TO ALL JOBBERS.

Notice of change in Delivery Clause of Jobber's Agreement, Form No. 585, dated July 18th, 1904,

To take effect July 1st, 1905.

All shipments are made f. o. b. Orange, N. J., at purchaser's risk.

On shipments of one hundred pounds or more made from factory, Orange, N. J., VIA ROUTING SELECTED BY US, freight will be allowed to any city in the United States in which a Jobber is located. If routing is dictated by Jobber, any increase in charges caused thereby will have to be paid by the Jobber.

If shipment is made from Chicago Office, delivery will be f. o. b. Chicago.

All allowances for freight charges will be made on receipt of paid freight bills.

Yours very truly,

W. E. GILMORE,

June 30, 1905.

President.

This is one of the most important announcements ever made by the National Phonograph Co. Its effect upon the trade will be far-reaching. It means that every Jobber and Dealer in Edison goods, no matter where located in the United States, will pay the same price for Phonographs and Records and

will be able to realize the same profit on them. It means that the East will have no advantage over the West. It means the removal of a cause of much dissatisfaction and trouble. It means the opening up of new territory, and it means, as a whole, a greater success for all making or selling Edison goods. The cost to us of this change will be heavy, but we believe that it will in the end be profitable.

THE EDISON ON TOP.

SAN ANGELO, Texas, July 12, 1905.

Accept my thanks for the PHONOGRAPH MONTHLY, which I find very interesting and of service in keeping me posted. The pie-plate machine man has been here, but has not done anything, as the town has gone wild on Edison machines, because they are so much more clear, don't scratch, and have no needles to change with every record. When I heard this agent was in town, I invited him to bring in his machine and set it up along side of our Edison Standard, but he said, "No; your Edison is very fine and clear." He then said: "Won't you play for me that clarinet solo 'Nellie Gray' I heard you play a few minutes ago, for it's a beauty, the finest thing I ever heard." Then turning to the audience he said: "That music is wonderful, and the man who invented that machine is the greatest man living to-day." To all of which I said amen. You would be surprised to see the interest manifested by the cowboys, teamsters, clerks, boys, merchants, stockmen and others when we give an Edison concert. It is certainly wonderful to notice the facial expressions, and the interest displayed. Why, a cowboy will climb up on the table, sit down on his heels, or cross his legs like a tailor, and gaze intently into the horn, while his associate cowboys gather on either side of the table in a continuous line and look into the horn for the singer. The Edison Phonograph is certainly on top out here, and every one sold helps to sell another.

S. L. S. SMITH.

FOREIGN CUT OUTS.

Notice is hereby given to the trade that we have no moulds or masters of the following foreign selections, and orders for them cannot be filled. These numbers appear in the Foreign Catalogue, Form 720, to appear this month, but they will be cut out with the next edition:

12495 O Paradiso Africana (Italian) Sala
12810 Wacht am Rhein (German) Muench

In the June issue of the PHONOGRAPH MONTHLY we printed a list of selections dropped from the Foreign Record Catalogue. This list included No. 12933, "Bravo Dublin Fusiliers," by the British Military Band. We have since discovered that this should not have been cut out, for we still have moulds of the selection and it will be restored to the Foreign Catalogue when again printed.

EFFECTIVE WINDOW DISPLAY.

"The old axiom, that 'Goods well displayed are half sold,' was never so applicable as it is in the case of Edison Records and machines," writes W. J. Killea, a Dealer in Albany, N. Y., who carries the full line of Edison domestic and foreign Records. "For some time I have noticed people coming in my store and asking, 'Have you got German Records?' I hit upon a window display scheme which certainly is a perfect illustration of the Edison phrase 'Edison Records Echo All Over the World.'

"All that is necessary is about thirty-five cents worth of silk ribbon about a quarter of an inch wide, (you can buy it for about one and a half cents a yard) and a map of the world. Hang the map in the window about a yard above the window flooring and about a foot back from the glass front.

"If you have the stock, the window display will sell them, if you have any kind of a location. Take, for instance, the German Records. Locate Germany on the map and cut a slit in the map at this point just large enough to pass the ribbon through it. Then take a German Record, preferably "Der Watch Am Rhien," with the name marked on the Record. Lead the ribbon down from the map inside the Record. Then place in front of the Record a small card inscribed 'RECORD FROM GERMAN-Y.' The Record, of course, must be placed as near the window front as possible, so passersby can read the name on the Record and see that it really is a German Record. With these foreign Records stretched along the front of the window and the ribbons leading down from the map, it makes a very pretty and effective display.

"In the center of the window may be placed a half-dozen Edison domestic Records with a card inscribed, 'A Bunch of American Beauties.' Have three ribbons lead from the United States on the map down into this group of American Records. The ribbons should be red, white and blue. Records for this group should be Nos. 4, 8818, 92, 2, 8971, 8135 and 8221.

"My most effective window display was an exhibit of the Edison gold moulding process. I showed a model of the Edison vacuum process and the electrotyping bath, together with a perfect copy of an Edison gold mould. As this exhibit was the result of considerable experimenting on my part I do not care to explain how all the details were worked out. However, anybody who will go into the matter and find out how to do it will certainly find that it will pay them for their trouble. I brought the people from miles to see that Edison gold mould, which I advertised as a free exhibit in my window.

"As a backing for the foreign Record display, described above, a pyramid built to hold on each step a specimen of each type of the Edison Phonograph makes the display doubly effective in that it sells then both machines and Records."

JUST THE THING FOR DANCING.

"We have organized a dancing club here called the Social Few, which has a private dance two nights a month," writes Will Barden, a Dealer at Edgertown, Wis. "We have

the complete list of dance Records, made only by you, and the time we have is a topic talked of by the whole crowd, and all say it is the finest dance music they ever heard. Our hall is 40x50 feet, and the Phonograph is just the thing. We use a Home with a 56-inch horn. I have sold several machines and not a fault is found in any of them. Also lots of Records. You see by heading of letter I am in the photographic business also. Well, when we get a restless child we start the machine and every thing is smooth sailing. It also livens up the older people, and we get better expressions while the machine is going."

ABOUT PREMIUM MACHINES.

J. H. Lepper, an Edison Dealer at Mason City, Iowa, sends the following interesting letter concerning the manner in which he routed the company which gives away a cheap talking machine and sells records at fifty cents each:

My first advertisement sent the local manager to Chicago to try and head me off. I got threatening letters from their so-called attorney, but the bluff did not work and I kept sawing "Edison" wood, using plenty of printer's ink and pushing the Edison goods, sending advertising matter to all people who had gotten one of their machines. As a consequence I sold several Edison standard outfits, taking in the premium machine at \$2. In doing so I soon placed such a low value on the premium machine that people as a general rule thought it only a toy and not worth having, and came to investigate my Edison Phonographs and Records. I also now have a scheme whereby I furnish these owners of the premium machines with Edison Records to fit their machines, and have a nice sale on our Records, sending them to all parts of the country in this section of the State where these machines are used. I have had the pleasure of a call this week from the manager of the concern at Chicago, calling on me to please let up on them, that I am ruining their business in this State. He says they sell their goods from Maine to California but have never had as much trouble as I have caused them. He said he was having trouble with his local man here and would have to go to law with him to settle it just on account of what I had done.

The premium machine concern guaranteed the local man protection in his deal, saying no one else could get the machines or records, but at the same time I was selling Edison Records at 35 cents, while they charged their customers (who wished to buy) 50 cents each for records.

The local man has thrown up the whole deal and Mr. Chicago man has been obliged to take his outfit and go, for none of the other local dealers will have anything to do with it.

If any Edison Dealers who read this have premium machines in their town and want to get rid of them, I will give them full particulars if they will write me.

I wish to say another word in behalf of the Edison Phonographs and the National Phonograph Co. I never as yet had a person come in my store and say they could buy a machine or a Record for less than list prices, and I have never sold a single Record or machine at one cent less than list price. On the other hand I have the agency of what is considered the best disc talking machine on the market and the prices are cut all to pieces on them all over the country. The goods are quoted to me by prospective buyers at prices from wholesale prices up to list. I am thoroughly disgusted with them and only sell them when my customer will have nothing else. Owing to the lack of protection this concern has given me, I have lost \$400 worth of business by having jobbers and others selling consumers at wholesale prices for single machines. While on the other hand I have gained business from the National Phonograph Co. by the protection they have given me and by following up inquiries they have had from this section of the country.

COMMENTS ON EDISON GOLD MOULDED RECORDS FOR SEPTEMBER, 1905.

Two new artists make their first Edison Records in this September list. Herbert L. Clarke, principal cornet soloist in Sousa's Band, plays a cornet duet with John Hazel, cornet soloist of the Edison Military Band. Miss Marie Narelle, the Australian soprano, sings that favorite Irish ballad, "Killarney." Besides these, all the old favorites, Collins, Harlan, Roberts, Murray, Tascott and the others, have selections suited to their particular talents. Edgar L. Davenport has another fine recitation and Hans Kronold is again heard in one of his artistic 'cello solos. The list as a whole is well balanced and contains one or more selections for all tastes.

No. 9074, "Pique Dame Overture," by the Edison Concert Band, is one of Suppe's best and most popular compositions. The flute and clarinet duet introduced is one of the features of the Record, which as a whole is strictly high-class in every respect.

No. 9075, "Down Where the Silv'ry Mohawk Flows," by Harry Anthony, is already a popular hit, having sprung into popularity with the same rapidity as have most of the sectional songs of this kind. The music is written by John and Otto Heinzman and the words by Monroe H. Rosenfeld. It is most effectively sung by Mr. Anthony, who is accompanied by the orchestra. This selection has a pretty melody and the story is the ever-appealing one of

"By the shores of the river she is waiting,
And I'm longing to see my Mountain Rose:
I am going home once more to the lov'd one I adore,
Down where the Silv'ry Mohawk flows."

No. 9076, "Making Eyes," by Collins and Harlan, is a new song by Harry Von Tilzer and Andrew B. Sterling, who are well known as the writers of many big song successes. Its music is of a jingling character and the words are interspersed with a witty dialogue in Collins and Harlan's best vein. This composition is bound to be a big hit in the coming season. The singers are accompanied by the orchestra.

No. 9077, "Swiss Boy," is a cornet duet by Herbert L. Clarke and John Hazel with orchestra accompaniment. This selection gives the theme of the old song, together with the famous variations composed by the late B. C. Bent, the celebrated cornet virtuoso, who was cornet soloist of the late P. S. Gilmore's great band. Mr. Clarke, who plays the duet with Mr. Hazel, is the principal cornet soloist of Sousa's Band. Mr. Hazel is the principal cornet soloist of the Edison Military Band, and will be well remembered as the composer and performer of the cornet solo "Le Secret Polka," (our Record No. 8546).

No. 9078, "Waltzing with the Girl You Love," by Harry MacDonough, is a well-rendered Record of a descriptive waltz song by Evans and Shields, and is sung with orchestra accompaniment. It is a very popular selection, and one for which we have had many calls.

No. 9079, "Chimmie and Maggie at the Hippodrome," by Ada Jones and Len Spencer, describes Chimmie and Maggie's first visit to the New York Hippodrome. Their characteristic comments during the progress of the performance are highly amusing. Chimmie and Maggie are from the Bowery, of course, as their style of conversation plainly indicates. A number of the features of the Hippodrome are given, among them being the "Dance of the Hours" ballet and the battle scene of the "Raiders." The music of the orchestra lends much realism to the portrayal, as does also other incidental effects.

No. 9080, "Melody in F," is a 'cello solo by Hans Kronold, with piano accompaniment, of this most delightful composition by Rubinstein. Mr. Kronold plays it with the same care and artistic interpretation characteristic of all his work. No collection of high-class Phonograph Records will be complete without this one.

No. 9081, "Killarney," by Miss Marie Narelle, introduces a new singer to the admirers of the Phonograph. Miss Narelle comes from Australia. She is a well-known concert singer, having taken part in concerts with the best vocal and instrumental artists in her own country, Great Britain, Europe and America. She has a powerful, well-trained soprano voice of adequate range and agreeable quality. Her rendition for our Record of "Killarney" will be recognized as the work of a finished artist. Her singing is accompanied by the orchestra. The music of "Killarney" was written by M. W. Balfe and the words by E. Falconer.

No. 9082, "The Crucifix" ("Come Ye That Weep"), by Anthony and Harrison, is a tenor and baritone sacred duet too well known to call for description here. It was written by J. Faure and the translation is by F. W. Rosier. This composition is sung by the best church choir soloists. Messrs. Anthony and Harrison have sung it for our Record in a most satisfactory manner. The orchestra accompaniment is an effective feature.

No. 9083, "Washington Greys March," by the Edison Military Band, is a stirring old-time march composed by C. S. Grafulla, of wide fame as a composer and band leader. It was previously listed by us in the old style wax Records and is made over for the Moulded Records in response to many calls for it.

No. 9084, "Nobody," by Arthur Collins, is a coon song that is quite a departure from those recently written, introducing a number of comical situations. The song fits Mr. Collins like a glove. The story is of a coon for whom nobody does nothing, therefore he does nothing for nobody. Nobody told him that the tobacco sauce wasn't catchup, in fact "nobody" told him "nothing," causing him lots of trouble. Mr. Collins brings out the ludicrous points in the song to perfection. He is accompanied by the orchestra. The music of this song is by Bert A. Williams and the words by Alexander Rogers.

No. 9085, "Just Plain Folks," by Ada Jones, is a descriptive song of great human interest and is handled with that finish which characterizes all of Miss Jones' offerings. The

orchestra accompaniment is fit and appropriate, and enhances not only the beauty of the melody and story, but enables Miss Jones to impart to the sentiment of the piece its full scope and meaning. The music and words of this composition were written by Maurice Stonehill.

No. 9086, "Waltz of the Swallows," by the Edison Symphony Orchestra, is a delightful waltz selection, very effectively featuring the oboe. It is a Mexican composition by Chueca and Valverde, and is known to many under its Spanish title "Vals de las Golondrinas."

No. 9087, "Lasca," by Edgar L. Davenport, is a pathetic poem by F. Desprez. It tells of the affection of Lasca for her lover of the plains. She was ever at his side and ever seeking to protect him. She would hunger that he might eat; she would take the bitter and leave him the sweet. One day the herd stampeded on the Rio Grande with Lasca and her lover right in the path of the maddened cattle. They mounted a mustang and endeavored to escape. The herd gained on them and the only chance left was to shoot the mustang and crouch under his body. A shot, and this was done. As the pair fell, Lasca protected the body of her lover so that she bore all the blows of the surging cattle. When the steers had passed, Lasca was dead but her lover lived. Those who have heard Mr. Davenport's recitation of "Jim Bludso," listed last month, will realize how effectively he has made this Record of "Lasca." Chopin's Funeral March is introduced at the close of the selection.

No. 9088, "Just Because I'm from Missouri," by Bob Roberts, is a new coon song descriptive of a colored gentleman's woes just because he was born in Missouri. It is rendered in Mr. Roberts's inimitable style, with the same clear articulation that has been so much admired. He is accompanied by the orchestra. Percy Wenrich wrote the words and music of this song.

No. 9089, "Through Battle to Victory March," by the Edison Concert Band, is a splendid march by F. v. Blon, composer of "Flag of Victory March" (our Record No. 9032.) "Through Battle to Victory March" was previously listed in the old style Records. It was a popular selection and many Phonograph enthusiasts have regretted that it was not before made by the moulded process. It is listed here because of a general demand for it. This composition is known also by its German title, "Durch Kampf zum Sieg."

No. 9090, "Two Little Girls Loved One Little Boy," by Byron G. Harlan, is a sentimental ballad that is fully described by its title. The story is a new idea, and the melody has a very catchy waltz movement. Mr. Harlan sings it in the careful manner characteristic of his solos and he is accompanied by the orchestra. The music of this song was written by J. B. Mullen and the words by Estelle Hillman. It has only just been published.

No. 9091, "You Must Think I'm Santa Claus," is made by Tascott. The success of Tascott in our Record No. 9033, "Shame on You," listed in July, leads us to put out "You Must Think I'm Santa Claus," another coon song in which this artist had made more than

a hit throughout the country. The Record is made with orchestra accompaniment. The music is by Maxwell Silver and the words by Irving Jones. The character of the selection is shown in the chorus as follows:

You must think I'm Santa Claus,
And Christmas comes ev'ry day;
I guess you hear sleigh-bells ringing, babe,
When I comes 'round this way.
If you think I'm a human Christ-mas tree,
You have cer-tain-ly made a frost;
Because I give you presents, honey.
Once in awhile, don't think I'm Santa Claus.

No. 9092, "The Adieu," by Marie Narelle and Harry Anthony, is a soprano and tenor duet with orchestra accompaniment. This is a sentimental composition of the better class and one of the so-called standard kind that live and are always well liked. Miss Narelle's success in making a Record of "Killarney" (No. 9081), referred to above, warranted the belief that she would also be appreciated in duets with an artist of Mr. Anthony's calibre. We are sure that the public will agree with this opinion. The music of "The Adieu" was written by O. Nicolai and the English version of the words by H. Millard.

No. 9093, "The Bells," by Albert Benzler, is a bells solo with orchestra accompaniment. It is a particularly appropriate selection for orchestra bells, both in title and character of music. It differs considerably from bells selections previously listed and has a delightful orchestra accompaniment. That it will increase rather than diminish in popular favor is confidently expected. The music is of a gavotte character and was written by Carlos Mora.

No. 9094, "Little Girl You'll Do," by Irving Gillette, is a sentimental ballad with orchestra accompaniment. This is assuredly one of Mr. Gillette's best efforts. It is a favorite song of this artist, a fact made apparent to the listener of the Record by the extreme care with which it is rendered. It is said that one of next season's biggest drawing attractions is to feature it by having it sung by one of its principal artists, which will add much to the favor in which it is already held. The music is by Alfred Solman and the words by Benjamin H. Burt.

No. 9095, "Give My Regards to Broadway," by Billy Murray, is one of the biggest successes in the musical farce, "Little Johnny Jones," in which it is sung by its composer, George M. Cohan. The song always makes a hit whether sung in or out of the play. We made a Record of it last January, but it was not considered up to our usual standard and was not listed. This will explain why we are apparently late in putting it out. Nothing has been lost, however, by the delay, for the song is now so widely popular that it will be in greater demand than it would have been eight months ago. The song describes the parting of two Yankees in a foreign country. One is coming back to New York and is enjoined by the other to:

Give my regards to Broadway, remember me to
Herald Square;
Tell all the gang at Forty-second street that I will soon
be there;
Whisper of how I'm yearning, to mingle with the old
time throng.
Give my regards to old Broadway and say that I'll be
there ere long.

No. 9096, "Sing Me the Songs of Dixie Land," by the Edison Male Quartette, is another splendid quartette Record with orchestra accompaniment. It is a descriptive composition and tells of the dying soldier boy's desire to have his comrades sing him songs of Dixie land. The verse is done in solo and quartette alternating and the chorus is all in the quartette form. The music and words are by James W. Casey. The chorus is as follows:

Sing me songs of Dixie land, my southern home.
Let me hear the dear old tunes, as far away I roam,
Sing of my Kentucky home, and sing of old Black Joe;
Way down upon the Suwannee River, Dixie's songs of long ago.

No. 9097, "Keep a Little Cosey Corner in Your Heart for Me Medley," by the Edison Military Band, introduces four popular selections from the August list as follows: "Keep a Little Cosey Corner in Your Heart for Me," (our Record No. 9060); "The Message of the Old Church Bell," (our Record No. 9071); "Would You Care," (our Record No. 9070), and "Violette," (our Record No. 9061).

"THE MODERN PROFESSION OF INVENTING."

The World's Work for June contained an interesting article on "The Modern Profession of Inventing." Part of the article referred to Mr. Edison and his work, as follows:

The best-known example of the independent inventor is Mr. Thomas A. Edison. This strange man, so simple in personal appearance and manner, so extraordinary in his habits of life and methods of work, moves among his complicated series of shops and experiments with such mental precision and constructive energy, yet appearing to do so without any sense of order or system—a sort of volcanic intellectual chaos—that he is the despair of all the men who try to analyze him. But he has no sentimental notions about an invention. When an idea occurs to him his first question is, "If it can be done, is it worth anything?" If it will not pay, he has no use for it. Inventing is his business; the things he invents must be worth money.

The instant he decides that the idea is worth while, he sets in motion his extraordinary method of developing it. Some time ago, for example, he needed a chemical mixture that should have two properties that are rarely found together in the same compound. He might have set a chemist to work to figure out from the known science of chemistry what would be most likely to fill the requirements, and so narrow the problem down to one of trying a few chemicals. What he did was to take Watts's Chemical Dictionary, in several ponderous volumes, and have his assistants make every chemical mixture in it that could even conceivably serve his purpose, and try every one of the thousands.

"Out of the lot, I found about seven compounds that worked," said Mr. Edison, "but when I finished the experiments I knew beyond a doubt that those seven were the only ones that could be made for that purpose."

He became interested in radium. The scientists had described certain substances as being those in which the presence of radium could be detected by sensitive photographic plates. Mr. Edison was not satisfied. He took 7,000 plates, put a sample of fifty different substances on each plate, and locked them up for seven weeks in a dark room. At the end of that time he had the plates developed and found that practically every one of the 350,000 specimens showed traces of the presence of radium.

This, then, is his method—to take nothing for granted, to believe that anything may be possible, and then to try everything conceivable in the hope of hitting on what he needs. To see him moving through his great laboratories, head bowed, hands in pockets, his face set in an expression of intense mental preoccupation, his hair carelessly combed which

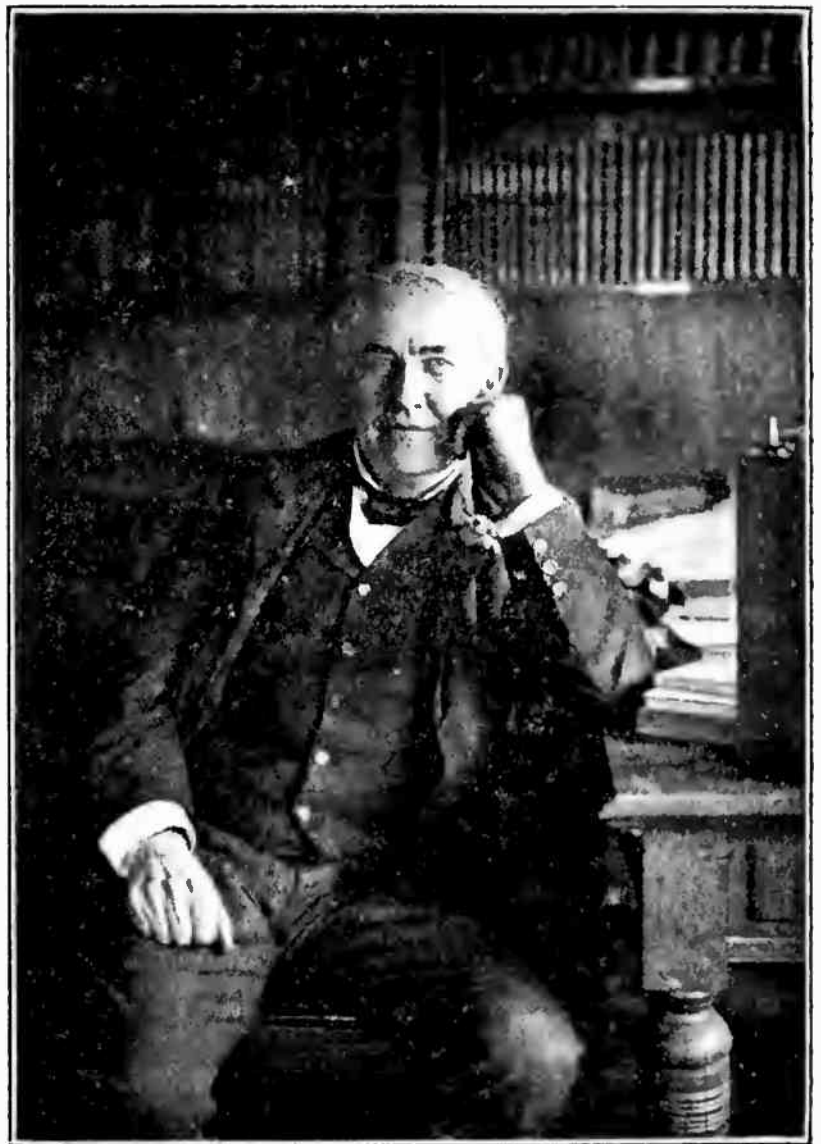

Courtesy of The World's Work.

THOMAS A. EDISON.

ever way it may please to fall, his eyes focussed miles away except when he flashes into some one else's a look of instant understanding, his whole appearance, except for the eyes and the humorous yet grim mouth, is that of a dreamer rather than of a tireless worker. Yet this is the man who, eating practically nothing and exercising not at all, works often for thirty-six hours without sleep, falls unconscious from exhaustion on bench or desk, and wakes to work again, sometimes for a week without undressing; electrical with mental energy; marvelous in the power of his inventive imagination. This is the popular idea of what an inventor is—a man of dreams and action in one, possessed by an idea that

harasses him until it be delivered in finished form.

Mr. Edison has very definite ideas about inventing as a profession. When asked to describe the personal qualifications and the type of mind necessary for an inventor, Mr. Edison said:

"The point in which I am different from most inventors is that I have, besides the usual inventor's make-up, the bump of practicality as a sort of appendix, the sense of the business, money value of an invention. Oh, no, I didn't have it naturally. It was pounded into me by some pretty hard knocks. Most business, money value of an invention. Oh, think whether their invention will be salable when they get it made. Unless a man has plenty of money to throw away, he will find that making inventions is about the costliest amusement he can find. Commercial availability is the first thing to consider.

"In working out an invention, the most important quality is persistence. Nearly every man who develops a new idea works it up to a point where it looks impossible, and then he gets discouraged. That's not the place to get discouraged, that's the place to get interested. Hard work and forever sticking to a thing till it's done, are the main things an inventor needs. I can't recall a single problem in my life, of any sort, that I ever started on that I didn't solve, or prove that I couldn't solve it. I never let up until I had done everything that I could think of, no matter how absurd it might seem as a means to the end I was after. Take the problem of the best material for Phonograph Records. We started out using wax. That was too soft. Then we tried every kind of wax that is made, and every possible mixture of wax with hardening substances. We invented new waxes. There was something objectionable about all of them. Then somebody said something about soap. So we tried every kind of soap. That worked better, but it wasn't what we wanted. I had seven men scouring India, China, Africa; everywhere, for new vegetable bases for new soaps. After five years we got what we wanted, and worked out the Records that are in use to-day. They are made of soap—too hard to wash with and unlike any other in use, but soap just the same.

"The second quality of an inventor is imagination, because invention is a leap of the imagination from what is known to what has never been before.

"The third essential is a logical mind that see analogies. No! No! not mathematical. No man of a mathematical habit of mind ever invented anything that amounted to much. He hasn't the imagination to do it. He sticks too close to the rules, and to the things he is mathematically sure he knows, to create anything new. I don't know anything about mathematics; can't even do proportion. But I can hire all the good mathematicians I need for \$15 a week."

This last point is illustrated by an incident that occurred in his laboratory. He needed to know the exact capacity of a vessel of very irregular shape. He called in two of his mathematicians to work it out. They made innumerable careful measurements with various finely graduated instruments, and after an

hour's work went away with a mass of figures to work out the capacity. As soon as they had left, Mr. Edison filled the vessel with water, poured the water out into a measure, and noted how many cubic inches it held. Two days later the mathematicians brought in the result of their complicated figuring, and it tallied exactly with Mr. Edison's five-minute measurement.

In the practice of his profession Mr. Edison has to save time. There is a pretty well developed suspicion among his assistants that his deafness is largely a ruse to avoid hearing things that he does not care to pay attention to. When Mr. Edison sat for the photograph at the front of this magazine, in one of the poses his eyes were dropped, looking at his hands. It was a time exposure, and the instant the shutter of the camera closed with a click he looked up and exclaimed "Over-exposed." His attorney shouted to him:

"Did you hear that click?"

"Eh?"

"How did you know that he had finished that exposure?"

"Oh, I had an intuition."

To Mr. Edison, time is so valuable that he does not waste it even by taking account of it. Time to him is only the chance to get things done: and no matter how long it takes, they must be got done. In his office safe there is carefully locked away a \$2,700 Swiss watch, given him by a European scientific society. It is never used. He buys a stem-winder costing a dollar and a half, breaks the chain ring off, squirts oil under the cap of the stem, thrusts it into his trousers pocket—and never looks at it. When it gets too clogged with dirt to run, he lays it on a laboratory table, hits it with a hammer and buys another.

Where a man in the profession of law or of medicine has a suite of offices, Mr. Edison's Time to him is only the chance to get things many laboratories. In this building are many rooms set apart for different kinds of experiments. In one, an assistant who came to him in 1889 from the laboratory of the German scientist, Helmholtz, works alone, or with his sub-assistants, on Phonograph improvements. Mr. Edison may not see him for two weeks at a stretch, but when he does come, he is full of enough ideas to keep the room busy for a month. In another room is his chief chemist, himself an inventor of proved merit, working out Mr. Edison's ideas on some new chemical compound. Across the hall, in a room filled with batteries, each of a different composition, two men and a boy are taking records of how the batteries work. In another room, improvements are being worked out for Mr. Edison's new storage battery. There are often a dozen inventions under way at once, each requiring the work of an expert; and through the great laboratory Mr. Edison move from room to room, keeping check on the progress of each, suggesting radical changes in the work, always full of ideas, and impressing so profoundly on his men his own mental curiosity, and eagerness, and energy that they, as they say themselves, work much harder for him than they would on their own ideas.

Mr. Edison's power of rapid assimilation of the meat in any point discussed is one of the most valuable parts of his professional equip-

ment. An instance, chosen from many of the kind, illustrates how it serves him. On one occasion he started to study a part of the mechanism of typewriters.

"Have a model here next Tuesday of every typewriter made," he said to one of his assistants. "Have each company send an expert to explain their machine. And get me out all the books in the library about this piece of the mechanism."

Monday evening the assistant called Mr. Edison's attention to a stack of books several feet high, and reminded him of the appointment next day.

"Send the books up to the house. I'll look them over to-night," said Mr. Edison.

The next morning he appeared at the exhi-

bition, and so thoroughly had he read the books that he frequently corrected the experts' explanation of how their own machines worked. The assistant, out of curiosity, tried reading the references that Mr. Edison had absorbed in one evening, and it took all his spare hours for eleven days.

The result of Mr. Edison's professional activity as an inventor are about 800 patents allowed him by the Government. He takes out an average of one patent every two weeks. At present he is working out experiments with the chemicals used in batteries, improvements on his Portland cement, improvements on his storage battery, and a number of ideas that are not yet far enough developed to be published.

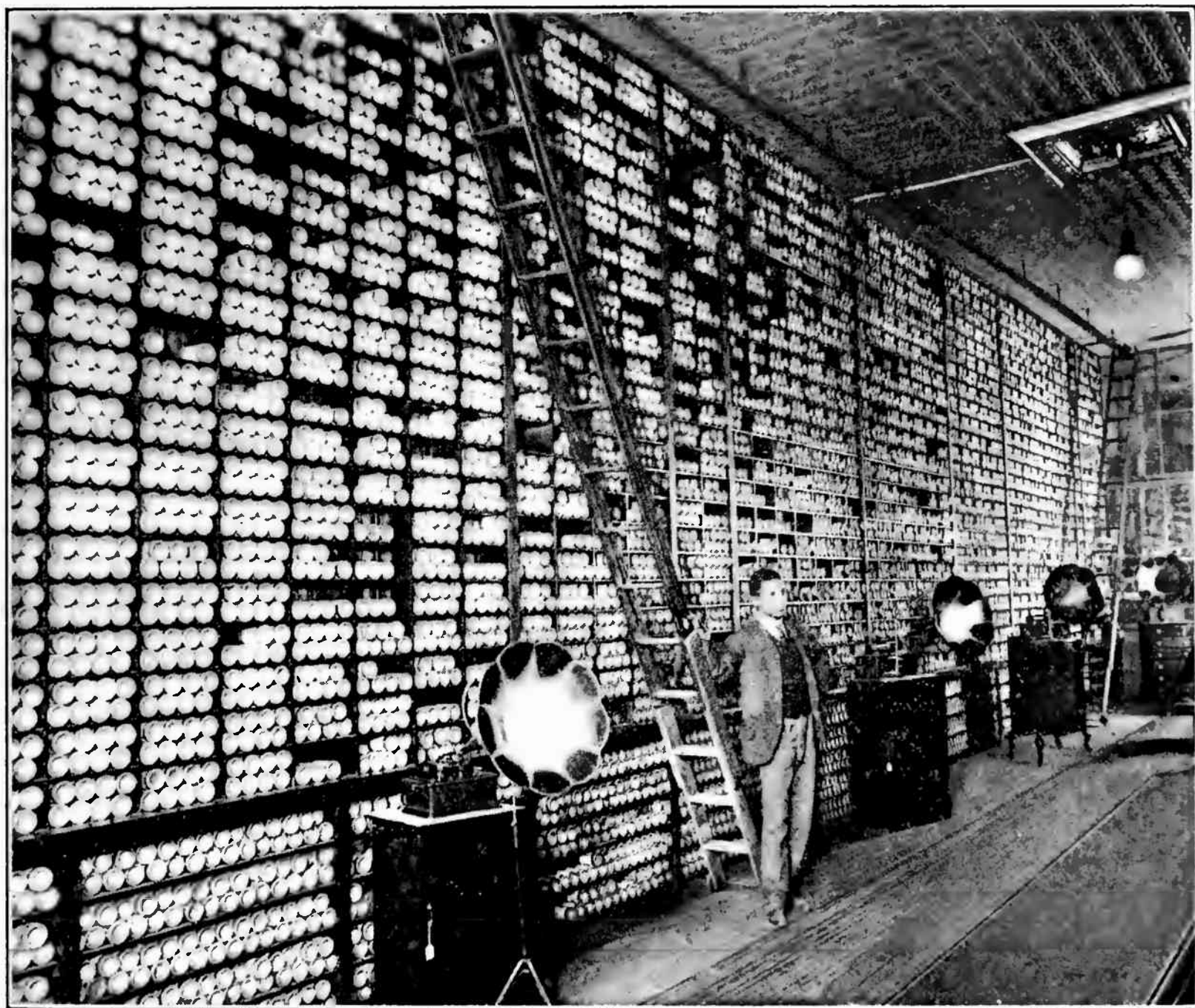

PHONOGRAPH DEPARTMENT OF THE THEO. F. BENTEL CO., PITTSBURG.

At our request the Theo. F. Bentel Co. sent us the following description of the above department:

"We believe we can say without any hesitancy that we show the largest stock of Edison Records for retail exclusively in this section. Traveling men in the trade say that our retail department is the largest they visit. We give you the dimensions as follows: Length of shelving, 96 feet; height, 14 feet; capacity of each bin, 12 Records. According to estimate, from the ceiling down to the base, which is arranged numerically, the capacity is 28,800 Records. Capacity of latter space, 4,600, from

which you will see we show over 30,000 Records in the retail department.

"In our wholesale department, which occupies the second floor, the racks are arranged largely on the same basis and will hold 50,000 Edison Records. At the present writing we believe our stock of Edison Records alone will average about 70,000. It is our aim to carry not less than twenty-five in the wholesale. From this you will see that we are in a position to give the best service possible. Our almost nine years' experience in the talking machine business enables us to appreciate the wants of the trade and we believe we are in a position to do so.

JOBBERS OF EDISON PHONOGRAPHS AND RECORDS.

ALABAMA.

Birmingham—Talking Machine Co., 2007 Second ave.
Mobile—W. H. Reynolds, 167 Dauphin street.
Montgomery—R. L. Penick, 119 Dexter ave.

CALIFORNIA.

San Francisco—Peter Bacigalupi, 786-788 Mission street.

COLORADO.

Denver—Denver Dry Goods Co., 619 16th street.

CONNECTICUT.

Middletown—Caulkins & Post Co., 405-408 Main street.
New Haven—Pardee-Ellenberger Co., 155 Orange st.

DISTRICT OF COLUMBIA.

Washington—E. F. Droop & Sons Co., 925 Pennsylvania avenue, N. W.
 S. Kann Sons & Co., 8th and Pennsylvania avenues.

GEORGIA.

Atlanta—Atlanta Phonograph Co., 49 Peachtree St.
Waycross—George K. Youmans.

ILLINOIS.

Chicago—James I. Lyons, 192 Van Buren street.
 Siegel, Cooper & Co., 281 State street.
 Talking Machine Co., 107 Madison street.
 The Vim Co., 68 E. Lake street.
 Montgomery Ward & Co., 111 Michigan ave.
 Rudolph Wurlitzer Co., 302 Wabash ave.

Peoria—Peoria Phonograph Co., 222 Bridge street.
Quincy—Quincy Phonograph Co., 808 Hampshire st.

INDIANA.

Indianapolis—Craig Jay Co., 234 Massachusetts ave.
 Kipp Bros. Co., 37 S. Meridian street.
 A. B. Wahl & Co., 119 S. Illinois street.

Lafayette—A. B. Wahl & Co., 304 Main street.

IOWA.

Des Moines—Hopkins Bros. Co., 620 Locust street.
 Vim Co., 704 West Walnut street.

Fort Dodge—Early Music House, 822 Central ave.

KENTUCKY.

Louisville—C. A. Ray, 640 Fourth street.

LOUISIANA.

New Orleans—William Bailey, 600 Frenchman street.
 National Automatic Fire Alarm Co.,
 614 Gravier street.

MAINE.

Bangor—S. L. Crosby Co., 186 Exchange street.
Portland—W. H. Ross & Son, 207 Commercial street.

MARYLAND.

Baltimore—E. F. Droop & Sons Co., 109 N. Charles St.

MASSACHUSETTS.

Boston—Boston Cycle & Sundry Co., 48 Hanover street.
 Eastern Talking Mach. Co., 177 Tremont st.
 Iver Johnson Sptg. Goods Co., 163 Washington street.

C. E. Osgood Co., 744 Washington street.
 Read & Read, 558 Washington street.

Fitchburg—Iver Johnson Sptg. Goods Co., 247 Main st.

Lowell—Thomas Wardell, 111 Central street.

New Bedford—Household Furnishing Co., 170 Purchase street.

Springfield—Flint & Brickett Co., 439 Main st.

Worcester—Iver Johnson Sptg. Goods Co., 304 Main st.

MICHIGAN.

Detroit—American Phono. Co., 106 Woodward ave.
 Grinnell Bros. 219 Woodward ave.

Saginaw—Morley Bros.

MINNESOTA.

Minneapolis—Thomas C. Hough, 714 Hennepin ave.

St. Paul—W. J. Dyer & Bro., 21-23 West 5th street.

Thomas C. Hough, 392 Wabasha street.

Minnesota Phonograph Co., 37 E. 7th street.

MISSOURI.

Kansas City—J. W. Jenkins' Sons Music Co., 1013-1015 Walnut street.

J. F. Schmelzer & Sons Arms Co., 710 Main street.

St. Louis—Conroy Piano Co., 11th and Olive streets.

O. K. Houck Piano Co., 1118 Olive street.

Western Talking Machine Co., 923 Olive st.

NEBRASKA.

Lincoln—H. E. Sidles Cycle Co., 1317 O street.

Omaha—Nebraska Cycle Co., 15th and Harney streets.
 Omaha Bicycle Co., 16th & Chicago sts.

NEW JERSEY.

Hoboken—Eclipse Phono. Co., 205 Washington st.

Newark—A. O. Petit, New and Halsey streets.

Paterson—James K. O'Dea, 117 Ellison street.

Trenton—Stoll Blank Book and Stationery Co., 30 E. State street.

John Sykes, 105 N. Broad street.

NEW YORK.

Albany—Finch & Hahn, 92 State street.

Brooklyn—Chapman & Co., Fulton and Duffield streets.

A. D. Matthews' Sons, 394 Fulton street.

Price Phonograph Co., 1260 Broadway.

Buffalo—P. A. Powers, 613 Main street.

Elmira—Elmira Arms Co., 117 Main street.

Gloversville—American Phono. Co., 99 W. Fulton st.

Kingston—Forsyth & Davis, 307 Wall street.

New York City—Bettini Phono Co., 156 W. 23d street.

Blackman Talking Machine Co., 97 Chambers street.

J. F. Blackman & Son, 2737 3d avenue.

Sol Bloom, New Amsterdam Theatre Building.

I. Davega, Jr., 802 Third avenue.

S. B. Davega, 32 E. 14th street.

Douglas Phono. Co., 89 Chambers st.

H. S. Gordon, 139 Fifth avenue.

Harry Jackson, 219 Bowery.

Jacot Music Box Co., 39 Union Square.

Victor H. Rapke, 1661 Second avenue.

Siegel-Cooper Co.

John Wanamaker.

Alfred Weiss, 1525 First avenue.

Oswego—Frank E. Bolway, 32 Bridge street.

Poughkeepsie—Price Phonograph Co., 203 Main st.

Rochester—A. J. Deninger, 345 North street.

Mackie Piano, O. & M. Co., 100 State street.

Giles B. Miller, 63 State street.

Talking Machine Co., 97 Main st., E.

Schenectady—Finch & Hahn, 456 State street.

Jay A. Rickard & Co., 253 State street.

Syracuse—W. D. Andrews, 216 E. Railroad street.

Troy—Finch & Hahn, 7 Third street.

Utica—Clark-Horrocks Co., 54 Genesee street.

Arthur F. Ferriss, 89 Washington street.

William Harrison, 41 Columbia street.

Utica Cycle Co., 31 Columbia street.

OHIO.

Canton—Klein & Heffelman Co., 216 N. Market street.

Cincinnati—Ilsen & Co., 25 W. 6th street.

Rudolph Wurlitzer Co., 10-12 W. 4th st.

Cleveland—Eclipse Musical Co., Jr., Erie and Huron sts.

Columbus—Perry B. Whitsit Co., 213 S. High street.

Dayton—Niehaus & Dohse, 35 E. 5th street.

East Liverpool—Smith & Phillips Music Co.

Newark—Ball-Fintze Co.

Toledo—Hayes Music Co., 608 Cherry street.

PENNSYLVANIA.

Allegheny—Henry Braun, 500 Federal street.

Allentown—G. C. Aschbach, 539 Hamilton street.

Easton—William Werner, 401 Northampton street.

Harrisburg—S. K. Hamburger, 12-14 N. Market sq.

New Castle—W. C. DeForeest & Son.

Philadelphia—C. J. Heppe & Son, 1117 Chestnut street

Lit Bros., Market and 8th streets.

Penn Phonograph Co., 17 S. 9th street.

John Wanamaker, 13th and Market sts.

Wells Phonograph Co., 41 N. 9th street.

Western Talking Mach. Co., 25 S. 9th st.

H. A. Weymann & Son, 923 Market st.

Pittsburg—Theo. F. Bentel Co., Inc., 632 Liberty street.

Kaufmann Bros., Fifth avenue.

H. Kleber & Bro., 221 Fifth avenue.

C. C. Mellor Co., 319 Fifth avenue.

Pittsburg Phono. Co., 937 Liberty street.

Reading—Reading Phonograph Co., 809 Penn street

Scranton—Ackerman & Co., 130 Wyoming avenue.

Technical Supply Co.

RHODE ISLAND.

Pawtucket—Pawtucket Furniture Co., 39 N. Main St.

Providence—J. M. Dean Co., 785-795 Westminster street.

J. A. Foster Co., Weybosset st.

Household Furniture Co.

J. Samuels & Bro., 154 Weybossett street.

A. T. Scattergood & Co., 106 N. Main st.

TENNESSEE.

Knoxville—Knoxville Typewriter and Phonograph

Co., 311 Clinch street.

Memphis—O. K. Houck Piano Co., 359 Main street.

F. M. Atwood, Lyceum Building.

Nashville—Nashville Talking Mach. Co., 510 Church st.

Magruder & Co., 13 Arcade.

Continued on page 15.

JOBBER'S OF EDISON PHONOGRAPHS AND RECORDS—Continued.

TEXAS.

Dallas—Southern Talking Machine Co., 347 Main st
 *El Pas—W. G. Walz Co., 101 El Paso street.
 Fort Worth—Cummings, Shepherd & Co., 700 Houston st
 Houston—Texas Phono. Co., Capitol and Fannin Sts.

VIRGINIA.

Richmond—Magruder & Co., 729 E. Main st.

WISCONSIN.

Milwaukee—McGreal Bros., 173 3d street.

CANADA.

Toronto—R. S. Williams & Sons Co., Limited,
 143 Yonge street.
 Winnipeg—R. S. Williams & Sons Co., Ltd., 121 Princess street.

*Added since July 1, 1905.

SUSPENDED LIST, JULY 1, 1905.

SUPERSEDING ALL PREVIOUS LISTS.

ILLINOIS.

Chicago—H. E. Everett, 6134 S. Halsted street.
 Ottawa—Edward Hayne.
 Wheaton—E. Irving.

INDIANA.

South Bend—EUGENE MARSH, 126 Vistula avenue.
 SOUTH BEND BOOK BINDERY, Robert
 Lebolt, Prop., 203 North Michigan street.

IOWA.

Burlington—JOHN P. WEISS, 711 Jefferson street.
 Sioux City—HATTENBACH BROS. CO.
 *A. V. LARIMORE, 518 Fifth street.

KANSAS.

Clay Centre—E. M. GOWENLOCK.
 Lawrence—BELL BROS.

MAINE.

Biddeford—W. H. FIELD.
 Monmouth—G. H. STETSON.

MASSACHUSETTS.

Boston—T. SINGER, 60 Leverett street.
 Lawrence—LORD & CO., 314 Essex street.
 E. O. MOSHER, 420 Essex street.
 Lynn—ELIAS DEYOUNG.
 Malden—A. T. FULLER.
 Nantucket—ARTHUR M. TAYLOR.
 New Bedford—H. B. DEWOLFF.
 Somerville—E. J. WINCHESTER, 32 Summit avenue.
 Woburn—OSBORN GILLETTE, or THE BOLTON
 JEWELRY CO., L. F. Maloney, Manager.

MICHIGAN.

Detroit—F. J. SCHWANKOVSKY.
 Saginaw—GEO. W. EMENDORFER.
 JAMES V. CALAHAN, 217 Genessee st.
 TIERNEY BROS., 217 Genessee st.

MISSOURI.

Kansas City—THE WITTMANN CO.

NEBRASKA.

Lincoln—THE WITTMANN CO.
 Omaha—THE WITTMANN CO.

NEW HAMPSHIRE.

Hillsboro Bridge—E. M. BARNES.
 Manchester—A. E. DUMAS
 Nashua—F. A. McMASTER & CO.

NEW JERSEY.

Atlantic City—SAM'L D. WOLF, 32-34 Arkansas ave.
 Bayonne—I. WIGDOR, 450 Avenue D.
 Jersey City—W. L. HOFFMAN, 151 Montgomery st.
 Newark—R. L. CORWIN; also New York City.
 Passaic—I. HURWITZ.
 Paterson—CHAS. H. KELLY, 25 N. Main street.

Plainfield—S. W. FRUCHT, or R. FRUCHT; also
 New York City.

ELSTON M. LEONARD.

West Hoboken—EMIL HOLLANDER, or THE WEST
 HOBOKEN BICYCLE & PHONO. CO., 619
 Spring street.

NEW YORK.

Albany—G. LINDE, 353 S. Pearl street.
 Bedford Park—GEO. H. TYRRELL.
 Brooklyn *WM. ALBRECHT, 204 Knickerbocker ave.
 *H. HINDERMANN, BUSHWICK PHONO-
 GRAPH EXCHANGE, 1421 Myrtle avenue.
 Hobart—F. H. MARSHALL.
 New York City—A. T. ARMSTRONG, or AMERI-
 CAN PHONO. CO., 100 Wall street.
 AUTOMATIC ZITHER CO., M. Cohen, Prop.,
 58 Second avenue.
 BERN BEARWALD, 373 W. 11th st.
 BRONX PHONO. CO. or DAVID SWITKY,
 506 Willis ave.
 CENTRAL PHONO. CO., 160 E. 42d street.
 R. L. CORWIN; also Newark, N. J.
 EAGLE PHONO. CO., or C. LOWENTHAL,
 83 Nassau street.
 EMPIRE PHONO. CO., 2 W. 14th street.
 S. W. FRUCHT, or R. FRUCHT, 7 Barclay st.,
 or 68 Cortlandt st.; also Plainfield, N. J.
 O. HACKER, 2 Murray street.
 HAWTHORNE & SHEBLE, 297 Broadway;
 also Philadelphia, Pa.
 HOLOBER BROS., 350, 421 and 491 West st.
 N. HORN, 148 E. 58th street.
 W. L. ISAACS, 114 Fulton street.
 S. LEMBURG & CO., 194 Broadway.
 J. McELLYNNE, 202 Broadway.
 RICHMOND PEASE, 44 W. 132d st.
 F. M. PRESCOTT, 44 Broad st.
 WINTHROP CYCLE CO., 2212 Seventh ave.

Rome—CHARLES TUTTLE.

Saratoga—W. J. TOTTEN.

Saratoga Springs—MARVIN A. COTE.

OHIO.

Cincinnati—J. L. ANDEM.
 Coshocton—BURNS & GOSSER.
 Springfield—D. & M. VANDERPOOL.
 Uhrichsville—F. A. MAZURIE.

PENNSYLVANIA.

Philadelphia—A. R. CASSIDY, 2783 Emerald street.
 HAWTHORNE & SHEBLE, 604 Chestnut st., or
 Oxford and Mascher sts.; also New York City.
 A. KROUSE, 832 Arch street.
 PENN NOVELTY CO., 15 South 9th st.

Phoenixville—KEINARD BROS.

Pittsburg—A. LIPPARD, 615 Wylie ave.

RHODE ISLAND.

Providence—F. P. MOORE.

WISCONSIN.

Milwaukee—J. C. BLATZEK.

*Added Since July 1, 1905.

Jobbers and Dealers are asked not to supply any of the above named firms with our apparatus, either at addresses given or any other address.

FUN AND SERIOUSNESS IN DOUBLE SERVICE



AUGUST 1905						
SUN.	MON.	TUE.	WED.	THUR.	FRI.	SAT.
		1	2	3	4	5
6	7	8	9	10	11	12
13	14	15	16	17	18	19
20	21	22	23	24	25	26
27	28	29	30	31		

Send for free literature telling how you can increase your business from 10 to 30 per cent., or send fifty cents for the new I. C. S. language demonstrating record containing extracts from four language lessons on *one cylinder*. Delivered by express prepaid in the United States or Canada. Write us today.

DEPARTMENT OF LANGUAGES
INTERNATIONAL CORRESPONDENCE SCHOOLS
 SCRANTON, PA.

FOR FOREIGN SALES, ADDRESS { Foreign Dept., National Phonograph Co., 31 Union Square, New York City.
 European Headquarters, National Phonograph Co., Ltd., 25 Clerkenwell Road, London, E. C.

EDISON Phonograph Monthly

PUBLISHED FOR TRADE USE ONLY BY
THE NATIONAL PHONOGRAPH CO.

VOL. III. ORANGE, N. J., SEPTEMBER, 1905. No. 7.

NATIONAL PHONOGRAPH CO.

ORANGE, N. J.

NEW YORK: 31 UNION SQUARE.

CHICAGO: 304 WABASH AVENUE.

SAN FRANCISCO: 786 MISSION STREET.

NATIONAL PHONOGRAPH CO., LTD., 25 CLERKENWELL
ROAD, LONDON, ENG.

EDISON PHONOGRAPHS AND RECORDS.

All communications to THE PHONOGRAPH MONTHLY
should be addressed to the Advertising Department,
Orange, N. J.

C O N T E N T S

Be Ready When Business Comes.....	1
Advance List of Edison Gold Moulded Records for October, 1905.....	2
New Record Box.....	3
An Attractive Folder.....	3
Dealers Should Advertise.....	3
Dealers Must Get Printed Matter from Jobbers	4
Among the Jobbers	4
Printed Matter	4
Music Dealers Injuring Themselves.....	4
Records and Copyright	5
A Follow-Up Letter	5
Mexican Records	5
The Phonograph	6
The Phonogram	6
Song the Hand Organ Played.....	6
Comments on October Records.....	7
Thomas Alva Edison (An Interview)....	9
July, 1904, Phonogram Reprinted.....	12
Phonograph Section of Store of the Werner Music Co., Easton, Pa.....	13
Notice to the Trade	13
Southern Dealers' Announcement	13
Visitors from India	13
Jobbers of Edison Phonographs and Records	14
Suspended List for September.....	15

BE READY WHEN BUSINESS COMES.

Every Jobber and Dealer in Edison Phonographs and Records who sincerely desires to get a fair share of the business in these goods in the coming fall and winter must at once give careful and serious consideration to the subject, if he has not already done so. So far as the thermometer is concerned, it is still summer, but fall is but a few days away, and when it comes it is going to bring a demand for Edison goods that will astonish even the most optimistic. Aside from the efforts being made by this company to exploit its product, the Edison Phonograph and Edison Gold Moulded Records have jumped into a popularity that has amazed the entire trade. The peculiar merits of both have swept aside much of the prejudices of the past and have caused the public to realize that the Edison Phonograph is infinitely better than they deemed it possible for a "talking machine" to be. This awakening to the improvements in the Phonograph made by Mr. Edison in the past few years is responsible for much of the present phenomenal demand for Edison goods, and this demand is going to continue with added strength as the weeks pass by. The installation of an Edison Phonograph in a home is almost invariably followed by the sale of others in the same neighborhood. It is so much better than the kind the neighbors had previously heard that they cannot resist the desire to own one. Every Dealer has seen this happen. Every Dealer knows that his greatest difficulty is to get a prospective customer to hear the Phonograph, for once heard it will sell itself and it is a most active salesman for all time.

These remarks are simply to point the way and arouse the slumbering Dealer to the necessity for immediate action. Edison Dealers who are in the business to make money should foot up the biggest month that they have had this year and add fifteen per cent. to it as a

THE ADVANCE LIST OF OCTOBER RECORDS APPEARS ON PAGE 2.

NEW EDISON GOLD MOULDED RECORDS. ADVANCE LIST FOR OCTOBER, 1905.

RECORDS listed below will be ready for shipment as near October 1st as possible, at which time Jobbers' stock orders, if received prior to September 10th, will be shipped. October Supplements will be forwarded to Jobbers with their stock order for Records. Retail Dealers should place stock orders with their Jobbers at once, to insure prompt shipment as soon as Jobbers' stock is received.

- 9098 Selection from Chimes of Normandy (*Planquette*) Edison Concert Band
 9099 In Dear Old Georgia (*Van Alstyne*) Irving Gillette
Descriptive song by the composer of "In the Shade of the Old Apple Tree,"
Orch. accom.
- 9100 Everybody Works But Father (*Havez*) Bob Roberts
Lew Dockstader's big comic song hit, Orch. accom.
- 9101 Robin Adair (*old Scotch air*), Herbert L. Clarke and Leo Zimmerman
Cornet and trombone duet, Orch. accom.
- 9102 I Wait for Thee (*Hazley*) Sentimental song, *Orch. accom.* Theo. Van Yorx
 9103 The Village Seamstress (*Adaptation—Wiggin*) Miss Elene Foster
Humorous monologue
9104. Making Eyes Medley Albert Benzler
Xylophone solo, Orch. accom., introducing "Making Eyes," "Waltzing With
the Girl You Love," "Come Along, Little Girl, Come Along,"
and "Give My Regards to Broadway"
- 9105 A Picnic for Two (*Albert Von Tilzer*) Harry MacDonough
Serio-comic song, Orch. accom.
- 9106 Fishing (*Vaudeville Sketch*) Ada Jones and Len Spencer
A summer resort flirtation scene with Orchestra incidental music and effects
- 9107 The Whistler and His Dog (*Pryor*) Edison Military Band
Arthur Pryor's new caprice
- 9108 I'll be Waiting in the Gloaming, Sweet Genevieve (*Helf*) Byron G. Harlan
Sentimental song from Dockstader's Minstrels, Orch. accom.
- 9109 When the Mists Have Rolled Away (*Sankey*) Anthony and Harrison
Tenor and baritone sacred duet, Orch. accom.
- 9110 New Era Overture (*Heed*) Edison Symphony Orchestra
- 9111 What You Goin' To Do When the Rent Comes 'Round (*Von Tilzer*) Arthur Collins
Coon song, Orch. accom.
- 9112 Angelena (*O'Connor*) Male duet, *Orch. accom.* MacDonough and Biehling
- 9113 Evening on the Plaza (*Siegel*) Mandolin solo (*unaccompanied*) Samuel Siegel
- 9114 My Word (*Hubbell*) Miss Ada Jones
Comic song from the musical comedy "Fantana," Orch. accom.
- 9115 Leader of the German Band (*Morse*) Collins and Harlan
Comic male duet, Orch. accom.
- 9116 Yankee Grit March (*Holzmann*). Edison Concert Band
By the composer of "Uncle Sammy" March
- 9117 Wearing of the Green (*old Irish song*) Miss Marie Narelle
Soprano song, Orch. accom.
- 9118 Hiram Green, Good-Bye (*Chapel*) Billy Murray
Comic song hit from the musical oddity "Kafoozelum," Orch. accom.
- 9119 Musical Yankee (*Vaudeville specialty*) Len Spencer
A musical act introducing witty dialogue and solos by sleighbells, xylophone,
violin, ocarina and cornet, Orch. accom.
- 9120 Hard Times Come Again No More (*Foster*) Edison Male Quartette
Male quartette, Orch. accom.
- 9121 My Maryland March (*Mygrant*) Edison Military Band
Introducing "Maryland, My Maryland"

Edison Gold Moulded Records are made only in Standard Size. Both Standard and Concert Records may be ordered from this list. Order by number, not title. If Concert Records are wanted, give the number and letter C.

basis for their October business. Another fifteen per cent. for November and still another for December. Many Dealers will do better, but every one should at least do as well as this. Dealers should then take account of stock and determine how many more Phonographs and Records are needed to do a business of this size and get busy with their order books. It is equally important to order early. At our factory in Orange we are already arranging to run night and day in order to keep pace, if possible, with the demand that we know is coming. We shall soon be pushing the factory to its utmost capacity, but we know that as the season advances even this will not keep up with orders. Therefore our injunction to order early.

It is not necessary for a Dealer to order at one time enough goods to carry him to the end of the year. He can decide on what he needs for that period and give an order to his Jobber to make a part delivery each month. This will insure the delivery of goods when wanted and will enable the Jobber to place his order upon us with a better knowledge of the situation. Most Jobbers order of us in this way every fall and find that it works most advantageously. Those who do follow this plan will find it profitable to adopt it.

Too much stress cannot be laid upon the importance of carrying a full stock of goods, especially Records. Dealers lose much business every year because they do not have the titles asked for by their patrons. Aside from our selfish desire to sell goods, we cannot too strongly urge Dealers in large towns and cities to carry the complete line of domestic titles. The cost is small compared with its value in getting and keeping business. Where this is not possible, Dealers should arrange to keep in close touch with a Jobber so as to get Records promptly and fill orders without delay.

Prepare for a great fall and winter business and order early.

NEW RECORD BOX.

The September Records were packed in a new style carton, which we think is the best box of the kind ever put out by this or any other company. It is slightly smaller in diameter than the carton recently used and is lined with felt, which fits snugly around the Record, holding it firmly in place, without scratching the surface. The box has no spindle such as held the Record in place in the old carton, but it has the countersunk cover and bottom peculiar to the latter. All Records hereafter made will be packed in this new

AN ATTRACTIVE FOLDER.

We have just mailed to the trade a copy of one of the most attractive folders yet issued by this company. It is Form No. 690, and is entitled "The Slave of the Ring." It is an adaptation of the "Arabian Nights" tale of that name. The title page shows a most charming slave rising from an Edison Record. On the other pages is an Edison Phonograph and the following ingeniously worded matter:

BEHOLD THE SLAVE OF THE RING!

I am the Genii of Entertainment, created by the Great Wizard of the New World to delight him who possesses the Ring.

Wouldst thou have melody?

Place thy ring upon my finger and I will sing for thee a tender song of love.

Or wouldst prefer merry tales and joyous laughter? These can I give thee until thy heart shall swell with happiness.

Perchance thou wouldst yield thy members to the rhythmic dance?

Then can I sound the harmonies that will float thy form through space e'en as the thistleblow rides on the bosom of the breeze.

I can lull the babe to sweet repose, or waken in the aged heart soft memories of youthful days. At thy command, "The night shall be filled with music, and the cares that invest the day, will fold their tents like the Arabs, and as silently steal away."

Speak thy will, O Prince!

I am the Slave of the Ring!

No. This is not a fairy-tale from The Arabian Nights Entertainments, but a marvellous reality of to-day: The American Nights Entertainment.

The great Wizard of the New World is none other than Thomas A. Edison.

The Slave of the Ring is the Edison Phonograph.

The Ring is the Edison Gold Moulded Records.

You are the favored Prince, if you own a Phonograph, and your home is the Palace of Pleasure.

No matter what may be your mood, the Phonograph stands ready to entertain you. When you have finished your "daily grind" and want to forget your business, you need not forego the comfort of your sitting-room, your pipe, and your smoking jacket, to go to the theatre or opera.

The slave of the Ring can provide—when and where you wish—grand opera, comic opera, or vaudeville. You can hear sacred or popular music; bands, orchestras, or instrumental solos; male or mixed quartettes, solos, duets, trios, or minstrel choruses; political speeches, sermons, impersonations.

When your wife is wearied after a day's household cares, or the children tire of their boisterous play, this charming entertainer can rest the one and quiet the others.

Should you have unexpected visitors, an otherwise dull evening can be made an enjoyable occasion by summoning the Slave of the Ring.

It never tires, and you never tire of it, because it has ever something new to offer.

It gives pure pleasure to all, young or old.

It is always willing, and will go where you please; on the back porch or verandah to brighten the long summer evenings; in the bedroom to cheer the sick; along to your summer home to heighten the vacation pleasures.

You cannot realize what a pleasure it will be to own a Phonograph until you have heard some of the new Edison Gold Moulded Records.

Go to the nearest dealer and ask him to bid the Slave of the Ring prove his skill as an entertainer.

DEALERS SHOULD ADVERTISE.

Next in importance to keeping an adequate stock of Edison goods is to advertise so that the public will know that you have them. Our magazine advertising is arousing great interest in the Edison Phonograph, and when Dealers advertise locally they get the greatest possible benefit from this advertising. Try

Write to Mr. Dealer.

DEALERS MUST GET PRINTED MATTER FROM JOBBERS.

We must once more point out to Dealers the necessity of getting catalogues and printed matter from or through their Jobbers. If the latter cannot supply it they can at least forward the Dealers' order, with some statement to show that he should have the quantities asked for and a guarantee to pay transportation charges if the Dealer will not. We will not supply Dealers with printed matter direct and pay charges on it, whether ordered by a Jobber or Dealer. When Dealers order printed matter direct much unnecessary correspondence is caused. As an instance, we frequently get a request from a Dealer for a thousand each of Phonograph and Record catalogues. To use these quantities properly a Dealer must do a large business in Edison goods. Having no knowledge of the Dealer's business, we must either refer the Dealer to his Jobber, or find out whom he buys through and ask by mail whether the Dealer's business requires the quantities ordered. If the Dealer wrote direct to his Jobber he might not get catalogues by the thousands but he would get what his business warranted. Jobbers may get back at us by saying that they do not get enough printed matter to fill orders. For the most part we send all that is ordered. If it is not enough let us know and we will in turn order more largely. The demand of the past year has upset most liberal plans and at times made it hard to print catalogues fast enough. We will overcome this as quickly as possible until no one can find fault.

AMONG THE JOBBERS.

The H. C. Rees Optical Co., of San Antonio, Texas, have become Jobbers of Edison goods. They have been Dealers for some time.

The Douglas Phonograph Co., of 89 Chambers street, New York, have bought the business of E. S. Oliver, 20 New street, Newark, and will conduct it as a branch store.

The statement last month that the Conroy Piano Co., of St. Louis, had opened a branch store at Dallas, Texas, was premature. A representative of the company was sent to Dallas for that purpose, but after a stay of three weeks was unable to find a suitable location. The company has, therefore, given up the project.

Read & Read, Boston Jobbers, have removed from No. 558 Washington street to No. 630 on the same street.

PRINTED MATTER.

A new colored hanger, Form No. 657, was mailed to the trade with the Record bulletins, supplements, etc. It shows the heads of a family of four grouped around an Edison Phonograph and bears the phrase, "It Amuses the Whole Family." One has been mailed to every Dealer but small additional quantities will be furnished to Jobbers on request.

Copies of the new Phonograph catalogue, Form No. 740, are mailed to all Jobbers and Dealers herewith. As stated last month, there are but few changes in the descriptive matter. The cost of special equipments has been added, and the new prices of business blanks are given. The first nine pages are devoted to a "talk" on the merits of the Edison Phonograph and to several suggested programmes for evening entertainments. We believe that the latter features will make the catalogue much more useful as a means of selling Phonographs. The various illustrations are treated in a new and attractive manner. The cover is lithographed in several colors and gold, and shows a picture of Mr. Edison on the front.

MUSIC DEALERS INJURING THEMSELVES.

While music dealers are regarded as one of the natural agencies for the distribution and sale of talking machine products, still they do not take hold of the business with that vim and activity so characteristic of other lines handling these goods. The music trades proper have every facility for demonstrating and marketing the line, with store room ready at hand and customers who regard these dealers as the legitimate representatives and sellers of everything pertaining to music and kindred merchandise. A talking machine department is held to be a profitable addition to the business, and the only drawback to a better understanding of this inviting prospect is the prejudice of music dealers themselves.

A great many, much to the credit of their judgment, have recognized this fact and take pleasure in maintaining this branch of their establishment at the highest pitch of efficiency, according it ample room and suitable equipment. These are the wise ones. Another portion of the trade look askance at the proposition, arguing that the talking machine is in no sense musical, hence should be ignored entirely as being outside the pale. No greater mistake was ever made if the commercial side of the business is taken into consideration. It is a splendid line of goods to have, and in the hands of men entirely progressive there is "big money" in it. Besides, a talking machine department worthy the name is a drawing attraction to the distinctly musical end not to be despised, as many live dealers have cheerfully testified.—*Music Trade Review*.

RECORDS AND COPYRIGHTS.

When Judge Hazel, United States Circuit Court, New York City, recently handed down his decision in the White-Smith Music Publishing Co. against Apollo Co., in which he declared perforated music rolls were not "writings" within the meaning of the copyright statute, and therefore did not infringe or invade the rights of copyrighted music, he placed the talking machine record in the same category by approving the previous rulings of both American and English courts. That portion of his opinion dealing with this matter follows:

"In the Kennedy against McTammany case (33 Fed. Rep., 584), which was decided in 1888, Judge Colt held that perforated music rolls or strips of paper are not infringements of copyright sheets of music; and that such perforated sheets are designed not to occupy the field of sheet music, but are a mechanical invention to mechanically perform tunes. . . . In the Stern against Rosey case (17 App. D. C., 562), decided in 1901, it was held . . . that the ordinary meaning of the words 'copying, publishing,' etc., cannot be enlarged to include 'the reproduction through the agency of the phonograph of the sounds of musical instruments playing the music composed and published by the complainants.' There apparently is little difference between the facts of the Stern case and the facts here, except that in that case the alleged infringing record consisted of a disk or cylinder for reproducing sounds by means of the phonograph. The court further said: 'It is not pretended that the markings upon waxed cylinders can be made out by the eye, or that they can be utilized in any other way than as parts of the mechanism of the phonograph.'"

A FOLLOW-UP LETTER.

E. B. Rhodes, of Groesbeck, Texas, sends out the following letter to the names of inquirers sent him by this company:

DEAR SIR:—Your letter to the National Phonograph Co. has been referred to me for attention, as I am their agent at this place. I would be pleased to sell you a Phonograph, or any Records, or, in fact, anything in that line. I have been handling talking machines for a number of years, and have sold several different makes, but find that the Edison Phonograph is the most satisfactory in every respect. The machine is finely and correctly built, on the most approved and handsome plans. The Records are just as fine as can be made, the music and songs being plainer and sweeter than records for any other machine, as well as being more lasting, many of the other machines wearing the Records out very rapidly. After a record begins to wear, it loses its beauty very rapidly, and soon becomes worthless. Edison Records stand continuous use without showing wear, when properly handled. You can see and hear the machine at my place of business, where I have recently opened a general repair business, in connection with which I will handle Phonographs as mentioned above. Would be pleased to have you call and see me. Can furnish the machines at same price you would have to pay in Chicago, or St. Louis, thereby saving the freight for you. The Phonograph is a standard machine, at a standard price; nothing as good made, and no one can sell them cheaper than listed price. Thanking you for the inquiry, and hoping to be able to sell you a machine and outfit, I remain,

MEXICAN RECORDS.

Walter Stevens, manager of the Foreign Department of the National Phonograph Co., was interviewed recently by a representative of *The Music Trades* and furnished some interesting details in reference to their successful efforts to obtain in Mexico some 300 Records, made by their special representative in Mexico City. He said:

"Mexico is a land of music and song, and as a market for the talking machine is excellent. We have been met with great success there. Some time ago we sent our expert to Mexico City, and for us he obtained some 300 Records, including the national airs and dances, marches, etc., as rendered by the *Bandas Militares de Estado Mayor*, which is a military band used solely for State occasions and functions where many officers of the government and the army are present. In English we would call it the staff band. And also the *Zapadores de Mexico*. This band, while it is used also for large functions, is called upon to take part in the festivities of the soldiers themselves. Both of these bands are maintained by the government and are composed entirely of native Mexicans.

"There is one peculiarity about the musical balance of Mexican bands, and that is that they run largely to reed instruments, or to such branches as produce to a great extent reed tones.

"We also obtained some selections rendered by the *Arriaga Trio*, consisting of two mandolins and one guitar. The mandolin players in this trio are reputed to be the finest in Mexico. We were fortunate in obtaining the services of *Señores Arbego and Picazo*, *Arbego* being a noted tenor and *Picazo* a well and favorably known baritone. These selections are the popular songs of Mexico sung with guitar accompaniment.

"One of the most interesting lot of Records which we obtained in Mexico were some recitations by *Juan de Dios Peza*, who is the celebrated poet of Mexico. Another set of Records which have taken exceptionally well are the descriptions of bull fights and cock fights, the bull fight in Mexico being a very attractive sport and very popular. Records for these descriptions were obtained by securing the services of quite a number of the well-known patrons of the bull fights, and any one who knows anything at all about bull fighting, as practiced in Mexico City, can readily follow the different stages of the battle."

Mr. Stevens says that business in the Foreign Department is excellent; that Mexico is one of the best talking-machine countries there is; that Cuba is also very good, and that they have recently entered into Jamaica as a field for their machines with fair success.

In an entertainment recently given by a lodge at Kansas City, Mo., the entire programme was furnished by A. L. Trester, of that city, with his Edison Phonograph. Selections were also played for dancing.

THE PHONOGRAPH.

[The following is a composition written by Ella T. Connelly, a pupil in the San Francisco schools.]

The Phonograph was invented by Mr. T. A. Edison in 1877 at his Menlo Park Laboratory, New Jersey, and it came into existence to afford pleasure and amusement to thousands of hearts.

Thomas Alva Edison, the most noted electrician of the age, was born at Milan, Ohio, February 11, 1847. His father was of Dutch and his mother of Scotch descent. His mother having been a teacher, gave him a fair education.

Edison was a great reader. At the age of twelve he became a newsboy on the Grand Trunk line running into Detroit; he then began to study chemistry.

Having gained the right to sell papers on this line he purchased old type and with a few companions printed and issued the "Grand Trunk Herald," the first newspaper printed on a railway train.

He then learned telegraphy from a station master and thereafter his mind was chiefly taken up with electrical studies.

His fame as an inventor was world-wide in 1876. He had taken out over fifty patents in connection with improvements in telegraphy alone. Thence also emanated his Phonograph, a machine for recording and then transmitting human or any other sound.

The Phonograph was discovered by accident. Mr. Edison was at work on a telegraphic apparatus, which by reason of indentations made on paper would transfer a message from one circuit to another automatically by means of a tracing point connected with a circuit-closing device.

Upon revolving with rapidity the cylinder that carried the indented paper, Mr. Edison found that the indentations could be reproduced with great rapidity through the vibration of the tracing point. Immediately he was sure that he could vibrate a diaphragm, by the sound-waves of the human voice.

He reasoned that he could attach a stylus to the diaphragm, and make these sounds record themselves upon an impressionable substance adjusted on a revolving cylinder. He began to experiment with paraffined paper and afterwards with tinfoil as the receiving apparatus.

Although the apparatus was crude the result was a remarkable success, and in 1878 Mr. Edison made a number of Phonographs, which were exhibited in America and Europe.

The perfected Phonograph of to-day is a metal cylinder covered with a layer of wax on which a pointed pen inscribes tracings corresponding to the vibrations caught by a membrane placed on the top of the pen.

An electric battery causes the cylinder to revolve and as one speaks in front of the membrane the cylinder advances slowly in a horizontal position and at the same time revolves rapidly.

The Phonograph is now very common. Many thousands are distributed in American business offices, where they facilitate correspondence in a variety of ways. They are also employed by stenographers as a help in the transcription of their shorthand notes,

which are frequently read off to a Phonograph and then written out when time affords. Direct stenographic work may be reported verbatim by the Phonograph.

It reported a discussion of 40,000 words at a Presidential convention held in 1890, the words being quietly repeated into the machine by the reporter as quickly as they were uttered by the various speakers.

THE PHONOGRAM.

Dealers desiring to get a supply of *Phonograms* to mail to their customers must order them of Jobbers four weeks in advance, and we cannot agree to fill Jobbers' orders unless placed with us a similar period in advance. We plan to print about 10,000 more than we have orders for when we go to press, five weeks in advance of the month of issue, but frequently these are soon used up with extra orders.

Following is a schedule of prices at which *Phonograms* may be obtained by the trade:

DELIVERED WITH GOODS.

Blank, per 1000 copies.....\$2.50
Smaller quantities pro rata.

Imprinted, per 500 copies..... 1.50
Imprinted, per 1000 copies..... 2.75

No orders filled for less than 500 copies requiring imprint, and all imprinting orders must be for multiples of 500.

Jobbers will be glad to supply Dealers on the above basis.

BY MAIL.

Single copies, per year.....\$.20
Five copies to one address, per year..... .40
Twenty-five copies to one address, per year.... 1.80
Fifty copies to one address, per year..... 3.60

Unless they have open accounts on our books, Dealers ordering *Phonograms* sent by mail are requested to send cash or stamps with their orders. The amounts are too small to handle in any other way.

"SONG THE HAND ORGAN PLAYED."

The H. M. Holleman Co., of Houston, Texas, recently sent a programme of a vaudeville theatre in that city, in which mention was made of a special record made by that company, and used in connection with a song by Willis Fessenden, entitled "Song the Old Hand Organ Played." The Holleman Co wrote the following explanation of the matter:

Willis Fessenden, an actor called on our Mr. Holleman and together they arranged a novel effect, making some first-class records of "hand organ songs," which were put on a Gem Phonograph, wound up and installed in a box painted to imitate a hand organ, such as they use in connection with a monkey. At the proper time in the act the hand organ effect was started, mystifying the audience. It is rather hard to adequately describe the act unless one could hear it, but much favorable comment was made upon the novelty at its first performance.

COMMENTS ON EDISON GOLD MOULDED RECORDS FOR OCTOBER, 1905.

The October list of Edison Records has been made up with especial attention to variety, and it will be found to contain something for all tastes, whether it be for high class music or rag-time coon songs. It is this variation that makes these monthly lists so popular. We are frequently criticised by lovers of good music for not cutting out the rag-time and kindred selections, but such critics are selfish and can only see one side of the situation. They do not realize that thousands of others prefer the songs and music of a light and seemingly silly character. We know the wants of both, and as far as is possible with twenty-four selections each month we endeavor to furnish something to suit all. Dealers should point out to the public that now is the time to prepare for entertaining their families and friends in the coming indoor season and that they cannot do better than make a generous selection from this list for that purpose:

No. 9098, "Selection from Chimes of Normandy," by the Edison Concert Band, introduces the most popular airs from this ever-favorite opera by Planquette. The number of different airs given make the Record one of exceptional interest. The work of the band is fully up to the high standard of the Records already made by this organization.

No. 9099, "In Dear Old Georgia," by Irving Gillette, is another descriptive song by Egbert Van Alstyne and Harry Williams, composers of that phenomenal success, "In the Shade of the Old Apple Tree," our Record No. 8958, which was also sung by Mr. Gillette. These facts will lend much interest to this new song. The subject and melody differ greatly from the "Apple Tree" song, as it properly should to be a success. The chorus has a melody that lingers in the mind of the hearer and the more it is heard the better it is liked. It is one of those songs that wears well and never tires. The publishers expect it to be quite as popular as the "Apple Tree," as the song is generally known. Mr. Gillette sings "In Dear Old Georgia" with much feeling, and his fine voice makes a notably fine Record. He is accompanied by the orchestra.

No. 9100, "Everybody Works but Father," by Bob Roberts, is now being sung by Lew Dockstader in performances by his minstrel organization. This is one of the biggest hits that Mr. Dockstader has had in years, being repeatedly encored wherever he sings it. The song humorously tells how the various members of the family work with the exception of father, who sits on the front porch all day. Mr. Roberts's unusually clear articulation makes every word clearly understood. The Record will be found one of his best efforts and will be one of the best sellers on the October list. Mr. Roberts is accompanied by the orchestra. "Everybody Works but Father" was written by Helf and Hager.

No. 9101, "Robin Adair," by Herbert L. Clarke and Leo Zimmermann, is a cornet and trombone duet with orchestra accompaniment. This is an original arrangement as a duet by Mr. Clarke of this charming old song. Messrs. Clarke and Zimmermann are respectively the principal cornet and trombone soloists of Sousa's Band, and have played this selection all over the world, responding to nightly encores with it, so great has been its success. Our Record is a splendid reproduction of these artists' performance.

No. 9102, "I Wait for Thee," by Theodore Van Yorx, is a sentimental song by C. B. Hawley and Ida Whipple Benham, which introduces to the Phonograph clientele a new singer in Mr. Van Yorx, who is one of America's best oratorio and concert tenors, and is tenor soloist of St. Thomas's Church, New York City. The ballad that Mr. Van Yorx has chosen for his initial performance is a splendid composition and one that displays his well-trained voice to perfection. The usual orchestra accompaniment stands back of the singer.

No. 9103, "The Village Seamstress," by Miss Elene Foster, is something entirely new in the way of a Phonograph Record. Miss Foster, who makes it, is a well-known elocutionist, having given readings and recitations before many of the leading clubs and at select entertainments in various parts of the country. She is an unusually clever mimic, as those who hear this Record will admit. Her portrayal of the garrulous village seamstress, with the latter's characteristic repetition of the gossip of the day, will be readily recognized as lifelike by all familiar with country life.

No. 9104, "Making Eyes Medley," by Albert Benzler, is a xylophone Record with orchestra accompaniment that cannot fail to be in great demand, including as it does four popular songs, as follows: "Making Eyes," (our Record No. 9076); "Waltzing With the Girl You Love," (our Record No. 9078); "Come Along, Little Girl, Come Along," (our Record No. 9028), and "Give My Regards to Broadway," (our Record No. 9095). The orchestration is very effectively arranged with a cornet variation on "Waltzing With the Girl Your Love," which is a feature of the Record. The orchestra accompanies the xylophone.

No. 9105, "A Picnic for Two," by Harry MacDonough, is a serio-comic song and one of the most popular hits of the present season. It was written by Albert Von Tilzer (music) and Arthur J. Lamb (words), and sung in good style by Mr. MacDonough, with orchestra accompaniment. Messrs. Von Tilzer and Lamb also wrote "Teasing," our Record No. 8804. This new song is written on an entirely different theme, both words and music, but it is quite as catchy.

No. 9106, "Fishing," by Ada Jones and Len Spencer, is a vaudeville sketch, with orchestra incidental music, introducing a summer resort flirtation scene, with a witty dialogue by Miss Jones and Mr. Spencer and concluding with Fay Templeton's song "Fishing," sung by Miss Jones. This is one of the best Records that these artists have made. It will be a favorite with everybody and especially with those who

spend a vacation at any of the numerous summer resorts of the country.

No. 9107, "The Whistler and His Dog," by the Edison Military Band, will bring back pleasant memories to those who visited Asbury Park, N. J., in the past summer. "The Whistler and His Dog" was composed by Arthur Pryor. It was played with great success by the band under his leadership at Asbury Park during the season ending in September. If the piece did not appear on the regular programme it was demanded as an encore, no concert being permitted to end without it being rendered. It is written in the caprice movement and includes some effects quite new in band compositions. Our Record will be recognized as a splendid rendition of this selection.

No. 9108, "I'll Be Waiting in the Gloaming, Sweet Genevieve," by Byron G. Harlan, is a sentimental ballad that is being sung with great success in Dockstader's Minstrels by Manuel Romain. It has a tuneful melody and effectively introduces a bit of the old song "Genevieve." It is quite certain to achieve a wide popularity. The song is well fitted to Mr. Harlan's style of ballad singing. He is accompanied by the orchestra. J. Fred Helf wrote the words and music of this composition.

No. 9109, "When the Mists Have Rolled Away," by Anthony and Harrison, is a sacred selection, the words of which were written by Annie Herbert and the music by Ira D. Sankey. It makes a splendid duet Record. As Messrs. Anthony and Harrison are both choir singers in one of the principal New York City churches they are able to give the hymn a perfect interpretation. Our recording department has had many calls for this selection. The singers are accompanied by the orchestra.

No. 9110, "New Era Overture," by the Edison Symphony Orchestra, is a beautiful orchestral selection by J. C. Heed. It features the different instruments interestingly and is a Record that will please all who are partial to the work of our orchestra.

No. 9111, "What You Goin' to Do When the Rent Comes 'Round," is a new coon song, sung by Arthur Collins. Rufus Rastus Johnson Brown has a fondness for gambling. Bad luck has been his on this particular occasion. When he returns home Mrs. Brown won't let him in and shouts to him despairingly "What you goin' to do when the rent comes 'round? Rufus, I love you, but this serves you right. Guess that's sufficient; good night." This song was written by Harry Von Tilzer (music) and Andrew B. Sterling (words). It is extremely funny and its melodious swing will land it into popularity. The orchestra accompanies the singer.

No. 9112, "Angelena," by MacDonough and Biehling, is a descriptive love song by Lawrence B. O'Connor (music) and C. E. Biehling (words), and sung with orchestra accompaniment. This is unquestionably one of the best duet Records ever made by Messrs. MacDonough and Biehling. The success of the selection is largely due to its delightful melody and swinging movement. The humming of male

voices in the chorus is a new and attractive feature.

No. 9113, "Evening on the Plaza," by Samuel Siegel, is an unaccompanied mandolin solo. The selection was composed by Mr. Siegel and has been played by him on his various tours throughout the country. There is no greater artist on the mandolin than Mr. Siegel, and his selection is one of his most taking numbers, being nightly received with generous applause by discriminating audiences.

No. 9114, "My Word," by Ada Jones, furnishes another evidence of the great versatility of Miss Jones. She has been heard in coon songs, German dialect, Irish ballads, vaudeville sketches, and now she fairly outdoes previous efforts by the clever manner in which she renders Katie Barry's great success in "Fantana." The English dialect employed by Miss Jones in this song is very refreshing. The music of "My Word" was written by Raymond Hubbell and the words by Robert B. Smith. The orchestra accompanies the singer.

No. 9115, "Leader of the German Band," by Collins and Harlan, is a new comic march song by Theodore Morse (music) and Edward Madden (words), who have a number of big hits to their credit in the past season. It has a catchy swing to it and as a duet it makes a fine number. Messrs. Collins and Harlan, as usual, bring out the fun and melody in an excellent manner. They are accompanied by the orchestra.

No. 9116, "Yankee Grit March," by the Edison Concert Band, is Abe Holzmann's companion composition to his "Uncle Sammy March," (our Record No. 8632) Mr. Holzmann's marches are famous throughout the world, and no composer's works spring into such sudden and lasting popularity as his.

No. 9117, "Wearing of the Green," is by Miss Marie Narelle. Even better than Miss Narelle's Record of "Killarney" in September is her rendition of this song, so dear to the heart of every true son and daughter of old Ireland. The sentiment of the song will appeal strongly to them, but Miss Narelle's artistic singing will cause the Record to be sought by all classes. Unusually good is the work of the orchestra in playing the accompaniment.

No. 9118, "Hiram Green, Good Bye," by Billy Murray, is a comic song being sung by Dave Lewis in the musical oddity "Kafooze-lum." The music is by Clarence M. Chapel and the words by Henry A. Gillespie. It is cleverly sung by Mr. Murray with orchestra accompaniment. Hiram is a country lad who wants to see the city, and his friends sorrowfully bid him good bye, knowing well what his finish will be. That Hiram is verdant may be seen by the following bit of introduced dialogue: *Bunco Man*—"Hello, Hiram, come with me and I'll show you the Tenderloin." *Hiram*—"Tenderloin! Gee, that's my favorite kind of steak."

No. 9119, "The Musical Yankee," by Len Spencer, is a vaudeville musical specialty in which are introduced music by sleighbells, xylophone, violin, ocarina and cornet. The conversation between the musical Yankee and

the leader of the orchestra is decidedly humorous and gives a flavor of theatre realism seldom attained in a record performance. Because of its unusual variety this Record will be a large seller.

No. 9120, "Hard Times Come Again no More," by the Edison Male Quartette. A better quartette Record is seldom heard. The verse is given in the form of solo, duet, trio and quartette and the chorus by the quartette. It is beautifully arranged and extremely interesting from the fact of its constant change in tone color. The orchestral background lends an added charm.

No. 9121, "My Maryland March," by the Edison Military Band, is a delightful march by W. S. Mygrant and played in splendid style by our Military Band. "Maryland, My Maryland," is introduced into the composition in a most attractive manner.

THOMAS ALVA EDISON.

[An interview by Francis Arthur Jones, published in *Strand*, May, 1905.]

Probably no man living has ever been the subject of more remarkable newspaper stories than Thomas Alva Edison. He very rarely grants interviews to journalists, and, consequently, the hard-pressed reporter has occasionally to rely upon his gifts of imagination when his editor calls for a new "story" respecting the inventor of the incandescent light system. Mr. Edison, however, very seldom takes the trouble to contradict these tales, though a short time ago he did break silence when an enterprising American journal began publishing a weekly interview with him and attributing to the inventor statements of so extraordinary and ridiculous a nature as to call forth a letter from Mr. Edison's legal adviser, which brought the interesting series of "interviews" to an abrupt conclusion. Remarkable as the statement may appear, there is no authentic record of Mr. Edison's work in existence. A number of short "Lives" were published in the early days, but they were more the work of the imagination than of a truthful observer.

The present writer has paid many visits to the Edison Laboratory at Orange, N. J., and had the honor of being granted more than one interview with the inventor, and it was with his special permission and approval that this article was prepared for *The Strand Magazine* and the various departments of the laboratory were photographed. During these visits to Orange much interesting information was obtained from those who are in the inventor's confidence, though nothing is here published which has not been sanctioned by Mr. Edison himself.

"You have my full permission," he said, "to come here when you please, gather all the information you require, and photograph the laboratory from end to end." This was certainly a generous invitation, of which the writer, it is scarcely necessary to say, took full advantage.

The Edison laboratory consists of a group of buildings of impressive proportions, erected in the midst of green meadows and shady trees, and is probably more picturesquely situated than any other place of the kind in the world. The main building is two hundred and fifty feet long and three stories high, while the four smaller buildings are a hundred feet by twenty-five feet and one story high. The laboratory is being constantly added to, and each year sees some improvement or enlargement.

On first entering, one is ushered into a fine library a hundred feet square and fully forty feet high. It has two spacious galleries, containing a magnificent collection of minerals and gems which Mr. Edison purchased in Paris many years ago. The works on scientific subjects which have been gathered together in this spacious room number close upon sixty thousand volumes, and include every magazine and journal dealing with scientific research published throughout the world during the last forty years.

It may be remarked here that Mr. Edison seldom replies personally to a letter, and, indeed, rarely even signs one, and it is not a fact, as has often been stated, that he speaks his replies into a Phonograph, which are afterwards transferred to paper by his secretary. He simply glances at those letters which are of sufficient importance to be placed before him,

and scribbles a few words on the margin, after which his secretary, Mr. J. F. Randolph, expands them into a polite missive. Mr. Edison has no particular dislike to writing, and could probably, if he chose, get through more correspondence than any two men, for he is one of the quickest longhand writers in the world, having cultivated the art when a telegraphist many years ago.

Near Mr. Edison's desk is an alcove containing a small table and a chair, and here the inventor occasionally takes his modest lunch, which is of the plainest description, for he suffers at times from indigestion and has to be careful. The lunch is sent down from the house each day by Mrs. Edison, who packs the little basket herself.

Near the library is the stock room, where everything necessary for scientific experimenting may be found, and in quantities which would last for many years. The room is long and narrow, but of considerable height, and contains thousands of small drawers, reaching from the floor to the roof, labelled with a hundred queer titles, such as ores, needles, shells, macaroni, fibres, inks, teeth, bones, gums, resins, feathers, etc.

One of the most interesting sections of the laboratory is the galvanometer building, presided over by Messrs. Robert Rafn and N. Traaholt, both young men and exceptionally clever scientists. This building is of heroic size and excellently lighted by a dozen large windows. The room is further remarkable from the fact that not a speck of iron was used in its construction, everything being of brass. The cost, naturally, was great, but subsequently proved to be so much money wasted, for it had not been erected more than a few months when electric cars were run past the very door, thus rendering futile Mr. Edison's costly endeavor to banish "magnetic influence." Near this department is another room which contains nothing but a very big safe and a very small bed, and on the latter the inventor takes an occasional stretch while he enjoys a cigar. In former years, when he would spend night after night at the laboratory, he would lie on this same bed and, covered with a woollen rug which still does duty, snatch a few hours' rest from his labors.

The galvanometer room contains many things of interest connected with Mr. Edison's early inventions. There is, for instance, his first patent, a vote recorder, which comprises a system whereby each member of a legislative body can, by moving a switch to right or left, register his name on a sheet of paper under the "Ayes" or "Noes." The paper was chemically prepared, and when the circuit was closed an iron rolled passed over the paper, under which was the type signifying the member's name. The current passing through the chemically prepared paper caused its discoloration wherever the type came in contact with it, and the name was accordingly printed on the paper. At the same time the vote was counted by a dial indicator which was operated by the same current.

Then there are also shown in this room the "gold and stock ticker which is now found in every broker's office, the model of a picture telegraph which was a device to transmit photographs over the wires, the first models of the duplex and quadruplex telegraphs, the microphone, the mimeograph, etc. Then there is a costly and rare collection of galvanometers, electrometers, photometers, spectrometers, spectroscopes, chronographs, etc. There is also a wonderful collection of acoustic instruments, which were used in connection with the perfecting of the Phonograph, as well as a number of anatomical models of the ear and throat. Neither the first Phonograph nor the first incandescent light is shown, both being now located in London at the South Kensington Museum.

I asked Mr. Edison why he had allowed these interesting mementos to go out of his possession, and he explained that some years ago an Englishman had paid him a visit and seemed so anxious to have them that he was persuaded to part with them. He seemed somewhat surprised that people should take any interest at all in such things.

The X-ray room, which is in the charge of Mr. E. Dally, is a small compartment containing the X-ray machine which is the identical instrument which Mr. Edison sent down to Buffalo at the time Mr. McKinley was shot, in order to locate the bullet.

Near the X-ray department is a small room which apparently contains nothing of interest save a table, a chair, some lumber, and a lathe or two. But it has "associations," for it was here that Mr. Edison perfected the Phonograph.

There are two machine shops, both spacious and excellently lighted by twenty-four windows apiece. One is known as the heavy machine shop, while the other is where all the light experimental machinery

is made. The latter is presided over by Mr. John F. Ott, and it is here where all the small models are made. In the heavy machine shop, in charge of Mr. Robert A. Bachman, is turned out the big machinery used in the cement works and elsewhere, as well as the large battery trays.

Another interesting room is known as the Precision Room, where all the instruments are perfected. This room is also in charge of Mr. Ott. Here all the most delicate parts of the machinery used in the construction of the various inventions are made. There are many remarkable machines in this room, all of an automatic nature, such, for example, as the device by which the body of a Phonograph is made in one operation. The metal box on which the Phonograph is mounted is placed on the machine, and simultaneously eight holes are drilled, the box is milled, and the holes are reamed to size. This takes but a few minutes, and one man is able to turn out a hundred a day.

Perhaps the room having the greatest amount of interest for the general public is that presided over by Mr. A. T. E. Wangemann, and known as Room No. 13, or the Phonograph Experimental Department. Everything connected with the "talking machine" is shown here—hundreds of records, forests of horns, ranging in length from a few inches to eighteen feet, Phonographs of all sizes and shapes, Records, etc. In this room efforts are being constantly made to obtain better all-round results and superior Records.

"All the work done in this room," Mr. Wangemann said, "is of an experimental nature, and all our efforts are centered on obtaining better apparatus for recording and reproducing, better raw materials for cylinders, and better Records, both blank and moulded, etc. In fact, it is here that every effort at improving and advancing the present way of Phonograph production and reproduction is made. We are constantly experimenting with new Records, new speakers, new compositions for blank Records, new horns or funnels, and, in fact, there is nothing we do not try in order to obtain absolute perfection of sound reproduction."

Mr. Edison has spent many weeks and months in this room, often working until two and three in the morning. He has a small room partitioned off from the experimental department, and here he sits and listens to Records for many hours at a time, scribbling on scraps of paper his opinions of the various Records. No one is allowed in this room under any consideration. Last year Mr. Edison spent the best part of seven months in this room, endeavoring to render the Phonograph more perfect. He spends much of his time finding out the reasons for poor work, for he believes that more can be learned from things going wrong than from things which go well. As readers may be aware, there is no substance known which is proof against influence by sound vibrations, or which will not transmit sound at some velocity. If it were possible to find a substance which would be absolutely dead to sound, and yet solid enough to be used in mechanical construction, then one could obtain far superior reproductions of sound waves, both vocal and instrumental.

The legal department of the Edison laboratory is under the charge of Mr. Frank L. Dyer, who employs a numerous staff, and who is, perhaps, one of the hardest worked individuals in the building. Although a member of a prominent firm of patent lawyers in New York, he spends practically his entire time at the laboratory, and there is little in regard to Mr. Edison's numerous inventions with which he is not acquainted. The writer had an interesting conversation with Mr. Dyer regarding his department, in the course of which he said:

"Mr. Edison's work being based almost entirely on new inventions, a large part of my work has to do with patents and suits based thereon. Not only has Mr. Edison been by long odds the most prolific inventor and patentee of any time, having filed more than one thousand one hundred applications in this country alone, for which over seven hundred patents have so far been granted, and more than two thousand applications for foreign patents in most of the countries of the world, but numerous and frequent applications for patents are being filed by experimenters and workmen connected with the several companies that are identified with the Edison interests, such as the National Phonograph Co., the Edison Manufacturing Co., the Edison Storage Battery Co., the Edison Portland Cement Co., and about twenty others. Consequently there are always several hundred active applications for patents pending in this country and abroad, the special details of which have to be remembered in order that they may be properly prosecuted.

"It is, of course, physically impossible for me or my department to attend personally to the many suits against infringers of the Edison patents all over the world, although they are conducted under my own direction and some by me personally. In this work, however, I have the assistance of other lawyers in New York, Chicago, Washington, London, Paris, and elsewhere. In addition to the patent suits, there are many other legal actions of which this department has charge and many of which it directly conducts, such as the usual damage suits for personal injuries, actions based on contracts, matters of insurance, real estate, etc.

"Mr. Edison's work as an inventor," continued Mr. Dyer, "as shown by the records in my office, extends over a most varied field. In addition to his better-known patents granted in connection with the development of the electric lamp, the Phonograph, telegraph, telephone, ore-milling machinery, and storage batteries, I find that the inventions include vote recorders, typewriters, electric pens, vocal engines, addressing machines, methods of preserving fruit, cast-iron manufacture, wire-drawing, electric locomotives, moving picture machines, the making of plate glass, compressed-air apparatus, and many others. In the line of Phonographs he has secured a hundred and one patents, on storage batteries twenty patents, on electric meters twenty patents, on telegraphs a hundred and forty-seven patents, on telephones thirty-two patents, on electric lights a hundred and sixty-nine patents, on dynamos ninety-seven patents, and on ore-milling machinery fifty-three patents. When it is remembered that an incandescent lamp consists simply of a carbon filament in an exhausted glass globe, the ingenuity in devising one hundred and sixty-nine different patentable modifications and improvements on such device appears really marvellous."

Mr. Edison being a proverbially modest man and one who dislikes nothing so much as talking about himself, I took the opportunity of asking Mr. Dyer if he would give me some of the results of his observations of the great inventor during the many years with which he had been connected with him, and which must necessarily be far more valuable and accurate than any journalistic interview. Mr. Dyer was quite agreeable, and, placing his finger-tips together in legal fashion, he said:

"I presume the commonly accepted idea of Mr. Edison is that by brilliant flashes of intellect inventions spring fully developed from his brain, or else that he has had the singular good fortune of being the instrument to whom Nature communicates her discoveries, just as you or I might be lucky enough to continue to draw grand prizes at the successive monthly distributions of a lottery.

"Neither of these views is correct, and Mr. Edison draws a very broad line between 'discovery' and 'invention.' In his parlance a discovery is a 'scratch'—something that might be disclosed to any one and for which he thinks little or no credit is due. Invention, on the other hand, is the result of that peculiar mental faculty which perceives the application of some phenomenon or action to a new use. As an inventor, therefore, Mr. Edison possesses two qualifications pre-eminently. First, the inventive faculty, or the special intuition by which the adaptability of some observed result to a useful end is presented; and, secondly, the physical energy and patience necessary for the investigation by which that result may be ascertained.

"Although capable of flashes of great genius, his mind is necessarily analytical, and when a problem is presented to his attention it may be safely presumed that most of its solutions will be considered by him and the most successful selected. Notwithstanding this mental equipment, his success has depended, I think, very largely on his physical make-up as well as upon a certain solidity of his nervous system that takes no account of fatigue or ennui. In other words, day after day, with only a few hours' sleep, he can devote himself enthusiastically to the investigation of a single problem, the very monotony of which would drive most men into nervous prostration.

"In a recent argument in a suit on one of Mr. Edison's patents opposing counsel sought to show that Edison was more an inventor than a discoverer, but I think the remark made was entirely complimentary. Said the learned gentleman: 'If your honor wished him to, Mr. Edison could go into a field of grass a mile square and select therefrom the most perfect blade!' The popular conception of Mr. Edison is that of a man who accomplishes startling results by instantaneous flashes of intellect. The real Edison is a man of indefatigable industry, who attains his ends by patient effort intelligently applied."

World Radio History "On the subject of 'scratches,' but very few real

discoveries have been made by him. In one of them, experiments were being made in the early days with automatic telegraphs, where the effect of the current was to produce chemical changes in moving paper strips with various substances. In making these experiments Mr. Edison held in his hand a pen, through which the current passed, and which pressed upon the strip. It was found that, with some chemicals, the passage of the current increased the friction between the pen and the strip, so as to subject the pen to slight pulls. Later, when experimenting with the telephone, these earlier observances occurred to him, and as a result the 'motograph,' or 'chalk telephone receiver,' was invented, wherein the same phenomena take place. Although this work Mr. Edison regards as a 'scratch,' it seems to me that very few men would have had the inventive faculty to foresee that the original discovery could have been used for making a new telephone."

A very good example of the inventor's methods may be found in the perfected Edison storage battery. To recount the details of this development would require a book—a book of much human nature, of intense interest, of hopes and fears, of many disappointments, and of final successful realization. In the first place, the defects of the old forms of storage batteries had to be analyzed, from which it was found that the objections were inseparable from these types. Consequently a definite ideal was fixed—a battery that should be cheap, light, compact, mechanically strong, absolutely permanent, and generally "fool-proof"—and for the accomplishment of this ideal the energies of Mr. Edison and his assistants were directed.

It was immediately perceived that the use of an acid solution was out of the question, since that meant the employment of lead, the objections to which were fully appreciated. At the outset, therefore, it was determined to use an alkaline electrolyte, and the question then presented was as to the character of active materials to be used. In this search for suitable active materials, practically the whole gamut of chemical elements was run; nothing was left untried, and in this investigation many remarkable and heretofore unknown discoveries were made.

After months of patient experimenting it was finally decided that the metals which possessed all the desirable properties *theoretically* were iron and nickel. When this was settled the real inventive work began. That work involved the solution of the question how to obtain iron and nickel so as to get those elements in the proper condition of activity for practical use in a storage battery. Literally thousands of experiments were made in this particular direction, and processes were gradually developed by which the materials were finally secured in the desirable condition. The development of the two metals was carried on simultaneously, the effort, of course, being to obtain practically the energy which the metals should give theoretically. In this work the development of the iron would sometimes be far ahead of that of the nickel, and then some new discovery would be made or some new process suggested by which the nickel would exceed the iron. Finally, the work had so far developed that practically the entire theoretical efficiency was secured for both materials.

At this point the mechanical make-up of the battery required consideration in order that a cell might be obtained capable of cheap manufacture, mechanically strong, durable, and compact. Unforeseen difficulties were met in these investigations, as, for example, it was found that in charging or discharging one or other of the active masses in absorbing oxygen tended to swell; no solder was known that would resist the effects of electrolysis in a caustic solution; and it was also found that during charging the generated gases tended to carry off a fine spray of the alkali, so as thereby to deplete the electrolyte. All these difficulties, and many others, had to be overcome.

Even when the battery had been experimentally developed both mechanically and chemically, machines and processes had to be designed and invented by which the active materials could be made, the mechanical parts produced, and the battery assembled on a commercial scale. In all this work Mr. Edison was in the forefront, directing the experiments, suggesting modifications, preparing new processes, and designing new mechanical appliances, until to-day the Edison battery is a perfected entity, realizing all the ideal conditions that were laid down at the start, and crowning with success many years of the most patient, persistent, and indefatigable investigations that can be imagined.

I have dwelt somewhat at length on this story of the perfecting of the Edison battery, not only because

it is one of the inventor's greatest achievements, but from the fact that there must be very few people who are not directly or indirectly interested in the automobile. The same story might be told of the very least of Mr. Edison's inventions, for it is an unalterable rule with him never to let any new device issue from his laboratory until it is absolutely perfect. Everyone knows how, when he was at work on his incandescent lamp, he explored the two hemispheres in search of the bamboo that would yield him just the homogeneous fibrous structure that he needed. Indeed, such details regarding each one of his inventions, if collected, would fill many volumes, and his success has been won only by the most indomitable perseverance and untiring energy.

The story of how Mr. Edison came to invent the Phonograph has been told many times and with many variations, and it may not, therefore, be without interest to relate exactly how the wonderful "talking machine" came into existence. Briefly, then, the invention of the Phonograph was the result of pure reason based upon a very happy inspiration. In his early work with automatic telegraphs operating at high speeds Mr. Edison had occasion to experiment with embossed strips impressed with dashes and dots thereon which were moved rapidly beneath a stylus to vibrate it. It was observed that this stylus in vibrating produced audible sounds. A small thing such as this would pass unnoticed by the ordinary observer as of no interest, but to a mind that is not only intensely alert but highly analytical it was regarded as a curious phenomenon. At this time Mr. Edison was actively working on his telephone experiments, so that his attention was largely absorbed by matters connected with acoustics. Simply as a matter of *inspiration* the idea of a talking machine occurred to Mr. Edison, and, remembering his experiences with the automatic telegraph transmitter, he concluded that, if the undulations on the strip could be given the proper form and arrangement, a diaphragm could be vibrated so as to reproduce any desired sounds.

The next step was to *form* the proper undulations in the strip, and the idea was then suggested to Mr. Edison's mind that these undulations could be produced by *sounds themselves*, which could then be reproduced. When this complete conception was reached the Phonograph was produced. Obviously, the change from a strip of material capable of being impressed by sound waves to a cylinder of such material on which the sound waves could be impressed in a spiral line was a refinement of the original conception which simply involved mechanical considerations. It is, therefore, rather an interesting fact that in the development of the Phonograph the reproduction of the sound *preceded* the original production of the Record.

Readers may also be interested to learn that the first patent on the Phonograph was filed in the United States on December 24, 1877, and was granted February 19, 1878, No. 200,521. In this patent is disclosed the now historic instrument in which the sounds are recorded on a sheet of tinfoil applied to a spiral groove cylinder. Prior to this, however, in an application filed in Great Britain on July 30, 1877, No. 2,909, Mr. Edison disclosed not only a cylinder Phonograph, but also an apparatus embodying his original conception of an embossed strip.

I have left all reference to the chemical department until the last for two reasons. First, because it is by far the most absorbing section of the laboratory; and, secondly, because it was there that I first saw Mr. Edison. The apartment, which is lofty, spacious, and splendidly lighted, is divided into two portions, the outer and larger being presided over by Mr. Fred Ott, while the inner and smaller room is Mr. Edison's own private sanctum. Very few people are permitted to enter this room—only those who are closely connected with the inventor in his work—though when the "old man," as his *employees* love to call him in all reverence, is seated at his table endeavoring to solve some scientific conundrum, he is so absorbed as to be perfectly unconscious of any one who might enter.

Mr. Edison has spent many days and nights in this room without taking any sleep, and often so engrossed in his experiments as to even forget to eat. Latterly, however, Mrs. Edison, with a devoted wife's privilege, has insisted on her husband returning home in reasonable time, and, in order that he should not have the excuse of being able to say that he had nowhere to work, she has had a laboratory built on to their beautiful home in Llewellyn Park, where the inventor may prosecute his scientific investigations undisturbed.

The chemical department at the Edison laboratory

differs very little in appearance from those belonging to other noted scientists and inventors, though it is probably larger than the majority. It is, of course, fitted with every contrivance necessary to scientific experimenting, and replete with philtres, stills, "muffles" (used for carbonizing or reducing chemicals), fume chambers, test-tubes (for testing the solution of his storage battery), every kind of chemical, numerous charts, etc.

On entering the chemical department I found Mr. Edison seated upon the table chatting to half-a-dozen of his "boys," as he always calls his assistants, and while waiting until he was at liberty I was enabled to examine his features without his being aware of the fact. Most readers doubtless know Edison from the portrait of him published many years ago, and which shows him listening to the Phonograph. Although taken almost twenty years ago, the inventor still resembles this photograph to a remarkable degree. He is older, of course, but his face still wears that youthful expression which will, without doubt, always be its chief characteristic, whatever age he may reach.

He is of medium height, powerfully and compactly built, and, as I then saw him, was wearing a well-worn coat covered with chemical stains, and an old pair of trousers, spotless linen, and a white tie. His head is massive, the forehead high, eyes deeply set, brows overhanging, and the expression extraordinarily keen. His eyes are wonderfully luminous and, when he is interested, light up his entire face. The nose is straight, the mouth tender and humorous. He is somewhat deaf in the right ear, and, though constantly placing his hand behind his left ear in order to catch what is being said, the organ has been pressed slightly forward. He was speaking in a very quiet voice, and was watching the lips of those who were answering him, in order the more readily to hear their remarks.

Suddenly he became conscious that there was a stranger in the room, and, jumping from the table with the agility of a boy, welcomed me in hearty American fashion, and was about to lead the way into his own room when he paused and asked me if I could wait a moment while he read the "boys" a story which had been given to him a short time before. At the same time he drew a sheet of paper out of his pocket, on which was typed a humorous paragraph, which he read to the young men who were crowding round him, and I joined in the hearty laugh which followed the recital. Like Lincoln, Edison loves a good story.

Then he led the way into his sanctum, and seating himself at his table, where he has evolved so many wonders, motioned me to a chair beside him and expressed a desire to know what he could do for me. I almost felt inclined to request him to invent some wonder on the spot for my especial benefit, but instead I asked him to tell me of his early days, when he printed and published the *Weekly Herald* on board the express running between Port Huron and Detroit.

There was not much to tell, he declared. He was a boy of fourteen at the time, and the idea of publishing a newspaper on a train had occurred to him some time before he was able to put it in actual operation. Early in 1862 he bought some old type and "stereos" of the *Detroit Free Press*, obtained the use of a smoking car as his publishing and printing office, and founded the *Weekly Herald*. He did all the work himself: set up the type, wrote the editorials, gathered the news as the train flew from town to town, sold the papers himself, and in a very short time had no fewer than four hundred subscribers. The paper ran for several months, and then, in an unfortunate moment, the "staff" began to combine chemical experiments with his journalistic enterprise, set fire to the car with a phosphorus bottle, and was summarily ejected from his "office."

"In this way," laughed Mr. Edison, "the *Weekly Herald* came to an end. But I had not quite finished with journalism, for soon after I issued a 'society' paper called *Paul Pry*, which, however, only ran a very short time."

One copy only of the *Weekly Herald* appears to have been preserved, and that was rescued from destruction by Mrs. Edison, who kept it as a memento of her husband's early days. It is a most interesting little sheet, and though stained and creased, probably from being carried in the pocket, is very legible. One item shows how, even at the age of fourteen, Edison was keenly alive to the best means of attracting new subscribers. "In a few weeks," announces the editor, "each subscriber will have his name printed on his paper."

One of the stories most frequently related regard-

ing Edison's earlier days tells how, when he was working in a certain factory, he was called upon to evolve some means whereby the hordes of cockroaches which infested the place might be got rid of. For the special benefit of these insects he constructed a trap and charged it with electricity, so that each insect on touching it received a shock which effectually put an end to its existence. I asked Mr. Edison if this story was true, and he acknowledged that it was.

There seems to be a generally expressed belief that Mr. Edison dislikes the Phonograph, and some papers have gone so far as to affirm that he will not allow one in his house. Again I asked Mr. Edison to corroborate this, but he could not do so. "I am very fond of the Phonograph," he said, "and can listen to good Records by the hour. I do not, perhaps, like the Records that are most popular with the public, for I am not particularly fond of so-called comic songs or 'rag-time' music. My favorite composer is Beethoven, and I never tire listening to his symphonies."

Mr. Edison has never spoken into a Phonograph for the purpose of making a selling Record, and seemed surprised when I suggested that if he did so it would certainly have an enormous sale. But he shook his head and modestly declared that he did not think so. He might some day speak into the Phonograph the story of how he invented the talking machine, but he did not consider it very likely, so we let it go at that, and I asked him what was the longest time he ever spent over an invention without leaving it.

"Five days and five nights," he replied. "During that time I had no sleep and took most of my meals standing. I did not find it a great hardship, and got so accustomed to doing without sleep that, had I wished to do so, I could have gone on for another two days. I have men who work with me here in this laboratory who get so absorbed over a new discovery or invention that they have cheerfully spent three and four days and nights with me helping to work out my ideas. Every inventor must possess unflagging energy if he is desirous of achieving anything. Without it he will certainly fail in his object."

"Which do I consider the greatest inventive country? Why, America, of course. She probably has more need of inventions, for labor is dear, and so some means must be found to reduce the time sheet. My greatest invention? Well, if you mean the one which I consider has been the greatest benefit to mankind, I unhesitatingly say the incandescent light system. It is certainly the one of which I am most proud."

It seemed superfluous, when one considered how tenaciously Mr. Edison sticks to his work, to ask the inventor if he had any "hobbies," but I did so, and he at once declared that he had. "Chemistry and experimenting are my chief forms of amusement," he said, "and very fascinating I find them. I am also fond of driving, and, of course, deeply interested in automobiling."

Mr. Edison looked affectionately at a glass tube containing some kind of solution suspended over an electric spark, and as the liquid began to bubble I tactfully rose to depart. While bidding the great inventor good-bye I asked him if he contemplated a visit to England, and he replied that in the course of a year or two he might give himself that pleasure. He had already made two visits to Great Britain, and on each occasion his reception had been so warm and sincere that he felt very much inclined to repeat the experiment. Then he returned to watch with some anxiety the bubbling test-tube, and as I looked back from the laboratory door I knew that his mind was once more absorbed with some scientific experiment, and that everything else was forgotten.

JULY, 1904, PHONOGRAM REPRINTED.

Owing to the hundreds of requests for copies of the first issue of the new *Phonogram* (July, 1904), we have reprinted a limited edition, and will mail copies at two cents each. It is our intention to later reprint the pictures of Messrs. Collins and Harlan, which appeared in the first issue, but many correspondents were anxious to get a complete file.



PHONOGRAPA SECTION OF STORE OF WERNER MUSIC CO., EDISON JOBBERS AT EASTON, PA.

NOTICE TO THE TRADE.

Change in Prices of Edison Business Blanks.

Edison Business Blanks, shaved, will hereafter be sold to the trade and the consumer at the following net prices:

Singly and up to 100	\$.30	each net
100 to 500	.25	each net
500 to 1000	.22½	each net
1000 or more	.20	each net

We will not hereafter list or quote prices on *rough* Business Blanks.

NATIONAL PHONOGRAPH CO.,

July 14, 1905. Orange, N. J.

SOUTHERN DEALER'S ANNOUNCEMENT.

The following is part of a letter sent by the Southern Phonograph Co., of Birmingham, Ala., to its patrons, announcing its removal to larger quarters to 116 North 21st street:

Our list of Edison Records is replete with all the elegant and latest numbers of these famous Records, which are unequalled and which are recognized the world over as the acme of excellence in the art of reproduction of sound. There is but one perfect instrument for the reproduction of sound, in its full value of beautiful shadings of tonal quality, in existence, and that is the Edison Phonograph in connection with the Edison Gold Moulded Record. This instrument faithfully reproduces every musical instrument and all the peculiarities of tone incident thereto, as well as the human voice without sensible diminution of volume or tone value.

We will occupy the entire building, and in the arrangement of our parlors have an eye single to the comfort and convenience of our patrons. One of the greatest benefits accruing in our removal to the new quarters is the freedom from noise and other disturbing influences we were forced to endure in the old location. We will be all to ourselves, too, all of

which enables us to demonstrate to you the superiority of our goods. We will inaugurate on Thursday and Saturday evenings Phonograph recitals, embracing the latest and most pleasing numbers, and it will be our constant aim to contribute to your pleasure, not only during these entertainments, but at all times to the best of our ability.

We beg to invite your attention to the fact that we are the original introducers in Birmingham of this famous instrument and Record, which have furnished so much delight to thousands.

Thanking you for past patronage, and taking this occasion to state that we will endeavor to merit to the fullest extent a continuance of same, we beg to remain.

SOUTHERN PHONOGRAPH CO.

VISITORS FROM INDIA.

Messrs. Rustamji Jamsedji Noorbhoy and S. J. Noorbhoy, of Khetwady, Bombay, India, representing the Standard Trading Agency, called at the Laboratory on Wednesday, August 9th, with Senor Cabanas, of the Foreign Department. They have been on a tour through Europe and America since May 1st last. They will reach home again about November 1st, after having visited thirty cities in Europe and America, and traveling over 25,000 miles.

The J. F. Schmelzer & Sons' Arms Co., of Kansas City, who became Jobbers in Edison goods a few months ago, recently wrote:

"We find a greater demand for these machines than any others. We are pleased to state that our business in Edison goods is far better than we anticipated. We are getting up circular matter and send it out broadcast, and we are satisfied that it will have the desired effect."

JOBBER'S OF EDISON PHONOGRAPHS AND RECORDS.

ALABAMA.

Birmingham—Talking Machine Co., 2007 Second ave.
 Mobile—W. H. Reynolds, 167 Dauphin street.
 Montgomery—R. L. Penick, 119 Dexter ave.

CALIFORNIA.

San Francisco—Peter Bacigalupi, 786-788 Mission street.

COLORADO.

Denver—Denver Dry Goods Co., 619 16th street.

CONNECTICUT.

Middletown—Caulkins & Post Co., 406-408 Main street.
 New Haven—Pardee-Ellenberger Co., 155 Orange st.

DISTRICT OF COLUMBIA.

Washington—E. F. Droop & Sons Co., 925 Pennsylvania avenue, N W
 S. Kann Sons & Co., 8th and Pennsylvania avenues.

GEORGIA.

Atlanta—Atlanta Phonograph Co., 49 Peachtree St.
 Waycross—George R. Youmans.

ILLINOIS.

Chicago—James I. Lyons, 192 Van Buren street.
 Siegel, Cooper & Co., 281 State street.
 Talking Machine Co., 107 Madison street.
 The Vim Co., 68 E. Lake street.
 Montgomery Ward & Co., 111 Michigan ave.
 Rudolph Wurlitzer Co., 302 Wabash ave.
 Peoria—Peoria Phonograph Co., 222 Bridge street.
 Quincy—Quincy Phonograph Co., 808 Hampshire st.

INDIANA.

Indianapolis—Craig-Jay Co., 234 Massachusetts ave.
 Kipp Bros. Co., 37 S. Meridian street.
 A. B. Wahl & Co., 119 S. Illinois street
 Lafayette—A. B. Wahl & Co., 304 Main street.

IOWA.

Des Moines—Hopkins Bros. Co., 620 Locust street.
 Vim Co., 704 West Walnut street.
 Fort Dodge—Early Music House, 822 Central ave.

KENTUCKY.

Louisville—C. A. Ray, 640 Fourth street.

LOUISIANA.

New Orleans—William Bailey, 600 Frenchman street.
 National Automatic Fire Alarm Co.,
 614 Gravier street.

MAINE.

Bangor—S. L. Crosby Co., 186 Exchange street.
 Portland—W. H. Ross & Son, 207 Commercial street.

MARYLAND.

Baltimore—E. F. Droop & Sons Co., 109 N. Charles St.

MASSACHUSETTS.

Boston—Boston Cycle & Sundry Co., 48 Hanover street.
 Eastern Talking Mach. Co., 177 Tremont st.
 Iver Johnson Sptg. Goods Co., 163 Washington street.
 C. E. Osgood Co., 744 Washington street.
 Read & Read, 630 Washington street.
 Fitchburg—Iver Johnson Sptg. Goods Co., 247 Main st.
 Lowell—Thomas Wardell, 111 Central street.
 New Bedford—Household Furnishing Co., 170 Purchase street.
 Springfield—Flint & Brickett Co., 439 Main st.
 Worcester—Iver Johnson Sptg. Goods Co., 304 Main st.

MICHIGAN.

Detroit—American Phono. Co., 106 Woodward ave.
 Grinnell Bros. 219 Woodward ave.
 Saginaw—Morley Bros.

MINNESOTA.

Minneapolis—Thomas C. Hough, 714 Hennepin ave.
 St. Paul—W. J. Dyer & Bro., 21-23 West 5th street.
 Thomas C. Hough, 392 Wabasha street.
 Minnesota Phonograph Co., 37 E. 7th street.

MISSOURI.

Kansas City—J. W. Jenkins' Sons Music Co., 1013-1015 Walnut street.
 J. F. Schmelzer & Sons Arms Co., 710 Main street.
 St. Louis—Conroy Piano Co., 11th and Olive streets.
 O. K. Houck Piano Co., 1118 Olive street.
 Western Talking Machine Co., 923 Olive st.

NEBRASKA.

Lincoln—H. E. Sidles Cycle Co., 1317 O street.
 Omaha—Nebraska Cycle Co., 15th and Harney streets.
 Omaha Bicycle Co., 16th & Chicago sts.

NEW JERSEY.

Hoboken—Eclipse Phono. Co., 205 Washington st.
 Newark—A. O. Petit, New and Halsey streets.
 Paterson—James K. O'Dea, 117 Ellison street.
 Trenton—Stoll Blank Book and Stationery Co., 30 E. State street.
 John Sykes, 105 N. Broad street.

NEW YORK.

Albany—Finch & Hahn, 92 State street.
 Brooklyn—Chapman & Co., Fulton and Duffield streets.
 A. D. Matthews' Sons, 394 Fulton street.
 Price Phonograph Co., 1260 Broadway.
 Buffalo—P. A. Powers, 613 Main street.
 Elmira—Elmira Arms Co., 117 Main street.
 Gloversville—American Phono. Co., 99 W. Fulton st.
 Kingston—Forsyth & Davis, 307 Wall street.
 New York City—Bettini Phono. Co., 156 W. 23d street.
 Blackman Talking Machine Co., 97 Chambers street.
 J. F. Blackman & Son, 2737 3d avenue
 Sol Bloom. New Amsterdam Theatre Building.
 I. Davega, Jr., 802 Third avenue.
 S. B. Davega, 32 E. 14th street.
 Douglas Phono. Co., 89 Chambers st.
 H. S. Gordon, 139 Fifth avenue.
 Harry Jackson, 219 Bowery.
 Jacot Music Box Co., 39 Union Square.
 Victor H. Rapke, 1661 Second avenue.
 Siegel-Cooper Co.
 John Wanamaker.
 Alfred Weiss, 1525 First avenue.
 Oswego—Frank E. Bolway, 32 Bridge street.
 Poughkeepsie—Price Phonograph Co., 203 Main st.
 Rochester—A. J. Deninger, 345 North street.
 Mackie Piano, O. & M. Co., 100 State street.
 Giles B. Miller, 63 State street.
 Talking Machine Co., 97 Main st., E.
 Schenectady—Finch & Hahn, 456 State street.
 Jay A. Rickard & Co., 253 State street.
 Syracuse—W. D. Andrews, 216 E. Railroad street.
 Troy—Finch & Hahn, 7 Third street.
 Utica—Clark-Horrocks Co., 54 Genesee street.
 Arthur F. Ferriss, 89 Washington street.
 William Harrison, 41 Columbia street.
 Utica Cycle Co., 31 Columbia street.

OHIO.

Canton—Klein & Heffelman Co., 216 N. Market street.
 Cincinnati—Ilsen & Co., 25 W. 6th street.
 Rudolph Wurlitzer Co., 10-12 W. 4th st.
 Cleveland—Eclipse Musical Co., Jr., Erie and Huron sts.
 Columbus—Perry B. Whitsit Co., 213 S. High street.
 Dayton—Niehaus & Dohse, 35 E. 5th street.
 East Liverpool—Smith & Phillips Music Co.
 Newark—Ball-Fintze Co.
 Toledo—Hayes Music Co., 608 Cherry street.

PENNSYLVANIA.

Allegheny—Henry Braun, 500 Federal street.
 Allentown—G. C. Aschbach, 539 Hamilton street.
 Easton—William Werner, 401 Northampton street.
 Harrisburg—S. K. Hamburger, 12-14 N. Market sq.
 New Castle—W. C. DeForest & Son.
 Philadelphia—C. J. Heppe & Son, 1117 Chestnut street
 Lit Bros., Market and 8th streets.
 Penn Phonograph Co., 17 S. 9th street.
 John Wanamaker, 13th and Market sts.
 Wells Phonograph Co., 41 N. 9th street.
 Western Talking Mach. Co., 25 S. 9th st.
 H. A. Weymann & Son, 923 Market st.
 Pittsburg—Theo. F. Bentel Co., Inc., 632 Liberty street.
 Kaufmann Bros., Fifth avenue.
 H. Kleber & Bro., 221 Fifth avenue.
 C. C. Mellor Co., 319 Fifth avenue.
 Pittsburg Phono. Co., 937 Liberty street.
 Reading—Reading Phonograph Co., 809 Penn street.
 Scranton—Ackerman & Co., 130 Wyoming avenue.
 Technical Supply Co.

RHODE ISLAND.

Pawtucket—Pawtucket Furniture Co., 39 N. Main St.
 Providence—J. M. Dean Co., 785-795 Westminster street.
 J. A. Foster Co., Weybosset st.
 Household Furniture Co.
 J. Samuels & Bro., 154 Weybossett street.
 A. T. Scattergood & Co., 106 N. Main st.

TENNESSEE.

Knoxville—Knoxville Typewriter and Phonograph Co., 311 Clinch street.
 Memphis—O. K. Houck Piano Co., 359 Main street.
 F. M. Atwood, Lyceum Building.
 Nashville—Nashville Talking Mach. Co., 510 Church st.
 Magruder & Co., 13 Arcade.

JOBBER'S OF EDISON PHONOGRAPHS AND RECORDS—Continued.

TEXAS.

Dallas—Southern Talking Machine Co., 347 Main st.
 El Paso—W. G. Walz Co., 101 El Paso street.
 Fort Worth—Cummings, Shepherd & Co., 700 Houston st.
 Houston—Texas Phono. Co., Capitol and Fannin Sts.
 *San Antonio—H. C. Rees Optical Co., 242 West Commerce St.

VIRGINIA.

Richmond—Magruder & Co., 729 E. Main st.

WISCONSIN.

Milwaukee—McGreal Bros., 173 3d street.

CANADA.

Toronto—R. S. Williams & Sons Co., Limited,
 143 Yonge street.
 Winnipeg—R. S. Williams & Sons Co., Ltd., 121 Princess street.

*Added since August 1, 1905.

SUSPENDED LIST, SEPTEMBER 1, 1905.

SUPERSEDING ALL PREVIOUS LISTS.

ILLINOIS.

Chicago—H. E. Everett, 6134 S. Halsted street.
 Ottawa—Edward Hayne.
 Wheaton—E. Irving.

INDIANA.

South Bend—EUGENE MARSH, 126 Vistula avenue.
 SOUTH BEND BOOK BINDERY, Robert Lebolt, Prop., 203 North Michigan street.

IOWA.

Burlington—JOHN P. WEISS, 711 Jefferson street.
 Sioux City—HATTENBACH BROS. CO.
 A. V. LARIMORE, 518 Fifth street.

KANSAS.

Clay Centre—E. M. GOWENLOCK.
 Lawrence—BELL BROS.

MAINE.

Biddeford—W. H. FIELD.
 Monmouth—G. H. STETSON.

MASSACHUSETTS.

Boston—T. SINGER, 60 Leverett street.
 Lawrence—LORD & CO., 314 Essex street.
 E. O. MOSHER, 420 Essex street.
 Lynn—ELIAS DEYOUNG.
 Malden—A. T. FULLER.
 Nantucket—ARTHUR M. TAYLOR.
 New Bedford—H. B. DEWOLFF.
 Somerville—E. J. WINCHESTER, 32 Summit avenue.
 Woburn—OSBORN GILLETTE, or THE BOLTON JEWELRY CO., L. F. Maloney, Manager.

MICHIGAN.

Detroit—F. J. SCHWANKOVSKY.
 Saginaw—GEO. W. EMENDORFER.
 JAMES V. CALAHAN, 217 Genessee st.
 TIERNEY BROS., 217 Genessee st.

MISSOURI.

Kansas City—THE WITTMANN CO.

NEBRASKA.

Lincoln—THE WITTMANN CO.
 Omaha—THE WITTMANN CO.

NEW HAMPSHIRE.

Hillsboro Bridge—E. M. BARNES.
 Manchester—A. E. DUMAS
 Nashua—F. A. MCMASTER & CO.

NEW JERSEY.

Atlantic City—SAM'L D. WOLF, 32-34 Arkansas ave.
 Bayonne—I. WIGDOR, 450 Avenue D.
 Jersey City—W. L. HOFFMAN, 151 Montgomery st.
 Newark—R. L. CORWIN; also New York City.
 Passaic—I. HURWITZ.
 Paterson—CHAS. H. KELLY, 25 N. Main street.

Plainfield—S. W. FRUCHT, or R. FRUCHT; also New York City.

ELSTON M. LEONARD.

West Hoboken—EMIL HOLLANDER, or THE WEST HOBOKEN BICYCLE & PHONO. CO., 619 Spring street.

NEW YORK.

Albany—G. LINDE, 353 S. Pearl street.
 Bedford Park—GEO. H. TYRRELL.
 Brooklyn WM. ALBRECHT, 294 Knickerbocker ave.
 *H. HINDERMANN, BUSHWICK PHONOGRAPH EXCHANGE, 1421 Myrtle avenue.
 Hobart—F. H. MARSHALL.
 New York City—A. T. ARMSTRONG, or AMERICAN PHONO. CO., 106 Wall street.
 AUTOMATIC ZITHER CO., M. Cohen, Prop., 58 Second avenue.
 BERN BEARWALD, 373 W. 11th st.
 BRONX PHONO. CO. or DAVID SWITKY, 506 Willis ave.
 CENTRAL PHONO. CO., 160 E. 42d street.
 R. L. CORWIN; also Newark, N. J.
 EAGLE PHONO. CO., or C. LOWENTHAL, 83 Nassau street.
 EMPIRE PHONO. CO., 2 W. 14th street.
 S. W. FRUCHT, or R. FRUCHT, 7 Barclay st., or 68 Cortlandt st.; also Plainfield, N. J.
 O. HACKER, 2 Murray street.
 HAWTHORNE & SHEBLE, 297 Broadway; also Philadelphia, Pa.
 HOLOBER BROS., 350, 421 and 491 West st.
 N. HORN, 148 E. 58th street.
 W. L. ISAACS, 114 Fulton street.
 S. LEMBURG & CO., 194 Broadway.
 J. MCELLYNNE, 202 Broadway.
 RICHMOND PEASE, 44 W 132d st.
 F. M. PRESCOTT, 44 Broad st.
 WINTHROP CYCLE CO., 2212 Seventh ave.

Rome—CHARLES TUTTLE.

Saratoga—W. J. TOTTEN.

Saratoga Springs—MARVIN A. COTE.

OHIO.

Cincinnati—J. L. ANDEM.
 Coshocton—BURNS & GOSSER.
 Springfield—D. & M. VANDERPOOL.
 Uhrichsville—F. A. MAZURIE.

PENNSYLVANIA.

Philadelphia—A. R. CASSIDY, 2783 Emerald street.
 HAWTHORNE & SHEBLE, 604 Chestnut st., or Oxford and Mascher sts.; also New York City.
 A. KROUSE, 832 Arch street.
 PENN NOVELTY CO., 15 South 9th st

Phoenixville—KEINARD BROS.

Pittsburg—A. LIPPARD, 615 Wylie ave.

RHODE ISLAND.

Providence—F. P. MOORE.

WISCONSIN.

Milwaukee—J. C. BLATZEK.

*Added Since August 1, 1905.

Jobbers and Dealers are asked not to supply any of the above named firms with our apparatus, either at addresses given or any other address.

AMUSEMENT ~ AND LANGUAGE ~ STUDY



September
- 1905 -

SUN	MON	TUE	WED	THUR	FRI	SAT
~	~	~	~	~	1	2
3	4	5	6	7	8	9
10	11	12	13	14	15	16
17	18	19	20	21	22	23
24	25	26	27	28	29	30

DOUBLE SERVICE

September will open the Fall demand for Phonographs. Demonstrate "DOUBLE SERVICE"—Amusement and Language Study. Send fifty cents and we will deliver the new I. C. S. Sample Language Record, containing extracts from lessons in French, German, Spanish, and English. Prices and literature on application. Address:

LANGUAGE DEPARTMENT

**INTERNATIONAL CORRESPONDENCE SCHOOLS
SCRANTON, PA.**

FOR FOREIGN SALES, ADDRESS { Foreign Dept., National Phonograph Co., 31 Union Square, New York City.
European Headquarters, National Phonograph Co., Ltd., 25 Clerkenwell Road, London. E. C.

EDISON Phonograph Monthly

PUBLISHED FOR TRADE USE ONLY BY
THE NATIONAL PHONOGRAPH CO.

VOL. III. ORANGE, N. J., OCTOBER, 1905. No. 8.

NATIONAL PHONOGRAPH CO.
ORANGE, N. J.

NEW YORK: 31 UNION SQUARE.

CHICAGO: 304 WABASH AVENUE.

SAN FRANCISCO: 786 MISSION STREET.

NATIONAL PHONOGRAPH CO., LTD., 25 CLERKENWELL
ROAD, LONDON, ENG.

EDISON PHONOGRAPHS AND RECORDS.

All communications to THE PHONOGRAPH MONTHLY
should be addressed to the Advertising Department,
Orange, N. J.

C	O	N	T	E	N	T	S
A Great Season at Hand.....							1
Advance List of Edison Gold Moulded Records for November, 1905.....							2
Must Get Orders in by the 10th.....							3
Questions and Answers for the Trade....							3
A Sure Way to Increase Sales.....							3
Western Sales Force Visit the Orange Factory							4
Among the Jobbers.....							5
About Ourselves							5
A Word to Dealers About Orders for Parts, Etc.							5
Phonogram Changes							5
Current Advertising Forms							6
Printed Matter							6
Read the Phonograph Monthly.....							6
How Father Outdid Edison.....							7
Dealers Who Advertise.....							7
A Fine Business Showing.....							7
Comments on Edison Gold Moulded Records for November, 1905.....							8
A Comfortable English Order.....							10
Slot Phonographs in Great Favor.....							10
A Hearing Converted Him.....							10
A Phonograph Club.....							11
Store of Texas Phonograph Co., Houston, Texas							13
Beat Out the "Roasters".....							13
Jobbers of Edison Phonographs and Records							14
Suspended List for October.....							15

A GREAT SEASON AT HAND.

From the manner in which orders for Phonographs and Records have been received in the past month it is evident that the Jobbers are amply anticipating their wants and are preparing for a great fall and winter season in Edison goods. Every order for both machines and Records shows a large increase over orders placed by the same firms at the same time a year ago. This makes it certain that our factory facilities will be strained to the last degree to meet the demand. Hundreds of hands have been added to the working force and many departments are working nights as well as days, with two shifts of hands. This will be continued for the remainder of the year at least and as much longer as the demand makes it necessary.

Many of the orders placed by Jobbers cover a period of four months and provide for shipments at a given time each month or as near as circumstances will make it possible. This plan enables our factory force to plan for some months in advance and it ensures Jobbers getting goods nearer on time than would be possible if orders were placed from month to month. Dealers would act wisely if they would adopt a similar policy and give their Jobbers orders covering the remainder of the year, with shipments of a certain quantity each month. Jobbers would appreciate this and Dealers would be in better shape to supply the wants of their patrons than if they waited till their stocks were nearly depleted before they placed their orders. Every Dealer who is making an earnest effort to sell Edison goods can safely count upon an increase of from twenty-five to fifty per cent. over his business in the fall of last year and can order accordingly.

The advertising that we are doing this fall is double what it was in the same months last year and the expenditures for November and

(Continued on Page 3.)

THE ADVANCE LIST OF NOVEMBER RECORDS APPEARS ON PAGE 2.

NEW EDISON GOLD MOULDED RECORDS. ADVANCE LIST FOR NOVEMBER, 1905.

RECORDS listed below will be ready for shipment as near **November 1st** as possible, at which time Jobbers' stock orders, if **received prior to October 10th**, will be shipped. November Supplements will be forwarded to Jobbers with their stock orders for Records. Retail Dealers should place stock orders with their Jobbers at once, to insure prompt shipment as soon as Jobbers' stock is received.

- | | | |
|------|---|--|
| 9122 | Hungarian Fantasia (<i>Tobani</i>) | Edison Concert Band |
| 9123 | Mother o' Mine (<i>Kipling-Tours</i>) | <i>Song with Orch. accom.</i> Theo. Van Yorx |
| 9124 | On the Banks of the Rhine With a Stein (<i>Von Tilzer</i>) | Collins and Harlan |
| | <i>Comic male duet, by the composer of "Under the Anheuser Bush,"</i> | |
| | <i>Orch. accom.</i> | |
| 9125 | Friendly Rivals (<i>Godfrey</i>) | Herbert L. Clarke and John Hazel |
| | <i>Cornet duet, Orch. accom.</i> | |
| 9126 | Honeymoon Hall (<i>Bratton</i>) | Harry MacDonough |
| | <i>Waltz song from "The Pearl and the Pumpkin</i> | <i>Orch. accom.,</i> |
| 9127 | In Timbuctoo (<i>Morse</i>) | <i>A Monkey ditty, Orch. accom.</i> Billy Murray |
| 9128 | Jesus, Saviour, Pilot Me (<i>Gould</i>) | Anthony and Harrison |
| | <i>Sacred male duet, Orch. accom.</i> | |
| 9129 | Bold Front March (<i>Seltzer</i>) | Edison Military Band |
| 9130 | Wait 'Till the Sun Shines, Nellie (<i>Von Tilzer</i>) | Byron G. Harlan |
| | <i>Descriptive song, Orch. accom.</i> | |
| 9131 | And the World Goes On (<i>Sutton</i>) | Bob Roberts |
| | <i>Song hit, as sung by Raymond Hitchcock in "Easy Dawson,"</i> | <i>Orch. accom.,</i> |
| 9132 | Betty (<i>Taylor</i>) | <i>Sentimental male duet, Orch. accom.</i> MacDonough and Biehling |
| 9133 | Roses and Thorns (<i>Rideguc</i>) | <i>Mexican Dance</i> Edison Symphony Orchestra |
| 9134 | We'll be Together When the Clouds Roll By (<i>Mills</i>) | Irving Gillette |
| | <i>Descriptive song, Orch. accom.</i> | |
| 9135 | I'm the Only Star that Twinkles on Broadway (<i>Von Tilzer</i>) | Ada Jones |
| | <i>Comic song, Orch. accom.</i> | |
| 9136 | Pretty Mary (<i>Mills</i>) | <i>Sentimental male duet, Orch. accom.</i> Harlan and Stanley |
| 9137 | Dancing in the Starlight (<i>Ellis</i>) | Edison Concert Band |
| 9138 | Sweetest Flower That Blows (<i>Hawley</i>) | Marie Narelle |
| | <i>Soprano sentimental song, Orch. accom.</i> | |
| 9139 | Have You Seen My Henry Brown? (<i>Albert Von Tilzer</i>) | Arthur Collins |
| | <i>Coon song, Orch. accom.</i> | |
| 9140 | The Irish Girl I Love (<i>Hoffman</i>) | Edward Barrow |
| | <i>Tenor sentimental song, from "Rogers Brothers in Ireland,"</i> | <i>Orch. accom.,</i> |
| 9141 | Sweet Little Daisies (<i>Seltzer</i>) | <i>Bells solo, Orch. accom.</i> Albert Benzler |
| 9142 | Fol-the-rol-lol (<i>Limericks</i>) | <i>Comic song, Orch. accom.</i> Edward M. Favor |
| 9143 | Courtship of Barney and Eileen (<i>Vaudeville</i>) | Ada Jones and Len Spencer |
| | <i>Comic dialect sketch, Orch. incidental music</i> | |
| 9144 | When the Evening Breeze is Sighing Home. Sweet Home (<i>Solman</i>) | Edison Male Quartette |
| | <i>Descriptive male quartette, Orch. accom.</i> | |
| 9145 | Everybody Works but Father Medley | Edison Military Band |
| | <i>Introducing "Everybody Works but Father." "Leader of the German Band,"</i> | |
| | <i>"Angelena," "In Dcar Old Georgia" and "Hiram Green, Good-Bye"</i> | |

Edison Gold Moulded Records are made only in Standard Size. Both Standard and Concert Records may be ordered from this list. Order by number, not title. If Concert Records are wanted, give the number and letter C.

(Continued from Page 1.)

December will be the largest in the history of the company. It is certain to create an unprecedented demand for Edison Phonographs and Records, and the Dealers who do not carry a sufficient stock to meet the demand will learn of their mistake when too late to remedy it. Dealers will also find it profitable to do an extra amount of advertising in their local papers, so that the public after reading our general advertisements in the magazines will know where to buy the goods in their own cities and towns.

MUST GET ORDERS IN BY THE 10th.

The following letter was sent to our Jobbers in the latter part of August, just too late for publication in the September PHONOGRAPH MONTHLY:

NEW YORK, AUG. 26, 1905.

For the reason that some Jobbers are not complying with our instructions and request, that their stock orders for advance Records be sent us not later than the 10th of the month following receipt of samples, we again beg to notify you that unless such orders are sent us by the 10th of the month, we cannot promise shipment of them at same time shipment is made to such Jobbers as send their orders by that time.

This month there are some Jobbers who have not sent in their orders for September Records and for that reason shipment of same, if order is received, cannot be made at same time as to other Jobbers, which will be some time next week.

As we believe it is very important, if not absolutely imperative, that each and every Jobber receive their stock of advance Records at the same time, we trust any who have heretofore been delinquent in getting their orders in on time, as above requested, will hereafter see that delays of so serious a nature do not occur again.

C. H. WILSON,
Manager of Sales.

There is little to add to this notice, except to say that the greatly increased demand for Records makes it absolutely necessary to get orders in by the 10th. If shipments are to be made between the 25th and the 1st of the month we must have the co-operation of Jobbers.

QUESTIONS AND ANSWERS FOR THE TRADE.

Lovejoy Novelty Works, Laramie, Wyo.—Are the words "Gold Moulded" copyrighted as applied to Edison Records? There is a party here that is advertising another make of records as "Gold Moulded." Now, the word "Gold Moulded" is misleading, as it would make people think that they were the same as the Edison Records.

[It is not copyrighted. It was, however, originally used by this company to describe Mr. Edison's original process of using gold in making moulds for Phonograph Records. The value of the phrase was not recognized till it was too late to copyright it.]

A SURE WAY TO INCREASE SALES.

Every month we spend thousands of dollars advertising the Edison Phonograph. Did you ever think that this advertising is done for *your* benefit, Mr. Dealer?—to send you *new* customers? Most Dealers appreciate this great help. Others apparently think it is nothing because it costs them nothing. They will not take care of the business we send them. Our advertising produces inquiries about the Phonograph from prospective buyers all over the country. They want to know just what a Phonograph will do for them in the home, and how much it will cost.

We send them a booklet, and write them that we have sent their names to the nearest Dealer, who will call or write and give them full particulars. Then we send the Dealer a Home Office Reference giving the name and address of the inquirers and asking him to report to us the result of his call or letter. And here's where we find out whether the Dealer appreciates the free advertising or not. Most Dealers call or write promptly, and in a large percentage of cases, make a sale. Others apparently throw this valuable information in the waste basket and neglect a good prospect of a sale, because a little effort is required to handle it.

Of course we know that every prospective does not buy, but a large percentage do, if properly followed up by the Dealer. But whether they buy or not we want to know. We want every Dealer to give Home Office References prompt and careful attention, and then report to us. This information is important. It tells us how much our advertising accomplishes, where it is weak, how it can be improved, how we can help the Dealer to close sales, and whether it will pay to increase the advertising.

Won't you help us help you? Designate some one in your office to take care of these references and report to us. Progressive Dealers find that it pays, and so will you if you have not heretofore given this matter the attention it deserves. Now is a good time to start handling references systematically. Our advertising is heavier this fall than ever before, and if Dealers want us to keep up this expenditure, they should work with a will to make it pay.

Owing to a typographical error the title of No. 9116, "Yankee Grit March," is given in the October Supplement as "Yankee Girl March." Dealers whose patrons call attention to it will please explain the matter. But for the large edition we would have had the supplement reprinted.

WESTERN SALES FORCE VISIT THE ORANGE FACTORY.

George M. Nisbett, Manager of our Chicago office, and his seven salesmen, paid a visit to the factory at Orange, N. J., during the week of August 28. They reached New York on August 28 and spent the two following days

inspecting Mr. Edison's laboratory and the various buildings which comprise the factory of the National Phonograph Co. It was the first visit to Orange of most of the salesmen, and they obtained a much better idea of how Phonographs and Records are made than they had before known. They also found the plant



WESTERN SALESMEN AT THE EDISON LABORATORY.

The seven salesmen are standing in the back row and reading from right to left they are: W. C. Patrick, L. R. Chandler, F. L. Fritchey, W. Hope, A. H. Kloehr, M. G. Kreusch and A. B. Chandler. In the center of the front row are Mr. Edison and Mr. W. E. Gilmore, President of the company. Mr. Wilson, General Sales Manager, sits at the right and L. C. McChesney, Advertising Manager, at the left.



GEORGE M. NISBETT,
WESTERN MANAGER.

a much larger proposition than they had anticipated. Mr. Edison met the party at the laboratory and gave each a cordial hand shake and a pleasant greeting. The occasion was the first time that the Western salesmen had ever met together, and on the second day the wish was expressed that they might be photographed in a group. A happy combination of circumstances made it possible to get Mr. Edison, Mr. William E. Gilmore, President of the company, and Mr. C. H. Wilson, General Manager of Sales, to join the group. The picture is reproduced herewith. Mr. Nisbett was detained in New York and to the regret of his faithful co-workers could not be included in the picture. This will explain why his photograph is here given separately.

Thursday and Friday were spent in seeing New York and its nearby resorts. On Thursday night President Gilmore gave a dinner in honor of the party in New York. When the party left for Chicago Friday night they had absorbed enough material to tell interesting stories to the trade for some weeks to come.

AMONG THE JOBBERS.

Finch & Hahn, of Albany, have moved their Troy branch from 7 Third street to 3 Third street, and their Schenectady branch from 456 State street to 504 State street.

The Eclipse Phonograph Company, of Cleveland, O., have removed to 162 Prospect street.

The Knoxville Typewriter and Phonograph Co., of Knoxville, Tenn., have moved from 311 Clinch street to 421 Gay street.

The American Phonograph Co., of Gloversville, N. Y., opened a branch jobbing agency at 34 Church street, Burlington, Vt., on October 2.

New Edison Jobbers during the past month were the Hext Music Co., Denver, Colo., the Talking Machine Co., Pittsburg, and W. A. Meyers, Williamsport, Pa.

W. E. Henry, formerly manager of the Pittsburg branch of the Columbia Phonograph Co., in connection with P. A. Powers, of Buffalo, has opened a large wholesale and retail talking machine store at 619 Penn avenue, Pittsburg, under the title of the Talking Machine Co. They have already become Edison Jobbers. They have fitted up their large store in handsome style.

The Eastern Talking Machine Co., Boston, Mass., is one of the very prosperous concerns of the country. Last year it declared a dividend of over 30 per cent., and perhaps this will be exceeded for the current fiscal period. Starting with a capital of \$7,500, it is now ambling along cheerfully and contentedly, with its financial standing rated at \$75,000 and not owing a dollar.—*Music Trade Review*.

ABOUT OURSELVES.

John R. Schermerhorn, Assistant General Manager of the National Phonograph Co., sailed on September 26 on the Kronprinz Wilhelm to spend several months at our branch offices in London, Paris, Berlin and Brussels, and also to look into the matter of establishing branches in other European cities.

C. H. Wilson, General Manager of Sales, is making a trip to the Pacific Coast with a view of establishing new trade relations in several of the large cities west of the Rocky Mountains. He is accompanied by Mrs. Wilson, and will visit several Jobbers between Chicago and San Francisco before he returns.

Edgar W. Dennison resigned on September 16 as Secretary of the National Phonograph Co. A. Westee, General Auditor, who has been with the company almost since its organization, has been appointed Secretary in place of Mr. Dennison.

Walter H. Miller, Manager of our Recording Department, returned in the latter part of August from a tour of the recording plants at London, Paris, Berlin and Brussels. Mrs. Miller made the trip with him.

Charles N. Wurth, of the Edison Laboratory, returned recently from Europe, where he spent the past two years installing Record moulding plants at Paris, Berlin and Brussels.

A WORD TO DEALERS ABOUT ORDERS FOR PARTS, ETC.

We would like to impress upon sub-Dealers the desirability of having Reproducers and Recorders repaired and ordering small parts through their Jobbers. When Dealers who are buying goods from Jobbers send such orders to us it causes a lot of needless trouble. Before we can receive the order we must get the Dealer to sign agreement, because we do not allow a Jobber to sell goods to a Dealer who has not signed through him and to be consistent we cannot do it ourselves. This done the order is put through. When the work is done or the parts ready for shipment we must put through a *pro forma* bill, having no knowledge of the Dealer's financial standing. When the bill is paid shipment is made. All of this trouble would be saved if orders were placed through Jobbers and the Dealer would get much better service. Should Jobbers decline to handle these small orders, we shall be glad to have the Dealer send us the Jobber's refusal. We doubt, however, if any Jobbers would refuse to handle them.

PHONOGRAM CHANGES.

The Advertising Department would appreciate it if the Jobbers who order *Phonograms* each month would give us notice at least a month in advance of any change in quantity or imprints. This will enable us to order a sufficient quantity printed each month and properly fill orders for imprinted copies. By the time this paragraph is read we shall have the November *Phonograms* largely printed and some of them will be packed for shipment. *Phonograms* are packed with Records of the month and as the demand for the latter has grown to such an enormous extent we are compelled to begin packing early in the month so as to get the work completed by the 25th. After the *Phonograms* are packed with Records it is difficult to increase or decrease the standing order. By sending in changes before the first of the month, Jobbers will materially assist the handling of orders for *Phonograms* and Records.

CURRENT ADVERTISING FORMS.

Following is a list of numbers of current catalogues and other forms; no other forms can be supplied at the present time:

- 378—Order Book.
- 400—Chinese Supplement.
- 464—Japanese Supplement.
- 515—Catalogue of Parts.
- 551—Shaving Machine Folder.
- 608—Jobbers' Discount Sheets.
- 609—Dealers' Discount Sheets.
- 618—Hanger on Prices of Machines, etc.
- 619—Catalogue of Accessories.
- 635—Dance Record Supplement.
- 641G—Price Cards for Gem.
- 641S—Price Cards for Standard.
- 641H—Price Cards for Home.
- 641T—Price Cards for Triumph.
- 649—Hebrew Record Supplement.
- 650—Record Order Blanks.
- 655—Steel Portrait of Mr. Edison.
- 657—Family Poster.
- 658—Boy Poster.
- 660—Mexican Record Catalogue.
- 675—Music in Every Home Folder.
- 686—Record Placard (35c.).
- 713—Swedish Record Supplement.
- 720—Foreign Record Catalogue.
- 725—Domestic Record Catalogue.
- 728—August Record Supplement.
- 740—Machine Catalogue.
- 741—September Record Supplement.
- 751—October Record Supplement.
- No form number—Celluloid Card.
- No form number—Absent Lover Poster.

PRINTED MATTER.

We have gotten out a special booklet, printed in two colors, for use only in replying to inquiries for our catalogues resulting from our magazine advertising. It is called "Home Entertainments with the Edison Phonograph." It is not intended to supply this form to the trade. The edition printed would not make it possible, even if we felt disposed to send it out for general distribution. It will be useless, therefore, for Jobbers or Dealers to request quantities of it.

Until we can reprint them, it will not be possible to fill any further orders for Folder No. 690, entitled "Slave of the Ring," or Card No. 746, showing the picture of Mr. Edison. It will require from four to six weeks' time to print a further edition of these forms.

For the benefit of those who do not seem to have read previous notices in the PHONOGRAPH MONTHLY, we beg to say that Forms 535, 540 and 550 are now out of print and cannot be supplied. They will not be reprinted. The same is true of the little book marks, Form 205.

In order to have a more up-to-date catalogue for the holiday trade and avoid as far

as possible the use of supplements, it has been decided not to get out a new catalogue of Domestic Records until November 1. This will include November Records. Jobbers should bear these facts in mind and not get too heavily stocked up with the present catalogue. None of the November 1 edition will be shipped till the November Records have gone out.

Form No. 409, the card in colors, showing a boy with a hatchet "Looking for the Band," is out of print and cannot be supplied to the trade.

We would again advise the trade that the booklet on the "Art of Making Phonograph Records" is out of print. A new edition is in preparation, but will not be ready for several weeks.

The numbers on Record order sheet C will run out with the December Records. Sheet D will be ready for use in December.

One of the handsomest and most effective show-cards that we have had sent us is that recently published by the National Phonograph Co., Ltd. It is an oval portrait of Edison, with the famous trade mark signature underneath, and at top the words "Edison Phonographs and Edison Gold Moulded Records." The background of the card is apparently of mahogany, and the graining of the wood is really wonderfully well imitated. The card is actually of steel, and is nineteen inches by thirteen.—*Talking Machine News, London.*

LOOK OUT FOR BOGUS PARTS.

Dealers are cautioned against buying bogus parts for Edison Phonographs, reproducers and records. Order Edison parts and insist upon having them. The difference in cost between Edison parts and imitations is trifling but the difference in quality makes the latter much more expensive in the end, to say nothing of the dissatisfaction of customers who get the inferior parts.

STOLEN PHONOGRAPH.

F. H. Van Duzer, a Dealer at Port Richmond, Staten Island, N. Y., had a Home Phonograph No. 144854 stolen from his store on the night of September 14. If any Dealer is asked to buy it he should hold the machine and notify Mr. Van Duzer.

READ THE MONTHLY.

It is to be regretted that many Jobbers and Dealers do not pay sufficient attention to the information given them in these columns. This is especially true of printed matter. Much correspondence could be saved if they would read and remember the information given them, especially that concerning the issuance of new forms of printed matter and also of forms, the editions of which become exhausted.

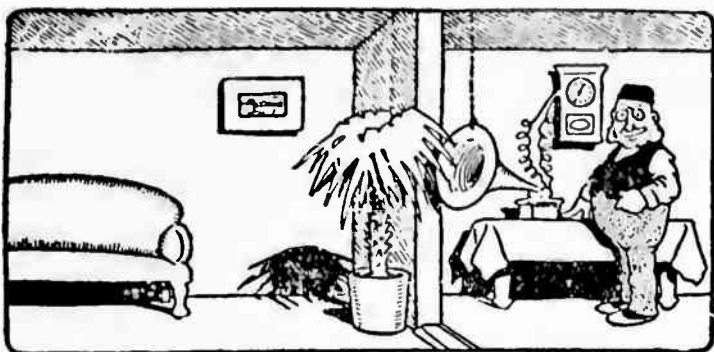
HOW FATHER OUTDID EDISON.

"I'll bet you that I'm not kept awake until midnight by that gabby Clarence."

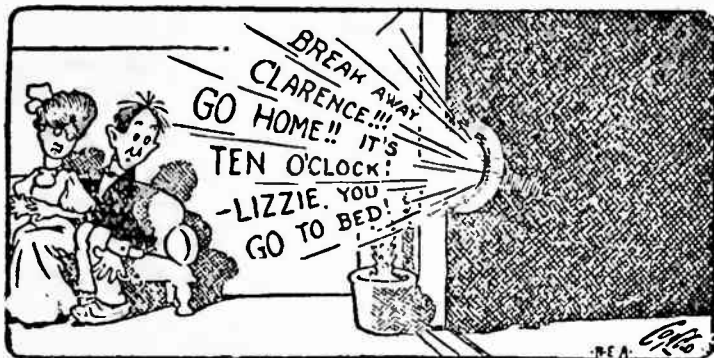

And he wasn't.

Courtesy of Talking Machine World.

COULDN'T RESIST ITS CHARMS.

I sold a Home outfit recently to a man that said he would not have a talking machine in his home. I said to him, "Yes you would if you heard an Edison Phonograph." He said, "No I would not have one." "Well," I said, "you let me bring an Edison Home machine up to your home and you will be delighted so much, and so surprised, that you will buy one at once." So he consented to let me bring it to his home. I took it with the latest Records and I sold him the Home machine, a large horn and stand and three dozen Records, and he is now one of my best customers. I won him over to the Phonograph completely. He told me that he was delighted with it and would not part with it for anything.

W. H. DYER,
Frederick, Md.

BOUGHT THE WHOLE LIST.

As it may be interesting to you to note the value of your methods of advertising, we relate an instance that was quite interesting to us, which happened a few days ago. A gentleman came in with a full page from *McClure's Magazine* containing the Edison advertisement, wherein any one interested was requested to call upon the nearest dealer and hear several select numbers. After hearing two or three pieces, he requested that we wrap up the entire list without exception. This is rather unusual, but quite satisfactory.

SOUTHERN PHONOGRAPH Co.
Birmingham, Ala.

GREAT AID IN MISSIONARY WORK.

The following is an extract from a letter received from the Rev. J. H. Pettee, for twenty-seven years a missionary in Japan:

"I am constantly using my Edison Phonograph to the great delight of foreigners and Japanese, civilians and soldiers, missionaries and merchants, adults and children, Russian prisoners and Japanese wounded soldiers, Buddhists and Christians, and the public generally. It is a great aid to my missionary work."

DEALERS WHO ADVERTISE.

Interesting advertisements setting forth the merits of Edison Phonographs and Records have recently been received from the following: Merrill Bowers, Le Roy, Minn.; Ball-Fintze & Co., Inc., Newark, Ohio; Buckeye Music Co., Rudolph, Ohio; Bennett & Co., Cloyuet, Minn.; Theo. F. Bentel Co., Pittsburg, Pa.; Peter Bacigalupi, San Francisco, Cal.; Christianson Bros. Co., Racine, Wis.; T. B. Davis, Logan, Utah; E. F. Droop & Sons Co., Washington, D. C.; Eastern Talking Machine Co., Boston, Mass.; Foster & Foster, Spokane, Wash.; Finch & Hahn, Albany, N. Y.; W. P. Herms, Hemstead, Texas; Household Furniture Co., Providence, R. I.; J. E. Harding & Son, Norfolk, Va.; Dan Irick, Rushsylvania, Ohio; Kramer's Music House, Allentown, Pa.; F. I. Lamson, Rockland, Me.; J. B. Lawton, Phenix, R. I.; H. L. Miller, Oakwoods, Texas; J. B. Meiler & Son, Dayton, Ohio; C. C. Mellor Co., Pittsburg, Pa.; Fred C. Morgan, Pine Plains, N. Y.; McGreal Bros., Milwaukee, Wis.; C. E. Osgood Co., Boston, Mass.; R. L. Penick, Montgomery, Ala.; J. F. Schmelzer & Sons Arms Co., Kansas City, Mo.; Aaron A. Snow, Orleans, Mass.; Springfield Music Rooms, Springfield, Vt.; Shadow Town Co., Baraboo, Wis.; E. F. Shad, Jacksonville, Fla.; Spratt & Corcoran, Watertown, N. Y.; J. Samuels & Bro., Providence, R. I.; Superior Phonograph Co., Superior, Wis.; R. E. Snipes, Selma, N. C.; Simons Music Store, Ottawa, Ill.; Texas Phono. Co., Houston, Texas; Thos. Wardell, Lowell, Mass.; H. O. Wiles, Sidney, Ohio; N. G. Woodward, Defiance, Ohio.

A FINE BUSINESS SHOWING.

Spratt & Corcoran, of Watertown, N. Y., became Dealers in Edison goods on December 3, 1904, with three machines and 150 Records. At that time there were several other Edison Dealers in Watertown. They at once saw the possibilities in the business and began to push the line in a most aggressive manner, becoming large advertisers in local mediums and using other up-to-date methods. On July 19 they reported that their business for less than eight months was as follows:

13288 Edison Records.
7 Gem Phonographs.
198 Standard Phonographs.
54 Home Phonographs.
2 Triumph Phonographs.

COMMENTS ON EDISON GOLD MOULDED RECORDS FOR NOVEMBER 1905.

With the advance of the amusement season and the development of song hits by the various music publishers, there comes such a variety of material suitable for Record making that it is quite a task to know what to put out first. We feel that in making up this November list our Recording Department has shown excellent judgment. It has produced twenty-four Records of unusual merit and sufficiently diversified in character to meet the approval of all. From a recording standpoint they are also fine.

No. 9122, "Hungarian Fantasia," by the Edison Concert Band, is a well-known composition by Theodore M. Tobani, written in Hungarian style and made up of Hungarian selections. It has all the characteristic snap of Hungarian music, and our Concert Band has interpreted it in a manner only obtained by a thoroughly efficient organization.

No. 9123, "Mother O' Mine," sung by Theodore Van Yorx, is by Rudyard Kipling and it has been set to music by Frank E. Tours. The music is of a dramatic character in the climaxes, which are well brought out by Mr. Van Yorx. Mr. Van Yorx's fine voice is winning him a host of Phonographic friends. The words of "Mother O' Mine" are:

If I were hanged on the highest hill,
Mother O' Mine,
I know whose love would follow me still,
Mother O' Mine.

If I were drown'd in the deepest sea,
Mother O' Mine,
I know whose tears would come down to me,
Mother O' Mine.

If I were damn'd of body and soul,
I know whose pray'rs would make me whole,
Mother O' Mine.

No. 9124, "On the Banks of the Rhine with a Stein," by Collins and Harlan, is a waltz song by Harry Von Tilzer and Andrew B. Sterling, writers of "Under the Anheuser Bush," (our Record No. 8575). The music is of the same general character and fully as attractive. The song tells of the pleasures of a chat with the boys alongside of the well-filled stein. It is a new composition and is sung with much spirit by Collins and Harlan, with orchestra accompaniment.

No. 9125, "Friendly Rivals," is another splendid cornet duet by Herbert L. Clarke and John Hazel. Mr. Clarke is the principal cornet soloist of Sousa's Band, and Mr. Hazel is principal cornet soloist of the Edison Military Band. The music is of a polka character. Its writer is Carl Fischer.

No. 9126, "Honeymoon Hall," by Harry MacDonough, is a waltz song from "The Pearl and the Pumpkin," which had such a run at the Broadway Theatre, New York. Its music was written by John W. Bratton, and the words by Paul West. It is of a serio-comic order. It is finely sung by Mr. MacDonough, who is accompanied by the orchestra. The chorus follows:

Honeymoon, Honeymoon Hall!
O, the rent there is nothing at all,

'Tis in Bill and Co's street,
All the rooms are "ensuite"
And upon you no creditors call.
Down in Honeymoon, Honeymoon Hall!
It is crowded in springtime and fall;
And the band plays the wedding march
Down in Honeymoon, Honeymoon Hall.

No. 9127, "In Timbuctoo," by Billy Murray, is a monkey ditty not unlike "Come Down from the Big Fig Tree," by the same composers (Theodore Morse and Ed. Madden), except that "In Timbuctoo" will be judged more tuneful and interesting. We predict a big success for this song and for our Record of it. Mr. Murray has the assistance of the orchestra in his excellent rendition of this song.

No. 9128, "Jesus, Saviour, Pilot Me," by Anthony and Harrison, is a well-known gospel hymn by J. E. Gould and the Rev. Edward Hopper, and much requested by users of the Edison Phonograph. It is one of those selections that are as staple as the necessities. It will probably be a permanent selection in our catalogue. The Record is made with orchestra accompaniment.

No. 9129, "Bold Front March," by the Edison Military Band, was composed by F. R. Seltzer, who wrote "American Standard March." The Record is made by the Edison Military Band, under the direction of Mr. Seltzer, who is its leader. It is played with a vim and dash in keeping with its attractive title.

No. 9130, "Wait 'Till the Sun Shines, Nellie," by Byron G. Harlan, is a descriptive song with a march tempo chorus. It is one of the popular ballads of the present season. Harry Von Tilzer and Andrew B. Sterling, who wrote this song, seem to be always in touch with the wants of the public and to give it just what it wants in the song line. Mr. Harlan's sympathetic voice and style are admirably suited to this selection. It is sung with orchestra accompaniment.

No. 9131, "And the World Goes On," by Bob Roberts, is the song hit sung by Raymond Hitchcock in his new comedy drama "Easy Dawson." Mr. Roberts makes the Record with such a perfect imitation of Mr. Hitchcock's manner of singing that it is hard to realize that Mr. Hitchcock is not singing himself. All who are familiar with this actor's style will appreciate the imitation. The singer is accompanied by the orchestra. The song is written by Harry O. Sutton (music) and Jean Lenox (words).

No. 9132, "Betty," by MacDonough and Biehling, is a swingy rhythmical schottische tempo melody, set to a sentimental story and sung in good style by these popular duettists, with orchestra accompaniment. The chorus follows:

Betty, my sweetest little fairy,
Betty I love you true,
Tell me just when we are to marry,
Give me your answer, do;
Betty, just tell me what's to hinder,
Betty, with dainty form so slender,
Betty, with eyes of blue so tender,
I love you.

No. 9133, "Roses and Thorns," by the Edison Symphony Orchestra, is a Mexican dance previously listed in the old style Record catalogue. It is brought forward again on account of its beautiful melody and the fact that

it is well adapted to our present methods of recording orchestra selections.

No. 9134, "We'll Be Together When the Clouds Roll By," is a sentimental ballad by Irving Gillette. A monthly supplement that did not include a selection by Mr. Gillette would now be regarded as incomplete by thousands of Phonograph owners. By many he is regarded as one of the best tenor singers we have ever had. This song by Kerry Mills and Alfred Bryan is well suited to Mr. Gillette's voice and cannot fail to be widely sought. The Record is made with orchestra accompaniment. The words follow:

We'll be together, sweetheart, when the clouds roll by,
Let your heart be cheery, dearie, don't you cry;
When the winter days are o'er, in the spring time,
you and I,
Will be together when the clouds roll by.

No. 9135, "I'm the Only Star that Twinkles on Broadway," by Ada Jones, was written by Harry Von Tilzer and Andrew B. Sterling and is sung in Miss Jones' usual attractive style with orchestra accompaniment. The following words tell how the "star twinkles":

Now I am a Broadway star all right,
I'm the only star that twinkles on Broadway,
All the other stars are only shines they say,
I'm a public benefactress, I'm a lady and an actress,
Why I'm making Leslie Carter's hair turn gray;
I remember when Belasco saw me play,
He threw up his hands and fainted dead away,
Richard Mansfield lost his reason,
'Cause I signed with Hill next season,
I'm the only star that twinkles on Broadway.

No. 9136, "Pretty Mary," by Harlan and Stanley, is a beautiful sentimental ballad of the old time "Sweet Marie" order. It is just as tuneful and singable, and on its merits, both words and music, ought to be just as popular. The blending of the voices of Mr. Harlan and Mr. Stanley is in perfect sympathy with the old but ever new and interesting story and the charming melody to which it is set. It is sung with orchestra accompaniment. The music is by Kerry Mills and the words by A. B. Sterling.

No. 9137, "Dancing in the Starlight," by the Edison Concert Band, is a delightful light number of the caprice-gavotte order and well worth a place in the most exclusive collection of Records. J. Henry Ellis is the composer.

No. 9138, "The Sweetest Flower that Blows," by Marie Narelle, is a sentimental song by Charles B. Hawley (music) and Frederick Peterson (words). Splendidly sung by Miss Narelle with orchestra accompaniment. The words follow:

The sweetest flow'r that blows,
I give you as we part,
For you it is a rose,
For me it is my heart;
The fragrance it exhales,
Ah! if you only knew,
Which but in dying fails,
It is my love for you.

No. 9139, "Have You Seen My Henry Brown?" by Arthur Collins, is a new coon song that fits Mr. Collins' voice and style as if it were written especially for him. Sung with orchestra accompaniment. Henry Brown has left his loved one, who states her desire to find him in the following words:

Have you seen my Henry Brown,
Any place a-hanging 'round?
I won't never rest till he am found.
I'm going to hunt all over town,
For that scamp that threw me down;
On my knees, I ask you please, have you seen my
Henry Brown?

No. 9140, "The Irish Girl I Love," is sung by Edward Barrow a well-known English tenor, who here makes his first Record for the Edison Phonograph. Mr. Barrow commenced his musical studies when but a youth. Going to London he entered the Royal Academy of Music, placing himself under Arthur Thompson, an eminent professor at the Conservatory, and later under Signor Alberto Randegger, and graduated with the highest honors. Coming to this country he continued his studies with Victor Harris. He now makes New York City his home. He is solo tenor at the Central Congregational Church, New York City, and he has appeared in concerts with the most prominent singers of the country. His first Edison selection is from "Rogers Brothers in Ireland," which opened at the Liberty Theatre, New York, in August. The song is one of the gems of the play. It has a slow waltz movement. It was written by Max Hoffman (music) and George V. Hobart (words), and the orchestra accompanies the singer.

No. 9141, "Sweet Little Daisies," by Albert Benzler, is a bells solo with orchestra accompaniment. It is one of those pretty song and dance movements that have been so well received as bells numbers and which admit of splendid orchestral embellishment in the accompaniment. The Record will rank among the best of Mr. Benzler's solos. "Sweet Little Daisies" was composed by Frank R. Seltzer, director of our Military Band.

No. 9142, "Fol-the-rol-lol," by Edward M. Favor, comprises eight nonsensical verses set to the old Fol-the-rol-lol tune. Four choruses are also introduced, being sung by male voices. The Record is one that will be very popular because of its extremely ludicrous character.

No. 9143, "Courtship of Barney and Eileen," by Ada Jones and Len Spencer, is another clever vaudeville specialty with orchestra accompaniment. This is quite unlike the specialties heretofore made by Miss Jones and Mr. Spencer, but is just as clever. It tells in Irish dialect of how Barney courted Eileen.

No. 9144, "When the Evening Breeze is Sighing 'Home, Sweet Home,'" by the Edison Male Quartette, is a charming descriptive ballad given in quartette form, effectively arranged, and sung with orchestra accompaniment with the same blending of voices and artistic style that have made the Records of this quartette so popular. The words of the refrain follow:

And the breezes still are sighing as they sighed that
summer's eve,
When through the world I started forth to roam;
And it seems that I can hear the Mother's voice to
me so dear,
When the evening breeze is sighing "Home, Sweet
Home."

No. 9145, "Everybody Works But Father Medley," by the Edison Military Band, introduces five popular songs as follows: "Everybody Works But Father," our Record No. 9100; "Leader of the German Band," our Record No. 9115; "Angelena," our Record No. 9112; "In Dear Old Georgia," our Record No. 9099, and Hiram Green, Good Bye," our Record No. 9118.

A COMFORTABLE ENGLISH ORDER.

Our London office sends us a copy of an order placed with them on July 12 by John G. Murdock & Co., Ltd., 91 and 93 Farringdon road, London, calling for the delivery of 3,160 Phonographs during August to November, inclusive. It was as follows:

Please supply the following:
 1,400 "Gem" Phonographs @ 42s. less 40%
 1,400 "Standard" " @ 84s. less 50%
 360 "Home" " @ 126s. less 50%
 To be sent us direct from the States.
 Delivery to be made as follows:

		STAND- GEMS.	ARDS.	HOMES.
To be shipped on	August 1st.....	350	350	90
" " " "	September 1st..	350	350	90
" " " "	October 1st....	350	350	90
" " " "	November 1st...	350	350	90
		1400	1400	360

SLOT PHONOGRAPHS IN GREAT FAVOR.

The advantage of the Phonograph to the public at large is being greatly appreciated by all classes. Take, for instance, the amusement parlors found in the shopping districts of all of the large cities, where for a cent one is able to hear many of the great singers sing their favorite songs and ballads and operatic selections. Then, again, the National Phonograph Co. have their own orchestras and bands, and every day these orchestras and bands are playing for the purpose of making Records of all the latest popular music, particularly marches and operatic selections. The Records which are manufactured for this purpose often cost large sums of money, and evidently there has been no expense spared on the part of the manufacturer to obtain for the public the very finest material at hand. In all sections of the country these penny arcades, as they are popularly styled, are meeting with great success. This not only opens up a field for the manufacturer in the arcade business itself but increases the popularity and demand for the Phonograph, because in many instances where the Phonograph is unknown comparatively, in the rural districts particularly, folks visiting the city are attracted by the glamor and glare of these places and visit them, immediately becoming imbued with the idea that they must have a Phonograph for their own home. The price at which they are sold places them within the reach of nearly every one.

The American Phonograph Co., of Detroit, recently received the following letter from a customer to whom they had sold an Edison Standard Phonograph, allowing him \$7 for his disc outfit which had cost him \$35:

"I received the Standard Phonograph yesterday all right and notice that it is put in a fine quarter-sawed dark golden oak finished cabinet. After using a _____ machine for two or three years the difference is so great that I don't think I would have been better pleased if you had sent me a deed for a half interest in your business."

THE PHONOGRAM.

Dealers desiring to get a supply of *Phonograms* to mail to their customers must order them of Jobbers four weeks in advance, and we cannot agree to fill Jobbers' orders unless placed with us a similar period in advance. We plan to print about 10,000 more than we have orders for when we go to press, five weeks in advance of the month of issue, but frequently these are soon used up with extra orders. Following is a schedule of prices at which *Phonograms* may be obtained by the trade:

DELIVERED WITH GOODS.	
Blank, per 1000 copies.....	\$2.50
Smaller quantities pro rata.	
Imprinted, per 500 copies.....	1.50
Imprinted, per 1000 copies.....	2.75
No orders filled for less than 500 copies requiring imprint, and all imprinting orders must be for multiples of 500.	
Jobbers will be glad to supply Dealers on the above basis.	
BY MAIL.	
Single copies, per year.....	\$.20
Five copies to one address, per year.....	.40
Twenty-five copies to one address, per year....	1.80
Fifty copies to one address, per year.....	3.60

Unless they have open accounts on our books, Dealers ordering *Phonograms* sent by mail are requested to send cash or stamps with their orders. The amounts are too small to handle in any other way.

A HEARING CONVERTED HIM.

Walter Rolfe, a Dealer in Edison Phonographs and Records at Rumford Falls, Me., relates the following incident "While in my store a few days ago I was engaged in conversation with a gentleman of considerable musical ability and he inquired, 'How is business?' When I informed him that the Phonograph business was especially good, he laughed and remarked that he could not understand how intelligent people could be induced to invest their money in such 'misery boxes.' Upon this I started my Home Phonograph with a late, high-class orchestra Record. When I finished playing it there was a look of surprise on his face. 'Why,' he remarked, 'that is beautiful. It beats anything I ever heard on a talking machine. That must be a better machine than the average.' I replied that it was no better than any of the late model Edison Phonographs and I entertained him for a solid half-hour with some of the late Gold Moulded Records. When he left the store he was glad to take back his remark regarding the Phonograph and said it was the best concert he had listened to for many months and was a wonderful improvement on the cheap scratchy machines he had been accustomed to hearing."

WHAT AN ILL WIND DID.

Last week a large touring car stopped here for repairs. One of the party fell in love with the Phonograph. I had one running while they were waiting. I sold him a Standard and three dozen Records and they left for Olean, N. Y., with the Edison playing No. 9017.

G. C. Coe,
 East Aurora, N. Y.

A PHONOGRAPH CLUB.

ROCKDALE, TEXAS, SEPT. 6, 1905.

Here is a selling scheme that might be of interest to the trade. I have a Phonograph Club consisting of twenty members. Each member pays \$1 per week for twenty weeks and the club buys one machine a week. Then they draw to see which member gets the machine that week, and the member who gets the machine does not draw again but pays his dollar every week till he has paid \$20. The club takes a mortgage on the machine for balance due. You see, I sell a Standard machine a week to this club. I get cash for the machine and the club gets twenty weeks' time. You see this gives me a cinch on selling twenty Standard machines, and the members believe they have twenty weeks to pay for their Phonograph, but there is only one goes out every week till every member has a machine. The beauty of this plan is when a member draws for eight or nine weeks without getting a machine he will come in and pay the balance and get his machine. The way I manage the drawing is this: I write each man's name on a slip of paper and put it in a small envelope and seal it up. I draw one out each week and open it and the name inclosed gets the machine that week. I think when I get these twenty machines out, and others I sell to parties who do not belong to the club, I will have a fine Record business. I have handled other machines here but did not make a success of it as the price of the records was too high. I have got every one Phonograph crazy here now and I am expecting a large trade.

J. B. ASHBY.

500 EDISONS TO ONE OF ALL OTHERS.

ALBANY, N. Y., AUG. 31, 1905.

Your letter enclosing a reference to a prospective purchaser received. I appreciate your favor very much, and commend the adoption of your follow-up system. I think it will prove a great benefit to Dealers and Jobbers as well as to the National Phonograph Co. I have received many favorable comments on the fine list of records for September, both in regard to the tone and quality and the artists in general. While I handle other records besides Edison Gold Moulded Records, I sell but few of them, for the Edison Records excell them all. I sell 500 Edison Records to every one of the other makes. Many of my patrons say, give me the Edison Record or none at all, even if the selection wanted is made by other companies and not on the Edison Record. When I first started in business, my store was small, but before long I had to get a larger place, thereby increasing my trade. I look for a prosperous fall and winter business.

MARK A. ODY,

1122 Broadway.

WANT NONE BUT EDISON MAKE.

BLUFFTON, INDIANA, AUG. 21, 1905.

I formerly handled disc goods exclusively, but since I put in the Edison line my talking machine business has doubled many times over and I find it almost impossible to sell any other make. In fact, I have sold but one disc machine in seven months.

The people don't want them after they hear the Edison.

Your Records as you are now making them, are simply wonderful and outclass every other line. I find that it pays to carry a complete assortment prominently displayed. The arrangement of record stock which you illustrated in your August PHONOGRAPH MONTHLY, has been in use by me for some time. It is certainly fine and establishes the confidence and enthusiasm of customers the moment they enter my store.

GEORGE D. SHIGLEY.

A FINE PHONOGRAPH STORE.

Foster & Foster, Edison Dealers at Spokane, Wash., send the following description of their new store:

"We now have the swellest Phonograph store in the Pacific Northwest, having the whole store, where heretofore we have only had half of it. The size of our store now is 20 x 60. It has two swell display windows. The interior decorations and woodwork are in dark golden oak, both sides of the store being shelved and numbered from 2 to 10,000, numerically arranged from 0 to 9. In the back of store we have arranged a shipping room and a very pretty Phonograph parlor, where we can take a prospective buyer and show him what a machine will do in a room similar to one in his home. The store is very high, and we have a balcony over these rooms which we will finish off later, and by double-decking the front part we will have lots of room.

"The new Records from month to month are getting better and better, and we wonder if the company will ever quit improving."

A STRONG ENDORSEMENT.

Brown Brothers, of Great Eastern street, London, in a recent advertisement of their business used this unusually strong phrase: "Worth Handling; Genuine Edison Phonographs and Gold Moulded Records; *absolutely the most perfect talking machines* and Records yet introduced." The italics are ours. It is significant when a firm with the standing of Brown Brothers, without solicitation, prints such a sweeping and unqualified endorsement of the Edison product.

WHY HE IS SUCCESSFUL.

SALEM, INDIANA, AUG. 18, 1905.

Having noticed in this month's PHONOGRAPH MONTHLY a description of F. L. Fritchey's "step" shelving as applied and used by some of the large Dealers of Edison goods, we thought possibly the readers of the MONTHLY might be interested in the application of the plan to the needs of the smaller Dealer in a town of 2,000 people. Our initial order for Edison goods was received some four months ago. Since that time we have done a very fine business and we attribute it to the method of showing the goods, judicious advertising, and last, but not least, the superiority of Edison Phonographs and Records. In this section of the country we find that the price of the Edison Record as compared with the dollar records of the other kind, is a point to be emphasized in our advertising, and then, after the possible purchaser hears them and the musical tone produced, it is no trouble to sell him an outfit. This may appeal to other small Dealers. There are other machines on sale in this town, but so far as we can learn, not one of them has been sold since we have been selling Edison goods.

H. H. ROUTH & SON.

CONTRAST MADE A QUICK SALE.

I am delighted with the Phonograph business. It is on the increase. I am putting out twice as many machines as last year. My clerk was conducting a free concert a few days ago when a gentleman came into the store and asked if it was possible for the Home Phonograph to record and reproduce all the Records advertised. I overheard the remark and replied that it would record the voice of a mule as well as the beautiful songs we had played. We played Record No. 8971, "Yankee Patrol," and then No. 8721, "The Mule Song." He at once said, "I want the machine." In one hour I had his outfit loaded on my auto car and delivered three miles in the country. I don't sell any other make of machines and my customers are all delighted and have the best.

G. R. WARREN,
Slatington, Pa.

ORANGE BLOSSOMS AND THE PHONOGRAPH.

This is the way J. A. Leiszy, a Dealer at Richmond, Cal., recently sent an order to Peter Bacigalupi, Edison Jobber at San Francisco:

"Send by next mail to S. C. Dole, Richmond, Cal., Record No. 120, 'Mendelssohn's Wedding March.' Party is so enthused over the Phonograph just purchased that the wedding march is to be played on it at their daughter's wedding."

A BETTER ONE NOT SOLD.

Here's the way Thomas Wardell, Edison Jobber at Lowell, Mass., put it in a circular letter sent to his patrons recently.

The undersigned has had eleven years' experience in the talking-machine business. In that time I have heard, handled and sold all makes of records. I am now as you are aware, handling Edison Records almost exclusively, because I believe they are the best in wearing qualities, and **ESPECIALLY IN QUALITY OF TONE**, consequently they are **THE CHEAPEST RECORD IN THE MARKET**.

When I find a better Record than the Edison, I shall be glad to handle it.

Edison Records advertise themselves.

THE YOUNGSTER KNEW THE DIFFERENCE.

"Here is a little incident you can make use of," writes T. L. Thomas, a Dealer at Hazelton, Pa. "A customer came in this week to buy Records. I have a half-dozen of another make which I don't sell. I have them here for comparison only. I went to put one on the machine for comparison when a little boy six years old, who was with the lady, when he saw the box, begged me not to put it on the machine, and asked that I should take one out of the box that had Mr. Edison's picture on, as Mr. So and So, their neighbor, had the other kind and they did not play as loud as the ones that had Mr. Edison's picture on. Of course I complied for the time being, but I hunted the neighbor up and got him to my place, allowed him \$2.50 for his old machine and sold him a Standard, horn and stand and forty-two Records. So you see the children know the difference between the real and the imitation."

CERTAIN TALKING MACHINES TOO MUCH FOR PEOPLE OF MARION, O.

MARION, O., SEPT. 9, 1905.

Citizens of Marion are up in arms against "talking machines." They have stood for the piano practice and the girl taking lessons in voice culture, *but the disc concerns are the limit*. The chief complaint seems to be that the machines disturb their nightly slumbers, though some assert that they get tiresome through the daytime, especially as they are forced to hear the same old tune many times a day. A long petition has been presented to the police protesting that a certain machine was becoming a public nuisance. An investigation will be made.—Hamilton, O., *Evening Democrat*.

In sending the above clipping a Dealer notes: "Recently a show exhibiting in a large tent made a week's stand in this city. They had a disc machine which they used throughout the show. It was awful—both show and disc."

A DEALER'S WAY OF ADVERTISING RECORDS.

TURNER'S FALLS, Mass., Sept. 7, 1905.

I have an advertising sheet that I am sending out every month. This has proven very profitable to me. I am getting mail orders from Vermont and New Hampshire. If I get hold of a party who has ever even told his friend or neighbor that he was going to get a Phonograph sometime I enter his name on my list and send him the circulars, together with a PHONOGRAM each month. I have got enough sales from this sheet so far to pay for its cost for years. It will help others as it helps me.

G. A. GOVE.

The sheet referred to was a circular 8½ x 11 inches in size. At the top was printed Mr. Gove's letter head. Below it were the words "Edison September Records Received Today." Then followed a brief description of about a dozen of what Mr. Gore considered the best in the September list. The descriptions were condensed from those in the August PHONOGRAPH MONTHLY.

IN THE REALM OF MUSIC AND SONG.

Robert M. Reese, of Hamilton, Ohio, sends a show bill and programme of a Phonograph entertainment given by him recently. It was announced as a "Grand Double Phonograph Entertainment by the Edison Concert Co. One hundred and twenty minutes in the realm of music and song. The prince of entertainers—The Phonograph—will delight its hearers with: Exquisite operatic selections, charming melodies, famous band and orchestral productions, comic and sentimental songs, recitations—comic and dramatic; and everything in the way of pleasures that appeals to the sense of hearing."

The programme included forty-eight specially selected Edison Records.

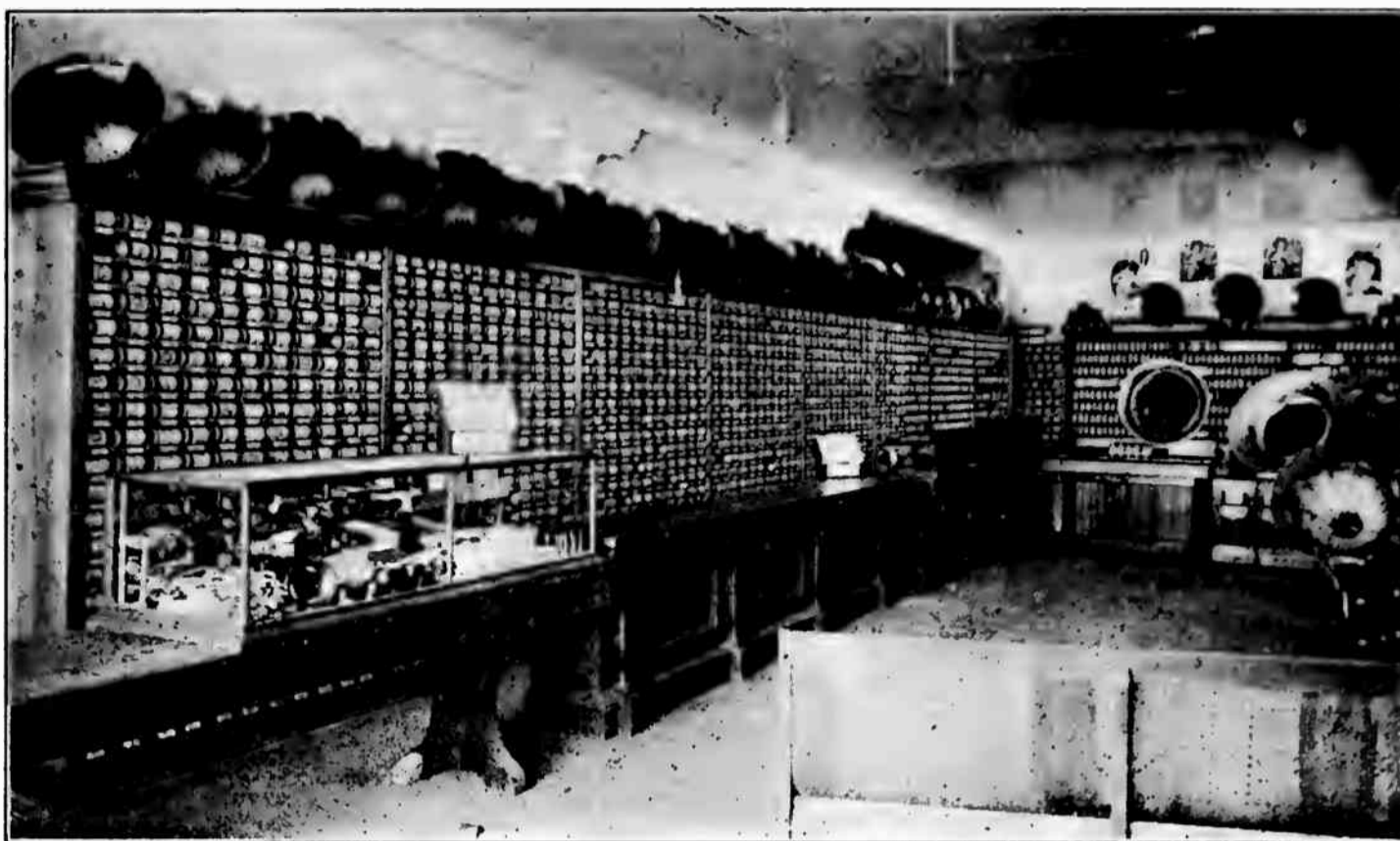

SECTION OF STORE OF TEXAS PHONOGRAPH CO., HOUSTON, TEXAS.

BEAT OUT THE "ROASTERS."

"The enclosed letter explains itself, coming as it does from a man of prominence," wrote the Santa Fe Watch Co., of Topeka, Kan., recently. "The Saturday Night Club has never before been known to allow a man to finish his speech. This time the speech was finished, not by a man, but by the Edison Home Phonograph and in a voice loud and plain enough to be heard anywhere in the hall. We heard the Records in our store and they were as loud and clear as any made in the factory."

The letter referred to was written by Judge R. A. Burch, of the Supreme Court, Topeka, Kan., and was as follows:

"I beg pardon for the long delay in expressing my thanks for the use of the Edison Phonograph at the Saturday Night Club banquet. Without ever before attempting the feat, I made a perfect Record of my speech at the first trial, and the reproduction was such that the 'joshers' and 'roasters' of the club could do nothing but wait until the machine had finished delivering the speech.

R. A. BURCH."

SIMPLY GRAND.

Accept my congratulations and thanks for your "Hungarian Rhapsody" and "Summer Night's Dream" just issued. They are *simply grand*. I consider them the most wonderful of anything you have yet produced. I cannot half tell you what the Phonograph is to me. It has opened up a field of pleasure and knowledge that has heretofore been almost inaccessible to me. Wishing you success for your high-grade machines and your most wonderful Records of *natural* tone.

PAUL R. STEVENS.
Portland, Me.

A SIDE LINE BUT PROFITABLE.

I have more orders on hand now for Edison goods than I have ever had since I have been in business. My books call for one Home, a Standard and four Gems, all cash sales. They are growing more popular every day. Wish I had \$500 to spare. I would invest it all in Edison goods. Your goods paid my rent through the winter. I hope to largely increase sales this winter.

Canaan, Conn. GEORGE W. FORD.

A LITTLE EDISON EXPERIENCE.

Two ladies came into my store and wanted to buy two machines, one each. I was loaded with disc machines and tried to run off a couple of them, so played the best records I had on the disc machine. Then they asked to hear the Edison. What did they do? Not a thing but take the two Edison machines. Moral—Keep a full line of Edison goods and do business.

C. V. YORK,
Carroll, Ia.



INTERIOR OF STORE OF HENRY L. SCHALL TALKING MACHINE CO., DECATUR, ILL.

JOBBER'S OF EDISON PHONOGRAPHS AND RECORDS.

ALABAMA.

Birmingham—Talking Machine Co., 2007 Second ave.
Mobile—W. H. Reynolds, 167 Dauphin street.
Montgomery—R. L. Penick, 119 Dexter ave.

CALIFORNIA.

San Francisco—Peter Bacigalupi, 786-788 Mission street.

COLORADO.

Denver—Denver Dry Goods Co., 619 16th street.
 *Hext Music Co., 15th and California streets

CONNECTICUT.

Middletown—Caulkins & Post Co., 406-408 Main street.
New Haven—Pardee-Ellenberger Co., 155 Orange st.

DISTRICT OF COLUMBIA.

Washington—E. F. Droop & Sons Co., 925 Pennsylvania avenue, N W
 S. Kann Sons & Co., 8th and Pennsylvania avenues.

GEORGIA.

Atlanta—Atlanta Phonograph Co., 49 Peachtree St.
Waycross—George R. Youmans.

ILLINOIS.

Chicago—James I. Lyons, 192 Van Buren street.
 Talking Machine Co., 107 Madison street.
 The Vim Co., 68 E. Lake street.
 Montgomery Ward & Co., 111 Michigan ave.
 Rudolph Wurlitzer Co., 302 Wabash ave.
Peoria—Peoria Phonograph Co., 222 Bridge street.
Quincy—Quincy Phonograph Co., 808 Hampshire st.

INDIANA.

Indianapolis—Craig-Jay Co., 234 Massachusetts ave.
 Kipp Bros. Co., 37 S. Meridian street.
 A. B. Wahl & Co., 119 S. Illinois street.
Lafayette—A. B. Wahl & Co., 304 Main street.

IOWA.

Des Moines—Hopkins Bros. Co., 620 Locust street.
 Vim Co., 704 West Walnut street.
Fort Dodge—Early Music House, 822 Central ave.

KENTUCKY.

Louisville—C. A. Ray, 640 Fourth street.

LOUISIANA.

New Orleans—William Bailey, 600 Frenchman street.
 National Automatic Fire Alarm Co.,
 614 Gravier street.

MAINE.

Bangor—S. L. Crosby Co., 186 Exchange street.
Portland—W. H. Ross & Son, 207 Commercial street.

MARYLAND.

Baltimore—E. F. Droop & Sons Co., 109 N. Charles St.

-MASSACHUSETTS.

Boston—Boston Cycle & Sundry Co., 48 Hanover street.
 Eastern Talking Mach. Co., 177 Tremont st.
 Iver Johnson Sptg. Goods Co., 163 Washington street.
 C. E. Osgood Co., 744 Washington street.
 Read & Read, 630 Washington street.
Fitchburg—Iver Johnson Sptg. Goods Co., 247 Main st.
Lowell—Thomas Wardell, 111 Central street.
New Bedford—Household Furnishing Co., 170 Purchase street.
Springfield—Flint & Brickett Co., 439 Main st.
Worcester—Iver Johnson Sptg. Goods Co., 304 Main st.

MICHIGAN.

Detroit—American Phono. Co., 106 Woodward ave.
 Grinnell Bros. 219 Woodward ave.

MINNESOTA.

Minneapolis—Thomas C. Hough, 714 Hennepin ave.
St. Paul—W. J. Dyer & Bro., 21-23 West 5th street.
 Thomas C. Hough, 392 Wabasha street.
 Minnesota Phonograph Co., 37 E. 7th street.

MISSOURI.

Kansas City—J. W. Jenkins' Sons Music Co., 1013-1015 Walnut street.
 J. F. Schmelzer & Sons Arms Co., 710 Main street.
St. Louis—Conroy Piano Co., 11th and Olive streets.
 O. K. Houck Piano Co., 1118 Olive street.
 Western Talking Machine Co., 923 Olive st.

NEBRASKA.

Lincoln—H. E. Sidles Cycle Co., 1317 O street.
Omaha—Nebraska Cycle Co., 15th and Harney streets.
 Omaha Bicycle Co., 16th & Chicago sts.

NEW JERSEY.

Hoboken—Eclipse Phono. Co., 205 Washington st.
Newark—A. O. Petit, New and Halsey streets.
Paterson—James K. O'Dea, 117 Ellison street.
Trenton—Stoll Blank Book and Stationery Co., 30 E. State street.
 John Sykes, 105 N. Broad street.

NEW YORK.

Albany—Finch & Hahn, 92 State street.
Brooklyn—A. D. Matthews' Sons, 394 Fulton street.
 Price Phonograph Co., 1260 Broadway.
Buffalo—P. A. Powers, 613 Main street.
Elmira—Elmira Arms Co., 117 Main street.
Gloversville—American Phono. Co., 99 W. Fulton st.
Kingston—Forsyth & Davis, 307 Wall street.
New York City—Bettini Phono. Co., 156 W. 23d street.
 Blackman Talking Machine Co., 97 Chambers street.
 J. F. Blackman & Son, 2737 3d avenue.
 Sol Bloom. New Amsterdam Theatre Building.
 I. Davega, Jr., 802 Third avenue.
 S. B. Davega, 32 E. 14th street.
 Douglas Phono. Co., 89 Chambers st.
 H. S. Gordon, 139 Fifth avenue.
 Harry Jackson, 219 Bowery.
 Jacot Music Box Co., 39 Union Square.
 Victor H. Kapke, 1661 Second avenue.
 Siegel-Cooper Co.
 John Wanamaker.
 Alfred Weiss, 1525 First avenue.
Oswego—Frank E. Bolway, 32 Bridge street.
Poughkeepsie—Price Phonograph Co., 203 Main st.
Rochester—A. J. Deninger, 345 North street.
 Mackie Piano, O. & M. Co., 100 State street.
 Giles B. Miller, 63 State street.
 Talking Machine Co., 97 Main st., E.
Schenectady—Finch & Hahn, 504 State street.
 Jay A. Rickard & Co., 253 State street.
Syracuse—W. D. Andrews, 216 E. Railroad street.
Troy—Finch & Hahn, 3 Third street.
Utica—Clark-Horrocks Co., 54 Genesee street.
 Arthur F. Ferriss, 89 Washington street.
 William Harrison, 41 Columbia street.
 Utica Cycle Co., 31 Columbia street.

OHIO.

Canton—Klein & Heffelman Co., 216 N. Market street.
Cincinnati—Ilsen & Co., 25 W. 6th street.
 Rudolph Wurlitzer Co., 10-12 W. 4th st.
Cleveland—Eclipse Musical Co., Jr., 162 Prospect st.
Columbus—Perry B. Whitsit Co., 213 S. High street.
Dayton—Niehaus & Dohse, 35 E. 5th street.
Newark—Ball-Fintze Co.
Toledo—Hayes Music Co., 608 Cherry street.

PENNSYLVANIA.

Allegheny—Henry Braun, 500 Federal street.
Allentown—G. C. Aschbach, 539 Hamilton street.
Easton—William Werner, 401 Northampton street.
Harrisburg—S. K. Hamburger, 12-14 N. Market sq.
New Castle—W. C. DeForeest & Son.
Philadelphia—C. J. Heppe & Son, 1117 Chestnut street.
 Lit Bros., Market and 8th streets.
 Penn Phonograph Co., 17 S. 9th street.
 John Wanamaker, 13th and Market sts.
 Wells Phonograph Co., 45 N. 9th street.
 Western Talking Mach. Co., 25 S. 9th st.
 H. A. Weymann & Son, 923 Market st.
Pittsburg—Theo. F. Bentel Co., Inc., 632 Liberty street.
 Kaufmann Bros., Fifth avenue.
 H. Kleber & Bro., 221 Fifth avenue.
 C. C. Mellor Co., 319 Fifth avenue.
 Pittsburg Phono. Co., 937 Liberty street.
 *Talking Machine Co., 619 Penn ave
Reading—Reading Phonograph Co., 809 Penn street.
Scranton—Ackerman & Co., 130 Wyoming avenue.
 Technical Supply Co.
 *Williamsport—W. A. Meyers, 145 W 3d st.

RHODE ISLAND.

Pawtucket—Pawtucket Furniture Co., 39 N. Main St.
Providence—J. M. Dean Co., 785-795 Westminster street.
 J. A. Foster Co., Weybosset st.
 Household Furniture Co.
 J. Samuels & Bro., 154 Weybossett street.
 A. T. Scattergood & Co., 106 N. Main st.

TENNESSEE.

Knoxville—Knoxville Typewriter and Phonograph Co., 421 Gav street.
Memphis—O. K. Houck Piano Co., 359 Main street.
 F. M. Atwood, Lvceum Building.
Nashville—Nashville Talking Mach. Co., 510 Church st.
 Magruder & Co., 13 Arcade.

JOBBER OF EDISON PHONOGRAPHS AND RECORDS—Continued.

TEXAS.

Dallas—Southern Talking Machine Co., 347 Main st.
 El Paso—W. G. Walz Co., 101 El Paso street.
 Fort Worth—Cummings, Shepherd & Co., 700 Houston st.
 Houston—Texas Phono. Co., Capitol and Fannin Sts.
 San Antonio—H. C. Rees Optical Co., 242 West Commerce St.

VIRGINIA.

Richmond—Magruder & Co., 729 E. Main st.

WISCONSIN.

Milwaukee—McGreal Bros., 173 3d street.

CANADA.

Toronto—R. S. Williams & Sons Co., Limited,
 143 Yonge street.

Winnipeg—R. S. Williams & Sons Co., Ltd., 121 Princess street.

*Added since September 1, 1905.

SUSPENDED LIST, OCTOBER 1, 1905.

SUPERSEDING ALL PREVIOUS LISTS.

ILLINOIS.

*Champaign—Eggleston Bros.
 Chicago—H. E. Everett, 6134 S. Halsted street.
 Ottawa—Edward Hayne.
 Wheaton—E. Irving.

INDIANA.

South Bend—EUGENE MARSH, 126 Vistula avenue.
 SOUTH BEND BOOK BINDERY, Robert
 Lebolt, Prop., 203 North Michigan street.

IOWA.

Burlington—JOHN P. WEISS, 711 Jefferson street.
 Sioux City—HATTENBACH BROS. CO.
 A. V. LARIMORE, 518 Fifth street.

KANSAS.

Clay Centre—E. M. GOWENLOCK.
 Lawrence—BELL BROS.
 *Topeka—R. H. MOREHOUSE, 510 E. 4th street.

MAINE.

Biddeford—W. H. FIELD.
 Lewiston—J. W. SKENE.
 Monmouth—G. H. STETSON.

MASSACHUSETTS.

Boston—*E. C. PECK, 43 Milk st.
 T. SINGER, 60 Leverett street.
 Lawrence—LORD & CO., 314 Essex street.
 E. O. MOSHER, 420 Essex street.
 Lynn—ELIAS DEYOUNG.
 Malden—A. T. FULLER.
 Nantucket—ARTHUR M. TAYLOR.
 New Bedford—H. B. DEWOLFF.
 Somerville—E. J. WINCHESTER, 32 Summit avenue.
 Woburn—OSBORN GILLETTE, or THE BOLTON
 JEWELRY CO., L. F. Maloney, Manager.

MICHIGAN.

Detroit—F. J. SCHWANKOVSKY.
 Saginaw—GEO. W. EMENDORFER.
 JAMES V. CALAHAN, 217 Genessee st.
 TIERNEY BROS., 217 Genessee st.

MISSOURI.

Kansas City—THE WITTMANN CO.

NEBRASKA.

Lincoln—THE WITTMANN CO.
 Omaha—THE WITTMANN CO.

NEW HAMPSHIRE.

Hillsboro Bridge—E. M. BARNES.
 Manchester—A. E. DUMAS
 Nashua—F. A. McMASTER & CO.

NEW JERSEY.

Atlantic City—SAM'L D. WOLF, 32-34 Arkansas ave.
 Bayonne—I. WIGDOR, 450 Avenue D.
 Jersey City—W. L. HOFFMAN, 151 Montgomery st.
 Newark—R. L. CORWIN; also New York City.
 Passaic—I. HURWITZ.
 Paterson—CHAS. H. KELLY, 25 N. Main street.

Plainfield—S. W. FRUCHT, or R. FRUCHT; also
 New York City.

ELSTON M. LEONARD.

West Hoboken—EMIL HOLLANDER, or THE WEST
 HOBOKEN BICYCLE & PHONO. CO., 619
 Spring street.

NEW YORK.

Albany—G. LINDE, 353 S. Pearl street.
 Bedford Park—GEO. H. TYRRELL.
 Brooklyn—WM. ALBRECHT, 204 Knickerbocker ave
 H. HINDERMANN, BUSHWICK PHONO-
 GRAPH EXCHANGE, 1421 Myrtle avenue.
 Hobart—F. H. MARSHALL.
 New York City—A. T. ARMSTRONG, or AMERI-
 CAN PHONO. CO., 101 Wall street.
 AUTOMATIC ZITHER CO., M. Cohen, Prop.,
 58 Second avenue.
 BERN BEARWALD, 373 W. 11th st.
 BRONX PHONO. CO. or DAVID SWITKY,
 506 Willis ave
 CENTRAL PHONO. CO., 160 E. 42d street.
 R. L. CORWIN; also Newark, N. J.
 EAGLE PHONO. CO., or C. LOWENTHAL,
 83 Nassau street.
 EMPIRE PHONO. CO., 2 W. 14th street.
 S. W. FRUCHT, or R. FRUCHT, 7 Barclay st.,
 or 68 Cortlandt st.; also Plainfield, N. J.
 O. HACKER, 2 Murray street.
 HAWTHORNE & SHEBLE, 297 Broadway;
 also Philadelphia, Pa.
 HOLOBER BROS., 150, 421 and 491 West st.
 N. HORN, 148 E. 58th street.
 W. L. ISAACS, 114 Fulton street.
 S. LEMBURG & CO., 194 Broadway.
 J. McELLYNNE, 202 Broadway.
 RICHMOND PEASE, 44 W 132d st.
 F. M. PRESCOTT, 44 Broad st.
 WINTHROP CYCLE CO., 2212 Seventh ave.

Rome—CHARLES TUTTLE.

Saratoga—W. J. TOTTEN.

Saratoga Springs—MARVIN A. COTE.

*Watertown—HENRY A. HARDY, 24 Arsenal st.
 *H. S. WARDWELL & CO., 39 Public Square.

OHIO.

Cincinnati—J. L. ANDEM.

Coshocton—BURNS & GOSSER.

Springfield—D & M. VANDERPOOL.

Uhrichsville—F. A. MAZURIE.

PENNSYLVANIA.

Philadelphia—A. R. CASSIDY, 2783 Emerald street.

HAWTHORNE & SHEBLE, 604 Chesnut st., or
 Oxford and Market sts.; also New York City.

A. KROUSE, 832 Arch street.

PENN NOVELTY CO., 15 South 9th st.

Phoenixville—KEINARD BROS.

Pittsburg—A. LIPPARD, 615 Wylie ave.

RHODE ISLAND.

Providence—F. P. MOORE.

WISCONSIN.

Milwaukee—J. C. BLATZEK.

*Added Since September 1, 1905.

Jobbers and Dealers are asked not to supply any of the above named firms with our apparatus, either at addresses given or any other address.

DOUBLE SERVICE



LANGUAGE STUDY AND AMUSEMENT

"DOUBLE SERVICE" means "Double Profits." You are neglecting a money-making feature of your business if you are not equipped for demonstrating the I. C. S. Language Courses. Begin now! Get our combination French-German-Spanish-English Record, including Display Poster and Advertising Literature, 50 cents delivered. Address:

LANGUAGE DEPARTMENT
INTERNATIONAL CORRESPONDENCE SCHOOLS
SCRANTON, PA.

FOR FOREIGN SALES, ADDRESS { Foreign Dept., National Phonograph Co., 31 Union Square, New York City.
 { European Headquarters, National Phonograph Co., Ltd., 25 Clerkenwell Road, London, E. C.

EDISON Phonograph Monthly

PUBLISHED FOR TRADE USE ONLY BY
THE NATIONAL PHONOGRAPH CO.

VOL. III. ORANGE, N. J., NOVEMBER, 1905. No. 9.

NATIONAL PHONOGRAPH CO.
ORANGE, N. J.

NEW YORK: 31 UNION SQUARE.

CHICAGO: 304 WABASH AVENUE.

SAN FRANCISCO: 786 MISSION STREET.

NATIONAL PHONOGRAPH CO., LTD., 25 CLERKENWELL
ROAD, LONDON, ENG.

EDISON PHONOGRAPHS AND RECORDS.

All communications to THE PHONOGRAPH MONTHLY
should be addressed to the Advertising Department,
Orange, N. J.

C O N T E N T S

A Phenomenal Situation	1
Advance List of December Records.....	2
Jobbers Should Anticipate Record Demand	3
Australian and Mexican Distributing Depots	3
Improvements in the Gem, Standard and Home	4
Why Some Dealers Don't Succeed.... ..	5
Who Are Instalment Dealers?.....	5
Printed Matter	6
Among the Jobbers	6
Lyon & Healy's Announcement	7
Personal	7
No Freight Allowance to Dealers.....	7
King William's Birthday Remembered....	7
Comments on Edison Gold Moulded Rec- ords for December	8
Tray System of Carrying Edison Records	10
"Follow Up" Letters	12
An Excellent Window Display.....	12
An Aggressive Company	13
Publishers of December Music.....	13
350 Tons of Phonographs and Records... ..	13
Jobbers of Edison Phonographs and Records	14
Suspended List November, 1905	15

A PHENOMENAL SITUATION.

The problem that confronts the National Phonograph Co. at the present time is not how to secure orders for Phonographs and Records but how to fill those orders already on file. No more eloquent statement concerning the demand for our goods could be made than the fact that within the past month we have been compelled to decline orders from nearly a dozen firms who wanted to become Jobbers in our goods and who stood ready to make a cash payment for the initial quantity required by our jobbing agreement. It follows that we greatly regretted that circumstances compelled us to do this. It was, however, simply impossible to take on any further Jobbers at the present time and give them a service that would enable such firms to make a proper start with our goods. We could have taken their orders, and, by making our regular patrons wait longer for Phonographs and Records, and making part shipments to the new firms, have permitted them to make a beginning, but such a course would have been unsatisfactory to the new firms and unfair to those already in the business. The best that we could promise the newcomers was that we would be able to take care of them after the first of the year, which we sincerely trust we can do. The jobbing orders that were accepted in the past month, and they were of a notable character, were the result of plans made earlier in the season, or it is probable that they, too, would have been compelled to wait until a later date before we could have welcomed them into the Edison family.

No such demand has ever existed for Edison Phonographs and Records as now prevails. At this time a year ago we thought we had reached the top notch in volume of orders, but the unfilled orders at the present date are double those at the same date a year ago, and the new orders each week exceed the product of our factory. To tell the trade the number

(Continued on Page 3.)

THE ADVANCE LIST OF DECEMBER RECORDS APPEARS ON PAGE 2.

NEW EDISON GOLD MOULDED RECORDS. ADVANCE LIST FOR DECEMBER, 1905.

RECORDS listed below will be ready for shipment as near December 1st as possible, at which time Jobbers' stock orders, if received prior to November 10th, will be shipped. December Supplements will be forwarded to Jobbers with their stock orders for Records. Retail Dealers should place stock orders with their Jobbers at once, to insure prompt shipment as soon as Jobbers' stock is received.

- | | | | |
|------|---|--|---------------------------|
| 9146 | At the Old Grist Mill (Müller) | <i>Descriptive fantasy</i> | Edison Concert Band |
| 9147 | Lorna (Newton) | <i>Sentimental song, Orch. accom., and Quartette chorus by the Edison Male Quartette</i> | Edward Barrow |
| 9148 | The Golden Wedding (Vaudeville) | <i>Character sketch with Orchestra incidental music and introducing the old-time ballad "The Golden Wedding" (Goderey)</i> | Ada Jones and Len Spencer |
| 9149 | Träumerei (Schumann) | <i>'Cello solo, Piano accom.</i> | Hans Kronold |
| 9150 | Bye-Bye, My Eva, Bye-Bye (Smith and Brown) | <i>Coon song, Orch. accom.</i> | Arthur Collins |
| 9151 | Lily White (Bratton) | <i>Popular sentimental song from "The Pearl and the Pumpkin," Orch. accom.</i> | Harry MacDonough |
| 9152 | I'm Old but I'm Awfully Tough (Laughing song) | <i>Comic Rube selection, Orch. accom.</i> | Andrew Keefe |
| 9153 | Happy Heinie March (Lampe) | <i>Characteristic</i> | Edison Military Band |
| 9154 | Girl from the U. S. A. (Hollander) | <i>March song, Orch. accom.</i> | Irving Gillette |
| 9155 | Nothin' from Nothin' Leaves You (Snyder) | <i>Coon song, Orch. accom.</i> | Bob Roberts |
| 9156 | Star, Beautiful Star (Schilling) | <i>Christmas-male duet, Orch. accom.</i> | Anthony and Harrison |
| 9157 | Romantic Overture (Kéler Béla) | | Edison Symphony Orchestra |
| 9158 | Can't You See I'm Lonely (Armstrong) | <i>Coon love ballad, Orch. accom.</i> | Miss Ada Jones |
| 9159 | Call Again, Calligen | <i>Comic Irish song, Orch. accom.</i> | Edward M. Favor |
| 9160 | Nigger Loves His Possum (Paul Dresser) | <i>Coon male duet, Orch. accom.</i> | Collins and Harlan |
| 9161 | With Flying Colors March (Cruger) | | Edison Concert Band |
| 9162 | Silver Threads Among the Gold (Danks) | <i>Soprano song, Orch. accom.</i> | Miss Marie Narelle |
| 9163 | Short Stories by Frank Bush (Original) | <i>Comic talking selection</i> | Frank Bush |
| 9164 | Sympathy (Kendis and Paley) | <i>Comic song, ("Don't Worry, Bill"), Orch. accom.</i> | Billy Murray |
| 9165 | Killarney, from "The Rogers Bros. in Ireland" (Hoffman) | <i>Xylophone solo, Orch. accom.</i> | Albert Benzler |
| 9166 | Starlight (Morse) | <i>March song by the composer of "Blue Bell," Orch. accom.</i> | Byron G. Harlan |
| 9167 | As We Parted at the Gate (Keith) | <i>Descriptive male duet, Orch. accom.</i> | Harlan and Stanley |
| 9168 | Silent Night (Quartette) | <i>Christmas carol, unaccompanied</i> | Edison Male Quartette |
| 9169 | Good Night Waltz (For Dancing) | <i>Introducing "My Dream" Waltz, "Auld Lang Syne," "Good Night Ladies," "Merrily We Roll Along" and "Home, Sweet Home"</i> | Edison Military Band |

Edison Gold Moulded Records are made only in Standard Size. Both Standard and Concert Records may be ordered from this list. Order by number, not title. If Concert Records are wanted, give the number and letter C.

(Continued from Page 1.)

of unfilled orders for Phonographs and Records that we now have on hand, even stated without any thought of exaggeration, would cause the trade to feel that we had entered into competition with firms to whom figures mean little when stating the business that they have done or are doing. We are amazed ourselves at the magnitude of the business, and we know that the trade would be equally amazed could it realize the true situation.

Fortunately, we have a factory capacity largely in excess of that of a year ago, and as it is now being crowded to its limit, we hope to make steady progress toward shipping the Jobbers sufficient goods to take care of their Dealers, even though we may not be able to make complete shipments. Jobbers may rely upon it that in apportioning our daily output of machines and Records, we will make shipments with equal fairness to all. No one will be given any advantage over his competitor in this respect. Nothing will be left undone to keep the trade supplied and to complete orders as near as possible to the specified time.

JOBBER SHOULD ANTICIPATE RECORD DEMAND.

The demand for Edison Records is growing so rapidly that the time is at hand when Jobbers will be compelled to change their methods of carrying stocks and ordering Records. Most of the time in the past it has been feasible for a Jobber to wait till his stock of Records ran low, place a new stock order and get the Records in from one to two weeks, thus avoiding the necessity of anticipating weeks in advance or carrying large stocks. With the Record-business almost doubling from year to year it is no longer possible to give the service of two years ago, even with facilities for making 100,000 Records a day. A greater time must elapse between the time of placing orders and getting the goods. Jobbers must order farther in advance or wait longer to get their orders filled. To wait means loss of business to the Jobber who does not have the Records to fill the orders of his Dealers. Placing orders farther in advance is, therefore, the only practical solution. This, after all, only means a little more study of the Record situation. It only means that a Jobber must learn how to anticipate the sale of every Record and place orders to be shipped on or after a certain date. By the use of a card file or any similar system a complete record can be kept of the sales of each title. Such a record will show the total sales of each number in a given

period and will form an excellent basis from which to make up anticipatory orders. A system of recording the number of Records received from the factory and sold can be kept that will tell by a glance just how many of each number are in stock without looking at the shelves or store rooms. The plan of ordering Phonographs in advance is successfully followed by all Jobbers and there is no reason why the same principle cannot be followed in ordering Records. To do so would greatly facilitate the task of filling orders at the factory. The advantage to the Jobber of always keeping a complete and adequate stock of Records is too apparent to call for comment.

AUSTRALIAN AND MEXICAN DISTRIBUTING DEPOTS.

Owing to our constantly increasing trade in the Australasian Colonies and the Republic of Mexico (both showing in the past year an increase of business representing nearly 100 per cent. over the preceding year), it has been found necessary to open distributing depots at Sydney, N. S. W., and Mexico City, Mexico.

William W. Wyper, our Australian representative, sailed from San Francisco October 12th, en route for Sydney, N. S. W., and as soon as practicable after his arrival, will secure the necessary office quarters, also a store-room for the accommodation of a large stock of Edison Laboratory products, the shipment of which is now in transit. It may be of interest to our friends in the trade to know that the people of Australia are to-day using more Edison Phonographs per capita than those of the United States. We are sure that our efforts to carry a large stock of Edison apparatus in Sydney will be thoroughly appreciated by our clients when it is shown that it requires from two and a half to three months to receive a shipment from New York by direct steamer, or via Liverpool.

Practically the same conditions prevail in Mexico as in Australia. The increase of our business in Mexico has been phenomenal, and to meet the requirements of the trade, we have arranged to carry there a large stock of all goods we manufacture. Our Mexican representative, Raphael Cabañas, left New York October 12th, and after visiting the trade in several of the principal Mexican cities, expects to reach Mexico City about November 15th.

Both Mr. Wyper and Mr. Cabañas are particularly adapted to the work which they have undertaken, in that they have spent the greater part of their lives in the field in which they will operate. With direct representation, and with a large stock of goods at hand, there is no doubt that a still further increase in business in the above territories will result from our efforts.

IMPROVEMENTS IN THE GEM, STANDARD AND HOME.

All orders for Edison Gem, Standard and Home Phonographs for the past month have been filled with machines embodying a number of important improvements which will make them more desirable than ever as ideal instruments for home entertainment. Because a number of each machine without the improvements are still on the market, it has been thought advisable not to show the changes in the Phonograph catalogue for at least another month. This will give Dealers a further opportunity to dispose of their stock on hand.

CHANGES IN THE HOME.

The principal feature of the Home machine is that the top plate is done away with and the body is screwed on to the cabinet, which we believe will eliminate the feature of the body shifting during transportation and getting out of alignment with the motor frame. The swing arm lock bolt has been changed,



THE IMPROVED HOME.

not for the purpose of improving the working of the lock bolt itself, but so as to be able to shorten the machine about two inches, which improves the appearance of the machine and the cabinet, and also decreases the dimensions of the packing box.

A more important feature is the change that has been made in the speed adjusting screw, which has been taken off from the top of the machine entirely and placed underneath the top plate. All machines before they leave the factory will be adjusted for 160 revolutions per minute, but if for any reason any one should desire to change the speed it can be done by lifting up the table of the cabinet and turning the adjusting screw. The reason for this change is that with the adjusting screw in such easy reach it has been the cause of the speed being unintentionally changed and consequently the results from the Records have not been the best.

A guard has been placed over the feed nut spring to protect the spring from being bent out of adjustment. A set screw passes through this guard for adjusting the spring, in place

of making the adjustment by bending the spring.

The machine is equipped with a new winding crank, nickel plated and polished, and the crank is attached to the winding shaft by means of a thread. The reason for this change is that it was very difficult to drill the hole in the old crank perfectly true with the outside and occasionally a crank would touch in the thimble hole of the cabinet and spoil the effect of the cushion springs by transmitting the noise from the motor frame to the cabinet and the top plate of the machine. Besides, there are other advantages to this style of fastening, the principal one being that the crank cannot slip off of the key when machine is being wound.

The shaving knife has been left off this machine for the reason that the Moulded Record, the only commercial Record, cannot be shaved and the motor has not sufficient power to drive the mandrel at a speed which would give satisfactory results.

The cabinet is finished in antique oak in place of the green. In fact, all types of cabinets will have this finish. This change has been made in compliance with requests received from many of our dealers and customers, the green finish not harmonizing with house furniture.

CHANGES IN THE STANDARD.

The principal change in the Standard machine is in the introduction of cushion springs between the top plate and the motor frame to eliminate the noise from the motor gearing.



THE IMPROVED STANDARD.

The speed-adjusting screw and winding crank is applied the same as on the Home machine. The cabinet is of same finish as the Home, but the lower part is one-half inch higher than the old cabinet to provide for the additional height, taken up by the motor, due to the introduction of the cushion springs.

CHANGES IN THE GEM.

The most noticeable feature on the new Gem machine is the winding crank, which replaces the winding key; that the winding is done right hand, the same as the other types

of machines, and that the winding crank is stationary while machine is running. To accomplish this it was necessary to introduce a special shaft and two gears. It takes less power to wind the machine.

The starting button has been placed on the right hand side of the machine, and in place



THE IMPROVED GEM.

of pushing and pulling the button to start and stop the machine the new button is in the shape of a cam, which has to be turned to the right to start the machine and to the left to stop it. The starting and stopping device is so arranged that the speed cannot be changed during the ordinary operation of starting and stopping the machine, as was the case with the old Gem, and if it is desired to make any alteration in the speed of the machine it can readily be done without removing the wooden base.

Another important feature is the substitution of a regular Model "C" reproducer instead of the old Model "B" reproducer. The finish of the cabinet is the same as other machines.

OPENING AT LAWRENCE, MASS.

Gordon Bros., of Worcester, Mass., opened a coin-slot Phonograph parlor in Lawrence on September 30th and a local paper referred to the occasion as follows:

The one cent exhibit, 503 Essex street, opened up last Saturday night with a wonderful success. The management was obliged at one time to ask the eager, amusement-loving people to wait outside as they could not be accommodated. The Gordon Bros., with headquarters at Worcester, are the proprietors of the exhibit, who run places like it in the principal cities of the country. Thomas A. Edison is the principal figure in the unique exhibit. One full side of this exhibit is represented by his twentieth century type Phonograph, when by merely depositing one cent you can hear the best singers and musicians of the world, with most wonderful distinctiveness. Views and comic sets are also on exhibit. The place is very neat and tastefully arranged, beautifully illuminated by electric lights.

"It is just what we want in this growing city of ours; a place where we can nourish our souls with good music, such as the Edison Phonograph furnishes, a place where ladies and children, the young and the old can be amused with one cent," remarked an old resident of the city while shaking hands with the manager, Mr. Essinger.

WHY SOME DEALERS DON'T SUCCEED.

A Western Dealer who has made a considerable success selling Edison Phonographs and Records visited our factory at Orange recently and during the course of a conversation on the general situation, with reference to the business being done by Dealers in Edison Phonographs and Records, made the following significant remark. He said, "The trouble with many Dealers is that they do not study the Phonograph proposition. If they did, they would be more successful in business." This is undoubtedly the real reason why many Dealers do not become successful. They expect to buy Phonographs and Records as they would cereals in packages and sell them with no more knowledge. They do not keep themselves informed about the general situation; they do not take the trouble to learn even the simplest things about the machines from a mechanical standpoint; they do not keep a proper stock of goods; they do not display them in an attractive manner; they do not let the public know they sell them, and they do none of the things which an up-to-date and aggressive man would do. Consequently, they seldom carry more than the initial quantity of goods, and they are always wondering why they do not have a better sale for them. The stock they do carry is not infrequently stuck away in a corner out of sight and more or less covered with dust. Prospective customers soon find they do not have what is wanted and they seldom return for the purpose of making a purchase. Contrast such dealers with those who read trade papers and everything else pertaining to the line; who make a study of the machine; who know which Records are most likely to be wanted by the public; who carry the entire stock of Edison Records; who make an attractive window display; who play the Phonograph occasionally for the entertainment of the public; who advertise, and who, in other ways, handle the business in an intelligent manner and you will see why they make money and why the unprogressive Dealer does not.

WHO ARE INSTALMENT DEALERS?

In following up the inquiries received from our magazine advertisements we frequently get letters from inquirers who want us to refer them to Dealers who sell Phonographs on instalments. At present we are unable to comply with these requests, for we have no means of knowing which of our Jobbers or Dealers do a business of this character. We will be glad, therefore, if Jobbers or Dealers selling on instalments will advise us of the fact. We will enter this information on our file cards for future reference in all cases where it is sent to us.

PRINTED MATTER.

Record order sheet D is being printed and will be ready for the use of the trade in time to use it for orders for December Records.

A Christmas folder is in preparation. Single copies will be mailed to Jobbers within ten days, with a request that they place orders for such quantities as they can use during the holiday season. Jobbers should get enough for their own retail trade and to supply their Dealers. The edition being printed will permit the trade to use them liberally. It is expected to ship these folders with the December Records.

Complaint has been that the Phonograph catalogue does not agree with the improved Gem, Standard and Home Phonographs now being shipped on all orders, in that the catalogue shows that the Standard and Home machines are equipped with shaving devices, whereas shaving devices have been removed from the new machines. This condition was known when we began to ship the improved types, but since the catalogue could not show both the old and new it was deemed best to continue the present catalogue until Dealers generally had had time to dispose of their stocks on hand. In spite of the removal of the shaving devices the new machines are superior to the old, and Dealers should have no trouble in explaining the situation to customers who want machines equipped with shaving devices. A corrected edition of the machine catalogue will be issued shortly.

Folder No. 690 ("Slave of the Ring") and photo card No. 746, showing a picture of Mr. Edison on one side, are being reprinted and trade orders can be filled about November 15.

The new *Phonogram* has reached an edition of 275,000 copies each month and still continues a popular and profitable means of selling Records.

AN INTERESTING BOOKLET.

"Thomas A. Edison and Phonograph Record Talent" is the title of a handsome little booklet just issued by the Souvenir Publishing Company, Easton, Pa. It contains a well written biographical sketch of Mr. Edison, the story of the first Phonograph and a good description of the machine in its present state of development. Among the excellent half-tone pictures which embellish the booklet are those of Mr. Edison, his birthplace, laboratory and library, and photographs of a large number of artists who have made Edison Records. The booklet is designed to be sold by Phonograph Dealers at twenty-five cents.

AMONG THE JOBBERS.

October was a notable month in the history of the National Phonograph Co., not only because of the truly remarkable volume of orders placed by our regular Jobbers, but also from the fact that four of the leading firms in their line in the United States became Jobbers in our goods. Perhaps the most prominent of these were Lyon & Healy, of Chicago, one of the leading music houses in the country. Marquette Healy, of this firm, paid a visit to our New York office and placed an initial order for 500 machines and 20,000 Records. It is the intention of this house to strongly push the Edison line without in any way affecting the lines which they now represent.

As a result of the trip made to the Pacific Coast by C. H. Wilson, General Manager of Sales, jobbing orders were placed by D. S. Johnston Co., 903 Second avenue, Seattle, Washington; Graves & Co., 328 Washington street, Portland, Oregon, and the Spokane Phonograph Co., 7 Post street, Spokane, Washington. The initial orders placed by these firms were unusually large, and because of more economical transportation charges, the orders were placed in car loads. The principal factor in the signing of these three firms was the decision of this Company to allow freight charges on all goods sold to Jobbers anywhere in the United States. It is the intention of all three of these new Pacific Coast Jobbers to open up new territory and aggressively push the sale of Edison Phonographs and Records in places where they heretofore have been unknown because of the heavy freight charges to the West.

Babson Bros., 148 Michigan avenue, Chicago, have also become Jobbers in Edison goods, and it is their intention to do a large mail order business, besides jobbing the line in the usual way.

Harry Jackson, Edison Jobber at 219 Bowery, New York City, has opened his seventh branch store at 86 Amsterdam avenue, New York City.

The Peoria Phonograph Co., of Peoria, Ill., have removed from 222 Bridge street, to 416 South Adams street.

The Minnesota Phonograph Co., Edison Jobbers at St. Paul, Minn., have opened a jobbing branch at 518 Nicollet avenue, Minneapolis, Minn.

F. M. Atwood, of Memphis, Tenn., has removed from the Lyceum Building to 160 North Main street.

S. K. Hamburger, of Harrisburg, Pa., has opened a jobbing branch store at 723 Chestnut street, Reading, Pa.

LYON & HEALY'S ANNOUNCEMENT.

The letter printed below was sent out by Lyon & Healy, of Chicago, as an announcement to the talking machine trade that they had become Jobbers in Edison Phonographs and Records.

We have added a complete line of brand new EDISON PHONOGRAPHS AND RECORDS to our talking machine department and are now prepared to give prompt attention to all orders for anything in this line.

This letter, with the enclosures, is intended more particularly for our friends who are familiar with Edison goods and to invite those who are already established as Edison Dealers to sign the Edison contract in triplicate and return, with information as to being already established as an Edison Dealer. We would ask regularly established Edison people to sign and return the contracts, even if at this time they are unable to favor us with an order. It will save delay in filling orders should we receive such favors in the future.

The Edison line has proved such a money-maker and has been confined so closely to a class of Dealers who are very much in earnest about the talking machine proposition, that this class of talking machine goods is having a phenomenal business. A daily output of one thousand machines and 100,000 Records, all sold at the full list price, is certainly making money for somebody. Are you in on this harvest? If not, don't you want to be?

There is no buncombe about the figures given above. Our Mr. Marquette A. Healy has just spent a week at the factory and you are presented with facts to figure on.

We will announce our special prices on a fine line of up-to-date supplies to the regularly established trade who return the signed contracts. Those who are not familiar with the Edison line are asked to fill out the enclosed card calling for complete information, catalogues, etc., concerning our new goods.

Write to us for our new and original plan of sending a monthly Record list to your Record buyers in envelopes with your name on, thereby saving you the trouble of mailing them out yourself.

Thanking you in advance, we are,

PERSONAL.

William E. Gilmore, President of the National Phonograph Co., paid a flying visit to the Chicago office on October 18th, returning on the 22d.

W. A. Myers, Edison Jobber at Williamsport, Pa., visited our New York office on October 23d and also took occasion to run out to the factory at Orange.

Richard F. Outcault, creator of "Buster Brown," lectured in Orange on October 21st, and while there called upon Mr. Edison, for whom he worked as a draughtsman for several years.

AN ATTRACTIVE STORE.

One of the most attractive Phonograph stores in the South, reports our Southern travelers, is located at Macon, Ga., and known as the Macon Phonograph Co. R. T. Dews is the manager. They carry the entire line of Edison Records and Phonographs, and Mr. Dews reports conditions very flattering owing to the fact that the Phonograph business has just commenced to be popular in the South.

NO FREIGHT ALLOWANCE TO DEALERS.

A misapprehension has arisen among some Dealers in the far West concerning the meaning of the announcement made in the August PHONOGRAPH MONTHLY about freight allowances to Jobbers beyond the Mississippi. In commenting on this announcement we said in August:

"It means that every Jobber and Dealer in Edison goods, no matter where located in the United States, will pay the same price for Phonographs and Records and will be able to realize the same profit on them."

This statement meant that no Jobber would hereafter have any occasion for charging Dealers more than the standard prices for our goods due to the extra freight charges he formerly paid. It did not mean that we had changed our policy of not allowing freight charges on goods shipped to Dealers whether ordered by a Jobber or by the Dealer himself. Under our new rule we will allow full transportation charges to Jobbers, no matter where located, but we will not do so to Dealers, whether shipments are made from the factory or from their Jobber. In emergency cases or as a matter of accommodation, where we make shipments direct to Dealers on an order sent us by Jobber or on an order sent direct by Dealer to be charged to Jobber, they will have to pay the amount which the transportation charges would represent had the shipment been made from the city in which Jobber was located. To be more explicit, where we make shipments direct from the factory to Dealers, such shipments to be charged to Jobber, the Dealers will have to pay the transportation charges when the goods are received. They should then turn the freight vouchers covering such charges over to the Jobber, who will credit them in full and then charge the Dealers with the amount which the freight would represent had the shipment been made from the city in which the Jobber is located.

KING WILLIAM'S BIRTHDAY REMEMBERED.

Mr. Edison in June presented the German Emperor with a specially finished Phonograph in commemoration of His Majesty's birthday. The gift was in September acknowledged as follows:

Washington, D. C., September 25, 1905.

Dear Sir:—I have the honor to inform you that His Majesty the German Emperor has been pleased to accept the specimen of your latest type of Phonograph kindly offered in your letter of June 20th. His Majesty has commanded me to thank you for your courtesy which he appreciates very much.

Very sincerely yours,

BARON v. d. BUSSCHE,
German Charge d'Affaires.

COMMENTS ON EDISON GOLD MOULDED RECORDS FOR DECEMBER, 1905.

Abounding in all the features characteristic of the holiday season is the December list of Edison Gold Moulded Records. It includes music for those who dance, songs for the light-hearted, ballads for the sentimentally inclined, old time songs for the reminiscent, appropriate hymns for the Christmas season, and band and orchestra selections for all. Notable features of the month are the re-listing of "I'm Old But I'm Awfully Tough," "Silver Threads Among the Gold," and "As We Parted at the Gate." These songs have been out of our catalogue for some time, but their never diminishing popularity has made it desirable to put them back. "I'm Old but I'm Awfully Tough" is sung by Andrew Keefe, and we believe that he will at once achieve a great success.

No. 9146, "At the Old Grist Mill," by the Edison Concert Band, is a descriptive fantasy beginning with the "break of day." The bull-frog and the bobwhite are heard, with the crow of the rooster and the barking of dogs in the distance. The hour of four strikes in the old town clock, after which begins an allegro number descriptive of the starting of the old mill, accompanied by the singing of birds. The mill at work follows, as does also the noon hour rest, with characteristic music. Returning of the mill hands—finishing the day's labor and stopping of the old mill, followed by the croaking of the frogs in the evening, brings the Record to a fitting close. This composition was written by Otto J. Müller.

No. 9147, "Lorna," by Edward Barrow, is a delightful Record of a most beautiful song, which Mr. Barrow renders with an abandon never before approached in the Phonograph. The beauty of the Record is further enhanced by the work of the Edison Male Quartette, which softly accompanies Mr. Barrow in the chorus. The Record is made with orchestra accompaniment. The song is written by Ernest Newton (music) and F. E. Weatherly (words).

No. 9148, "The Golden Wedding," by Ada Jones and Len Spencer, is an original vaudeville sketch, with orchestra accompaniment, written especially for our Record. An aged couple on the fiftieth anniversary of their marriage are talking reminiscently of their wedding day and lovingly exchanging felicitations on the happy years that have marked the span of their married life. Interspersed with the dialogue is incidental music by the orchestra, including "The Golden Wedding" and "Silver Threads Among the Gold." This Record is unlike any that Miss Jones and Mr. Spencer have yet made, but we believe that it will find a large sale among those who appreciate well rendered Records of sentimental subjects.

No. 9149, "Träumerei," is a violoncello Record by Hans Kronold. No more artistic Records have ever been made for the Phonograph than these solos by Mr. Kronold, an acknowledged master of this most delightful instrument. Mr. Kronold's rendition of Schumann's

charming composition is that of the true musician. In making the selection he was accompanied by the piano, an orchestra accompaniment not being suited to a violoncello solo.

No. 9150, "Bye-Bye, My Eva, Bye-Bye," by Arthur Collins, is Carroll Johnson's great song hit in Lew Dockstader's Minstrels. It is a coon song that will hold its own among the best. The story is humorous and the melody is singable and catchy. Mr. Collins gives it in his inimitable style. In it Mr. Collins introduces the following bit of monologue in dialect: "Eva, did you ever note the fact of how happy we might have been if we hadn't been so dog-gone miserable?" The orchestra also effectively introduces a bit of "Auld Lang Syne."

No. 9151, "Lily White," by Harry MacDonough, is one of the most popular numbers in the performance of "The Pearl and the Pumpkin," which has had such a successful run at the Broadway Theatre, New York City. It is a sentimental composition and one that cannot fail to please, both in its music and in the manner in which Mr. MacDonough sings it. The music is by John W. Bratton and the words by Paul West. It is sung with orchestra accompaniment.

No. 9152, "I'm Old But I'm Awfully Tough," by Andrew Keefe, introduces a new Phonograph singer. Since circumstances made it impossible to supply the trade with this Record and later made it necessary to eliminate it from our catalogue, we have probably had more requests for this selection than any other one in the catalogue. In making it over, we shall, beyond question, be pleasing thousands of present and prospective owners of Phonographs, and we anticipate that until the trade is again supplied, there will be a great demand for this Record. In Mr. Keefe we have found an artist who has done this song full justice and we believe that his Record of it will equal in popularity any one previously made. Unlike our former Record, this one is made with orchestra accompaniment.

No. 9153, "Happy Heinie March," by the Edison Military Band, is a new composition by J. Bodewalt Lampe, introducing bits and suggestions of well-known German melodies, interwoven and entangled very cleverly, forming a snappy, characteristic march, descriptive of its title.

No. 9154, "The Girl from the U. S. A.," by Irving Gillette, is quite a departure from the usual run of popular songs. The music is catchy and quite characteristic of the story. The music was written by Joe Hollander and the words by Wm. Clifford. The words of the chorus follow:

"The English girls are nice, I know,
We love the German beauty,
The French girl has a winsome face,
To praise her is your duty;
The Spanish girl has dreamy eyes,
But still I'm bound to say,
The girl I prize the most of all
Is the girl from the U. S. A."

No. 9155, "Nothin' from Nothin' Leaves You," by Bob Roberts, is a coon song by Ed. Rose and Ted. Snyder, and sung in Mr. Roberts' best style, with orchestra accompaniment. Harold Lee is told by his beloved to listen to her, whereupon she proceeds to make the most scathing and sarcastic comparisons between

him and nothing, in which nothing comes out first best. The chorus follows:

"You talk like nothin', and you walk like nothin'

Nothin' seems to be your aim;
You look like nothin', and you act like nothin',
Nothin' and you are the same.
You can't learn nothin' 'cause you don't know nothin',

I've forgot more than you ever knew;
The only way I can figure you out
Is nothin' from nothin' leaves you."

No. 9156, "Star, Beautiful Star," by Anthony and Harrison, is a hymn by Fred Schilling and Rossiter W. Raymond which was written especially for Christmas services. It is included in the December list because of its appropriate Christmas character. It is sung in a manner appropriate to the character of the music, and the singers are accompanied by the orchestra.

No. 9157, "Romantic Overture," by the Edison Symphony Orchestra, is a swell orchestra overture by Kéler Béla, similar in character and opportunities for featuring various instruments in the orchestra to "Summer Night's Dream" overture (our Record No. 9029), which was so much admired.

No. 9158, "Can't You See I'm Lonely," by Ada Jones, is one of the prettiest songs that Miss Jones has ever sung for a Record. The dainty coon dialect introduced is fascinating. Miss Jones' Records are widely popular, and all who admire her singing must have this one in their collections. The music of this song was written by Harry Armstrong and the words by Felix F. Feist.

No. 9159, "Call Again, Calligen," by Edward M. Favor, is an unpublished song, written especially for our Record. It is sung with orchestra accompaniment. Calligen, an Irish tailor, has a customer who is in arrears on payment for clothes that have been furnished on the instalment plan. When he calls to collect he is told to call again. The similarity in sound of Calligen" and "Call Again" furnish, together with a number of ludicrous situations, the humor in the selection.

No. 9160, "Nigger Loves His 'Possum," by Collins and Harlan is a coon song with orchestra accompaniment, introducing a Mississippi steamboat scene with all the incidental effects. Sung in the characteristic style of these popular artists. Paul Dresser wrote the words and music of this song.

No. 9161, "With Flying Colors March," by the Edison Concert Band, is a stirring and military march by Dox Cruger, the composer of "Down Tennessee" (our Record No. 8844), and "In Old Alabama" (our Record No. 8392). A splendid march Record.

No. 9162, "Silver Threads Among the Gold," by Marie Narelle, is an ever popular song, which to render well requires a very sweet and sympathetic voice, such as is possessed by Miss Narelle. There have been constant requests for this ballad and doubtless our friends have often wondered why it has not been listed before, but to have it by Miss Narelle is well worth waiting for. Miss Narelle is accompanied by the orchestra. The composers of this song are H. P. Danks (music) and Eben E. Rexford (words).

No. 9163, "Short Stories by Frank Bush," is a talking Record made by Mr. Bush him-

self, who is one of the best known vaudeville artists on the American stage. The stories are extremely funny, and the manner in which Mr. Bush tells them adds to their humor. The stories given on this Record were written for this especial purpose and have not been published in any form.

No. 9164, "Sympathy," by Billy Murray, is a comic song out of the ordinary, both in music and story. "Don't Worry Bill," which is the sub-title, is likely to become a catch word. Mr. Murray with his clear articulating voice brings out the comic situations in the piece very funnily. He is accompanied by the orchestra. The music and words of this song were written by Kendis and Paley.

No. 9165, "Killarney, from Rogers Bros. in Ireland," is a xylophone solo by Albert Benzler, with orchestra accompaniment. This instrumental number was composed especially for the Rogers Brothers by Max Hoffmann and is played as an overture at their nightly performances. Bits and suggestions of Killarney will be noticed throughout the Record.

No. 9166, "Starlight," by Byron G. Harlan, is a new march song by Theodore Morse and Edward Madden, composers of "Blue Bell" (our Record No. 8855). It has a catchy air that will carry it to wide popularity, and Mr. Harlan's splendid rendition of it will aid in popularizing the song and our Record. The chorus follows:

"Good night, my Starlight,
Heart of my heart,
You'll be my Starbright
Tho' we're far apart;
And when you're lonely,
My heart's delight,
Dream of your true love,
Good-night, Starlight.

No. 9167, "As We Parted at the Gate," by Harlan and Stanley, was previously listed when we were making the old style wax Records. It is now re-listed on account of the many urgent demands for it. Its popularity is not to be wondered at because it is a most attractive sentimental song and one that will ever retain its hold upon the public. It is as attractive to-day as when first written some years ago by E. Austin Keith. Being sung by a duet will make the Record more desirable than when made in solo form. The orchestra accompanies the singers.

No. 9168, "Silent Night," by the Edison Male Quartette, is another selection suitable to the Christmas season. The Christmas words are set to an old German melody, which is sweetly rendered. Somewhat of a departure is the lights and shades introduced so appropriately by the quartette. The effect is much more pleasing than uniform volume of tone heretofore given. The singers are unaccompanied.

No. 9169, "Good-Night Waltz," by the Edison Military Band, is issued as a supplemental number to our dance list and intended to be used as the last number in dance entertainments, ending as it does with "Home, Sweet Home." The Record includes Waldteufel's "My Dream" waltz, "Auld Lang Syne," "Good-Night, Ladies," "Merrily We Roll Along" and "Home, Sweet Home." The Record is made in accurate waltz tempo, but aside from this feature it will be a desirable Record because of the variety of airs included in it.

TRAY SYSTEM OF CARRYING EDISON RECORDS.

Since it is the function of the EDISON PHONOGRAPH MONTHLY to furnish the trade with all information that will aid Dealers in handling Edison goods to advantage, we are this month referring at length to the advantages



Fig. 1. General appearance of Trays.

of the tray system for carrying retail stocks of Edison Records. As its name implies, Records are kept in stock by means of pasteboard trays, or rather open boxes, whose sides are about half as deep as a Record box when standing on end. These trays are made of black covered pasteboard, reinforced with cloth at the corners, and large enough to hold four Records standing on end. Their general appearance is shown in Fig. 1. On the front of the boxes are labels, being printed for trade use by Victor H. Rapke, of 1661 Second avenue, New York. These labels show the number and title of each Edison Record and the name of the

artist or organization that makes it. Fig. 2 furnishes an excellent illustration of the appearance of a large number of Edison Records, when carried by the tray system. The reader will note the ease with which every number may be read and the facility with which a Dealer may determine when a number is missing. The system shown in Fig. 2 requires ordinary shelving ten inches deep and with a space from five and a quarter to six inches between the shelves. Uprights should be built at intervals of from five to six feet or the shelves will sag and mar the appearance of the whole rack.

Victor H. Rapke, Edison Jobber at 1661 Second avenue, New York, who was the first to introduce the tray system for carrying Edison Records, furnishes some figures about his plan for constructing shelving. Instead of building shelves along the wall he has built four racks at right angles with it. Each rack is 14.8 feet long, 6 feet high, has twelve shelves made of half-inch material and built with a clearance of five and a half inches between the shelves.

Uprights of seven-eighth inch stuff are placed 34 inches apart or just wide enough for 12 trays, placed side by side. Each shelf is 11 inches deep from front to rear. The bottom shelf is built 4 inches above the floor. Two sections of 12 shelves each are placed back to back, so that the two occupy a floor space of 14.8x11.0. Each section will hold 720 trays, so that only two sections are needed to carry every Edison Record in the domestic catalogue. The four sides of the two double racks provide room for 2,880 trays, enough to carry every Edison Record made, and as each tray holds four Records the total capacity is 11,520 Records. Every Record is in easy reach of the floor.

Mr. Rapke points out that the numbers should run up and down and not lengthwise across the shelves. The advantage of this is that all the low numbers are found in one division and time is saved in not being com-



Fig. 2. A Section of Phonograph Department of C. E. Osgood Co., Boston, showing Trays on Shelves arranged along the wall.

pelled to walk from one end of the shelves to the other to find numbers wanted.

This system of carrying Edison Records is of greater value to the Dealer who wants to carry the entire Edison list than it is to one who carries only part of the list, although it can be used advantageously by any Dealer. The number of Dealers who carry every domestic Record is rapidly growing, it being more and more recognized that to do so means to be successful, and to such Dealers the tray system is invaluable.

The advantages obtained by using this system are many, but perhaps the most important is the fact that the customer can see at a glance the name and number of any selection in stock, which in many cases means a sale that would be lost if the catalogue alone was depend upon. Thus it acts as a silent salesman. Another benefit of no small importance is the ease with which a Dealer can make up an order for the selections not in stock. The trays for this system can be had from any firm manufacturing paper boxes and they are quite inexpensive. The Talking Machine Supply Manufacturing Co., of 48 Hanover street, Boston, is making a specialty of furnishing a complete outfit for the tray system at a cost of \$40.00. The outfit includes 1350 trays, enough for the entire Edison domestic list now issued and the December list in addition. The trays are labeled and ready to put on the shelves. The outfit also includes a year's subscription for new labels, which are mailed monthly as issued.

With the talking machine business in the thriving condition it is to-day, and still growing, no Edison Dealer can afford to be without a complete stock of Records, and to such the tray system is worthy of the praises bestowed by those who already use it.

THANKS.

ELIZABETH, N. J., October 4, 1905.

I can't help congratulating you on your efforts in improving the Edison Records and machines. A customer can't help asking for more and more Records, especially this month's list. I *think it my duty* to thank you for the improvement as it is done in my benefit as much as the customer's.

EMIL TAUSSIG.

HIRE THE OPERA HOUSE TO PLAY RECORDS.

Thomas Bros., of Madison, Neb., hire the local opera house one evening each month and play the new Edison Records for the benefit of their patrons and the public in general. The invitation they sent out in August read as follows:

GRAND CONCERT
Hein Opera House.

You and your friends are cordially invited to be present at the Opera House, Saturday evening, August the Twelfth, at the hour of seven forty-five to listen to an Edison Phonograph concert from the latest August Records.

Our August Records have just been received and the entire lot are new and catchy, and consist of the latest and popular selections.

Admission to the concert is free. Farmers come with the family.

Call in and make your selections while the list is complete and get first pick of your favorites. Remember that we always carry a complete

line of Edison Phonographs, Records and supplies and you are always welcome at our store to examine the Phonographs and hear them.

Thomas Bros.' Book Store,
In Opera House Block, Madison.

EDISON ALL THE TIME.

Here is something for the PHONOGRAPH MONTHLY which I consider to be the most interesting musical periodical that we receive.

About six months ago we sold a Standard outfit to a well-known gentleman here. He soon got the Record fever and now has a nice selection of Edison Records to which he adds a few each week or so. He became an Edison enthusiast and spread the glad tidings of a perfect talking machine. Since that time his niece and nephew have both bought Standard outfits and to-day his brother eighty-four years of age drove sixteen miles in order to buy a Standard outfit. He left with it as happy a man as you could find.

Edison product first, last and all the time for me! During the last three years the sales in our talking machine department have increased from a few hundred dollars to several thousand dollars per year. And the end is not in sight! Why this increase? Pushing Edison product.

SIMON'S MUSIC HOUSE,
Ottawa, Ill.

AN INVITATION.

Below is given a copy of a series of letters that the O. K. Houck Piano Co., of St. Louis, are sending to their patrons each month:

We take pleasure in mailing you herewith bulletin of Edison Records for the month of October. The list is an exceptionally good one, and you will note that there are two new artists in the list of Record makers for this month.

We particularly recommend the following excellent numbers:

POPULAR—9099, 9104, 9107, 9112, 9116, 9121, 9102, 9101, 9120.

CLASSIC—9098, 9110.

COMIC—9106, 9111, 9114, 9118, 9119, 9103.

SACRED—9109.

You are cordially invited to call at our store and hear the October list of EDISON GOLD MOULDED RECORDS whether you desire to purchase or not.

We have just added a new Record room, size 22x30 feet, to our already handsome department. This gives us a show room floor space larger than any in the city.

We extend to you a standing invitation to call at our store and hear the new Records whenever it is convenient for you to do so, and we trust that you will make it convenient to call often. We will continue mailing you the Phonogram each month.

STORE OF HENRY L. MILLER, EDISON DEALER AT PALESTINE, TEXAS.

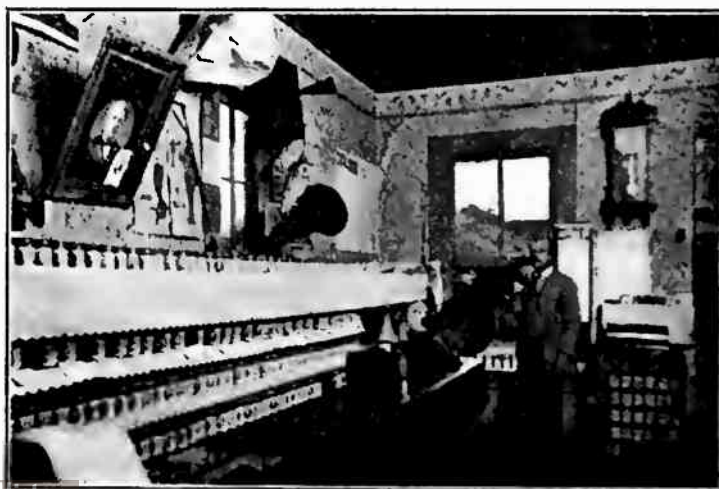

"FOLLOW-UP" LETTERS.

The following "follow-up" letters are printed for the information of Edison Dealers who may desire to get up something of the same kind:

FROM CHARLES REINHARD, NEW HAVEN, PA.

Dear Sir:

The home office of the National Phonograph Co. advises that you have made inquiry about their Gold Moulded Records.

I am their agent in this territory and will be pleased to sell you any Records listed by this firm. I have been handling talking machines for some time, and am safe in telling you that the improved Edison Gold Moulded Records are the best that money can secure.

Under separate cover I am mailing you a catalogue of Edison Records, and a copy of August and September Phonograms.

You can make up a selection of Records from these lists, and if you order one dozen or more at one time I will pay the express charges.

Should you desire to hear the Records before you buy them I would suggest that you come to our Phonograph parlor, which is located on Third street, New Haven, Pa. You will find it open any evening.

You could do this very nicely by coming down on the B. & O. train No. 49 some evening and returning on train No. 10.

However, should you find it inconvenient to make this trip, you will be perfectly safe in ordering by mail. There are no inferior Edison Records. We have hundreds of customers who order all their Records by mail. We do not get to see these people from one year's end to the other, and if we did not take pains in filling their orders we could not get orders from them each month.

We thank you for the inquiry and hope to be able to make some satisfactory arrangement with you and add your name to our already large list of regular customers.

Don't forget that we have the only complete line of Edison goods in this section; we have no shop worn goods, everything that we handle comes to us direct from the factory, always new, fresh and up-to-date.

Thanking you in advance for at least a reply, we beg to remain. Yours truly

SECOND LETTER.

Dear Sir:

Several days ago we wrote you in reference to a letter of inquiry which you addressed to the National Phonograph Co.

Not having heard from you leads us to believe that our letter may have miscarried, and we take the liberty of again advising you that we are the authorized agents for the sale of Edison Records and supplies in this territory.

Under separate cover we are mailing you another Record catalogue, and desire to impress upon you that we carry a full line of the Edison Gold Moulded Records, and should you place an order with us for Records we will fill your order the same day that it is received.

If you order one dozen or more Records at one time we will deliver them to you all charges paid.

We now have several customers in your town who order a few Records from us each month, and we would be gratified to add your name to our list.

Having had several years' experience in the talking machine business we do not hesitate in telling you that the Edison is superior to all others.

Should you desire to hear the Records before you purchase them, we invite you to come to our Phonograph parlor, located on Third street, New Haven, Pa.

We will be pleased to play a number of Records for you whether you intend to buy or not.

Trusting that you will give this your best consideration, we beg to remain

Very truly yours,

FROM J. A. FOSTER CO., PROVIDENCE, R. I.

Your home is not complete without the PHONOGRAPH—what other instrument at even double its cost can provide such a variety of music and amusement as an EDISON PHONOGRAPH? See if you can think of one.

We wish to make you the following proposition on a PHONOGRAPH OUTFIT. If you will call at our store we will quote you the lowest cash price and sell you at \$1 down and 50 cents per week.

If you give us the opportunity, we will demonstrate our ability to give you service and goods that will be sure to please. We trust you will pardon such a long letter, but we want to give you all this information, believing that it would be of value to you at this time.

FROM O. A. REYNOLDS, SPRINGFIELD, ILLINOIS.

Dear Sir:

The National Phonograph Co. have informed me as to your inquiry in regard to Edison Phonographs. They also state that they have sent you catalogues, which you have no doubt received by this time. We would be pleased to have you call at our store and let us show you the different size machines, as we have them all in stock, we being the only firm in Central Illinois carrying a complete line of Edison goods. Our store is devoted exclusively to talking machines and supplies. Should it not be possible for you to call on us, we would be glad to ship you the machine you would most like to hear, with the privilege of exchanging it at any time within thirty days. With this arrangement you would run no risk of being dissatisfied with your purchase. Please notice the enclosed circular as to guarantee of one year on Edison machines.

We would kindly ask you to let us have a reply at your earliest convenience.

We are Yours respectfully,

AN EXCELLENT WINDOW DISPLAY.

The illustration shown herewith was made from a photograph sent by O. S. Thompson, an Edison Dealer at New Albany, Ind. It is a photograph of one of his window attractions. The photograph shows a picture of Mr. Edison in the center, surrounded by pictures of the



Edison talent, cut from the *Phonogram* each month. As each issue of the *Phonogram* appears the pictures are cut out and added to the group, changing its general appearance and furnishing a new attraction each month. The group measures 26 x 34 and is set on an easel in Mr. Thompson's show window. It attracts much attention from the public.

AN AGGRESSIVE COMPANY.

The Eastern Talking Machine Co., Edison Jobbers at 177 Tremont street, Boston, had a formal opening on October 8th of their remodelled building, to which a two-story addition has just been made, affording 6,000 more square feet of floor space. This company ranks among the leading talking machine firms in the country.

When the firm started in Boston at 177 Tremont street, they had 2,000 square feet floor space. At the present time they have 14,000 square feet. Two entire floors have been added, besides the basement, where all the shipping is done.



STORE OF THE EASTERN TALKING MACHINE CO., BOSTON.

On the first floor is an immense show room for the machines, and an Edison Record stock room. This floor is newly painted and decorated and three new demonstrating rooms for the Edison Records have been added.

At the rear is the repair department, completely equipped for repairing all machines, no matter what the make. Skilled workmen are constantly at work on these delicate mechan-

isms. In the basement all the shipping is carried on and freight received. The surplus stock is stored here also.

On the second floor are the offices, including the general and private offices, and the reception room for ladies. This reception room is an entirely new innovation for this sort of a business house. Its purpose is to provide a meeting place for the women patrons, a place where they can wait for a half-hour or so for their friends, and spend the time writing the many social notes necessary to the women of to-day.

The room is furnished in a novel manner, three unique models of the combination machine and Record cabinet being shown. These look like the exquisite parlor curio cabinets and are finished in Vernis Martin marquetry and Rookwood and make a very desirable addition to any room. These are the first combination cabinets that have been shown in this part of the country.

The reception room has a very attractive view, looking out onto Tremont street and the Common. Attractive hard-wood chairs and ferns make a very pleasant ensemble.

On the third floor is the surplus stock and the Record storage. The walls and ceiling of the building are made of fireproof metal.

PUBLISHERS OF DECEMBER MUSIC.

The publishers of the compositions made for our December list of Records, so far as we can give them, are printed below. Where the numbers are omitted they are either not published or we are unable to give the names of the publishers.

- 9146 "At the Old Grist Mill," D. Müller, New York.
- 9147 "Lorna," Chappell & Co., London.
- 9149 "Traumerei," C. H. Ditson, New York.
- 9150 "Bye-Bye, My Eva, Bye-Bye," Helf & Hager, New York.
- 9151 "Lily White," M. Witmark & Sons, New York.
- 9153 "Happy Helnie March," Jerome H. Remick & Co., New York.
- 5194 "The Girl from the U. S. A.," Harry Von Tilzer Music Publishing Co., New York.
- 9155 "Nothin' From Nothin' Leaves You," F. A. Mills, New York.
- 9157 "Romantic Overture," Carl Fischer, New York.
- 9158 "Can't You see I'm Lonely," Leo Feist, New York.
- 9160 "Nigger Loves His 'Possum," Paul Dresser, New York.
- 9161 "With Flying Colors March," Manhattan Music Publishing Co., New York.
- 9162 "Silver Threads Among the Gold," Hamilton S. Gordon, New York.
- 9164 "Sympathy," Jerome H. Remick & Co., New York.
- 9166 "Starlight," F. B. Haviland Publishing Co., New York.
- 9167 "As We Parted at the Gate," E. Austin Keith, Boston, Mass.

350 TONS OF PHONOGRAPHS AND RECORDS.

Our Foreign Department made one shipment to Australia, via S.S. "Victoria," sailing from New York October 10th, via Liverpool, en route for Australia, of 350 tons of Edison Phonographs and Records. The shipment comprised 2000 cases.

JOBBER'S OF EDISON PHONOGRAPHS AND RECORDS.

ALABAMA.

Birmingham—Talking Machine Co., 2007 Second ave.
Mobile—W. H. Reynolds, 167 Dauphin street.
Montgomery—R. L. Penick, 119 Dexter ave.

CALIFORNIA.

San Francisco—Peter Bacigalupi, 786-788 Mission street.

COLORADO.

Denver—Denver Dry Goods Co., 619 16th street.
 Hext Music Co., 15th and California streets

CONNECTICUT.

Middletown—Caulkins & Post Co., 406-408 Main street.
New Haven—Pardee-Ellenberger Co., 155 Orange st.

DISTRICT OF COLUMBIA.

Washington—E. F. Droop & Sons Co., 925 Pennsylvania avenue, N. W.
 S. Kann Sons & Co., 8th and Pennsylvania avenues.

GEORGIA.

Atlanta—Atlanta Phonograph Co., 49 Peachtree St.
Waycross—George R. Youmans.

ILLINOIS.

Chicago—*Babson Bros., 148 Michigan Ave.
 *Lyon & Healy, Wabash Ave. & Adams St.
 James I. Lyons, 102 Van Buren street.
 Talking Machine Co., 107 Madison street.
 The Vim Co., 68 E. Lake street.
 Montgomery Ward & Co., 111 Michigan ave.
 Rudolph Wurlitzer Co., 302 Wabash ave.
Peoria—Peoria Phonograph Co., 413 S. Adams street.
Quincy—Quincy Phonograph Co., 808 Hampshire st.

INDIANA.

Indianapolis—Craig-Jay Co., 234 Massachusetts ave.
 Kipp Bros. Co., 37 S. Meridian street.
 A. B. Wahl & Co., 119 S. Illinois street.
Lafayette—A. B. Wahl & Co., 304 Main street.

IOWA.

Des Moines—Hopkins Bros. Co., 620 Locust street.
 Vim Co., 704 West Walnut street.
Fort Dodge—Early Music House, 822 Central ave.

KENTUCKY.

Louisville—C. A. Ray, 640 Fourth street.

LOUISIANA.

New Orleans—William Bailey, 600 Frenchman street.
 National Automatic Fire Alarm Co.,
 614 Gravier street.

MAINE.

Bangor—S. L. Crosby Co., 186 Exchange street.
Portland—W. H. Ross & Son, 207 Commercial street.

MARYLAND.

Baltimore—E. F. Droop & Sons Co., 109 N. Charles St.

-MASSACHUSETTS.

Boston—Boston Cycle & Sundry Co., 48 Hanover street.
 Eastern Talking Mach. Co., 177 Tremont st.
 Iver Johnson Sptg. Goods Co., 163 Washington street.
 C. E. Osgood Co., 744 Washington street.
 Read & Read, 630 Washington street.
Fitchburg—Iver Johnson Sptg. Goods Co., 247 Main st.
Lowell—Thomas Wardell, 111 Central street.
New Bedford—Household Furnishing Co., 170 Purchase street.
Springfield—Flint & Brickett Co., 439 Main st.
Worcester—Iver Johnson Sptg. Goods Co., 304 Main st.

MICHIGAN.

Detroit—American Phono. Co., 106 Woodward ave.
 Grinnell Bros. 219 Woodward ave.

MINNESOTA.

Minneapolis—Thomas C. Hough, 714 Hennepin ave.
St. Paul—W. J. Dyer & Bro., 21-23 West 5th street.
 Thomas C. Hough, 392 Wabasha street.
 Minnesota Phonograph Co., 37 E. 7th street.

MISSOURI.

Kansas City—J. W. Jenkins' Sons Music Co., 1013-1015 Walnut street.
 J. F. Schmelzer & Sons Arms Co., 710 Main street.

St. Louis—Conroy Piano Co., 11th and Olive streets.
 O. K. Houck Piano Co., 1118 Olive street.
 Western Talking Machine Co., 923 Olive st.

NEBRASKA.

Lincoln—H. E. Sidles Cycle Co., 1317 O street.
Omaha—Nebraska Cycle Co., 15th and Harney streets.
 Omaha Bicycle Co., 16th & Chicago sts.

NEW JERSEY.

Hoboken—Eclipse Phono. Co., 205 Washington st.
Newark—A. O. Petit, New and Halsey streets.
Paterson—James K. O'Dea, 117 Ellison street.
Trenton—Stoll Blank Book and Stationery Co., 30 E. State street.
 John Sykes, 105 N. Broad street.

NEW YORK.

Albany—Finch & Hahn, 92 State street.
Brooklyn—A. D. Matthews' Sons, 394 Fulton street.
 Price Phonograph Co., 1260 Broadway.
Buffalo—P. A. Powers, 613 Main street.
Elmira—Elmira Arms Co., 117 Main street.
Gloversville—American Phono. Co., 99 W. Fulton st.
Kingston—Forsyth & Davis, 307 Wall street.
New York City—Bettini Phono. Co., 156 W. 23d street.
 Blackman Talking Machine Co., 97 Chambers street.
 J. F. Blackman & Son, 2737 3d avenue.
 Sol Bloom. New Amsterdam Theatre Building.
 I. Davega, Jr., 802 Third avenue.
 S. B. Davega, 32 E. 14th street.
 Douglas Phono. Co., 89 Chambers st.
 H. S. Gordon, 139 Fifth avenue.
 Harry Jackson, 219 Bowery.
 Jacot Music Box Co., 39 Union Square.
 Victor H. Rapke, 1661 Second avenue.
 Siegel-Cooper Co.
 John Wanamaker.
 Alfred Weiss, 1525 First avenue.
Oswego—Frank E. Bolway, 32 Bridge street.
Poughkeepsie—Price Phonograph Co., 203 Main st.
Rochester—A. J. Deninger, 345 North street.
 Mackie Piano, O. & M. Co., 100 State street.
 Giles B. Miller, 63 State street.
 Talking Machine Co., 97 Main st., E.
Schenectady—Finch & Hahn, 504 State street.
 Jay A. Rickard & Co., 253 State street.
Syracuse—W. D. Andrews, 216 E. Railroad street.
Troy—Finch & Hahn, 3 Third street.
Utica—Clark-Horrocks Co., 54 Genesee street.
 Arthur F. Ferriss, 89 Washington street.
 William Harrison, 41 Columbia street.
 Utica Cycle Co., 31 Columbia street.

OHIO.

Canton—Klein & Heffelman Co., 216 N. Market street.
Cincinnati—Ilsen & Co., 25 W. 6th street.
 Rudolph Wurlitzer Co., 10-12 W. 4th st.
Cleveland—Eclipse Musical Co., 162 Prospect st.
Columbus—Perry B. Whitsit Co., 213 S. High street.
Dayton—Niehaus & Dohse, 35 E. 5th street.
Newark—Ball-Fintze Co.
Toledo—Hayes Music Co., 608 Cherry street.

OREGON.

***Portland**—Graves & Co., Inc., 328 Washington St.

PENNSYLVANIA.

Allegheny—Henry Braun, 500 Federal street.
Allentown—G. C. Aschbach, 539 Hamilton street.
Easton—William Werner, 401 Northampton street.
Harrisburg—S. K. Hamburger, 12-14 N. Market sq.
New Castle—W. C. DeForeest & Son.
Philadelphia—C. J. Hepp & Son, 1117 Chestnut street.
 Lit Bros., Market and 8th streets.
 Penn Phonograph Co., 17 S. 9th street.
 John Wanamaker, 13th and Market sts.
 Wells Phonograph Co., 45 N. 9th street.
 Western Talking Mach. Co., 25 S. 9th st.
 H. A. Weymann & Son, 923 Market st.
Pittsburg—Theo. F. Bentel Co., Inc., 632 Liberty street.
 Kaufmann Bros., Fifth avenue.
 H. Kleber & Bro., 221 Fifth avenue.
 C. C. Mellor Co., 319 Fifth avenue.
 Pittsburg Phono. Co., 937 Liberty street.
 Talking Machine Co., 619 Penn ave.
Reading—Reading Phonograph Co., 809 Penn street.
Scranton—Ackerman & Co., 130 Wyoming avenue.
 Technical Supply Co.
Williamsport—W. A. Myers, 145 W 3d st.

RHODE ISLAND.

Pawtucket—Pawtucket Furniture Co., 39 N. Main St.
Providence—J. M. Dean Co., 785-795 Westminster street.
 J. A. Foster Co., Weybosset st.
 Household Furniture Co.
 J. Samuels & Bro., 154 Weybossett street.
 A. T. Scattergood & Co., 106 N. Main st.

TENNESSEE.

Knoxville—Knoxville Typewriter and Phonograph Co., 421 Gay street.
Memphis—O. K. Houck Piano Co., 359 Main street.
 F. M. Atwood, 160 N. Main St.
Nashville—Nashville Talking Mach. Co., 510 Church st.
 Magruder & Co., 13 Arcade.

JOBBER'S OF EDISON PHONOGRAPHS AND RECORDS—Continued.**TEXAS.**

Dallas—Southern Talking Machine Co., 347 Main st.
 El Paso—W. G. Walz Co., 101 El Paso street.
 Fort Worth—Cummings, Shepherd & Co., 700 Houston st.
 Houston—Texas Phono. Co., Capitol and Fannin Sts.
 San Antonio—H. C. Rees Optical Co., 242 West Commerce St.

VIRGINIA.

Richmond—Magruder & Co., 729 E. Main st.

WASHINGTON.

*Seattle—D. S. Johnston Co., 903 Second Ave.
 *Spokane—Spokane Phono Co., 7 Post St.

WISCONSIN.

Milwaukee—McGreal Bros., 173 3d street.

CANADA.

Toronto—R. S. Williams & Sons Co., Limited,
 143 Yonge street.
 Winnipeg—R. S. Williams & Sons Co., Ltd., 121 Princess street.

*Added since October 1, 1905.

SUSPENDED LIST, NOVEMBER 1, 1905.**SUPERSEDING ALL PREVIOUS LISTS.****GEORGIA.**

*Valdosta—H. K. McLendon, 109 West Central Ave.

ILLINOIS.

Champaign—Eggleston Bros.
 Ottawa—Edward Hayne.
 Wheaton—E. Irving.

INDIANA.

South Bend—EUGENE MARSH, 126 Vistula avenue.
 SOUTH BEND BOOK BINDERY, Robert Lebolt, Prop., 203 North Michigan street.

IOWA.

Burlington—JOHN P. WEISS, 711 Jefferson street.
 Sioux City—HATTENBACH BROS. CO.
 A. V. LARIMORE, 518 Fifth street.

KANSAS.

Clay Centre—E. M. GOWENLOCK.
 Lawrence—BELL BROS.
 Topeka—R. H. MOREHOUSE, 510 E. 4th street.

MAINE.

Biddeford—W. H. FIELD.
 Lewiston—J. W. SKENE.
 Monmouth—G. H. STETSON.

MASSACHUSETTS.

Boston—E. C. PECK, 43 Milk st.
 T. SINGER, 60 Leverett street.
 *Franklin—E. P. Blackman.
 Lawrence—LORD & CO., 314 Essex street.
 E. O. MOSHER, 420 Essex street.
 Lynn—ELIAS DEYOUNG.
 Malden—A. T. FULLER.
 Nantucket—ARTHUR M. TAYLOR.
 New Bedford—H. B. DEWOLFF.
 Somerville—E. J. WINCHESTER, 32 Summit avenue.
 Woburn—OSBORN GILLETTE, or THE BOLTON JEWELRY CO., L. F. Maloney, Manager.

MICHIGAN.

Detroit—F. J. SCHWANKOVSKY.
 Saginaw—GEO. W. EMENDORFER.
 JAMES V. CALAHAN, 217 Genessee st.
 TIERNEY BROS., 217 Genessee st.

MISSOURI.

Kansas City—THE WITTMANN CO.

NEBRASKA.

Lincoln—THE WITTMANN CO.
 Omaha—THE WITTMANN CO.

NEW HAMPSHIRE.

Hillsboro Bridge—E. M. BARNES.
 Manchester—A. E. DUMAS
 Nashua—F. A. McMASTER & CO.

NEW JERSEY.

Atlantic City—SAM'L D. WOLF, 32-34 Arkansas ave.
 Bayonne—I. WIGDOR, 450 Avenue D.
 Jersey City—W. L. HOFFMAN, 151 Montgomery st.
 Newark—R. L. CORWIN; also New York City.
 Passaic—I. HURWITZ.
 Paterson—CHAS. H. KELLY, 25 N. Main street.

Plainfield—S. W. FRUCHT, or R. FRUCHT; also
 New York City.
 ELSTON M. LEONARD.
 West Hoboken—EMIL HOLLANDER, or THE WEST
 HOBOKEN BICYCLE & PHONO. CO., 619
 Spring street.

NEW YORK.

Albany—G. LINDE, 353 S. Pearl street.
 Bedford Park—GEO. H. TYRRELL.
 Brooklyn—WM. ALBRECHT, 294 Knickerbocker ave.
 H. HINDERMANN, BUSHWICK PHONO-
 GRAPH EXCHANGE, 1421 Myrtle avenue.
 Hobart—F. H. MARSHALL.
 New York City—A. T. ARMSTRONG, or AMERI-
 CAN PHONO. CO., 106 Wall street.
 AUTOMATIC ZITHER CO., M. Cohen, Prop.,
 58 Second avenue.
 BERN BEARWALD, 373 W. 11th st.
 BRONX PHONO. CO. or DAVID SWITKY,
 506 Willis ave
 CENTRAL PHONO. CO., 160 E. 42d street.
 R. L. CORWIN; also Newark, N. J.
 EAGLE PHONO. CO., or C. LOWENTHAL,
 83 Nassau street.
 EMPIRE PHONO. CO., 2 W. 14th street.
 S. W. FRUCHT, or R. FRUCHT, 7 Barclay st.,
 or 68 Cortlandt st.; also Plainfield, N. J.
 O. HACKER, 2 Murray street.
 HAWTHORNE & SHEBLE, 297 Broadway;
 also Philadelphia, Pa.
 HOLOBER BROS., 350, 421 and 491 West st.
 N. HORN, 148 E. 58th street.
 W. L. ISAACS, 114 Fulton street.
 S. LEMBURG & CO., 194 Broadway.
 J. MCELLYNNE, 202 Broadway.
 RICHMOND PEASE, 44 W. 132d st.
 F. M. PRESCOTT, 44 Broad st.
 WINTHROP CYCLE CO., 2212 Seventh ave.
 Rome—CHARLES TUTTLE.
 Saratoga—W. J. TOTTEN.
 Saratoga Springs—MARVIN A. COTE.
 Watertown—HENRY A. HARDY, 24 Arsenal st.
 H. S. WARDWELL & CO., 39 Public Square.

NORTH CAROLINA.

*Kingston—S. A. Quinerly.

OHIO.

Cincinnati—J. L. ANDEM.
 Coshocton—BURNS & GOSSER.
 Springfield—D. & M. VANDERPOOL.
 Uhrichsville—F. A. MAZURIE.

PENNSYLVANIA.

Philadelphia—A. R. CASSIDY, 2783 Emerald street.
 HAWTHORNE & SHEBLE, 604 Chestnut st., or
 Oxford and Mascher sts.; also New York City.
 A. KROUSE, 832 Arch street.
 PENN NOVELTY CO., 15 South 9th st.
 Phoenixville—KEINARD BROS.
 Pittsburg—A. LIPPARD, 615 Wylie ave.

RHODE ISLAND.

Providence—F. P. MOORE.

WISCONSIN.

Milwaukee—J. C. BLATZEK.

*Added Since October 1, 1905.

Jobbers and Dealers are asked not to supply any of the above named firms with our apparatus, either at addresses given or any other address.

DOUBLE SERVICE



NOVEMBER 1905

SUN.	MON.	TUE.	WED.	THUR.	FRI.	SAT.
-	-	-	1	2	3	4
5	6	7	8	9	10	11
12	13	14	15	16	17	18
19	20	21	22	23	24	25
26	27	28	29	30	-	-

**LANGUAGE
STUDY**

AMUSEMENT

Stock up for the holidays. The Profit-and-Pleasure Present is the best of all presents, and nothing of this kind is as good as the I. C. S. Language Outfit with Edison Repeating Phonograph. Do **YOU** handle "**DOUBLE SERVICE**"? If not, send 50 cents for a demonstrating outfit. It has increased other dealers' business from 10 to 30 per cent.

LANGUAGE DEPARTMENT

**INTERNATIONAL CORRESPONDENCE SCHOOLS
SCRANTON, PA.**

FOR FOREIGN SALES, ADDRESS } Foreign Dept., National Phonograph Co., 31 Union Square, New York City.
 } European Headquarters, National Phonograph Co., Ltd., 25 Clerkenwell Road, London, E. C.

EDISON Phonograph Monthly

PUBLISHED FOR TRADE USE ONLY BY
THE NATIONAL PHONOGRAPH CO.

VOL. III. ORANGE, N. J., DECEMBER, 1905. No. 10.

NATIONAL PHONOGRAPH CO.
ORANGE, N. J.

NEW YORK: 31 UNION SQUARE.

CHICAGO: 304 WABASH AVENUE.

SAN FRANCISCO: 786 MISSION STREET.

NATIONAL PHONOGRAPH CO., LTD., 25 CLERKENWELL
ROAD, LONDON, ENG.

EDISON PHONOGRAPHS AND RECORDS.

All communications to THE PHONOGRAPH MONTHLY
should be addressed to the Advertising Department,
Orange, N. J.

C O N T E N T S

The Holiday Season.....	1
Advance List of Edison Gold Moulded Records for January, 1906.....	2
Abuse of Sample Record Privilege.....	3
Not a Mistake.....	3
Will be Called "Balmoral".....	3
Shall Dealers Sell on Instalments?.....	4
75 Records to be Eliminated from List....	5
Inferior Parts.....	5
Music Publishers	6
Get Them to Buy New Ones.....	6
Standard Speed Test.....	6
Treated Well It Will Pay Well.....	6
The Phonograph.....	6
Advertising Dealers.....	7
Advertise Locally.....	7
Printed Matter.....	7
The Phono Trader's Opinion.....	7
Comments on Edison Gold Moulded Rec- ords for January, 1906.....	8
The Phonogram.....	9
No More Divided Orders.....	10
The Art of Attracting Custom.....	10
Will the Wonders Ever Cease?.....	10
Graves & Co., Portland, Ore.....	11
Edison Phonograph Christmas Advertise- ment	13
Jobbers of Edison Phonographs and Rec- ords	14
Suspended List for December.....	15

THE HOLIDAY SEASON.

If the year 1905 lives up to its record for another month, the holiday season now at hand will be the most successful in the history of the Phonograph trade. The extent of each Dealer's success now depends largely upon his own efforts. If he is aggressive and enterprising, he will succeed handsomely; if indifferent, his business will be small. For weeks we have worked every department of our factory to its utmost capacity to turn out Phonographs and Records, and while we are still far from being caught up on orders, we believe that our efforts have produced Phonographs and Records in sufficient quantities to provide every Dealer with a stock large enough to do the biggest holiday trade he has ever seen. The extent to which Edison Phonographs will be bought for Christmas presents this month will astonish even those familiar with the unusual conditions constantly arising in the Phonograph business.

An Edison Phonograph possesses many qualities which make it an ideal Christmas present, for it has a place in every home and is something that will not lose its novelty in a day, but will furnish amusement for a family for months and even years to come. This view of it is going to be taken by thousands of families, and they are going to spend their money accordingly.

The National Phonograph Co. has been doing more advertising this year than any time in its history, and we believe that it has done much to cause the present widespread demand for Edison Phonographs and Records. Local Dealers can get a direct benefit from this advertising by taking such steps as will tell the people of their city or town that they have the goods and can take care of their demand. It is the season of the year above all others when advertising of Edison goods yields its best results, and Dealers should advertise liberally now, even though they do not at any other time of the year.

THE ADVANCE LIST OF JANUARY RECORDS APPEARS ON PAGE 2.

NEW EDISON GOLD MOULDED RECORDS. ADVANCE LIST FOR JANUARY, 1906.

RECORDS listed below will be ready for shipment as near **January 1st** as possible, at which time Jobbers' stock orders, if **received prior to December 10th**, will be shipped. January Supplements will be forwarded to Jobbers with their stock orders for Records. Retail Dealers should place stock orders with their Jobbers at once, to insure prompt shipment as soon as Jobbers' stock is received.

- 9170 The Choristers (*Phelps*) Edison Concert Band
Introducing chimes, birds and bells.
- 9171 Somebody's Sweetheart I Want to Be (*Cobb and Edwards*) Byron G. Harlan
Sentimental song, Orch accom.
- 9172 Fritzzy and Louisa (*Vaudeville*) Ada Jones and Len Spencer
German dialect sketch, with singing and orchestra incidental music
- 9173 A Lovely Night in June (*Missud*) Bells solo, Orch accom. Albert Benzler
- 9174 I'm Getting Sleepy (*Hollander*) Coon song, Orch. accom. Arthur Collins
- 9175 If a Girl Like You, Loved a Boy Like Me (*Cobb and Edwards*) Harry MacDonough
Waltz song hit as sung by Lillian Russell in vaudeville, Orch. accom.
- 9176 Hebrew Vaudeville Specialty (*Original*) Julian Rose
Hebrew monologue, introducing parody on "In the Shade of the Old Apple Tree," Orch. accom.
- 9177 Lights Out March (*McCoy*) Edison Military Band
- 9178 Miss Mary (*Olcott and Northrup*) Irving Gillette
Sentimental song from Chauncey Olcott's new play "Edmund Burke," Orch. accom.
- 9179 The Load That Father Carried (*Mullen*) Comic song, Orch. accom. Bob Roberts
- 9180 Pass Me Not, O Gentle Saviour (*Doane*) Anthony and Harrison
Sacred male duet, Orch. accom.
- 9181 Forget-Me-Nots (*Englemann*) Edison Symphony Orchestra
- 9182 I'm a Woman of Importance (*Schwartz*) Ada Jones
Comic song from "Fritz in Tammany Hall," Orch. accom.
- 9183 La-Tydley Tydley Um (*Morse*) Edward M. Favor
Comic song, Orch. accom.
- 9184 Paddle Your Own Canoe (*Morse*) Collins and Harlan
"A Darkey ditty," male duet, Orch. accom.
- 9185 It Blew! Blew! Blew! Schottische (*Johnson*) Edison Concert Band
A new Record for dancing
- 9186 Robin Redbreast (*DeKoven*) Miss Marie Narelle
Soprano solo from "Happyland" with bird imitations by Joe Belmont, Orch. accom.
- 9187 Good-Bye "Dixie" Dear (*Penn*) MacDonough and Biehling
March song, male duet, Orch. accom.
- 9188 Yankee Boodle (*Schwartz*) Billy Murray
Topical song from "Fritz in Tammany Hall," Orch. accom.
- 9189 A Gay Gossoon (*Kendall*) Vess L. Ossman
Characteristic march, banjo solo, Orch. accom.
- 9190 Take Me to Your Heart Again (*Richmond*) Edward Barrow
Sentimental song, Orch. accom.
- 9191 Barnyard Serenade (*Original*) Spencer and Holt
Descriptive talking Record, punctuated with imitations of the barnyard denizens
- 9192 The Jolly Blacksmiths (*Geibel*) Edison Male Quartette
Male quartette, unaccompanied, introducing the Anvil Chorus from Verdi's "Il Trovatore"
- 9193 Fol-the-rol-lol Medley (*Original*) Edison Military Band
Introducing "Fol-the-rol-lol," "Sympathy," "Starlight," "Silver Threads Among the Gold" and "Can't You See I'm Lonely"

Edison Gold Moulded Records are made only in Standard Size. Both Standard and Concert Records may be ordered from this list. Order by number, not title. If Concert Records are wanted, give the number and letter C.

ABUSE OF SAMPLE RECORD PRIVILEGE.

The plan of sending samples of new Records to Jobbers one month in advance of their general shipment to the trade was adopted in order that Jobbers might learn by hearing them just how good they were from a selling standpoint, and be able to make out their orders in a more intelligent manner. It was recognized that without being able to hear them a Jobber could not arrive at a satisfactory conclusion in making out his monthly order. Then Jobbers were permitted to play them for Dealers, either by having Dealers visit their stores or by sending them to the stores of Dealers when accompanied by a salesman. Still later Jobbers who did not employ salesmen were permitted to ship these sample Records from one Dealer to another, with the distinct understanding that they should not be played before the public.

All of this was done in the interest of Jobbers and Dealers and it was understood from the beginning that the whole arrangement was to be purely a trade matter. It was one of which the public was to know nothing and we endeavored to make it clear that the Records were in no instance to be played to individuals outside of the trade. We regret to say that the privilege has been abused in a manner, which, if continued, will compel us to cut off entirely from offending Jobbers the privilege of getting these samples. The latest abuse of the privilege has been by certain Dealers advertising and inviting the public to hear the new Records when sent to them by their Jobbers. This abuse will not be permitted to continue. Jobbers must refuse to ship samples to Dealers unless they will agree not to play them before the public, or we shall feel compelled to refuse to send them to Jobbers who ship them to Dealers knowing that the latter will play them publicly.

There are excellent reasons why sample Records should not be played to any one outside of the trade. In the first place, it accomplishes no good to play them beyond the amusement of a few individuals who can just as well wait until the Records are on the market. On the other hand, permitting them to be played in advance must necessarily be a source of constant trouble and friction. For instance, there are two or more Dealers in one town. One Dealer buys of Jobber A and the other of Jobber B. The sample Records of Jobber A reach the town a week in advance of those of Jobber B, or probably the latter does not send out samples at all. As a result the Dealer buying from Jobber A gets the new Records, plays them for the public and

gets credit for being more enterprising than his competitor. The latter, on the contrary, is fully as alive as the other Dealer and naturally feels that he has not been fairly used. There are a number of other good reasons why the abuses must not continue. It is not necessary, however, to refer to them here, for we are determined that these samples shall not be used for any other purpose than we intended when the plan was put into effect. Those who continue to offend must not find any fault if they are summarily cut off from the privilege of hearing sample Records.

NOT A MISTAKE.

We are in receipt of a letter from a Dealer stating that two of his customers selected old style Home machines in preference to the new style recently put out. He states that they did this on account of the speed regulating screw being on top of the cabinet. This experience leads him to ask whether we do not think that we have made a mistake in placing the speed regulating screw on the under side of the machine instead of the top. Instead of thinking it a mistake, we still strongly claim that the change is a marked improvement. The speed-adjusting screw when on top of the machine was constantly being turned by inexperienced players, changing the speed of the machine and causing an unsatisfactory playing of Records. With the speed-adjusting screw on the underside, it is quite accessible when it is desired to change the speed for some good reason, and it is out of the way of idle or mischievous hands. As a matter of fact, if Phonograph owners would get their machines adjusted to the right speed at the start, they would find it much more advisable not to make any change in it. Our Records are made at a uniform speed of 160 revolutions per minute and there is no occasion for running a Phonograph at any other speed, notwithstanding the views of those individuals who think they can improve the Records by increasing or decreasing the speed. Those who once get their machines running at the right speed and give it no further thought will get the best and most satisfactory results from their Records.

WILL BE CALLED THE "BALMORAL".

It has been decided to change the name of the Victor Phonograph (battery current playing standard size Record) to "Balmoral." This change will take effect as fast as new literature is printed, beginning with the new edition of the Phonograph Catalogue.

SHALL DEALERS SELL ON INSTALMENTS?

Whether or not to sell Edison Phonographs on what is known as the instalment plan is a question that is being debated by many Dealers throughout the country. Among many Dealers who have not given the subject proper thought there is considerable prejudice against the general plan of selling goods in this manner. Viewed superficially, they can only see in it considerable trouble and many chances of loss. They are apt to regard the firms who are selling goods in this way as lacking in business acumen, and as those whose failures are only a matter of time. Many men who have not taken the trouble to investigate the subject have declared time and time again that before they would sell goods on instalments they would go out of business, and with this declaration they have dismissed the subject.

As a matter of fact, selling Phonographs on instalments does not mean half the trouble that many Dealers fancy. In fact, it is much easier to sell a Phonograph to a man upon a small payment with an agreement to make other payments weekly than it is to get him to lay down the entire amount of the purchase. Of course, as an offset to this, there is the trouble of making the weekly collections, if a collector is sent out, or of making a series of entries on the books when the payments are made at the store. This, after all, is a clerical detail and easily handled.

Firms who make a feature of selling Phonographs on instalments do not take any greater risk than a grocer would in the ordinary course of his business. These firms do not turn a Phonograph over to a man simply because he comes in and makes the first payment or signs an agreement to make a weekly payment. On the contrary, before they allow the machine to go out, they find out who the man is, where he works, what he is probably earning, and they get two or more desirable people to say that he will in all probability complete the payments required to own the machine sold him. The experience of men doing this character of business has shown that a very small proportion of those who get a Phonograph on this plan fail to make the payments, and a very much smaller proportion still disappear with the machine before they have finished paying for it. Probably not five per cent. of those who buy a Phonograph on instalments return it, and not two cases in a hundred does a Dealer actually lose the machine without being compensated.

In some States the laws are such that the title of the machine passes as soon as a pay-

ment is made upon it and the remaining payments are considered by the law as similar to all other debts. In such States there is, perhaps, a little larger element of uncertainty about doing business in this manner, but an extra precaution in making sales will offset this risk. In all other States the Dealer remains the owner of a machine until the payments have been completed, and the purchaser who fails to make his payments loses not only his machine but the payments he has made, unless the Dealer leniently returns to him the amount above the wear and tear on the instrument. Such a variety of goods is now successfully sold on the instalment plan, that there is no longer any question about the propriety of doing this kind of a business.

Selling Phonographs on instalments can only be successfully done where the Dealer has a reasonable amount of capital that he can invest in this way. If his means are limited, it would be foolish for him to consider the matter. If, however, he has capital enough to handle a business of this character, there is no reason why he cannot make money in doing so. It has never been the policy of this Company to urge Jobbers or Dealers to do an instalment business, for we have always felt that the decision should rest with the individual or firm. The experience of others has shown that it is a legitimate and profitable way of selling Phonographs, and that no reason exists why those now prejudiced against it should not follow in the same footsteps. The greatest argument in favor of an instalment business is that five men will buy goods on instalments to one who will pay spot cash, and it simply means that Dealers selling on time payments would sell five machines where they now sell one.

Then, too, since Records are seldom sold on instalments, the Dealer makes a nice cash sale of Records with every Phonograph put out, and he has a steady and profitable customer for Records for at least the time the payments are being made; and indefinitely if the customer gets the right sort of treatment. In fact, it is worth while to get a Phonograph into a home for the Record business that will follow.

ALWAYS GETTING BETTER.

Have been handling Edison goods for more than ten years, and the longer I am associated with them the better they become. I like your principle of doing business. I thank you for your past favors and trust that you may always maintain your present sterling business standing, which makes it a pleasure to handle your goods.

JOS. V. CHRISTY.
San Jose, Cal.

75 RECORDS TO BE ELIMINATED FROM LIST.

Notice is hereby given that after February 1st, 1906, we will be unable to supply the following Records and they will not appear in Record Catalogues issued after that date. Many, if not all, of these are good selling selections. We, therefore, trust that the trade will be able to dispose of stock on hand before they are dropped, but even after that date there will be a demand for them from catalogues now out. The chief reason for eliminating them is to give the trade additional space to carry the new Records listed monthly.

6913	His Little Wife Was With Him	Quinn
7234	Fairhill Wheelman	Siegel
7237	Nine Knights March	E. M. Band
7406	Sweet Suzanne	Fisher
7514	Ethiopian Bouquet	Siegel
7537	Her Name Is Rose	Natus
7556	Vaudeville Specialty, No. 5	Denny
7735	I'll Be Your Sweetheart	Clifford
7756	I Want to Be a Military Man	Quinn
7808	3.33 in the Morn	Denny
7936	March from the Strollers	P. Orchestra
7992	Soldier's Bride	Thompson
8018	On a Sunday Afternoon	Libby
8039	Parody on I've Waited, Honey, Waited	North
8051	Oriental Rondo	P. Orchestra
8078	Facilita	Liberati
8095	Cupid's Garden	P. Orchestra
8119	On a Saturday Night	Favor
8137	March from Die Verkaufte Braut	P. Orchestra
8156	Cinderella	Spencer
8157	Cock Robin	Spencer
8210	Susie Woosie	Favor
8229	March Medley from Salley in Our Alley	P. Orchestra
8242	Absent Minded Man	Favor
8283	Sel. from Old Limerick Town	P. Orchestra
8367	Coo,	Clifford
8388	What's the Matter with the Moon	Clifford
8401	Glory	Clifford
8405	Won't You Roll Dem Eyes	Collins
8458	The Moss Rose	E. S. Orchestra
8463	While the Moon Shines Bright	Harlan
8478	You'd Better Ask Me	Clifford
8493	Dreamy Eyes	Ossman
8505	In Starlight	Thompson
8506	Thy Sentinel Am I	Stanley
8510	Sweet Remembrance	E. S. Orchestra
8513	Le Tremolo	Molé
8514	Poverty's Tears Ebb and Flow	Thompson
8518	There's Music in the Air	Tally
8520	Love's Dilemma	Clifford
8523	Love and Passion	E. S. Orchestra
8530	When the Fields are White, Etc.	Wallace
8534	I Like You, Lil, for Fair	Quinn
8540	Lobster's Promenade	Van Epps
8543	Once in Awhile	Morgan
8547	Mister Breezy Was an Easy Mark	Denny
8548	Sun Dance	E. S. Orchestra
8551	Flowers of Dixie Land	Wallace
8552	Trixie	Denny
8556	Last Farewell	Wallace
8558	Miller's Daughter	MacDonough
8559	That's How I Love You, Mame	Collins
8568	Girl You Love	MacDonough
8572	Maid of Timbuctoo	MacDonough
8578	Rooster Dance	E. S. Orchestra
8581	My Dixie Lou	Collins
8589	Sukey Sue	MacDonough
8592	Celia	Collins
8597	Mary Ellen	Murray
8603	Lovey Mary	E. S. Orchestra
8605	A Dream	Lenox
8634	In the Lives of Famous Men	Roberts
8682	Roses' Honeymoon	E. S. Orchestra
8691	He Done Me Wrong	Collins
8714	Then and Now	Harrison
8716	On the Wings of Love	Francelli and Lewis
8777	Russian Story	E. S. Orchestra
8786	Forsaken—Verlassen	Edison Brass Quartette
8787	Back Among the Clover and the Corn	Harrison
8793	Bloom is on the Rye	Lenox
8802	Star of My Life	Thompson
8821	She Was a Good Old Soul	Stanley
8843	There's Nothing New to Say	MacDonough
8851	My Little Canoe	E. S. Orchestra
12575	La Gran Via (Spanish)	Carmen

INFERIOR PARTS.

Complaints reach us occasionally from individuals who claim that they bought certain repair parts like sapphires, feed-nuts, springs, etc., from their Dealers and found that they were decidedly inferior. Investigation of such cases has shown that the supplies and parts had not been obtained from us, but had been bought from outside individuals at slightly lower rates than we charge them. The retail purchasers of these supplies and parts naturally thought that they were buying Edison goods and our reputation suffered, though we were in no way responsible for the substitution. This leads us to point out to the trade generally, and especially Dealers, that it does not pay to buy inferior goods of this character, because they can be had for a little less money than charged by us for the same parts. A Dealer can impose upon his customer once, but in most instances he cannot do it a second time, for as soon as the customer learns of the imposition he will not only refuse to buy further parts from him but he will in all probability take away his Record patronage. The parts made by us for the various types of Phonographs are the best that can be produced, and they are worth all that is asked for them. Dealers will be wise if they buy Edison supplies and parts and get them only from such sources as they can rely upon. We feel sure that no Jobber would attempt to sell inferior goods when Edison goods are asked for. Dealers are especially cautioned against buying sapphires except those known to be made by us. Ordinary glass when rounded and polished looks to the eye very much the same as a genuine sapphire and yet is a much different article when put into actual use. It soon wears, and when it begins to wear, it cuts the Records and causes trouble all around. The saving of a few cents on a sapphire will cause dollars of mischief in the future to all who get them. Jobbers will do well to handle no other sapphires except those bought from us, and Dealers should buy them only from such Jobbers as they can rely on.

MONEY TALKS.

The Kern Music Co., of Jersey City, N. J., backed its belief in Edison Phonographs by running the following phrase in display type in the daily papers:

"\$50.00 cash! Reward will be paid for proof that any Phonograph is as good as an Edison."

MUSIC PUBLISHERS.

The publishers of the music in the January list of Edison Records will not be printed until the January issue of the PHONOGRAPH MONTHLY. The lists will be printed regularly thereafter. Since this information seems to be in such general demand, the publishers of the October and November music, so far as we know them, are given below.

- 9098 Selection from Chimes of Normandy, Carl Fischer, New York.
 9099 In Dear Old Georgia, Jerome H. Remick & Co., New York.
 9100 Everybody Works but Father, Helf & Hager, New York.
 9102 I Wait for Thee, John Church Co., New York.
 9105 A Picnic for Two, New York Music Co., New York.
 9107 The Whistler and His Dog, Carl Fischer, New York.
 9108 I'll be Waiting in the Gloaming, Sweet Genevieve, Helf & Hager, New York.
 9110 New Era Overture, Carl Fischer, New York.
 9111 What You Goin' To Do When the Rent Comes 'Round, Harry Von Tilzer Pub. Co., New York.
 9112 Angelena, G. W. Setchell, Boston, Mass.
 9114 My Word, M. Witmark & Sons, New York.
 9115 Leader of the German Band, F. B. Haviland Pub. Co., New York.
 9116 Yankee Grit March, Leo Feist, New York.
 9117 Wearing of the Green, Oliver Ditson, Boston, Mass.
 9118 Hiram Green, Good-Bye, C. M. Chapel, Chicago, Ill.
 9120 Hard Times Come Again No More, Oliver Ditson, Boston, Mass.
 9121 My Maryland March, Leo Feist, New York.
 9122 Hungarian Fantasie, Carl Fischer, New York.
 9124 On the Bank of the Rhine with a Stein, Harry Von Tilzer Pub. Co., New York.
 9125 The Friendly Rivals, Carl Fischer, New York.
 9126 Honeymoon Hall, M. Witmark & Sons, New York.
 9127 In Timbuctoo, F. B. Haviland Co., New York.
 9129 Bold Front March, Carl Fischer, New York.
 9130 Wait 'Till the Sun Shines, Nellie, Harry Von Tilzer Pub. Co., New York.
 9131 And the World Goes On, J. W. Stern & Co., New York.
 9132 Betty, Continental Music Co., New York.
 9133 Roses and Thorns, W. H. Cundy, Boston, Mass.
 9134 We'll be Together When the Clouds Roll By, F. A. Mills, New York.
 9135 I'm the Only Star that Twinkles on Broadway, H. Von Tilzer Pub. Co., New York.
 9136 Pretty Mary, F. A. Mills, New York.
 9137 Dancing in the Starlight, Carl Fischer, New York.
 9138 The Sweetest Flower That Blows, John Church Co., New York.
 9139 Have You Seen My Henry Brown, New York Music Co., New York.
 9140 The Irish Girl I Love, Rogers Bros. Music Pub. Co., New York.
 9141 Sweet Little Daisies, Harry Coleman, Philadelphia, Pa.
 9144 When the Evening Breeze is Sighing "Home, Sweet Home," J. W. Stern & Co., New York.

GET THEM TO BUY NEW ONES.

Most Dealers do not realize how important a belt is to a Phonograph. If they did, they would point out more frequently to their customers the desirability of getting a new belt instead of attempting to repair an old one. A new belt for a Gem machine costs but 10 cents, one for the Home and Standard machines, 15 cents and one for the Triumph 25 cents. At these prices it does not pay any one to attempt to mend an old belt, to say nothing

of the unsatisfactory results caused by a belt so repaired. When Dealers hear their patrons talk about mending a belt, they should strongly urge them to get a new one instead of doing so.

A STANDARD SPEED TEST.

On the back rod of every Edison Phonograph now being shipped from this factory, two circular marks have been placed at a distance of one and six-tenths (1 6-10) of an inch apart. With the Phonograph fully wound and running at full speed, and with reproducer arm down as for reproducing, the reproducer arm should travel from one mark to the other in exactly one minute, which indicates that the cylinder makes 160 revolutions in one minute. These marks may easily be made on any Phonograph, but care must be exercised to make them exactly the right distance apart. Even a slight variation will affect this speed.

TREATED WELL IT WILL PAY WELL.

The necessity of Jobbers and large Dealers having sound-proof rooms in which Records can be tested is becoming more and more obvious. In order to pay well, the Phonograph business requires just as careful treatment as other special lines of trade, and when it receives it, it will show just as gratifying returns. The business cannot be treated indifferently and stowed away in some obscure portion of an establishment if expected to pay well. It is more than could be expected of any other line. The sale of Phonographs requires just as correct treatment as other trade specialties. It is pretty sure to respond to progressive environment and return Dealers excellent results for any legitimate outlay.

THE PHONOGRAPH.

The children in the flat above,
 May race and romp and tear,
 Until the noise quite drives you mad,
 And long and loud you swear;
 These are the many causes,
 That lead mankind to sin,
 And the only peace you ever get is
 When the Phonograph starts in.

The maiden just across the hall,
 Thumps the piano strong;
 A budding arists blows upon
 The cornet loud and long—
 Yet, though both may be thus engaged,
 This most infernal din
 Is charmed by heavenly music
 When the Phonograph starts in.

They wake you in the morning
 Before the day grows bright;
 You'll find them there again to break
 Your slumbers late at night.
 Why hide beneath the coverlets—
 Your ears put cotton in?
 You can escape that awful sound
 When the Phonograph starts in.

There's "Violets" and "Would You Care,"
 "Tammany" and the rest;
 From rag-time up to sacred song—
 A million, I'll be blest!
 They send the baby off to sleep
 As the twilight's peeping in,
 And you're always glad you're living
 When the Phonograph starts in.

—From an advertisement of L. R. Portor, Brockton, Mass.

ADVERTISING DEALERS.

Two excellent mailing cards have been received from H. Schmidt & Son Co., Edison Dealers at Muscatine, Ia. Both are printed as folders, and they present the advantages of Edison Phonographs and Edison Gold Moulded Records as Christmas gifts in forcible style.

We desire to acknowledge receipt of advertising matter of various kinds from the following: Tomaz F. Deuther, Chicago; Neosho Cycle & Repair Works, Neosho, Mo.; Talking Machine Co., Pittsburg; Charles H. Turner, Buffalo, N. Y.; Hopkins Bros. Co., Des Moines, Ia.; C. E. Wyeth, Newark, Ohio; Alfred Caron, Brunswick, Me.; S. F. Alston Co., Brookwood, Ala.; John M. Smyth Co., Chicago, Ill.; Harry K. Lister, Plainfield, N. J.; Eastern Talking Machine Co., Boston; H. W. Mosier, Stockton, Cal.; Peter Duffy, Crescent City, Cal.; S. D. Wones, Hiawatha, Kas.; George E. Buss, West Philadelphia, Ohio; Saratoga Phonograph Co., Saratoga Springs, N. Y.; O. K. Houck Piano Co., St. Louis; Cosmopolitan Music Stock Co., Boston; M. L. Abbey Music House, Hudson, Mich.; J. N. Draper, Gouverneur, N. Y.; Hanover Cycle Co., Hanover, Pa.; Spratt & Corcoran, Watertown, N. Y.; Texas Phonograph Co., Houston, Tex.; Emil Taussig, Elizabeth, N. J.; O. C. Thompson, New Albany, Ind.; Nebraska Cycle Co., Omaha, Neb.; C. E. Osgood Co., Boston; L. R. Porter, Brockton, Mass.; Bard Bros., Wheeling, W. Va.; Denver Dry Goods Co., Denver, Col.; Eastern Talking Machine Co., Boston; Household Furniture Co., Providence, R. I.; Shepherd, Rose & Conover, Corning, N. Y.; J. F. Schmelzer Arms Co., Kansas City, Kas.; McGreal Bros., Milwaukee; Standard Machine & Music Co., Chattanooga, Tenn.; Conroy Piano Co., St. Louis, Mo.; C. W. Hall Co., Bellefonte, Pa.; Elmira Arms Co., Elmira, N. Y.; Spokane Phonograph Co., Spokane, Wash.; E. F. Shad, Jacksonville, Fla.; W. S. Branch, Orlando, Fla.

ADVERTISE LOCALLY.

On page 13 of this issue, we print a copy of our advertisement in the Christmas publications. This advertisement is appearing in magazines and other publications having an aggregate circulation of many millions of copies which reach half the homes of the country. In addition to this, we are running special advertisements in the Sunday issues of the principal papers in the principal cities throughout the United States and Canada, and these papers will reach many homes not covered by magazines. On the whole, we believe that our advertising will be seen and read by nine-tenths of the people of this country. All of this advertising is general in its character and calls upon the public to visit Dealers and have them play Edison Phonographs and Edison Gold Moulded Records. It does not, in any case, give the names of Jobbers or Dealers

The latter can reap the fullest advantage from this advertising by using the columns of their local papers to tell the public who they are, where they are and what they sell. Dealers who do this advertising will get much more benefit from our general campaign than those who make no effort to advertise.

PRINTED MATTER.

We are sending out this month a copy of the new edition of the Record Catalogue, Form No. 770. The first half of this Catalogue to go out will be bound with the present style cover and the second half with a new cover. In every other respect the Catalogue is the same, and those who later learn that the new cover is in use should not feel that their Catalogues differ in any way from the later ones, but continue to use them. We will make no effort to fill orders for the new covers where we feel that the trade is asking for them simply to have something that their competitors do not have. Having two different covers on one edition is something that we could not avoid and we shall expect the trade to use them just as if they all had the same cover.

With their orders for December Records, we are sending to all Jobbers in the United States a supply of folders and hangers printed especially for the holiday season. These are being sent in sufficient quantities to enable Jobbers to give Dealers as many folders as they receive Supplements each month and one of each hanger to each of their active Dealers. The editions of all three forms are exhausted with these shipments, and it will not be possible to fill any further orders for them. This treatment of the matter was necessary because the forms could not be gotten ready earlier.

THE PHONO TRADER'S OPINION.

The Edison Gem, Standard, Home, and Triumph Machines are so well known in every part of the civilized world that I can with confidence advise every agent, large or small, to stock these machines. They are absolutely perfect. They always give universal satisfaction. They make customers that you will never lose. It is a pleasure to handle them, for you can rely on the workmanship, exact timing, silent action, and beautiful finish. What more do you need, Mr. Dealer? The same remarks apply to their up-to-date Gold Moulded Records. Who ever heard of a customer being dissatisfied with their Records—it would be a *record*, certainly, to hear of such a thing.—*Phono Trader, London.*

COMMENTS ON EDISON GOLD MOULDED RECORDS FOR JANUARY, 1906.

The opening list for 1906 of Edison Gold Moulded Records is full of excellent selections, including hits from new comic operas and musical comedies, with the usual variety of instrumental music characteristic of these monthly lists. There is not a single Record in the entire twenty-four that does not represent the highest standard of the art of reproducing sound.

No. 9170, "The Choristers," by the Edison Concert Band, is a novel band Record. In one of the strains the melody is played by chimes with band accompaniment embellished by clarinets. In another strain the same melody is played by chimes with band accompaniment and orchestra bells obligato. Another attractive feature is the singing of birds, by Joe. Belmont. The selection is varied and very interesting from beginning to end. The composer of this selection is Bernard Phelps.

No. 9171, "Somebody's Sweetheart I Want to Be," is by Byron G Harlan, who is always fortunate in his selections. He is particularly so in this month's offering, "Somebody's Sweetheart I Want to Be," written and composed by Cobb & Edwards, has already well started on the road to popularity. Among the prominent performers singing it in vaudeville is Lillian Russell. The Record is made with orchestra accompaniment.

No. 9172, "Fritzy and Louisa," by Ada Jones and Len Spencer, is a vaudeville sketch introducing both singing and talking by Miss Jones and Mr. Spencer, also orchestra incidental music. It is a German dialect sketch, a line of work in which these artists have been more than successful. This sketch was written especially for our Record.

No. 9173, "A Lovely Night in June," is a bells solo by Albert Benzler, of a song and dance composition in schottische tempo, written by Jean Missud. A well rendered Record of a most attractive composition.

No. 9174, "I'm Getting Sleepy," by Arthur Collins, is something new in the line of coon songs, the words and music of which are by Joe Hollander, who also composed, "Gone, Gone, Gone," (our Record No. 8759). It is quite a bit of character work as rendered by Mr. Collins for our Record. Especially interesting is his comic talking interpolation. Mr. Collins has a style all his own in this line of work. Made with orchestra accompaniment.

No. 9175, "If a Girl Like You, Loved a Boy Like Me," by Harry MacDonough, is one of Lillian Russell's successes in vaudeville. Made with orchestra accompaniment. It has a catchy waltz melody and the story is something away from the usual run of songs of this character. Cobb & Edwards have written a number of songs that have taken the public fancy, and this, their latest, is thought by those who have heard it, to have all the essentials that made their former work so successful.

No. 9176, "Hebrew Vaudeville Specialty," is a Record by Julian Rose. It is some time since we have listed a Record made by Mr. Rose, whose comic Hebrew dialect specialty

is known all over the country. In this Record he gives a very humorous monologue, concluding with a parody on "In the Shade of the Old Apple Tree." His former Records were accompanied by the piano. This one is accompanied by orchestra, which enhances the realism of the vaudeville specialty greatly and makes of the Record, "A regular little theatre."

No. 9177, "Lights Out March," by Edison Military Band, is a characteristic military march, introducing "Lights Out." Played with all the precision and artistic work of our excellent band organization. Written by E. E. McCoy.

No. 9178, "Miss Mary," by Irving Gillette, is from Chauncey Olcott's new Irish play, "Edmund Burke." It is a song that appeals thoroughly to his audiences. Mr. Gillette makes much of this song and we think it surpasses some of his previous Records. It is a very pretty song and exquisitely sung and recorded, and will attract a lot of attention. This composition is by Chauncey Olcott and Theodore H. Northrup, and the Record is made with orchestra accompaniment.

No. 9179, "The Load That Father Carried," by Bob Roberts, is a comic song with an original and catchy melody, something after the order of "Everybody Works But Father," (our Record No. 9100). Both are sung by Mr. Roberts and accompanied by orchestra. We print the words of the chorus, supplying the information that the referred to "load" is a load of "peaches."

"'Twas the load that father carried that made him bend so low,
Since the day that he was married he's been always on the go,
We'd watch him in the evening while struggling down the road,
Then all us kids would shout 'Hey Marm,
Here's Dad with his daily load.'"

No. 9180, "Pass Me Not, O Gentle Saviour," is another splendid selection by Anthony and Harrison. Our sacred songs by Anthony and Harrison are meeting with universal praise and considered to fill a long felt want. Both Mr. Anthony and Mr. Harrison are well-known church singers, occupying solo positions in prominent New York City churches. Consequently they bring to this class of work an experience which, together with their cultured voices, contribute largely to the success of these Records. The beautiful orchestration is also a feature.

No. 9181, "Forget-Me-Nots," by the Edison Symphony Orchestra, is a beautiful and dainty orchestra selection equal to any we have ever listed. Our Symphony Orchestra Records are one of the features of our monthly supplements. The music is always of a high grade, requiring the best artists to interpret it and the most perfect methods of recording.

No. 9182, "I'm a Woman of Importance," by Ada Jones, is a comic song hit from "Fritz in Tammany Hall," which gives Miss Jones an opportunity to display her versatility with different dialects. Audiences at the Herald Square Theatre, New York City, nightly applauded this popular number. The Phonograph public will be just as much entertained with our Record of it.

No. 9183, "La-Tydley-Tydley-Um," is a fun-song, by Edward M. Favor. The enormous

success of Mr. Favor's Record of "Fol-the-rol-lol" (our Record No. 9142), prompts us to list a similar selection, entitled "La-Tydney-Tydney-Um," which is made of topical verses and choruses and sung in Mr. Favor's clever style. This composition is by Worton David and Maurice Scott. The Record is made with orchestra accompaniment.

No. 9184, "Paddle Your Own Canoe," by Collins and Harlan, is one of Morse and Madden's latest characteristic coon songs, combining an original and catchy tune with a story of more than ordinary interest and fun making opportunities, which it is needless to say Collins and Harlan make the most of. The attractiveness of the Record is further added to by the comic coon talk and an excellent orchestra accompaniment.

No. 9185, "It Blew! Blew! Blew! Schottische," by the Edison Concert Band, is a Record in dancing tempo made in response to many requests for Dancing Records. It is recorded at the correct tempo as approved by William P. Rivers, of the Knapp Mansion Dancing Academy, Brooklyn, N. Y. The selection will be found to comprise both the catchy tunefulness and swingy rhythm so requisite for dancing.

No. 9186, "Robin Redbreast," by Marie Narelle, is one of the most popular numbers in "Happyland," performed by The Hopper Opera Company at the Lyric Theatre, New York City. As sung by Miss Narelle for our Record, it makes a dainty and beautiful number. An added charm is the bird imitations by Joe Belmont. It is a new and novel idea and will doubtless be very much appreciated. It is also accompanied by the orchestra.

No. 9187, "Good-Bye Dixie Dear," by MacDonough & Biehling, is one of the popular march songs of the season. As made for our Record by MacDonough and Biehling it is an exceptionally fine number. The orchestration is decidedly effective, especially the part that introduces "Dixie." The Record is bound to be liked very much.

No. 9188, "Yankee Boodle," by Billy Murray, is one of those topical songs always interesting to people who keep up to the times. "Yankee Boodle," sung in "Fritz in Tammany Hall" and made for our Record by Billy Murray, is one of the best of its kind and strictly up to the minute in topics introduced. The insurance question, just now of such universal interest, is one of the matters humorously treated.

No. 9189, "A Gay Gossoon," by Vess L. Ossman, is a composition well suited to the banjo and one which Mr. Ossman makes much of, as does also our orchestra director, who features his orchestra effectively throughout. The selection brings out unexpectedly every now and then bits of well-known Irish melodies, which are as often and surprisingly turned again into original airs by the composer. The number is characteristic of its title and is in march tempo.

No. 9190, "Take Me to Your Heart Again," by Edward Barrow, is a beautiful new sentimental ballad that will at once appeal to its hearers. Mr. Barrow renders it in that sympathetic manner which he so appropriately and

artistically employs. Sung with orchestra. The words of the refrain follow:

"When the sun at eve is sinking,
When the colors tint the West,
When the birds have flown to rest,
When the dew-drops kiss the clover,
Softer than the summer rain;
When the busy day is over,
Take me to your heart again."

No. 9191, "Barnyard Serenade," by Spencer and Holt, is a unique Record. Len Spencer gives a descriptive talk on the rural barnyard at sunrise, which is punctuated by Alf. Holt with imitations of the shanghai rooster, little chickens, bantam rooster, robin, mocking bird, peacock, turkey gobbler, cow, calf, dog and jackass. The imitations are exceptionally fine and the way the talk is worked in and around them is decidedly clever. The recording is very distinct and clear and tonal quality human and natural.

No. 9192, "The Jolly Blacksmiths," by Edison Male Quartette, is a good solid number. One of the striking features is where the well-known part of the "Anvil Chorus" from Verdi's "Il Trovatore" is introduced with anvil accompaniment. It will always be a steady seller—good staple goods.

No. 9193, "Fol-the Rol-Lol Medley," by Edison Military Band, is one of the best band medleys of popular songs we have listed in some time. Composed of the following five song successes: "Fol-the-Rol-Lol" (our Record No. 9142), "Sympathy" (our Record No. 9164), "Starlight" (our Record No. 9166), "Silver Threads Among the Gold" (our Record No. 9162), "Can't You See I'm Lonely" (our Record No. 9158).

THE PHONOGRAM.

Dealers desiring to get a supply of *Phonograms* to mail to their customers must order them of Jobbers four weeks in advance, and we cannot agree to fill Jobber's orders unless placed with us a similar period in advance. Following is a schedule of prices at which *Phonograms* may be obtained by the trade:

DELIVERED WITH GOODS.

Blank, per 1,000 copies	\$2.50
Smaller quantities pro rata.	
Imprinted, per 500 copies.....	1.50
Imprinted, 1,000 copies.....	2.75
No orders filled for less than 500 copies requiring imprint, and all imprinting orders must be for multiples of 500.	
Jobbers will be glad to supply Dealers on the above basis.	

BY MAIL.

Single copies, per year.....	\$.20
Five copies to one address, per year.....	.40
Twenty-five copies to one address, per year.....	1.80
Fifty copies to one address, per year.....	3.60

Unless they have open accounts on our books, Dealers ordering *Phonograms* sent by mail are requested to send cash or stamps with their orders. The amounts are too small to handle in any other way.

MR. SCOTT LAID UP.

The New England trade will regret to learn that J. W. Scott, our New England salesman, is laid up at his home, Newark, N. J., with a severe attack of facial erysipelas.

NO MORE DIVIDED ORDERS.

The letter printed below was recently sent to all Jobbers. It explains itself fully. Its issuance was made necessary by the abuse of the privilege of splitting up orders for new Records so as to save Jobbers the trouble of repacking for shipment to Dealers.

TO ALL JOBBERS.

New York, Nov. 15, 1905.

It has recently become the custom of some Jobbers to split up their advance stock order for new Records into several different orders; one to be marked for them in the regular manner, the balance to be marked with special markings, which we presume is a means of identification for them to determine the Dealers to whom they are to be shipped. This custom we cannot allow or carry out, as in the first place it makes a great deal of additional work and some considerable extra expense to pack and mark the orders in this manner. In the second place, it gives the Jobbers, to whom we split up shipments in this manner, unfair advantage over those who receive one shipment only, as not having to unpack and repack, they can make deliveries to their Dealer quicker. In the third place, we cannot for one moment attempt to split up orders and mark them differently, as should such a policy become general, we would soon be called upon to pack all Jobbers Record orders in separate shipments, containing special marking, so they would not be put to the trouble or expense of repacking before making shipment to their Dealers.

With this explanation in the matter, we must absolutely refuse hereafter to pack any orders whatever in separate lots, or containing special markings, and would, therefore, request that hereafter your advance order for new Records be sent us complete in one order, to be shipped by freight, or should you desire part of them by express, in two orders, one to be shipped by freight and one by express.

C. H. WILSON, Manager of Sales.

WILL THE WONDERS EVER CEASE?

[Written by C. Harold Porter, of Brockton, Mass., upon hearing that Byron G. Harlan was a father, and that his only regret was that his daughter was not born in New York.]

No wonder that the clocks have stopped;
No wonder trains are late;
For something most surprising
I'm now about to state.

It happened in New Jersey
Not very long ago;
And the news I'm 'bout to tell you
I'm sure you ought to know.

You all have heard of Harlan,
The tenor, heaped with fame.
It was not very long ago
A fair maid took his name.

You've heard him sing without a doubt
Upon the Phonograph;
And you, no doubt, as well as I,
Enjoy his pleasing laugh.

You've heard him sing with Stanley;
And Collins, many times.
As often in the slot machines
You've spent your hard earned dimes.

Sometimes his songs are jolly,
Sometimes they're very sad.
Some of them cause the tears to flow,
Some of them make you sad.

He imitates the Dutchman,
The Reuben and the Yank.
When he imitated mother's voice,
My heart within me sank.

No longer need he change his voice
To childish tones, 'tis said;
For now he's got a little tot
Who'll take this part instead.

They say he's happy as a lamb;
We know this by his talk.
His only wish is that the babe
Had been born in New York.

THE ART OF ATTRACTING CUSTOM.

The imperative duty of attracting customers, calls for certain activities within the store and without. In the first place, the store itself should be inviting. Its exterior, no less than its interior, should appeal pleasantly to the public and convey to the observer a favorable idea of the proprietor and his wares. A clean, unobstructed pavement, a tasteful, prosperous-looking store front, a handsome modern sign, an attractive entrance—all these are important factors in giving to the store an individuality that appeals favorably to the public. In this category, too, is the show-window, which should be a crystallized edition-de-luxe of the store itself, reflecting, in a striking way, not only the beauty and merit of the stock, but the enterprise and good taste of the proprietor. Brilliant lighting and effective arrangement in the window will speak volumes for the goods and service within. And care must be taken, especially at this season, that the interior of the store is worthy of the exterior presentment—that the floors, walls, fixtures, decorations and goods are harmoniously bright and bewitching. Christmas-tide is a time of joy and good cheer, of giving and receiving, of happiness and pleasantries, and the spirit of the season should be reflected not only in the store and decorations, but also in the unobtrusive politeness and graciousness of manner of the proprietor and clerk.—*Exchange.*

AMERICAN PHONOGRAPH CO. AT BURLINGTON, VT.

The American Phonograph Co., of Gloversville, N. Y., Jobbers of Edison Phonographs, which recently opened a branch store at 34 Church Street Burlington, Vt., to meet demands of increasing trade in the state of Vermont and Northern New York, report an excellent business since the opening on October 2d. They occupy two floors and basement, and carry a large stock of Edison Phonographs, Records and supplies, which enables them to supply the trade more conveniently and promptly than in the past. They have received many praises from Dealers in that section, for prompt shipments, always carrying a large stock and filling orders the same day received, which enables the Dealer to replenish his stock on short notice, and to supply his customers with the new Edison Records the day they are received from the factory. This concern are firm believers in judicious advertising and are conducting an extensive campaign, in the newspapers, backed by an efficient follow up system, which not only helps the American Phonograph Co., but all the Dealers handling Edison Phonographs.

GRAVES & CO., PORTLAND, ORE.

Two carloads of Edison Records and Phonographs have arrived in Portland from the Edison laboratories in Orange, N. J. This is said to be the largest shipment of Phonographs ever sent out to the Pacific coast. It is destined to complete the stock of Graves & Company, who have been made Jobbers for Edison goods in the Northwest.

As one would naturally expect the already large retail store at 328 Washington street would have to be expanded considerably to accommodate in proper classified arrangement a stock of 50,000 Records and several thousand Phonographs, in addition to the big stock of stringed and band instruments, and the complete stock of supplies kept for the trade, saying nothing of the immense stock of sheet music which occupies one entire wall of this big retail and wholesale establishment. When this demand for more room confronted F. W. Graves, the head and founder of the house, a man who has grappled with and solved successfully many knotty financial problems, he proposed to his associates that a lease be taken on the Arcade Theater building, standing at the rear of the store. Naturally enough this looked like extravagant expansion to many. The wisdom of the step taken is now apparent. Where theatrical stars delighted thousands of people, Phonographs now perform a similar mission. The space occupied by the auditorium and stage of the old theater has been divided into four Phonograph parlors, each having individual finish and different furnishings. One of the front parlors, occupied by Edison machines, is finished in blue and gold, with a canopy ceiling studded with electric lights.

The old galleries of the theatre are fitted up with cabinets which skirt every nook and corner of the walls, holding, it is estimated, 25,000 Records. In all the departments of this big establishment over 10,000 square feet of floor space are utilized. Taken as a whole, the Phonograph parlors of Graves & Co., are acknowledged to be the finest by far in the United States.

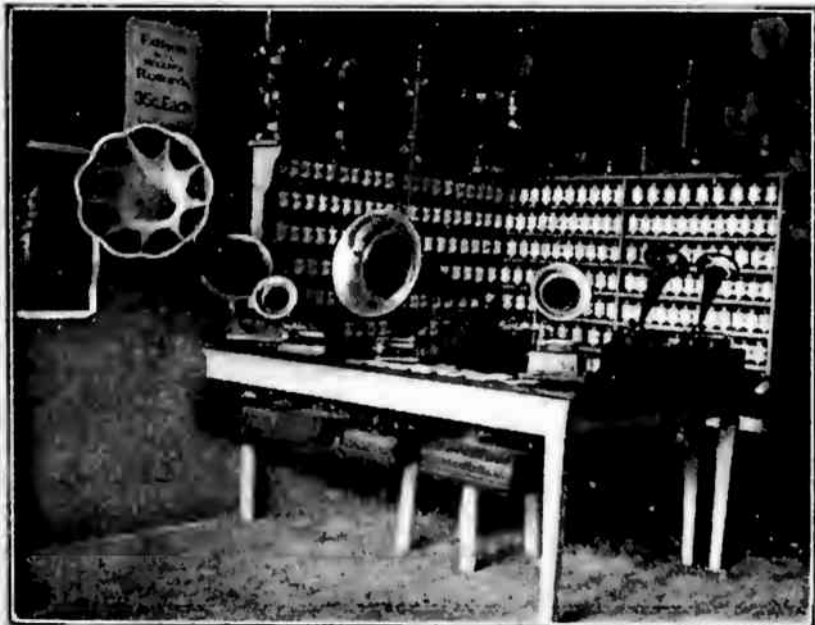

PHONOGRAPH NOOK OF W. A. PRESTON, THE
"HANDY MAN," GRINNELL, IA.

These Phonograph parlors are crowded all day long with customers, and the interest manifested in the marvel of the times.—*Portland Telegram.*

A NOVEL ADVERTISING PLAN.

A daily paper in Houston, Texas, recently inaugurated a novel guessing contest, in which well-known business houses were described, but the actual names withheld. The following is the paragraph referring to the Texas Phonograph Co., Edison Jobbers in that city:

There are several varieties of talking machines. One style claims their 1905 model is the only one that will make perfectly harmonious music. Makes no scratching sound, runs without noise, and so simple any child can operate it. Instead of constantly changing needles, as required on "disc" machines, it has a sapphire point that lasts for years without a change. On this machine your voice or singing is easily recorded at your own home. Machines sell for \$10 up and the Records at 35 cents each for any title of music desired, and may be run hundreds of times without wear.

The store that handles these Records at wholesale and retail is on the same street as the Houston Water Co. and the Burnett Hotel. What is the firm's name? Two names appear on the windows, so don't get the wrong one.

ADVANCE THE WATCHWORD.

"I have just opened up our last shipment of Records," writes a Dealer at Wellington, N. Z., "and I must say that the improvement shown therein by your Recording Department is very marked. In fact, you have reached a high level, and it will be difficult to say how you can improve, but I know 'advance' is your watchword, so I know that quality will improve as we go along. I think that Record No. 9029, 'Summer Night's Dream Overture,' is superb, and shows a wonderful piece of recording."

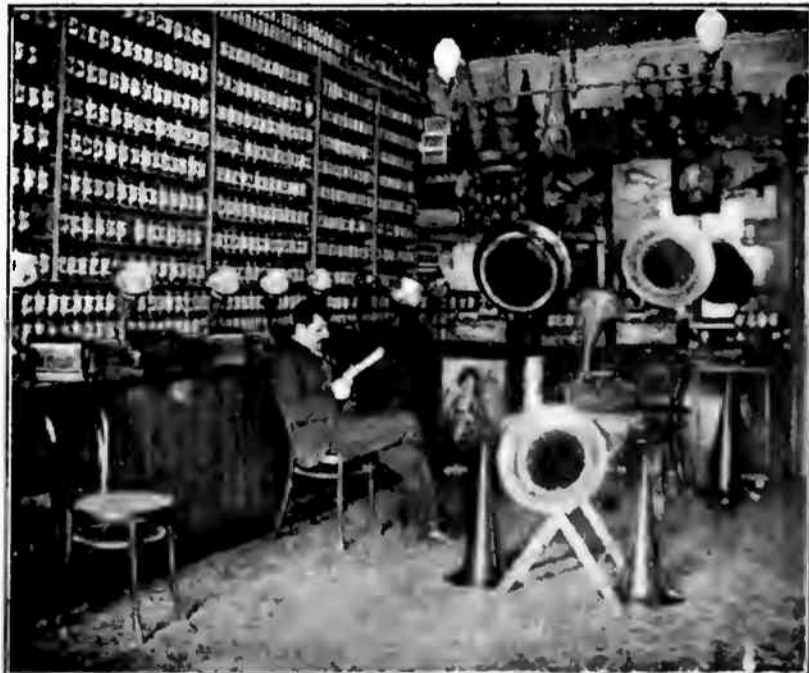

PHONOGRAPH PARLOR OF C. BOUZAI & CO.,
AUCKLAND, NEW ZEALAND.

A HINT TO SALESMEN.

In former issues we have urged the necessity of salesmen becoming acquainted with the machines, and too great a knowledge cannot be gained of this great question. An intimate knowledge of any business is necessary to achieve success, for better results can be obtained. We have discovered that dull seasons do not exist for the man who understands his business. He places a stronger emphasis upon business during periods which are more than ordinarily dull than at other times, and as a result he secures advantages which are far beyond those men who sit by and say that the season is dull and there is no necessity for any special exertion. When a man says that business is dull it usually means that he has not a correct knowledge of his local environments. Some seasons may be better than others, but there should not be dull times in any well-regulated enterprise.—*Talking Machine World*.

MUSIC HATH CHARMS.

I wish to inform you of a rather peculiar coincidence that occurred to me a short time ago. I was alone one day, playing one of your machines, and after playing several selections I noticed three mice almost in a row, making their way toward the Phonograph. I was rather surprised at their appearance, as the place is quite free from mice as a rule. I watched them closely, not disturbing them until the Record was finished. They appeared to enjoy the music very much, as they came very close to the machine and then stopped looking at it. I was playing a band piece in which the piccolo parts were quite prominent, and I think it must have been the tone of the piccolo that drew them.

WM. F. HUNT,
Wanatah, Ind.

"FOLLOW-UP" LETTERS.

FROM A. G. ARCARO, WILMERDING, PA.

Your recent favor addressed to National Phonograph Co., Orange, N. J., has been referred to me for attention, and in reply would say I can furnish you with anything made by the company, at the lowest possible price (regular) and would be pleased to meet you at my store at any time and play any of the Gold Moulded Records in our stock (which includes about 1,200 of the latest and best selling Edisons). Any Records that you may wish and not in our stock I can order for you and can assure you that I can get them at the earliest possible date, as I deal with the four leading Phonograph houses that handle the Edison line in the State of Pennsylvania. Therefore, I stand a better chance than if I was only dealing with the factory, for if I get your order for Edison goods (out of stock) at 4 o'clock P. M. I go to my telephone and call up the supply houses, and if any of the four have what you wish, I will have it at Wilmerding at 7 P. M. that same day. This is about two weeks sooner than I could get a factory shipment, and at the same price. Hoping to be favored with a call or order, I remain,

FROM H. S. SHORT, BROOKLYN, N. Y.

The National Phonograph Co. writes me you have made inquiries about Records. I beg to put myself at your services, and inform you that I have in stock every Record, without exception, made by the Edison people. If you can find it convenient to call at my store any time between 8 A. M. and 9.30 P. M. I shall be pleased to play all Records you desire to hear.

IMPOSSIBLE TO OVERSTOCK.

"At the time I placed my advance order for machines, I thought I was ordering enough to take care of increasing business, but it seems that no one can calculate with any certainty on the sale of Edison goods, except that it is impossible to overstock."—*Extract from letter from A. F. Ferriss, Edison Jobber at Utica, N. Y.*

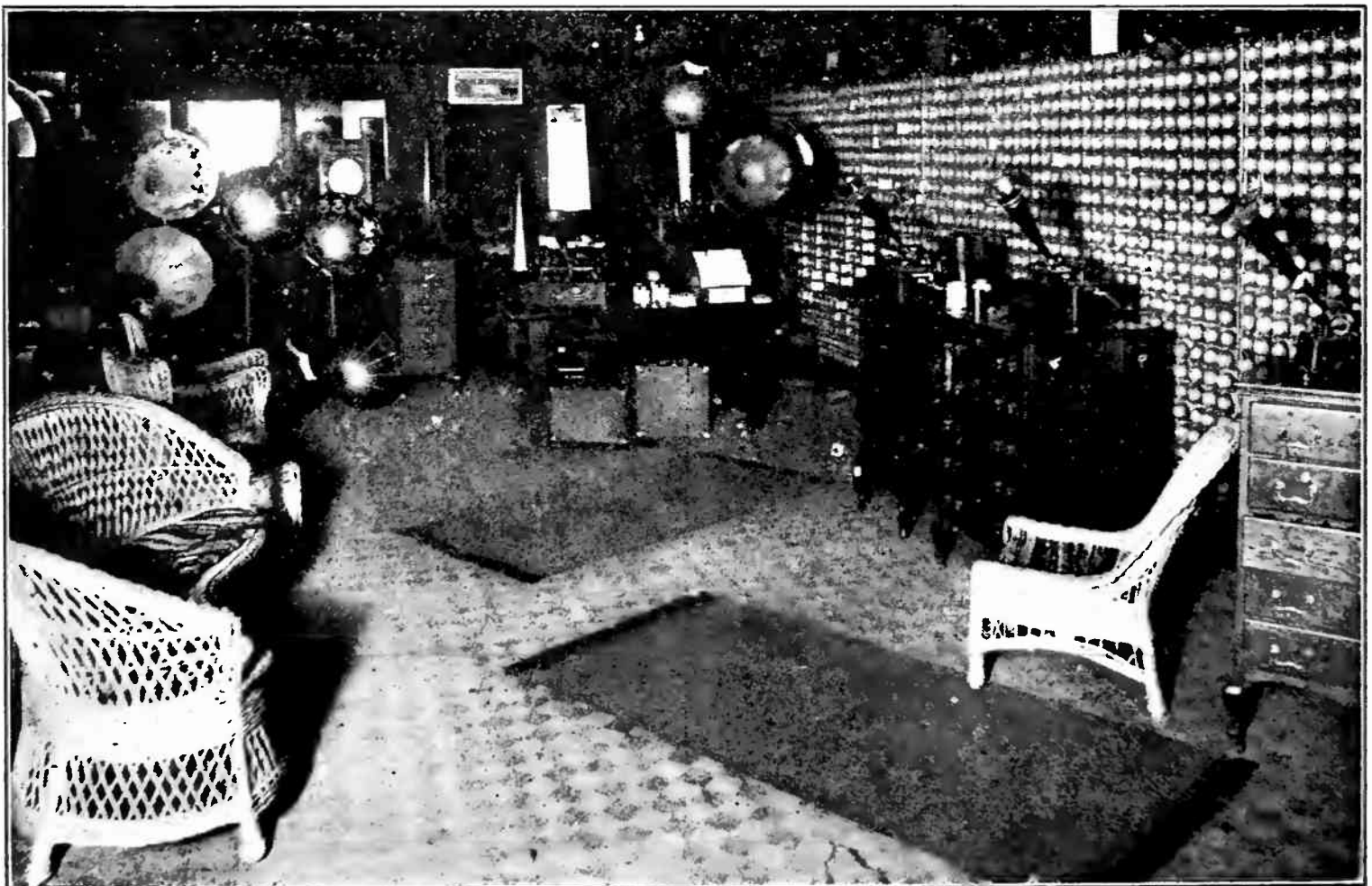

PHONOGRAPH DEN OF THE PARDEE-ELLENBERGER CO., NEW HAVEN, CONN.



AN IMPROVED EDISON PHONOGRAPH

Brings Christmas Cheer All the Year

No other gift yields such lasting pleasure as an Edison Phonograph. Everybody likes it—from baby to grandmother. No skill is required to reproduce perfectly brilliant band music; the finest vocal solos, duets, and quartettes; the funniest character songs and vaudeville skits. It replaces the opera and theatre for grown folks, and is unequalled for entertaining children. Edison Gold Moulded Records include thousands of popular, classic, sacred, operatic, or comic selections, and 24 are added every month. Thus the Phonograph provides more fun and music than any other automatic entertainer—yet is within the reach of all. Hear it at the nearest dealer's before deciding on any Christmas present. *"It speaks for itself."*

Latest Edison Gold Moulded Records—Now on Sale At All Dealers

- 9122 Hungarian Fantasia...Edison Concert Band
- 9123 Mother o' Mine—Song.....Theo. Van Yorx
- 9124 On the Rhine With a Stein..Collins & Harlan
- 9125 Friendly Rivals—Cornets..Clarke and Hazel
- 9126 Honeymoon Hall—Song...Harry MacDonough
- 9127 In Timbuctoo—A Monkey ditty..Billy Murray
- 9128 Jesus, Saviour, Pilot Me..Anthony & Harrison
- 9129 Bold Front March....Edison Military Band
- 9130 Wait 'Till the Sun Shines, Nellie....Harlan
- 9131 And the World Goes On—Song..Bob Roberts
- 9132 Betty—Duet.....MacDonough and Biehling
- 9133 Roses and Thorns.....Edison Orchestra
- 9134 We'll be Together When the Clouds
Roll By—Descriptive Song...Irving Gillette

- 9135 I'm the Only Star that Twinkles on
Broadway—Comic Song.....Ada Jones
- 9136 Pretty Mary—Duet.....Harlan and Stanley
- 9137 Dancing in the Starlight.....Edison Band
- 9138 Sweetest Flower that Blows...Marie Narelle
- 9139 Have You Seen My Henry Brown?...Collins
- 9140 Irish Girl I Love—Tenor....Edward Barrow
- 9141 Sweet Little Daisies—Bells Solo....Benzler
- 9142 Fol-the-rol-lol—Comic Song, Edward M. Favor
- 9143 Courtship of Barney and Eileen—
Comic Sketch...Ada Jones and Len Spencer
- 9144 When the Evening Breeze is Sighing
Home, Sweet Home.....Male Quartette
- 9145 Everybody Works but Father.....
MedleyEdison Military Band

**An Edison Phonograph Makes
the Best Christmas or Birth-
day Present for Anyone**

Every genuine Edison Phonograph bears the inventor's trade mark signature. Do not be misled or prejudiced by the distressing noises of inferior imitations. Go to the nearest Edison dealer and hear the genuine Phonograph, and you will instantly appreciate its marked superiority. Edison's signature is also on every Edison Gold Moulded Record. Edison Phonographs cost from \$10 up; Records, 35c. each.

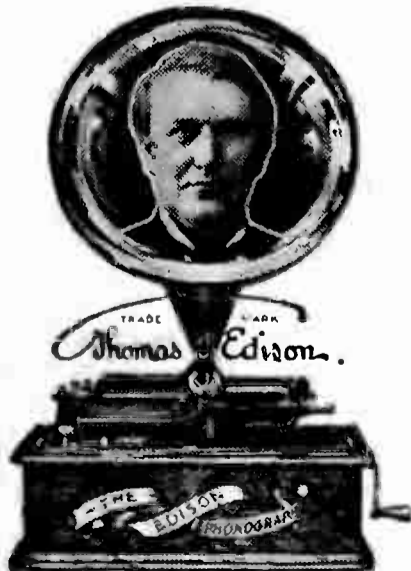

Send for new booklet, "Home Entertainments With the Edison Phonograph," obtainable only from Orange, N. J., office. Our Latest Record Catalogue will be sent to any Phonograph owner who gives the number of his Phonograph. Write now to

**National Phonograph
Company**

56 Lakeside Ave., Orange, N. J.
New York, Chicago, San Francisco
London

*I. C. S. Language Courses Taught
With Edison Phonographs.*

JOBBER'S OF EDISON PHONOGRAPHS AND RECORDS.

ALABAMA.

Birmingham—Talking Machine Co., 2007 Second ave.
Mobile—W. H. Reynolds, 167 Dauphin street.
Montgomery—R. L. Penick, 119 Dexter ave.

CALIFORNIA.

San Francisco—Peter Bacigalupi, 786-788 Mission street.

COLORADO.

Denver—Denver Dry Goods Co., 619 16th street.
 Hext Music Co., 15th and California streets

CONNECTICUT.

Middletown—Caulkins & Post Co., 406-408 Main street.
New Haven—Pardee-Ellenberger Co., 155 Orange st.

DISTRICT OF COLUMBIA.

Washington—E. F. Droop & Sons Co., 925 Pennsylvania avenue, N. W.
 S. Kann Sons & Co., 8th and Pennsylvania avenues.

GEORGIA.

Atlanta—Atlanta Phonograph Co., 49 Peachtree St.
Waycross—George R. Youmans.

ILLINOIS.

Chicago—Babson Bros., 148 Michigan Ave.
 Lyon & Healy, Wabash Ave. & Adams St.
 James I. Lyons, 192 Van Buren street.
 Talking Machine Co., 107 Madison street.
 The Vim Co., 68 E. Lake street.
 Montgomery Ward & Co., 111 Michigan ave.
 Rudolph Wurlitzer Co., 302 Wabash ave.

Peoria—Peoria Phonograph Co., 416 S. Adams street.
Quincy—Quincy Phonograph Co., 808 Hampshire st.

INDIANA.

Indianapolis—Indiana Phono. Co., 45 Virginia Avenue.
 Kipp Bros. Co., 37 S. Meridian street.
 A. B. Wahl & Co., 119 S. Illinois street.

Lafayette—A. B. Wahl & Co., 304 Main street.

IOWA.

Des Moines—Hopkins Bros. Co., 620 Locust street.
 Vim Co., 704 West Walnut street.
Fort Dodge—Early Music House, 822 Central ave.

KENTUCKY.

Louisville—C. A. Ray, 640 Fourth street.

LOUISIANA.

New Orleans—William Bailey, 600 Frenchman street.
 National Automatic Fire Alarm Co.,
 614 Gravier street.

MAINE.

Bangor—S. L. Crosby Co., 186 Exchange street.
Portland—W. H. Ross & Son, 207 Commercial street.

MARYLAND.

Baltimore—E. F. Droop & Sons Co., 109 N. Charles St.

MASSACHUSETTS.

Boston—Boston Cycle & Sundry Co., 48 Hanover street.
 Eastern Talking Mach. Co., 177 Tremont st.
 Iver Johnson Sptg. Goods Co., 163 Washingt-
 ton street.

C. E. Osgood Co., 744 Washington street.
 Read & Read, 630 Washington street.

Fitchburg—Iver Johnson Sptg. Goods Co., 247 Main st.
Lowell—Thomas Wardell, 111 Central street.

New Bedford—Household Furnishing Co., 170 Pur-
 chase street.

Springfield—Flint & Brickett Co., 439 Main st.

Worcester—Iver Johnson Sptg. Goods Co., 304 Main st.

MICHIGAN.

Detroit—American Phono. Co., 106 Woodward ave.
 Grinnell Bros. 219 Woodward ave.

MINNESOTA.

Minneapolis—Thomas C. Hough, 714 Hennepin ave.
St. Paul—W. J. Dyer & Bro., 21-23 West 5th street.
 Thomas C. Hough, 392 Wabasha street.
 Minnesota Phonograph Co., 37 E. 7th street.

MISSOURI.

Kansas City—J. W. Jenkins' Sons Music Co., 1013-1015
 Walnut street.

J. F. Schmelzer & Sons Arms Co., 710
 Main street.

St. Louis—Conroy Piano Co., 11th and Olive streets.

O. K. Houck Piano Co., 1118 Olive street.
 Western Talking Machine Co., 923 Olive st.

MONTANA.

***Helena**—Frank Buser.

NEBRASKA.

Lincoln—H. E. Sidles Cycle Co., 1317 O street.

Omaha—Nebraska Cycle Co., 15th and Harney streets.
 Omaha Bicycle Co., 16th & Chicago sts.

NEW JERSEY.

Hoboken—Eclipse Phono. Co., 205 Washington st.

Newark—A. O. Petit, New and Halsey streets.

Paterson—James K. O'Dea, 117 Ellison street.

Trenton—Stoll Blank Book and Stationery Co., 30 E.
 State street.

John Sykes, 105 N. Broad street.

NEW YORK.

Albany—Finch & Hahn, 92 State street.

Brooklyn—A. D. Matthews' Sons, 394 Fulton street.
 Price Phonograph Co., 1260 Broadway.

Buffalo—P. A. Powers, 613 Main street.

Elmira—Elmira Arms Co., 117 Main street.

Gloversville—American Phono. Co., 99 W. Fulton st.

Kingston—Forsyth & Davis, 307 Wall street.

New York City—Bettini Phono. Co., 156 W. 23d street.

Blackman Talking Machine Co., 97
 Chambers street.

J. F. Blackman & Son, 2737 3d avenue.

Sol Bloom, 214 W. 42d St

I. Davega, Jr., 802 Third avenue.

S. B. Davega, 32 E. 14th street.

Douglas Phono. Co., 89 Chambers st.

H. S. Gordon, 1241 Broadway.

Harry Jackson, 219 Bowery.

Jacot Music Box Co., 39 Union Square.

Victor H. Rapke, 1661 Second avenue.

Siegel-Cooper Co.

John Wanamaker.

Alfred Weiss, 1525 First avenue.

Oswego—Frank E. Bolway, 32 Bridge street.

Poughkeepsie—Price Phonograph Co., 203 Main st.

Rochester—A. J. Deninger, 345 North street.

Mackie Piano, O. & M. Co., 100 State street.

Giles B. Miller, 63 State street.

Talking Machine Co., 97 Main st., E.

Schenectady—Finch & Hahn, 504 State street.

Jay A. Rickard & Co., 253 State street.

Syracuse—W. D. Andrews, 216 E. Railroad street.

Troy—Finch & Hahn, 3 Third street.

Utica—Clark-Horrocks Co., 54 Genesee street.

Arthur F. Ferriss, 89 Washington street.

William Harrison, 41 Columbia street.

Utica Cycle Co., 31 Columbia street.

OHIO.

Canton—Klein & Heffelman Co., 216 N. Market street.

Cincinnati—Ilsen & Co., 25 W. 6th street.

Rudolph Wurlitzer Co., 10-12 W. 4th st.

Cleveland—Eclipse Musical Co., 162 Prospect st.

Columbus—Perry B. Whitsit Co., 213 S. High street.

Dayton—Niehaus & Dohse, 35 E. 5th street.

Newark—Ball-Fintze Co.

Toledo—Hayes Music Co., 608 Cherry street.

OREGON.

Portland—Graves & Co., Inc., 328 Washington St.

PENNSYLVANIA.

Allegheny—Henry Braun, 500 Federal street.

Allentown—G. C. Aschbach, 539 Hamilton street.

Easton—William Werner, 401 Northampton street.

Harrisburg—S. K. Hamburger, 12-14 N. Market sq.

New Castle—W. C. DeForest & Son.

Philadelphia—C. J. Heppe & Son, 1117 Chestnut street.

Lit Bros., Market and 8th streets.

Penn Phonograph Co., 17 S. 9th street.

John Wanamaker, 13th and Market sts.

Wells Phonograph Co., 45 N. 9th street.

Western Talking Mach. Co., 25 S. 9th st.

H. A. Weymann & Son, 923 Market st.

Pittsburg—Theo. F. Bentel Co., Inc., 632 Liberty street.

Kaufmann Bros., Fifth avenue.

H. Kleber & Bro., 221 Fifth avenue.

C. C. Mellor Co., 319 Fifth avenue.

Pittsburg Phono. Co., 937 Liberty street.

Talking Machine Co., 619 Penn ave.

Reading—Reading Phonograph Co., 809 Penn street.

Scranton—Ackerman & Co., 130 Wyoming avenue.

Technical Supply Co.

Williamsport—W. A. Myers, 145 W 3d st.

RHODE ISLAND.

Pawtucket—Pawtucket Furniture Co., 39 N. Main St.

Providence—J. M. Dean Co., 785-795 Westminster street.

J. A. Foster Co., Weybosset st.

Household Furniture Co.

J. Samuels & Bro., 154 Weybossett street.

A. T. Scattergood & Co., 106 N. Main st.

TENNESSEE.

Knoxville—Knoxville Typewriter and Phonograph

Co., 421 Gay street.

Memphis—O. K. Houck Piano Co., 103 S. Main street.

F. M. Atwood, 160 N. Main St.

Nashville—Nashville Talking Mach. Co., 510 Church st.

Magruder & Co., 13 Arcade.

JOBBER OF EDISON PHONOGRAPHS AND RECORDS—Continued.

TEXAS.

Dallas—Southern Talking Machine Co., 347 Main st.
 El Paso—W. G. Walz Co., 101 El Paso street.
 Fort Worth—Cummings, Shepherd & Co., 700 Houston st.
 Houston—Texas Phono. Co., Capitol and Fannin Sts.
 San Antonio—H. C. Rees Optical Co., 242 West Commerce St.

VERMONT.

Burlington—American Phono. Co., 34 Church St.

VIRGINIA.

Richmond—Magruder & Co., 729 E. Main st.

WASHINGTON.

Seattle—D. S. Johnston Co., 903 Second Ave.
 Spokane—Spokane Phono Co., 7 Post St.

WISCONSIN.

Milwaukee—McGreal Bros., 173 3d street.

CANADA.

Toronto—R. S. Williams & Sons Co., Limited,
 143 Yonge street.
 Winnipeg—R. S. Williams & Sons Co., Ltd., 121 Princess street.

*Added since November 1, 1905.

SUSPENDED LIST, DECEMBER 1, 1905.

SUPERSEDING ALL PREVIOUS LISTS.

GEORGIA.

Valdosta—H. K. McLendon, 109 West Central Ave.

ILLINOIS.

Champaign—Eggleston Bros.
 Ottawa—Edward Hayne.
 Wheaton—E. Irving.

INDIANA.

South Bend—EUGENE MARSH, 126 Vistula avenue.
 SOUTH BEND BOOK BINDERY, Robert Lebolt, Prop., 203 North Michigan street.

IOWA.

Burlington—JOHN P. WEISS, 711 Jefferson street.
 Sioux City—HATTENBACH BROS. CO.
 A. V. LARIMORE, 518 Fifth street.

KANSAS.

Clay Centre—E. M. GOWENLOCK.
 Lawrence—BELL BROS.
 Topeka—R. H. MOREHOUSE, 510 E. 4th street.

MAINE.

Biddeford—W. H. FIELD.
 Lewiston—J. W. SKENE.
 Monmouth—G. H. STETSON.

MASSACHUSETTS.

Boston—E. C. PECK, 43 Milk st.
 T. SINGER, 60 Leverett street.
 Franklin—E. P. Blackman.
 Lawrence—LORD & CO., 314 Essex street.
 E. O. MOSHER, 420 Essex street.
 Lynn—ELIAS DEYOUNG.
 Malden—A. T. FULLER.
 Nantucket—ARTHUR M. TAYLOR.
 New Bedford—H. B. DEWOLFF.
 Somerville—E. J. WINCHESTER, 32 Summit avenue.
 *Worcester—JOSEPH TUKMAN, 44 Front street.
 Woburn—OSBORN GILLETTE, or THE BOLTON JEWELRY CO., L. F. Maloney, Manager.

MICHIGAN.

Detroit—F. J. SCHWANKOVSKY.
 Saginaw—GEO. W. EMENDORFER.
 JAMES V. CALAHAN, 217 Genessee st.
 TIERNEY BROS., 217 Genessee st.

MISSOURI.

Kansas City—THE WITTMANN CO.

NEBRASKA.

Lincoln—THE WITTMANN CO.
 Omaha—THE WITTMANN CO.

NEW HAMPSHIRE.

Hillsboro Bridge—E. M. BARNES.
 Manchester—A. E. DUMAS
 Nashua—F. A. MCMASTER & CO.

NEW JERSEY.

Atlantic City—SAM'L D. WOLF, 32-34 Arkansas ave.
 Bayonne—I. WIGDOR, 450 Avenue D.
 Jersey City—W. L. HOFFMAN, 151 Montgomery st.
 Newark—R. L. CORWIN; also New York City.
 Passaic—I. HURWITZ.
 Paterson—CHAS. H. KELLY, 25 N. Main street.
 Plainfield—S. W. FRUCHT, or R. FRUCHT; also New York City.

ELSTON M. LEONARD.

West Hoboken—EMIL HOLLANDER, or THE WEST HOBOKEN BICYCLE & PHONO. CO., 619 Spring street.

NEW YORK.

Albany—G. LINDE, 353 S. Pearl street.
 *Auburn—CHAS. C. CHIER CO., 18 Clark street.
 Bedford Park—GEO. H. TYRRELL.
 Brooklyn—WM. ALBRECHT, 294 Knickerbocker ave.
 H. HINDERMAN, BUSHWICK PHONO-GRAPH EXCHANGE, 1421 Myrtle avenue.
 Hobart—F. H. MARSHALL.
 *Hohawk—ALBANY SPECIALTY CO., or CHAS. F. RICE, Main street.
 *Moravia—C. D. LOOMIS & CO., Union Block.
 New York City—A. T. ARMSTRONG, or AMERICAN PHONO. CO., 106 Wall street.
 AUTOMATIC ZITHER CO., M. Cohen, Prop., 58 Second avenue.
 BERN BEARWALD, 373 W. 11th st.
 *EDWARD BIELFELD, 481 Willis Ave.
 BRONX PHONO. CO. or DAVID SWITKY, 506 Willis ave.
 CENTRAL PHONO. CO., 160 E. 42d street.
 R. L. CORWIN; also Newark, N. J.
 EAGLE PHONO. CO., or C. LOWENTHAL, 83 Nassau street.
 EMPIRE PHONO. CO., 2 W. 14th street.
 S. W. FRUCHT, or R. FRUCHT, 7 Barclay st., or 68 Cortlandt st.; also Plainfield, N. J.
 O. HACKER, 2 Murray street.
 HAWTHORNE & SHEBLE, 297 Broadway; also Philadelphia, Pa.
 HOLOBER BROS., 350, 421 and 491 West st.
 N. HORN, 148 E. 58th street.
 W. L. ISAACS, 114 Fulton street.
 S. LEMBURG & CO., 194 Broadway.
 J. MCELLYNNE, 202 Broadway.
 RICHMOND PEASE, 44 W. 132d st.
 F. M. PRESCOTT, 44 Broad st.
 WINTHROP CYCLE CO., 2212 Seventh ave.
 Rome—CHARLES TUTTLE.
 Saratoga—W. J. TOTTEN.
 Saratoga Springs—MARVIN A. COTE.
 Watertown—HENRY A. HARDY, 24 Arsenal st.
 H. S. WARDWELL & CO., 39 Public Square.
 *Wolcott—J. A. MURPHY, 7 Main street.

NORTH CAROLINA.

Kingston—S. A. Quinerly.

OHIO.

Cincinnati—J. L. ANDEM.
 Coshocton—BURNS & GOSSER.
 Springfield—D. & M. VANDERPOOL.
 Uhrichsville—F. A. MAZURIE.

PENNSYLVANIA.

Philadelphia—A. R. CASSIDY, 2783 Emerald street.
 HAWTHORNE & SHEBLE, 604 Chestnut st., or Oxford and Mascher sts.; also New York City.
 A. KROUSE, 832 Arch street.
 PENN NOVELTY CO., 15 South 9th st.
 Phoenixville—KEINARD BROS.
 Pittsburg—A. LIPPARD, 615 Wylie ave.

RHODE ISLAND.

Providence—F. P. MOORE.

WISCONSIN.

Milwaukee—J. C. BLATZEK.

*Added Since November 1, 1905.

Jobbers and Dealers are asked not to supply any of the above named firms with our apparatus, either at addresses given or any other address.

Business Increased 200%

WHOLESALE. EXPORT, RETAIL

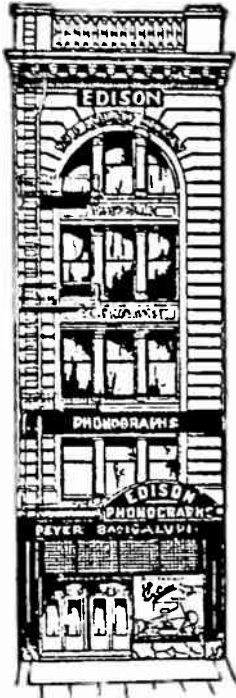

PENNY ARCADES:
 840 MARKET STREET
 805 KEARNY STREET
 605 K ST. SACRAMENTO

TELEPHONE:
 MAIN 5464

OFFICE AND SALESBROOM
 786-788 MISSION ST.

SAN FRANCISCO Oct. 6th, 1905.

PROJECTING MACHINES

FILMS International Cor. Schools,
 SLOT PIANOS
 PIANINOS Scranton, Pa.
 PIAN-ORCHESTRA
 MINIATURE RAILWAYS Gentlemen:-
 MERRY-GO-ROUNDS

ALL KINDS OF COIN-CONTROLLED MACHINES

Replying to yours of the 30th ult. will say that we find that our business in your product has increased at least 200% this year over last, with every indication of still increasing.

I thank you for your generosity in furnishing us with the literature which we will spread broadcast over our territory, and also thank you for your very kind and prompt attention to us generally.

The goods are first class and are a recommendation in themselves and every time we make a sale it leads to another one.

You can rest assured of our co-operation to the fullest extent.

Yours very truly,

Dict.P.B

Peter Bagigalupi
Increase your business

by selling "Double Service"—Edison Repeating Phonograph, language feature of the business are unanimous in rating it high as a money maker. It will cost YOU only 50 cents to try it out in your business. Send that much for a demonstrating outfit, pamphlets, advertising literature, etc. Can you afford to neglect opportunities for better business. Write today.

foreign languages taught by the I. C. S. system with as well as amusement. Dealers who have tried the

INTERNATIONAL CORRESPONDENCE SCHOOLS
 Box 920, SCRANTON, PA.

FOR FOREIGN SALES ADDRESS } Foreign Dept., National Phonograph Co., 31 Union Square, New York City.
 } European Headquarters, National Phonograph Co., Ltd., 25 Clerkenwell Road, London, E. C.

EDISON Phonograph Monthly

PUBLISHED FOR TRADE USE ONLY BY
THE NATIONAL PHONOGRAPH CO.

VOL. III. ORANGE, N. J., JANUARY, 1906. No. 11.

NATIONAL PHONOGRAPH CO.
ORANGE, N. J.

NEW YORK: 31 UNION SQUARE.

CHICAGO: 304 WABASH AVENUE.

340 KENT STREET, SYDNEY, N. S. W.

CALLE PROLONGACION DEL 5 DE MAYO, NO. 67-77,
MEXICO CITY.

NATIONAL PHONOGRAPH CO., LTD., 25 CLERKENWELL
ROAD, LONDON, ENG.

EDISON PHONOGRAPHS AND RECORDS.

All communications to THE PHONOGRAPH MONTHLY
should be addressed to the Advertising Department,
Orange, N. J.

C O N T E N T S

Looking Backward and Forward.....	1
Advance List of February Records.....	2
Don't Cancel	3
That Freight Allowance Again	3
Grand Opera Records	4
More About Inferior Parts	4
Too Costly	4
Announcement to Trade Concerning Grand Opera Records	5
Concerning Repair Parts	6
No Exchange Proposition for Customers..	6
Dealers' Resolves for 1906	6
A Premature Announcement	6
An Advertising Record for the Trade....	7
Among Jobbers	7
Numbers 12227 and 12273 to be Cut Out..	7
Comments on Edison Gold Moulded Rec- ords for February	8
For Lower Freight Rates	10
Edison Plan a Good Model	10
Publishers of January Music	10
Piano Trade and Phonographs	11
Printed Matter	11
National Phonograph Co.'s Export Busi- ness	11
Edison Phonograph a Court Witness.....	12
A Dealer's View on Instalment Sales....	12
Ball-Fintze Co.	13
Jobbers of Edison Phonographs and Records	14
Suspended List, January, 1906	15

LOOKING BACKWARD AND FORWARD.

At a time like this it is quite proper to cast retrospective and prospective glances at the trade situation as viewed from an Edison standpoint. The year 1905 was one of unexampled prosperity to the entire country and great strides were made in all industrial businesses. In few other industries have greater advances been made than in the manufacture of talking-machines. The growth of the business has been of a phenomenal character and quite beyond the expectations of even the most optimistic men connected with it. Regarded but a few years ago as a fad that would soon run its course, the Phonograph has, by its rapid evolutions, won widespread recognition as an article quite as staple as a piano and as likely to endure. Without desiring to be egotistical or boastful, we believe that the business of the National Phonograph Co. has in the past year grown in a greater ratio than that of any similar concern in the industry. We feel assured that the Edison Phonograph and the sound reproducing principles back of it have to a greater extent than ever been accepted by the world as those furnishing the most natural reproduction of the human voice or of any musical instrument, and therefore the most desirable instrument of its kind on the market. The business of the National Phonograph Co. steadily increased throughout the year. Each successive month brought a larger business than its predecessor, the summer months being no exception to this growth, the last four months bringing a demand for goods beyond our factory capacity.

Looking forward, all conditions seem favorable for a volume of business as much greater than that of 1905 as the latter was greater than the year before. Never before have the relations between the trade and ourselves been more cordial, and never before have Jobbers and Dealers been so enthusiastic over the possibilities of the Edison product. Recent im-

(Continued on page 3.)

NEW EDISON GOLD MOULDED RECORDS. ADVANCE LIST FOR FEBRUARY, 1906.

RECORDS listed below will be ready for shipment as near **February 1st** as possible, at which time Jobbers' stock orders, if **received prior to January 10th**, will be shipped. February Supplements will be forwarded to Jobbers with their stock orders for Records. Retail Dealers should place stock orders with their Jobbers at once, to insure prompt shipment as soon as Jobbers' stock is received.

- 9194 Caprice Militaire (*Rollinson*) Edison Concert Band
 9195 Henny Klein (*Jerome and Schwartz*) Ada Jones
Dutch waltz song from "The White Cat," Orch. accom.
- 9196 I'm a-Dreaming of You (*Mullen*) Coon love song, Orch. accom. Collins and Harlan
 9197 "Genevieve" Waltz Medley (*Original*) Eugene Rose
Ocarina solo, Orch. accom., introducing "On the Banks of the Rhine with a Stein," "I'll be Waiting in the Gloaming, Sweet Genevieve," and "Wait till the Sun Shines, Nellie."
- 9198 Will You Love Me in December as You Do in May? (*Ball*) Harry MacDonough
Sentimental song, Orch. accom.
- 9199 God Be With You till We Meet Again (*Tomer*) Anthony and Harrison
Sacred duet, Orch. accom.
- 9200 It's a Good World After All (*Bryan and Edwards*) Bob Roberts
Comic song, Orch. accom.
- 9201 Blue Jackets March (*Bennett*) Edison Military Band
 9202 Daddy's Little Girl (*Morse*) Descriptive song, Orch. accom. Byron G. Harlan
 9203 College Life March (*Frantzen*) Whistling solo, Orch. accom. Joe Belmont
 9204 Lazy Moon (*Cole and Johnson*) Billy Murray
Coon love song, Orch. accom., chorus by Edison Male Quartette
- 9205 Ghost of the Mayor Overture (*Grossmann*) Edison Symphony Orchestra
From the opera "Der Geist des Wojewoden"
- 9206 'Neath the Spreading Chestnut Tree (*Bloom*) Irving Gillette
Descriptive song, Orch. accom.
- 9207 Believe Me, If All Those Endearing Young Charms (*Moore-Stevenson*) Marie Narelle
Soprano song, Orch. accom.
- 9208 Pocahontas (*Bryan and Edwards*) Comic song, Orch. accom. Edward M. Favor
 9209 Titania, Air de Ballet (*Sired*) Edison Concert Band
 9210 Is Everybody Happy? (*Hogan-Lemonier*) Coon song, Orch. accom. Madge Maitland
 9211 Robinson Crusoe's Isle (*Burt*) Arthur Collins
Comic song, from Marie Cahill's "Moonshine," Orch. accom.
- 9212 My Mother's Old Red Shawl (*Moreland*) MacDonough and Biehling
Descriptive duet, Orch. accom.
- 9213 The Chaser March (*Ruby*) Xylophone solo, Orch. accom. Albert Benzler
 9214 Save Your Money, 'Cause de Winter Am Coming On (*Godfrey*) Clarice Vance
Coon song, Orch. accom.
- 9215 The Original Cohens (*Vaudeville*) Ada Jones and Len Spencer
Hebrew sketch, with orchestral incidental music, and introducing an adaptation of the old-time character song, "Solomon Levy"
- 9216 Song of the Steeple (*Rosenfeld*) Edison Male Quartette
Male quartette, unaccompanied
- 9217 Silver Heels (*Moret*) Edison Military Band
The 1905-06 annual instrumental number issued by the popularizers and the composer of "Hiawatha"

Edison Gold Moulded Records are made only in Standard Size. Both Standard and Concert Records may be ordered from this list. Order by number, not title. If Concert Records are wanted, give the number and letter C.

(Continued from page 1.)

provements have made the several types of Edison Phonographs the most perfect sound reproducing devices of the day, and the progress in the art of recording has produced Records of lifelike naturalness and clearness. The number of Jobbers and Dealers now handling Edison goods long ago reached a high watermark, and the weekly increase in the number is greater than ever. Several of the largest firms in the country in their respective lines will become Jobbers as soon as it becomes possible to give them the goods required by the initial order. Freight allowances to Jobbers to all points in the United States is going to have a salutary effect upon the growth of Edison business in the South and far West. The opening up of new branch offices at Sydney, Australia, and Mexico City, and the phenomenal growth of the business in all foreign countries all presage a year of continuous growth and progress.

So here's to the year 1906. May it bring greater prosperity to all engaged in marketing Edison goods and may its close bring us the same good will from the trade as we enjoy today.

DON'T CANCEL.

The holiday season is over, the year closing with a month that, for strenuousness from a manufacturing standpoint, has never seen its equal in the life of the Edison Phonograph. Every member of the Sales Department has spent his waking hours reading letters and telegrams and listening to personal appeals for goods that could scarcely be half appeased, and their sleeping hours have been haunted by visions of irate Jobbers, each of them declaring that he was not getting his share of the machines that were being made at the factory and begging for a "square deal." Such a situation has had no precedent. Its extent was not anticipated and its trying features could not, therefore, have been prevented. And now that we have passed through it, we feel safe in saying that a similar situation will not occur again. Not that we do not expect as great a demand for goods, for we have every reason to look for a much greater demand, but the demand will find us better prepared to take care of it. We hope that the trade will never again be compelled to sell machines of other makes because of an inability to get as many Edison Phonographs as they wanted. It is due the General Manager of Sales to say that no official of the company has worked harder in the past four months to apportion fairly and equitably among the Jobbers the output of machines. It has been his daily task to sit down with a tabulated

sheet showing the orders on file and designate how each day's output should be shipped. The fact that so many Jobbers have felt aggrieved shows that he did his work without favor but with an eye single to the welfare of Edison trade everywhere.

Now that the holiday rush is past it may be that some Jobbers will feel inclined to cancel all or a portion of their unfilled orders. Here is where they will err. The natural inclination is to think that there will be a falling off in the demand, but we have every reason to believe that the sales of Edison goods will show no marked decrease for several months. Every indication points that way, and the wise Jobber and Dealer will carry an adequate stock to meet it. The sale of Edison goods has ceased to be a matter of seasons. It is an all-year-round business with less variation in volume each month than many lines generally regarded as more staple. The sooner this fact is recognized the better it will be for all concerned.

THAT "FREIGHT ALLOWANCE" AGAIN.

A New York City Jobber wrote recently, asking that something further be said in the matter of freight allowance to Jobbers, claiming that many Dealers were still unable to understand the subject. If such Dealers will turn to the Agreements they sign they will find under the heading of "Delivery" on the first page three sentences reading as follows:

F. O. B. Orange, N. J., if ordered from factory.

F. O. B. Chicago, if ordered from Chicago.

F. O. B. city in which Jobber is located, if ordered from Jobber.

These phrases tell the entire story and should require no further explanation. They mean that if a Dealer orders goods direct from us, shipment is made from factory at the expense of the Dealer. The same is true if goods are ordered from the Chicago office. If goods are ordered from the Jobber they are shipped from the Jobber's city and transportation charges must be paid by the Dealer. If for any reason a Jobber has a shipment made direct from the factory to a Dealer, then the Dealer must pay the transportation charges the same as if shipment had been made from the Jobber's city. In other words, shipments made direct from factory cannot be used as a means of evading any part of the transportation charges that a Dealer would pay if shipment was made from the Jobber's city. The original paragraph which caused this misunderstanding had reference only to Jobbers and did not in any way affect the freight charges on shipments from Jobbers to Dealers.

GRAND OPERA RECORDS.

Below is printed a copy of a letter sent to the entire trade in the United States under date of December 15th. The announcement referred to and given on page 7, also contained biographical sketches of the eight artists who made the first ten of these Grand Opera Records. Five of these artists, Messrs. Scotti, Van Rooy, Dippel, Knotte and Resky, are now singing leading roles at the Metropolitan Opera House, New York. Messrs. Constantino and Berti are widely known abroad as operatic singers of high rank, but they have not yet been heard in this country. Signora Resky has a beautiful soprano voice, but her engagements to sing in high class concerts will not permit her to sing in Grand Opera at present. The letter given below and the announcement on page 7, give full details about the selections. These ten Records will be found the most natural reproductions of the human voice ever made.

LETTER TO THE TRADE.

We enclose herewith an announcement concerning the issuance of a series of Edison Records of Grand Opera music made by Grand Opera artists. The ten selections shown on this announcement comprise the first supplement of these Records. Other supplements will follow from time to time.

These Records will be shipped to Jobbers with their February Records. Dealers are asked to place early orders for them so that Jobbers may be able to make up their own orders more intelligently. For your convenience in making out your order, we are enclosing a special blank, which should be filled in and sent to your Jobber.

The list price of these Grand Opera Records has been fixed at seventy-five (75) cents each and they must be sold under all the conditions of the present agreement governing the sale of Edison goods. The full list price of seventy-five (75) cents must be maintained. The Dealer's price will be forty-five (45) cents each net.

Special supplements, attractively printed, will be shipped to each Jobber with his order for Grand Opera Records. These supplements will be supplied in about the same quantities as furnished Jobbers each month and they will supply them to Dealers in the same manner. As far as possible, we want every Phonograph owner to be informed concerning these high class Records and the trade is urged to use every effort along these lines.

We anticipate a large business in these Records and trust that every Dealer will carry such a stock as will meet every demand on the part of the public. The trade will take no risk in ordering liberally, for they will always be staple stock, and there will be an increasing demand for them as soon as the public learns of their superior character. Then, too, the greater ratio of profit will make it worth while to carry a stock and push the sale of these Records.

NATIONAL PHONOGRAPH Co.,
C. H. WILSON,
General Manager of Sales.

Owing to the duty, the list price in Canada has been fixed at 85 cents each.

MORE ABOUT INFERIOR PARTS.

In the last issue of the PHONOGRAPH MONTHLY was printed an article headed "Inferior Parts," which cautioned the trade against buying parts for Edison Phonographs not made by us. A Dealer returned a clipping of the article, with this notation: "Would you blame Dealers in getting other makes of parts when Edison parts don't fit. How about feed-nuts?" The following was our reply:

We note your statement on clipping from December PHONOGRAPH MONTHLY with reference to Edison parts. We think that you are quite mistaken in this matter. The only parts that you refer to are our feed-nuts, and we do not, therefore, know what other parts you refer to. The feed-nuts that we are supplying to the trade are made on a machine which turns out thousands of them weekly and they are absolutely the same as we are putting on our regular machines. We have no trouble whatever in making them fit these machines and no reason exists why they should not fit other machines of the same style now in use. If you have in your possession any of our make that do not fit the machines they are made for, we will thank you to return them to us and we will be glad to give you new ones for them without charge. You may send these to us collect, and we will immediately return new ones, prepaid. Is it not possible that some one else has sold you feed-nuts, claiming that they are Edison make when really they are not?
NATIONAL PHONOGRAPH Co.

As yet no reply has been received. The offer made in our reply stands good to the entire trade. If Dealers have any genuine Edison parts that will not fit the machines that they are made for, they may send them back and we will replace them without cost for parts or transportation. If such parts are in existence we want to get them back at any reasonable expense.

TOO COSTLY.

Interested owners of Phonographs still occasionally suggest that it would be an excellent plan to print the complete words of all the songs of which we make Records and include a copy in each Record that we send out. Viewed in the light of a few copies, this suggestion seems quite feasible and attractive. When, however, the total quantity of Records made each year is considered, the idea assumes a very different phase, for even at a cost of a few cents per thousand the total cost in a year would be many thousands of dollars. Since there would be no return whatever for this service, the expenditure would be an entire loss. Then, too, the publishers of the various songs would probably take exception to this use of the words and demand a money return for the privilege. Altogether, the suggestion is out of the question.

LOCAL ADVERTISING BY THE TRADE.

As might be expected, the local advertising done by Edison Jobbers and Dealers in December was of a most enterprising character. We regret that an unusual crowd of matter makes it impossible to publish a list of those who sent us copies of their local advertising. The most notable of this advertising was done by the Knoxville Typewriter and Phonograph Co., Knoxville, Tenn., and Ackerman & Co., Scranton, Pa., both of whom used full pages in their daily papers.

GRAND OPERA RECORDS.

Announcement to the Trade.

We have perfected plans for the issuance of a series of Edison Records of Grand Opera selections, made by the principal stars of the Metropolitan Opera House, New York, and prominent artists appearing in Grand Opera in this country and abroad. The following artists appear in the ten selections given herewith that comprise the first list of the series:

Antonio Scotti, Italian baritone	Florencio Constantino, Italian tenor
Heinrich Knote, German tenor	Romeo Berti, Italian tenor
Andreas Dippel, German tenor	Gustave Berl Resky, Italian baritone
Anton Van Rooy, German baritone	Signora Scarphy Resky, Italian soprano

The services of these great artists of the Grand Opera world, as will be understood, were obtained at an extraordinary expense. The work of recording was done at our own laboratories, where our unrivalled equipment made it possible to secure the most faithfully accurate and natural reproductions.

Other instalments of these Records will be issued from time to time.

As an evidence of the artistic character of these Records, we print below the translation of a letter written by Signor Scotti referring to the records made of his voice.

NATIONAL PHONOGRAPH CO., Orange, N. J.
New York Chicago London Paris Berlin
Brussels Sydney Mexico City

LETTER FROM SIGNOR SCOTTI

MILAN, October 9, 1905.

"I have great pleasure in informing you that the cylinders which I sang for you are excellent from every point of view, and I consider them as an absolutely natural reproduction of my voice. I must, however, tell you that the cylinder on which I sang the air from the 'Sonnambula' pleases me most, and I certainly think it is the best of all I have ever heard.

"(Signed) A. SCOTTI."

Grand Opera Records—Supplement A.

FEBRUARY, 1906.

By HEINRICH KNOTE, Tenor.
B. 1—HOCHSTES VERTRAUEN,
("All confidence thou ow'st me.")
"Lohengrin" Wagner
Sung in German. Orchestra accompaniment.

By ANDREAS DIPPTEL, Tenor
B. 2—"ACH, SO FROMM,"
"Martha," Flotow
("None so rare.")
Sung in German. Orchestra accompaniment.

By GUSTAVE BERL RESKY, Baritone
B. 3—"DI PROVENZA IL MAR,"
"La Traviata" Verdi
("Hath thy home in fair Provence.")
Sung in Italian. Orchestra accompaniment.

By FLORENCIO CONSTANTINO, Tenor
B. 4—"LA DONNA E MOBILE,"
"Rigoletto" Verdi
("Fair woman is fickle.")
Sung in Italian. Orchestra accompaniment.

By ANTONIO SCOTTI, Baritone.
B. 5—"VI RAVVISO, O LUOGHI AMENI,"
("Oh, remembrance of scenes long vanished.")
"La Sonnambula" Bellini
Sung in Italian. Orchestra accompaniment.

By SCARPHY RESKY, Soprano
B. 6—ARIA, "SUICIDIO,"
"La Gioconda" Ponchielli
("The Suicide Song.")
Sung in Italian. Orchestra accompaniment.

By ROMEO BERTI, Tenor
B. 7—ARIOSO, "Pagliacci," Leoncavallo
Sung in Italian. Orchestra accompaniment.

By SIGNOR AND SIGNORA RESKY
B. 8—DUET, "La Favorita" Donizetti
Sung in Italian. Orchestra accompaniment.

By ANTON VAN ROOY, Baritone
B. 9—"O KEHR ZURUCK,"
"Tannhäuser" Wagner
("O brother, come.")
Sung in German. Orchestra accompaniment.

By ANTON VAN ROOY, Baritone
B. 10—"CHANSON DU TOREADOR,"
("Toreador's Song.")
"Carmen" Bizet
Sung in French. Orchestra accompaniment.

PHONOGRAPHS FOR MONKEYS.

A dispatch from Paris says that Professor Garner who made special studies of the Simian languages, is now ready for another expedition to the Congo, somewhere near Cape Lopez. He will be equipped with a number of delicate instruments designed to analyze the

the sensations monkeys feel regarding the impressions of color, form and music. He will carry Edison Phonographs especially to register the sounds made by the monkeys while he is hidden among them in his green painted cage. He will sail from Marseilles in a few days.

CONCERNING REPAIR PARTS.

Now that there are two kinds of Gem machines, two kinds of Standards and two kinds of Homes on the market. The trade in ordering repair parts should be careful to state whether they are wanted for the old style or new style machines. Some parts of the new style machines differ from similar parts in the old, and without knowing whether they are wanted for new style or old style, we cannot fill orders with any certainty that we are doing so correctly.

We again desire to call the attention of sub-Dealers to the necessity of ordering repair parts from Jobbers and not direct from us. Even if all conditions are in regular form, practically no time would be gained in ordering repair parts direct from the factory. On the other hand, in most cases, such sub-Dealers are not known to us except through the agreement furnished by their Jobber, and before we can accept any order direct from them we must have a direct agreement signed. Then, if the Dealer is not known to our Credit Department, before shipment of the parts can be made, we send out a pro forma invoice, which must be paid before shipment is made. As a consequence, Dealers put us to considerable extra trouble and cause themselves needless delay when they order parts direct. We will be glad if Jobbers will explain this matter more fully to their Dealers and urge them to make all purchases from them and thereby discourage placing orders direct.

NO EXCHANGE PROPOSITION FOR CUSTOMERS.

Once in a while a Dealer writes in, stating that in his opinion some arrangement should be put into effect by which a Dealer could take back from his customers old Records in exchange for new ones, a similar exchange to be made between Jobbers and Dealers, and between Jobbers and this company. The suggestion is not a new one by any means, and we have on one or two occasions referred to the unreasonableness of such a proposition. When a Phonograph owner buys a Record at a cost of thirty-five cents and plays it several hundred times, if he cares to, he will lose nothing if he throws it away. Even if he plays it fifty times he has had in amusement full value for the money expended. It would be just as reasonable to ask publishers of sheet music to take back old copies in exchange for new ones after the owner had played the music over until he was tired of it. This is the attitude of the National Phonograph Co. concerning this subject, and it is quite improbable that any exchange proposition of this kind will ever be allowed.

DEALERS' RESOLVES FOR 1906.

To carry an adequate stock of Edison Phonographs and the full list of Edison Gold Moulded Records (domestic selections).

To see that every Phonograph owner within your knowledge gets a list of new Records each month and, if possible, some other printed matter concerning Edison Records.

To put down the reason why you lose a sale and take steps to prevent its recurrence.

To advertise in some way and increase such advertising as your business grows; learn to regard advertising as a profitable investment—not an expense.

To maintain prices and other conditions and thereby give Edison goods the same fair treatment that you have given them and they have given you in the past.

To make your stock of goods inviting and your window displays attractive.

To keep in close touch with your Jobber so that you can get goods at short notice should you unexpectedly run out of Phonographs or Records.

To keep your credit at par so that Jobbers will be glad to sell you and will seek your patronage.

A PREMATURE ANNOUNCEMENT.

An announcement has appeared in some of the music trade papers recently to the effect that the National Phonograph Co. was about to put a six-inch Record on the market. This announcement is decidedly premature, for this company has no immediate intention of doing anything of this kind. Should a decision at any time be reached to market a Record of this kind, the trade may rest assured that it will be given ample notice of it in the usual way, and it should pay no attention to unauthorized paragraphs on the subject.

FOLLOW-UP LETTERS.

FROM L. R. PORTER, BROCKTON, MASS.

A short time ago I wrote you a letter, in reply to your correspondence with the National Phonograph Co., in regard to Edison Phonographs and Records. Not having had the pleasure of a reply from you I have thought that perhaps the matter had slipped your mind. If so, kindly let me remind you that winter with its long cold and lonesome evenings is upon us. Now, the best and cheapest way of turning these into hours of happiness is to have an Edison machine in your home.

No other machine or instrument can please your whole family at such a small cost as this great invention of Thomas A. Edison. If you have not yet purchased, kindly inform us of the fact, that we may assist you in what every way possible and open to us to do so. If you have purchased an outfit we would be more than pleased to have your trade in Records and supplies. We carry a very large stock of machines and supplies and also every Edison Record listed in the catalogues. Awaiting your reply and trusting you will not let this matter remain in an undecided way any longer, I remain,

We sell on easy terms and will be pleased to let you have an outfit on terms which I know will please you.

AN ADVERTISING RECORD FOR THE TRADE.

With this copy of the EDISON PHONOGRAPH MONTHLY we are mailing a blank entitling the Dealer receiving it to the use of a special advertising Record which we are loaning the trade for use in connection with store exhibitions. A supply of these Records is being shipped to all Jobbers with their January orders for regular Records and they will supply Dealers upon presentation of the order blanks. This advertising Record is put out with the express understanding that it shall not be sold or given away to the public. The "talk" on the Record is printed in full below. It was made by Len Spencer, whose splendid voice and clear articulation have produced a record of unusual attractiveness.

I am the Edison Phonograph, created by the great Wizard of the new world to delight those who would have melody or be amused. I can sing you tender songs of love. I can give you merry tales and joyous laughter. I can transport you to the realms of music. I can cause you to join in the rhythmic dance. I can lull the babe to sweet repose, or waken in the aged heart soft memories of youthful days.

No matter what may be your mood I am always ready to entertain you. When your day's work is done I can bring the theatre or the opera to your home. I can give you grand opera, comic opera or vaudeville. I can give you sacred or popular music, band, orchestra or instrumental music. I can render solos, duets, trios, quartettes.

I can aid in entertaining your guests. When your wife is worried after the cares of the day and the children are boisterous, I can rest the one and quiet the other. I never get tired and you will never tire of me, for I always have something new to offer. I give pleasure to all, young and old.

I will go wherever you want me—in the parlor, in the sick-room, on the porch, in the camp or to your summer home.

If you sing or talk to me I will retain your songs or words, and repeat them to you at your pleasure. I can enable you to always hear the voices of your loved ones, even though they are far away.

I talk in every language. I can help you to learn other languages.

I am made with the highest degree of mechanical skill. My voice is the clearest, smoothest and most natural of any talking machine.

The name of my famous master is on my body and tells you that I am a genuine Edison Phonograph.

The more you become acquainted with me the better you will like me. Ask the Dealer.

AMONG THE JOBBERS.

The Western Talking Machine Co., Philadelphia, have moved from 25 S. Ninth street to 128 S. Ninth street.

The Phillips & Crew Co., of Atlanta, Ga., who took up Edison goods as Jobbers during December, are one of the leading piano and music houses in the South, and we feel especially pleased at being able to include them in our list of Jobbers. They are aggressive and their efforts will add much to the popularity of Edison Phonographs and Records in that part of the South.

Pardee-Ellenberger Co., of New Haven, have bought the jobbing business of the Caulkins & Post Co., at Middletown, and are now the only Edison Jobbers in Connecticut.

C. A. Ray, Louisville, has moved from 640 Fourth avenue to 650-652 Fourth avenue.

The Reading Phonograph Co., Reading, Pa., are now located at 911 Penn avenue, have moved from 809 Penn avenue.

The Craig-Jay Co., of Indianapolis, have dissolved, the business being continued as the Indiana Phonograph Co., with Charles F. Craig, proprietor. They have moved from the former location, 234 Massachusetts avenue, to 45 Virginia avenue, where they have fully doubled their facilities. The new store is 160 feet deep, with entrances and display windows on two streets. The company are exclusive Edison Jobbers.

For some time past the talking-machine department of the large store of John Wanamaker has been considerably handicapped by the inadequate floor space. They are now making alterations, which, when completed, will give them about twice as much space as they have had before and will enable them to display to much greater advantage a line of Edison goods which they carry. Manager Bockhurst, when seen recently by a representative of the *Music Trades* said: "We carry only the Edison line of goods, and up to this time have suffered materially for want of space. As soon as our alterations are complete we will greatly increase our stock of Records, machines and cabinets and will then have a thoroughly up-to-date line. This department with us is growing rapidly. "Many of our customers find it very convenient to purchase their records and supplies while visiting the store for other purposes, and this helps us materially in our sales. For an indefinite time the talking-machine department will continue to occupy its present quarters, and I cannot say definitely when it will be moved to the new store."—*Music Trades*.

BRANCH OFFICES.

The Mexico branch of the National Phonograph Co. is now in full operation. It is located at Calle Prolongación del 5 de Mayo, No. 67-77, Mexico City. This branch will be under the direction of our Foreign Department with Rafael Cabanas as local manager.

The Australian branch of the National Phonograph Co. is located at 340 Kent street, Sydney. It began business on January 1. Its cable address is "Sonido, Sydney." This office is also under the control of our Foreign department.

Nos. 12227 AND 12273 TO BE CUT OUT.

The trade is hereby advised that we have no moulds or masters of Records Nos. 12227 and 12273 and we will consider these cut out selections when our present stock is exhausted.

COMMENTS ON EDISON GOLD MOULDED RECORDS FOR FEBRUARY, 1906.

This February list of new Records is strictly Edison in character—full of timely songs and music, abounding in variety and recorded in a manner that has made Edison Records the synonym for artistic excellence throughout the entire world. Claims for natural reproduction are made by everybody and, consequently, the public, who will not listen, remain prejudiced. To hear an Edison Phonograph and Edison Gold Moulded Records is to become a convert to their really remarkable qualities.

No. 9194, "Caprice Militaire," by the Edison Concert Band, a composition by T. H. Rollinson, is a favorite with a number of first class band and orchestra organizations and is often heard at the best theatres. It is original in style, brilliant and quite unlike any other composition listed in our catalogue. Its rendition by our Concert Band is a remarkably fine piece of recording.

No. 9195, "Henry Klein," by Miss Ada Jones, is easily the best song specialty introduced into Klaw & Erlanger's annual spectacle, "The White Cat," from the Drury Lane Theatre, London. It is a Dutch waltz song, and Miss Jones gives it in dialect in her usual happy style. It has an orchestra accompaniment. The Dutch wooden shoe dance is one of the realistic and effective parts of the Record. Jerome and Schwartz, who wrote "Mr. Dooley," "Bedelia," "Cordalia Malone" and "My Irish Molly O," all listed in our Record catalogue, are the composers of "Henry Klein," their latest big success.

No. 9196, "I'm Dreaming of You," sung by Collins and Harlan, is a selection quite different from the coon love songs previously made by Collins and Harlan. The song is particularly new, showing the two voices in separate melodies and different words. There is no question about its becoming one of these artists' big successes. Frank Fogerty wrote the words and J. B. Mullen gave it the best melody that he has written in some time.

No. 9197, "Genevieve Waltz Medley," by Eugene Rose, is a Record by the ocarina and the first solo of its kind made for our catalogue. A bit played by the ocarina which was introduced into "The Musical Yankee," our Record No. 9119, led to numerous requests for an entire Record of this unique instrument. This specially arranged waltz solo, with orchestra accompaniment, is the result. The ocarina makes an unusually loud and clear Record, and this selection will undoubtedly be much in demand. It introduces "On the Banks of the Rhine with a Stein," our Record No. 9124, "I'll Be Waiting in the Gloaming, Sweet Genevieve," our Record No. 9108, and "Wait Till the Sun Shines, Nellie," our Record No. 9130.

No. 9198, "Will You Love Me in December as You Do in May?" sung by Harry MacDonough, is a sentimental ballad somewhat above the ordinary, the medley being particularly well written. The words are by J. J. Walker and the music by Ernest R. Ball, composers new to our catalogue. Mr. MacDonough ren-

ders the ballad in a manner fully up to his usual high standard.

No. 9199, "God Be With You Till We Meet Again," is a splendid Record by Anthony and Harrison, of the widely known sacred song, the music of which was written by William G. Tomer and the words by the late Rev. Jeremiah E. Rankin. Made with orchestra accompaniment and splendidly sung by Messrs. Anthony and Harrison. From time to time calls for this selection have been numerous, especially of late, or since the Oyster Bay school children sang it at the departure of the President for his recent tour through the South.

No. 9200, "It's a Good World After All," by Bob Roberts, is a comic song written and composed by Vincent Bryan and Gus Edwards, respectively. The verses are numerous, containing such sentiment as "Married life can't last forever, it's a good world after all." The music is well fitted to the words, which latter Mr. Roberts articulates in his usual distinct manner.

No. 9201, "The Blue Jackets March," played by the Edison Military Band, is a march, composed by C. W. Bennet. It may be likened to one of the most successful Records of band pieces ever listed in our catalogue: "The New Colonial March." Both have the same clarinet features in the trio, or second half, which has been so much admired. The melody in each, of course, differs materially, but the same swing, spirit and dash are in both.

No. 9202, "Daddy's Little Girl," by Byron G. Harlan, is another sentimental song, written by Theodore Morse and Edward Madden, who are responsible for many popular song successes during the last few years. It tells a pathetic little story of human interest set to a melody lingeringly attractive. That Mr. Harlan's work in this Record is in entire sympathy with the intention of the composer goes without saying.

No. 9203, "College Life March," by Joe Belmont, is a most attractive whistling solo. It has been some time since we have listed a solo by Mr. Belmont, whose style and method of whistling is like no other artist in his line. The selection will be found to have lots of snap and go to it. It was written by Henry Frantzen and it is his first appearance in our catalogue with an instrumental number, although we have several successful vocal selections listed, for the music of which he is responsible. Mr. Belmont's solo is made with orchestra accompaniment.

No. 9204, "Lazy Moon," by Billy Murray, is a very unique and melodious coon love song. Written by Cole and Johnson and sung with orchestra accompaniment. It is something new in our Records for Mr. Murray to sing a song of this character, but his excellent rendering of this piece is reason enough for his departure from the kind of songs with which he has been identified. The assistance of the Edison Male Quartette in the chorus is one of the features of the Record.

No. 9205, "Ghost of the Mayor Overture," by the Edison Symphony Orchestra, is a Record, the title of which is the English translation of L. Grossmann's opera "Der Geist

des Wojewoden." It is perhaps best known by its Hungarian title. All the characteristics of Hungarian music are present in the composition. As an orchestra Record, showing the best features of the different instruments, as well as skillful playing and careful recording, it is doubtful if we have ever listed any instrumental number that will be more generally appreciated by admirers of this class of Records.

No. 9206, "Neath the Spreading Chestnut Tree," by Irving Gillette, is a song by Evelyn Bloom and Arthur J. Lamb that gives Mr. Gillette the opportunity of duplicating the success of his singing in our Record "In the Shade of the Old Apple Tree." The two songs are dissimilar both in story and music, but are thought by many to be equally melodious. Sung with orchestra accompaniment.

No. 9207, "Believe Me If All Those Endearing Young Charms," by Miss Marie Narelle, is an excellent Record of the old and ever popular ballad that needs no description here. Its music was written by Sir John Stephenson and its words are by Thomas Moore. Miss Narelle's sweetly sympathetic soprano voice is heard to great advantage in this Record.

No. 9208, "Pocahontas," by Edward M. Favor, is a comic song by Vincent Bryan and Gus Edwards, and is interpreted in Irish dialect by Mr. Favor, who excels in songs of this character. The play upon words is extremely ludicrous, which, of course, Mr. Favor makes the most of. It suggests "Tammany" in a general way, but has no local reference, for which reason it will no doubt have a wider territorial popularity.

No. 9209, "Titania (Air de Ballet)," played by the Edison Concert Band, is a very interesting band selection, and it is rendered by our Concert Band in a style in keeping with its character. It is written in a fascinating waltz tempo, and is replete with changes of melody throughout. The work of the composer, W. G. Sired, is new to our catalogue.

No. 9210, "Is Everybody Happy?" introduces a new artist to our patrons in Miss Madge Maitland. This song was composed by Frank Williams (words) and Ernest Hogan and Tom Lemonier (music). That Miss Maitland will at once prove a success we have no doubt, and the song that she has selected for her initial bow ought to be a second in success to the artist herself. Miss Maitland's coon dialect has never been excelled by an Edison singer, and she injects an individuality into the song that stamps her as a clever artist. Miss Maitland is well known on the vaudeville stage. The chorus of the song is decidedly infectious and insists on not leaving you.

No. 9211, "Robinson Crusoe's Isle," by Arthur Collins, is a song by Benjamin Hapgood Burt, which is one of the best numbers in "Moonshine," a musical play in which Marie Cahill plays the principal part and sings this song. Our Record was made by Arthur Collins, who makes a decided hit of the song. It is a comic song, as will be seen by the chorus as follows:

Robinson Crusoe lived alone,
No bills to pay, or friends to loan;

No wife to say when he comes home,
"Robinson Crusoe, why do you do so?"
He wore the same clothes all the while,
A set of beads and a heavenly smile,
They very seldom changed the style,
On Robinson Crusoe's Isle.

No. 9212, "My Mother's Old Red Shawl," sung by MacDonough and Biehling, is a selection, which is also known as "The Little Old Red Shawl My Mother Wore." It was formerly included in our catalogue and in response to numerous requests is now re-listed, but this time as a male duet by MacDonough and Biehling. The favorite old pathetic ballad is too well known to need description.

No. 9213, "The Chaser March," is another xylophone solo by Albert Benzler. It is thought by many to equal "The Messenger Boy" March, one of the best xylophone Records in our catalogue. It is safe to predict that it will be just as popular and perhaps more so. The one composition suggests the other in swing and catchiness, but they are entirely unlike otherwise. The orchestra accompaniment makes a fine background.

No. 9214, "Save Your Money 'Cause de Winter am Coming On," by Miss Clarice Vance, is a coon song of the real comic variety, and in the hands of Miss Vance is unusually so. The general opinion of all who have heard Miss Vance's latest effort is that it is superior in every point of interest to "Mariar," our Record No. 9051, which we listed last August. The orchestra accompaniment is one of the features of this Record. Raymond Teal and Hal Godfrey are the writers.

No. 9215, "The Original Cohens," by Ada Jones and Len Spencer, is a vaudeville sketch that differs from all other Records of these artists previously listed by us. As the title implies, it is a Hebrew sketch. It introduces an adaptation of the old-time Hebrew character song, "Solomon Levy," sung by both Miss Jones and Mr. Spencer. The scene is laid in a Baxter street New York clothing store, while the action of the sketch portrays the popular impression of daily happenings in that famous locality. Such expressions as "Fadder, push the blue shade over the skylight, here's a gentleman wants a blue suit," are numerous throughout the Record and provoke many a laugh.

No. 9216, "Song of the Steeple," by the Edison Male Quartette, is a composition by Edmund E. Price (words) and Monroe H. Rosenfeld (music) that was specially arranged for our Record as a male quartette and sung unaccompanied. The song is splendid in its new dress and is bound to be appreciated more than ever. It is quite a departure in style of arrangement from the usual quartette.

No. 9217, "Silver Heels," played by the Edison Military Band, is the new 1905-6 annual instrumental number issued by the music publishing firm who made "Hiawatha" famous throughout the world. It is also composed by Nell Moret, who wrote "Hiawatha." That it will be extremely popular and much asked for, goes without saying, even if it had to depend on its catchy musical merit alone, without the added boom that it will get from its very much alive publishers and the reputation of its famous composer.

FOR LOWER FREIGHT RATES.

The National Phonograph Co., through George N. Nisbett, its Western manager, is actively working toward securing a reduction in the freight rates on talking machines.

We have filed a petition and made application to the Western Classification Committee for a reduction in rates on Phonographs and Phonograph Records, from one and a half times first class to first class in less than car lots, and third class in car lots, and have prefaced our contention for this application by stating that the representative business men of the West recognize the utility of our product and that they realize that to successfully introduce same and handle it on a paying basis it is very essential that transportation charges be brought into line, in order to do business at a profit, and that while we are doing a fairly good business in the West we feel justified in saying that it would be increased 300 per cent. by granting the reduction prayed for. As further matters of interest, we have demonstrated to the Classification Committee that the average value of Phonographs shipped last year did not exceed \$12. The average weight per cubic foot is 15¼ pounds, the average value per cubic foot, \$3.57. Another strong point that we have brought forward is the value, loading capacity and commercial necessity, in comparison with articles analogous thereto:

First.—A musical instrument, and as such is entitled to the same rates as musical instruments, boxed, N. O. S. first class, pianos, automatic pianos, boxed, etc.

Second.—They are in use commercially for dictation and educational purposes, and as such are entitled to same rates as other articles used for educational purposes, school books, as an illustration, from which knowledge is imparted.

Third.—The commodities mentioned below are of greater value and of less loading capacity, and in a large measure are no more of a commercial necessity—photographic material, N. O. S. boxed; millinery, N. O. S. boxed; perfumery, boxed; toys, N. O. S. boxed, etc., and we could add innumerable other citations.

In this move we shall undoubtedly have hearty support of the entire trade, as it will be the means of helping Jobbers and Dealers to get their goods at fair transportation rates. The matter will come up for consideration before the classification committee which meets in Los Angeles, Cal., some time in January.

EDISON PLAN A GOOD MODEL.

The reduction in price of certain talking machine records is interesting to us in some features which make us feel flattered. These include the same trade prices as fixed for Edison Records, they abolish the exchange proposition and they cut out the special dozen price, all of which have been peculiar to the National Co.'s plan of doing business.

PUBLISHERS OF MUSIC IN JANUARY LIST.

The publishers of the compositions made for our *January* list of Records, so far as we can obtain them, are given below. Where the numbers are omitted they they are either not published or we are unable to give the names of the publishers:

- 9170 "The Choristers"—Piano copy published by Jos. W. Stern & Co., New York.
 9171 "Somebody's Sweetheart I Want to Be"—Gus Edwards Music Pub. Co., New York.
 9173 "A Lovely Night in June"—Jean Missud, Salem, Mass.
 9174 "I'm Getting Sleepy"—Harry Von Tilzer, New York.
 9175 "If a Girl Like You, Loved a Boy Like Me"—Gus Edwards Music Pub. Co., 1512 B'way, New York.
 9177 "Lights Out March"—Carl Fischer, New York.
 9178 "Miss Mary"—M. Witmark & Sons, New York.
 9179 "The Load that Father Carried"—P. J. Howley, New York.
 9181 "Forget-Me-Nots"—Oliver Ditson Co., Boston, Mass.
 9182 "I'm a Woman of Importance"—Jerome H. Remick & Co., New York.
 9183 "La-Tydley-Tydley-um"—Jerome H. Remick & Co., New York.
 9184 "Paddle Your Own Canoe"—F. B. Haviland, New York.
 9185 "It Blew! Blew! Blew!"—Carl Fischer, New York.
 9186 "Robin Redbreast"—Jos. W. Stern & Co., New York.
 9187 "Good-Bye, 'Dixie' Dear"—Sol Bloom, New York.
 9188 "Yankee Boodle"—Jerome H. Remick & Co., New York.
 9189 "A Gay Gossoon"—Chas. K. Harris, New York.
 9190 "Take Me to Your Heart Again"—M. Witmark & Sons, New York.
 9192 "The Jolly Blacksmiths"—White-Smith Music Pub. Co., New York.

LIKES THE IMPROVEMENTS.

FINDLAY, OHIO, DEC. 4, 1905.

I noticed in the December issue of the PHONOGRAPH MONTHLY that a dealer did not like the idea of the speed regulating screw being placed under the machine. I, on the contrary, think it a very wise idea in putting same where it can not so easily get turned, as it is almost impossible to wipe off the machine with cloth without turning this screw. I have sold the Edison machines, for over ten years and many a time I have had a customer bring his machine back to have the speed regulated, as there are a great many who own machines that cannot tell, anywhere near, by the sound how fast they should run, and thus the reproduction is not as good as it might be. I think this will stop the bad habit which some owners of machines have, and that is in varying the speed of the machine on almost every Record. I have heard a machine played that was not at the proper speed and it was enough to disgust anyone with the very name of a talking machine, and yet, strange to say, the operator did not honestly know but what it was being played at the very best advantage possible. Although he knew it was not very natural, he took it for granted that it was the best a Phonograph would do. The other improvements on Standard, Home and Gem are greatly in their favor, and I am glad, for one, to see them so rapidly advance.

F. J. COLLINGWOOD.

THE PIANO TRADE AND PHONOGRAPHS.

C. H. Wilson, General Manager of Sales of the National Phonograph Co., had the following to say when the subject of the influence of the talking-machine on the sale of pianos was broached to him by a representative of the *Music Age*:

"In the first place, my impression is that you can sell one hundred talking-machines where you sell one piano; because they reach a poorer class of people than the piano does. Talking-machines, in my opinion, are more profitable to the dealer than pianos, for the reason that the money invested in them is turned three or four times to once for that in pianos.

"As for our business being temporary, I have heard that tale for the past ten years, but in spite of it the talking-machine industry is going ahead by leaps and bounds, and we are just as optimistic to-day about it as we were at its inception. I feel, as every talking-machine man must, that the business is simply in its infancy. Instead of being a fake or a fad, as some wise ones hinted at first, it has got to be one of the staple lines in the musical field.

"From talks which I have had with several concerns, I am convinced that music dealers are making more out of the talking-machine than any other line of goods they handle, and if it were not for this instrument a great many of the small dealers would not be able to make a living. Instead of being a detriment to piano dealers, I consider it a benefit, as it brings customers into their stores who otherwise would not come. One object of every merchant, I take it, is to get people to examine his wares, and in this respect what can outshine the talking-machine as an advertiser? When people come to the store to buy talking-machines or any other article that the dealer carries the salesman has the opportunity to let them know something about the piano line. This is only one of the ways in which the talking-machine can help the piano man.

"To-day the talking-machine is being sold by the foremost piano dealers of the country, which clearly proves my contention that it is one of the legitimate and permanent adjuncts of the music trade.

"I think I cannot advance any sounder argument in behalf of the talking machine's future than to mention just a few of our customers who are prominent piano dealers. On our list we have Lyon & Healy, of Chicago; W. J. Dyer & Bro., of St. Paul, Minn.; Rudolph Wurlitzer Co., of Cincinnati and Chicago; O. K. Houck Piano Co., of Memphis, Tenn., and St. Louis; D. S. Johnston Co., Seattle, Wash.; J. W. Jenkins' Sons Co., Kansas City, Mo.; C. J. Heppe & Son, Philadelphia; E. F. Droop & Sons Co., Washington, D. C., and Ilsen & Co., of Cincinnati; all of whom handle our talking-machines as Jobbers, and there are many others who handle them as retail dealers.

"In conclusion, let me prophesy that within half a decade every piano house of note that also handles small goods will deal extensively in talking-machines."

Plan for a bigger Phonograph and Record Business in 1906.

PRINTED MATTER.

A new edition of the Numerical Record Catalogue will be mailed to the trade in January. It will contain all titles listed to and including February.

Because so many Jobbers insisted upon having a quantity of Record Bulletins sent with goods each month, with which to supply their Dealers, we are now mailing but one copy to Dealers, instead of two as before. Other Jobbers having Dealers who need more than one copy may have a supply shipped with Records. Such orders will be kept on a standing list.

NATIONAL PHONOGRAPH CO.'S EXPORT BUSINESS.

The manner in which the export business of the National Phonograph Co. is increasing is well told in the following interview by Walter Stevens, manager of our Foreign Department, in the *Talking Machine World*:

The unexampled prosperity of the talking machine business is not confined, by any means, to the domestic trade. Export business is keeping step with the phenomenal trade, and Walter Stevens, manager of the export department of the National Phonograph Co., bears out this assertion in the subjoined remarks:

"Has our export business increased? Why, my dear sir, it has gone ahead in the most remarkable manner. Of course, in Japan, with the war troubles, little could be expected, and in China it is also a little slow. Elsewhere, however, the National Phonograph Co. and the Edison goods are regnant. The company's European business is in the hands of our established agencies in London, Paris, Berlin, Belgium, etc. Our particular territory is the Latin-American countries and Australia, and business in those portions of the world is simply surprising. As compared with last year the increase has been fully 100 per cent., and in Australia it goes even beyond that percentage. As a matter of truth, Australia is 'Phonograph mad,' and there is practically no end to the Edison business in that portion of the world. Recently we have established a branch there, and the other morning I received a cable that our man had secured a location and would proceed immediately to put things in shape. Hereafter goods will be sent our agent there as a general distributing point for the entire colony. As yet no goods are sold there on instalment, but it is probable this will come along soon, as competition is very keen.

"In the South and Central American countries the preferable call is for band and orchestra Records. Operatic numbers are also very popular, and where the English-speaking people reside the ordinary popular song, instrumental and talking Records, sell well, and the Edison line has a prestige that stands undimmed before the world. India is another great market for talking machines, but the distinctions of caste or class are so marked that the great call is for the highest grade of goods—

everything gold-plated and the most costly Records. In common with other foreign countries, the demand is for native Records, and we are now in a position to satisfy all comers in this respect.

"European merchants, especially the English and the Germans, are more favorably placed than we, so far as trade with South American countries is concerned, on account of the banks established by these nationalities and the shipping lines, but we are gradually overcoming these drawbacks, and as has been true in the past, American enterprise and ingenuity will overcome this temporary obstacle. A new line of steamships from New York is about to be realized, and then we will be in a position to compete with anybody. Our best trade is on the west coast of South America, but business with Argentina is prospectively of the most glowing character. The Edison goods command a price, and the only objection I could offer is that our Latin-American friends are inclined to insist upon too high figures. That, of course, we cannot help. It is beyond our jurisdiction."

EDISON PHONOGRAPH A COURT WITNESS.

For the first time in the legal annals of the United States the sound Record of a Phonograph was admitted in evidence in the Superior Court, Boston, on December 13th, in a "noise" damage suit against the Boston Elevated Railroad. It was not, however, without strenuous objection on the part of Gen. C. W. Bartlett, late Democratic candidate for Governor, counsel for the defense, that this novel proceeding was permitted. Judge Wait overruled the objections.

The machine—an Edison, furnished by the Eastern Talking Machine Co., of Boston—was then placed on a table facing the jury, and then a voice was heard from the horn, saying: "Record No. 7."

This was followed by a light rumbling, as of street traffic, and the voice announced: "The train is now at the Beach street station."

The rumbling continued, somewhat louder than before, and the voice announced: "A tip-cart is now passing."

A heavier rumbling, which grew louder, was heard, and the voice announced: "The train has just started."

This was followed by an increasing noise and the announcement: "The train is approaching."

The noise rose with the characteristic clatter and bang of a passing train and diminished to that of the usual traffic of the street. The voice was heard for the last time, saying: "The train has passed."

In offering the Record R. M. Morse, counsel for the petitioners, said: "Anticipating an objection on the part of Brother Bartlett, I will state my object in offering this evidence. The Phonograph is one of the most acute scientific Records, and I offer it on the same ground upon which photographs are put in evidence. Originally the photograph was in the position now occupied by the Phonograph,

and I remember well the strenuous opposition which was raised to the admission of the former at one time. The Phonograph, as we all know, is a scientific instrument, and to my knowledge it has been put in evidence at least once in the English courts, though never before, I think, in the courts of this country. It is difficult to describe a noise, or compare one noise with another. The best that can be done is to offer a Record of it."

Gen. Bartlett objected to the introduction of the instrument on the ground that the development of the instrument, and the art of managing it, was not sufficiently advanced and exact to warrant its admission to a court of law, and because it did not appear that the instrument presented in court had the same appliances in the shape of the horn, and other appliances for the reproduction of sound, that it had when the Records were taken.

Judge Wait said that the objections made by counsel were practically the same as those that were made against the admission of photographs and radiographs as evidence, to be submitted to a jury, though perhaps greater in degree, but said that in his discretion he would admit the evidence in this case, but would not consider this as a precedent for the submission of such evidence generally.

The case resulted in a verdict of large damages for the plaintiff.

A DEALER'S VIEW ON INSTALMENT SALES.

Having read your article in the December PHONOGRAPH MONTHLY, "Shall Dealers Sell on Instalments?" I would like to give you our experience along that line. We find that by selling Phonographs on the easy-payment plan (as we call it) we can sell about ten times as many as we could if we sold them for cash only.

A great many working men and farmers are buying them in this way, while, if they had to pay the full amount down, they would never own a machine. This class of people are also good Record customers. We have one customer who bought a machine this way and now he says, he buys Records instead of getting drunk.

In regard to our collections, we have it distinctly understood that all weekly payments are to be paid at our store, and up to date we have not had one delinquent. It is a matter of how you teach your customers. If there is nothing said about this matter, they naturally will expect you to go after it, and if you make the first collection in that way you can make up your mind that you will have to continue such a course.

We do not consider that we take as much risk in selling Phonographs by this method as some Dealers do that are in the credit business. If we find that a customer is not going to pay, then, by the terms of our agreement, we will proceed to have the machine returned. Every customer to whom we have sold an Edison outfit would not take twice what he paid for it, if he could not replace it, hence we feel safe in selling Edison Phonographs on this plan.

Our agreement is a form that was adopted by the piano dealers at their last annual meet-

ing, and is considered the only one that will stand the law. (It is given below.)

G. W. HALL & CO.,
BELLEFONTE, PA., DEC. 7, 1905.

BELLEFONTE, Pa.,

THIS IS TO CERTIFY, That I have this day hired from G. W. Hall & Co., Bellefonte, Pa., one Edison Phonograph No., valued at \$....., for the use of which I agree to pay G. W. Hall & Co., \$..... in advance at their office, and in consideration of the renting me said Edison Phonograph, No..... I hereby agree that it shall not be sublet or removed from the premises now occupied by me at except on account of danger from the elements, without the written consent of G. W. Hall & Co., said G. W. Hall & Co. to be at liberty to enter upon my premises and remove said Edison Phonograph at any time, provided moneys paid in advance for time not yet expired, if any, be refunded, and I further agree to pay for any damage to or loss of said Edison Phonograph while leased by me—except ordinary wear. In witness whereof, I have hereunto set my hand and seal this day of, 190

Signed in the presence of
Name (L. s.)
P. O. Address

MR. SCHERMERHORN IN EUROPE.

Mr. J. R. Schermerhorn has been elected Chairman of Directors of the National Phonograph Co., Limited, and will take an active part in the management of the company's affairs. In addition to his position on the board of the National Phonograph Co., Limited, Mr. Schermerhorn has also undertaken, on behalf of the National Phonograph Company of America, the control and management of the different manufacturing plants in Germany,

Belgium and France. Mr. Schermerhorn will thus have an opportunity of organizing both selling and manufacturing departments with, it is safe to predict, most satisfactory results to all those who handle genuine Edison Records.—*Talking Machine News, London.*

PLAYED IT AND CHANGED HIS MIND.

MONROE, N. C., DEC. 8, 1905.

Just received your last shipment of Records and they are all good ones. I went out about seven miles in the country a few weeks ago to give a school a little concert. They wanted to raise funds for their library. I gave them about two hours. They cleared a good little sum, and I sold two Standard machines with thirty-six-inch horns, and a lot of Records, the very next week. I am going out again next Saturday to another school to give them a concert. While I do not charge them anything, it is a big "ad" for me, and more than pays me. There is no Phonograph that can touch the Edison in my opinion. A man was in my store not long since that had made up his mind to buy a disk machine. I told him that he was making a mistake. He said that he knew what he was doing; that the disks were the only machines. He knew a good deal about handling Phonographs, and I let him play mine all he wanted to. He kept coming in and playing my machine. I said nothing to him; only greeted him kindly. The outcome of it all was, I sold him a Standard, 36-inch horn and stand and 200 Records.

T. P. DILLON.

THE BALL-FINTZE CO., NEWARK, O.

The Ball-Fintze Co., Newark, O., Jobbers of Edison Phonographs, recently moved into a fine new building which they have erected for their own purposes. It is a store structure, 100x100, three stories and basement. The en-

the building justice. As the picture shows, they have their own side track. They believe that this is the largest building devoted entirely to this line of goods in the United States. The Ball-Fintze Co. are exclusively wholesale Job-



tire second and third floors are devoted to Phonographs and supplies. The offices are located on the second floor and are very handsomely finished in Flemish oak. The accompanying picture being a side view does not do

bers and not connected in any way with a retail department. They are one of the largest and most aggressive Edison Jobbers in the middle West.

JOBBER'S OF EDISON PHONOGRAPHS AND RECORDS.

ALABAMA.

Birmingham—Talking Machine Co., 2007 Second ave.
Mobile—W. H. Reynolds, 167 Dauphin street.
Montgomery—R. L. Penick, 119 Dexter ave.

CALIFORNIA.

San Francisco—Peter Bacigalupi, 786-788 Mission street.

COLORADO.

Denver—Denver Dry Goods Co., 610 16th street.
 Hext Music Co., 15th and California streets

CONNECTICUT.

New Haven—Pardee-Ellenberger Co., 155 Orange st.

DISTRICT OF COLUMBIA.

Washington—E. F. Droop & Sons Co., 925 Pennsylvania avenue, N. W.
 S. Kann Sons & Co., 8th and Pennsylvania avenues.

GEORGIA.

Atlanta—Atlanta Phonograph Co., 49 Peachtree St.
 *Phillips & Crew Co., 37-39 Peachtree St.
Waycross—George R. Youmans.

ILLINOIS.

Chicago—Babson Bros., 148 Michigan Ave.
 Lyon & Healy, Wabash Ave. & Adams St.
 James I. Lyons, 192 Van Buren street.
 Talking Machine Co., 107 Madison street.
 The Vim Co., 68 E. Lake street.
 Montgomery Ward & Co., 111 Michigan ave.
 Rudolph Wurlitzer Co., 302 Wabash ave.
Peoria—Peoria Phonograph Co., 416 S. Adams street.
Quincy—Quincy Phonograph Co., 808 Hampshire st.

INDIANA.

Indianapolis—Indiana Phono. Co., 45 Virginia Avenue.
 Kipp Bros. Co., 37 S. Meridian street.
 A. B. Wahl & Co., 119 S. Illinois street.
Lafayette—A. B. Wahl & Co., 304 Main street.

IOWA.

Des Moines—Hopkins Bros. Co., 620 Locust street.
 Vim Co., 704 West Walnut street.
Fort Dodge—Early Music House, 822 Central ave.

KENTUCKY.

Louisville—C. A. Ray, 650-652 Fourth avenue.

LOUISIANA.

New Orleans—William Bailey, 600 Frenchman street.
 National Automatic Fire Alarm Co.,
 614 Gravier street.

MAINE.

Bangor—S. L. Crosby Co., 186 Exchange street.
Portland—W. H. Ross & Son, 207 Commercial street.

MARYLAND.

Baltimore—E. F. Droop & Sons Co., 109 N. Charles St.

MASSACHUSETTS.

Boston—Boston Cycle & Sundry Co., 48 Hanover street.
 Eastern Talking Mach. Co., 177 Tremont st.
 Iver Johnson Sptg. Goods Co., 163 Washington street.
 C. E. Osgood Co., 744 Washington street.
 Read & Read, 630 Washington street.

Fitchburg—Iver Johnson Sptg. Goods Co., 247 Main st.

Lowell—Thomas Wardell, 111 Central street.

New Bedford—Household Furnishing Co., 170 Purchase street.

Springfield—Flint & Brickett Co., 439 Main st.

Worcester—Iver Johnson Sptg. Goods Co., 304 Main st.

MICHIGAN.

Detroit—American Phono. Co., 106 Woodward ave.
 Grinnell Bros. 219 Woodward ave.

MINNESOTA.

Minneapolis—Thomas C. Hough, 714 Hennepin ave.
St. Paul—W. J. Dyer & Bro., 21-23 West 5th street.
 Thomas C. Hough, 392 Wabasha street.
 Minnesota Phonograph Co., 37 E. 7th street.

MISSOURI.

Kansas City—J. W. Jenkins' Sons Music Co., 1013-1015 Walnut street.
 J. F. Schmelzer & Sons Arms Co., 710 Main street.

St. Louis—Conroy Piano Co., 11th and Olive streets.
 O. K. Houck Piano Co., 1118 Olive street.
 Western Talking Machine Co., 923 Olive st.

MONTANA.

Helena—Frank Buser, Diamond Block, Sixth avenue.

NEBRASKA.

Lincoln—H. E. Sidles Cycle Co., 1317 O street.
Omaha—Nebraska Cycle Co., 15th and Harney streets.
 Omaha Bicycle Co., 16th & Chicago sts.

NEW JERSEY.

Hoboken—Eclipse Phono. Co., 203 Washington st.
 Douglas Phonograph Co., 20 New street.

Newark—A. O. Petit, New and Halsey streets.
 V. H. Rapke, 287 Bank street.

Paterson—James K. O'Dea, 117 Ellison street.

Trenton—Stoll Blank Book and Stationery Co., 30 E. State street.
 John Sykes, 105 N. Broad street.

NEW YORK.

Albany—Finch & Hahn, 92 State street.

Brooklyn—A. D. Matthews' Sons, 394 Fulton street.
 Price Phonograph Co., 1260 Broadway.

Buffalo—P. A. Powers, 613 Main street.

Elmira—Elmira Arms Co., 117 Main street.

Gloversville—American Phono. Co., 99 W. Fulton st.

Kingston—Forsyth & Davis, 307 Wall street.

New York City—Bettini Phono. Co., 156 W. 23d street.
 Blackman Talking Machine Co., 97 Chambers street.
 J. F. Blackman & Son, 2737 3d avenue.
 Sol Bloom, 214 W. 42d St
 I. Davega, Jr., 802 Third avenue.
 S. B. Davega, 32 E. 14th street.
 Douglas Phono. Co., 89 Chambers st.
 H. S. Gordon, 1241 Broadway.
 Harry Jackson, 219 Bowery.
 Jacot Music Box Co., 39 Union Square.
 Victor H. Rapke, 1661 Second avenue.
 Siegel-Cooper Co.
 John Wanamaker.
 Alfred Weiss, 1525 First avenue.

Oswego—Frank E. Bolway, 32 Bridge street.

Poughkeepsie—Price Phonograph Co., 203 Main st.

Rochester—A. J. Deninger, 345 North street.
 Mackie Piano, O. & M. Co., 100 State street.
 Giles B. Miller, 63 State street.
 Talking Machine Co., 97 Main st., E.

Schenectady—Finch & Hahn, 504 State street.
 Jay A. Rickard & Co., 253 State street.

Syracuse—W. D. Andrews, 216 E. Railroad street.

Troy—Finch & Hahn, 3 Third street.

Utica—Clark-Horrocks Co., 54 Genesee street.
 Arthur F. Ferriss, 89 Washington street.
 William Harrison, 41 Columbia street.
 Utica Cycle Co., 31 Columbia street.

OHIO.

Canton—Klein & Heffelman Co., 216 N. Market street.

Cincinnati—Ilsen & Co., 25 W. 6th street.
 Rudolph Wurlitzer Co., 10-12 W. 4th st.

Cleveland—Eclipse Musical Co., 162 Prospect st.

Columbus—Perry B. Whitsit Co., 213 S. High street.

Dayton—Niehaus & Dohse, 35 E. 5th street.

Newark—Ball-Fintze Co.

Toledo—Hayes Music Co., 608 Cherry street.

OREGON.

Portland—Graves & Co., Inc., 328 Washington St.

PENNSYLVANIA.

Allegheny—Henry Braun, 500 Federal street.

Allentown—G. C. Aschbach, 539 Hamilton street.

Easton—William Werner, 401 Northampton street.

Harrisburg—S. K. Hamburger, 12-14 N. Market sq.

New Castle—W. C. DeForest & Son.

Philadelphia—C. J. Heppe & Son, 1117 Chestnut street.
 Lit Bros., Market and 8th streets.
 Penn Phonograph Co., 17 S. 9th street.
 John Wanamaker, 13th and Market sts.
 Wells Phonograph Co., 45 N. 9th street.
 Western Talking Mach. Co., 128 S. 9th st.
 H. A. Weymann & Son, 923 Market st.

Pittsburg—Theo. F. Bentel Co., Inc., 632 Liberty street.
 H. Kleber & Bro., 221 Fifth avenue.
 C. C. Mellor Co., 319 Fifth avenue.
 Pittsburg Phono. Co., 937 Liberty street.
 Talking Machine Co., 619 Penn ave.

Reading—Reading Phonograph Co., 911 Penn street.

Scranton—Ackerman & Co., 130 Wyoming avenue.
 Technical Supply Co.

Williamsport—W. A. Myers, 145 W 3d st.

RHODE ISLAND.

Pawtucket—Pawtucket Furniture Co., 39 N. Main St.

Providence—J. M. Dean Co., 785-795 Westminster street.
 J. A. Foster Co., Weybosset st.
 Household Furniture Co.
 J. Samuels & Bro., 154 Weybossett street.
 A. T. Scattergood & Co., 106 N. Main st.

TENNESSEE.

Knoxville—Knoxville Typewriter and Phonograph Co., 421 Gay street.

Memphis—O. K. Houck Piano Co., 103 S. Main street.
 F. M. Atwood, 160 N. Main St.

Nashville—Nashville Talking Mach. Co., 510 Church st
 Magruder & Co., 13 Arcade.

JOBBERERS OF EDISON PHONOGRAPHS AND RECORDS—Continued.

TEXAS.

Dallas—Southern Talking Machine Co., 347 Main st.
 El Paso—W. G. Walz Co., 101 El Paso street.
 Fort Worth—Cummings, Shepherd & Co., 700 Houston st.
 Houston—Texas Phono. Co., Capitol and Fannin Sts.
 San Antonio—H. C. Rees Optical Co., 242 West Commerce St.

VERMONT.

Burlington—American Phono. Co., 34 Church St.

VIRGINIA.

Richmond—Magruder & Co., 729 E. Main st.

WASHINGTON.

Seattle—D. S. Johnston Co., 903 Second Ave.
 Spokane—Spokane Phono Co., 7 Post St.

WISCONSIN.

Milwaukee—McGreal Bros., 173 3d street.

CANADA.

Toronto—R. S. Williams & Sons Co., Limited,
 143 Yonge street.
 Winnipeg—R. S. Williams & Sons Co., Ltd., 121 Princess street.

*Added since December 1, 1905.

SUSPENDED LIST, JANUARY 1, 1906.

SUPERSEDING ALL PREVIOUS LISTS.

GEORGIA.

Valdosta—H. K. McLendon, 109 West Central Ave.

ILLINOIS.

Champaign—Eggleston Bros.
 Ottawa—Edward Hayne.
 Wheaton—E. Irving.

INDIANA.

*Logansport—F. M. Neff, 406 Broadway.
 South Bend—EUGENE MARSH, 126 Vistula avenue.
 SOUTH BEND BOOK BINDERY, Robert
 Lebolt, Prop., 203 North Michigan street.

IOWA.

Burlington—JOHN P. WEISS, 711 Jefferson street.
 Sioux City—HATTENBACH BROS. CO.
 A. V. LARIMORE, 518 Fifth street.

KANSAS.

Clay Centre—E. M. GOWENLOCK.
 Lawrence—BELL BROS.
 Topeka—R. H. MOREHOUSE, 510 E. 4th street.

MAINE.

Biddeford—W. H. FIELD.
 Lewiston—J. W. SKENE.
 Monmouth—G. H. STETSON.

MASSACHUSETTS.

Boston—E. C. PECK, 43 Milk st.
 T. SINGER, 60 Leverett street.
 Franklin—E. P. Blackman.
 Lawrence—LORD & CO., 314 Essex street.
 E. O. MOSHER, 420 Essex street.
 Lynn—ELIAS DEYOUNG.
 Malden—A. T. FULLER.
 Nantucket—ARTHUR M. TAYLOR.
 New Bedford—H. B. DEWOLFF.
 Somerville—E. J. WINCHESTER, 32 Summit avenue.
 Worcester—JOSEPH TUKMAN, 44 Front street.
 Woburn—OSBORN GILLETTE, or THE BOLTON
 JEWELRY CO., L. F. Maloney, Manager.

MICHIGAN.

Detroit—F. J. SCHWANKOVSKY.
 Saginaw—GEO. W. EMENDORFER.
 JAMES V. CALAHAN, 217 Genessee st.
 TIERNEY BROS., 217 Genessee st.

MISSOURI.

Kansas City—THE WITTMANN CO.

NEBRASKA.

Lincoln—THE WITTMANN CO.
 Omaha—THE WITTMANN CO.

NEW HAMPSHIRE.

Hillsboro Bridge—E. M. BARNES.
 Manchester—A. E. DUMAS
 Nashua—F. A. MCMMASTER & CO.

NEW JERSEY.

Atlantic City—SAM'L D. WOLF, 32-34 Arkansas ave.
 Bayonne—I. WIGDOR, 450 Avenue D.
 Jersey City—W. L. HOFFMAN, 151 Montgomery st.
 Newark—R. L. CORWIN; also New York City.
 Passaic—I. HURWITZ.
 Paterson—CHAS. H. KELLY, 25 N. Main street.
 Plainfield—S. W. FRUCHT, or R. FRUCHT; also
 New York City.

*Added Since December 1, 1905.

Jobbers and Dealers are asked not to supply any of the above named firms with our apparatus, either at addresses given or any other address.

ELSTON M. LEONARD.

West Hoboken—EMIL HOLLANDER, or THE WEST
 HOBOKEN BICYCLE & PHONO. CO., 619
 Spring street.

NEW YORK.

Albany—G. LINDE, 353 S. Pearl street.
 Auburn—CHAS. C. CHIER CO., 18 Clark street.
 Bedford Park—GEO. H. TYRRELL.
 Brooklyn—WM. ALBRECHT, 294 Knickerbocker ave.
 H. HINDERMAN, BUSHWICK PHONO-
 GRAPH EXCHANGE, 1421 Myrtle avenue.
 Hobart—F. H. MARSHALL.
 Mohawk—ALBANY SPECIALTY CO., or CHAS. F.
 RICE, Main street.
 Moravia—C. D. LOOMIS & CO., Union Block.
 New York City—A. T. ARMSTRONG, or AMERI-
 CAN PHONO. CO., 106 Wall street.
 AUTOMATIC ZITHER CO., M. Cohen, Prop.,
 58 Second avenue.
 BERN BEARWALD, 373 W. 11th st.
 EDWARD BIELFELD, 481 Willis Ave.
 BRONX PHONO. CO. or DAVID SWITKY,
 506 Willis ave.
 CENTRAL PHONO. CO., 160 E. 42d street.
 R. L. CORWIN; also Newark, N. J.
 EAGLE PHONO. CO., or C. LOWENTHAL,
 83 Nassau street.
 EMPIRE PHONO. CO., 2 W. 14th street.
 S. W. FRUCHT, or R. FRUCHT, 7 Barclay st.,
 or 68 Cortlandt st.; also Plainfield, N. J.
 O. HACKER, 2 Murray street.
 HAWTHORNE & SHEBLE, 297 Broadway;
 also Philadelphia, Pa.
 HOLOBER BROS., 350, 421 and 491 West st.
 N. HORN, 148 E. 58th street.
 W. L. ISAACS, 114 Fulton street.
 S. LEMBURG & CO., 194 Broadway.
 J. MCELLYNNE, 202 Broadway.
 RICHMOND PEASE, 44 W. 132d st.
 F. M. PRESCOTT, 44 Broad st.
 WINTHROP CYCLE CO., 2212 Seventh ave.
 Rome—CHARLES TUTTLE.
 Saratoga—W. J. POTTEN.
 Saratoga Springs—MARVIN A. COTE.
 Watertown—HENRY A. HARDY, 24 Arsenal st.
 H. S. WARDWELL & CO., 39 Public Square.
 Wolcott—J. A. MURPHY, 7 Main street.

NORTH CAROLINA.

Kinston—S. A. Quinerly.

OHIO.

Cincinnati—J. L. ANDEM.
 Coshocton—BURNS & GOSSER.
 Springfield—D. & M. VANDERPOOL.
 Uhrichsville—F. A. MAZURIE.

PENNSYLVANIA.

Philadelphia—A. R. CASSIDY, 2783 Emerald street.
 HAWTHORNE & SHEBLE, 604 Chestnut st., or
 Oxford and Mascher sts.; also New York City.
 A. KROUSE, 832 Arch street.
 PENN NOVELTY CO., 15 South 9th st.
 Phoenixville—KEINARD BROS.
 Pittsburg—A. LIPPARD, 615 Wylie ave.

RHODE ISLAND.

Providence—F. P. MOORE.

WISCONSIN.

Milwaukee—J. C. BLATZEK.



Edison Assures Perfect I.C.S. Records

Perfection is exemplified in every part of the I. C. S. Language Courses. The pronunciation of the master records is first made absolutely perfect by the best authorities in the land, and then perfectly reproduced by Mr. Edison's Gold Mould process. No wonder dealers that handle "Double Service" increase their sales 30 per cent. Are YOU selling I. C. S. Language Records? If not, send 50 cents for complete selling outfit.

Call Address "Edison, New York!"

*From the Laboratory
of
Thomas A. Edison*

Subject, Languages

Orange, N.J.

March 15, 1905.

International Correspondence Schools,
Scranton, Pa.

Gentlemen:

In your efforts to secure a perfect language record for instruction purposes, I am pleased to state that the master phonograph records, approved by authorities and submitted to me, will be reproduced at the laboratory by my Gold Mould Process, which insures an accurate and unchangable product for any number of duplicates, virtually placing the language in a standard form. Furthermore, these special records will reproduce the human voice in the most perfect and natural manner.

Yours sincerely,

Thomas A. Edison

International Correspondence Schools

Box 920, SCRANTON, PA.

For Foreign Sales, Address } Foreign Dep't. National Phonograph Co., New York City
European Headquarters, National Phono. Co., Ltd., London

EDISON Phonograph Monthly

PUBLISHED FOR TRADE USE ONLY BY
THE NATIONAL PHONOGRAPH CO.

VOL. III. ORANGE, N. J., FEBRUARY, 1906. No. 12.

NATIONAL PHONOGRAPH CO.

ORANGE, N. J.

NEW YORK: 31 UNION SQUARE.

CHICAGO: 304 WABASH AVENUE.

340 KENT STREET, SYDNEY, N. S. W.

CALLE PROLONGACION DEL 5 DE MAYO, NO. 67-77,
MEXICO CITY.

NATIONAL PHONOGRAPH CO., LTD., 25 CLERKENWELL
ROAD, LONDON, ENG.

EDISON PHONOGRAPHS AND RECORDS.

All communications to THE PHONOGRAPH MONTHLY
should be addressed to the Advertising Department,
Orange, N. J.

C O N T E N T S

The Trade Situation.....	1
Advance List of March Records.....	2
Grand Opera Records a Great Success....	3
The Advertising Record.....	3
Printed Matter	4
Reduced Freight Rates Secured.....	4
Jobbers Advance Orders must be Mailed by the Tenth	5
Salesmen Changes	5
Record Music Publishers.....	6
No. 12338 Cut Out	6
A Striking Oil Painting.....	6
Give the Older Titles a Show.....	6
Not a Violation of Contract.....	7
Paris Recording Plant Destroyed by Fire..	7
A Muslin Poster	7
Comments on Edison Gold Moulded Rec- ords for March	8
Visiting Jobbers	10
Please Report, Anyway.....	10
Advertise the Cut-Outs	10
English Edition of Edison Phonograph Monthly	10
New York State Instalment Form.....	11
Among the Jobbers.....	11
Not Needed on the Triumph.....	11
This Will Interest All Dealers.....	12
Dealer's View of Instalment Business....	12
Jobbers of Edison Phonographs and Records	14
Suspended List, February, 1906.....	15
How to Enjoy the Phonograph.....	16
The Phonograph as An Assistant Salesman	16

THE TRADE SITUATION.

Just as much as ever the slogan of the Edison trade continues to be: "Give us goods." The four weeks that have elapsed since the holiday season have brought no change in the situation. The demand for Phonographs seems quite as great as it was on December 1st, and the tremendous weekly output of our factory seems to make but small progress in cutting down the number of unfilled orders constantly on hand. The new year brought no cancellations of any account, the few that did come in having no effect upon the situation. Anyone who doubts the rapidly growing popularity of the Edison Phonograph and Edison Gold Moulded Records should see the correspondence received by our Sales Department from all parts of the country,— all complaining of the difficulty of getting Edison goods fast enough to meet the demands of the public. What seem like ample orders when made out and forwarded prove inadequate when the goods are received. This is quite as true of Records as of machines. On January 1st, by unusual effort, we got the Record situation well in hand and were congratulating ourselves upon the promptness with which we were filling orders, when the Jobbers finished their annual or semi-annual inventories and again began to fill up their shelves and bins. This brought an aggregate of orders in a week that, to use a slang phrase, "put us to the bad" before we were aware of it, and again caused a delay in filling Record orders until we could, pugilistically speaking, "get our wind." At this date we are gaining on orders and hope to make more prompt shipments ere long.

While not yet out of the tall timber we want to say a word or two about the coming months of 1906. Steps are already being taken to prevent a duplication of last fall's trade conditions. It seems certain that with our present output of machines and Records we must in another six weeks or two months be practically

(Continued on page 3.)

THE ADVANCE LIST OF MARCH RECORDS APPEARS ON PAGE 2.

NEW EDISON GOLD MOULDED RECORDS. ADVANCE LIST FOR MARCH, 1906.

RECORDS listed below will be ready for shipment as near March 1st as possible, at which time Jobbers' stock orders, if received prior to February 10th, will be shipped. March Supplements will be forwarded to Jobbers with their stock orders for Records. Retail Dealers should place stock orders with their Jobbers at once, to insure prompt shipment as soon as Jobbers' stock is received.

- | | | |
|------|--|---------------------------|
| 9218 | Gleaming Star (<i>Hager</i>) | Edison Concert Band |
| | <i>A Novelette Intermezzo by the Composer of "Laughing Water."</i> | |
| 9219 | Dreaming Love of You (<i>Harris</i>) | Harry Anthony |
| | <i>Charles K. Harris' new sentimental song, Orch. accom.</i> | |
| 9220 | L-A-Z-Y Spells Lazy (<i>Wallace</i>) | Collins and Harlan |
| | <i>Coon male duet, Orch. accom.</i> | |
| 9221 | Uncle Josh Weathersby in a Department Store | Andrew Keefe |
| | <i>The same old story entertainingly retold.</i> | |
| 9222 | Just a Little Rocking Chair and You (<i>Morse</i>) | Ada Jones |
| | <i>New song by the composer of "Keep a Little Cosey Corner in Your Heart for Me," Orch. accom.</i> | |
| 9223 | Hebrew Vaudeville Specialty (<i>Original</i>) | Julian Rose |
| | <i>Hebrew Monologue, introducing parody on "Then I'd be Satisfied with Life," Orch. accom.</i> | |
| 9224 | Some One Thinks of Some One (<i>Helf</i>) | Irving Gillette |
| | <i>Sentimental waltz song by the composer of "Mamma's Boy," Orch. accom.</i> | |
| 9225 | 10th Regiment March (<i>Hall</i>) | Edison Military Band |
| | <i>By the composer of "The New Colonial" March.</i> | |
| 9226 | Answer (<i>Robyn</i>) | Marie Narelle |
| | <i>The old standard ballad sung by Soprano, Orch. accom.</i> | |
| 9227 | My Name is Morgan, but it ain't J. P. (<i>Mohr</i>) | Bob Roberts |
| | <i>Coon song, Orch. accom.</i> | |
| 9228 | I Love to Tell the Story (<i>Fischer</i>) | Anthony and Harrison |
| | <i>Sacred male duet, Orch. accom.</i> | |
| 9229 | Sweet Smiles (<i>Laurendeau</i>) | Albert Benzler |
| | <i>Bells solo, Orch. accom.</i> | |
| 9230 | I Lost My Heart 'way Down in Alabama (<i>Petrie</i>) | Harry MacDonough |
| | <i>Sentimental song, Orch, accom.</i> | |
| 9231 | Forty-five Minutes from Broadway (<i>Cohan</i>) | Billy Murray |
| | <i>Comic song from the musical play "Forty-five Minutes from Broadway," Orch. accom.</i> | |
| 9232 | I Long to See You Once Again (<i>Winternitz</i>) | Harlan and Stanley |
| | <i>Descriptive song, Orch. accom.</i> | |
| 9233 | Razzazza Mazzazza (<i>Pryor</i>) | Edison Concert Band |
| | <i>By the composer of "The Whistler and His Dog."</i> | |
| 9234 | What's the Use of Knocking (when a Man is Down) (<i>Edwards</i>) | Edward Meeker |
| | <i>Coon song, Orch. accom.</i> | |
| 9235 | Once Upon a Time (<i>Edwards</i>) | Byron G. Harlan |
| | <i>Descriptive song, Orch. accom.</i> | |
| 9236 | Mandy and Her Man (<i>Original</i>) | Ada Jones and Len Spencer |
| | <i>Vaudeville sketch with Orchestra incidental music and introducing the coon song "On Yo' Way" (Allen).</i> | |
| 9237 | Waltz of the Roses—Air de Ballet (<i>Ecke</i>) | Edison Symphony Orchestra |
| | <i>Composed especially for our Record, introducing a solo for Oboe.</i> | |
| 9238 | Sister (<i>Vaughan</i>) | Frank C. Stanley |
| | <i>March song introducing descriptive effects, Orch. accom.</i> | |
| 9239 | Pretty Desdamone (<i>Wildman</i>) | Arthur Collins |
| | <i>Coon love song as sung by Williams and Walker, Orch. accom.</i> | |
| 9240 | Only a Message from Home, Sweet Home (<i>Florant</i>) | Edison Male Quartette |
| | <i>Descriptive song, Orch. accom.</i> | |
| 9241 | The Dixie Rube (<i>Allen</i>) | Edison Military Band |
| | <i>With descriptive effects.</i> | |

Edison Gold Moulded Records are made only in Standard Size. Both Standard and Concert Records may be ordered from this list. Order by number, not title. If Concert Records are wanted, give the number and letter C.

(Continued from Page 1.)

caught up and be in a position to stay so until plans, now under consideration, can become effective. The immense three-story concrete building recently finished will be fully occupied, other buildings will be erected and existing ones enlarged until it is possible to increase the output twenty-five per cent. Instead of cutting down the output during the more quiet summer months the factory will be operated with its full force and the surplus of output over shipments will be held in reserve for the fall. These plans will, we are sure, make it possible to meet every demand of the trade throughout the year. We have figured that our inability to manufacture enough Phonographs to fill orders caused us a loss of many thousands of dollars, with a corresponding enrichment of our competitors, whose machines were bought because ours could not be had, and we are determined that we will not again suffer such a loss.

GRAND OPERA RECORDS A GREAT SUCCESS.

The National Phonograph Co. entered upon the task of securing the services of the necessary artists and making a series of grand opera Records with a feeling of no little uncertainty as to its commercial success. People with the ability to make good Phonograph Records always command good salaries but to pay thousands of dollars for a few Records by grand opera artists of world-wide reputation was a new experience. It was also a new experience to ask seventy-five cents each for Records when our regular product was being sold for thirty-five cents. But the evolution of the Edison Record had brought it to a point where its naturalness would do justice to the voices of great singers and the work was carried out without regard to expense.

When the announcement and samples of the first ten Records were sent out to the trade many estimates were made by the officials of the company as to the total of the advance orders that would be received from the Jobbers. The sample Records had been out but a few days when we began to get congratulatory letters from enthusiastic Jobbers, all commenting in terms of the highest praise upon the remarkable naturalness and artistic character of the Records. They were declared to be far in advance of anything of the kind ever before placed before the public and to mark an epoch in the history of reproduced sound. The Jobbers later backed their encomiums with orders of surprising size, the aggregate of which was nearly double the highest advance estimate of any official of the company.

We naturally feel much elated over the pronounced success of the first series. It is gratifying to have our work and our own judgment as to its merit so emphatically approved by the Jobbers and to a certain extent by Dealers.

These ten grand opera Records are now in the hands of the trade and in a few days will be passed upon by the most critical jury in the world—the American public. We have no misgivings as to the verdict that it will render. We feel too confident concerning their quality to expect anything but enthusiastic approval. We are confident that these new Records will not only please present owners of Edison Phonographs but attract to the Edison standard many whose musical tastes have kept them from buying because our catalogues have not until now contained high class compositions sung by artists of the highest rank. Of the eight artists represented by our first list, Messrs. Scotti, Knoté, Van Rooy, Dippel and Resky are now singing leading roles at the Metropolitan Opera House, New York, and to question their ability is to doubt Mr. Conried's reputation as the great operatic director of his time.

One other reason for our confidence in the success of these grand opera Records is the manner that Jobbers have placed advance orders. Experience has shown us that a few Jobbers may err in making up their advance orders, but taken as a whole they make few mistakes. We have found that the selections they order in the largest quantities prove to be the most popular with the public.

Because many Jobbers and Dealers have gained the impression that additional grand opera Records would be issued each month, we want to state that, for a time at least, new ones will not be put out more frequently than once in three months. The next supplement will be dated May 1. An advance list will be sent out after March 15th and samples will follow the latter part of the month, probably with the May samples.

THE ADVERTISING RECORD.

The Advertising Record has been voted a great success by the trade and many letters in its praise have been received. In fact, the Record is so attractive that many Dealers report having been offered fancy prices if they would sell the one they had. Of course, Dealers must not dispose of them to the public. There have been so many requests for the Record outside of the trade that we may make it over, eliminating the last sentence "Ask the Dealer," give it a number and title and put it into the regular catalogue as a talking Record.

PRINTED MATTER.

A new Phonograph Catalogue, Form No. 805, and a new Catalogue of Domestic Records, Form No. 840, are being mailed to the trade with this issue of the PHONOGRAPH MONTHLY. The Phonograph catalogue has been in use some time, but until now has not been mailed to the trade. The Record catalogue contains all Domestic Records to and including February.

The new Numerical Catalogue, Form No. 820, has at last been mailed to Jobbers and Dealers, five copies going to each Jobber and one to each Dealer. Jobbers will be supplied with extra copies for new Dealers or to supply such Dealers as may need extra ones. It must be borne in mind that this catalogue is for trade use only and must not be supplied to the public. Nor should copies be used as order blanks. It is expected to issue a new edition of the Numerical Catalogue every six months.

With the February Record supplement, bulletin, etc., we are mailing copies of the grand opera supplement. This is handsomely printed in two colors, and besides an announcement concerning the Records, it gives a description of each selection.

A quantity of hangers, showing the pictures of the artists who made the Grand Opera Records, and a list of the selections, is being shipped to all Jobbers. Dealers who will carry Grand Opera Records in stock can get one of these hangers from their Jobbers. Dealers who may have decided not to put in Grand Opera Records may find it advisable to change their minds and order some. The printed matter gotten out for these Records should make it easy to sell them.

Dealers who have ordered Grand Opera Records should see that a grand opera supplement is sent to every Phonograph owner. A little effort in this way will result in a nice business in these Records.

We have just gotten out an interesting and attractive hanger illustrating "The Evolution of the Edison Phonograph from a Crude Talking Machine to a Delightful Musical Instrument." It shows pictures of the original Phonograph made in 1877, the Phonograph of 1887 and the present Triumph Phonograph, with a photograph of Mr. Edison in the horn of the latter. It is 17x24 inches in size, is printed in several colors and is mounted with metal strips for hanging. A supply of these hangers are being shipped to all Jobbers for the purpose of supplying their Dealers. It is not being mailed.

The calendar mailed to the trade in January was printed for trade use only and the edition was only sufficient for this purpose. It cannot be supplied to Jobbers or Dealers in quantities on any basis.

REDUCED FREIGHT RATES SECURED.

Thanks to the efforts of George M. Nisbett, manager of our Chicago office, and F. A. Voullaire, Traffic Manager for our company, with headquarters at Orange, the Western Classification Committee, representing the various railroads throughout the United States, on January 19th, reduced the classification on Phonographs and Records from one and a half times first class to first class in less than carload lots and to third class in carload lots; effective March 1, 1906. Although Messrs. Nisbett and Voullaire secured the reduction unaided, it will benefit all talking machine companies. Mr. Nisbett sends the following account of their trip:

The members of the Western Classification Committee assembled at Kansas City on Friday, January 13, and left on a special train at 2 P. M. for Los Angeles, via Missouri Pacific to Pueblo, Colo., Denver & Rio Grande to Colorado Springs, Colorado Midland to Grand Junction, D. & R. G. W. to Salt Lake, and San Pedro, Los Angeles and Salt Lake Route to Los Angeles. The train consisted of three Pullmans, a dining car, observation car and baggage car. The trip was most enjoyable from every point of view, scenic and otherwise. On Sunday we were detained over twelve hours in the mountains near Tucker, Utah, owing to a freight wreck, but the time passed pleasantly, owing to my having with me a Home Phonograph and a collection of thirty-six Records. Every selection played brought innumerable encores, and each Record was voted by acclamation to be the "best ever." We reached Salt Lake at midnight on Sunday and left again on the last stage of our journey at 2.20 A. M. Monday, arriving at Los Angeles on Tuesday, the 16th, at 2 A. M. Those on the train were as follows: H. E. Pierpont, A. G. F. A., C. M. & St. P. Ry.; E. J. Seymour, A. G. F. A., C. & N. W. Ry.; J. S. Gorman, G. F. A., A., T. & S. Fe Ry.; H. E. Still, G. F. A., Gt. Nor. Ry.; J. C. Lincoln, A. G. F. A., Missouri Pac. Ry.; E. E. Wood, G. F. A., Union Pac. Ry.; W. W. Broughton, G. F. A., Nor. Pac. Ry.; Fred Wild, Jr., G. F. A., Denver & Rio Grande; George M. Sargent, A. G. F. A., San Pedro, Los Angeles & Salt Lake Ry.; F. H. Tibbitts, A. G. F. A., Chicago Great Western Ry.; C. E. Wilson, A. G. F. A., Wisconsin Central Ry.; John T. Bowe, Agt. Colo. Southern; W. G. Neimyer, So. Pac.; H. Snyder, C. R. I. & P. Ry.; G. L. Crosby, C. B. & Q. Ry.; R. B. Miller, O. R. & Nav. Co.; J. C. Groseclose, M. K. & T. Ry.; J. Lund, Wabash; F. O. Becker, chairman West. Class. Com.; F. W. Meadows, Sec'y West. Class. Com.; George M. Nisbett, Western Manager, National Phonograph Co.; F. A. Voullaire, Traffic Department, Nat. Phono. Co., Orange, N. J. The presence of the wives of a great many of the degelates added zest and enjoyment to the trip.

Messrs. Nisbett and Voullaire appeared before the committee on Wednesday afternoon and argued for a reduction in the classification on Phonographs and Phonograph Records, from one and a half times first class to first

class in carload lots and third class in carload lots. No decision was reached until Thursday evening when the committee announced that our petition had been granted, the reduction to become effective on March 1, 1906. The novelty of the entire meeting and the thing that made the biggest hit was that the Phonograph itself made part of the plea before the committee. A Home Phonograph was used and two standard blanks which had been dictated to a few minutes before the meeting.

JOBBER ADVANCE ORDERS MUST BE MAILED BY THE TENTH.

The continued practice, month after month, of some Jobbers in not sending their advance orders for new Records until after the 10th of the month, notwithstanding various appeals from the Sales Department, led to the issuance, on December 30th, of the letter given below, signed by Mr. Gilmore, President of this Company. This letter was mailed to every Jobber.

NEW YORK, December 30, 1905.

DEAR SIR:—

Our sales department has several times written all Jobbers relative to stock orders for advance Records being sent us by the 10th of the month following receipt of samples. Some Jobbers, however, have not complied with requests made in this matter, but on the contrary continue sending their orders anywhere from the 11th to the 16th of the month. This has, no doubt, been due to carelessness or an oversight on their part; nevertheless, it interferes very materially with our getting the new Records out in time to ship before the 1st of the month. As orders for the new monthly Records are constantly increasing, the question of manufacturing a sufficient quantity to allow shipments to be made before the 1st of each month has grown to be a very serious one, and the only way we can possibly continue to do so, is by receiving the Jobbers' orders promptly and on time.

We are, therefore, again compelled to advise that unless stock orders for newly listed Records are MAILED US ON OR BEFORE THE 10TH OF EACH MONTH they will not be entered as first orders, and the orders that are MAILED US ON OR BEFORE THE 10TH, will be given preference and shipped first. Orders mailed subsequent to the 10th will be considered as second orders and will be filled in rotation as received, after all of the first orders have been shipped.

As the question of your receiving new Records at the same time other Jobbers do, is a very important one, we trust you will give this matter your personal attention and that your order will be mailed us on time; that is, not later than the 10th of each month.

Yours very truly,

W. E. GILMORE, President.

Advance orders for February Records will be filled in accordance with the statements made in this letter. A number of Jobbers paid no more attention to the letter than in the previous requests, but mailed their orders some days after January 10th. If conditions make it possible to fill their orders and ship with those of other Jobbers it will be done. If not, then they will follow as soon as possible thereafter. For one Jobber in a city to get his new Records some days after his competitor is going to cause unpleasantness, but we think that the tardy Jobber will have only himself to blame.

In endeavoring to get all Jobbers to mail advance orders on or before the 10th of each

month, we have no desire to be arbitrary. On the contrary, we are only seeking to serve the trade in a proper manner. The extent of the demand for the monthly supplements leaves no other course open. The total of the advance orders is more than double what it was a year ago, and is constantly increasing. It has reached a total that cannot be made in time for shipment by the last of the month, unless Jobbers will co-operate by getting orders in on time. Jobbers will serve their own interests by giving us this co-operation.

SALESMEN CHANGES.

A number of changes have taken place in our force of salesmen during the past two months. C. S. Gardner, who travelled in Pennsylvania and Ohio, resigned in December and his territory is now being covered by F. J. Smith, of Newark, N. J. Frank E. Madison, who represented the company in Delaware, District of Columbia, Maryland, Virginia, West Virginia, North Carolina, Tennessee and Kentucky, has been transferred to the New York office and placed in charge of the Agreement Department. A new man will shortly be placed in his territory. H. K. Miller, formerly a retail Edison Dealer at Lacona, N. Y., has been assigned to the Pacific Coast States, under the direction of the Chicago office. H. A. Turner, at one time manager of the Ray Company branches, will cover Texas, Louisiana and Arkansas. J. W. Scott, our New England traveller, has had Connecticut added to his territory.

THE PHONOGRAM.

Dealers desiring to get a supply of *Phonograms* to mail to their customers must order them of Jobbers four weeks in advance, and we cannot agree to fill Jobber's orders unless placed with us a similar period in advance. Following is a schedule of prices at which *Phonograms* may be obtained by the trade:

DELIVERED WITH GOODS.

Blank, per 1,000 copies\$2.50

Smaller quantities pro rata.

25 cents additional for imprinting with Dealer's name and address, without regard to quantity. No orders filled for less than 500 copies requiring imprint, and all imprinting orders must be for multiples of 500.

Jobbers will be glad to supply Dealers on the above basis.

BY MAIL.

Single copies, per year\$.20
Five copies to one address, per year..... .40
Twenty-five copies to one address, per year..... 1.80
Fifty copies to one address, per year..... 3.60

Unless they have open accounts on our books, Dealers ordering *Phonograms* sent by mail are requested to send cash or stamps with their orders. The amounts are too small to handle in any other way.

RECORD MUSIC PUBLISHERS.

Because of a desire on the part of some Dealers to know in advance the names of music publishers whose compositions are represented in our monthly list of new Records, we have decided to return to the plan of printing the names of publishers a month in advance. Consequently the February and March list is given below. It is as complete as we can make it. Where a publisher is not given we either do not know his name or the selection is not published.

FEBRUARY.

- 9194 Caprice Militaire, Oliver Ditson Co., Boston.
 9195 Henny Klein, Jerome H. Remick & Co., New York.
 9196 I'm a-Dreaming of You, P. J. Howley, New York.
 9198 Will You Love Me in December as You Do in May? M. Witmark & Son, New York.
 9200 It's a Good World, After All M. Witmark & Son, New York.
 9201 The Blue Jackets March Oliver Ditson, Boston.
 9202 Daddy's Little Girl F. B. Haviland, New York.
 9203 College Life March, F. B. Haviland Pub. Co., New York.
 9204 Lazy Moon, Jos. Stern & Co., New York.
 9206 'Neath the Spreading Chestnut Tree, Sol Bloom, New York.
 9207 Believe Me if All those Endearing Young Charms, Oliver Ditson Co., Boston.
 9208 Pocahontas Gus Edwards Music Pub. Co., New York.
 9209 Titania, Harry Coleman, Philadelphia.
 9210 Is Everybody Happy? C. K. Harris, New York.
 9211 Robinson Crusoe's Isle, Jos. W. Stern & Co., New York.
 9212 My Mother's Old Red Shawl, T. B. Harms & Co., New York.
 9213 The Chaser March. Albright Music Co., Chicago.
 9216 The Song of the Steeple, C. H. Ditson & Co., New York.
 9217 Silver Heels, Jerome H. Remick & Co., New York.

MARCH.

- 9218 Gleaming Star, Helf & Hager, New York City.
 9219 Dreaming Love of You, Chas. K. Harris, New York City.
 9220 L-A-Z-Y Spells Lazy, F. B. Haviland Pub. Co., New York City.
 9222 Just a Little Rocking Chair and You, F. B. Haviland Co., New York.
 9224 Some One Thinks of Some One, Helf & Hager, New York City.
 9225 10th Regiment March, Harry Coleman, Phila.
 9226 Answer, Balmer-Weber Music House, St. Louis, Mo.
 9227 My Name is Morgan, but it Ain't J. P., P. J. Howley, New York.
 9229 Sweet Smiles, Carl Fischer, New York City.
 9230 I Lost My Heart 'Way Down in Alabama, Jos. W. Stern & Co., New York City.
 9231 Forty-five Minutes from Broadway, F. A. Mills, New York.
 9232 I Long to See You Once Again, Leo Feist, New York.
 9233 Razzazza Mazzazza, Carl Fischer, New York.
 9234 What's the Use of Knocking (When a Man is Down) Vincent Bryan Music Co., New York.
 9235 Once Upon a Time, Vincent Bryan Music Co., New York.
 9238 Sister, Chas. K. Harris, New York City.
 9239 Pretty Desdamone, Attucks Music Co., New York City.
 9240 Only a Message from Home, Sweet Home, M. Witmark & Son, New York.
 9241 The Dixie Rube, Walter Jacobs, Boston, Mass.

NUMBER 12338 CUT OUT.

The trade is hereby advised that we have no more moulds or masters of foreign selection No. 12338, "Verses Margot" (French), by Bartel, and after our present stock of this selection is exhausted it will be considered as a cut-out selection.

A STRIKING OIL PAINTING.

A calendar for 1906 was mailed to the entire trade early in January. Its principal feature was a reproduction by the three-color process of an oil painting of an old couple listening in delighted amazement to an Edison Phonograph for the first time. The original of this picture was painted by Massani, a noted Italian painter. It was imported a year ago by William Johnson, then of Fifth avenue, New York city. Its first public exhibition in this country was at the Chalfonte Hotel, Atlantic City, where Mr. Johnson had an extensive exhibit of paintings, and where it was priced at \$1,050. It was there bought by the National Phonograph Co. It is now being reproduced in a handsome and life-like manner in fourteen colors of lithography, and copies will later be distributed to the trade. This reproduction will be the full size of the original painting, 17 x 25 inches. It will be worth a place in any home. Other uses of the painting will follow. The subject is universally regarded as one of the most striking ever put out in connection with a talking machine.

GIVE THE OLDER TITLES A BETTER SHOW.

Too many Dealers and too many of their salesmen are making the mistake of playing only the latest Records issued when the purchaser of a Phonograph is endeavoring for the first time to make up a selection of suitable Records. To the salesman who has heard all of the older numbers it is quite natural that the new list is the most attractive, and a purchaser who makes up his selection from them gets a lot of well-made and varied selections. On the other hand, the older numbers include hundreds of desirable selections, many of which would be preferred by the purchaser if he knew that they could be had. Many a Dealer carries on his shelves for months excellent Records from every standpoint and Records that would find a ready sale, simply because it does not occur to him to play them for customers. In this way he puts down many Records as being slow sellers when really they are only slow because he does not give them the same chance that he does the later titles. Then, too, many Dealers would be able to dispose of many of their apparently slow selling Records, if they would make more of an effort to put them forward and play the later ones only when asked for. Every Dealer should make an inventory of his stock at intervals to ascertain how many of the apparently slow sellers he has on hand and play these frequently. He will be surprised to find how many of them he can sell.

OFFERED \$14.00 FOR STANDARDS.

As showing the eagerness of the public to get Edison Phonographs during the holiday season, a large Chicago house offered Jobbers \$14.00 for Standard machines.

NOT A VIOLATION OF CONTRACT.

Quite a number of Jobbers and Dealers have written within the past two or three months asking if it was not a violation of contract for firms selling Phonographs on the mail order plan to prepay or allow transportation charges on their sales. In order that this matter may be understood by the entire trade and full opportunity be given all Jobbers and Dealers to sell goods outside of their own cities, we desire to say that it is entirely permissible to prepay or allow transportation charges, provided goods are sold at full list prices. When a Phonograph is bought from a Dealer at a distant point and charges are prepaid or allowed on its delivery, the purchaser does not get it at any less price than he would pay if he bought it from a local Dealer. Therefore, the distant Dealer is gaining no advantage over the local one. In most cases where individuals are induced to buy a Phonograph from a distant point it is either because the local Dealer does not carry a sufficient stock to properly supply the wants of the individual or the Dealer's terms of sale are not satisfactory. Of course, in rare instances, there may also be some personal reasons. The great success of the mail order business in most lines is due to the fact that the firms in the large cities really sell goods cheaper than a local dealer. Such a condition does not obtain with the Edison Phonograph or with Edison Records, since they are sold at precisely the same prices everywhere. Many small Dealers do not sell Phonographs on the instalment plan and are, therefore, placed at a

disadvantage by the city firm which will sell on easy terms. If local Dealers would carry an adequate stock of Phonographs and Records and would sell machines on the instalment plan, they would be able to control all the sales in their territory, provided, of course, that they took reasonable means to make it known that they were in business. The clause in our contract preventing Jobbers from allowing transportation charges on goods applies only to the trade to whom goods are sold at a discount. So far as this Company is concerned, we can see no reason why a Dealer should not deliver goods, ten, fifty or one hundred miles away from his store just as he delivers them a shorter distance, provided he is willing to stand the expense. Such a delivery cannot in any way be construed as cutting prices. Dealers who feel that their territory is being trespassed upon by others have the remedy entirely in their own hands, and will be able to retain all the local business if they take the same steps to secure it that outside firms do.

PARIS RECORDING PLANT DESTROYED BY FIRE.

The Paris recording plant of the National Phonograph Co. was totally destroyed by fire on the night of December 28th. Fortunately, we were able to continue the manufacture of French Records at our Brussels plant, and the fire caused little inconvenience to the trade in France. Steps have been taken to secure a new location and purchase the necessary machinery to continue the manufacture of Records in Paris.

**A MUSLIN POSTER.**

The above cut illustrates a muslin poster in three colors, 24x48 inches in size, of which we have had a quantity made for the use of Dealers to hang up in front of their stores, on the side of their store buildings or on the inside

walls. They are made of extra heavy muslin and the manufacturers guarantee that the colors will stand the elements for a long time. One of them will be mailed to any Dealer in good standing upon request. They will *not* be supplied in quantities for billboard work.

EDISON GOLD MOULDED RECORDS FOR MARCH, 1906.

The twenty-four Records in the March list may be had anywhere in the United States for \$8.40 and no other similar expenditure in the whole wide world can buy such a variety of amusement and pleasure. Twenty years ago twenty-four Records like these could not be had at any price. How many Phonograph owners to-day appreciate what labor, time and money has been expended to bring Edison Gold Moulded Records to their present degree of perfection.

No. 9218, "Gleaming Star," by the Edison Concert Band, is called a novelette intermezzo by its composer, Frederick W. Hager. Mr. Hager is also the composer of "Laughing Water" (our Record No. 8532) which proved to be a great instrumental success. He expects that his latest composition will be equally as popular and, judging from the Record we have made of it, he and the public will not be disappointed.

No. 9219, "Dreaming Love of You," by Harry Anthony, is Charles K. Harris' newest sentimental ballad. Like most of Mr. Harris' songs, it has jumped quickly into popularity. As a Phonograph Record it will become just as popular, attributable as much to Mr. Anthony's artistic rendering as to the piece itself. Made with orchestra accompaniment.

No. 9220, "L-A-Z-Y spells Lazy," by Collins and Harlan, is a very catchy coon song, written and composed by Miss Cecilia Warfel and Ramsay Wallace. It is cleverly sung by Collins and Harlan with orchestra accompaniment. The chorus is rendered something after the manner of "I'm a-Dreaming of You" (our Record No. 9196) with a sort of double melody effect. Both melodies and words can be distinctly heard. It makes a very fine Record and will prove to be decidedly popular.

No. 9221, "Uncle Josh Weathersby in a Department Store," by Andrew Keefe, is a selection that was cut from our catalogue some time ago after long popularity with the public. In response to numerous requests we have decided to re-list it. The Record is now made by Andrew Keefe, whose clear speaking voice and artistic conception of the famous character of "Uncle Josh" will doubtless revive the interest in the series, the best of which will be re-listed from time to time.

No. 9222, "Just a Little Rocking Chair and You," sung by Ada Jones, is a composition by Fitzgibbon and Drislane (words) and Theodore Morse (music). It is a song that is already on the high road to popularity. It is something on the order of "Keep a Little Cosey Corner in Your Heart for Me" (our Record No. 9060) and by the same writers and also sung by Miss Jones with orchestra accompaniment.

No. 9223, "Hebrew Vaudeville Specialty," by Julian Rose, is another clever vaudeville specialty by Mr. Rose and it gives an original monologue in Hebrew dialect, introducing a parody on "Then I'd be Satisfied with Life," which Mr. Rose sings with orchestra accompaniment.

The Record is a "scream" from beginning to end. Many will decide it to be the artist's most entertaining number.

No. 9224, "Some One Thinks of Some One," by Irving Gillette, is a beautiful ballad in waltz tempo, written by J. Fred Helf, composer of "Mamma's Boy" and other popular songs. Ed. Gardenier is responsible for the well written verses. Irving Gillette sings the song for our Record in his customary artistic manner, and is accompanied by the orchestra. Mr. Gillette will add much to the favor in which he is held as a result of his work on this selection.

No. 9225, "10th Regiment March," by Edison Military Band is a bright, snappy march by R. B. Hall, and rendered in the usual admirable style of our Military Band. Mr. Hall also wrote "The New Colonial" March, (our Record No. 8587). This new composition has all the elements of success of the former selection.

No. 9226, "Answer," by Miss Marie Narelle, this is another old ballad, too well known to need description here. Suffice it to say that Miss Narelle, who sings it with orchestra accompaniment, does it to perfection and we think we have never made a better Record of this talented artist. The music to "Answer" was written by Alfred G. Robyn.

No. 9227, "My Name is Morgan, but It Ain't J. P.," by Bob Roberts, is a coon song by Will A. Mahoney (words) and Halsey K. Mohr (music), which tells of a coon by the name of William Morgan, whose girl's extravagant tastes drove him into bankruptcy and to whom he was constantly compelled to remind that his name was Morgan, but not J. P. This song is accompanied by orchestra which furnishes a fine background for a catchy tuneful and appropriate melody.

No. 9228, "I Love to Tell the Story," by Anthony and Harrison, is another of the series of sacred male duets that are being made by Messrs. Anthony and Harrison, which are among the most successful numbers on our monthly list. "I Love to Tell the Story," composed by W. G. Fischer, is no exception to the rule. Particular attention is called to the marked religious fervor employed by these artists in their exceptionally fine rendition of this selection. The orchestra accompaniment is an effective feature of the Record.

No. 9229, "Sweet Smiles," by Albert Benzler, is a bells solo with orchestra accompaniment. The selection was composed by L. P. Laurendeau and the Record is one of the best of Mr. Benzler's attractive solos. It is exceptionally tuneful and being in scottische tempo, or song and dance movement, has a fine swing to it. The bell tones ring out nice and clear and the orchestra accompaniment is artistically featured.

No. 9230, "I Lost My Heart 'way Down in Alabama," is sung by Harry MacDonough, who makes much of this very pretty sentimental ballad, the words of which were written by Rene Browner and the music by H. W. Petrie, and we think it one of the best Records that Mr. MacDonough has made in some time. Mr. Petrie will be remembered as the com-

poser of "When the Sunset Turns the Ocean's Blue to Gold," (our Record No. 8645). The Record is made with orchestra accompaniment.

No. 9231, "Forty-five Minutes from Broadway," by Billy Murray, is one of the leading successes in George M. Cohan's new musical play, "Forty-five Minutes from Broadway." Mr. Murray's success with songs of this character is proverbial. He was accompanied by the orchestra when making the Record. Mr. Cohan also composed "The Yankee Doodle Boy," (our Record No. 8910), which was also sung by Mr. Murray.

No. 9232, "I Long to See You Once Again," by Harlan and Stanley, is one of the descriptive and sentimental male duets made for our Records by Harlan and Stanley, which always meet with a popular reception, "I Long to See You Once Again" is a descriptive song, telling of the "rustic home down by the valley stream," and "the porch, the old arm chair, the mother sitting there." The pretty story is set to a beautiful melody of a kind that one never tires of. The music and words of this song are by Richard Winternitz and the Record is made with orchestra accompaniment.

No. 9233, "Razzazza Mazzazza," by Edison Concert Band, is a composition by Arthur Pryor, composer of "The Whistler and His Dog" (our Record No. 9107). It was, like the latter, one of the most successful numbers played by Mr. Pryor and his band during their successful season at Asbury Park last summer. Thousands of patrons of that resort will recall the applause that greeted it every time it was played. This composition again demonstrates Mr. Pryor's success in writing strikingly odd band numbers. Those not familiar with the selection must hear it to understand and appreciate it.

No. 9234, "What's the Use of Knocking (when a man is down)?" by Edward Meeker, is a coon song by Gus Edwards and Vincent Bryan, which serves to introduce a new artist in Mr. Meeker. That his first performance will gain for him many admirers seems assured, judging from this fine Record of his clear, strong voice, distinct articulation and natural delivery. The song is sufficiently well described in its title. It is already popular. It is sung with orchestra accompaniment.

No. 9235, "Once Upon a Time," by Byron G. Harlan, was written and composed by Vincent Bryan and Gus Edwards respectively, and is sung by Mr. Harlan, with orchestra accompaniment. Mr. Harlan's identification with songs of this character has been almost forced upon him by the public, which has always been prompt to show its appreciation of his conception of songs telling of the sadder things of life, such as "Please, Mr. Conductor," (our Record No. 7219) and "Always in The Way," (our Record No. 8501).

No. 9236, "Mandy and Her Man," by Ada Jones and Len Spencer, is an exceptionally well put together vaudeville coon sketch and shows Miss Jones and Mr. Spencer at their best. The characteristic dialogue and comic situations have never been excelled, which together with the singing and orchestra embellishments make this Record a great entertainer. The coon song, "On Yo' Way," sung

by Miss Jones, with orchestra accompaniment, is a feature of the Record.

No. 9237, "Waltz of the Roses," by the Edison Symphony Orchestra, was specially composed for our Record by Frederick W. Ecke, and is not yet published. The oboe is featured prominently, playing one of the principal melodies. It is a splendid composition, magnificently performed by our Edison Symphony Orchestra and will be a delight to the many Phonograph friends of this popular organization.

No. 9238, "Sister," by Frank C. Stanley, is a march song inspiration from Australia, from whence came "Daddy Dear," (our Record No. 8923). The story differs from the usual "good-bye" song in the respect that the fair recipient of the soldier's farewell is the sister instead of the sweetheart. The interest, however, survives the departure from the conventional and is added to by the effects introduced by our orchestra of the tramp of soldiers to the tune of "Tramp, Tramp the Boys are Marching," bugle calls and cheers. Mr. Stanley's well trained and robust, yet withal, sympathetic voice, has responded readily to the sentiment of the composition, which was written and composed by Allan M. Rattray and Clarence Vaughan, respectively, both of Sydney, Australia.

No. 9239, "Pretty Desdamone," by Arthur Collins, is a coon love song written and composed by F. Collis Wildman. Williams and Walker have made a great success with this clever song, responding nightly to encore after encore. Arthur Collins sings it with orchestra accompaniment. The Record will make it clear at once why the song has proved such a big entertainer with Williams and Walker, as well as why it is claimed that it will be just as big a Phonograph success.

No. 9240, "Only a Message from Home Sweet Home," by the Edison Male Quartette, is a descriptive ballad with words by Carroll Fleming and music by Edmund N. Florant. The song is fast becoming well known and in this quartette form it takes an added interest by reason of the story which describes a scene where is congregated a ship's crew and the receipt by "Jack," one of the members, of a "Message from Home, Sweet Home." Sung with orchestra accompaniment.

No. 9241, "The Dixie Rube," by the Edison Military Band, is a descriptive selection, the music for which was arranged by Thomas S. Allen. In the form here listed the selection was specially gotten up for our Record. The scene depicts a band room, the band just about to begin rehearsal. Silas Flatscales, a rube composer, enters and the band begins to play one of its newest pieces. Silas interrupts and requests that one of his own compositions be played. The band leader objects, saying that his piece is all mixed up, as "Dixie," "Annie Laurie" and "Yankee Doodle" are written to be played at one and the same time. Silas insists on hearing it, however. Silas' piece makes quite a hit, for you can readily make out the three different tunes, which when played together form a very harmonious whole. Byron G. Harlan plays the part of old Silas Flatscales and Edward Meeker the band leader.

VISITING JOBBERS.

The automobile shows last month brought to New York City a larger number of Jobbers than usual, many of them being interested in the business of selling automobiles. All of them took occasion to visit our New York office and some of them paid a visit to the factory at Orange. Following the custom that has prevailed for the past three years, the Company gave an informal dinner at Martin's, Broadway and 26th street, on the night of January 18th, to such of the visiting Jobbers as could be present. Covers were laid for nineteen. The guests of the Company were the following: W. D. Andrews, Syracuse, N. Y.; S. K. Hamburger, Harrisburg, Pa.; W. C. Finch, of Finch & Hahn, Schenectady, N. Y.; John N. Willys and W. O. Crew, of the Elmira Arms Co.; W. H. Hug, of Klein & Heffelman Co., Canton, O.; N. D. Griffin, of the American Phonograph Co., Gloversville, N. Y.; Messrs. Pardee, Ellenberger and Silliman, of the Pardee-Ellenberger Co., New Haven, Conn.; W. F. Carroll, of the Utica Cycle Co., Utica, N. Y.; P. A. Powers, Buffalo, N. Y., and C. V. Henkel, of the Douglas Phonograph Co., New York City. The Company was represented by C. H. Wilson, General Manager of Sales; F. K. Dolbeer, Manager of Credit Department; C. E. Stevens, Manager of Foreign Department; William Pelzer, of the Legal Department; A. C. Iretton, Assistant Sales Manager, and L. C. McChesney, Manager Advertising Department.

Other Jobbers in the city during automobile week and not able to attend the dinner were: J. W. Jenkins, of the J. W. Jenkins Sons Co., Kansas City, Mo.; Mr. Grinnell, of Grinnell Bros., Detroit, Mich.; H. M. Holleman, of the Texas Phonograph Co., Houston, Texas; Louis Buehn, of the Wells Phonograph Co., Philadelphia, Pa.; B. B. Crew, of the Philips & Crew Co., Atlanta, Ga.; Messrs. Osgood and Currier, of the C. E. Osgood Co., Boston, Mass.; G. L. Ackerman, of Ackerman & Co., Scranton, Pa.; Messrs. Linscott and Patton, of the Boston Cycle and Sundry Co., Boston, Mass., William Werner, Easton, Pa., and John Sykes, Trenton, N. J.

PLEASE REPORT, ANYWAY.

Dealers who receive retail inquiries from our Advertising Department are asked to report upon them in each case, even though they do not make a sale. A careful record is kept by us of each inquiry sent out, and in order to make the record complete, it is desirable to have a report from the Dealer, so that we may know that the inquirer is getting such attention as will make it possible to buy Phonographs or Records, should he be disposed to do so. Many Dealers have the impression that it is only necessary to report when a sale is made. We wish, therefore, that Dealers would reply to all inquiries sent them and as soon after their receipt as it is possible to make a definite statement.

ADVERTISE THE CUT-OUTS.

As announced in the December issue of the PHONOGRAPH MONTHLY, seventy-four titles will be eliminated from the Record Catalogue to be issued February 1st. Most of these cut-out numbers are quite as attractive as anything in the catalogue. Very few of them are not selling fully as well as most of the current numbers. They are being eliminated for no other reason than to keep down the total number to be handled by the trade. We are adding practically 300 new titles each year, and Jobbers and Dealers would be glad to have us eliminate an equal number from the catalogue. We found it quite impossible, however, to drop more than the seventy-four printed in the December PHONOGRAPH MONTHLY. The list could not be increased without a real sacrifice, both to the trade and ourselves, so largely do they still sell. Jobbers and Dealers who have a stock of these cut-out selections on hand would do well to print up a list of them and call the attention of their patrons especially to them. Many Phonograph owners would be glad to buy some of them if they knew that the opportunity to buy would soon be passed. A year ago, when we had a similar cut-out list, a Brooklyn Jobber printed a quantity of circulars giving the numbers and titles of those that he had on hand, and he reports that he disposed of a large number of them, some of his customers being glad of the opportunity to buy before the stock was exhausted. Other Dealers report that by printing circulars or advertising they can move their supply of any title of which they have a surplus on hand. We would ourselves be glad to get out a printed list of the cut-out titles for distribution to the trade were it not for the fact that few Dealers have a supply of the entire list and it would cause them trouble to advertise selections they did not have on hand and could not get by ordering. The matter can best be covered by each Dealer printing his own list and including in it only such titles as he has in stock.

ENGLISH EDITION OF PHONOGRAPH MONTHLY.

The National Phonograph Co., Ltd., with headquarters at London, has begun the publication of an English edition of the EDISON PHONOGRAPH MONTHLY. The first number was issued on December 1st. It is in charge of the Advertising Department connected with the London office. Both the first and second numbers are full of matter interesting to the trade in Great Britain. It is more pretentious in appearance than the American issue, having a colored cover and being printed on a better quality of paper. We believe that it will have an effect on Great Britain Factors and Dealers quite as beneficial to the Company as the American edition has had upon the trade here. A house publication furnishes an excellent medium for keeping the trade informed, and it is as much appreciated by the trade itself as it is beneficial to the company issuing it.

A NEW YORK STATE INSTALLMENT FORM.

Below is a form used by a dealer at Saranac Lake, N. Y., for selling goods on installments. It is printed for the information of dealers in New York and other States where similar laws prevail.

JOHN I. NILES Article.....
 LEASE. Price

Saranac Lake, N. Y.,.....190....
 THIS is to certify that I have received this day from John I. Niles, one
 No.which I am allowed to use with care and keep in good order.

I have agreed to purchase said and pay therefor the sum of \$..... per week, to be paid at his office, 59 Broadway, and until fully paid, the same to remain the property of John I. Niles.

I further agree not to mortgage, sell or dispose of said in any manner whatever, nor to remove from No. in without the written consent of John I. Niles endorsed thereon.

It is hereby understood and agreed that in case of failure to comply with all or any of the foregoing agreements that the said John I. Niles, his agents or attorneys, may take possession of the same without process of law, and for that purpose or the purpose of searching for the same they, or their legal representatives, may enter any premises occupied by me, and to that end may use such force as may be necessary without any liability to any action for trespass or damage therefor, and that all payments made by me shall be considered as made for the use of the article.
 Signed.....
 Witness.....

It is further stated and represented by the party of the SECOND part that he is over twenty-one years of age and is competent to make this agreement. In consideration of the execution and delivery of the within agreement, the party of the second part (the purchaser) hereby expressly waives the provisions of Chapter 762, of New York State laws of 1900.

Received from a duplicate of the foregoing agreement at the date thereof.
 Purchaser.

APPLYING THE GOLDEN RULE.

I have just made a sale that was a real pleasure to me, not from a financial point of view, but from the fact that it is going to be used for the pleasure and amusement of the inmates of the Sandusky County Infirmary.

The Directors have just purchased an Edison Home Phonograph, large horn and a large quantity of Edison Records, they have also left instructions to allow the Superintendent to get Records whenever he wants them, and the bill will be paid out of the County's funds.

This action on the part of the Infirmary Directors has been highly commended by all, as it gives our unfortunate poor the same pleasure that owners of Phonographs now enjoy, and it would be well for other Counties to do as much for their poor. The fact that they gave me a standing order for Records, shows that they want the inmates to hear the up-to-date music, and shows that they are doing "unto others as they would have others do unto them."

I thought your readers might be interested in knowing how much good the Phonograph can be made to do if the Dealer will do his share.

C. F. MILLER,
 Fremont, Ohio.

HOW IT CONVINCES.

I never sold the Edison Phonograph until about November 8, 1905. It was a very serious doubt in my mind if I could use the initial order and was about to turn it down. I finally took it, and was the most surprised man in any line of goods. I have not only sold the initial order, but in all so far have sold more than 500 Records and 20 Phonographs, and am not through for the season. I am very much pleased with the Edison. I was a _____ enthusiast until your machine came in my house, and now I am more an Edison enthusiast than I was a _____ before I handled the Edison. I have placed Edison machines in the finest homes in this town. When at first mentioning the matter to them they would say, "I do not want a talking machine." I ask them if they ever heard a good one, and beg the privilege of placing one in their house. At this writing I have not had to take out any machines. All have been more than pleased and in several instances these same parties have helped me to sell their friends.

I have a very fine testimony where I sold an Edison to a man. He told his wife about buying one before he took it home and she declared he could not bring it into the house. So he came down and told me about it, and asked if I would let him off. I told him certainly, but suggested that he ask his wife if she would not let me set it up in the house where she could hear it. She finally consented to let us do so, and we sent a dozen Records of a good selection. They played them over several times, and when he came home for dinner the next day his wife was playing the machine. After dinner he remarked that he had better take the machine back, as he had an errand down town before he went to work. She said "no you don't, that is the finest music I ever heard," since that time she has been our best Record purchaser. W. F. WARNING.
 Blanchester, O.

AMONG THE JOBBERS.

Magruder & Co., of Nashville, Tenn., have removed to 27 The Arcade.

Ackerman & Co., of Scranton, Pa., are now settled in their new quarters at 217 Wyoming avenue.

The O. K. Houck Piano Co., of Memphis, Tenn., have devoted one entire floor of their Nashville branch to the wholesale talking machine business and carry about 20,000 Edison Records.

NOT NEEDED ON THE TRIUMPH.

A statement was made a month or two ago that on all Edison Phonographs now being made there were special marks on the back rods by which a speed of 160 revolutions a minute could be determined. This statement was not intended to apply to the Triumph machine, which has a speed indicator and requires no other device.

THIS WILL INTEREST ALL DEALERS.

Knowing you are always interested in learning of dealers' progressive methods, I enclose herewith copy of a "Phonograph Talk," which I made on a "Home" and reproduce nightly to the people who attend our "free concert" from 8 to 9 p. m.

It has induced many people to buy, who had not before considered the Phonograph as of any special utility.

I also have a conspicuous card up, worded as follows: "Special Record of your own voice made here. Send one back to the Old Folks."

I charge \$1.00 for each one made and have made quite a number since the card was put up, and have added to my machine sales thereby, too.

If this hint is of service to dealers you are at liberty to print it. The entire piece (including introductory, showing who made it, and where and when made), is recorded on one cylinder, and as perfectly audible to an entire audience filling a 25x120-foot room. Every word and tone is distinct and natural. It was made with a recording horn.

SOUTH McALISTER, I. T., Dec. 4, 1905.
[Binks, Binks & Co., home-made Record, Dec. 4, 1905, in their store in South McAlister, Indian Territory.]

"LADIES AND GENTLEMEN:—I, the Phonograph, child of the brain of the great wizard, Thomas A. Edison, of Menlo Park, desire to call your attention to one great blessing that I can confer upon you all if you will take me to your homes.

"I can record the beloved voices of your parents, your children, your lover or sweetheart; and when perhaps they are thousands of miles away—or gone forever—I can bring them back to your fireside by reproducing their voices in the same old beloved tones and warm your hearts anew with sweet recollections.

"I can record the hilarity of your 'jolly good fellows' and years after they are gone renew to you the old stories and songs.

"On no other machine can you make a natural Record and reproduction in your own homes, and for this service alone I am worthy the place of honor in your parlors.

"But more, I can teach your children how to sing, and teach any of you the French, German, Spanish and other foreign languages, or teach the foreigner English.

"I can then bring home to you the Opera, Church, Sentimental and Comic or Descriptive Songs, Funny Stories, Vaudeville, Minstrels, all kinds of vocal and instrumental music for entertainment or dancing. And all this at the same price as my would-be competitors the "scratchophones," which send you wild with their screech and cannot make a Record at any price, * * * * *

"Now, hoping that you will 'Keep a Little Cosey Corner in Your Heart for Me,' I remain

"Yours faithfully and clearly,
"THE EDISON PHONOGRAPH."

The phrase "Keep a Little Cosey Corner in Your Heart for Me" was sung to the proper tune, without making any break in dropping and renewing talk before and after singing it, and it made a great sensation every night. I think Dealers should emphasize the Record making more to their customers, as it is a great advantage over all other makes. On the Edison every word is full toned and enunciation perfectly clear. BINKS, BINKS & Co.

A DEALER'S VIEW OF INSTALLMENT BUSINESS.

Your article in the December monthly on "Shall Dealers Sell on Installments," just strikes me exactly. I have been selling Phonographs for over three years, on the installment plan. My terms are \$1.00 down and

\$1.00 per week on Phonographs, except to customers living out of the city, of whom I require one-half cash down, and the balance, payments. Records, large horns, and all other supplies, are cash.

The prospective customer is required to sign a Rent Bill like the one I enclose, printed below], which is further secured by a promissory note, but I do not always require the note.

I find that not one customer in ten will pay cash for a Phonograph, but many who are able to do so, prefer the installment plan.

As you say, "it is worth while to get a Phonograph in a home for the Record business that will follow." The cash sale of Records goes on while they are making their payments, and when the machine is paid for, they keep right on coming for the new Records, which are getting better every month.

I had the pleasure of visiting the Edison Record plant, in New York, in October, and I am convinced that neither pains nor expense is spared in making Edison Records.

D. A. DEVINELL.
Des Moines, Ia.

KNOW ALL MEN BY THESE PRESENTS, That I, D. A. DWINELL, of the City of Des Moines, County of Polk, State of Iowa, DO HEREBY LET AND LEASE unto [John Smith, 1800 Lyon St., Des Moines, Ia.] said City, County and State aforesaid, the following described property, to-wit:

[One Edison "Home" Phonograph, No. 359687, @ \$30.00], to be used only in the [Residence] known as number [1800 Lyon Street], Des Moines, for the consideration of the sum of [Thirty (\$30.00)] dollars, to be paid as follows, as rent: [One (\$1.00)] Dollar in hand paid, the receipt whereof is hereby acknowledged, and the further sum of [One (\$1.00)] Dollar to be paid on each and every [Saturday of each week] thereafter until the whole of the first mentioned sum of [Thirty (\$30.00) Dollars], with legal interest from date, is paid in full. The above payments to be made at the office of D. A. DWINELL, 408 East Fifth street, Des Moines, Iowa, in accordance with the terms of one promissory note of even date and tenor herewith.

Now, be it understood, that if any of the above mentioned payments shall become due, and remain unpaid, or the Lessee shall not take proper care of said property, or shall remove the same from said described premises, without the consent of said D. A. DWINELL, in writing endorsed hereon, then at the option of said D. A. DWINELL, said lease, and note or notes, together with all payments made hereon shall be forfeited, and he shall have the right and this shall be his authority, to enter said premises or wherever else the said property may be found, and take possession of said property, and the Lessee to forfeit all payments made hereon.

Dated this [18th] day of [December] A. D., 190[5].

STATE OF IOWA, SS.
Polk County.

On thisday of.....A. D., 190..., before me..... a Notary Public, in and for said County, personally came..... personally to me known to be the identical person.. whose name..... affixed to the above instrument as grantor.., and acknowledged by the execution of the same to be..... voluntary act and deed for the purpose herein expressed.

IN TESTIMONY WHEREOF, I have hereunto set my hand and affixed my official seal, at Des Moines, Iowa, on the day and date last above written.

.....
Notary Public, Polk County, Iowa.

RENT BILL.
D. A. DWINELL
to

.....
Filed for Record the day of
.....A. D., 190..., at o'clockM.,
and recorded in Book..... on page.....
of.....County Records.

Recorder.
Deputy.

R. E. GRANT, MIDDLEPORT, OHIO.

Under separate cover I am mailing you photographs of the interior and windows of my new room just completed for a complete line of Phonograph and small goods as well as pianos, organs, etc. I am also pleased to say that the addition has proven to be a very profit-

number each box, the first, 1 to 53, the second, 54 to 85, and so on through, and it takes but a minute to find any number called. In order to keep track of what is sold and unsold, I write the actual eighteen numbers in rotation on a card in each box. When a Record is sold, I make a pencil x opposite the number sold; then when a number is called for all I have to



able and drawing card to my business. My arrangements are said, by travelers, to be as perfect and complete as ever seen. Each wall bracket contains a catalogue department for each piano handled. For Records I use a box, 18x9x3, holding 18 Records. I take the numerically arranged catalogue, count off and mark off under the eighteenth Record. I

look at is the card. It takes but a few minutes to make up an order from the cards. In ordering I use the National order blank. When Records are received, and as each Record is filed, the x is rubbed out, and in this way I know just how the stock is on short notice, and the order blank shows the amount

R. E. GRANT.

LOFTUS MUSIC COMPANY, PUEBLO.

We enclose a photograph showing part of the store of the Loftus Music Company, of Pueblo, Colorado, a company recently organized to handle sheet music and music supplies,

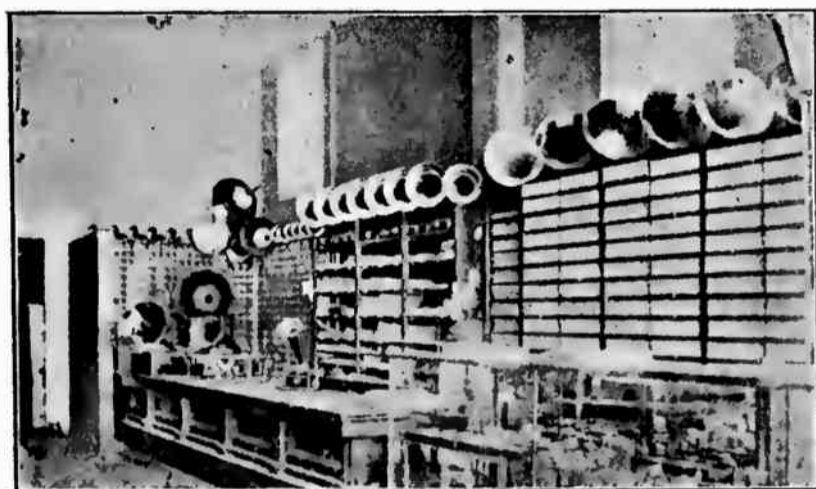

also the Edison Phonograph and Phonographic supplies. While a new company our business now exceeds the wildest sort of expectations, growing by leaps and bounds. The Edison Phonograph has taken such a hold on the people in this territory that we cannot at times fill orders for Records fast enough. Fortunately for us we do not have to explain to the public the merits of the Edison Phonographs—that having been already done on land and sea—consequently we have more time to fill orders,

and we need the time, too; and in addition, the Records "speak" for themselves. The photograph we enclose shows but two elevations of our Record rack, (account of the focus of the camera not covering) which holds two thousand Records—the largest in Pueblo or the surrounding country—but we are unable to keep it full.

LOFTUS MUSIC COMPANY.

"HOW I SOLD A RECORD."

One evening a short time ago, a motor-man on one of the electric cars here in this city, came to my store, with his wife, to buy some Records. I played two or three, but none of them seemed to just strike them. I finally, by chance, put on Record No. 8621, "I Ain't Got No Time," by Collins and Harlan. When the Record was nearly through his wife said she must take a car which was going by, as she had to go to a lodge that evening, and her husband could buy whatever he wished. She said, "Good night," opened the door and stepped out. She had no sooner closed the door when the Record called out "She's gone, She's gone, Come back and I'll be your dog; Come back and I'll even be your doormat." There was a great laugh as the store was full at the time. The husband spoke up and said, "I'll take that Record," and he did.

L. R. PORTER,
Brockton, Mass.

JOBBER'S OF EDISON PHONOGRAPHS AND RECORDS.

ALABAMA.

Birmingham—Talking Machine Co., 2007 Second ave.
Mobile—W. H. Reynolds, 167 Dauphin street.
Montgomery—R. L. Penick, 119 Dexter ave.

CALIFORNIA.

San Francisco—Peter Bacigalupi, 786-788 Mission street.

COLORADO.

Denver—Denver Dry Goods Co., 619 16th street.
 Hext Music Co., 15th and California streets

CONNECTICUT.

New Haven—Pardee-Ellenberger Co., 155 Orange st.

DISTRICT OF COLUMBIA.

Washington—E. F. Droop & Sons Co., 925 Pennsylvania avenue, N. W.
 S. Kann Sons & Co., 8th and Pennsylvania avenues.

GEORGIA.

Atlanta—Atlanta Phonograph Co., 49 Peachtree St.
 Phillips & Crew Co., 37-39 Peachtree St.
Waycross—George R. Youmans.

ILLINOIS.

Chicago—Babson Bros., 148 Michigan Ave.
 Lyon & Healy, Wabash Ave. & Adams St.
 James I. Lyons, 192 Van Buren street.
 Talking Machine Co., 107 Madison street.
 The Vim Co., 68 E. Lake street.
 Montgomery Ward & Co., 111 Michigan ave.
 Rudolph Wurlitzer Co., 302 Wabash ave.
Peoria—Peoria Phonograph Co., 416 S. Adams street.
Quincy—Quincy Phonograph Co., 808 Hampshire st.

INDIANA.

Indianapolis—Indiana Phono. Co., 45 Virginia Avenue.
 Kipp Bros. Co., 37 S. Meridian street.
 A. B. Wahl & Co., 119 S. Illinois street.
Lafayette—A. B. Wahl & Co., 304 Main street.

IOWA.

Des Moines—Hopkins Bros. Co., 620 Locust street.
 Vim Co., 704 West Walnut street.
Fort Dodge—Early Music House, 822 Central ave.

KENTUCKY.

Louisville—C. A. Ray, 650-652 Fourth avenue.

LOUISIANA.

New Orleans—William Bailey, 600 Frenchman street.
 National Automatic Fire Alarm Co.,
 614 Gravier street.

MAINE.

Bangor—S. L. Crosby Co., 186 Exchange street.
Portland—W. H. Ross & Son, 207 Commercial street.

MARYLAND.

Baltimore—E. F. Droop & Sons Co., 109 N. Charles St.

MASSACHUSETTS.

Boston—Boston Cycle & Sundry Co., 48 Hanover street.
 Eastern Talking Mach. Co., 177 Tremont st.
 Iver Johnson Sptg. Goods Co., 163 Washington street.

C. E. Osgood Co., 744 Washington street.

Read & Read, 630 Washington street.

Fitchburg—Iver Johnson Sptg. Goods Co., 247 Main st.

Lowell—Thomas Wardell, 111 Central street.

New Bedford—Household Furnishing Co., 170 Purchase street.

Springfield—Flint & Brickett Co., 439 Main st.

Worcester—Iver Johnson Sptg. Goods Co., 304 Main st.

MICHIGAN.

Detroit—American Phono. Co., 106 Woodward ave.
 Grinnell Bros. 219 Woodward ave.

MINNESOTA.

Minneapolis—Thomas C. Hough, 714 Hennepin ave.

Minnesota Phono. Co., 518 Nicollet avenue.

St. Paul—W. J. Dyer & Bro., 21-23 West 5th street.

Thomas C. Hough, 392 Wabasha street.

Minnesota Phonograph Co., 37 E. 7th street.

MISSOURI.

Kansas City—J. W. Jenkins' Sons Music Co., 1013-1015 Walnut street.

J. F. Schmelzer & Sons Arms Co., 710 Main street.

St. Louis—Conroy Piano Co., 11th and Olive streets.

O. K. Houck Piano Co., 1118 Olive street.

Western Talking Machine Co., 923 Olive st.

MONTANA.

Helena—Frank Buser, Diamond Block, Sixth avenue.

NEBRASKA.

Lincoln—H. E. Sidles Cycle Co., 1317 O street.
Omaha—Nebraska Cycle Co., 15th and Harney streets.
 Omaha Bicycle Co., 16th & Chicago sts.

NEW JERSEY.

Hoboken—Eclipse Phono. Co., 203 Washington st.
Newark—Douglas Phonograph Co., 20 New street.
 A. O. Petit, New and Halsey streets.
 V. H. Rapke, 287 Bank street.
Paterson—James K. O'Dea, 117 Ellison street.
Trenton—Stoll Blank Book and Stationery Co., 30 E. State street.
 John Sykes, 105 N. Broad street.

NEW YORK.

Albany—Finch & Hahn, 92 State street.
Brooklyn—A. D. Matthews' Sons, 394 Fulton street.
 Price Phonograph Co., 1260 Broadway.
Buffalo—P. A. Powers, 613 Main street.
Elmira—Elmira Arms Co., 117 Main street.
Gloversville—American Phono. Co., 99 W. Fulton st.
Kingston—Forsyth & Davis, 307 Wall street.
New York City—Bettini Phono. Co., 156 W. 23d street.
 Blackman Talking Machine Co., 97 Chambers street.
 J. F. Blackman & Son, 2737 3d avenue.
 Sol Bloom, 214 W. 42d St
 I. Davega, Jr., 802 Third avenue.
 S. B. Davega, 32 E. 14th street.
 Douglas Phono. Co., 89 Chambers st.
 H. S. Gordon, 1241 Broadway.
 Harry Jackson, 219 Bowery.
 Jacot Music Box Co., 39 Union Square.
 Victor H. Rapke, 1661 Second avenue.
 Siegel-Cooper Co.
 John Wanamaker.
 Alfred Weiss, 1525 First avenue.
Oswego—Frank E. Bolway, 32 Bridge street.
Poughkeepsie—Price Phonograph Co., 203 Main st.
Rochester—A. J. Deninger, 345 North street.
 Mackie Piano, O. & M. Co., 100 State street.
 Giles B. Miller, 63 State street.
 Talking Machine Co., 97 Main st., E.
Schenectady—Finch & Hahn, 504 State street.
 Jay A. Rickard & Co., 253 State street.
Syracuse—W. D. Andrews, 216 E. Railroad street.
Troy—Finch & Hahn, 3 Third street.
Utica—Clark-Horrocks Co., 54 Genesee street.
 Arthur F. Ferriss, 89 Washington street.
 William Harrison, 41 Columbia street.
 Utica Cycle Co., 31 Columbia street.

OHIO.

Canton—Klein & Heffelman Co., 216 N. Market street.
Cincinnati—Ilsen & Co., 25 W. 6th street.
 Rudolph Wurlitzer Co., 10-12 W. 4th st.
Cleveland—Eclipse Musical Co., 162 Prospect st.
Columbus—Perry B. Whitsit Co., 213 S. High street.
Dayton—Niehaus & Dohse, 35 E. 5th street.
Newark—Ball-Fintze Co.
Toledo—Hayes Music Co., 608 Cherry street.

OREGON.

Portland—Graves & Co., Inc., 328 Washington St.

PENNSYLVANIA.

Allegheny—Henry Braun, 500 Federal street.
Allentown—G. C. Aschbach, 539 Hamilton street.
Easton—William Werner, 401 Northampton street.
Harrisburg—S. K. Hamburger, 12-14 N. Market sq.
New Castle—W. C. DeForest & Son.
Philadelphia—C. J. Heppe & Son, 1117 Chestnut street.
 Lit Bros., Market and 8th streets.
 Penn Phonograph Co., 17 S. 9th street.
 John Wanamaker, 13th and Market sts.
 Wells Phonograph Co., 45 N. 9th street.
 Western Talking Mach. Co., 128 S. 9th st.
 H. A. Weymann & Son, 923 Market st.
Pittsburg—Theo. F. Bentel Co., Inc., 632 Liberty street.
 H. Kleber & Bro., 221 Fifth avenue.
 C. C. Mellor Co., 319 Fifth avenue.
 Pittsburg Phono. Co., 937 Liberty street.
 Talking Machine Co., 619 Penn ave.
Reading—Reading Phonograph Co., 911 Penn street.
Scranton—Ackerman & Co., 217 Wyoming avenue.
 Technical Supply Co.
Williamsport—W. A. Myers, 145 W 3d st.

RHODE ISLAND.

Pawtucket—Pawtucket Furniture Co., 39 N. Main St.
Providence—J. M. Dean Co., 785-795 Westminster street.
 J. A. Foster Co., Weybosset st.
 Household Furniture Co.
 J. Samuels & Bro., 154 Weybosset street.
 A. T. Scattergood & Co., 106 N. Main st.

JOBBER'S OF EDISON PHONOGRAPHS AND RECORDS—Continued.

TENNESSEE.

Knoxville—Knoxville Typewriter and Phonograph Co., 421 Gay street.
 Memphis—F. M. Atwood, 160 N. Main St.
 O. K. Houck Piano Co., 103 S. Main street.
 Nashville—Nashville Talking Mach. Co., 510 Church st.
 Magruder & Co., 27 Arcade.
 O. K. Houck Piano Co.

TEXAS.

Dallas—Southern Talking Machine Co., 347 Main st.
 El Paso—W. G. Walz Co., 101 El Paso street.
 Fort Worth—Cummings, Shepherd & Co., 700 Houston st.
 Houston—Texas Phono. Co., Capitol and Fannin Sts.
 San Antonio—H. C. Rees Optical Co., 242 West Commerce St.

VERMONT.

Burlington—American Phono. Co., 34 Church St.

VIRGINIA.

Richmond—Magruder & Co., 729 E. Main st.

WASHINGTON.

Seattle—D. S. Johnston Co., 903 Second Ave.
 Spokane—Spokane Phono Co., 7 Post St.

WISCONSIN.

Milwaukee—McGreal Bros., 173 3d street.

CANADA.

Toronto—R. S. Williams & Sons Co., Limited,
 143 Yonge street.
 Winnipeg—R. S. Williams & Sons Co., Ltd., 121 Princess street.

SUSPENDED LIST, FEBRUARY 1, 1906.

SUPERSEDING ALL PREVIOUS LISTS.

GEORGIA.

Valdosta—H. K. McLendon, 109 West Central Ave.

ILLINOIS.

Champaign—Eggleston Bros.
 Ottawa—Edward Hayne.
 Wheaton—E. Irving.

INDIANA.

Logansport—F. M. Neff, 406 Broadway.
 South Bend—EUGENE MARSH, 126 Vistula avenue.
 SOUTH BEND BOOK BINDERY, Robert Lebolt, Prop., 203 North Michigan street.

IOWA.

Burlington—JOHN P. WEISS, 711 Jefferson street.
 Sioux City—HATTENBACH BROS. CO.
 A. V. LARIMORE, 518 Fifth street.

KANSAS.

Clay Centre—E. M. GOWENLOCK.
 Lawrence—BELL BROS.
 Topeka—R. H. MOREHOUSE, 510 E. 4th street.

MAINE.

Biddeford—W. H. FIELD.
 Lewiston—J. W. SKENE.
 Monmouth—G. H. STETSON.
 *Waterville—FRANK BLANCHARD, 150 Main street.

MASSACHUSETTS.

Boston—E. C. PECK, 43 Milk st.
 T. SINGER, 60 Leverett street.
 Franklin—E. P. Blackman.
 Lawrence—LORD & CO., 314 Essex street.
 E. O. MOSHER, 420 Essex street.
 Lynn—ELIAS DEYOUNG.
 Malden—A. T. FULLER.
 Nantucket—ARTHUR M. TAYLOR.
 New Bedford—H. B. DEWOLFF.
 Somerville—E. J. WINCHESTER, 32 Summit avenue.
 Worcester—JOSEPH TUKMAN, 44 Front street.
 Woburn—OSBORN GILLETTE, or THE BOLTON JEWELRY CO., L. F. Maloney, Manager.

MICHIGAN.

Detroit—F. J. SCHWANKOVSKY.
 Saginaw—GEO. W. EMENDORFER.
 JAMES V. CALAHAN, 217 Genessee st.
 TIERNEY BROS., 217 Genessee st.

MISSOURI.

Kansas City—THE WITTMANN CO.

NEBRASKA.

Lincoln—THE WITTMANN CO.
 Omaha—THE WITTMANN CO.
 *PIANO PLAYER CO.

NEW HAMPSHIRE.

Hillsbro Bridge—E. M. BARNES.
 Manchester—A. E. DUMAS
 Nashua—F. A. MCMASTER & CO.

NEW JERSEY.

Atlantic City—SAM'L D. WOLF, 32-34 Arkansas ave.
 Bayonne—I. WIGDOR, 450 Avenue D.
 Jersey City—W. L. HOFFMAN, 151 Montgomery st.
 Newark—R. L. CORWIN; also New York City.
 Passaic—I. HURWITZ.
 Paterson—CHAS. H. KELLY, 25 N. Main street.
 Plainfield—S. W. FRUCHT, or R. FRUCHT; also New York City.

ELSTON M. LEONARD.

West Hoboken—EMIL HOLLANDER, or THE WEST HOBOKEN BICYCLE & PHONO. CO., 619 Spring street.

NEW YORK.

Albany—G. LINDE, 353 S. Pearl street.
 Auburn—CHAS. C. CHIER CO., 18 Clark street.
 Bedford Park—GEO. H. TYRRELL.
 Brooklyn—WM. ALBRECHT, 294 Knickerbocker ave.
 H. HINDERMANN, BUSHWICK PHONOGRAPH EXCHANGE, 1421 Myrtle avenue.
 Hobart—F. H. MARSHALL.
 Mohawk—ALBANY SPECIALTY CO., or CHAS. F. RICE, Main street.
 Moravia—C. D. LOOMIS & CO., Union Block.
 New York City—A. T. ARMSTRONG, or AMERICAN PHONO. CO., 106 Wall street.
 AUTOMATIC ZITHER CO., M. Cohen, Prop., 58 Second avenue.
 BERN BEARWALD, 373 W. 11th st.
 EDWARD BIELFELD, 481 Willis Ave.
 BRONX PHONO. CO. or DAVID SWITKY, 506 Willis ave
 CENTRAL PHONO. CO., 160 E. 42d street.
 R. L. CORWIN; also Newark, N. J.
 EAGLE PHONO. CO., or C. LOWENTHAL, 83 Nassau street.
 EMPIRE PHONO. CO., 2 W. 14th street.
 S. W. FRUCHT, or R. FRUCHT, 7 Barclay st., or 68 Cortlandt st.; also Plainfield, N. J.
 O. HACKER, 2 Murray street.
 HAWTHORNE & SHEBLE, 297 Broadway; also Philadelphia, Pa.
 HOLOBER BROS., 350, 421 and 491 West st.
 N. HORN, 148 E. 58th street.
 W. L. ISAACS, 114 Fulton street.
 S. LEMBURG & CO., 194 Broadway.
 J. MCELLYNNE, 202 Broadway.
 RICHMOND PEASE, 44 W. 132d st.
 F. M. PRESCOTT, 44 Broad st.
 WINTHROP CYCLE CO., 2212 Seventh ave.

Rome—CHARLES TUTTLE.

Saratoga—W. J. TOTTEN.

Saratoga Springs—MARVIN A. COTE.

Watertown—HENRY A. HARDY, 24 Arsenal st.

H. S. WARDWELL & CO., 39 Public Square.

Wolcott—J. A. MURPHY, 7 Main street.

NORTH CAROLINA.

Kinston—S. A. Quinerly.

OHIO.

Cincinnati—J. L. ANDEM.

Coshocton—BURNS & GOSSER.

Springfield—D. & M. VANDERPOOL.

Uhrichsville—F. A. MAZURIE.

PENNSYLVANIA.

Philadelphia—A. R. CASSIDY, 2783 Emerald street.
 HAWTHORNE & SHEBLE, 604 Chestnut st., or Oxford and Mascher sts.; also New York City.
 A. KROUSE, 832 Arch street.
 PENN NOVELTY CO., 15 South 9th st.

Phoenixville—KEINARD BROS.

Pittsburg—A. LIPPARD, 615 Wylie ave.

RHODE ISLAND.

Providence—F. P. MOORE.

*Rockville Center—O. A. CLARK.

WISCONSIN.

Milwaukee—J. C. BLATZKE.

*Added Since January 1, 1906.

Jobbers and Dealers are asked not to supply any of the above named firms with our apparatus, either at addresses given or any other address.

HOW TO ENJOY THE PHONOGRAPH.

The following interesting article appeared recently in the *Northern Whig*, published at Belfast, Ireland:

Firmly has the Edison Phonograph established itself in nearly every household. Still there are many possessors of such an instrument who do not extract from it the full measure of enjoyment which it is capable of imparting. It is a revelation even to the expert in talking machine mysteries to assist at a "Phonograph seance" in T. Edens Osborne's cosy reception-room at Edison House, Belfast. A couple of hours thus spent slip away with marvellous quickness, and you leave regretting that so enjoyable an experience could not be prolonged indefinitely. For you experience the mingled pleasures of a high-class vocal and instrumental concert, a jolly "smoker," a social chat (with absent friends and dear people of note taking part in the conversation), and a plain talk with yourself. What cannot but appeal to you whether you are a "Phonographist" or not is the marvellous perfection to which the Edison machine and Records have been brought. What a contrast in quality, volume, delicacy, and distinctness are the results to those obtained from the early appliances, such as those used in the demonstration given in St. George's Hall nearly twenty years ago. People marvelled then at the primitive machine; they regard the perfected Phonograph now with cool equanimity, although without doubt the developments made in recent years are scarcely less wonderful than the original invention—or rather discovery. The new Edison reproducer, for instance, gives tone effects which were impossible in the old appliance; the improved recorder used with the Edison blank cylinder enables the veriest tyro to make a vocal Record which is not only clear and distinct, but a faithful reproduction of his voice. Perhaps the most wonderful development in connection with the Phonograph is the "Gold Moulded Record," one of the American wizard's cleverest and most remarkable inventions. In connection with these Records the highest musical and "variety" talent have been requisitioned, with the result that Miss Morgan's lovely voice, Gilbert Girard's clever imitations, Len Spencer's stentorian Yankee humor, or Hooley's grand and resonant basso is given out by the Phonograph so naturally and perfectly that you might at times be led to believe that it is the real voice and not a reproduction to which you are listening. The same remark applies to instrumental Records. A Sousa march with its daring and ingenious trickeries of scoring, a dainty gavotte with its delicate nuances of orchestration, or an operatic selection with its beauty of light and shade "comes out" with equal faultlessness, and with just the amount of volume necessary to charm the ear, and to bring out every possible gradation of light and shade without taxing the most delicate nerves. There indeed lies the charm of the instrument for home purposes. It is always powerful enough, never too powerful.

Like an experienced conductor, Mr. Osborne at these seances enhances enjoyment

then a rousing baritone song with orchestral by introducing the element of variety. You could have a conventional concert if you liked, beginning with a pianoforte or violin duet and ending with an instrumental quartette. But it is pleasanter when he commences, say, with a bell solo (one of the daintiest things among the many hundreds of Edison instrumental Records); then follows with Michaelis's fine descriptive piece "The Forge in the Forest," splendidly given by a military band; accompaniment; and then Glover's beautiful old duet "In the Starlight," rendered by voices of fine quality and expusitely blended. Next come a couple of songs from well-known local artists, and the Records (made in that room) are not disgraced even by comparison with the specialties to which you have been listening. Then you are treated to a smokeroom conversation between three or four "fellows whom you know," and whose voices and tricks of speech you recognize even before their names are mentioned. "And now," says Mr. Osborne, "We'll make Records." So the recorder is placed upon the machine and your speech or your song is transferred in indelible characters to the blank cylinder. Gratification, astonishment, or mortification will follow, according to whether you thought you had a harsh or a dulcet voice. "Now, we'll have a discussion," suggests our host, "say, on the Government defeat." So a special tube attachment with four mouthpieces is fixed to the recorder, and a perfectly natural talk in ordinary smokeroom style is recorded, the reproduction of which causes no end of hilarity. Then we have more music—the garden scene from "Faust" finely sung; a pretty gavotte, "Beauty's Cunning," effectively played by the "Symphony Orchestra;" a plantation descriptive sketch by the Edison quintet; a clarinet solo by Tuson; and a violin and flute duet. The seance concludes by the entire company singing "Auld Lang Syne," some of the harmonies of which when reproduced cause a few shudderings among the musical members of the company. As an object lesson in the art of making the Phonograph a real boon instead of an infliction the evening has been as edifying as it undoubtedly has been pleasant.

THE PHONOGRAPH AS AN ASSISTANT SALESMAN!

The management of the old-fashioned Grocery and Drug House of Wm. Dobbin & Co., Ltd., North Street, Belfast, have—with laudable enterprise—placed Genuine "Standard" Edison Phonographs on their counters, which call attention, clearly and unmistakably, to their seasonable goods by means of Records that announce the specialties in each of their departments. We may mention that any person can make and reproduce similar Records inside three minutes.

Messrs. Dobbin & Co. are to be congratulated on having "broken the ice" in connection with this innovation as a modern business method, which was suggested to them by T. Edens Osborne, Belfast, who supplied the instruments &c.—*Ulster Echo, Belfast, Ireland.*