

# STEREO / HI-FI 1965 DIRECTORY

\$1.00

\$1.25 OUTSIDE U.S.A.

## COMPLETE BUYERS' GUIDE

- Latest Models
- Latest Prices
- Over 2000 Products
- 175 Different Manufacturers



**Buying stereo?**

**The first  
thing you need  
is free.**

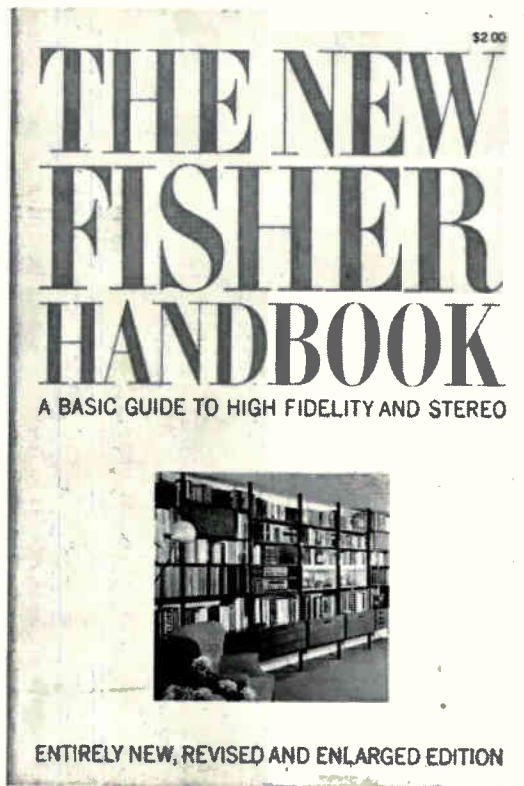

## Send for your free copy of the New Fisher Handbook!

**Free! 76 Pages! \$2.00 Value!** *The New Fisher Handbook* is a completely new version of the famous Fisher high fidelity reference guide, idea book and component catalogue. It is new in format, fifty per cent longer in content than any previous edition, and even more explicitly detailed and illustrated. Here is the finest comprehensive guide to all phases of high fidelity and stereo—the first thing you need before making an investment in new equipment.

The following special articles by outstanding authorities are appearing for the first time in *The New Fisher Handbook*:

**“What Is High Fidelity?”**

**By John M. Conly**

Record reviewer; former Music Editor of *The Atlantic Monthly*; former Editor in Chief of *High Fidelity* magazine.

**“The Why and How of High Fidelity Components”**

**By C. G. McProud**

Publisher of *Audio* magazine;

Fellow and former President of the Audio Engineering Society.

**“How to Play Hi-Fi by Ear”**

**By Emanuel Vardi**

Concert violist, conductor, composer and arranger; former member of Toscanini's NBC Symphony Orchestra.

**“How to Install a Home Music System”**

**By Ralph Freas**

High fidelity columnist of the *American Home Magazine* and *Esquire*.

For your free copy of this unique one-volume audio library, fill out and mail the coupon below.

Fisher Radio Corporation  
 21-40 44th Drive, Long Island City, N. Y. 11101  
 Please send me *The New Fisher Handbook* without charge or obligation.

Name \_\_\_\_\_

Address \_\_\_\_\_

City \_\_\_\_\_ State \_\_\_\_\_

156516

CIRCLE NO. 24 ON READER SERVICE CARD



for those  
who can **hear**  
the difference **V-15**

## FOUR MICRO-MAGNETIC\* 15° PICKUPS!

Whether you own a record changer, automatic turntable, or a professional type manual turntable Pickering has engineered the RIGHT V-15 pickup for you. If it's RECORD CHANGER application, where high output and heavier tracking forces are required try the **V-15 AC-1**. Most of you, no doubt are tracking lighter on the late model AUTOMATIC TURNTABLES and will use the **V-15 AT-1**. Or if a professional type MANUAL TURNTABLE is your choice you'll need the even more compliant **V-15 AM-1**. And if it's unexcelled tracking ability you're seeking, you will demand the ELLIPTICAL STYLUS PICKUP **V-15 AME-1**. All four of these pickups are radically different from any other cartridge. You can see the difference. You can hear the difference. Pick up a V-15. Note its light weight—only 5 grams. Perfect for low mass tone arm systems. Now, see how Pickering's exclusive "Floating Stylus" and patented replaceable V-Guard assembly protects your record and diamond as it plays.

\*Trade Mark of Pickering and Co., Inc.

PICKERING & CO., INC. PLAINVIEW, N.Y.

# Pickering

THE WORLD'S LARGEST AND MOST EXPERIENCED MANUFACTURER OF MAGNETIC PICKUPS  
CIRCLE NO. 46 ON READER SERVICE CARD

STEREO/HI-FI DIRECTORY

**PHILLIP T. HEFFERNAN**  
*Publisher*

**WM. A. STOCKLIN**  
*Editor*

**P. B. HOEFER**  
*Associate Editor*

**MARSHA JACOBS**  
*Assistant Editor*

**STELLA HALL**  
*Assistant Editor*

**DONALD THAYER**  
*Art Director*

**JOSEPH DAVIS**  
*Art Editor*

**LAWRENCE SPORN**  
*Advertising Manager*

# STEREO / HI-FI 1965

## DIRECTORY CONTENTS

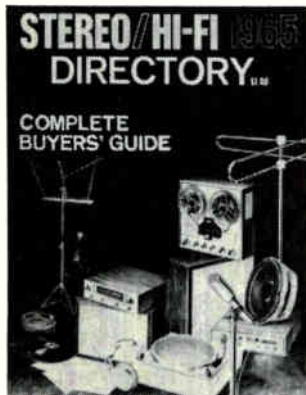

Cover by Otto E. Markevics



**William B. Ziff, Chairman of the Board (1946-1953)**  
**William Ziff, President**  
**W. Bradford Briggs, Executive Vice President**  
**Hershel B. Sarbin, Vice President and General Manager**  
**Philip Sine, Treasurer**  
**Walter S. Mills, Jr., Circulation Director**  
**Stanley R. Greenfield, Vice President**  
**Phillip T. Heffernan, Vice President**

**ZIFF-DAVIS PUBLISHING COMPANY**  
Editorial and Executive Offices  
One Park Avenue, New York, New York 10016, 212 ORegan 9-7200

**WESTERN OFFICE**  
9025 Wilshire Boulevard  
Beverly Hills, Calif. 90211  
213 CResview 4-0265  
Western Advertising Manager  
Bud Dean

**MIDWESTERN and CIRCULATION OFFICE**  
434 South Wabash Avenue  
Chicago, Ill. 60605  
312 WAbash 2-4911  
Midwestern Advertising Manager  
Royce Richard

Copyright © 1964  
by Ziff-Davis Publishing Co.  
All Rights Reserved.

1965 EDITION

### SPECIAL FEATURE ARTICLES

Guest Editorial .....	Walter O. Stanton	5
Directory of Hi-Fi Manufacturers .....		6
FM Stereo Station Directory .....	David Lachenbruch	10
Q & A on Hi-Fi Amplifiers .....	F. L. Mergner	24
Q & A on Phono Cartridges .....	R. E. Ward	45
Q & A on Receivers & Tuners ....	D. von Recklinghausen	59
Q & A on Tape Recorders .....	Herman Burstein	94
Q & A on Hi-Fi Speakers .....	Fred W. Nichols	135
Directory of Hi-Fi Dealers .....		176

### DIRECTORY LISTINGS

#### SECTION 1: AMPLIFIERS

Power Amplifiers, Preamplifiers, Integrated Amplifiers .....	13
---	----

#### SECTION 2: PHONO EQUIPMENT

Record Changers, Automatic Turntables, Manual Turntables .....	33
Phono Cartridges .....	40
Tonearms .....	47
Phono Accessories .....	49

#### SECTION 3: RECEIVERS & TUNERS

FM Receivers .....	51
FM, AM-FM, FM-Stereo Tuners .....	56
Multiplex Adapters .....	69
FM Antennas .....	70

#### SECTION 4: TAPE MACHINES

Recorders, Players, Transports .....	77
Tape Accessories .....	106
Raw Tape .....	110

#### SECTION 5: SPEAKERS/CABINETS

Loudspeakers, Enclosures, Speaker Systems, Crossover Networks .....	115
--	-----

#### SECTION 6: ACCESSORIES

Microphones .....	157
Equipment Cabinets .....	166
Miscellaneous .....	171

# “By all means listen to this \$95 speaker... This is not ‘just another box.’”

HiFi/Stereo Review

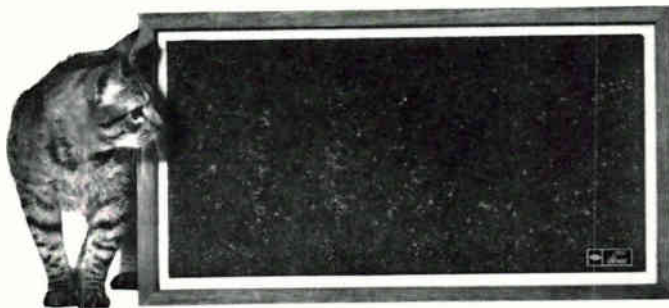

## THE ADC 303A BRENTWOOD

“After the lab measurements had been made, and I had a chance to analyze the data, I began to appreciate how unusual this speaker system really is.”

So writes Julian D. Hirsch of Hirsch-Houck Laboratories, in his “Technical Talk” column in *HiFi/Stereo Review*.

The measurements that evoked his enthusiastic comments revealed surprising qualities in a speaker so compact as the new ADC 303A. Here is how Julian Hirsch describes it:

“For one thing, my tests confirmed the manufacturer’s claimed frequency response of 35 to 20,000 cps  $\pm$  3 db measured in an average listening room.”

“... the Brentwood has a true, effective response down to at least 33 cps, with lower distortion than I have measured on many larger and more costly speaker systems, under similar conditions.”

“The system’s resonance is 48 cps, and ADC states that it delivers true bass response to at least 38 cps. This it certainly does, with ease. The Model 303A is a very successful application of the acoustic-suspension principle, achieved without excessive loss of efficiency.”

What Mr. Hirsch found in his laboratory was impressive; what he heard in his listening room was equally so. This is the way he sums it up:

“As for sound, the ADC 303A is very live and open. It has presence, but without the peaked unnatural response usually associated with that term.”

“... this speaker brings the music right into your listening room... as contrasted to some in which the sound never seems to get out of the speaker enclosure.”

The ADC 303A was planned to produce optimum performance in your home, as well as Mr. Hirsch’s listening room.

Prices slightly higher West of Mississippi.

## “MASS” REVOLUTION NOW IN PROGRESS

ADC Achieves Lowest Mass  
In Cartridge Design With  
POINT FOUR\*, 660 & 770

(\*Elliptical Stylus Now Available)

What are the characteristics of the ideal stereo phonograph cartridge? Stylus mass will have to come down... compliance will be concomitantly increased... vertical tracking angle will be standardized... tracking force will be exceptionally low.

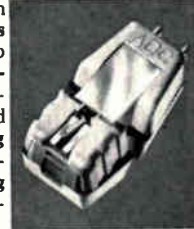

### WHAT ADC HAS DONE

ADC recognized these ideals some time ago. We knew that marginal upgrading of existing designs would not attain these goals. From this decision came the concept of the INDUCED MAGNET TRANSDUCER. In short order we had prototypes of this new class of magnetic cartridge that shattered old technical limitations. What followed were three startlingly new cartridges that incorporated this principle: the ADC POINT FOUR, recommended for manual turntables; the ADC 660 and 770, recommended for automatic turntables and record changers—NOT YEARS HENCE, BUT TODAY.

### YEARS AHEAD PRINCIPLE, TODAY

“Significantly reduced mass” was the key advantage, we said—months before the spotlight was turned on this factor. The use of a fixed magnet, separate from the moving system, inducing its field into an armature of extremely light weight, slashed mass to “half or less than that of systems previously regarded as low-mass designs” we also noted. The tubular, aluminum stylus arm or cantilever connected to the stylus to move this negligible mass was made even lighter. We were then able to match this low mass with a suspension of exceptionally high compliance. Minimum tracking force suggested is  $\frac{1}{4}$  gram, but we have tracked the POINT FOUR perfectly at  $\frac{1}{2}$  gram. “Obtaining the now established tracking angle of 15° is no problem” with the pivot point of the arm brought close to the record surface by the new physical configuration.

### OTHER ADVANTAGES

There are others. We stress a few of the many because they involve factors designated for an idealized cartridge of the future. And we ask you to compare the ADC cartridges AVAILABLE TODAY with these eventual goals. We believe you’ll agree that these are the most advanced cartridges available anywhere. We can only hope that you try them with equipment that will do them justice.

the only ALL-IN-ONE  
record cleaner... the  
ADC HUSH-BRUSH

- 1800 precision-ground nylon bristles
- 24 tufts—covering entire record groove width
- self-contained cleaner fluid supply
- completely eliminates record static
- completely removes all residue from record surfaces
- can never damage your records



\$7.95

### ADC-40 PRITCHARD TONE ARM:



\$44.50

Arm length: 10 $\frac{1}{2}$ " overall • Pivot to stylus tip: 9" • Rear overhang: 1 $\frac{3}{4}$ " • Fundamental resonance: 6 cycles/sec. (with ADC Point 4 cartridge) • System tracks at  $\frac{3}{4}$  gram. • Tone arm accommodates other cartridges. The system comes completely assembled and wired, and is provided with a cable assembly ready to plug into amplifier.



**AUDIO DYNAMICS  
CORPORATION**

PICKETT DISTRICT ROAD,  
NEW MILFORD, CONNECTICUT

CIRCLE NO. 7 ON READER SERVICE CARD

STEREO/HI-FI DIRECTORY



By WALTER O. STANTON  
President  
INSTITUTE OF HIGH FIDELITY



President of Pickering & Co., Inc., he has been named to a two-year term as president of the Institute. He is past president of the Audio Engineering Society and a member of the Young Presidents Organization.

## GUEST EDITORIAL

**T**HE component high-fidelity industry is entering what might well become its most important growth phase. Where several years ago the system itself was the focal point of home entertainment; today the enjoyment to be derived from a component high-fidelity system has supplanted the uniqueness of merely owning such a system.

The sound of component high-fidelity has subtly blended into the normal routine of the household. Just as a fine painting becomes an integral part of a room, so has the fidelity of a component system become a part of a home.

This is not to say, by any means, that the component high-fidelity industry has even begun to approach its potential. It has, rather, matured to the point where important strides forward are imminent.

Through the Institute of High Fidelity—the association of manufacturers of component high-fidelity equipment—a number of important consumer services have evolved as our young industry has grown.

In recent years, as you know, “Hi-Fi Shows” have been held annually in New York City and Los Angeles. These shows have attracted thousands upon thousands of people who want to see and hear the varied advancements in all forms and types of component high-fidelity systems at one central location. In 1964, a third show was added to the Institute’s schedule of consumer activities. The new show was held at the Hilton Hotel in San Francisco, September 10th through the 13th. The 1964 New York City Show is scheduled for October 1st through the 4th at the International Trade Center. The 1964 Los Angeles Show was held at the Ambassador Hotel from March 10th through the 15th and the 1965 Show will be held at the same location from April 1st through the 5th.

The Institute has recently completed the second printing of “An Introduction to Hi-Fi & Stereo”—probably the most influential consumer publication in the history of the high-fidelity industry. This booklet, designed for families new to component high-fidelity, has been available at our Shows, through hi-fi dealers, and at the Institute of High Fidelity’s exhibit in the Better Living Pavilion at the New York World’s Fair.

The World’s Fair Exhibit, again designed to win converts to high-fidelity sound, features one of the most exciting sound demonstrations ever offered. In a specially prepared isolation booth, visitors can test for themselves the range of their hearing. Also featured at this Exhibit, is the story of component high-fidelity—graphically told through color photographs. The demand for copies of “An Introduction to Hi-Fi & Stereo” at the Fair further illustrates the growing consumer desire to know *more* about what was once considered an almost mysterious, and certainly a highly technical, sound vehicle.

The Institute of High Fidelity has officially recognized over 1800 component high-fidelity dealers, throughout the United States, who have conformed to the rigid requirements demanded in order to be “Authorized” by the Institute (See page 176). Beginning this Fall, “Authorized” IHF dealers will be listed as such in the Yellow Pages of telephone directories in almost every metropolitan area.

The Institute of High Fidelity will continue to promote various consumer-oriented projects to introduce components to the greatest number of people. It will also, and with even greater emphasis, continue to serve as an information center not only for audiophiles but for architects, interior decorators, and others involved in designing, building, or in any way making the home more livable with music.

The sound of component high-fidelity is sophisticated sound, neither too technical nor too expensive to be enjoyed by anyone who loves music and will settle for nothing less than the best sound system—designed by specialists especially for one’s own home.

# DIRECTORY OF Hi-Fi Manufacturers

*Listing shows the identifying page numbers on which manufacturer's products are described.*

<b>ACOUSTECH, INC.</b> .....	13	<b>CABINART ACOUSTICAL DEV. CORP.</b> .....	124
139 Main St., Cambridge 42, Mass.		69 Fifth Ave., Hawthorne, N.J.	
<b>ACOUSTI-CRAFT</b> —Div. of Creative Products, Inc.....	166	<b>CALBEST ELECTRONICS</b> .....	14, 58, 69
14122 Aetna St., Van Nuys, Calif.		4801 Exposition Blvd., Los Angeles 16, Calif.	
<b>ACOUSTIC RESEARCH, INC.</b> .....	33, 115	<b>CHANNEL MASTER CORP.</b> .....	14, 70, 124
24 Thorndike St., Cambridge 41, Mass.		Ellenville, N.Y.	
<b>ADC</b> —Audio Dynamics Corp.....	40, 47, 115	<b>CLARK, DAVID, CO., INC.</b> .....	171
Pickett District Rd., New Milford, Conn.		360 Franklin St., Worcester, Mass. 01601	
<b>AEROVOX CORP.</b> .....	106	<b>COLORSOUND, INC.</b> .....	171
New Bedford, Mass. 02741		1044 E. Edna Pl., Covina, Calif.	
<b>AKG OF AMERICA</b> —Div. of North American Philips Co., Inc.....	157	<b>COMPONENTS CORP.</b> .....	33, 47
125 Park Ave., New York, N.Y. 10017		Denville, N.J.	
<b>ALTEC LANSING CORP.</b> —Subsidiary of Ling-Temco-Vought, Inc.....	13, 51, 56, 115, 157	<b>CONAR INSTRUMENTS</b> —Div. of Nat'l. Radio Institute.....	14, 124
1515 S. Manchester Ave., Anaheim, Calif.		3939 Wisconsin Ave., Washington 16, D.C.	
<b>AMERICAN</b> —Greentree Electronics Corp.....	110	<b>CONCERTONE</b> —Div. of Astro-Science Corp.....	80, 106
291 S. La Cienega Blvd., Beverly Hills, Calif. 90211		9731 Factorial Way, South El Monte, Calif. 91733	
<b>AMERICAN GELOSO ELECTRONICS, INC.</b> .....	77	<b>CONCORD ELECTRONICS CORP.</b> .....	80
251 Park Avenue S., New York, N.Y. 10010		809 N. Cahuenga Blvd., Los Angeles 38, Calif.	
<b>AMERICAN MICROPHONE CO.</b> .....	157	<b>CRAIG PANORAMA, INC.</b> .....	80
First and George, Galien, Mich.		3412 S. La Cienega Blvd., Los Angeles, Calif. 90016	
<b>AMPEX CORP.</b> .....	77, 110	<b>CROWN INTERNATIONAL</b> —Subsidiary of International Radio & Electronics Corp.....	81
401 Broadway, Redwood City, Calif. 94063		1718 W. Mishawaka Rd., Elkhart, Ind. 46517	
<b>AMPLIFIER CORP. OF AMERICA</b> .....	79, 106	<b>DELCO RADIO</b> —Div. of General Motors Corp.....	125
398 Broadway, New York, N.Y. 10013		Kokomo, Ind. 46901	
<b>APPARATUS DEVELOPMENT CO., INC.</b> .....	70	<b>DE WALT</b> —Div. of United Scientific Labs., Inc.....	14, 58
Drawer 153, Wethersfield 9, Conn.		35-15 37th Ave., Long Island City 1, L.I.	
<b>ARGOS PRODUCTS CO.</b> .....	118	<b>DUAL</b> —United Audio.....	33, 40, 82
600 S. Sycamore St., Genoa, Ill.		12 W. 18th St., New York, N.Y. 10011	
<b>ARGUS-X ELECTRONICS, INC.</b> .....	122	<b>DUBBINGS ELECTRONICS INC.</b> .....	106
315 West End Ave., New York, N.Y. 10023		226 Franklin Ave., Hewlett, N.Y. 11557	
<b>ASTATIC CORP., THE</b> .....	40, 158, 171	<b>DYNACO INC.</b> .....	14, 40, 47, 58, 69, 82, 158
Conneaut, Ohio		3912 Powelton Ave., Philadelphia, Pa. 19104	
<b>ATLAS SOUND</b> —Div. of American Trading and Production Corp.....	122	<b>EASTMAN</b> —Eastman Kodak Co.....	111
1419-51 39th St., Brooklyn, N.Y. 11218		343 State St., Rochester 4, N.Y.	
<b>AUDIO ORIGINALS</b> .....	166	<b>EICO ELECTRONIC INSTRUMENT CO., INC.</b> .....	15, 52, 58, 69, 82, 125
474 S. Meridian, Indianapolis, Ind.		131-01 39th Ave., Flushing, N.Y. 11352	
<b>AUDIOTAPE</b> —Audio Devices, Inc.....	106, 111	<b>ELAC</b> —Benjamin Electronic Sound Corp.....	42
235 E. 42nd St., New York, N.Y. 10017		80 Swalm St., Westbury, N.Y.	
<b>AUDIO-TECH LABORATORIES</b> .....	122	<b>ELECTRO-VOICE, INC.</b> .....	125, 158
2819 Newkirk Ave., Brooklyn, N.Y. 11226		Buchanan, Mich.	
<b>AUDIOTEX MFG. CO.</b> —Div. of GC-Textron Electronics, Inc.....	106, 158	<b>EMERSON RADIO INC.</b> .....	82
400 S. Wyman St., Rockford, Ill. 61101		680 Fifth Ave., New York, N.Y. 10019	
<b>B &amp; K MFG. CO.</b> —Div. of Dynascan Corp.....	70	<b>EMI</b> —Scope Electronics Corp.....	47, 130
1801 W. Belle Plaine Ave., Chicago, Ill. 60613		235 E. 42nd St., New York, N.Y. 10017	
<b>BARZILAY FURNITURE MFG. CO. INC.</b> .....	167	<b>EMPIRE SCIENTIFIC CORP.</b> .....	33, 42, 47, 131
17303 S. Western Ave., Gardena, Calif. 90247		845 Stewart Ave., Garden City, N.Y.	
<b>BELL</b> —TRW Columbus Div.....	13, 51, 56, 79	<b>ERIC ELECTRONICS CORP.</b> .....	20, 52, 60
6325 Huntley Rd., Columbus, Ohio 43224		2115 Colorado Ave., Santa Monica, Calif.	
<b>BIGG OF CALIFORNIA</b> .....	51, 122	<b>ESTEY ELECTRONICS, INC.</b> .....	83
5047 W. Pico Blvd., Los Angeles, Calif. 90019		201 W. John St., Hicksville, L.I., N.Y.	
<b>BOGEN COMMUNICATIONS</b> —Div. of Lear Siegler, Inc.....	14, 33, 51, 56	<b>EUPHONICS CORP.</b> .....	42
P.O. Box 500, Paramus, N.J.		Guaynabo, Puerto Rico	
<b>BOZAK, R. T., MFG. CO., THE</b> .....	122, 168	<b>FANON-MASCO</b> —Fanon Electronic Industries, Inc.....	83, 107
Box 1166, Darien, Conn. 06821		439 Frelinghuysen Ave., Newark, N.J. 07114	
<b>BRENELL</b> —Fen-Tone Corp.....	79	<b>FARGRAM</b> —Fargo Co.....	160
106 Fifth Ave., New York, N.Y. 10011		1162 Bryant St., San Francisco 3, Calif.	
<b>BURGESS BATTERY CO.</b> —Div. of Servel, Inc.....	111	<b>FERRODYNAMICS CORP.</b> .....	112
Freeport, Ill.		Lodi, N.J.	
<b>BURSTEIN-APPLEBEE CO.</b> .....	52, 58	<b>FERROGRAPH</b> —Ercona Corp.....	83
1012-14 McGee St., Kansas City 6, Mo.		432 Park Ave. S., New York, New York 10016	
<b>BUTOBA</b> —Stanford International.....	79	<b>FINCO</b> —The Finnev Co.....	72
569 Laurel St., San Carlos, Calif.		34 W. Interstate St., Bedford, Ohio 44014	
		<b>FISHER RADIO CORP.</b> .....	20, 34, 53, 61, 69, 131, 171
		21-21 44th Dr., Long Island City 1, N.Y.	
		<b>FRAZIER INC.</b> .....	132
		2649 Brenner Dr., Dallas, Texas 75220	
		<b>FREEMAN ELECTRONICS CORP.</b> .....	83, 171
		729 N. Highland Ave., Los Angeles, Calif. 90038	



# SPECIAL OFFER

FROM COMMAND RECORDS

## Your Choice Of Two Special Edition Command Stereo Samplers

Command Records has released two special-edition sampler albums to acquaint you with the best of Command albums . . . both popular and classical.

These magnificent albums will open your eyes to the broad scope and magnitude of Command recordings . . . will reveal to you the unparalleled technical advances Command engineers have achieved in master-recording on tape and on 35 mm magnetic film.

Here is your opportunity to savor the full range of Command artistry. The POPULAR SAMPLER contains 12 of the most exciting selections from 12 different Command Popular Albums. The CLASSIC SAMPLER contains 8 magnificent selections from 8 different Command Classical Albums.

Unlike many sampler albums, these Command Albums were created to give you full, uninterrupted musical pleasure. There is no sales message . . . no talk. The musical selections in the Popular Album are complete — not excerpts! In the Classical Album, great care was taken to select complete movements for your greatest possible enjoyment.

The musical content and the quality of the vinyl pressings are representative of the best of Command. No expense has been spared to make certain that these albums reflect the integrity and leadership that Command enjoys today.

Command sincerely believes that you will consider these albums among the finest and most enjoyable in your entire record collection.

### THESE ALBUMS NOT AVAILABLE IN STORES

To obtain your Command Sampler albums, order direct by mailing convenient coupon to the right. You may select either the Popular Album or the Classical Album for only \$2.98 each. (Command Stereo albums are normally list-priced at \$5.98).

If you wish, you can take advantage of an additional saving by ordering both albums for only \$5.00. Your albums will be shipped postpaid — Command pays all postage and handling. And, you may order as many albums as you wish. But don't delay . . . mail your order today.

**FREE Command Catalog.** You will automatically receive the latest Command Catalog with your order. This color catalog not only contains the complete list of all Command albums both popular and classical available at your dealer, but also a detailed explanation of Command's latest technical advances.

**World leader in recorded sound**  
**Command RECORDS**

1501 Broadway, New York 36, N. Y.  
A Subsidiary of ABC-Paramount Records, Inc.



THE BEST OF 12 DIFFERENT COMMAND POPULAR ALBUMS



THE BEST OF 8 DIFFERENT COMMAND CLASSICAL ALBUMS

## POPULAR SAMPLER

12 Complete Selections from 12 Different Popular Command Albums

- **HEAT WAVE**  
(Stereo 35/mm)
- **MOON RIVER**  
(Great Themes from Hit Films)
- **FINALE FROM CAROUSEL**  
(Carousel)  
Alfred Drake, Roberta Peters
- **CHEEK TO CHEEK**  
(Enoch Light and his Orchestra at Carnegie Hall play Irving Berlin)
- **GUITAR ESPANOL**  
(Spanish Guitar)  
Tony Mottola
- **LOVE FOR SALE**  
(The Big Band's back in town)
- **VIENI VIENI**  
(Rome Revisited)
- **FORTY-SECOND STREET**  
(Off Beat Percussion)
- **I'M OVER HERE**  
(Something Wonderful)  
Ray Charles Singers
- **CLOSE YOUR EYES**  
(The Persuasive Trombone of Urbie Green)
- **THE CRY OF THE WILD GOOSE**  
(Strange Interlude)
- **NINA**  
(Roman Guitar)

## CLASSIC SAMPLER

8 Selections from the Following 8 Command Classics

- WAGNER** — Der Ring Des Nibelungen — The Ride of the Valkyries. Steinberg . . . Pittsburgh Symph. Orch.
- BRAHMS** — Symphony No. 2 in D Op. 73, 3rd Movement. Steinberg . . . Pittsburgh Symph. Orch.
- BERLIOZ** — Symphonie Fantastique Op. 14 — March to the Gallows. Vandernoot . . . National Symph. Orch. (Paris).
- BEETHOVEN** — Symphony No. 4 in B Flat Op. 60, 4th Movement. Steinberg . . . Pittsburgh Symph. Orch.
- MUSSORGSKY-RAVEL** — Pictures At an Exhibition — The Great Gate at Kiev. Vandernoot . . . Conservatoire Symph. Orch. (Paris).
- RAVEL** — Rapsodie Espagnole — Malagueña. Dervaux . . . Colonne Symph. Orch. (Paris).
- SCHUBERT** — Symphony No. 3 in D, 4th Movement. Steinberg . . . Pittsburgh Symph. Orch.
- RAVEL** — Alborada Del Gracioso. Dervaux . . . Colonne Symph. Orch. (Paris).

### MAIL COUPON TODAY

COMMAND RECORDS Dept. 65-SD  
1501 Broadway, New York 36, N. Y.

Gentlemen: Please send me the Command Sampler Albums I have checked below. I understand Command pays all postage and handling costs.

QUANTITY	ALBUM	PRICE	TOTAL
<input type="checkbox"/> _____	POPULAR SAMPLER	@ \$2.98	_____
<input type="checkbox"/> _____	CLASSICAL SAMPLER	@ \$2.98	_____
<input type="checkbox"/> _____	SPECIAL OFFER (Both Popular & Classical)	@ \$5.00	_____

(Available Only In Stereo)

ENCLOSED IS \$ \_\_\_\_\_ (Check or Money Order)

NAME \_\_\_\_\_  
(Please Print)

ADDRESS \_\_\_\_\_

CITY \_\_\_\_\_ ZONE \_\_\_\_\_ STATE \_\_\_\_\_  
(COM 10-SD & CCD2-SD)

FURN-a-KIT, INC.—Furnette Industries, Inc. 1308 Edward L. Grant Highway, Bronx 52, N.Y.	168	McINTOSH LABORATORY INC. 2 Chambers St., Binghamton, N.Y.	27, 54, 65
FUTTERMAN—Harvard Electronics Co. 693 Broadway, New York, N.Y. 10012	20	MERRELL ELECTRONICS 519 Hendrix St., Brooklyn, N.Y. 11207	28, 54, 65
GALLO ELECTRONICS CORP. 12 Potter Ave., New Rochelle, N.Y.	72	MICROTRAN CO., INC. 145 E. Mineola Ave., Valley Stream, N.Y.	107
GARRARD—Div. of British Industries Corp. 80 Shore Rd., Port Washington, N.Y.	35, 49	MINNEAPOLIS SPEAKER CO. 3806 Grand Ave. S., Minneapolis, Minn. 55409	148
GC ELECTRONICS CO.—Div. of Textron Electronics, Inc. 400 S. Wyman St., Rockford, Ill. 61101	72	MIRACORD—Benjamin Electronic Sound Corp. 80 Swalm St., Westbury, N.Y.	37
GENERAL ELECTRIC CO. 2200 N. 22nd St., Decatur, Ill. 62525	42, 49	MIRANDA—Allied Impex Corp. 300 Park Ave. S., New York, N.Y. 10010	90
GOODMANS OF ENGLAND—UTC Sound Div. Garden City, N.Y.	132	MOOG, R. A., CO. Trumansburg, N.Y. 14886	173
GRADO LABORATORIES, INC. 4614 Seventh Ave., Brooklyn, N.Y. 11220	36, 43, 47, 49, 134	MURRAY-TONE—Murray-Carson Corp. 2424 E. 55th St., Indianapolis 20, Ind.	148
GRAETZ—Warman Precision Products Corp. 172 Madison Ave., New York, N.Y. 10016	84	NATIONAL KITS INC. 140 Tenth Ave., New York, N.Y. 10011	28, 65
GRAY RESEARCH AND DEVELOPMENT CO. INC. 333 Roberts St., East Hartford, Conn. 06108	36, 47	NORELCO—North American Philips Co., Inc. 100 E. 42nd St., New York, N.Y. 10017	91
GRECO CABINET CORP. 2862 Fulton St., Brooklyn, N.Y. 11207	168	NORTRONICS CO., INC., THE 8101 10th Ave. N., Minneapolis 27, Minn.	107
HARMAN-KARDON, INC.—Div. of Jerrold Electronics Corp. Plainview, Long Island, N.Y.	20, 53, 61	NUCLEAR PRODUCTS CO. 10173 E. Rush St., El Monte, Calif.	49
HARTLEY PRODUCTS CO. 519 E. 162nd St., New York, N.Y. 10051	134	OKI—Chancellor Electronics, Inc. 457 Chancellor Ave., Newark, N.J.	91
HEATH CO.—Subsidiary of Daystrom, Inc. Benton Harbor, Mich.	21, 36, 53, 62, 70, 84, 134, 169	OLSON ELECTRONICS, INC. 260 S. Forge St., Akron 8, Ohio	28, 54, 65, 148, 160, 173
HI-FI HQ INC. 235 E. 60th St., New York, N.Y. 10022	22, 172	ORTOFON—Elpa Marketing Industries, Inc. New Hyde Park, N.Y.	43, 47
INTER-MARK CORP. 29 W. 36th St., New York, N.Y. 10018	84	PACO ELECTRONICS CO., INC.—Div. of Precision Apparatus, Inc. 70-31 84th St., Glendale 27, N.Y.	28, 54, 66, 70, 148
IONOVAC—DuKane Corp. St. Charles, Ill. 60174	136	PICKERING AND CO., INC. Sunnyside Blvd., Plainview, L.I., N.Y.	43
JANSZEN—Neshaminy Electronic Corp. Edison-Furlong Rd., Furlong, Pa.	137	PILOT RADIO CORP.—Subsidiary of The Jerrold Corp. 100 Electra Lane, East Station, Yonkers, N.Y.	29, 54, 66, 148
JENSEN MFG. CO.—Div. of The Muter Co. 6601 S. Laramie Ave., Chicago, Ill. 60638	137, 172	PML—Ercona Corp. 432 Park Ave. S., New York, N.Y. 10016	160, 173
JERROLD ELECTRONICS CORP. 15th and Lehigh, Philadelphia 32, Pa.	72	QUADRAMATIC—Pure Sonics, Inc. 4938 W. North Ave., Chicago, Ill. 60639	29
JFD ELECTRONICS CORP. 1462 62nd St., Brooklyn, N.Y. 11219	73	QUAM-NICHOLS CO. Marquette Rd. and Prairie Ave., Chicago, Ill. 60637	148
KARG LABORATORIES, INC. 162 Ely Ave., S. Norwalk, Conn.	63	RCA 30 Rockefeller Plaza, New York, N.Y. 10020	37, 55, 74, 92, 112, 160
KARLSON—K. R. C. Corp. P.O. Box 117, W. Hempstead, L.I., N.Y. 11552	141, 169	R-COLUMBIA PRODUCTS CO., INC. 2008 St. Johns Ave., Highland Park, Ill.	173
KENWOOD ELECTRONICS, INC. 3700 S. Broadway Pl., Los Angeles, Calif. 90007	22, 53, 63	REALISTIC—Radio Shack Corp. 730 Commonwealth Ave., Boston 17, Mass.	29, 55, 66, 92, 149
KERSTING MFG. CO. 504 S. Date Ave., Alhambra, Calif.	169	REK-O-KUT CO., INC. 38-19 108th St., Corona 68, N.Y.	38, 48
KLH RESEARCH AND DEVELOPMENT CORP. 30 Cross St., Cambridge, Mass. 02139	22, 36, 53, 64, 70, 141	RESLO—Fen-Tone Corp. 106 Fifth Ave., New York, N.Y. 10011	162
KLIPSCH AND ASSOCIATES, INC. P.O. Box 96, Hope, Arkansas 71801	142	REVERE-WOLLENSAK—Div. of The 3M Co. 2501 Hudson Rd., St. Paul 19, Minn.	92
KNIGHT—Allied Radio Corp. 100 N. Western Ave., Chicago 80, Ill.	22, 36, 53, 64, 88, 142, 160, 169, 172	R.G.F. ENGINEERING & DESIGN— Fredro Sound & Electronics Co. 2250 Sheraton Pl., San Mateo, Calif.	149
KNIGHT-KIT—Allied Radio Corp. 100 N. Western Ave., Chicago 80, Ill.	23, 54, 64, 107	RICOH INDUSTRIES, U.S.A., INC. 432 Park Ave. S., New York, N.Y. 10016	98
KORTING RECORDER SALES CORP.—Div. of Matthew Stuart & Co., Inc. 3650 Dyre Ave., Bronx 66, N.Y.	70, 88	ROBERTS ELECTRONICS—Div. of Rheem Mfg. Co. 5922 Bowcroft St., Los Angeles, Calif. 90016	98
KOSS ELECTRONICS, INC. 2227 N. 31st St., Milwaukee 8, Wisc.	172	ROBINS INDUSTRIES CORP. 15-58 127th St., Flushing, N.Y. 11356	49, 110
KOUYOH INTERNATIONAL CORP. 1200 Santee St., Los Angeles 15, Calif.	89	ROCKFORD SPECIAL FURNITURE CO. 2024 23rd Ave., Rockford, Ill.	149, 170
LAFAYETTE RADIO ELECTRONICS CORP. 111 Jericho Turnpike, Syosset, L.I., N.Y. 11791	26, 36, 49, 54, 64, 89, 107, 144, 160, 169, 173	ROYCE ELECTRONIC DEVELOPMENTS, INC. P.O. Box 321, Valley Stream, L.I., N.Y.	173
LAHTI OF ANN ARBOR, INC. 1200 N. Main St., Ann Arbor, Mich.	145	SARKES TARZIAN INC. East Hillside Dr., Bloomington, Ind.	112
LANSING, JAMES B., SOUND, INC. 3249 Casitas Ave., Los Angeles 39, Calif.	145	SCHOBOR ORGAN CORP., THE 43 W. 61st St., New York, N.Y. 10023	29, 110, 149
LEAK—Ercona Corp. 432 Park Ave. S., New York, N.Y. 10016	26, 64, 147	"SCOTCH" TAPES—The 3M Co. 2501 Hudson Rd., St. Paul, Minn. 55119	112
LEONHARDT ENGINEERING CO. 5126 E. State St., Rockford, Ill.	147	SCOTT, H. H., INC. 111 Powder Mill Rd., Maynard, Mass.	29, 56, 66, 149
LESA OF AMERICA CORP. 3217 61st St., Woodside, N.Y. 11377	37	SHARPE, E. J., INSTRUMENTS, INC. 965 Maryvale Dr., Buffalo, N.Y. 14225	173
LUCOR ELECTRONICS, INC. 22-20 40th Ave., Long Island City 1, N.Y.	90	SHERWOOD ELECTRONIC LABORATORIES, INC. 4300 N. California Ave., Chicago 18, Ill.	30, 56, 69, 149, 174
MAGNECORD—Midwestern Instruments, Inc. P.O. Box 7509, Tulsa, Okla. 74105	90	SHURE BROTHERS, INC. 222 Hartrey Ave., Evanston, Ill.	44, 48, 49, 162
MARANTZ CO., INC. 25-14 Broadway, Long Island City, N.Y. 11106	26, 64	SONOTONE CORP. Elmsford, N.Y. 10523	44, 48, 150, 163
MARCOR, INC. 200 S. Tioga St., Ithaca, N.Y.	148, 173	SONY—Superscope, Inc. 8150 Vineland Ave., Sun Valley, Calif.	99, 150, 164, 174
MARTEL ELECTRONICS 2356 S. Cotner Ave., Los Angeles, Calif. 90064	90	SOUNDCRAFT—Reeves Soundcraft Great Pasture Rd., Danbury, Conn.	113

(Continued on page 156)

# Records at Discount through our Special Membership Plan

**BUILD YOUR RECORD LIBRARY INEXPENSIVELY, QUICKLY, CONVENIENTLY  
NO "AGREE TO PURCHASE" OBLIGATION — CHOOSE RECORDS YOU WANT**

**CITADEL RECORD CLUB** is a unique kind of membership club that entitles its members to purchase hi-fi and stereo albums at discount prices; all categories of music are available including classical, popular, jazz, show hits, folk, children's records etc. Prices never vary from our published price list. There are never any "list price" purchases through Citadel.

- no "agree to purchase"
- freedom of selection
- prompt service
- periodic specials
- free Schwann catalog
- 100% guarantee

**CITADEL RECORD CLUB MEMBERSHIP** — the complete record service for you and your family. Whether your music interests are classical, popular, jazz, show hits, folk — whether you prefer one label or a variety of labels and artists . . . all are available through Citadel.



**CITADEL MEMBERSHIP — THE PROVEN METHOD OF RECORD BUYING USED BY THOUSANDS OF SATISFIED CLUB MEMBERS BECAUSE . . .**

- **YOU DECIDE ON YOUR PURCHASES** — You are not obligated to purchase any particular quantity of records. Buy as few or as many records as you want, when you want them . . . the choice is always yours. Citadel has no "agree to purchase" requirement of any kind.
- **YOU HAVE COMPLETE FREEDOM OF SELECTION** — Virtually any record or album by any artist on any label is available including ABC, Angel, Atlantic, Audio Fidelity, Bach Guild, Blue Note, Caedmon, Capitol, Columbia, Command, Decca, DGG, Dot, Epic, Folkways, Impulse, Kapp, Liberty, London, Mercury, MGM, Pacific Jazz, Period, Philips, Prestige, RCA, Riverside, Roulette, Spoken Arts, United Artists, Vanguard, Verve, Warner Brothers, Westminster, and hundreds of others as well as most imports. Again, the choice is completely up to you. Citadel has no "pre-selected" list of recordings for you to choose from. We do not limit your choice in any way.
- **PROMPT SERVICE** — Many orders are shipped the same day received, rarely later than the next several days. In the event of a delay, partial shipments are made and your order completed as soon as the record is available and, of course, without any additional cost to you.
- **PERIODIC SPECIALS** — Periodically you receive a list of hit albums from all categories of music at prices up to 55% off list. The selections depend on those special purchases we have been able to make. Again, you are under no obligation to purchase any of these selections.
- **FREE! SCHWANN RECORD CATALOG** — With your membership you receive this quick reference to over 25,000 albums. This easy-to-use catalog contains separate sections for classical, popular, ballet, opera, musical shows, folk music, jazz, etc., and lists a separate section for all new releases. You are not restricted to this catalog; it is simply a handy guide.
- **100% GUARANTEE** — All records Citadel supplies to members are guaranteed factory fresh and free of defects or damages of any sort. If a damaged or defective record does get through our inspection, we shall immediately replace it with a perfect copy.

**Special!** Bonus benefits make your Citadel Membership the most valuable club you ever joined

**DIAMOND NEEDLES**



A complete selection of 100% guaranteed, precision engineered diamond needles is available for virtually all cartridges. A clearly pictured, easy-to-follow order form is sent to you with your catalog.

**GIFT CERTIFICATE SERVICE**

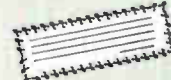

A great help in solving your gift-giving problems to friends and relatives for birthdays, anniversaries, holidays or any special occasions.

**OPTIONAL PRE-RECORDED TAPE DIVISION MEMBERSHIP**



Many Citadel members collect both LP's and pre-recorded 4-track stereo tapes. As an added service we have made all stereo tapes available. All membership benefits apply.

Membership dues is \$3.00 a year (\$1.00 more for tape division membership) . . . a nominal amount if you reflect for a moment on the record and tape purchases you have made within the past year and the prices you have paid. AS A CITADEL MEMBER BUYING RECORDS AND TAPES AT DISCOUNT PRICES, YOUR DUES WILL BE PAID FOR WITH VIRTUALLY THE FIRST PURCHASE YOU MAKE THROUGH THE CLUB. Additional savings quickly mount up, permitting you to buy many more LP'S and tapes. Special bonus benefits make your membership an ever increasing asset as you now have a complete source to serve your needs.

May we suggest that you give Citadel an opportunity of proving its value to you. You enter no obligations, take no risks . . . simply complete the coupon below, enclose your yearly membership dues and upon receipt we shall immediately forward all club membership material to you. We cordially invite you to join thousands of other satisfied Citadel members who are purchasing their records and tapes at discount prices through their Citadel Club membership.

**CITADEL RECORD CLUB**

545 Fifth Avenue, New York, N. Y. 10017 S-5

Enroll me for one year. I am under no obligation to purchase any particular quantity of records or tapes, but those that I do purchase will be at discount price. I am to receive a current Schwann catalog immediately and subsequent periodic lists of specially priced hit albums. If after trying membership for 30 days I am not completely satisfied, I can get my full membership dues back immediately. Also, include the free quality record cleaning cloth as a gift.

- \$3.00 enclosed. Record membership only.
- \$4.00 enclosed. Both record and tape membership. (Complete Harrison tape catalog as well as the Schwann catalog sent)

FULL NAME \_\_\_\_\_  
STREET \_\_\_\_\_  
CITY \_\_\_\_\_ STATE \_\_\_\_\_

**SATISFACTION GUARANTEED** — Try membership in the Citadel Record Club for 30 days. If at the end of that time you are not completely satisfied, simply request your membership dues back and it will be immediately refunded, no questions asked.

**FREE!** Record Cleaning Cloth

Act now. Fill out the coupon, enclose your dues and we will include a free quality record cleaning cloth as a gift. This is our way of thanking you for your confidence in us.



# STEREO STATION DIRECTORY

Compiled by  
DAVID LACHENBRUCH

*All known FM stations in the United States and Canada  
that are now broadcasting FM stereo multiplex programs.*

Location	Call Letters	Freq. (mc.)	Location	Call Letters	Freq. (mc.)	Location	Call Letters	Freq. (mc.)
<b>ALABAMA</b>			Walnut Creek.....	KWME	92.1		WFMQ	107.5
Birmingham.....	WCRT-FM	96.5	Woodland.....	KATT	102.5		WFMT	98.7
	WSFM	93.7					WKFM	103.5
Huntsville.....	WAHR	99.1	<b>COLORADO</b>				WXRT	93.1
	WNDA	92.9	Colorado Springs.....	KLST	94.3	Decatur.....	WSOY-FM	102.9
<b>ALASKA</b>			Denver.....	KFML-FM	98.5	Elmwood Park.....	WXFM	105.9
Anchorage.....	KBYR-FM	102.1		KLIR-FM	100.3	Joliet.....	WJOL-FM	96.7
	KNIK-FM	105.1	Manitou Springs.....	KCMS-FM	102.7	Loves Park.....	WLUV-FM	96.7
<b>ARIZONA</b>			<b>CONNECTICUT</b>			Mattoon.....	WLBH-FM	96.9
Phoenix.....	KEPI	96.9	Brookfield.....	WGHF	95.1	Quincy.....	WGEM-FM	105.1
	KNIX	102.5	Hartford.....	WTIC-FM	96.5	Rock Island.....	WHBF-FM	98.9
Sun City.....	KTPM	106.3	Meriden.....	WBMI	95.7	<b>INDIANA</b>		
Tucson.....	KSOM	92.1	<b>DELAWARE</b>			Columbus.....	WCSI-FM	98.3
<b>ARKANSAS</b>			Wilmington.....	WDEL-FM	93.7	Evansville.....	WIKY-FM	104.1
El Dorado.....	KELD-FM	103.1		WJBR	99.5	Greenfield.....	WSMJ	99.5
	KRIL	99.3	<b>DISTRICT OF COLUMBIA</b>			Indianapolis.....	WFMS	95.5
<b>CALIFORNIA</b>			Washington.....	WASH	97.1	Richmond.....	WISH-FM	107.9
Bakersfield.....	KIFM	92.7		WGMS-FM	103.5	South Bend.....	WNDU-FM	101.3
Beverly Hills.....	KCBH	98.7	(See also Bethesda, Md.)			Terre Haute.....	WVTS	100.7
Coachella.....	KCHQ-FM	93.7	<b>FLORIDA</b>			<b>IOWA</b>		
Fresno.....	KCIB	94.5	Clearwater.....	WTAN-FM	95.7	Ames.....	WOI-FM	90.1
	KXQR	102.7	Cocoa Beach.....	WRKT-FM	104.3	Cedar Rapids.....	KHAK-FM	98.1
Garden Grove.....	KGGK	94.3	Coral Gables.....	WVCG-FM	105.1		WMT-FM	104.5
Long Beach.....	KNOB	97.9	Fort Lauderdale.....	WFLM	105.9	Des Moines.....	KDMI	97.3
Los Angeles.....	KFAC-FM	92.7		WMJR	100.7	Sioux City.....	KDVR	97.9
	KFMU	97.1	Miami.....	WAEZ	102.1	Waterloo.....	KXEL-FM	105.7
	KMLA	100.3		WWPB	101.5	<b>KANSAS</b>		
	KPOL-FM	93.9	Milton.....	WXBM-FM	102.3	Kansas City.....	KCJC	98.1
	KRHM	94.7	Orlando.....	WHOO-FM	96.5	Lawrence.....	KANU	91.5
Palm Springs.....	KDES-FM	104.7	Palm Beach.....	WWOS	97.9	Wichita.....	KCMB-FM	107.3
Riverside.....	KDUO	97.5	Pensacola.....	WPEX-FM	94.1		KQTY	101.3
Sacramento.....	KHIQ	105.1	St. Petersburg.....	WTCX	99.5	<b>KENTUCKY</b>		
	KSFM	96.9	Sarasota.....	WYAK	102.5	Lexington.....	WVLK-FM	92.9
San Diego.....	KBBW	102.5	<b>GEORGIA</b>			Owensboro.....	WSTO	96.1
	KFMX	96.5	Athens.....	WGAU-FM	95.5	<b>LOUISIANA</b>		
	KGB-FM	101.5	Atlanta.....	WKLS	96.1	Monroe.....	KMLB-FM	104.1
	KLRO	94.9		WLTA-FM	99.7	New Orleans.....	WWMT	95.7
San Francisco.....	KPRI	106.5		WSB-FM	98.5	<b>MAINE</b>		
	KAFE	98.1	Columbus.....	WRBL-FM	93.3	Caribou.....	WFST-FM	97.7
	KBCO	105.3	Gainesville.....	WDUN-FM	103.9	<b>MARYLAND</b>		
	KFOG	104.5	<b>HAWAII</b>			Bethesda (Wash., D.C.)	WHFS	102.3
	KMPX	106.9	Honolulu.....	KAIM-FM	95.5		WJMD	94.7
	KPEN	101.3		KPOI-FM	97.5	Towson (Baltimore)...	WAQE-FM	101.9
	KSFR	94.9	<b>IDAHO</b>			<b>MASSACHUSETTS</b>		
	KXXX	88.5	Boise.....	KBOI-FM	97.9	Boston.....	WBCN	104.1
San Jose.....	KEFN-FM	100.3	<b>ILLINOIS</b>				WGBH	89.7
	KSJO-FM	92.3	Bloomington.....	WJBC-FM	101.5	Framingham.....	WKOX-FM	105.7
San Luis Obispo.....	KVEC-FM	92.3	Champaign.....	WSTB	94.5	Waltham.....	WCRB-FM	102.5
Santa Barbara.....	KGUD-FM	99.9	Chicago.....	WEFM	99.5	Worcester.....	WSRS	96.1
	KMUZ	103.3	<b>INDIANA</b>			<b>STEREO/HI-FI DIRECTORY</b>		
Santa Maria.....	KEYM	99.1						
Stockton.....	KUOP	91.3						
Turlock.....	KHOM	92.9						
Ventura.....	KUDU-FM	95.1						
Visalia.....	KONG-FM	92.9						

Location	Call Letters	Freq. (mc.)	Location	Call Letters	Freq. (mc.)	Location	Call Letters	Freq. (mc.)
<b>MICHIGAN</b>			<b>OHIO</b>			<b>UTAH</b>		
Ann Arbor.....	WOAI-FM	102.9	Barberton (Akron)...	WDBN	94.9	Houston.....	KQUE	102.9
Bay City.....	WNEM-FM	102.5	Canton.....	WCNO	106.9		KRBE	104.1
Detroit.....	WABX	99.5	Cincinnati.....	WKRC-FM	101.9	Port Arthur.....	KXYZ-FM	96.5
	WBFG	98.7	Cleveland.....	WCLV	95.5	San Antonio.....	KFMP	93.3
	WDTM	106.7		WDOK-FM	102.1	Wichita Falls.....	KEEZ	97.3
	WGPR	98.7		WNOB	107.9		KNTO	95.1
	WLDM	95.5	Columbus.....	WBNS-FM	97.1	<b>UTAH</b>		
	WOMC	104.3	Fairfield.....	WFOL-FM	94.9	Salt Lake City.....	KSL-FM	100.3
East Lansing.....	WSWM	99.1	Findlay.....	WFIN-FM	100.5	<b>VIRGINIA</b>		
	WVIC	94.9	Kettering.....	WKET-FM	99.9	Martinsville.....	WMVA-FM	96.3
Flint.....	WGMZ	107.9	Mansfield.....	WVNO-FM	106.1	Norfolk.....	WTAR-FM	95.7
Grand Rapids.....	WJFM	93.7	Middletown.....	WPFB-FM	105.9		WYFI	99.7
	WOOD-FM	105.7	Port Clinton.....	WRWR-FM	94.5	Richmond.....	WFMV	103.7
Interlochen.....	WIAA	89.7	Portsmouth.....	WPAV-FM	104.1	Roanoke.....	WSLS-FM	99.1
Midland.....	WQDC	99.7	Springfield.....	WBLY-FM	103.9	<b>WASHINGTON</b>		
Mount Pleasant.....	WCEN-FM	94.5	Toledo.....	WTOL-FM	104.7	Seattle.....	KETO-FM	101.5
			Youngstown.....	WBBW-FM	92.3		KISW	99.9
<b>MINNESOTA</b>			<b>OKLAHOMA</b>				KIXI-FM	95.7
Minneapolis.....	KRSI-FM	104.1	Oklahoma City.....	KFNB	101.9		KLSN	96.5
	KWFM	97.1		KYFM	98.9		KZAM	92.5
	WAYL	96.1	Stillwater.....	KOSU-FM	91.7	Tacoma.....	KLAY-FM	106.1
<b>MISSOURI</b>				KOCW	97.5	<b>WEST VIRGINIA</b>		
Joplin.....	KSYN	92.5	Tulsa.....	KRAV	96.5	Bluefield.....	WHIS-FM	104.5
Kansas City.....	KCMO-FM	94.9				Charleston.....	WKNA	98.5
	KMBC-FM	99.7	<b>OREGON</b>			Martinsburg.....	WEPM-FM	94.3
St. Louis.....	KCFM	93.7	Eugene.....	KFMY	97.9	<b>WISCONSIN</b>		
	KSHE	94.7	Portland.....	KWFS-FM	96.1	Delafield.....	WHAD	90.7
Springfield.....	KTXR	101.5		KGMG	95.5	Eau Claire.....	WIAL	94.1
			Portland.....	KPFM	97.1	Green Bay.....	WBAY-FM	101.1
<b>MONTANA</b>			Springfield.....	KEED-FM	93.1	Kenosha.....	WAXO	96.9
Great Falls.....	KARR-FM	106.3	<b>PENNSYLVANIA</b>			Madison.....	WLIP-FM	95.1
<b>NEBRASKA</b>			Braddock (Pgh.)....	WLOA-FM	96.9		WHA-FM	88.7
Omaha.....	KQAL-FM	94.1	Boyetown.....	WBVO	107.5		WISM-FM	98.1
<b>NEVADA</b>			Chambersburg.....	WCHA-FM	95.1		WMFM	104.1
Las Vegas.....	KORK-FM	97.1	Harrisburg.....	WTPA-FM	104.1		WRVB-FM	102.5
	KRGN	101.9	Johnstown.....	WJAC-FM	95.5	Milwaukee.....	WFMR	96.5
<b>NEW HAMPSHIRE</b>			Philadelphia.....	WDVR	101.1		WMKE	102.1
Mount Washington....	WMTW	94.9		WFLN-FM	95.7	Wausau.....	WTMJ-FM	94.5
<b>NEW JERSEY</b>				WHAT-FM	96.5	West Bend.....	WSAU-FM	95.5
Atlantic City.....	WFPG-FM	96.9		WIFI	92.5		WBKV-FM	92.5
Dover.....	WDHA-FM	105.5	Pittsburgh.....	WQAL	106.1	<b>WYOMING</b>		
Long Branch.....	WRLB	107.1	Reading.....	WKJF	93.7	Cheyenne.....	KVWO-FM	106.3
Princeton.....	WPRB	103.3	Tyrone.....	WRFY-FM	102.5	<b>PUERTO RICO</b>		
Trenton.....	WBUD-FM	101.5	Wilkes-Barre.....	WGMR-FM	101.1	Rio Piedras (San Juan)	WFDI	95.7
<b>NEW MEXICO</b>			York-Hanover.....	WYZZ	103.3	<b>ALBERTA</b>		
Albuquerque.....	KHFM	96.3		WYCR	98.5	Calgary.....	CHFM-FM	95.9
Los Alamos.....	KRSN-FM	98.5	<b>RHODE ISLAND</b>			Edmonton.....	????	100.3
<b>NEW YORK</b>			Providence.....	WPFM	95.5	<b>BRITISH COLUMBIA</b>		
Babylon, L.I.....	WGLI-FM	94.3		WXCN	101.5	Kamloops.....	CFM-FM	98.3
Binghamton.....	WNBF-FM	98.1	<b>SOUTH CAROLINA</b>			Vancouver.....	CHQM-FM	103.5
Buffalo.....	WADV	106.5	Beaufort.....	WBEU-FM	98.7	<b>MANITOBA</b>		
	WDCX	99.5	Columbia.....	WCOS-FM	97.9	Winnipeg.....	CJOB-FM	97.5
Fresh Meadows, L.I....	WTFM	103.5	North Charleston....	WKTM	102.5		CJOM-FM	94.3
Garden City, L.I.....	WLIR	92.7	Spartanburg.....	WSPA-FM	98.9		CKY-FM	92.1
New York.....	WABC-FM	95.5	<b>TENNESSEE</b>			<b>ONTARIO</b>		
	WKCR	89.9	Chattanooga.....	WDOD-FM	96.5	London.....	CFPL-FM	95.9
	WNBC-FM	97.1	Greenville.....	WGRV-FM	94.9	Ottawa.....	CFMO-FM	93.9
	WQXR-FM	96.3	Kingsport.....	WKPT-FM	98.5	Sault Ste. Marie.....	CJIC-FM	100.5
Pachogue, L.I.....	WPAC-FM	106.1	McKenzie.....	WKTA	106.9		CKCY-FM	104.3
Riverhead, L.I.....	WAPC-FM	103.9	Morristown.....	WMTN-FM	95.9	Toronto.....	CHFI-FM	98.1
Rochester.....	WCMF	96.5	Nashville.....	WNFO-FM	103.3		CKFM-FM	99.9
Schenectady.....	WGFM	99.5		WSIX-FM	97.9	Windsor (Detroit)....	CKLW-FM	93.9
Syracuse.....	WSYR-FM	94.5	Sevierville.....	WSEV-FM	102.1	<b>QUEBEC</b>		
Utica.....	WUFM	107.3	Tullahoma.....	WJIG-FM	93.3	Montreal.....	CFCF-FM	92.5
<b>NORTH CAROLINA</b>			<b>TEXAS</b>				CJFM-FM	95.9
Burlington.....	WBBB-FM	101.1	Amarillo.....	KCHO	103.5		CKGM-FM	97.7
Charlotte.....	WBT-FM	107.9	Austin.....	KTBC-FM	93.7	Quebec.....	CHRC-FM	98.1
Greensboro.....	WMDE	98.7	Beaumont.....	KHGM	95.1	Sherbrooke.....	CHLT-FM	102.7
	WQMG	97.1	Corpus Christi.....	KTOD-FM	103.1	Verdun.....	CKVL-FM	96.9
Greenville.....	WNCT-FM	107.7	Dallas.....	KIXL-FM	104.5			
Hickory.....	WHKY-FM	102.9		KVIL-FM	105.3			
Leaksville.....	WIRC-FM	95.7	Fort Worth.....	KXOL-FM	99.5			
	WLOE-FM	94.5		WBAP-FM	96.3			
			Gainesville.....	KGAF-FM	94.5			
			Houston.....	KFMK	97.9			
				KODA-FM	99.1			

# "UNEXCELLED

## by any other Tuner!"

Audio, February, 1964

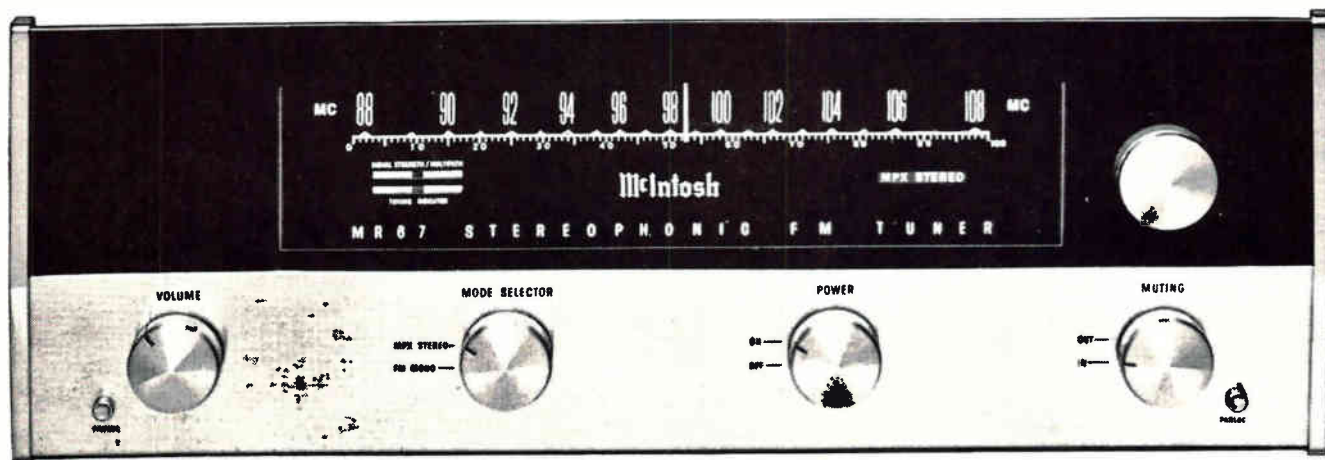

## need we say more?



\$30 down and only  
\$10 a month  
from most dealers!

Send for FREE INFORMATION

### MR 67

11 Chambers St.  
Binghamton, N. Y.

McINTOSH LABORATORY INC.  
11 Chambers St., Binghamton, N. Y.

*Please send me MR 67 information*

NAME \_\_\_\_\_

STREET \_\_\_\_\_

CITY \_\_\_\_\_

STATE \_\_\_\_\_

# AMPLIFIERS

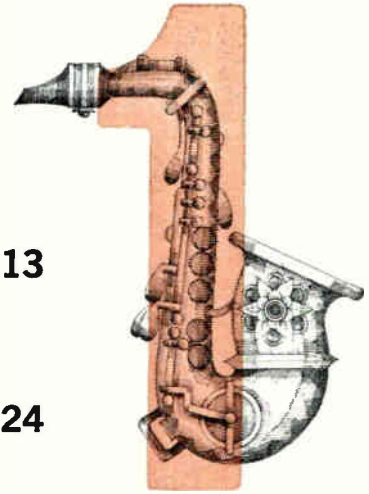

POWER AMPLIFIERS  
 PREAMPLIFIERS  
 INTEGRATED AMPLIFIERS } .....13

## Special Feature

Q & A ON HI-FI AMPLIFIERS.....24

### ACOUSTECH

#### Model I Transistorized Stereo Power Amp

40 w./ch. (continuous sine wave) from 20-20,000 cps; 4-8-16 ohms output; clip-

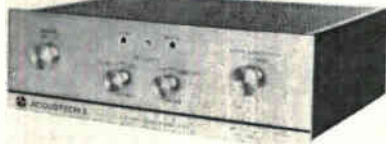

ping power 65 w. @ 8 ohms, 50 w. @ 16 ohms, 40 w. @ 4 ohms; IM & HI each less than .95% at rated output; response 5-50,000 cps  $\pm 1/4$  db (2.5-250,000 cps  $\pm 3$  db); rise time less than 1.75  $\mu$ sec.; hum & noise -85 db below 40 w.; damping factor over 25; input impedance 150,000 ohms; all driver & output transformers omitted; 8-ST7175 silicon output transistors are used plus 6 other transistors, 6 diodes, 6 rectifiers; 15 3/4" x 5" x 12" d. ....\$395.00

#### Model II Transistorized Preamp

Features stepped decade (10 db) and micro (2 db) level controls; square-wave



characteristic is uniform over entire dynamic range; other front-panel controls: input, mode, individual stepped treble and bass for each channel (switched out of circuit when flat), balance, 3-position equalization (RIAA, NAB tape, and microphone), 3-position low-frequency filter (flat, 20 cps, and 70 cps); 3-position high-frequency filter (flat, 6 kc., and r.f.), and 3-position speaker selector (left, right, or both); push-button switches for power, loudness, tape monitor, and muting; input selector provides for switching between three stereo sets of magnetic inputs with input sensitivities varying from 3-15 mv. and three stereo sets of high-level inputs; at 2.5-volt output HI and IM distortion each less than 0.25%; hum and noise better than -60 db below 2.5 volts in magnetic position; response flat from 1-100,000 cps; output impedance about 100 ohms (front panel stereo output for earphones or tape recorder also 100 ohms); two stereo pairs of paralleled audio out-

puts provided plus tape output (output impedance about 1500 ohms) on rear; 15 3/4" x 5" x 12" d.....\$348.00

#### Model III Transistorized Stereo Power Amp Kit

Factory pre-built, pre-adjusted plug-in printed-circuit boards; 40 w./cb. (continuous sine wave) from 20-20,000 cps; 4-8-16 ohm output; clipping power 65 watts at 8 ohms, 50 watts at 4 ohms, 42 watts at 16 ohms; IM distortion less than .45% and HM distortion less than .25% at rated output; rise time below 1  $\mu$ sec.; hum & noise -85 db below 40 watts; damping factor over 70 at 16 ohms; transformerless direct-coupled circuitry; all silicon transistors; 15 3/4" x 5" x 8" d.....\$199.00

#### Model IV Transistorized Stereo Preamp Kit

Factory pre-built, pre-adjusted plug-in printed-circuit boards; full control functions: 2 bass, 2 treble, level, balance, mode, input selector, speaker left-right or both, muting, tape monitor; IM distortion: tuner input .09%—phono input .15%; sensitivities: phono 3 mv. or 10 mv. for 2 volts out, all high-level inputs .5 volt for 2 volts out; hum & noise -75 db on tuner; rise time below 1.25  $\mu$ sec.; outputs: tape and main; inputs: mag. 1, mag. 2 hi., mag. 2 low, tuner, aux., and tape monitor; front-panel headphone output for phones above 600 ohms; 15 3/4" x 4" x 8" d.....\$149.00

#### Model V Transistorized Integrated Stereo Amp

All silicon transistor circuitry with direct-coupled transformerless power amplifier section; all control functions and input sensitivities same as Model IV; no speaker switch; IM distortion under 0.5% at 30 watts equiv. sine-wave power at 8 ohms; HM distortion under .25%, 20-20,000 cps at 20 watts per channel; 4-8-16 ohms; rise time under 2  $\mu$ sec.; hum & noise 70 db below 30 watts; damping factor over 60 at 16 ohms; front-panel headphone output; 15 3/4" x 5" x 8" d.....\$299.00

#### Model VI Transistorized Stereo Preamp

Factory-assembled control center with stepped tone controls; NAB equalization; 30 ohm output impedance; similar in all other specifications to the Model IV; 15 3/4" x 5" x 8" d.....\$249.00

.45 v.; response 20-20,000 cps  $\pm 1$  db; noise 90 db below full output; single level control; protective-circuit sw.; transistors: 2N381, 2N377, Syl 2834, 6-B 1272; 5" h. x 9 3/4" w. x 9 1/4" d.....\$252.00

#### Model 360A Playback Transistorized Integrated Stereo Amp

35 w./ch. music power; HD 1.5% @ 25 w., 20-10,000 cps; response 20-20,000 cps  $\pm 1$



db; input sensitivity for 25 w. @ 1000 cps: radio, tape, aux. 400 mv., mag. phono 4 mv., ceramic phono 200 mv., tape head 1.9 mv., mic. 4.5 mv.; output impedance 4/8 and 16 ohms (ctr. speaker 8/16 ohms); damping factor 10; has conventional operating controls; features solid-state circuitry; matrixing network for center-channel output; automatic reset circuit breakers for channel protection; 28 transistors, 3 diodes & rectifiers; 15" x 5 1/2" x 11 3/8" d. \$389.00 Case optional.....\$11.00

#### SG520 "Graphic Controller"

All-transistor stereo preamplifier with straight-line controls, illuminated push-

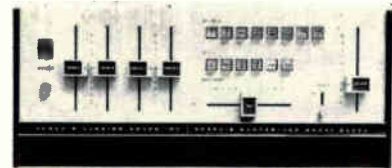

button selector switches, secondary controls concealed behind hinged front panel. Has built-in 1000-cps test tone and provisions for auxiliary "Aural Null" balancing system. Separate "trim" balance control for phono input is provided. Installs from front of mounting panel. Cabinet available as an accessory .....\$450.00

### BELL

#### Model 2440 Stereo Amplifier

Integrated design with 22 w./ch. music power; included are separate bass & treble controls, high & low filter sw., and loudness, balance & volume controls; response 20-20,000 cps  $\pm 1$  db; power response

### ALTEC LANSING

#### Model 351B Transistorized Amplifier

50 watt music power mono design; 4-8-16-125 ohm & 70 volt line outputs; sensitivity

# 1 Amplifiers

35-20,000 cps  $\pm$  1 db @ 20 w. r.m.s./ch.; dist. less than 1% @ 1 kc. & 20 w./ch.; hum & noise -76 db from 22 w.; has 6 dual inputs: tape head, 2 mag. phono, ceramic phono, aux.-MPX, tape amp; 4-



8-16 ohm outputs; 10 tubes; 5 $\frac{3}{8}$ " x 17 $\frac{1}{8}$ " x 19 $\frac{1}{8}$ " d.; with case.....\$159.95

## Model 2420 Stereo Amplifier

Similar in many ways in design & styling to Model 2440; power output is 17 w./ch. music power; has additional dual "tuner" inputs; with case.....\$129.95

## BOGEN

### Model AP250 Integrated Stereo Amp

25 watt per channel (IHF rating); response 20-20,000 cps  $\pm$  1 db; distortion

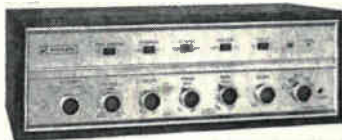

.6% at 25 watts; hum & noise -60 magnetic phono and tape, -75 db aux. and tuner; stereo headphone output; sensitivity low-level inputs 4.5 mv., high-level .5 v.; 4-8-16 ohm outputs; center-channel output; magnetic phono, tape, aux., tuner, tape monitor inputs; controls: 4-position selector, 4-position mode, volume, balance, bass, treble, rumble filter, scratch filter, loudness, tape monitor, blend, power; 10 tubes, 2 silicon and 1 selenium rectifiers; 15" w. x 4 $\frac{3}{4}$ " x 11 $\frac{3}{8}$ " d. ....\$154.95  
Metal enclosure .....\$ 11.95  
Walnut cabinet .....\$ 26.95

### Model AT600 Transistor Amp

Integrated design; 30 w./ch. music power; 25 w./ch. sine wave @ 4 ohms; HD .6%



@ 1 kc. at rated output; IM dist. less than 1%; power bandwidth 20-20,000 cps; response 25-50,000 cps  $\pm$  1 db. Sensitivity: tuner 250 mv., aux. 250 mv., mag. phono 2.5 mv., tape 1.5 mv. Separation 50 db @ 1000 cps; hum & noise -65 db for tuner input & full output; 4, 8, 16 ohm output. Has all conventional front-panel controls and 26 transistors with 6 diodes. 15" w. x 10" d. x 4 $\frac{3}{8}$ ".....\$224.95  
Vinyl-clad walnut metal case.....\$ 14.95  
Walnut case .....\$ 27.95

### Model AP35 Integrated Amp

Stereo design; 17.5 w./ch. music power; response 20-20,000 cps  $\pm$  1 db; dist. .6%

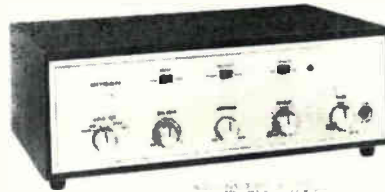

@ rated output; hum & noise -70 db for tuner at rated output; sensitivity: mag phono/tape head 4.5 mv., tuner/aux. .5 v.; 8 & 16 ohm impedance. Controls are input selector, balance, loudness/volume, treble, bass, mode, speaker/phone. Inputs: phono, tape, tuner & aux. 15" w. x 11 $\frac{3}{8}$ " d. x 4 $\frac{3}{4}$ ".....\$99.95  
Vinyl-clad metal cabinet.....\$14.95

## CALBEST ELECTRONICS

### Model 8211 Stereo Amplifier

Dual amplifier produces 15 watts per channel, 30 watts peak power per chan-



nel; integrated amplifier; frequency response 15-40,000 cps; IM distortion less than 1% at 1 watt output; 2 $\frac{1}{2}$ % at rated output; controls for turnover, roll-off, rumble filter, treble, bass, loudness; sensitivity 0.3 v. for high-level inputs, 7 mv. for low-level inputs for rated output; tubes are 6-ECC83/12AX7, 4-EL84/6BQ5, 5U4GB.  
With metal case.....\$159.95  
Salem maple case.....\$199.95  
Limed oak case.....\$189.95  
Walnut case.....\$199.95  
Mahogany case.....\$189.95

## CHANNEL MASTER

### Model 6601 Integrated Stereo Amp

20 watts per channel (music power); 5

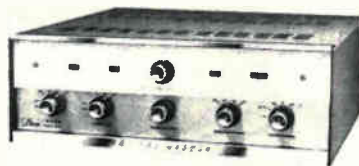

mv. for 10 watts on phono input and 250 mv. for high-level inputs; hum level 46 db below full output; response 20-20,000 cps  $\pm$  1 db; harmonic distortion less than 1%; inputs: tuner, aux., tape, ceramic & mag. cartridge; outputs: 4-8-16 ohms; has output for center-channel; bass, treble, loudness controls; rumble, noise, center-channel switches .....\$101.95

## CONAR

### Model 300 Power Amplifier

Stereo design 5 w./ch.; response 40-12,000



cps; channel separation 50 db. Has crystal or ceramic & tuner inputs. Controls: bass, treble, balance & volume. Kit.....\$31.50  
Wired .....\$41.50

## DE WALD

### Model R-5000 "Troubador"

Monophonic preamp-equalizer, with its own built-in power amplifier, 15 watts



output: harmonic distortion 1% at 12 watts; -75 db hum level; output impedances are 8 and 16 ohms; equalization for LP, tape, and pop; input jacks for magnetic, aux., crystal phono and tuner, tape and tape monitor; controls are selector, loudness, treble and bass.....\$52.95

### Model S-1400A "Concerto" Stereo Amp

17.5 watts per channel; response 20-20,000 cps  $\pm$  1 db; HM distortion under



2% full output; IM under 1%; sensitivity full output .5 v. high-level inputs, 4 mv. at 1000 cps for magnetic input; inputs—magnetic, tuner, ceramic, tape, tape output, aux. ....\$99.95

## DYNACO

### Mark IV Mono Amplifier Kit

40 watts power, up to 80 watts peak; less than 1% IM distortion at 40 watts; fre-



quency response  $\pm$ 0.5 db from 10 cps to 40 kc.; sensitivity 1.3 volts r.m.s. input for 40 watts output; output impedances are 4, 8, and 16 ohms; tubes, 2-EL34, 7199 GZ34 selenium rectifier; over-all size 5" x 14" x 6 $\frac{1}{2}$ ".  
Mark IV Kit .....\$59.95  
Mark IV Factory wired .....\$79.95

### Mark III Mono Power Amplifier Kit

Power output 60 watts continuous up to 140 watts peak; frequency response 6-60,000 cps within  $\frac{1}{2}$  db at 60 watts; sensitivity 1.6 volts r.m.s. input for 60 watts out; IM distortion less than 1% at rated output; damping factor 15; includes patented Biaset for non-critical balancing control; matched set of KT88 power output tubes; other tubes are 6AN8, GZ34, selenium rectifier; power socket for preamp; printed circuit boards; over-all size 9" x 9" x 6 $\frac{3}{4}$ ".  
Mark III Kit .....\$ 79.95  
Mark III Factory wired .....\$ 99.95  
Mark III-70 4-8-16 ohm & 70.7 volt out-





put .....\$104.95  
 Mark III-500, 500 or 125 ohm output  
 .....\$109.95

### "Stereo 35" Power Amplifier Kit

17.5 w./ch. (continuous sine wave); 22.5 w./ch. music power; IM dist. less than



1% at 17 w.; response 10-40,000 cps  $\pm$  1 db; sensitivity 1 v. for 17.5 w. output; damping factor 10; hum & noise -80 db; 8 & 16 ohm outputs; 2-7247, 4-6BQ5, & 2 silicon rect.; 13" x 5 1/2" x 4" h.; with case; kit.....\$59.95  
 Factory wired.....\$79.95

### Stereo 70 Amplifier Kit

Two power amplifiers 35 watts each; full 70 watts on mono operation; printed circuit board; 7199 driver; push-pull EL34's;



frequency response  $\pm$  5 db 15-40,000 cps; IM distortion less than 1% at 35 watts; sensitivity 1.3 volts r.m.s. input for 35 watts output; estimated time of assembly 4-6 hours.

Model 70 Kit .....\$ 99.95  
 Model 70 Factory wired .....\$129.95

### PAM-1 Mono Preamp Kit

Six inputs: high and low level magnetic phono, tuner, TV, tape, plus option of



tape head, mike or extra phono position; two outputs, low impedance (1000 ohms), and tape output; equalization for RIAA, LP, 78 rpm records; tape A-B monitor switch; separate bass and treble controls with up to 15 db of boost or cut at 30 cps and 15 kc; loudness control with switch; IM distortion under .05% at 1.5 volts output; noise level less than 3 microvolts equivalent input noise on RIAA position; frequency response 10 cps to 100 kc,  $\pm$ 1

db; d.c. filaments, 2-12AX7 or ECC83, selenium rectifier; 4 a.c. outlets, 2 switched; scuff-proof and washable; 12" x 6" x 2 3/4"; 7 lbs.; preassembled printed circuit board.

Kit .....\$34.95  
 Factory wired .....\$59.95  
 PM-1 Panel mounting kit .....\$ 2.95

### PAS-3 Stereo Preamp Kit

Inputs for 3 low level stereo and 4 high level stereo; controls for bass, treble, vol-



ume, balance, blend, tape monitor switch, loudness compensation, feedback scratch filter to eliminate high frequency distortion; RIAA equalization; gain: 60 db at 1000 cps on RIAA, 20 db 20-20,000 cps at high level inputs; d.c. filament supply; tubes are 4-ECC83, 12X4 rectifier; 13" x 8" x 4"; kit.....\$ 69.95

PAS-3 Factory wired.....\$109.95  
 PAS-2 Kit (Same as PAS-3 except styling) .....\$ 59.95

PAS-2 Factory wired.....\$ 99.95

PM-3 Panel mounting kit.....\$ 4.95

PK-30 Deluxe panel & knob kit (same as on PAS-3) for modernizing PAS-2 units .....\$ 13.95

### SCA-35 Integrated Stereo Amp Kit

Combines dual-channel preamps & power amps; 17.5 w./ch. continuous sine-wave



power; response 20-20,000 cps  $\pm$  .25 db; IM dist. less than 1% at 17 w.; has 7 pairs inputs: mag. phono, low & high levels; ceramic phono; tape head; radio;

tape; and spare; controls: selector, volume, balance, bass, treble, stereo/mono, loudness, on-off, filter; sensitivity 2.5 mv. at tape head, 4 mv. mag. phono, 1 v. at high-level inputs; 13" x 10" x 4"; with cabinet; Kit .....\$ 99.95

Factory wired.....\$139.95

## EICO

### Model ST-70 Integrated Stereo Amp

Complete stereo control center and amplifier; two 35-watt amplifiers; inputs for tape head, two mag. phono, FM-AM tuners, multiplex; input selection and mode switches; ganged level and separate balance controls; concentric bass and concentric treble controls; tape monitor, tape speed, hi-filter, lo-filter, loudness compensation, phase reversal, and balance-check

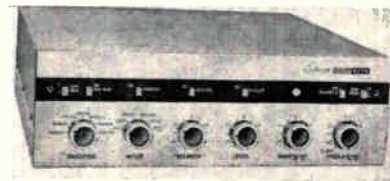

slide switches; center-channel speaker output; IM distortion 1% @ 70 watts; re-

sponse 9-60,000 cps  $\pm$  1 db. Kit.....\$99.95  
 Factory wired.....\$149.95

### Model ST-40 Integrated Stereo Amp

Similar to Model ST-70 except unit has two 20-watt amplifiers; all controls and

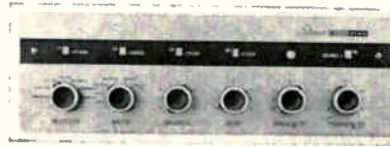

features as in ST-70 but no phase-reversal or choice of tape-speed equalization; IM distortion 1% @ 40 watts; response 12-25,000 cps  $\pm$  1 db.

Kit .....\$79.95  
 Factory wired.....\$129.95

### Model HF-12A Preamp-Amplifier

Power output 12 watts (25 watts peak); Williamson type; 25 to 20,000 cps at 12

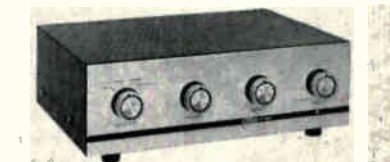

watts,  $\pm$ 0.5 db; harmonic distortion 2% at 30 cps, 1% at 10,000 cps.

Kit .....\$39.95  
 Factory wired .....\$59.95

### Model AF-4 Integrated Stereo Amp

Two single-ended amplifiers preceded by input selection, mode of operation, tone



and level controls; harmonic distortion 4 watts: 1% 100-10,000 cps; IM distortion 2.2% at 4 watts; frequency response  $\pm$ 0.5 db, 30-20,000 cps; sensitivity (input for 4 watts output per channel), for ceramic phono input-0.26 volt; hum & noise-74 db.

Kit .....\$38.95  
 Factory wired.....\$64.95

### 2036 Integrated Stereo Amp

18 w./ch. music power, 14 w./ch. continuous sine wave; has four pairs of inputs in-

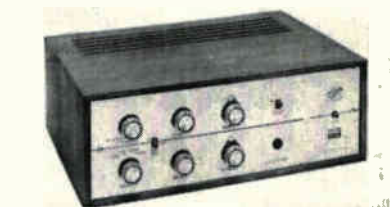

cluding 2.3 mv. mag. phono; response 15-40,000 cps  $\pm$  1 db; power bandwidth at rated power (1% HD) 30-20,000 cps; IM .2% -1 w., 7% -5 w., 2% -14 w.; 8 & 16 ohm outputs; kit .....\$ 79.95  
 Factory wired .....\$109.95  
 Metal cover .....\$ 7.50  
 Walnut case .....\$ 19.95

### 2050 Integrated Stereo Amp

Similar in design & appearance to Model 2036 except 25 w./ch. music power, 22 w./ch. continuous sine wave; has 1.7 mv. mag. phono input; IM .1% -2w., .2%-5 w.,  
 (Continued on page 20)

# Here Are \$1,099.50 Worth of

# HEATHKIT® Stereo Components . . .

# Comparable Factory-Built Brands Cost \$2,579.90!

It Doesn't Make Any Difference Whether You're Price Or Performance Conscious. Regardless of which Heathkit stereo unit you buy, you automatically get both—low price and fine performance.

You enjoy a low price for 3 reasons: 1. because you buy direct from the Heath factory . . . *no dealers, no distributors, no middleman expense.* Reason #2: *no elaborate, expensive packaging.* Your kit is shipped direct to your door in sturdy, protective containers that keep the parts as safe and sound as they were when they left the factory. Reason #3: by quickly and easily building it yourself, labor costs are eliminated. No special skills or knowledge are needed . . . you'll enjoy building your kit . . . it's like getting two hobbies for the price of one! These savings are passed on to *you* . . . in the form of better parts and lower prices.

And with Heath, you're assured of the best performance. Name brand parts combined with experienced design bring you electronic kits you can rely on for the finest, up-to-date performance and life-long dependability. The world's most experienced kit engineers, using the latest techniques in the art of electronics, develop, produce, and test each Heathkit component to insure published specification performance. Every Heathkit product is "specification guaranteed".

To buy factory-built units with the same performance capabilities as these Heathkit components, you'd have to pay *more than twice the Heath price.* So why pay more when you can enjoy the best for less? Select your favorites from this wide array of Heathkit stereo. Then use the handy order form, and order now!

## All-Transistor Stereo Receiver



**All-Transistor, AM/FM/FM Stereo Receiver AR-13 . . . \$195.00**—43 transistor, 18 diode circuitry for cool, fast, economical operation and the quick, natural beauty of "transistor sound." Compact, yet houses two 20-watt power amplifiers, 2 preamplifiers, and a wide band AM/FM/FM Stereo tuner. Attractive walnut cabinet in new low-silhouette styling. Just add 2 speakers for a complete stereo system. 30 lbs.

## Deluxe All Transistor Stereo "Separates"

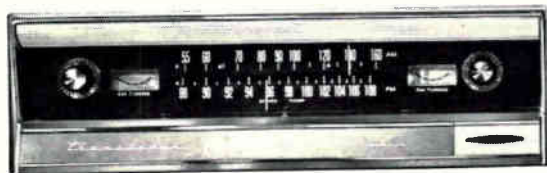

**Deluxe All-Transistor, AM/FM/FM Stereo Tuner AJ-43 . . . \$119.95**—Up to the minute AM, beautifully quiet FM, thrilling natural FM Stereo . . . all reproduced in the exciting new dimension of "transistor sound." Features 25-transistor, 9-diode circuitry, automatic switching to stereo, AFC, stereo phase control, filtered stereo outputs for beat-free recording and handsome tan vinyl-clad steel cabinet. 18 lbs.



**Matching Deluxe All-Transistor 70-Watt Stereo Amplifier AA-21 . . . \$139.95**—Enjoy the quick, unmodified response of every musical instrument, each with its characteristic sound realistically reproduced, with no fading, no faltering! Enjoy 100 watts of music power at  $\pm 1$  db from 13 to 25,000 cps. Enjoy cooler, faster, "hum-free" operation from its 26-transistor, 10-diode circuitry. Easy to build. 29 lbs.

## Low-Cost All-Transistor Stereo "Separates"

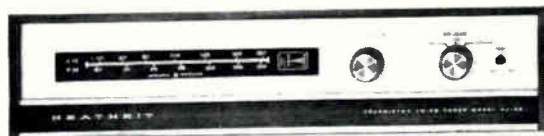

**Low Cost All-Transistor AM/FM/FM Stereo Tuner AJ-33 . . . \$99.95**—Features 20-transistor, 10-diode circuitry for cool, "hum-free" operation and longer life, built-in stereo demodulator, AFC for drift-free reception, stereo broadcast indicator light, filtered stereo outputs, for beat-free recording, concealed secondary controls to prevent accidental system settings, and "low-silhouette" walnut cabinet. 17 lbs.



**Matching All-Transistor 40-Watt Stereo Amplifier AA-22 . . . \$99.95**—Produces a full 66 watts IHF music power at  $\pm 1$  db from 15 to 30,000 cps. Quick, clean, unmodified "transistor sound." 20-transistor, 10-diode circuitry for cool, fast, trouble-free operation and long life. 5 stereo inputs for versatile performance. Concealed secondary controls. Handsome "low-silhouette" walnut cabinet. 23 lbs.

## Deluxe Tube-Type Stereo "Separates"



Deluxe "Tube-Type" AM/FM/FM Stereo Tuner AJ-41 . . . \$119.95—Deluxe features include built-in stereo circuitry, automatic stereo indicator light, adjustable AFC for drift-free reception, adjustable FM squelch, stereo phase control, individual tuning meters, filtered stereo tape recorder outputs, fly-wheel tuning, and handsome luggage-tan, vinyl-clad steel cabinet. Easy to build. 26 lbs.

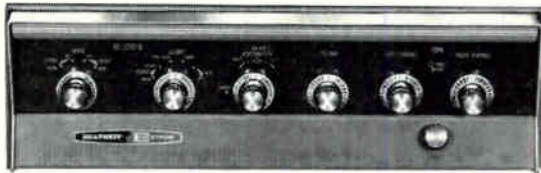

Matching "Tube-Type" 50-Watt Stereo Amplifier AA-100 . . . \$84.95—Value leader in the industry! Features 5 stereo inputs, separate monophonic input, versatile controls, mixed channel center speaker output, and a power response of  $\pm 1$  db from 30 cps to 15 kc. Advanced circuit board construction for quick, easy assembly. Attractively styled in luggage-tan, vinyl-clad steel cabinet . . . matches any decor! 36 lbs.

## Value-Line Tube-Type Stereo "Separates"



Low-Cost "Tube-Type" AM/FM/FM Stereo Tuner AJ-32 . . . \$89.95—Boasts features and capabilities of tuners selling for 3 times its price! Built-in stereo circuit, stereo indicator light, variable squelch, stereo phase control, adjustable AFC, individual "bar" tuning meters, filtered stereo tape recorder outputs, and factory built & aligned "front-end." Tan vinyl-clad steel cabinet. 21 lbs.

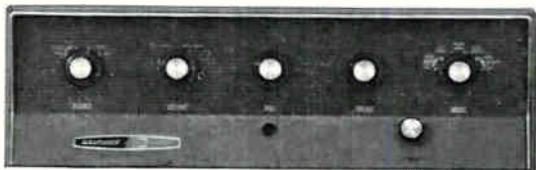

Budget-Saver "Tube-Type" 28-Watt Stereo Amplifier AA-151 . . . \$59.95—The AA-151 is ready to accept any stereo or mono program source, offers complete controls, and delivers plenty of hi-fi rated power. Features two hi-fi rated 14-watt channels, preamps and power amplifiers, 4 stereo music sources, stereo or mono operation, and famous patented Heath Ultra-Linear® circuit. Matches the AJ-32 in styling. 29 lbs.

## Budget-Saver Tube-Type Stereo "Separates"

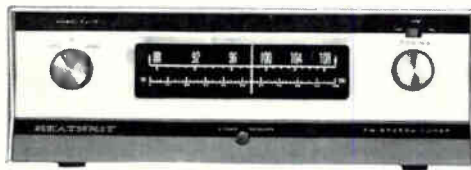

New FM/FM Stereo "Tube-Type" Tuner AJ-13 . . . Only \$49.95—Easy to own! Only 3 simple controls to operate. Features built-in FM stereo circuitry, stereo indicator light, automatic frequency control for drift-free reception, flywheel tuning, lighted slide-rule dial, external antenna terminals, pre-assembled, prealigned "front end", and new mocha brown, beige & black color styling. Matches the AA-32 Amplifier. 13 lbs.

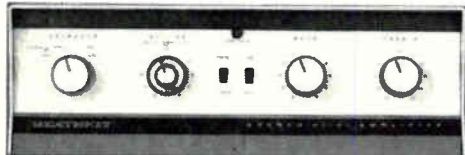

New 16-Watt "Tube-Type" Stereo Amplifier AA-32 . . . \$39.95—An inexpensive way to start a modern stereo system in your home. Operates with magnetic as well as ceramic phono cartridges; delivers full power (20 watts IHF) within  $\pm 1$  db from 30 to 30,000 cps; has full-range controls, 4 stereo inputs, 2 four-stage preamplifiers, 2 push-pull power output stages; plus new mocha brown, beige, & black color styling. Matches the AJ-13 Tuner. 15 lbs.

Buy Now—Use this Order Blank



Note: All prices and specifications subject to change without notice.

Enclosed find  check  money order.

Please ship C.O.D.

On Express orders do not include transportation charges—they will be collected by the express agency at time of delivery.

On Parcel Post orders include postage for weight shown.

All prices are net F.O.B. Benton Harbor, Michigan and apply to Continental U. S. and Possessions only, 20% deposit is required on all C.O.D. orders.



### FREE 1965 CATALOG

See these and over 250 other exciting Heathkits available in easy-to-build kit form. Save 50% or more by doing the easy assembly yourself! Send for your free catalog today!

Please send free Heathkit Catalog.

SHIP VIA:  Parcel Post  Express  Freight  Best Way

Postage

Total

NAME \_\_\_\_\_ (Please Print)

ADDRESS \_\_\_\_\_

CITY \_\_\_\_\_ STATE \_\_\_\_\_ ZIP NO. \_\_\_\_\_

HEATH COMPANY Dept. 42-10-1  
Benton Harbor, Michigan 49023

## ORDER BLANK

Quantity	Model	Description	Wt.	Price Ea.	Total

HF-171

# 1 Amplifiers

1%-17 w., 2%-22 w.; less cabinet; kit ..... \$ 92.50  
 Factory wired .....\$129.95

## 2080 Integrated Stereo Amp

40 w./ch. music power & continuous sine wave; has center speaker drive & 4 pairs of inputs including 1 low level (1 or 3.3. mv. switched mag. phono); response 10-80,000 cps  $\pm 1$  db; power bandwidth at rated power (1% HD) 20-20,000 cps; IM .2%-1 w., 1.1%-40 w.; 4-8-16 ohm outputs; has center speaker level control (4 pos. & off). Kit .....\$112.50  
 Factory wired .....\$159.95  
 Metal cover .....\$ 7.50  
 Walnut case .....\$ 19.95

## ERIC

### "The Sierra" SA-400 Transistor Integrated Stereo Amp

25 w./ch. sine-wave power (50 w./ch. peak); response 10-30,000 cps  $\pm 1$  db; HD less than 1%; hum & noise 80 db below full output. Inputs: mag. phono (sensitivity 2 mv.), tape head (2 mv.), tuner & aux (.125 v.). Output 4-8-16 ohms. Has high & low freq. filters, no output transformers. 3 1/2" x 14 1/4" x 11 1/4" d. Supplied with cabinet .....\$239.00

## FISHER

### Model K-1000 Stereo Power Amp

65 w./ch. continuous sine-wave; HD .25% & IM dist. .4% (both at rated output);



response 20-20,000 cps  $\pm 5$  db; 8-48,000 cps  $\pm 1$  db; sensitivity .5 v.; 15 1/8" x 7 3/4" x 12" d.; less cabinet.  
 Kit .....\$279.50  
 SA-1000 Factory wired.....\$329.50

### X-100-C Integrated Stereo Amp

25 w./ch. music power at .5% HD. Features speaker on/off sw.; center-channel

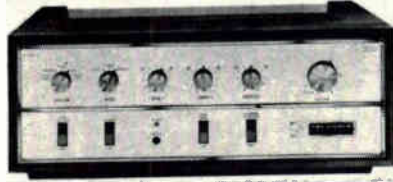

output; tape monitor; hi-freq. filter. Response 20-20,000 cps  $\pm 1$  db; power bandwidth 25-40,000 cps. IM distortion .5% at rated output; hum & noise -80 db; sensitivity: high-level inputs 320 mv., phono inputs 3.5 mv., tape head 2 mv. 4-8-16 ohm outputs. 15 1/2" w. x 4 3/16" h. x 11 1/2" d. Less cabinet.....\$169.50

### X-101-D Integrated Stereo Amp

30 w./ch. music power output @ .5% HD. Has tape monitor, hi-freq. filter; speaker selector; center-channel output; 2 tape recorder outputs. Response 20-20,000 cps  $\pm 1$  db; hum & noise -80 db; power bandwidth 22-43,000 cps; IM dist. .5% at rated power. Sensitivity: high-level inputs 350

mv., phono inputs 3.5 mv., tape-head inputs 2 mv. 4-8-16 ohm output. Appearance similar to X-100-C. 4 3/16" x 15 1/4" w. x 11 1/8" d. Less cabinet.....\$199.50

### X-202-C Integrated Stereo Amp

42 w./ch. music power @ .5% HD. Features tape monitor, speaker selector sw., 2 sets of low-level phono & tape-head inputs; low & hi-freq. filter. Response 20-20,000 cps  $\pm 1$  db; hum & noise -80 db; power bandwidth 22-45,000 cps; IM distortion .4% at rated power. Sensitivity: high-level inputs 265 mv., phono inputs 3.5 mv., tape-head inputs 2 mv. 4-8-16 ohm output. Appearance same as X-100-C. 15 1/8" w. x 4 3/16" h. x 11 1/2" d. Supplied less cabinet. ....\$249.50

### TX-300 Transistorized Integrated Amp

50 w./ch. music power @ .5% HD; IM dist. .5% at rated output; power bandwidth

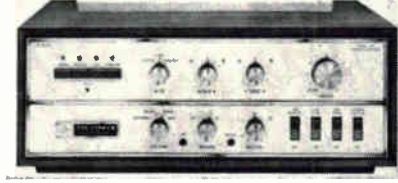

12-50,000 cps; hum & noise -80 db; separation 55 db @ 1 kc. Has tape monitor, speaker selector sw., high & low filter; push-button selector sw. (tuner, tape play, aux., low level). Sensitivity: phono 2.8 mv., tape head 1.8 mv., microphone 2.2 mv., aux. 200 mv. 4 & 16 ohm output. 15 1/8" x 4 3/16" h. x 11 1/2" d. Less cabinet .....\$329.50

### Model 400-CX Stereo Master Audio Control Center

Push-button control selectors; record-monitor facilities; controls for bass, treble,

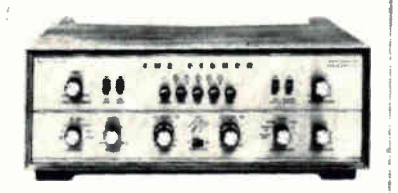

phase, scratch and rumble filters; 10 tubes; 15 1/2" x 11 1/2" x 4 3/16".....\$199.50

### Model KX-200 "Stratakit" Integrated Amp

Combination amp-preamp; dual-channel design; 40 watts per channel music power



at .4% harmonic distortion @ 1000 cps with both channels operating; response 20-20,000 cps  $\pm 1$  db; sensitivity 350 mv. high-level. 3.5 mv. low-level: high-frequency and subsonic frequency filters; 14 front-panel controls; 10 tubes; full-wave silicon rectifiers; 15 1/4" w. x 12 1/2" d. x 4 3/16" h.; less cabinet; kit.....\$169.50

### Model KX-100 "Stratakit" Integrated Amp

Similar to Model X-100-C; combination amplifier and preamp, dual-channel design; 25 watts per channel music power at .5% harmonic distortion at 1000 cps with



both channels operating (24 w. r.m.s.); response 20-20,000 cps  $\pm 1$  db; sensitivity 16 mv. high level, 3.5 mv. low level; has high frequency and subsonic frequency filters; front-panel earphone jack; 14 front-panel controls; 10 tubes, 2 silicon rectifiers; 15 1/8" w. x 12 1/2" d. x 4 3/16" h.; less cabinet; kit .....\$129.50

## FUTTERMANN

### Model H-3 Power Amp

Transformerless stereo design with 50 w./ch. r.m.s. output with 15 or 16 ohm load.



Response +0, -5db 5-90,000 cps (-3 db at 200 kc.). HD less than .2% at rated output. IM dist. less than .05% at rated output. Damping factor 200. S/N ratio 90 db below 50 w. Has less than 2.0  $\mu$ sec. rise time. Requires 2 v. r.m.s. to drive amp to rated output. Has 18 tubes & 6 rect. 17" x 10 1/4" x 7 1/2" h., with cage.....\$288.00

## HARMAN-KARDON

### "Citation A" Transistorized Preamp

Response flat from 1 to 1 million cps +0 -1/4 db; square-wave response better than



1  $\mu$ sec. in all functions, less than 5% tilt at 5 cps; harmonic distortion unmeasurable at 2 volts output from 20-20,000 cps; IM distortion less than .05% from 40 to 140° F.; noise -85 db below rated output; sensitivity: high-level input .25 v., low-level input 1.5 mv.; controls—on-off, function selector, mode, blend, equalization, tone, balance contour channel reverse low-cut filter, high-frequency filter, tape monitor; 33 transistors; 14 3/8" w x 5 3/8" h x 7" d.  
 Kit .....\$279.95  
 Factory wired.....\$350.00  
 Walnut cabinet.....\$ 20.00

### "Citation B" Stereo Amplifier

Transistorized design; 40 w./ch. continuous r.m.s. power. 15-60,000 cps at rated power; 1-100,000 cps  $\pm 1$  db at one watt level. HD less than 0.5%, 20-20,000 cps, at rated output. IM dist. less than 0.1% at normal listening level. Square-wave response less than 1  $\mu$ sec. rise time. Damping factor is 50 at all frequencies down to 10 cps. One fuse on a.c. primary and one on "B+" of each channel. Front panel controls include: idling current adjustment for each output transistor-meter monitored; a.c. "on/off" switch; low-cut filter; meter selector switch. 14 transistors. 14 3/8" x 5 3/8" x 14".  
 Kit .....\$335.00

Factory wired.....\$425.00

### Model A1000T Transistorized Integrated Amp

Features 35 w./ch. music power (30 w./ch. sine wave); high damping factor; trans-



formerless direct-coupled circuitry; silicon output transistors; printed-circuit wiring; stereo/mono blend indicator lights; response 10-100,000 cps  $\pm 1/2$  db at normal listening level; square-wave response less than 10% tilt at 20 cps with better than 2.5  $\mu$ sec. rise time; dist. .5% at rated output; input sensitivity: high level 200 mv., low level 2.5 mv.; damping factor @ 1000 kc. 30 at 4 ohms, 75 at 16 ohms; has conventional inputs & operating controls; has 28 transistors & 6 diodes; 14 $1/8$ " x 3 $3/8$ " x 10" d. ....\$369.95  
Walnut enclosure.....\$ 19.95

## HEATH

### Model AA-21 Transistorized Amplifier

Integrated preamp and power amplifier; dual channel; 35 watts (8-ohm load) per



channel continuous sine-wave or 50 watts per channel music-power rating; response 13-25,000 cps  $\pm 1$  db at max. power; 26 watts (16-ohm load) sine wave; 18 watts (4-ohm load) sine wave; harmonic distortion less than 1% @ 20 cps, .5% at 1000 cps, 2% @ 20,000 cps; IM distortion less than 1% at rated output; channel separation 40 db; has all conventional operating controls many of which are mounted behind hinged front panel; 26 transistors and 10 diodes; 15 $1/2$ " w. x 5 $1/4$ " h. x 14" d.; (kit) .....\$139.95

### Model AA-22 Transistorized Amplifier

Integrated stereo design features 35 w./ch. music power; 20 transistors & 10 diodes.

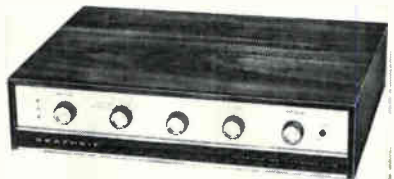

Response 15-30,000 cps  $\pm 1$  db; 4,8,16 ohm output. Has 5 stereo inputs (mag. phono, tuner, tape recorder & 2 aux.). Front-panel controls: mode (mono, stereo, stereo reverse); 5-pos. input selector sw. & bass & treble tone controls. Power output 35 w./ch. @ 8 ohms, 18 w./ch. @ 16 ohms, 17 w./ch. @ 4 ohms—all music power rating @ .7% THD, 1 kc.; HD less than .3% @ 1 kc. and at rated output. IM dist. less than 1% at rated output; separation 60 db at 1 kc.; input sensitivity (20 w./ch. & for 8 ohms) mag. phono 5 mv., all others .25 v.; 15 $3/8$ " w. x 3 $3/8$ " h. x 11 $3/8$ ". Kit.....\$99.95

### Model AA-23 Integrated Amplifier

Mono design; 25 w. sine-wave power; re-

sponse 30-15,000 cps  $\pm 1$  db at 25 w.; HD less than 2% at 30-15,000 cps, 25 w.; IM



less than 2% at 25 w.; inputs for mic., mag. phono, crystal or ceramic phono, aux.; bass & treble tone controls; 4-8-16 ohm outputs; 13 $1/2$ " w. x 4 $15/16$ " h. x 9 $1/2$ ".  
Kit .....\$42.95

### Model AA-13 Amplifier

Mono design, 14 watts output. Response 20-15,000 cps  $\pm 1$  db; HD less than 2% at

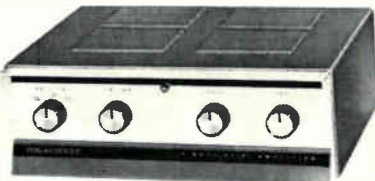

14 w.; IM distortion less than 2% at 14 watts; three inputs; mag. phono (RIAA), crystal phono & tuner; separate bass & treble controls; hum balance control; screen-tapped output circuit uses EL84 tubes; output impedances: 4, 8, and 16 ohms; complete with cabinet; 13 $1/2$ " w. x 10 $1/2$ " d. x 4 $15/16$ ". Kit .....\$29.95

### Model AA-11 Deluxe Stereo Preamp

Push-button design; all primary operating controls are on front panel; all secondary



controls behind hinged lower panel; frequency response 20-20,000 cps  $\pm 0.5$  db; harmonic distortion .05% maximum; IM distortion .09% max.; five stereo inputs and three mono inputs. Has center-channel output and all necessary controls—blend, stereo balance controls, scratch and rumble filters, stereo/mono switch, channel reversal switch, phase reversal switch, volume/loudness switch; 10 tubes; over-all dimensions 5 $1/2$ " h. x 11 $1/2$ " d. x 15 $1/8$ " w. (kit) .....\$84.95

### Model AA-100 Integrated Stereo Amp

Rated output: 25 watts per channel; frequency response 30-15,000 cps  $\pm 1$  db for



rated output; IM distortion less than 1%, harmonic distortion less than 0.5% at rated power; channel separation 42 db minimum at 1000 cps; input sensitivity: mag phono, 1.5 mv.; tape head, 1.0 mv.; tuner, aux 1, aux 2, 0.2 volt; 4-position

function switch: stereo, stereo reverse, chan A, chan B; balance control; separation control; dual tandem type level control; dual concentric bass and treble controls for each channel; input level controls for each channel except tape head; power amplifier input level control, one per channel; hum balance controls; phase switch; low impedance tape outputs; output impedances: 4, 8, 16 ohms each channel; tubes 2-EF86, 4-12AX7, 2-7199; 4-7591, 1-GZ34; 15 $1/2$ " w. x 4 $3/8$ " h. x 12 $1/2$ " d. Model AA-100 (kit).....\$ 84.95

### Model AA-151 Integrated Stereo Amp

Power output 14 watts per channel; frequency response 20-20,000 cps  $\pm 1$  db; channel separation better than 45 db; input sensitivity for rated output; mag phono, 4 mv.; crystal phono, 0.25 volt tuner and aux, 0.2 volt; 4 position selecto switch; mag phono, crystal phono, tuner aux; dual concentric (clutch) volume control; dual tandem bass and treble controls;



phase switch; 1 filament balance per channel; output impedances: 4, 8, 16 ohms; tubes are: 2-6EU7, 2-6AU6, 2-6AN8, 4-EL84/6BQ5, 1-GZ34/5AR4.  
Kit .....\$ 59.95

### Model AA-191 Integrated Amplifier

Mono version; 3 watts output; response 50-20,000 cps  $\pm 1$  db; harmonic distortion



less than 3% 60-20,000 cps @ 3 watts; IM distortion less than 3% @ 3 watts; sensitivity (crystal phono & tuner) .15 v. for 3 watts; 4-8-16 ohm outputs; tubes—EF86, EL84, 6X4. Kit.....\$16.88

### Model AA-121 Stereo Power Amplifier

Power output 40 watts per channel; frequency response 20-20,000 cps  $\pm 0.5$  db



for rated output; 20.5 db negative feedback; damping factor, 17; phase reversal switch; center speaker terminals; tubes: 2-6AN8, 4-EL34; 4 silicon diodes; 1 selenium diode for bias supply; 15" w. x 7 $1/4$ " h. x 11" d. (kit).....\$79.95

### Model AA-141A Stereo Preamplifier

Input sensitivity (for 2.5 v. output @ 1000 cps) mag. phono .006 v., crystal phono .2 v., aux. #1 & #2 .2 v.; input impedance mag. phono 47,000 ohms, balance 1 meg-ohm; response 20-20,000 cps  $\pm 1$  db; IM & HD for high-level circuit .1%; channel sep-

# 1 Amplifiers

ation 45 db from 20-20,000 cps; hum & noise for mag. phono input —55 db; controls: source selector sw., 6-pos. function sw., bass & treble controls, "on-off" sw.;

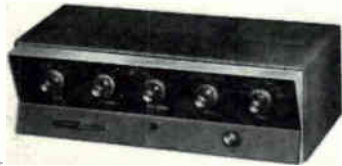

6-6EU7 tubes; 15 3/4" x 5 1/4" x 7 1/2" d.; (kit) .....\$34.95

## Model AA-111 Stereo Power Amplifier

Power output 14 watts per channel; frequency response 30-15,000 cps  $\pm 1$  db at rated output; total harmonic distortion



2%; channel separation 65 db; hum and noise 76 db below 14 watts; input sensitivity 0.74 volt for rated power; octal sockets for preamplifier power; phase reversal switch; level control for each channel; output impedances 4, 8, 16 ohms; tubes: 2-7199, 4-EL84, 1-GZ34; 13" w. x 8 1/2" d. x 6" h.; (kit).....\$44.95

## Model AA-201 Integrated Stereo Amp

Power output 3 watts per channel; frequency response 50-20,000 cps  $\pm 1$  db for



rated power; input sensitivity 150 mv. total harmonic, IM distortion less than 3%; 7-position selector switch: mono phono, chan A tuner, chan B tuner, stereo phono, stereo phono reverse, stereo tuner, stereo tuner reverse; phase switch; output impedances: 4, 8, 16 ohms; tubes: 2-EL84, 2-7199, 1-EZ81; (kit) .....\$31.95

## HI-FI HQ.

## Model "Stereo 50-50" Power Amp

Dual 50-watt per channel continuous sine-wave power; sensitivity .65 volt for 50



watt output; response 15-50-000 cps  $\pm 1$  db; harmonic distortion approx. 0.1% at rated output; 1M distortion .64% at 50 watts; noise and hum 90 db or more below rated output; damping factor 14 for 16-ohm output; input impedance .5 meg-ohm; output impedance 4 8 16 ohms for each channel .....\$350.00

## KENWOOD

### TK-400 Integrated Stereo Amp

All-transistor, transformerless design featuring 40 w./ch. music power & 32 w./ch.

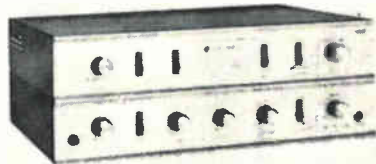

continuous sine wave @ 8 ohms; 26 transistors & 5 diodes; 5 stereo inputs (2 phono, tape head 1.5 mv. sen. & aux., tuner 100 mv. sen.); 4-16 ohm outputs. Damping factor 20; HD 1% @ 40 w. & 1000 cps; response 20-20,000 cps  $\pm 1$  db. Controls: volume, bass, treble, balance, separation. Switches: input selector, mode selector, low filter, high filter, loudness, speaker on/off, speaker phase, tape monitor. ....\$199.95

### KW-220 Integrated Stereo Amp

50 w./ch. music power; 40 w./ch. sine wave at 1000 cps @ 1%. HD: 4-8-16 ohm



outputs: HD 1% @ 50 w./ch. (1 kc.); damping factor 8. Response 20-20,000 cps  $\pm 1$  db. Sensitivity: mag. phono 1 & 2, tape head 1.5 mv.; tuner, aux. 1 & 2, 100 mv. Has 13 front-panel controls including bass & treble, loudness, low & high filter, phono equalization, balance, separation, volume, speaker on/off, phase. 15 1/4" w. x 12 1/4" d. x 5 3/4" h. ....\$169.95

## KLH

### Model Sixteen Integrated Stereo Amp

Fully transistorized integrated amp with stereo output of 70 watts r.m.s. (both channels driven into 8 ohms): mid-frequency

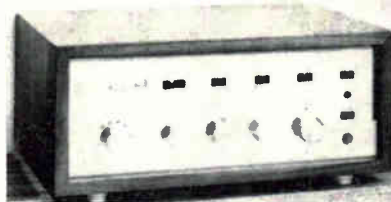

power per channel 49 w. (one channel); IHF music power over 100 watts; THD less than 2% from 25-20,000 cps  $\pm 0, -1$  db @ 35 watts (both channels at full output into 8 ohms); S/N better than 80 db. Controls: rotary program selector, volume, balance, treble, bass. Slide sw.: three-position loudness, stereo/mono mode, tape monitor, high-frequency filter, power on/off; speakers on/off; stereo headphone output jack. Inputs: mag. phono, tuner, aux. 1, aux. 2, tape in. Rear-panel outputs: record out, speakers out; without housing. ....\$219.95 Oiled walnut case.....\$ 19.95

## KNIGHT

### KN-999 Transistor Stereo Amp

50 w./ch. (music power), 35 w./ch. sine wave power; solid-state (all transistor) de-



sign: 19 transistors, 8 diodes; tape monitor, scratch & rumble filter; phase, mode, and stereo reverse switches; bass, treble, balance & volume controls; push-button input selectors: tape, phono, tuner, aux.; response 20-25,000 cps  $\pm 5$  db; HD 1%, hum —80 db all at rated power; stereo headphone jack; less case.....\$179.95 Walnut case.....\$ 14.95 Metal case.....\$ 5.95

### KN-940A Stereo Amplifier

22 w./ch. music power; 18 w./ch. sine wave power; 9 tubes & 4 silicon rectifiers;



input selector switch: tape, tuner, phono, aux. 1 & 2; bass, treble, balance, loudness controls; scratch & rumble filter switches; low impedance plus two high-impedance outputs for off-the-air stereo tape recording; stereo headphone jack; response 30-18,000 cps; HD 1.5%, hum —72 all at rated power; less case.....\$89.95

### KN-950A Transistor Stereo Amp

25 w./ch. music power; 15 w./ch. sine wave power; 15 transistors, 2 diodes; input



selector switch: tape, phono, tuner, aux. 1 & 2, bass, treble, balance & volume controls; scratch and rumble filter; mode & stereo reverse switches; stereo headphone jack; response 20-20,000 cps  $\pm 1$  db; HD 1%, hum —75 db all at rated power; less case .....\$119.95 Walnut case.....\$ 12.95 Metal case.....\$ 5.95

### KN-928 Stereo Amplifier

28 w./ch. peak power, 14 w./ch. IHF. Input selector: phono, tuner, aux., mode,



bass, treble, balance & volume. Low- & high-impedance outputs for tape. Response 30-15,000 cps  $\pm 1$  db. Has stereo phone jack & speaker switch. Oiled walnut & metal cases optional.....\$54.95

### KN-918 Stereo Amplifier

15 w./ch. peak power. Full array of controls including balance, bass, treble. For use

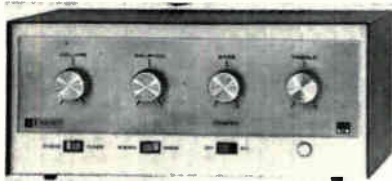

with ceramic or crystal phono cartridge  
\$39.95

### KNIGHT-KIT

#### Model KG-250 Stereo Amp

12 w./ch. music power; response 30-15,000 cps  $\pm 1$  db at full rated power; harmonic

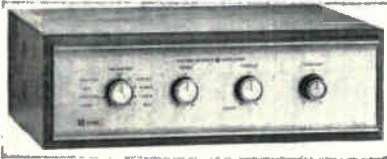

distortion less than 1.5% at rated power; inputs: 4 pair—mag. phono, ceramic or crystal phono, tuner, aux.; selector switch positions are: stereo phono, phono reverse, tuner, tuner reverse, aux., aux. reverse; mono—phono, tuner, aux.; bass and treble on-off controls; concentric volume control; output impedances 4-8-16 ohms; tubes: 4—ECL82, 2—ECC83/12AX7, 1—E781/6CA4; 4 1/4" x 13 1/4" x 8 1/2"; wt. 17 lbs. 83YX317—KG-250.....Kit \$39.95 83YX030 Deluxe walnut case.....\$ 9.95 83YX031 Metal case.....\$ 3.95 83YX029 Economy walnut case.....\$ 4.95

#### Model KG-400 32-Watt Stereo Amp

Preamps have d.c.-heated filaments; 5 pairs stereo inputs, including tape head input;



center-channel output; outputs for stereo tape recording; response 30-16,000 cps  $\pm 1$  db; harmonic distortion less than 1% at 16 watts; tubes 7025, 5—12AX7, 4—7189, GZ34/5AR4. 83YU413—KG-400.....Kit \$59.95 83YX023 Deluxe walnut case.....\$ 9.95 83YX024 Metal case.....\$ 3.95 83YX078 Economy walnut case.....\$ 4.95

#### Model KG-854 54-Watt Transistor Stereo Amp

27 w./ch. music power; response 20-25,000 cps  $\pm 1$  db at rated power; 4-8-16 ohm out-

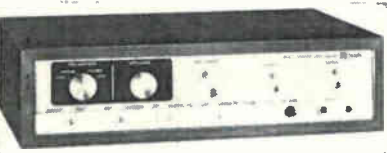

puts; features 14 transistors and 2 silicon diodes; direct-coupled output (no transformers); has stereo headphone jack; volume-loudness control; 5 pairs of inputs: tape head, mag. phono, tuner, aux. 1 & aux. 2; circuit breakers: III less than 1% at rated power; less case.

83YX605 Kit.....\$79.95 83YX035 Deluxe walnut case.....\$12.95 83YX079 Economy walnut case.....\$ 6.95 83YX036 Metal case.....\$ 4.95

#### Model KM-15 Amplifier

14 w. music power, mono design; response 30-15,000 cps  $\pm 1.5$  db at full rated

power; harmonic distortion 1% at 1000 cps for rated output; hum and noise level 65 db down at rated output through high-level input; two inputs; bass control 9 db boost or cut at 40 cps; treble control 9

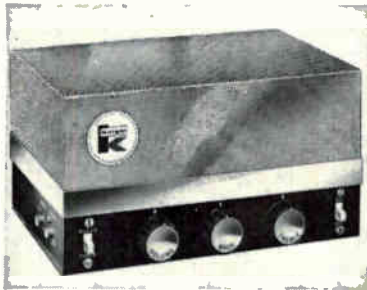

db boost or cut at 10,000 cps; tubes: 2—ECC83/12AX7, 2—EL84/6BQ5A E781/6V4/6BW4; output 4-8-16 ohms.

83Y784—KM-15 Kit.....\$19.95 83Y783 Metal cover.....\$ 3.95

#### Model KG-240 20-Watt Stereo Amp

Two pairs of inputs (tuner, ceramic phono) selectable by front-panel slide



switch; complete stereo control facilities; all controls front panel mounted and include ganged bass and treble controls, concentric volume control; hum and noise 60 db below rated output; power output 10 watts per channel (IHF music power); response 35-15,000 cps; harmonic distortion 1.5% at 1000 cps; separation 30 db; less cover.

83YX602 Kit.....\$29.95 83YX020 Metal cover.....\$ 3.95

#### KG-870 Transistor Stereo Amp

35 w./ch. music power; IM dist. less than 1%; response 20-25,000 cps  $\pm 1$  db at

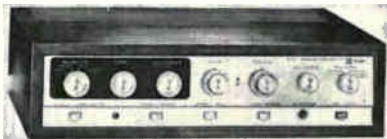

rated output; 4-8-16 ohm outputs; features 22 transistors and 4 silicon diodes; direct-coupled output (no transformers); 4 pre-driver transistors are silicon type; has stereo headphone jack; phasing switch; tone controls; 6 input circuits: phono, tape head, tape monitor, two aux., tuner; 2 1/4" x 13" x 11" d.; less case.

83YX603 Kit.....\$ 99.95 83YX035 Deluxe walnut case.....\$ 12.95 83YX036 Metal case.....\$ 4.95 83YX548 Factory wired (less case) \$149.95 83YX079 Economy walnut case.....\$ 6.95

#### KG-320 32-Watt Transistor Amp

32 w. music power mono design; 14-transistor, 4-diode circuit; direct-coupled out-



put, no transformers or capacitors in output stage; better than 30 db separation; mag. (Continued on page 26)

**Acoustech Solid State**  
"...better than the best..."  
—Hi Fi/Stereo Review



## Two New Kits That Make Tube Units Obsolete!

These two new Acoustech kits make anything you've heard sound out-of-date. Direct-coupled circuitry throughout provides performance unattainable with tube units regardless of price . . . factory assembled, plug-in glass epoxy printed circuit boards used in both kits give reliability just not possible until now.

**NEW ACOUSTECH IV CONTROL CENTER** has under 0.09% I.M. distortion through tuner input, under 0.15% I.M. through phono inputs. Rise time under 1 1/2  $\mu$ sec. Features dual mag inputs, tape monitor provisions, Muting. \$149 (\$149.95 West of Rockies).

**NEW ACOUSTECH III POWER AMPLIFIER** has over 200 watts per channel clean transient power. Under 0.95% I.M. at 60 watts per channel, under 0.45% I.M. at 40 watts per channel. Rise time under 1 1/2  $\mu$ sec. All silicon transistors throughout. \$199.00 (\$199.95 West of Rockies).

**ACOUSTECH**

ACOUSTECH, INC.  
Dept. SD-9, 139 Main Street, Cambridge, Mass. 02142

**FREE**

Please send free booklet "Why Solid State Amplifiers Can Sound Better" and full information on Acoustech solid state kits to

Name \_\_\_\_\_

Address \_\_\_\_\_

City \_\_\_\_\_ Zone \_\_\_\_\_ State \_\_\_\_\_

CIRCLE NO. 2 ON READER SERVICE CARD



# QA on Hi-Fi AMPLIFIERS

By F. L. MERGNER / V.P. & Director of Eng., Fisher Radio Corporation

**T**HE questions asked by prospective purchasers of amplifiers tend to fall into certain categories. Based on those questions most often asked, the replies given below should meet many of the requirements of would-be purchasers of amplifier equipment.

*Should I buy an integrated amplifier or separate pre-amplifier unit and power amplifier?* This depends on your requirements. Independent preamplifiers (control preamplifiers) generally offer somewhat greater flexibility by providing more inputs and controls than integrated designs and the combination of two separate components offers a greater latitude in installation, since the heat-generating power amplifier may be installed remote from the preamplifier. In addition, separate power amplifiers are generally available with higher power ratings than integrated designs.

On the other hand, integrated amplifiers often offer additional output-switching features, such as speaker-selector switches and headphone jacks. In addition, the combined unit is, in most cases, less expensive. However, there are no technical reasons why a combined unit can't equal the performance of a separate preamp and power amplifier of similar electronic design.

*How much amplifier power is required?* The amplifier power required in any given situation is dependent upon the efficiency of your loudspeakers, the acoustics of your listening area, and the number of speaker systems being used simultaneously. Therefore, no blanket formula can be given. However, ten watts (r.m.s.) power should be available for each thousand cubic feet of volume in the listening room.

*Won't a high-powered amplifier be too loud for a small room?* No. The loudness of the sound from the speaker is set by the volume control and (for a given control setting) is not related to amplifier power, speaker efficiency, and room acoustics. However, it must be remembered that the ear responds in a roughly logarithmic way, i.e., for *twice* the apparent loudness, *four* times as much power must be used. The direct result of this principle is that an amplifier with higher power capabilities is required, particularly with low-efficiency speakers.

*Are transistor amplifiers better than units with tubes?* Transistor circuitry has certain advantages and disadvantages. Some of these are given below.

1. Transistors are more efficient than tubes. They require no filament power and consequently have a lower operating temperature.

2. Because transistors and their associated components generally operate at lower voltages and because these components usually dissipate less power, transistor high-fidelity components may be made smaller than comparable tube units.

3. Transistors have a longer life expectancy and maintain uniform characteristics over extended periods of time.

4. Transistor amplifiers do not require output transformers, thus eliminating these large, expensive items required in tube units to achieve wide power bandwidth.

5. However, there is also the question of price. Transistors (and most of their associated components) presently cost more than components used in vacuum-tube amplifiers because of necessarily tighter tolerances and because of their premium nature. While the cost of solid-state components will undoubtedly be reduced in the future, it appears that tubes or transistor-tube combinations will be used in low-to-medium priced models for some time to come.

*Why does an amplifier have inputs marked "Tape Head" and "Tape Play"?* The tape heads (pickup devices) in simple tape transports without preamplifiers generally have an output signal ranging from one to three *thousandths* of a volt. The "Tape Head" input jacks are connected to additional stages within the amplifier and provide the greater amplification and the "equalization" needed for this low-level signal. The "Tape Play" jacks, however, are high-level inputs which are designed to accommodate the higher voltage signals provided by tape recorders and decks incorporating preamplifiers. If you intend to use a tape deck or recorder with your amplifier, check the recorder's instruction booklet to determine the correct input to use. If the recorder's output is greater than approximately 100 millivolts and already "equalized", use the "Tape Play" or "Tape Monitor" inputs.

*I have been told not to install an amplifier directly beneath a record changer, turntable, tuner, or recorder. Why?* A tube amplifier gives off a great deal of heat which might adversely affect any component mounted above the amplifier. With a changer, this heat may produce erratic operation or even disable the mechanism entirely. In an electronic instrument, such as a tuner, the heat may cause premature aging or circuit misalignment. However, with good ventilation (suitable spacing and/or a fan) and a heat shield (such as a board beneath the component), it should be possible to mount a changer or turntable above a low-powered amplifier. The ventilation requirements for the amplifier are the prime determinants.

*How far away from the amplifier may the loudspeakers be placed?* While no limit is generally set, no more than fifty feet of standard lamp cord should be attached between the amplifier and a speaker. However, with heavier wires, longer runs may be used.

*I am using a stereo cartridge. When I play a mono record (with my amplifier in either the mono or stereo mode) there is much less volume and often the sound distorts. Is something wrong with my amplifier?* You have probably installed your cartridge with one channel out of phase with the other, causing partial cancellation of the signal. Interchange leads in one channel to correct this condition. 



# FREE!

See the Largest Selection in Our 44-Year History:

- Stereo Hi-Fi — all famous brands plus Lafayette's own top-rated components
- Citizens Band — includes Walkie-Talkies
- Tape Recorders
- Ham Gear
- Test Equipment
- Radios & TV Sets and Accessories
- P.A. Equipment, Intercoms
- Cameras, Optical Goods
- Marine Equipment, Auto Accessories
- Musical Instruments, Optics, Tools, Books and MUCH MORE



## LAFAYETTE RADIO ELECTRONICS

1965 CATALOG No. 650

Over 500 Pages!

Featuring Everything in Electronics for

• Home • Industry • Laboratory

from the

**“World’s Hi-Fi & Electronics Center”**

Mail the Coupon for your FREE 1965 Lafayette Catalog

BUY ON TIME—Use Lafayette's famous Easy-Pay Credit Plan . . . up to 24 months to pay.

### NEW! LAFAYETTE 70-WATT COMPLETE AM-FM STEREO



### RECEIVER Model LR-800

Just Add Speakers and Enjoy FM, FM Stereo and High-Quality AM Reception

**199<sup>50</sup>**

99-0005WX

- A powerful 70-Watt Amplifier plus Complete Pre-amplifier Control Facilities plus a Standard AM Tuner plus a sensitive FM Tuner plus an FM Stereo Tuner—all on One Compact chassis
- Amazing FM “Stereo Search” Circuit Signals Presence of Stereo Broadcasts
- Tuned Nuvistor “Front End” provides Greater Sensitivity, Lower Noise, Less Heat
- Bar-Type Tuning Indicator for AM and FM
- Variable AFC Control • Imported

### NEW! LAFAYETTE Criterion® 1000—PROFESSIONAL 4-TRACK SELF-CONTAINED STEREO TAPE RECORDER

featuring MAGNIFICENT TEAK CABINTRY



DYNAMIC MICROPHONES

**199<sup>50</sup>**

99-1501WX

- Plays 2- and 4-Track Stereo and 4-Track Monaural
- Records 4-Track Stereo and Monaural
- 3-Speeds: 1 7/8, 3 3/4 and 7 1/2 ips
- 6 Pushbutton Tape Motion Controls
- Records Sound with Sound
- Automatic Shut-off Electrically and Mechanically Returns Recorder to Stop Position
- Transistorized Stereo Preamplifiers
- Complete with 2 Dynamic Microphones, Cables, 7" Take-up Reel • Imported

**Lafayette Radio Electronics**  
Mail Order and L. I. Sales Center  
111 Jericho Turnpike, Syosset, L. I., New York

New York, N. Y.  
100 Sixth Ave.  
Jamaica, N. Y.  
165-08 Liberty Ave.  
Brooklyn, N. Y.  
2265 Bedford Ave.  
Bronx, N. Y.  
542 E. Fordham Rd.  
Scarsdale, N. Y.  
691 Central (Park) Ave.

Newark, N. J.  
24 Central Ave.  
Paramus, N. J.  
182 Route 17  
Plainfield, N. J.  
139 W. 2 St.  
Boston, Mass.  
584 Commonwealth Ave.  
Natick, Mass.  
1400 Worcester St.

Lafayette Radio Electronics  
Dept. DBE-5, P. O. Box 10  
Syosset, L. I., N. Y. 11791

- Send me the FREE 1965 Lafayette Catalog 650
- \$..... enclosed; send me #.....
- (Prices do not include shipping charges.)

Name.....

Address.....

City..... State..... Zip.....

# 1 Amplifiers

phono, tuner, and aux. inputs; separate ganged bass and treble controls; output impedance 8-16 ohms; continuous sine-wave power output 24 watts at 8 ohms, 16 watts at 16 ohms; IHF music power output 32 watts at 8 ohms, 30 watts at 16 ohms; response at rated power 25-18,000 cps  $\pm$  1 db; harmonic distortion at rated power 1%; hum and noise -75 db.  
 83YX601 Kit.....\$59.95  
 83YX016 Deluxe walnut case.....\$ 9.95  
 83YX077 Economy walnut case.....\$ 4.95

## LAFAYETTE

### LA-350 Integrated Stereo Amp

35 w./ch. music power, 28 w./ch. continuous sine wave. Response 15-30,000 cps  $\pm$  1



db at normal listening level; HD 1%; hum & noise -76 db (high-level inputs); separation 50 db @ 1kc. Input sensitivity: tape head & phono 1.5 mv., phono #2 6 mv., tuner 200 mv. aux. #1 10 mv., aux. #2 750 mv. Output: 8 & 16 ohms. Has 2 stereo tape outputs. 11 front-panel controls, d.c. on preamp filaments. 14 1/8" w. x 5 1/4" h. x 10" d. Supplied with cabinet....\$99.50

### LA-200 Transistorized Integrated Stereo Amp

22 w./ch. music power; response 20-20,000 cps  $\pm$  1 db; HD 1%; hum & noise -74



db (tuner input); has 5 pairs of inputs; tape head, mag. phono, ceramic phono, tuner, aux.; has conventional operating controls; 19 transistors; 13" x 4 3/16" x 9" d.; metal case included.....\$109.50

### Model LA-260 40-Watt Stereo Amp

Integrated 40-watt stereo amp-preamp; 20 watts each channel; 8- or 16-ohm speak-



ers; concentric bass, treble controls; continuously variable separation control; individual volume-balance; loudness switch; rumble filter; mode switch; selector switch (aux., tuner, phono, tape head); hum balance controls; 5 inputs; dual tape output, dual 8- and 16-ohm terminals. Response: 40-20,000 cps  $\pm$  1 db @ 1 watt. Front panel headphone and tape output jacks. Enclosure included.....\$79.95

### LA-250A Stereo Amp-Preamp

25 watts per channel; frequency response 20-50,000 cps  $\pm$  1 db at rated power; hum



mag phono inputs, 50 db below rated output; sensitivity: mag phono, 3.5 mv; high level inputs, 0.5 volt; channel separation better than 55 db at 1000 cps; 4-position selector switch: aux. tuner, phono, tape head; dual concentric bass control  $\pm$  14 db at 50 cps; dual concentric treble control  $\pm$  14 db at 10,000 cps; dual concentric volume control; on/off loudness switch; phase switch; separation control; phono input RIAA equalization; tape head input NAB equalization; third channel output; output impedances 4, 8, 16 ohms; tubes; 4-EL86, 2-7199, 3-12AX7; 3 silicon diodes; 14 1/2" x 12 1/4" x 5 1/2".....\$79.95

## LEAK

### "Varislope 2" Stereo Preamp

Features 5 stereo inputs, mag. phono sensitivity 3.5 mv., tape head sensitivity 3 mv.,

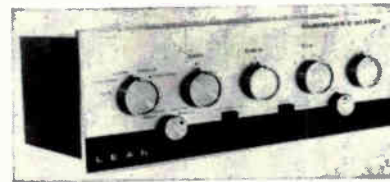

tuner sensitivity 50 mv., mic. sensitivity 3 mv., tape amplifier sensitivity 125 mv. Has function control (mono, stereo & right or left channel); bass & treble tone controls; balance control; tape monitoring sw.; filter & slope controls. HD .01% for 125 mv. output; hum & noise -60 db. Size 11 1/2" x 4 1/4" x 16 1/4" d.....\$129.50

### Stereo 30 Transistor Amp

Integrated design, 15 w./ch.; HD .1% @ 8 w./15 ohms/1 kc.; hum & noise -66 db; damping factor 50 @ 1 kc.; separation 50 db to 1 kc. & 30 db to 10 kc. Has 5 input selector sw. (mag. phono, tape head, tuner, tape amp, mic.). Controls are bass, treble, balance, volume, filter & slope; tape monitor sw. 13" x 9" x 4 1/4". Panel design similar to "Varislope 2" preamp.....\$249.50

### Stereo 20 Basic Amplifier

Frequency response 20 to 20,000 cps  $\pm$  0.5 db; power output 12 watts r.m.s. per chan-



nel; harmonic distortion 0.1% at 10 watts output (1000 cps); hum and noise 80 db below 10 watts; sensitivity 125 millivolts for 10 watts output; damping factor 25 at 1000 cps; output impedance 3 to 16 ohms; 100-125 volts; 50 to 60 cycles; tubes are 1-ECC83, 2-ECC81, 4-EL84, 1-GZ34. ....\$149.00

### Stereo 60 Basic Amplifier

Power output 30 w./ch. r.m.s.; harmonic distortion 0.1% at 1000 cps for 30 watts



output; hum and noise 80 db below 30 watts; sensitivity 125 millivolts for 30 watts output; frequency response 20 to 20,000 cps  $\pm$  0.5 db; damping factor 25 at 1000 cps; output impedance 3 to 16 ohms; tubes are 3-ECC83, 4-EL34, 1-GZ34; 100-120 volts; 50-60 cycles.....\$219.00

## MARANTZ

### Model 9A 70-Watt Mono Amp

70 watts r.m.s., 140 watts peak; switch for 40-watt triode operation; response 20-20,



000 cps  $\pm$  1 db at full rated power; subsonic filter switch -25 db @ 20 cps, -20 db @ 3 cps; harmonic distortion less than 0.3% at 20 kc. full rated power; IM distortion less than .5%; hum and noise better than 90 db below 70 watts; damping factor 17, can be changed internally; output impedances 4, 8, 16 ohms, plus 1 ohm tap for center speaker connection; front panel controls: gain (isolated by cathode-follower phase circuit), phase switch, low filter, test switch (bias readings each tube, built-in test signal for dynamic balance adj.); five bias and balance adjustments plus input and output connections under snap-out access panel; 2-6DJ8/ECC88, 1-6CG7, 4-6CA7/EL34, 1 zener diode, 5 silicon rectifiers; over-all size 15 3/8" x 8 1/4" x 10 1/2".

Model 9A.....\$384.00

Model 9R (rack mounted).....\$414.00

Also available:

Model 970 (70 v. output, plus 8, 16 ohms)

Model 970R (same as Model 970, rack mounted)

### Model 7 Stereo Console Preamp

Preamplifier; can select 8 positions: mic., phono 1 and 2, tape, FM-AM, multiplex,

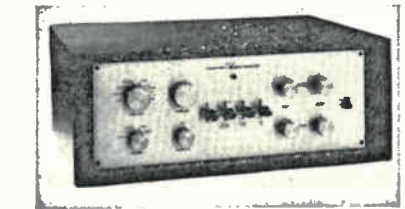

TV, aux.; controls for stereo, stereo reverse, channel A, channel B, channel A/B; all monophonic positions can be heard in both speakers; total volume range 90 db; high filter at 9 kc. and 5 kc.; rumble filter at 50 and 100 cps; 0.1% IM distortion at 10 volts r.m.s., 0.01% at 2 volts r.m.s.; frequency response 20-20,000 cps; tubes are 6-ECC83/12AX7; over-all size 14 3/8" x 5 3/8" x 8 1/2"; total noise level is 80 db below 10 mv.

phono input: weight 15 lb. ....\$285.00  
 Model 7R—identical to 7 but mounted on  
 19" rack panel.....\$309.00

**Model 8B Stereo Power Amplifier**

Two 35-watt amps on single chassis; each  
 amp: 70 watts peak; output in triode opera-



tion (with minor circuit changes) 18 watts;  
 response 20-20,000 cps  $\pm 1$  db at 35 watts;  
 harmonic distortion less than .1% at mid-  
 frequencies at 35 watts; IM distortion less  
 than .5% at 35 watts; damping factor 20  
 (can be adjusted for 2, 1, and  $\frac{1}{2}$ ); hum  
 better than 90 db below 35 watts; metered  
 bias adjust; tubes are 6BH6, 6CG7; 2-  
 EL34/6CA7 plus silicon rectifier (each chan-  
 nel);  $13\frac{1}{2}$ " x  $7\frac{1}{4}$ " x  $10\frac{1}{2}$ " .....\$285.00  
 Accessory grille.....\$10.50

**McINTOSH**

**C22 Stereo Preamp**

Response 20-20,000 cps  $\pm .5$  db; dist. less  
 than .2% @ 10 v. output, .02% @ 3 v.;



noise 85 db below rated output; input  
 sensitivity aux., tape, tuner 1 & tuner 2—  
 .25 v. @ 250,000 ohms; phono 1 & 2, 2  
 mv. @ 47,000 ohms; mic. 2.5 mv. @ 1  
 megohm, tape head 2 mv. @ 1 megohm;  
 tape compare .25 v. @ 250,000 ohms; has  
 conventional operating controls; features  
 front-panel jacks for connecting external  
 tape recorder .....\$279.00  
 Cabinet extra.....\$ 25.00

**C-24 Stereo Preamp**

All-silicon-type transistor design featuring  
 6 stereo program sources; 3 high-level  
 (tuner, tape, aux.) & 3 low-level (2-mag-  
 phono & tape head). Response 20-20,000



cps  $+0 -5$  db; Dist. less than .1% at 2.5  
 v., .3% at 10 v. (all 20-20,000 cps); noise  
 -75 db (vol. control clockwise pos.). Sensi-  
 tivity: high-level .2 v., low-level 2 mv.  
 Outputs 2.5 v. Controls: bass, treble, RIAA/  
 LP equalization, tape monitor, L.F. & H.F.  
 filters, input & mode selector. Panel size  $16$ "  
 x  $5\frac{3}{8}$ " with chassis  $11$ " deep.....\$249.00  
 Walnut cabinet.....\$ 25.00

**MC40 Mono Amplifier**

40 watts continuous sine-wave; harmonic  
 distortion less than .5% at rated output

1965 EDITION



and 20-20,000 cps; IM distortion less than  
 .5% (20-20,000 cps); phase shift  $\pm 8^\circ$   
 (20-20,000 cps); response 20-20,000 cps  
 $+0 -1$  db at 40 watts total output (10-  
 100,000 cps  $+0 -1$  db); output impedan-  
 ces 4-8-16-125-150-600 ohms; tubes: 2-  
 12AX7, 12AU7, 12BH7, 2-6L6GC or 2-  
 7027A;  $13\frac{3}{4}$ " l. x  $8\frac{1}{8}$ " w. x  $7\frac{3}{8}$ " h.  
 .....\$159.00

**MC75 Mono Power Amp**

Guaranteed continuous sine-wave output  
 75 watts with harmonic distortion less



than .5%, 20-20,000 cps; capable (but  
 not guaranteed) of 91 watts continuous  
 sine wave at same distortion; IM distor-  
 tion less than .5% for any combination of  
 frequencies 20-20,000 cps; phase shift less  
 than  $\pm 8^\circ$ ; response 16-60,000 cps  $+0$   
 $-5$  db; sensitivity .5 v. for rated output;  
 hum and noise 90 db below rated output;  
 output impedance 4-8-16 ohms;  $16\frac{1}{4}$ " l.  
 x  $8\frac{1}{4}$ " w. x  $8\frac{1}{4}$ " d.....\$229.50

**MA230 Integrated Amp**

30 w./ch. continuous sine wave output (44  
 w./ch. music power) with silicon planar  
 preamps & tube-type power amplifier. Re-  
 sponse 20-20,000 cps  $+0 -5$  db @ 30

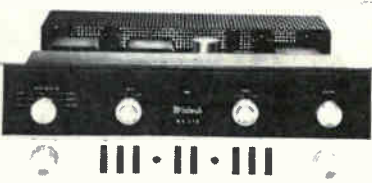

w./ch., 15-70,000 cps  $+0 -3$  db. Damping  
 factor 10; HD .5% @ 30 w./ch. (20-20,000  
 cps); IM dist. .5% (20-20,000 cps); phase  
 shift  $\pm 5^\circ$  (20-20,000 cps). Output impedan-  
 ce 4-8-16 ohms. Sensitivity: aux., tape,  
 tuner, tape monitor .25 v.; phono 1 & 2,  
 tape head 3 mv. Controls similar to Model  
 C-24 preamp.....\$349.00  
 Walnut cabinet.....\$25.00

**MC240 Stereo Power Amp**

Guaranteed 40 watts (capable of 58 watts)  
 continuous sine-wave power per channel;  
 harmonic distortion less than .5% from  
 20-20,000 cps at rated output; IM distor-  
 tion less than .5% for any combination of  
 frequencies from 20-20,000 cps; phase shift  
 less than  $\pm 6^\circ$  from 20 to 20,000 cps;  
 response 16-60,000 cps  $+0 -5$  db;  
 sensitivity .5 v. at rated output; hum and

**HERE'S ONE WAY TO  
 COOL A HOT AMPLIFIER**



but  
 here is a  
**BETTER WAY**



Only  
**\$14.85**

the **ROTRON**

*Whisper Fan*  
**KIT**

Beat the heat that wrecks the set by install-  
 ing a Rotron Whisper Fan Kit. Breathing  
 60 cubic feet of cool air over, under and  
 around every heat-generating component,  
 the Whisper Fan improves performance by  
 minimizing drift due to temperature  
 change within the enclosure. Requires  
 only 7 watts, just pennies a week to oper-  
 ate. Measuring only  $4\frac{1}{16}$ " square and  $1\frac{1}{2}$ "  
 deep, it can be set in a corner or mounted  
 on the rear panel in minutes. Comes com-  
 plete with mounting hardware, plug and  
 cord for electrical connections and instal-  
 lation instructions.



Write for details  
 or see your local dealer.

**ROTRON** mfg. co., inc.  
 WOODSTOCK, NEW YORK  
 Oriole 9-2401

CIRCLE NO. 49 ON READER SERVICE CARD

# 1 Amplifiers

noise 90 db below rated output; output impedance 4-8-16, 125, 150, and 600 ohms; 17 1/4" l. x 10 3/4" w. x 8" h.....\$288.00

## MC275 Stereo Power Amp

75 watts per channel with each channel identical in performance to Model MC75



power amplifier; 17 1/4" l. x 12 1/4" w. x 8" h.....\$444.00

## MC225 Stereo Power Amp

Guaranteed 25 watts (capable of 34 watts) per channel continuous sine-wave power



with less than .5% harmonic distortion, 20-20,000 cps at rated output; IM distortion less than .5% for any combination of frequencies from 20 to 20,000 cps; phase shift less than ±15° from 20 to 20,000 cps; response 18-60,000 cps ±0 -5 db; sensitivity .5 v. for rated output; hum and noise 90 db below rated output; output impedance 4-8-16-150-200 ohms; 14 1/2" l. x 9 1/4" w. x 7" h.....\$198.00

## MERRELL

### SA-210 Integrated Stereo Amp

Features 10 w./ch. music power; response 20-18,000 cps; 3 dual inputs: magnetic



phono, crystal phono & tuner; 12 1/4" x 4 1/4" x 8" d.....\$59.95  
Kit .....\$29.95  
Cover .....\$ 4.95

### SA-30 Integrated Stereo Amp



Features 15 w./ch. music power; response 20-20,000 cps ±1 db; 4 dual inputs: magnetic phono, crystal phono, tuner & aux.; 4, 8, 16 ohm outputs; 14" x 6" x 8" d.  
.....\$79.95  
Kit .....\$39.95  
Case .....\$ 5.95

### SA-40 Integrated Stereo Amp

Features 20 w./ch. music power; response 20-20,000 cps; 4 dual inputs; magnetic



phono, crystal phono, tuner & aux.; 4, 8, 16 ohm outputs; 12 1/2" x 4" x 10" d.  
.....\$99.95  
Kit .....\$49.95  
Cover .....\$ 8.95

### MA-12 Integrated Amplifier

Mono 12-watt (music power) design; response 20-20,000 cps ±1 db; has 4 in-



puts: magnetic phono, crystal phono, tuner & aux.; 4, 8, 16 ohm outputs; front-panel controls are: selector, bass, treble, and loudness; over-all size 11" x 5" x 7" d.  
.....\$39.95  
Kit .....\$22.95  
Case .....\$ 3.95

## NATIONAL

### Model 2000 Integrated Amplifier

Rated output: 15 watts; built-in preamp; 3-position record equalization; separate



bass and treble controls with 16 db boost or cut at 50 and 10,000 cps; frequency response: 20 to 20,000 cps ±0.5 db; hum 60 db below 15 watts on high level input, 50 db on phono input; inputs: magnetic (6 millivolts sensitivity), crystal phono, tape, tuner; output impedances: 4, 8, 16 ohms; one a.c. convenience outlet; tubes: 12AX7, 12AT7, 12AU7, 2-7408, 5Y3; 12 1/2" w. x 3 1/2" h. x 7 3/8" d.  
Kit form.....\$28.50  
Metal enclosure.....\$ 5.95

### Model STA-24 Stereo Amplifier

Williamson circuit preamp-amp; power output 15 watts per channel; separate bass and treble controls; selector switch for tape high and low, phono high or low, tuner and aux.; four dual inputs for channel A and B, tape and mag. phono, ceramic and xtal phono, tuner and aux.; distortion less than 1%; frequency response ±1 db 20-20,000 cps; tubes are 2-12AX7/ECC83/7025, 2-12AT7/ECC81, 4-7408,

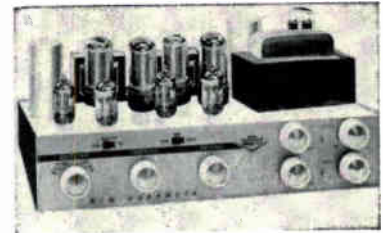

5U4 rectifier; 14" x 8" x 6".  
Kit .....\$39.95

### Model 2200 Integrated Amplifier

12-watt design; response 20-20,000 cps ±1 db; distortion 1% at 12 watts; four inputs—mag. phono/tape, crystal phono, tuner, mike/aux.; sensitivity phono 3 mv.,



others .5 v. for max. output; controls—function, loudness, bass, treble; tubes—12AX7, 12AT7, 2-6V6's 5Y3.

Kit .....\$22.75  
Metal enclosure.....\$ 3.95

## OLSON ELECTRONICS

### Model AM-231 Integrated Amp

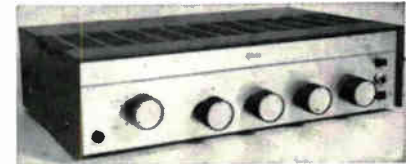

7 1/2 w./ch.; response 50-15,000 cps; 4,8,16 ohms; over-all size 12 3/4" w. x 8 1/4" x 3 3/4" d.  
.....\$39.98

### Model AM-240 Integrated Amp

25 w./ch.; response 15-40,000 cps. Has stereo balance meter and stereo headphone



jack; 4,8,16 ohms; 14 3/4" x 10 3/4" d. x 5" h.  
.....\$99.98

### Model AM-253 Stereo Amp

15 w./ch. response 30-25,000 cps; inputs: tape, phono (magnetic or ceramic), tuner,



aux. Controls: selector, bass, treble, volume, balance, function, rumble filter, loudness, and power; impedance 4,8,16 ohms. 12 1/4" w. x 10 3/4" d. x 4 3/4" h.  
.....\$59.99

## PACO

### SA-50 Integrated Stereo Amp

25 w./ch. music power; response 30-90,000 cps ±1 db, measured at 1 w. sine-wave

## STEREO/HI-FI DIRECTORY

power; HD .5% @ 20 w./ch.; IM 1% at rated output; hum & noise -80 db; sensitivity: high level .25 v.; magnetic phono 5 mv.; ceramic phono .3 v.; has 14 operating controls & conventional inputs; 15 1/2" x



11 1/4" x 5 1/2"; kit, less cabinet.....\$89.95  
 Factory assembled, including enclosure .....\$149.95  
 Metal enclosure.....\$ 7.95

### PILOT

#### Model 230 Integrated Amplifier

12 watts per channel (IHF); response 10-30,000 cps  $\pm 1$  db; harmonic distortion

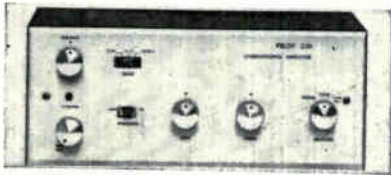

1% (IHF); hum level -80 db; sensitivity: mag. phono 3.5 mv., tape recorder 100 mv.; 8-16 ohm outputs; controls: bass and treble, volume, mode, selector, balance, loudness; 5" x 11 1/2" x 9 1/4"; with cover.....\$89.50

#### Model 246 Integrated Amplifier

30 watts per channel (IHF); response 10-40,000 cps  $\pm 1$  db; harmonic distortion

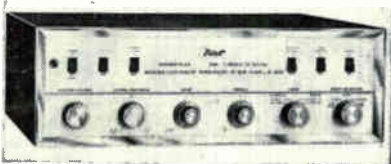

.1% (IHF); hum level -80 db; 4-8-16 ohms, center-channel, tape recorder outputs; sensitivity: two mag. phono (one can be used for tape head) and tape recorder (high-level) 110 mv.; has 11 operating controls; 5 1/2" x 14 1/2" x 12 1/4"; with cover .....\$199.50

#### A288 Integrated Stereo Amp

40 w./ch. music power; response 5-50,000 cps  $\pm 1$  db; HD 1%; hum -80 db.



Outputs: 4-8-16 ohms. Input sensitivity: mag. phono #1 12 mv., mag. phono #2 3 mv., tuner 1 & 2 110 mv., tape recorder 110 mv., tape head 2 mv., mic. 2.5 mv. Has center-channel output, 2 phone jacks & tape output. Controls: power/automatic shut-off, spkr. selector, balance, separate bass & treble, volume, scratch filter, rumble filter, phono input selector, bass compensator, tape monitor, stereo/mono, selector. 6 1/4" h. x 15 1/4" w. x 12 1/4" .....\$289.50  
 Oiled walnut cabinet.....\$ 22.50

### QUADRAMATIC

#### Model 402-C Power Amp

1965 EDITION



Stereo design; 40 w./ch.; response 5-60,000 cps; power response 25-20,000 cps; sensitivity 2.5 v. in high position & 1.1 v. in low position; distortion unmeasurable; damping factor nearly infinite; hum & noise 80 db below rated output; 5" h. x 11" d. x 17" w.....\$319.00

#### Model 110 Preamp

Stereo design; response 5-60,000 cps  $\pm 1$  db; noise 80 db below 10 v. r.m.s.; distortion unmeasurable; has input selector (mic., phono 1 & 2, tape, tuner 1 & tuner 2); volume, bass & treble controls; monitor output; rumble & high-freq. filters; 6" h. x 8" d. x 14" w.....\$249.00

### REALISTIC

#### Model SAF-24C Stereo Amplifier

15 watts per channel (60 watt mono peaks); response 20-20,000 cps  $\pm 1$  db;

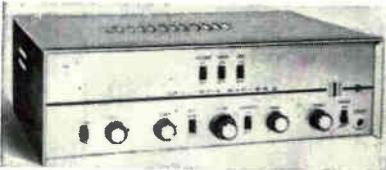

distortion 1.8% total r.m.s.; hum -52 db phono, -72 db tuner; sensitivity 4 mv. mag. phono, .85 v. tuner; tone controls; output impedances 4, 8, 16 ohms; 12" x 4 1/4" x 7 3/4" .....\$59.95

#### Model SA-203 Stereo Amplifier

Two watts per channel (8 watt mono peaks); response 90-15,000 cps  $\pm 2$  db; crystal/ceramic cartridge, high-level aux. input; 4 tubes; output impedance 4 ohms; 6" x 5" x 5" .....\$14.95

### SCHOBER

#### TR-2 Transistor Amplifier

Single-channel design with 55 mv. sensitivity for 40 w. continuous sine wave output @ 8 ohm load. Clipping power 50 w. @ 8 ohms, 48 w. @ 4 ohms, 31 w. @ 16 ohms, all at 1 kc. Response 20-20,000 cps  $\pm 1$  db at rated power. IM dist. 1.4% @ rated output; HD less than .75% (20-20,000 cps); hum & noise -83 db; input 100,000 ohms impedance. Kit.....\$69.95

### H. H. SCOTT

#### Model 299-D Stereo Preamp-Amp

Two complete amplifiers on one chassis; power output per channel 40 watts



(IHF music power standard); both channels in operation when used with monaural program sources; harmonic distortion less than 0.8%; IM distortion less than 0.5%; individual bass and treble controls for each channel; 2 low level and 3 high level inputs per channel; dual outputs to tape recorder and 4, 8, and 16

## BUYER'S GUIDE TO COMPONENTS TRADING



**1 TUNERS, RECEIVERS & AMPLIFIERS** . . . all leading makes and models. WHY BUY? When you can TRADE . . . and receive the highest trade-in allowance from the country's original and largest audio trading organization, Audio Exchange.

**2 RECORD PLAYBACK SYSTEMS, AND TAPE RECORD/PLAYBACK** . . . all leading makes and models. . . . The Hi Fi/Stereo components your ear is yearning for will not only cost you less when you trade by mail with Audio Exchange (or in person at our New York area showrooms), it's SAFER. Unmatched guarantees: free parts and labor within 90 days. . . . 75% allowance in trade-back within 6 months . . . plus a 10-day money-back guarantee on USED components.

**3 SPEAKER SYSTEMS, Wall, Large Enclosure and Bookshelf** . . . all leading makes and models . . .

■ FREE—"TRADERS HANDBOOK"—a colorful 12-page booklet that explains everything about trading by mail. New components from over a hundred manufacturers, and guaranteed used equipment by the carload. All at lower cost because of higher trade-in allowances. Write for free copy.

**audio exchange** WORLD'S FIRST AND FOREMOST HI FI/STEREO TRADING ORGANIZATION

PLEASE MAIL ALL ORDERS AND INQUIRIES TO JAMAICA  
 MANHATTAN—In Wiloughby's  
 110 W. 32nd St.—10 4-1600 Dept ED  
 JAMAICA—Near Parsons Blvd  
 153-21 Hillside Ave.—AX 7-7577  
 BROOKLYN—Near Macy's  
 1065 Flatbush Ave.—IN 9-6200  
 WHITE PLAINS—Near Post Road  
 203 Main Street—WV 8-3380  
 MANHASSET, L. I.—Opp. Theatre  
 451 Sandome Rd.—MA 7-5737

PLEASE SEND ME FREE BOOKLET

NAME \_\_\_\_\_

ADDRESS \_\_\_\_\_

CITY \_\_\_\_\_ STATE \_\_\_\_\_

CIRCLE NO. 8 ON READER SERVICE CARD

## NIMS NATIONWIDE IMPROVED MAIL SERVICE—

•  
 A PROGRAM  
 FOR REDUCING POSTAL COSTS  
 AND IMPROVING SERVICE  
 MAIL EARLY IN THE DAY  
 IT'S THE BETTER WAY!

•  
 LETTERS READY?—MAIL THEM EARLY!

# 1 Amplifiers

ohms to speaker; low level input sensitivity; 3 millivolts; 4-position record equalizer; NAB tape equalization; loudness-volume control; stereo balance control; scratch and rumble filters; phase reverse; stereo reverse; powered center channel output for direct speaker drive; microphone equalization; earphone outlet for binaural listening with speaker/earphone switch; tubes are: 4-12AX7, 2-6GH8, 5U4GB, 2-7591; Type "C" case extra.....less than \$230.00

## LK-72B Integrated Stereo Amp Kit

40 watts output each channel (IHF music power); IIF power band extending

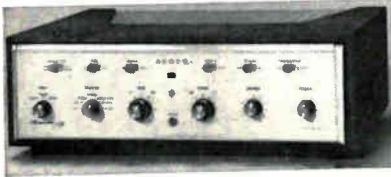

down to 20 cps; total harmonic distortion less than 0.8% at 1 kc. full power; hum level better than 75 db below full power output; stereo controls include center-channel level control, scratch filter, tape recorder monitor, separate bass and treble each channel; tube heaters d.c.-operated; Type "C" case extra.....less than \$150.00

## Model 233 Integrated Amplifier

Power output 33 watts per channel (IHF music power); hum and noise better than



75 db below full power output; harmonic distortion less than .8% at full power; response 20-20,000 cps; IM distortion less than .5%; IHF power band from below 19 cps to above 20,000 cps; inputs are either 3 mv. or 9 mv. for magnetic phono (RIAA) or tape head (NAB) equalization; tape monitoring provisions; tuner and extra high-level inputs provided; seven position stereo selector switch same as on 299-D; scratch filter; loudness compensation; stereo tape recorder outputs; powered center channel output for direct speaker drive; speaker/earphone switch; front-panel stereo headphone output; tubes— 4-12AX7, 2-7199, 4-7189, 1-5AR4; Type "C" case extra.....\$179.95

## LK-48B Integrated Stereo Amp Kit

Power output 24 watts per channel (IHF music power); hum and noise better than



75 db below full power output; harmonic distortion less than .8% at full power; response 20-20,000 cps; IM distortion less than .5%; IHF power band from below 19 cps to above 20,000 cps; inputs are either 3 mv. or 9 mv. for magnetic phono

(RIAA) or tape head (NAB) equalization; tape monitoring provisions; tuner and extra high-level inputs provided; seven-position stereo selector switch same as on 299-D; scratch-filter; loudness compensation; stereo tape recorder and derived center-channel outputs; all wires pre-cut to correct length; tube sockets, terminals, etc., are pre-riveted at factory; tubes—4-12AX7, 2-7199, 4-7189, 5AR4; Type "C" case available at extra cost. Kit.....less than \$130.00

## Enclosures

Type "C" metal enclosure.....\$13.95  
Type "C" wood enclosure, walnut or mahogany .....\$24.50  
Type "G" metal enclosure.....\$17.95  
Type "G" wood enclosure, walnut or mahogany .....\$29.95

## 4270 Transistorized Integrated Amp

30 w./ch. music power (25 w./ch. sine wave); 4-8-16 ohm outputs; power band-



width (IHF 19-10,000 cps  $\pm 1$  db; response 20-15,000 cps; HD .8%; hum level -70 db; damping factor 4; has all necessary inputs & outputs including center-channel and all conventional operating controls; 27 transistors, 9 diodes; 17 1/2" x 6 1/2" x 16 1/4" d.....\$395.00

## SHERWOOD

### S-5500 IV Integrated Stereo Amp

Has friction-locked dual knobs on bass and treble controls; 40 watts per channel

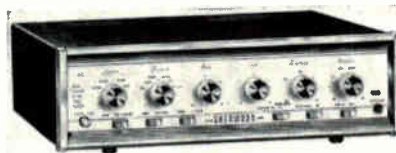

(80 watts total IHF music power); response 20-20,000 cps  $\pm 1/2$  db at 36 watts with 1 1/2% IM distortion; hum & noise, phono input 75 db below 1 watt; d.c. filament supply; inputs: tape head, phono, six high-level; two anode-follower recording outputs, two stereo/mono indicator lights; phono sensitivity 1.2 mv.; tuner .3 v.; damping factor 5; 4, 8, 16 ohm outputs; 14" x 12 1/2" x 4" high. Without case.....\$179.50  
With walnut leatherette case.....\$187.00

### Model S-5000 II 80-watt Integrated Stereo Amp

Similar in appearance to Model S-5500 IV; 40 watts per channel (80 watts total IHF music power); response 20-20,000 cps  $\pm 1/2$  db; IM distortion 1 1/2% at rated output; hum & noise, phono input 72 db below rated output; d.c. filament supply; sensitivity; radio .25 volt, phono 1.2 mv.; inputs: phono, tape head, six high-level; two anode-follower recording outputs; controls: 2 db/octave scratch and rumble filters, presence rise switch, four stereo/mono indicator lights; tubes: 4-7868, 6-12AX7/ECC83, 4-silicon rectifiers; 14" x 12 1/2" x 4" high .....\$199.50  
With walnut leatherette case .....\$207.00

### Model S-1000 III 40-watt Amplifier

Has 5 tubes & 4 silicon rectifiers; circuitry same as one channel of S-5000 II. Also fea-



tures 70-v. line output, low-level microphone channel with separate mixer-level control, and front-panel headphone jack; 14" x 4" x 10 1/2" d. Less cabinet.....\$124.50  
Walnut leatherette case.....\$ 7.50

## S-9000 Integrated Transistor Amp

Stereo design, 75 w./ch. music power (50 w./ch. r.m.s. sine wave). Features silicon



transistors & transformerless circuit. Controls: bass, treble, loudness, balance, selector, mode, phono level, scratch & rumble filters, loudness, phase, tape monitor. Response 20-20,000 cps  $\pm 5$  db at 50 w. HD .5% @ 50 w. from 20-20,000 cps; IM dist. 1% @ 55 w.; hum & noise 80 db below 50 w.; sensitivity: phono 1.2 mv., tuner .25 v.; damping factor 20; inputs: phono, tape head, tape monitor, aux., tuner. 14" x 4" h. x 12 1/4" d. ....\$299.50  
Leatherette case.....\$ 8.50

## TEECO

### Model 2225 Integrated Stereo Amp.

15 watts/ch. at less than 1% distortion; response 30-30,000 cps; 4-8-16 ohm output impedance; has 3 inputs—tuner, and crystal & magnetic phono; controls are: "off-on", mono/stereo selector, bass, treble, volume, balance, monitor, and function. 3-12AX7, 4-ECL86 & 2 silicon rectifiers are used .....\$117.25

## ULTRAUDIO

### D-4 Customixer

Mixer amplifier accepting up to 4 microphones, high or low impedance. Illuminated vu meter on each of two stereo high- and low-impedance output lines, zero level. Master gain control on each channel. Linear-motion potentiometers for utmost ease of operation .....\$288.00  
Model M-5 with one output line and 5 inputs .....\$288.00

## V-M CORP.

### Model 1428 Integrated Amplifier

Thirty watts (peak) output per channel (stereo design); 4-8-16 ohm outputs: 1% harmonic distortion and 2% IM distortion at rated output; response 20-30,000 cps  $\pm 2$  db; has conventional inputs: magnetic and crystal or ceramic phono, tuner, aux, and tape recorder; 5 1/2" h. x 13 1/2" w. x 10 1/2" d. Retail price.....\$129.95

### Model 1448 Stereo Amplifier

Dual-channel, 20 watts/channel integrated design; inputs for ceramic or crystal cartridge, radio, aux, or tape recorder; harmonic distortion less than 5% at rated output; response 40-25,000 cps; sensitivity: tuner .8 v., all others .25 v.; controls: bass, treble, balance, loudness, function, stereo/mono; 4-8-16 ohm output impedance; over-all size 5 1/2" h. x 13 1/2" w. x 10 1/2" d. Retail price.....\$89.95

## STEREO/HI-FI DIRECTORY

# Engineering Breakthrough! A 66-Watt Stereo Amplifier from Scott at only \$189.95



Never before has Scott offered such a combination of quality and performance at such a low price. Think of it... massive 66 watt output stage with distortion so low it can barely be measured... twelve front-panel controls, including full tape recording facilities... stereo headset output

... many other useful features that combine to give you control over program material unequalled by any other amplifier in its price range. Enjoy a lifetime of the finest music reproduction, choose the all-new Scott 233... truly today's most outstanding amplifier value.

Specifications and Features: Twelve front panel controls including complete tape monitoring and recording facilities and speaker on-off switch. Frequency response ( $\pm 1\text{db}$ ) 20 to 20,000 cps. Steady state power rating, 27 watts per channel. Provision for direct connection of tape deck. Dimensions in accessory case: 15½ wide x 5¼ high x 13¼ deep.



New Scott 299D 80-Watt stereo amplifier offers you famous Scott quality and reliability with 40 watts per channel... full undistorted power right down to the critical low frequencies. Outstanding features include: front panel headphone output for private listening, unique indicator light system showing mode of operation, and powered center channel output for extension speakers. The 299D is the latest in the famous Scott amplifier series consistently top-rated by leading consumer testing organizations. Handsome new decorator styling complements any room decor. Special jewel signal lights for easy operation. \$229.95

Export: Scott International, 111 Powdermill Road, Maynard, Mass. Canada: Atlas Radio Corp., 50 Wingold Ave., Toronto. Cable HIFI

**FREE!** NEW 1965 CATALOG AND GUIDE TO STEREO

H.H. Scott, Inc. 111 Powdermill Road Department 590-10 Maynard, Mass.

- Please send me your new 20-page full-color 1965 Stereo Guide and complete catalog.
- Send me complete information on new consoles by Scott... component quality in beautiful, hand-finished cabinets.

Name .....

Address .....

City..... Zone.... State.....



Price slightly higher West of Rockies. Subject to change without notice.

# the new Garrard models

here is a convenient chart  
of the key features of each unit:

**AT60—AUTOMATIC TURNTABLE—\$59.50**

**TYPE A70—AUTOMATIC TURNTABLE—\$84.50**

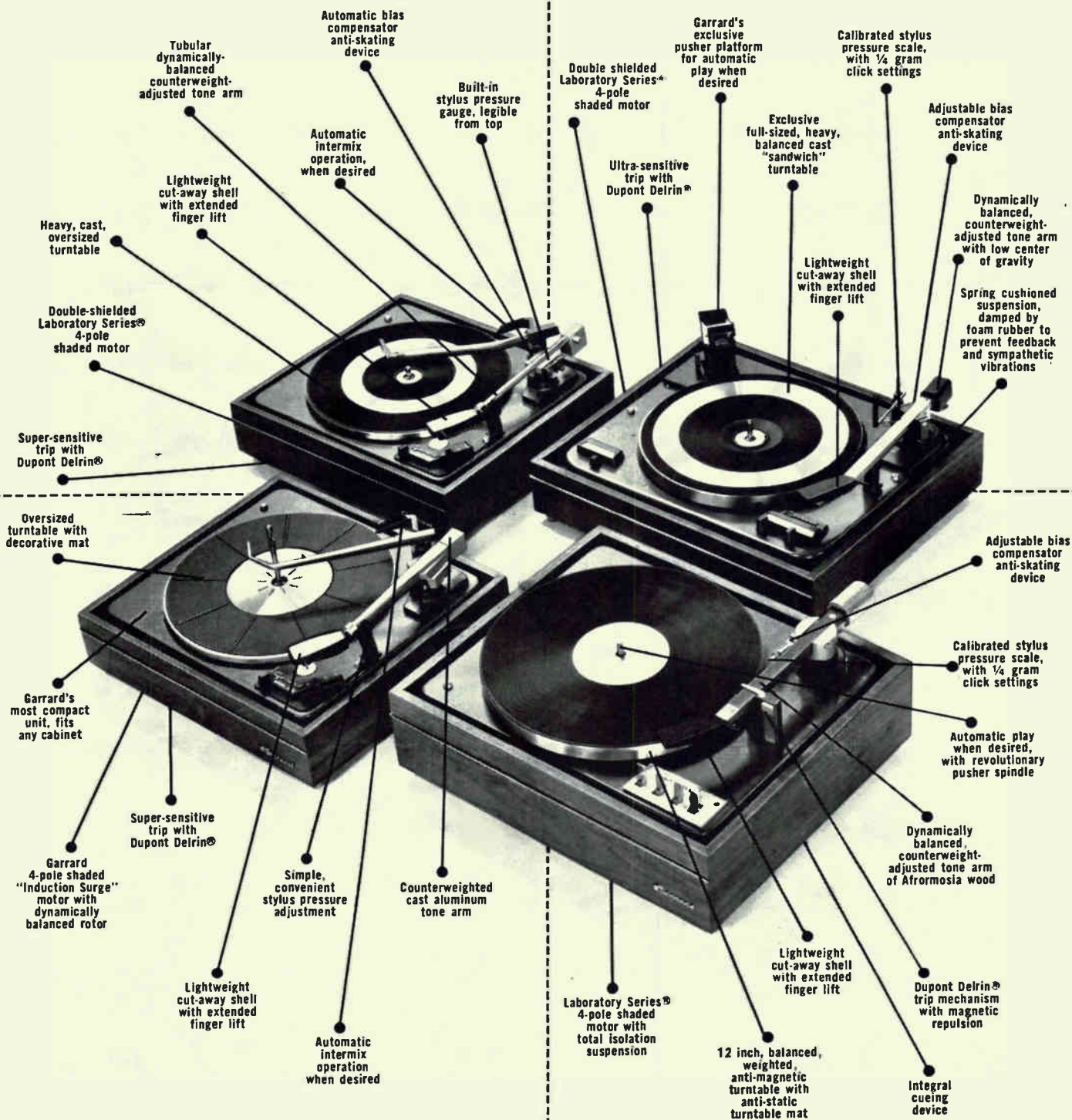

**MODEL 50—AUTOMATIC TURNTABLE—\$44.50**

**LAB 80—AUTOMATIC TRANSCRIPTION TURNTABLE—\$99.50**

For complete descriptive literature, write Garrard, Dept. GY-984, Port Washington, N.Y.



Special Feature Q & A ON HI-FI CARTRIDGES.....45

RECORD CHANGERS	}	33
AUTOMATIC TURNTABLES		
MANUAL TURNTABLES		

# PHONOGRAPH EQUIPMENT

PHONO CARTRIDGES.....	40
TONEARMS.....	47
PHONO ACCESSORIES.....	49

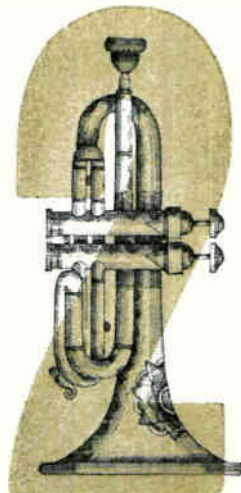

## ACOUSTIC RESEARCH

### AR Turntable

Two-speed (33 1/2 rpm & 45 rpm) turntable and arm combination; complete with oiled-



walnut base, transparent dust cover, and accessories such as needle force gauge, overhang adjustment device, etc.; meets NAB specifications for broadcast equipment on wow, flutter, rumble, and speed accuracy; 3.3 lb. machined, individually balanced aluminum platter is belt-driven from synchronous motors; insensitive to external shock or to acoustic feedback because of internal suspension; arm damping, which operates if arm is dropped, is released during play; less cartridge .....\$68.00  
Single speed, 33 1/2 rpm .....\$66.00

## BOGEN

### Model B62 Turntable

Continuously variable speed from 29 to 86 rpm; click-in position for 16 2/3, 33 1/2, 45,



78 rpm; 4-pole heavy-duty constant speed motor; nonferrous 7 1/4 lb. turntable; plug-in cartridge head; weight adjustment gauge; automatic cueing-flip switch raises and lowers arm; wow & flutter less than .2%; rumble -51 db; tracking force down to 1.5 grams; 15" x 3 1/2" x 13"; less cartridge .....\$64.95  
Walnut wood base .....\$ 5.25  
Dust cover .....\$ 5.50

### Model B51 Turntable

Continuously variable 29-86 rpm (fixed for 16 rpm); wow & flutter less than .4%; rumble 48 db below av. recording level; features 4-pole shielded motor; 3 1/4 lbs.,



11 3/8" dia. turntable; die-cast zinc alloy spring loaded; ball-bearing mounted tonearm; 4-pin plug-in cartridge head; 14 1/2" x 12 1/2" x 2 1/2" above deck & 2 1/4" below .....\$49.90  
Matching wood base.....\$ 5.25  
Extra plug-in shells.....\$ 2.75

## COMPONENTS CORP.

### Mark II Turntable

Two speed, lever shift belt-driven turntable with 4-pole induction motor; similar to Mark I in all respects except extra 45 rpm speed.....\$59.50

### Mark I Turntable

Single speed 33 1/2 rpm belt-driven turntable; 4-pole induction motor; filter capac-



itor across a.c. switch to eliminate click; improved motor suspension isolates motor vibration from the pickup arm; rumble down 70 db from standard reference of 7 cm./sec. at 1000 cps.; base finished in black with chrome trim.....\$49.50

### Model TT Turntable

Same as Model Mark I but in kit form .....\$29.50

## DUAL

### 1009 Automatic Turntable

Manual & automatic single play and automatic changer operation with interchangeable spindles; dynamically balanced tonearm tracks under 1/2 gr.; accepts all high-compliance cartridges; interchangeable cartridge

holder; four speeds (16, 33, 45, 78 rpm); variable over 6% range; strobe supplied; 7 1/2 pound nonferrous platter; motor resists line-voltage variations even exceeding 10%; direct-reading stylus force gauge 0-7 gr.; tracking error .4°/inch; pre-wired to permit shut-off of amplifier after play;



10 1/4" x 12 7/8" (3" below, 6" above deck); 110/220 v. a.c., 60 cycles.....\$99.50  
WB-91 Oiled walnut base.....\$11.95  
AS-9 45 rpm spindle.....\$ 4.80  
CH-6 Extra cartridge holder.....\$ 3.00  
DC-1 Dust cover.....\$11.95  
DCB-1 Dust cover & base.....\$29.50  
WB-39 Walnut base.....\$ 6.95

### 1010 Automatic Turntable

Manual & automatic single play and automatic changer operation; has interchangeable



able cartridge holder; 4 speeds (16, 33 1/2, 45 & 78 rpm); motor resists line-voltage variations even exceeding 10%; 1/2 gr. increments stylus force adjustment; tracking error below .75°/inch; pre-wired to permit shut-off of amplifier after play; 10 1/4" x 12 7/8" x 3" below & 6" above deck; accessories same as for Model 1009 .....\$69.50

### 1011 Automatic Turntable

Same design as Model 1010 plus record intermix .....\$72.50

## EMPIRE

### Model 208 Turntable

Has three speeds; hysteresis synchronous

# HAVE YOU HEARD WHAT THE EXPERTS SAY ABOUT KOSS STEREOPHONES?

"It was only yesterday that I purchased my set of Pro 4 Stereophones.

A whole new world of musical entertainment has been opened up for me. Listening to the harmony, instrumentation, shading etc. of my recordings is the most exciting thing that has happened to me for a long time.

Thank you so much for a perfect job of engineering."

J. S. Gardner  
Troy, New York

"I'm so enthusiastic about the Koss Stereophones I recently purchased that I felt I had to let you know how much pleasure I am receiving from them.

Since I live in a thin-walled apartment house, with early-to-bed neighbors, I just wasn't able to play my rig as often as I would have liked—the funeral march from the Eroica booming away at 1:00 a.m. is not exactly a lullabye. Now, at last I am finally getting full enjoyment from my hi-fi—in fact, I have just ordered a second set of Stereophones for guests.

Joan Shumway  
New York, New York

"I received a set of Koss Stereo headphones for Christmas and immediately realized they are the answer to a dream I've had for over 30 years. They fulfilled a need that has been gnawing at me since I first played my grandmother's Victrola and sat with my head inside the horn.

They so delighted my wife (who doesn't particularly care for music) that I had to buy her a pair or go without mine. A musician friend of mine bought two pair as soon as he heard mine.

Thanks again for developing Koss Stereophones they're great and my landlord is pretty glad I have them too."

Fred J. Dehler  
Brooklyn, New York



**KOSS PRO-4 STEREOPHONES \$45.00**

also manufacturers of famous Rek-O-Kut turntables

**KOSS REK-O-KUT**

2227 NORTH 31st STREET  
MILWAUKEE 8, WISCONSIN

CIRCLE NO. 34 ON READER SERVICE CARD



## 2 Changers & Turntables

motor; isolation-suspended motor and base plate; belt driven; 6 lb. aluminum turntable; pop-up 45 rpm adapter spindle; rumble better than -65 db; wow and flutter less than .05%; satin chrome or satin gold finish; 14<sup>1</sup>/<sub>16</sub>" x 16<sup>1</sup>/<sub>16</sub>" x 2<sup>7</sup>/<sub>8</sub>" above & 3<sup>1</sup>/<sub>2</sub>" below mounting board.....\$125.00

### Model 398 Transcription System

Includes Model 208 turntable, Model 980 tonearm with Dyna-Lift, walnut base; size



17" w. x 15" d. x 8<sup>3</sup>/<sub>4</sub>" h.....\$190.00  
Model 388 less base.....\$175.00

### Model 498 Transcription System

Includes Model 408 3-speed turntable, Model 980 tonearm, walnut base; size 16"



w. x 13<sup>3</sup>/<sub>4</sub>" d. x 7<sup>1</sup>/<sub>2</sub>" h.....\$187.00  
Model 488 less base.....\$172.00

### Model 408 Turntable

Available only as part of Models 488 and 498 transcription systems; compact size, 3-speed, belt-driven turntable; has 6 lb. aluminum turntable; pop-up 45 rpm adapter spindle; hysteresis synchronous motor; rumble better than -65 db; wow and flutter less than .07%.

### FISHER

### Model 70 Turnover Turntable

Automatically plays one or both sides of 7", 10", and 12" records intermixed;



holds up to 10 records (20 sides); more than 8 hours playing time; repeats one or both sides of each record if desired; only record in motion is one being played, permitting ideal stylus angle and pressure (3 grams) at all times; center spindle revolves with record, eliminating center-hole wear; electric trip mechanism leaves tonearm free during play; studio-quality turntable; two precision motors; 27" w. x 15<sup>3</sup>/<sub>8</sub>" d. x 19<sup>3</sup>/<sub>8</sub>" high over-all; single speed (33 rpm). Base optional at additional cost.....\$299.50

STEREO/HI-FI DIRECTORY

**GARRARD**

**Model A70 Automatic Turntable**

4-speed (16, 33½, 45 & 78 rpm) featuring dynamically balanced counterweighted



tonearm and weighted turntable; anti-skating device, stylus pressure gauge. Has plug-in cartridge shell, standard & manual spindles, manual 45 rpm adapter; less cartridge & 45 rpm automatic spindle.....\$84.50

**Model AT60 Automatic Turntable**

4-speed (16, 33½, 45, 78 rpm); dynamically balanced tonearm; anti-skating device;



automatic intermix record operation; stylus pressure gauge & plug-in cartridge shell. Has standard & manual spindles; less cartridge & 45 rpm spindle.....\$59.50

**Model 50 Automatic Turntable**

4-speed (16, 33½, 45 & 78 rpm); counter-balanced tonearm, plug-in cartridge shell;



intermix; stylus pressure gauge; available less cartridge & 45 rpm automatic spindle.....\$44.50

**Lab 80 Automatic Turntable**



33½ & 45 rpm featuring manual cueing, counter balanced wooden arm, 12" turntable, plug-in cartridge shell, magnetic end-

1965 EDITION

**HAVE YOU HEARD WHAT THE EXPERTS SAY ABOUT REK-O-KUT?**

"Wow and flutter were 0.07 and 0.03 percent at 33 rpm and 0.06 and 0.025 percent at 45 rpm bettering the rated 0.08 percent. The speeds were exact and were unaffected by line voltage variations from 70 to 135 volts... motor torque was sufficient to bring the turntable to full speed in about one second...the Rek-O-Kut R-34 was very easy to set up and use."

HI FI STEREO REVIEW (Julian D. Hirsch) May, 1964

"In stereo operation all turntables produce some audible rumble at high levels. Not the R-34 however. I found turntable rumble at normal music-listening levels so low that it was an effort to distinguish table rumble from that on the disc itself. This was an unprecedented experience for me... the finest rumble figures I have measured in any turntable."

AMERICAN RECORD GUIDE (Sound Ideas) April, 1964

"Excellent performance... Measurements made at United States Testing Co., Inc. further indicate very high levels of performance. Speed error was insignificant... Wow and flutter were of no consequence... The tone arm had no significant resonance above 10 cps, which is excellent... The R-34 in sum is a fine example of conscientious craftsmanship."

HIGH FIDELITY (U. S. Testing Labs) May, 1964

Complete reviews sent on request.



**REK-O-KUT R-34 (WITH ARM AND BASE) \$89.95**



also manufacturers of famous Koss Stereophones

**KOSS REK-O-KUT**

2227 NORTH 31st STREET MILWAUKEE 8, WISCONSIN

CIRCLE NO. 48 ON READER SERVICE CARD

## 2 Changers & Turntables

of-record trip; stylus force pressure scale and anti-skating device; will change 7", 10" & 12" records. Has standard & manual spindles, manual 45 rpm adapter; less cartridge & 45 rpm spindle: 17" wide x 14 3/4" x 5 1/2" above & 3 1/2" below motorboard .....\$99.50

### Wood Bases

B9U for "Lab 80" unfinished.....\$5.95  
 B9W for "Lab 80" walnut.....\$6.50  
 B8U for "Type 70" unfinished.....\$4.95  
 B8W for "Type 70" walnut.....\$5.50  
 B10U for "Models 60, AT60, 50" unfinished.....\$4.45  
 B10W for "Models 60, AT60, 50" walnut.....\$4.95

### Accessories

Mtg. boards available.....\$2.25  
 45 rpm spindles.....\$3.80  
 Dust covers for all models.....\$4.95

### GRADO

#### "Laboratory Standard" Turntable

Single speed, belt-driven design; wow .01%; flutter .025%; two 12-pole hys-

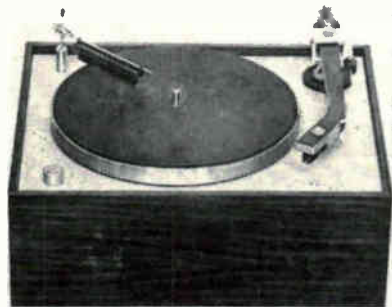

teresis synchronous motor; 16" w. x 13 1/2" d. x 8 1/2" high with arm (7 1/4" without arm); turntable & base.....\$115.00  
 With base, "Dustat" & "Lab Series" tonearm mounted.....\$169.50

### GRAY

#### Model PK-33 Turntable

Hysteresis synchronous-drive motor with polyurethane drive belt; multiplane shock



mounts; universal tonearm mounting allows almost all type tonearms to be used; flutter .08%; wow .2%; single 33 1/3 rpm speed; rumble -32 db @ 1000 cps and 7 cm/sec.; 4 7/8" h. x 12 1/4" l. x 12 1/4" w. Kit .....\$49.50

### HEATH

#### Model AD-92 Automatic Changer

Four-speed (16, 33, 45, 78 rpm) featuring

automatic or manual, stereo or mono operation; has automatic shut-off, plug-in cartridge head, friction drive, anti-skate device, and 4-pole motor; wow & flutter .2% r.m.s.; speed accuracy  $\pm 2\%$ ; tracking force variation .9 gr. from first to last record; will hold 10-12" or 12-10" records;



has manual reject control; 13 1/4" w. x 11 7/8" d. x 5 1/16" above & 2 3/8" below mounting board; with ceramic cartridge; (kit) \$46.90  
 With magnetic cartridge .....\$49.90  
 45 rpm adapter spindle .....\$ 2.95  
 Walnut base .....\$ 5.95  
 Unfinished base .....\$ 4.95

### Model ADP-21 Turntable Assembly

Includes Fairchild 440 turntable in kit form; assembled Fairchild 500 tonearm, Fairchild SM-2 stereo cartridge, Fairchild 440CBW walnut base; 33 1/3 & 45 rpm; arm transport has anti-skate device and dynamic balancing; tracking force 2.5 grams; response 20-15,000 cps  $\pm 2$  db; output 5 mv. @ 3.8 cm./sec.; wow .08% peak-to-peak; 17 7/8" w. x 15" d. x 3 1/2" below motorboard; (kit) .....\$124.95

### KLH

#### Model Eleven Portable Phono

AT-6 record changer with 4-pole motor and low-mass tonearm housing Pickering



V-15 cartridge with diamond stylus; dual-channel transistorized amplifiers; power rating 7 1/2 watts music power, per channel; controls: volume, bass and treble (each with 15 db boost or cut), balance, and mono/stereo switch; has separate tuner or aux. input; detachable KLH speakers have 40-ft. cables; cannot be used with other amplifiers; comes in portable carrying case; 24" l. x 14" d. x 7" h.; wt. 26 lbs. ....\$199.95

### Model Fifteen Compact

Compact stereo unit with integrated speaker systems & amplifiers; control center houses KLH changer with basic AT-6 changer mechanism with 4-pole motor; low-mass



tonearm with Pickering V-15 cartridge & diamond stylus. Transistorized stereo amplifier has output of 15 watts, 30 watts peak. Controls: volume, balance, bass & treble (each with 15 db boost or cut), mono/stereo sw., phono/aux. sw; stereo/aux. inputs also available on control panel; stereo headphone & stereo record/speaker outputs on rear panel; speaker system consist of two 3" drivers in ducted port enclosures; speakers may be separated up to 40 ft.

with cables supplied; cannot be used with other amplifiers; dimensions: control center -4" h. x 18" w. x 14" d.; speaker enclosures (each) -8" h. x 14" w. x 8 1/4" d. Oiled walnut.....\$259.95

### Model Twenty Stereo System

Complete system consisting of master control center & two speaker systems; control center contains KLH automatic turntable with low-mass tonearm & Pickering cartridge with diamond stylus; transistorized stereo preamp/amp with music power output of 40 watts, 80 watts peak; FM multiplex tuner with zero-center tuning meter, stereo signal beacon, built-in antenna, and vernier planetary tuning. Rotary controls: loudness-compensated volume, balance, bass, treble, and program selector. Slide switches: mono/stereo mode and power on/off. Output jacks for stereo headphones, stereo tape recording, speakers; two aux. inputs plus ext. 300-ohm antenna connection. Loudspeakers: 10" acoustic suspension woofer with special cone and magnetic circuit, 1 3/4" direct-radiator tweeter, plus special LCR crossover to permit increase or decrease of 2 1/2 db in high-frequency level without shelving in crossover region; speakers must be used only with Model Twenty amplifier. Dimensions: control center -4" h. x 18 1/4" w. x 14" d.; each speaker enclosure -23 1/8" h. x 11 1/4" w. x 9" d. Oiled walnut or mahogany....\$399.95

### Model Eleven W Compact

Cabinet version of the Model Eleven portable; designed for permanent placement; components are identical to those in Model Eleven. Dimensions: control center -4" h. x 18" w. x 14" d.; speaker enclosures (each) -8 1/2" h. x 15" w. x 4" d. ....\$209.95

### KNIGHT

#### KN-990A Automatic Turntable

Automatic turntable; 4 speed (16, 33, 45, 78 rpm); tonearm adjustable from 0-8



grams; oversize 11" turntable; 4-pole motor; 13 3/8" x 12" x 4 1/8" above mtg. board, 3" below; controls: speed, function, tracking weight; plug-in pickup head .....\$49.95

### LAFAYETTE

#### PK-770W Record Changer

Four speed (16, 33, 45, 78 rpm) with 4-pole motor & 8" turntable; wow .5%;



flutter .5%; has speed selector & reject on automatic cycling operation; wired for stereo; 14 3/4" x 13 3/4" x 5 1/2" above

mounting board & 4" below; less cartridge .....\$29.95  
 45 rpm spindle.....\$ 2.50  
 Walnut or mahogany base.....\$ 3.95  
 Unfinished mounting board for PK-770 W changer .....\$1.10

**Model PK-800W Record Changer**

Produced by Admiral and is similar to their "Ensign" design: four speeds (16 2/3, 33 1/3, 45, 78 rpm); automatic three-way shut-off; intermixes records of same speed; Ronette ceramic turnover stereo cartridge; stylus pressure 5-7 grams; will play man-



ually; 13 1/2" x 12" x 7 1/2" .....\$19.95  
 45 rpm spindle.....\$1.49  
 Walnut base.....\$4.50  
 Mahogany base.....\$3.95  
 Unfinished mounting board for PK-800 W changer.....\$ 1.10

**LESA**

**Model CD2/21 Automatic Changer**

Fully automatic with auto intermix; can be used for manual operation; 4 speeds;



6-second change cycle; universal plug-in head; tonearm mechanism is jamproof; after last record is played, tonearm is short circuited to prevent hum; plug-in shell is prewired for mono or stereo; 4-pole motor .....\$11.50  
 Extra universal plug-in head.....\$2.40  
 45 rpm spindle.....\$3.75  
 Base in mahogany, walnut.....\$4.75  
 Base in blonde.....\$5.25  
 Pre-cut mounting board for Model CA-2/21 changer .....\$2.00

**"Lesamatic" Automatic Changer**

Designed by Italian craftsmen; can be used as changer or played manually; has



stylus pressure gauge; counterbalance adjustment screw with marked gram measurements; plug-in head will accommodate most cartridges; heavy-duty 4-pole shaded motor; 4 speeds (16, 33 1/3, 45, 78 rpm); 12 1/2" x 11 1/2" x 5 1/4" above, 3" below top of motorboard; includes tonearm but less cartridge.....\$79.50  
 45 rpm spindle.....\$3.75  
 Base in walnut, mahogany, blonde to fit "Lesamatic" changer .....\$4.75  
 Base in oiled walnut.....\$6.75  
 Plastic cover to fit on above base.....\$6.50

**MIRACORD**

**Model 10H Automatic Turntable**

Can be used as manual single-record player (lifting arm starts turntable and at end



of play arm returns to rest and shuts off motor); automatic single-record player (where arm is operated automatically); continuous single-record player (record repeats automatically); automatic multiple-record player, accepts stack of up to 10 records; 6 lb. non-ferrous 12" turntable; hysteresis motor; stylus pressure gauge (2-6 grams); rumble -55 db; wow and flutter better than .1%; 14 1/2" w. x 12 1/2" d. x 5 3/8" above and 3 3/4" below mounting plate .....\$99.50  
 Lucite hinged cover .....\$14.95  
 Walnut base .....\$9.95  
 Walnut base with plexiglass hinged cover .....\$19.95  
 Mounting board .....\$3.00  
 Interchangeable plug-in head .....\$5.00  
 Automatic 45 rpm spindle .....\$5.00  
 Carrying case .....\$29.50

**Model 10 Automatic Turntable**

Same as Model 10H except has shaded 4-pole motor; rumble -50 db .....\$89.50

**PW-40 Automatic Turntable**

4-speed (16, 33, 45 & 78 rpm) design featuring manual or automatic operation. Will



play single record (automatic or manual), single record continuous, automatic multiple records (up to 10). Has automatic stop & lifting arm starts motor, a non-metallic 12", 6 lb. platter. Rumble -50 db; wow & flutter better than .1%. Stylus force 0 to 5 grs. Has stylus pressure gauge. 14 1/2" w. x 12 1/2" d. x 5 3/8" above mtg. plate & 3 3/4" below; right side clearance for arm 1"; supplied with tonearm less cartridge & base .....\$79.50  
 Accessories same as for Model 10H.

**RCA**

**Studiomatic "Feather Action" Record Changer**

Four-speed (16, 33, 45 & 78 rpm) design; will accommodate up to 15-7", 12-10", 10-12", or 10-10" and 12" intermixed; supplied with .7-mil diamond and 3-mil sapphire stylus in a ceramic cartridge; 15 3/4" (left-right) x 13 1/8" x 5 1/2" above and 3" below mounting surface.  
 Price, not more than.....\$60.00  
 Pre-cut mtg. board, not more than.....\$ 1.50  
 Mtg. base, not more than.....\$ 3.50

**UNIVERSAL RECORD SERVICE GOES WILD! SMASHING PRICES ON ALL RECORDS-ALL LABELS Lifetime Record Service ONE FEE!**



Here at last is the only record service that offers you every record on every label—at cost! As a member of Universal Record Service, you will enjoy the privilege of selecting any record in print (not just one label or a few labels, but all labels) and purchasing at savings up to one half of manufacturer's list price. What is more important, you will not have to obligate yourself to buy a certain number of records per year, nor to choose from a limited list. Simply stated, as a member of Universal Record Service, you will be entitled to select any record on any label, by any artist, and pay only cost price plus a few cents postage. Buy one record or a hundred. If it's in print we have it or can get it for you in a matter of days. Write for our price list that saves you up to 50% and more on all 33-1/3 mono and stereo L.P. records. Due to our huge purchasing power, we are able to offer super SPECIAL BONUS THROUGHOUT THE YEAR to our members. Lifetime entrance fee is only \$3.00. You can make this back in savings on your first purchase. PLUS—we send you, absolutely free, by return mail, the newest unabridged world famous Schwann Catalog.

Thousands of Satisfied Customers!

ALL RECORDS GUARANTEED FACTORY FRESH

**ACT NOW!**

FILL OUT AND MAIL COUPON TODAY FOR YOUR FREE BONUS

UNIVERSAL RECORD SERVICE  
 Box 1111P • Mountainside, N. J.

Gentlemen:

Enroll me now in the Universal Record Service. Enclosed is my  check  m.o. for \$3.00 covering lifetime membership. I understand this entitles me to buy all records at savings up to 50% off manufacturers list prices plus a few cents postage without obligation to purchase any certain amount, that I can choose any records in print and that, further I will receive absolutely free by return mail, the newest, complete Schwann Catalog as my bonus for acting immediately.

Name \_\_\_\_\_

Address \_\_\_\_\_

City \_\_\_\_\_ State \_\_\_\_\_

CIRCLE NO. 61 ON READER SERVICE CARD

## 2 Changers & Turntables



45 rpm spindle.....\$ 2.95

### REK-O-KUT

#### Model B-12H Stereotable

3-speed; hysteresis synchronous motor; 12" aluminum turntable; rubber mat; rim



driven by idler wheel; noise level: better than 59 db below average recording level; built-in 45 rpm adapter; pilot light; stroboscopic disc; dimensions for cabinet installation: left to right 17 3/4", front to back 16", height above deck 3", height below deck 6 1/4"; finish: silvertone aluminum .....\$165.00  
Base BH walnut.....\$18.95

#### Model B-12GH

All specifications identical to B-12H with the following exceptions: noise level -57 db; new design hysteresis synchronous motor; 4 3/4" below deck.....\$109.95  
Base BW-1 walnut.....\$16.95

#### Model K-33H Turntable Kit

Single speed (33 1/3 rpm); belt-driven; hysteresis synchronous motor; noise level 60 db below average recording level: adjustable belt tension; cast aluminum turntable; size with Rek-O-Kut tonearm 13" d. x 21" w. x 3" above deck & 4 1/4" below;



wow & flutter .08% r.m.s.; tonearm and base not included. Kit.....\$59.95  
Base KB walnut .....\$14.95  
Model K-34H. Same except 2-speed (33 1/3 & 45 rpm). Kit.....\$69.95

#### Model B-16H Turntable

16" cast aluminum 3-speed turntable primarily for broadcasting and recording studio use; hysteresis synchronous motor;

rubber mat; rim-driven by idler wheel; noise level: 50 db below average recording level; wow, flutter, and speed regulation meet NAB standards; built-in re-



tractable hub for 45 rpm records; built-in stroboscopic disc; size of deck: 18 3/4" x 20"; clearance required: above deck 1 1/2"; below deck 6 1/2"; finish: wrinkle gray; uses neoprene compound idlers; rotates on single-ball pivot.....\$275.00

#### Model C-7B Cabinet

Console cabinet designed to accommodate B-16H turntable without use of screws or bolts; 2 storage compartments; hinged doors with flush ring-latches; built-in electrical outlet; adjustable leveling domes; size: 33"h x 22"w x 20 1/2"d; finish: metallic gray.....\$150.00  
Model C-7BT (cut for any turntable) .....\$165.00

#### Model CVS-12 Turntable

Variable speed turntable operates on either 50 or 60 cycle current; speed variable from 25 to 100 rpm at 60 cycles and from 20 to 85 rpm at 50 cps.....\$99.95

#### Model R-34H Turntable

Dual-speed (33 1/3 & 45 rpm) design including tonearm & base; features hysteresis



synchronous, capacitor start/run motor; belt driven; wow & flutter .09% r.m.s.; noise -58 db @ 1000 cps; tonearm features plug-in cables, separate ground lead, & minimum 1 gr. tracking pressure; walnut base .....\$89.95

#### R-33 Turntable

Single-speed (33 1/3 rpm) for use with 12" tonearm. Noise level -60 db below av. recording level. Wow & flutter .08% r.m.s.; hysteresis synchronous motor. Deck size 14 7/8" x 14 1/2" x 3 1/2" above deck & 4 1/4" below .....\$69.95

## STANTON

#### Model 800B Stereotable

Complete record playing system which in-



cludes "Gyropoise" turntable, Model 200 "Unipoise" tonearm & walnut base; 15 7/8"

w. x 12 7/8" d x 6".....\$99.00

## THORENS

#### Model TD-111 Turntable

Single-speed turntable (33 1/3 rpm); precision Swiss assembly; 8-pound cast non-



magnetic 12" turntable, with motor isolation through idler and belt-type drive; self-lubricating bushings on all main drive parts; adjustable speed control (±3%); metal strobe disc included.....\$40.00  
WB-111 Base (walnut, mahogany, ebony) .....\$10.00

#### Model TD-121 Turntable

Single-speed turntable (33 1/3 rpm); same precision Swiss assembly as Model TD-124;



8-pound cast non-magnetic 12" turntable with combination belt and idler drive for isolation of motor vibration; adjustable speed control (±3%); self-lubricating bronze bushings on main drive shaft; separate tonearm board; adjustable built-in leveling feet; metal strobe disc included; 15 1/2" x 12 3/4" x 2 3/4" below base plate .....\$85.00  
Base in walnut, ebony, mahogany....\$10.00

#### Model TD-124 Turntable

Four-speed transcription turntable; 11 1/2 pound cast-iron and aluminum turntable



with built-in retractable hub for 45 rpm records and heavy rubber mat; extremely low wow, flutter, and rumble; induction-type roto-isolated drive motor; two-step speed reduction between motor and turntable—belt driven flywheel and stepped pulley-idler wheel speed shaft allows pulley to revolve at half the speed of conventional system—affording better contact with idler wheel; automatic disengagement of idler wheel; variable speed control (±3%) on all speeds with new eddy current brake design; self-contained 12" and 16" tonearm mounting boards; leveling knobs and built-

This  
is  
*the Townsend*<sup>®</sup>  
a new stereo turntable  
which you can own  
for only **\$59.95!**



That's all you will pay for this new top performance turntable by Weathers, a company whose turntables have won design awards and have been exhibited at the Louvre and Buenos Aires museums.

If you're graduating from a changer or looking forward to more discriminating music reproduction with a quality turntable, the Townsend will give you the comparable sound that only Weathers can produce . . . Yet the price is under sixty dollars!

This turntable could not have been built 10 years ago, despite lower labor and material costs at that time. It took Weathers' experience in the creation of prize winning turntables and a constant search for new and better techniques and materials to produce the Townsend — including solid walnut, oil finished base and tone arm\* — at this unequalled low price of \$59.95.

Specs? Here are a few: speed — 33 $\frac{1}{3}$  rpm; combined wow & flutter — .065%; rumble — min 50 db. The universal tone arm will accept a standard cartridge.

\* With Weathers top rated LDM Stereo Cartridge — \$69.95.

Write to Weathers for free literature about this new stereo turntable or better yet, visit your nearest hi-fi dealer for a demonstration.

**WEATHERS** Division of TelePro Industries, Inc.

**WEATHERS**

DIVISION OF TELEPRO INDUSTRIES, INC.  
CHERRY HILL INDUSTRIAL CENTER, CHERRY HILL, N. J. 08002

Please send me your free literature on the Townsend — the World's Greatest Turntable Value at \$59.95.

NAME \_\_\_\_\_

STREET \_\_\_\_\_

CITY \_\_\_\_\_ STATE \_\_\_\_\_ ZIP CODE \_\_\_\_\_

## 2 Changers & Turntables

in spirit level; base plate size 15½" x 12¾", required depth 2¾".....\$99.75  
Base in walnut, ebony, mah.....\$12.50

### TD-135 Transcription Turntable

Four-speed transcription turntable with integral professional arm; 8 lb., 12" non-



magnetic turntable (same as Model TD-121); variable speed control ± 3%; manual & stop switch; arm has instrument-type pivot bearings; calibrated stylus force adjustment; takes any standard stereo cartridge; 14½" x 11¾".....\$125.00  
Base.....\$7.00

### TD-224 "Masterpiece"

Combination turntable & record changer; an unusual design in that record stacking is



completely separate from turntable; records are played automatically and changed individually; includes Model BTD-12S tonearm; built-in record cleaning device; illuminated stroboscope; variable speed control; features 4 speeds; plays up to eight 7" to 12" intermixed records automatically; level indicator; automatic shut-off; base size 27" w. x 14½" d. x 4¼" h.; max. height for operation 9¾".....\$250.00

## V-M CORP.

### Model 1575 Deluxe "Stere-O-Matic"

Automatic changer; plays all 4 speeds (16, 33½, 45, 78 rpm); 11" turntable. Tonearm

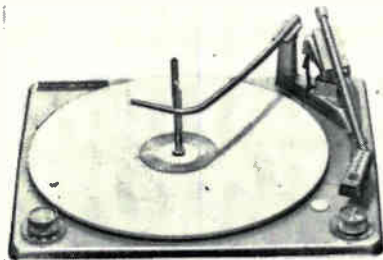

returns to rest post automatically after single record play & changer shuts off after last record has played. Wow .42% r.m.s.; flutter .21% r.m.s. & rumble .3% or less. Has tubular tonearm & diamond stylus. 8" h. x 13¼" w. x 12" (5¾" above mtg. board & 2¾" below) Retail price.....\$50.00

### Model 1552 "Stere-O-Matic"

Similar in design to Model 1575 except has 9" turntable & 8½" h. Retail price \$35.00

### Model 1477 Deluxe Base

Designed to fit all standard V-M changers. Walnut. Retail price.....\$11.95

## WEATHERS

### Model "66" Turntable

Employs two synchronous motors mounted on opposite sides of deck; rumble -60 db



with cut-off below 20 cps; platform tuned to 3 cps and suspended on neoprene mounts providing isolation from floor vibrations 500:1; flutter .04%; wow .02%; 33½ rpm; tonearm maximum tracking error 7°; brushed aluminum base supplied; 16¾" l. x 14½" d. x 2¾" h. including base.....\$75.00

### ML-66-A Low-Silhouette Turntable

Plug-in head accepts any make cartridge; has micrometer adjustment for normal range of tracking force; full-time vertical & lateral viscous-damped universal tonearm; no skating; base and tonearm of non-resonant walnut or oiled-walnut.....\$91.50  
Model K-66 with low dynamic mass (C-66) cartridge; tracking pressure below 1.5 grams.....\$99.50

### Model TP-2225 Stereo Turntable

Complete system, turntable, tonearm, cartridge, transistorized preamp & walnut base.



Has 12-pole synchronous hysteresis motor, viscous-damped tonearm, automatic shut-off, two pilot lights, headphone output connection. Response 20-20,000 cps ± 1 db; channel separation 40 db @ 8000 cps, 30 db @ 12,000 cps. Output 5 v. (50 kohms) at 5 cm./sec.; compliance 30 x 10<sup>-6</sup> cm./dyne; stylus .5 mil; tracking force 1 gr. Single speed 33½ rpm. Special "seismic platform" isolates turntable from room vibration 500 to 1 ratio. 14" w. x 16" d. x 3½" h. (including arm).....\$189.50

### "The Townsend" Turntable

Single speed 33½ rpm design. Rumble -50 db; wow & flutter .03%. Has uni-



versal cartridge mount for any make cartridge; adjustable stylus pressure & tracking angle. Walnut tonearm & base.  
Model 82-1 without cartridge.....\$59.95  
Model 82-2 with stereo cartridge.....\$69.95

## 2 Phono Cartridges

## ADC

### "Point Four" Stereo Cartridge

For manual turntables. Induced magnet design; sensitivity 5 mv. @ 5.5 cm./sec.; channel separation 30 db. 50-8000 cps; response 10-20,000 cps ± 2 db; .4-mil stylus; vertical tracking angle 15°; tracking force ¾ to 1½ gr. IM dist. less than 1% @ 14.3 cm./sec. velocity; compliance 30 x 10<sup>-6</sup> cm./dyne.....\$50.00  
"Point Four/E" with elliptical stylus \$60.00

### 660 Stereo Cartridge

For automatic turntables & changers capable of operating at low tracking force. Induced



magnet design; sensitivity 7 mv. @ 5.5 cm./sec.; separation 30 db, 50-8000 cps; response 10-20,000 cps ± 3 db; .5-mil stylus; 15° vertical tracking angle; 1½" to 4 grs. tracking force; IM dist. less than 1% @ 14.3 cm./sec.; compliance 20 x 10<sup>-6</sup> cm./dyne.....\$46.50

### 770 Stereo Cartridge

For good quality record changers. Same as Model 660 except 8 mv. sensitivity, .7-mil stylus, 2-6 gr. tracking force, compliance 15 x 10<sup>-6</sup> cm./dyne.....\$29.50

## ASTATIC

### Model 45D "Cantata" Cartridge

Ceramic stereo design featuring miniature alpha ray nuclear source which keeps



grooves free from foreign particles by dissipating static charge from record surface; 20-20,000 cps; 0.2 volt output at magnetic input (1000 cps @ 5 cm./sec.); separation 30-35 db; tracking force 1 gram; diamond needle; supplied with two equalizing networks to convert ceramic to RIAA magnetic input.....\$44.50

## DUAL

### DMS-900 Magnetic Stereo Cartridge

Tracking pressure 1.5-5 grs.; response 20-20,000 cps ± 3 db; output 6 mv. @ 5 cm./sec. and 1000 cps; separation 28 db @ 1000 cps; IM distortion 4% @ 5 cm./sec.; hor. compliance 4 x 10<sup>-6</sup> cm./dyne; vertical compliance 3 x 10<sup>-6</sup> cm./dyne; load 12,000-47,000 ohms; has .7-mil diamond stylus.....\$34.50

## DYNACO

### Stereodyne III Cartridge





## Why We Make the Model 211 Available Now

Although there are many stereo test records on the market today, most critical checks on existing test records have to be made with expensive test equipment.

Realizing this, HiFi/STEREO REVIEW decided to produce a record that allows you to check your stereo rig, accurately and completely, just by listening! A record that would be precise enough for technicians to use in the laboratory—and versatile enough for you to use in your home.

The result: the HiFi/STEREO REVIEW Model 211 Stereo Test Record!

## Stereo Checks That Can Be Made With the Model 211

- ✓ Frequency response—a direct check of eighteen sections of the frequency spectrum, from 20 to 20,000 cps.
- ✓ Pickup tracking—the most sensitive tests ever available to the amateur for checking cartridge, stylus, and tone arm.
- ✓ Hum and rumble—foolproof tests that help you evaluate the actual audible levels of rumble and hum in your system.
- ✓ Flutter—a test to check whether your turntable's flutter is low, moderate, or high.
- ✓ Channel balance—two white-noise signals that allow you to match your system's stereo channels for level and tonal characteristics.
- ✓ Separation—an ingenious means of checking the stereo separation at seven different parts of the musical spectrum—from mid-bass to high treble.

**ALSO:**

- ✓ Stereo Spread
- ✓ Speaker Phasing
- ✓ Channel Identification

## PLUS SUPER FIDELITY MUSIC!

The non-test side of this record consists of music recorded directly on the master disc, without going through the usual tape process. It's a superb demonstration of flawless recording technique. A demonstration that will amaze and entertain you and your friends.

# NOW...GET THE FINEST STEREO TEST RECORD

ever produced

for just...**\$4.98**

## Featuring The Most Spectacular Music Demonstration On Disc Today

### UNIQUE FEATURES OF HiFi/STEREO REVIEW'S MODEL 211 STEREO TEST RECORD

- Warble tones to minimize the distorting effects of room acoustics when making frequency-response checks.
- White-noise signals to allow the stereo channels to be matched in level and in tonal characteristics.
- Four specially designed tests to check distortion in stereo cartridges.
- Open-air recording of moving snare drums to minimize reverberation when checking stereo spread.

## All Tests Can Be Made By Ear

HiFi/STEREO REVIEW's Model 211 Stereo Test Record will give you immediate answers to all of the questions you have about your stereo system. It's the most complete test record of its kind—contains the widest range of check-points ever included on one test disc! And you need no expensive test equipment. All checks can be made by ear!

*Note to professionals: The Model 211 can be used as a highly efficient design and measurement tool. Recorded levels, frequencies, etc. have been controlled to very close tolerances—affording accurate numerical evaluation when used with test instruments.*

## DON'T MISS OUT—ORDER NOW

The Model 211 Stereo Test Record is a disc that has set the new standard for stereo test recording. There is an overwhelming demand for this record and orders will be filled by HiFi/STEREO REVIEW on a first come, first served basis. At the low price of \$4.98, this is a value you won't want to miss. Make sure you fill in and mail the coupon together with your check (\$4.98 per record) today.

## FILL IN AND MAIL TODAY!

Stereo Test Record  
HiFi/STEREO REVIEW—Dept. SD  
One Park Ave., New York 16, N.Y.

Please send me \_\_\_\_\_ test records at \$4.98 each. My check (or money order) for \$\_\_\_\_\_ is enclosed. I understand that you will pay the postage. (Add 50¢ to partially defray postage costs outside U.S.A.)

Name \_\_\_\_\_  
(Please Print)

Address \_\_\_\_\_

City \_\_\_\_\_ Zone \_\_\_\_\_ State \_\_\_\_\_

**SORRY—No charges or C.O.D. orders!**

**SD5**

## 2 Phono Cartridges

Moving-iron stereo cartridge imported from B&O of Denmark; 15° stylus angle; 4

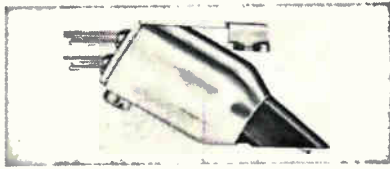

coils used in push-pull pairs; response  $\pm 2$  db from 20 to 20,000 cps; output 7 mv. per channel at 5 cm./sec.; tracking force 1-3 gr.; recommended load 47,000 ohms; 0.7 mil diamond stylus.....\$19.95  
Replacement diamond stylus 0.5, 0.7, or 3 mil available.....\$11.95  
Stereodyne II cartridge similar to Stereodyne III except 30-15,000 cps; and 2.4 gr. tracking force.....\$17.95  
Replacement styli for Stereodyne II..\$ 9.95

### ELAC

#### Model 322 Stereo Cartridge

Moving-magnet design; less than 2% IM & 1% harmonic distortion; Response 20-



20,000 cps  $\pm 2$  db; channel separations 25 db @ 1000 cps, 20 db @ 10,000 cps, 12 db @ 20,000 cps; output per channel 7 mv. @ 7 cm./sec.; compliance  $14 \times 10^{-6}$  cm./dyne (lateral & vertical); stylus force 1.5-3 grs. with most arms (1 gr. with some); supplied with .52 mil radius diamond stylus ..... \$49.50

### EMPIRE

#### Model 880 Stereo Cartridge

Response 10-25,000 cps  $\pm 1\frac{1}{2}$  db; output .01 volt per channel; .7 mil diamond styl-

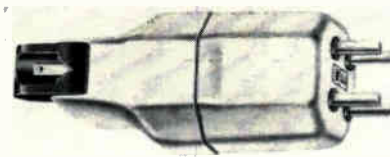

us;  $\frac{3}{4}$  to 6 gram tracking pressure; load impedance 47,000 ohms; channel separation 30 db or more; stylus compliance (vertical and horizontal)  $10 \times 10^{-6}$  cm./dyne; 4-terminal output; moving magnet design. Features 15° vertical tracking angle....\$19.95

#### Model 880P Stereo Cartridge

Response 10-28,000 cps; channel separation more than 30 db; output 8 mv./channel;

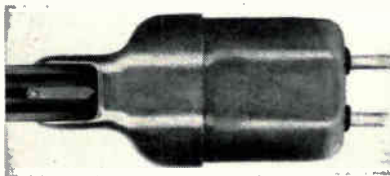

stylus compliance (vertical and horizontal)  $15 \times 10^{-6}$  cm./dyne; tracking force  $\frac{1}{4}$  to 4 grams; .6 mil diamond stylus; 4-terminal

output; load impedance 47,000 ohms. Features 15° vertical tracking angle.....\$19.95

#### Model 880PE Stereo Cartridge

Features 15° vertical tracking angle. Response 8-30,000 cps; output 8 mv./ch.;



separation more than 30 db; 47,000 ohm load impedance; compliance  $20 \times 10^{-6}$  cm./dyne; tracking force  $\frac{1}{2}$  to 4 grams; stylus .2 x .9 mil bi-radial elliptical diamond; 4-terminal output.....\$29.95

### EUPHONICS

#### "Mini-Mass" Ceramic Stereo Cartridge

Tracks at 1 gr. with a low-mass arm. Compliance  $17 \times 10^{-6}$  cm./dyne. Response

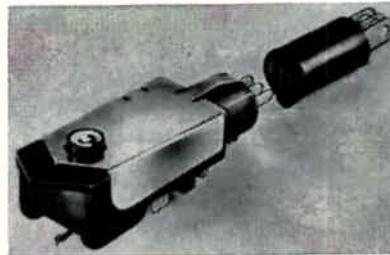

20-20,000 cps; .7 mil diamond with 3-mil sapphire on separate shanks.  
Model U-13 1000 pf., .3 v. output....\$10.29  
Model U-13-2 5000 pf., .15 v. output .....\$11.31  
Model U-13-5 7500 pf., .15 v. output .....\$11.64  
The high capacity units are for transistorized circuitry.

#### "Soft-Touch" Ceramic Stereo Cartridge

Features retractable stylus; response 20-20,000 cps; compliance  $8 \times 10^{-6}$  cm./dyne;

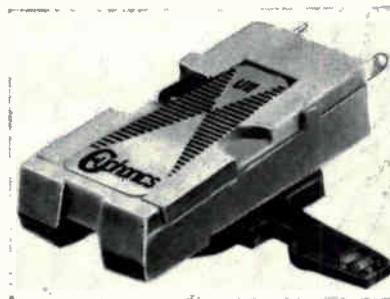

tracking force as low as 1.5 grs.; channel separation 25 db @ 1000 cps; has 7-mil diamond & 3-mil sapphire stylus.  
Model U-11R 1000 pf., .5 v. output....\$10.29  
Model U-11R3 7000 pf., .2 v. output..\$11.61  
Model U-11R8 3500 pf., .25 v. output .....\$11.31  
The high capacity units are for transistorized circuitry.

### GENERAL ELECTRIC

#### Model VR-225 Stereo Cartridge

Magnetic variable reluctance design; response 20-20,000 cps  $\pm 3$  db; output 5 mv. @ 3.8 cm./sec.; separation up to 25 db nominal; channel balance within 2 db 1000 cps; load impedance 47,000 ohms optimum; lateral compliance  $4 \times 10^{-6}$  cm./



dyne; vertical compliance  $3 \times 10^{-6}$  cm./dyne; tracking force 2-4 grams; .5-mil replaceable diamond stylus.....\$17.95

#### Model VR-227 Stereo Cartridge

Same as VR-225 except response 20-17,000 cps; lateral compliance  $2.5 \times 10^{-6}$  cm./dyne; vertical compliance  $2 \times 10^{-6}$  cm./dyne; tracking force 5-7 grams; .7-mil replaceable diamond stylus.....\$16.95

#### Model VR1000-5 "Orthonetic" Stereo Cartridge

For use with professional-type turntables and arms and record changers that will track below 4 grams; response 20-20,000 cps  $\pm 3$  db; tracking force 1-3 grams; vertical compliance  $6 \times 10^{-6}$  cm./dyne; lateral compliance  $6 \times 10^{-6}$  cm./dyne; 47,000 ohm load impedance; output 1 mv./cm./sec.; separation 25 db at 1000

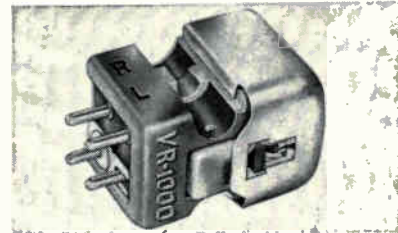

cps; channel balance within 2 db at 1000 cps; .5-mil replaceable diamond stylus .....\$29.95

#### Model VR1000-7 "Orthonetic" Stereo Cartridge

Similar to VR1000-5 except for use with any changer that will track from 3-7 grams; lateral compliance  $4.5 \times 10^{-6}$  cm./dyne; vertical compliance  $4 \times 10^{-6}$  cm./dyne; separation 20 db; has .7-mil replaceable diamond stylus.....\$24.95

#### Series VR-II Monophonic Cartridge

Variable reluctance magnetic design; single- and triple-play turnaround models; re-



sponse 20-20,000 cps; output voltage 10 mv. at 5.5 cm./sec.; lateral compliance  $1.7 \times 10^{-6}$  cm./dyne; vertical compliance  $.5 \times 10^{-6}$  cm./dyne; load impedance 100,000 ohms with 300 pf. shunt capacity; 47,000 ohms with 400 pf.; 6200 ohms with 1000 pf.; tracking force 4 grams with 1-mil stylus and quality tonearm; 6 grams with 3-mil stylus and quality tonearm; 6-8 grams for dual 1- & 3-mil styli used with record changer; replaceable stylus.  
Model 4G-050 (1 and 3 mil sapphire styli) .....\$12.95

- Model 4G-052 (1-mil diamond; 3-mil sapphire styli).....\$16.95
- Model 4G-053 (1-mil and 3-mil diamond styli) .....\$19.95
- Model 4G-040 (3-mil sapphire).....\$9.95
- Model 4G-041 (1-mil sapphire stylus).....\$9.95
- Model 4G-061 (1-mil diamond stylus).....\$13.95
- Model 4G-063 (3-mil diamond stylus).....\$13.95
- G-E stylus color code—Brown, .5 Dia.; Green, .7 Dia.; Black, 1.0 Dia.; Yellow, 2.5 Dia.; Violet, 3.0 Dia.; Blue, .7 Saph.; Red, 1.0 Saph.; White, 2.5 Saph.; None, 3.0 Saph.

**Model C100A Stereo Ceramic Cartridge**

Response 20-12,000 cps; output 450 mv.; channel balance 3 db at 1000 cps; Load

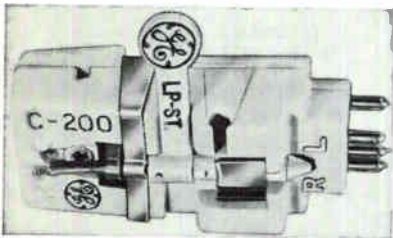

1 megohm, 100 picofarads; compliance 2.5 x 10<sup>-6</sup> cm./dyne; Tracking force 5-6 gr. Replaceable stylus .7 mil Dia. & 3 mil Saph. ....\$15.90

**Model C200 Stereo Ceramic Cartridge**

Same as Model C100A except response 20-17,000 cps & output 300 mv.....\$15.90

**GRADO**

**Mk I Stereo Cartridge**

Moving-coil design; response 10 to 50,000 cps; output 4 mv. @ 10 cm./v.; impedance 600 ohms/ch.; input load—any value over 2000 ohms; tracking force .2 to 2 grs.; compliance 30 x 10<sup>-6</sup>; separation 20 db; diamond stylus.....\$75.00

**Mk II Stereo Cartridge**

IM dist. .8%; tracking force .7 to 6 grs. Response 10-30,000 cps; output 6 mv./ch. @ 10 cm./v. Load imp. 5000 or over. Compliance 30 x 10<sup>-6</sup>; separation 30 db .....\$49.50

**Mk III Stereo Cartridge**

Similar to Mk II except at higher frequen-

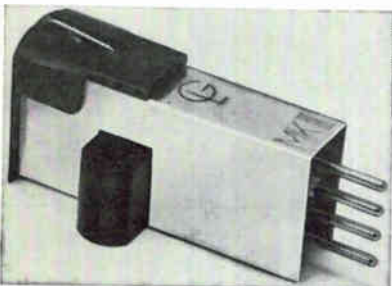

cies. Response 15-28,000 cps; compliance 25 x 10<sup>-6</sup>; separation 25 db.....\$37.50

**Mk IV Stereo Cartridge**

Similar to Models Mk II & Mk III but is somewhat crisper. Response 18-24,000 cps; separation 20 db.....\$27.50

**ORTOFON**

**Model SPU/GT Stereo Cartridge**

Response 20-20,000 cps; channel separa-



tion 20-25 db; load impedance 50,000 ohms; output at 1 kc. 7 mv. per channel; compliance 10 x 10<sup>-5</sup> cm./dyne; stylus pressure 1 to 2 grams; 4-pin terminal; cartridge is supplied mounted and enclosed within plug-in head; will fit any Ortofon tonearm.....\$50.00 With elliptical stylus.....\$75.00

**Model SPU/T Stereo Cartridge**

Identical to Model SPU/GT but without plug-in head; can be mounted in almost any make of tonearm.....\$50.00 With elliptical stylus.....\$75.00

**PICKERING**

**Model U38 Series Stereo Cartridge**



Designed especially for use with automatic turntables; response 20-20,000 cps; output 2 mv./cm. of recorded level; channel separation 35 db; tracking force 2 to 5 grams; magnetic ("Fluxvalve") design. Diamond stylus.....\$16.75 Model ATG for stylus force from 1 to 3 grams. ....\$17.95

**Model 380 Series Stereo Cartridges**

Frequency response 20-17,000 cps; output 2.5 mv./cm. of recorded level; channel separation 35 db; magnetic ("Fluxvalve")

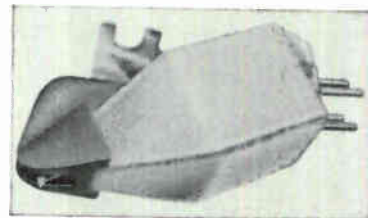

design with removable "V-Guard" diamond stylus.

Model 380A for manual tonearms; 2-5 grams tracking force.....\$11.75

Model 380C for automatic record changers. Designed for 4-7 grams tracking force .....\$11.75

**V-15 15° Cartridges**

15 degree tracking angle design. Has Mu-metal shielding & a replaceable floating stylus. Response 20-20,000 cps, channel

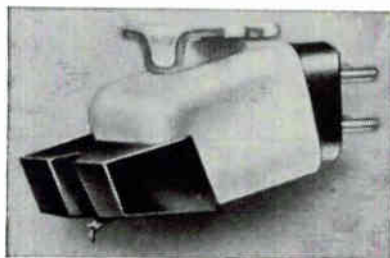

separation 35 db. AC-1 For inexpensive or old-style record changers where high out-

**SAVE On Stereo HI-FI**

**SEND NOW FOR FREE**

**228 PAGE CATALOG**

**B-A**

SINCE 1927

RADIO TV ELECTRONICS

Don't miss the 100's of amazing \$\$\$ savings on Complete Systems, components and kits—found ONLY at B-A!

**BURSTEIN-APPLEBEE CO.**

Dept. 57, 1012 McGee St., Kansas City 6, Mo.

Rush me FREE 1965 B-A Catalog

Name.....

Address.....

City.....State.....

**CIRCLE NO. 11 ON READER SERVICE CARD**

**Olson**

**\* FREE \***

**\* Fill in coupon for a FREE One Year Subscription to OLSON ELECTRONICS' Fantastic Bargain Packed Catalog — Unheard of LOW, LOW, DISCOUNT PRICES on Brand Name Speakers, Changers, Tubes, Tools, Stereo Amps, Tuners, CB, Hi-Fi's, and thousands of other Electronic Bargains. Credit plan available.**

NAME.....

ADDRESS.....

CITY..... ZONE..... STATE.....

If you have a friend interested in electronics send his name and address for a FREE subscription also.

**OLSON ELECTRONICS, INC.**

315 S. Forge Street Akron, Ohio 44308

**CIRCLE NO. 45 ON READER SERVICE CARD**

## 2 Phono Cartridges

put and heavier tracking force (3-7 gr.) are required, 8 mv. output.....\$15.95  
 AT-1 For automatic turntables or medium-priced systems where lighter tracking force (1-5 gr.) is desired. Has 7.5 mv. output & flat response .....\$17.95  
 AM-1 For manual turntables & higher-priced systems. Tracking force ¼-3 gr. 5.5 mv. output; flat response & low mass (5 gr.) .....\$21.95  
 AME-1 Elliptical bi-radial stylus; ¼-3 grs. tracking force; flat response; low mass (5 grs.); 5.5 mv. output.....\$29.95

### Model Mk 11 Cartridge

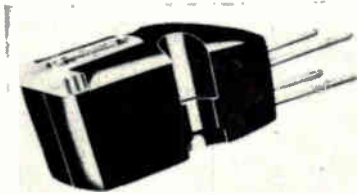

Frequency response 20-15,000 cps; output 1.3 mv./cm. of recorded level; channel separation 20/25 db; "T-Guard" stylus assembly; for changer; tracking force 4-7 grams .....\$7.79

### Plug-in Head Assemblies

Assemblies include pre-mounted cartridges for Garrard turntables.  
 For featherweight operation: 1-3 grams tracking (recommended 2 grams) where



environmental conditions permit light tracking forces; includes U38 stereo "Fluxvalve" cartridge with D3807ATG "Golden Safe V-Guard" floating stylus.  
 GA/38ATG for Garrard Type A.....\$22.95  
 G6/38ATG for Garrard Model AT6 .....\$22.95  
 For standard operation where environmental conditions require a nominal tracking force of 4 grams or more; with U38 stereo "Fluxvalve" cartridge and D3807AT "Safe V-Guard" floating stylus.  
 GA/38AT for Garrard Type A.....\$21.95  
 G6/38AT for Garrard Model AT6.....\$22.95

Note on "V-Guard" replacement stylus; AT stylus is for use in automatic turntables, recommended tracking force is from 2-5 grams; Type A stylus is for use in manual tonearms; Type C stylus is recommended for automatic record changers.

## SHURE

### Model V-15 Stereo Dynetic Cartridge

Features biradial elliptical stylus, 15° vertical tracking angle & scratch-proof retractile stylus. Response 20-20,000 cps; output 6 mv./ch. @ 1000 cps (5 cm./sec.); channel balance within 2 db; separation over 25 db from 20-5000 cps, over 20 db 5000 to 10,000 cps; tracking force ¼-1½ grs. Compliance vertical & horizontal 25 x 10<sup>-6</sup> cm./dyne; load impedance 47,000 ohms; Diamond stylus .9 mil frontal radius, .2 mil side contact radii, 1.2 mil wide be-

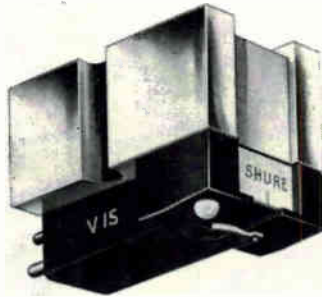

tween record contact points.....\$62.50  
 Replacement stylus VN2E.....\$25.00

### M55E Stereo Cartridge

Similar in design & performance to Model V-15 except produced and tested under

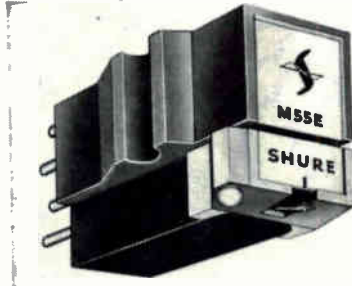

normal manufacturing processes. The V-15 gets individualized attention both in manufacture and testing.....\$35.50  
 Replacement stylus N55E.....\$20.00

### M44 Series Stereo Cartridges

Features 15° tracking angle, retractile stylus. Response 20-20,000 cps, channel separation greater than 25 db. Appearance similar to M55E.

M44-5 compliance 25 x 10<sup>-6</sup> cm./dyne; tracks ¼-1½ grs. with .5 mil diamond; output 6 mv./ch.....\$21.95  
 Replacement stylus N44-5.....\$11.35  
 M-44-7 cartridge compliance 20 x 10<sup>-6</sup> cm./dyne; tracks at ¼-1½ grs. with .7 mil diamond; output 9 mv./ch.....\$19.95  
 Replacement stylus N44-7.....\$ 9.75  
 N44-1 For mono LP records at 1½ to 3 grs. with .001" diamond.....\$9.75  
 N44-3 For 78 rpm mono records at 1½ to 3 grs. with .0025" diamond.....\$9.00

### Model M3D Stereo Cartridge

May be used with mono or stereo records; frequency response 20 to 15,000 cps ±3 db; compliance (vertical and lateral) 4x10<sup>-6</sup> cm./dyne; output 5 millivolts;

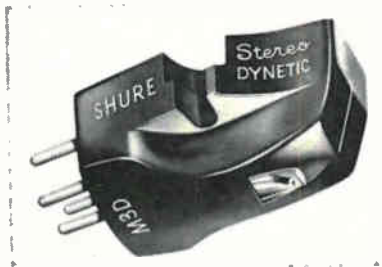

tracking force 3-6 grams; recommended load impedance 50,000 ohms; 0.7-mil diamond stylus.....\$15.75  
 N3D replacement diamond stylus.....\$ 9.95

### M-99 "Gard-A-Matic" Cartridge Assembly

Designed for Garrard and Miracord automatic turntables; supplied mounted in shell; is scratch-proof, bounce-proof & will track all records at 2 grs.; response 20-20,000 cps; tracking force 1.5-3 grs; separation 22.5 db @ 1 kc.

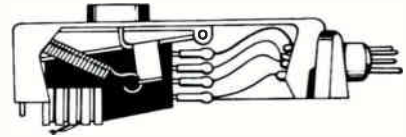

Model M99/A for Garrard Laboratory type A turntable, with .7-mil diamond stylus .....\$24.75  
 Model 99/AT6 Same, for Garrard AT6 .....\$24.75  
 Model M99/M10 Same, for Miracord M10 & M1011.....\$24.75  
 Model N99 Replacement stylus.....\$12.95

### Model M7/N21D

Features a tracking force of 2½ grs. or less. Response 20-20,000 cps; output 4 mv. per channel; compliance 9 x 10<sup>-6</sup> cm./dyne; separation over 20 db.....\$17.95  
 N21D Replacement stylus.....\$12.50

## SONOTONE

### Model 12 Stereo Crystal Cartridge

Made of plastic; has jack-in terminal plug to connect to tonearm wires; stylus is

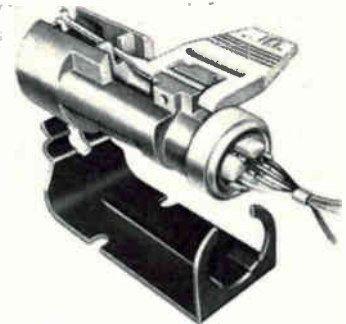

changed by snapping out turnover lever; Model 12THR has output of 2.5 volts; standard sapphire stylus are 0.7 mil and 3 mil radius .....\$5.85

### Model 20T Stereo Crystal Cartridge

Turnover-type cartridge for LP, 45 & 78 records. Direct replacement for Ronette, Vaco, and BSR type cartridges.  
 20T1-S output of 1 v. (dual sapphire) .....\$3.50  
 20T2-S output of 2 v. (dual sapphire) .....\$3.50  
 21T1L,B-S available without bracket (dual sapphire) .....\$3.25  
 20T2L,B-S available without bracket (dual sapphire) .....\$3.25

### Model 14T Mono Crystal Cartridge

Turnover-type cartridge for LP, 45 & 78 records. Direct replacement for Ronette, Vaco, and BSR type cartridges.  
 14T-S output of 3.6 volt (dual sapphire) .....\$2.50  
 14T1L,B-S available without bracket (dual sapphire) .....\$2.25

### 22T Stereo Ceramic Cartridge

High-compliance stereo ceramic cartridge complete with snap-in mounting bracket; turnover type cartridge, plays all speeds; equipped with "Sono-Flex" needle; output 0.3 v.; compliance 10 x 10<sup>-6</sup> cm./dyne; separation 24 db; tracking force 2-4 grs.  
 22T-S (.7-mil and 3-mil sapphire).....\$6.95  
 22T-S77 (dual .7-mil sapphire).....\$6.95  
 22R-SD (.7-mil diamond and 3-mil sapphire) .....\$9.70

### 23T Stereo Ceramic Cartridge

High-compliance stereo ceramic cartridge complete with snap-in mounting bracket and bottoming buttons; turnover-type cartridge, plays all speeds; equipped with



# PHONO CARTRIDGES

By R. E. WARD / Distr. Sales Mgr., Shure Brothers Inc.

**I**N reviewing the correspondence we have received from consumers over the past several years, we find a pattern of questions emerging. Nearly all of these questions involve tracking forces of cartridges. Here is a typical assortment of such inquiries.

*Why are there ranges of tracking force?* This is due to the use of different tonearms with the cartridges and in the choice of different types of recorded material. A cartridge used in a top-quality professional tonearm may track at  $\frac{3}{4}$  gram; in a less expensive type tonearm, it may require  $1\frac{1}{2}$  grams and, in most changers, 2 to 5 grams in order to compensate for the increased frictional content and other varying factors. A person who likes chamber music or relatively "soft"—not highly modulated types of music—may be able to track at forces  $\frac{1}{4}$  to  $\frac{1}{2}$  gram lighter than a person who likes very heavily modulated—"spectacular"—demonstration-type discs.

*How do I select the optimum "tracking force"?* The approach is really quite simple. Select a record that contains the type of music, in terms of dynamic range, that you most frequently listen to. Adjust your tonearm for the lowest tracking force specified for the cartridge. Listen to the record. If you hear sounds of distortion or break-up, or if the arm skips grooves, gradually increase the tracking force until the distortion, break-up, and groove skipping ceases. At this point, you will have achieved the optimum tracking force for the tonearm and cartridge combination you have selected. Of course, one must be sure that the tracking force range of the cartridge is now within the optimum range.

*How important is low "tracking force"?* The object is to reduce record wear and stylus tip wear to a minimum. There are other factors involved besides tracking force, but tracking force is the overwhelmingly important factor. In general, if a cartridge tracks satisfactorily at 2 grams or less, you will find that record and stylus wear have reached the vanishing point, for all practical purposes. Of course, the type of dust in the atmosphere, and the amount of this dust which is usually on the phonograph record when it is played, will cause a variance in the actual number of plays achievable.

*What about record cleaners?* In general, it is not desirable to use any type of wiping cloth or spray which imparts a foreign substance that tends to mix with the dust and form a type of mucilage. It can eventually completely encase the diamond stylus tip and cause serious record wear, along with greatly deteriorated performance levels. Wiping the record with a nap-type pad is usually the best.

*What size stylus tips should be used?* The older 78-rpm records require a stylus with a radius of .0027" (.0025 to .003). (A stereo cartridge is perfectly capable of playing 78-rpm records, providing a stylus with the proper size tip is used.)

The earlier mono LP recordings (33 $\frac{1}{3}$  and 45 rpm) were cut with a groove that required a stylus of .001" tip radius. These earlier recordings were not cut with a "V" groove and, therefore, it was important that the stylus tip was not too small because it would then ride down on the bottom of the groove. As long as the stylus is riding up in the groove itself, and not "bottoming", everything is fine.

The advent of stereo led to the choice of a .0007" (.7 mil) stylus tip radius. This is a compromise tip guaranteeing good performance on the majority of mono LP records and stereo discs. (With the advent of this smaller size tip, it became apparent that lower tracking forces were necessary. As the tip size is reduced, the effective pressure between tip and record increases.)

However, on heavily modulated passages, the .7-mil stylus began to encounter turns in the stereo record groove that were too sharp for it to negotiate readily. It tended to ride up in the groove, and this became known as "pinch effect", thus the .0005" stylus came into being. This stylus gave excellent reproduction with stereo records; however, when used with mono records, it tended to "bottom" in the grooves of the older mono records and produce noise and distortion. Therefore, many record enthusiasts who had large libraries of mono LP's in addition to the new stereo records, tended to use the .0007" as a compromise or two styli. For the best results on stereo records, they used the .0005" stylus. For their older LP's, they used the .001" stylus. This provided an ideal arrangement from the standpoint of maximum listening quality, but it did involve the inconvenience of changing needles when shifting from one type of record to the other.

*What about the elliptical stylus?* This is a type of stylus with an elliptical rather than a conical tip. In one such stylus, the tip radius from side to side is .0009", while the radius from front to back is only .0002". This means that it will ride up in the mono groove and not get down into the questionable area that produces noise and distortion. This enables the stylus to faithfully trace the sharpest turns in the groove. Some of these turns are extremely sharp because of the shape of the cutting stylus. In general, it can be stated that the elliptical stylus should not be used with tracking forces greater than  $1\frac{1}{2}$  to 2 grams. This is also true of the 0.5-mil stylus. The .7-mil stylus can be safely used with tracking forces in the 2- to 4-gram range. Tracking forces in excess of this should be avoided if possible. If you have a large library of mono LP's, as well as stereo LP's, the elliptical stylus will give you very good results on both types of records. If you are playing stereo records only, then you will find the elliptical stylus is still capable of giving faithful reproduction. Because of its extremely small front-to-back radius, it is capable of negotiating heavily modulated tracks in the record without losing contact or being "pinched" out of the groove. 

## 2 Phono Cartridges

"Sono-Flex" needle; output 0.4 v.; compliance  $10 \times 10^{-6}$  cm./dyne; separation 24 db; tracking force 2-4 grs.  
 23T-S (.7-mil and 3-mil sapphire).....\$7.65  
 23T-S77 (dual .7-mil sapphire).....\$7.65  
 23T-SD (.7-mil diamond and 3-mil sapphire) .....\$10.40

### Model 10T Stereo Ceramic Cartridge

For stereo or mono records; "fuse clip" mounting bracket; frequency response 20-15,000 cps  $\pm 2.5$  db; output 0.5 v.; compliance  $1.5 \times 10^{-6}$  cm./dyne; channel isolation 18 db; recommended load 1-5 megohm; tracking force 5-7 grams.  
 Model 10T2-S (0.7-mil sapphire, 3-mil sapphire) .....\$6.95  
 Model 10T2-SD (0.7-mil diamond, 3-mil sapphire) .....\$9.70  
 Model 10T2-S77 (0.7-mil sapphire, 0.7-mil sapphire) .....\$6.95  
 Model 10T2-SD77 (0.7-mil diamond, 0.7-mil sapphire).....\$9.70

### Model 3T-SD Pickup

Ceramic turnover cartridge; frequency response: 20 to 15,000 cps with gradual roll-off to 20,000 cps; compliance: 2.0 microcentimeters per dyne; output: 0.5 volt on microgroove records (5.5 cm/sec. recording level); 4-6 gram stylus pressure required; standard  $\frac{1}{2}$ " or  $\frac{3}{8}$ " mounting centers; diamond LP and sapphire 78 styli .....\$10.50

### Model 1P and 2TA Ceramic Cartridge

Model 1P is single-stylus cartridge, Model 2TA is two-stylus turnover-type; frequency response 30 to 15,000 cps  $\pm 3$  db; compliance  $2 \times 10^{-6}$  cm./dyne; output: 1 v.; tracking force 6-8 grams; recommended load 1-5 megohms.  
 Model 1P-1S (1-mil sapphire).....\$4.85  
 Model 1P-2S (2-mil sapphire).....\$4.85  
 Model 1P-3S (3-mil sapphire).....\$4.85  
 Model 1P-1D (1-mil diamond).....\$7.60  
 Model 1P-3D (3-mil diamond).....\$7.60  
 Model 2TA-S (2 sapphires).....\$6.15  
 Model 2TA-SD (1-mil diamond, 3-mil sapphire) .....\$8.90

### Model 8TA Stereo Ceramic Cartridge

For use with stereo or mono records; turnover-type; frequency response 20 to 15,000 cps, roll-off beyond; compliance  $3.0 \times 10^{-6}$  cm./dyne; tracking force 3-5 grams for professional arms, 4-6 grams for changers; channel isolation 20 db; recommended load 1-5 megohms.  
 Model 8TA-4S (0.7-mil and 3-mil sapphires) .....\$ 8.75  
 Model 8TA-4SD (0.7-mil diamond and 3-mil sapphire) .....\$11.50

### 9TAFHC Stereo Ceramic Cartridge

High-compliance turnover cartridge, handles all speeds; stereo and mono; equipped with "Sono-Flex" needle; response  $\pm 2$  db 20-7000 cps; compliance  $15 \times 10^{-6}$  cm./dyne; separation 30 db; load 1-5 megs for ceramic input; tracking force 1.5 to 3 grs. for professional arms, 3-4 grs. for changers.  
 9TAFHC-S (.7-mil and 3-mil sapphire) .....\$9.35  
 9TAFHC-S77 (dual .7-mil sapphire) \$9.35  
 9TAFHC-SD (.7-mil diamond and 3-mil sapphire) .....\$12.10  
 9TAFHC-D77 (dual .7-mil diamond).....\$13.10

### 9TAF Series Ceramic Cartridge

Turnover design handles all speeds, stereo

& mono; equipped with "Sono-Flex", flex-type, virtually breakproof phono needles; response 20-17,000 cps  $\pm 2$  db; compliance separation 30 db; load 1-5 megs for ceramic input; tracking force 2-4 gr. for professional arms, 3-5 gr. for changers;  $15 \times 10^{-6}$  cm./dyne.

9TAF-SF .7-mil & 3-mil sapphires.....\$ 8.85  
 9TAF-S77 Dual .7-mil sapphires.....\$ 8.85  
 9TAF-SD .7-mil diamond & 3-mil sapphire .....\$11.60  
 9TAF-D77 Dual .7-mil diamonds.....\$12.60

### 16TAF Series Ceramic Cartridge

Turnover design equipped with "Sono-Flex", flex-type, virtually breakproof phono



needle; response 20-10,000 cps; separation 25 db; load 2 megs.; output voltage .6 volt; compliance 2.4; tracking force 4-6 gr. for professional arms, 5-7 gr. for changers.  
 16TAF-S .7-mil & 3-mil sapphires.....\$ 6.50  
 16TAF-S77 Dual .7-mil sapphires.....\$ 6.50  
 16TAF-SD .7-mil diamond & 3-mil sapphire .....\$9.25

### Model 18TA Stereo Ceramic Cartridge

Specification same as for Model 16TA but with output of .10 volt; channel separation of 20 db; tracking force of 6-8 grams for professional arms, 7-9 grams for changers.

Model 18TA-S (.7 mil and 3 mil sapphires) .....\$ 6.00  
 Model 18TA-SD (.7 mil diamond, 3 mil sapphire) .....\$8.75  
 Model 18TA-S77 (.7 mil and .7 mil sapphires) .....\$ 6.00

### 916TAF Series Ceramic Cartridge

Turnover design handles all speeds, stereo and mono; equipped with "Sono-Flex" phono needle; response 20-15,000 cps  $\pm 2$  db; output .45 volt; compliance  $4 \times 10^{-6}$  cm./dyne; channel separation 28 db; load impedance 2 megs.; tracking force 2-5 gr. for professional arms, 4-6 gr. for changers.  
 916TAF-S .7-mil & 3-mil sapphires..\$ 7.65  
 916TAF-S77 Dual .7-mil sapphires.....\$ 7.65  
 916TAF-SD .7-mil diamond & 3-mil sapphire .....\$11.75

### "Velocitone Mark IV" Ceramic Assembly

Permits use of Sonotone's stereo cartridge without modification of velocity or magnetic amplifier system of record player; assembly consists of 9TAFHC stereo ceramic cartridge and two factory-matched equalizers; response 20-6000 cps  $\pm \frac{1}{2}$  db and to 17,000 cps  $\pm 1$  db, roll-off to 20,000 cps; output voltage 11 mv.; compliance  $15 \times 10^{-6}$  cm./dyne; tracking force 1.5-3 gr. for professional arms, 3 grams for changers.

9TAFHC-SDV (assembly with diamond/sapphire tips) .....\$20.25  
 9TAFHC-D77V (assembly with dual .7 mil diamond tips) .....\$24.25

### 21TR Stereo Ceramic Cartridge

Complete with retractable mounting bracket and bottoming buttons; turnover type cartridge, plays all speeds; equipped with "Sono-Flex" needle; output 0.6 v.; compliance  $5.5 \times 10^{-6}$  cm./dyne; separation 21 db; tracking force 4-7 gr.; Model 21T available with standard snap-in type mounting bracket.

21TR-S (.7-mil and 3-mil sapphire) \$6.95  
 21TR-SD (.7-mil diamond and 3-mil sap-

phire) .....\$9.70  
 21T-S (.7-mil and 3-mil sapphire).....\$6.50  
 21T-SD (.7-mil diamond and 3-mil sapphire) .....\$9.25

## STANTON

### Model 500AT Micro "Fluxvalve"

Total weight 5 grs; for stereo & mono; .7 mil diamond stylus & replaceable plug-in



"V-Guard" stylus assembly. Response 20-20,000 cps. Output 1.5 mv./cm. of recorded level; channel separation 35 db; 47,000 ohm load impedance; cable capacitance not critical; stylus force 3 grs. Vertical tracking angle  $15^\circ$ .....\$24.00

### Model 481 "Calibration Standard" Cartridges

Frequency response 20-10,000 cps  $\pm 1$  db, 10,000-20,000 cps  $\pm 2$  db; channel

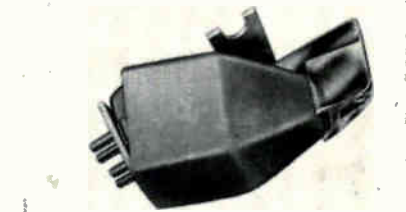

separation 35 db; magnetic ("Fluxvalve") design.

Model 481EL Elliptical stylus—for high-quality manual turntable & automatic changers. Output 1 mv./cm. of recorded level; 47kohm load; cable capacitance 250 pf.; tracking force  $\frac{1}{4}$  to 3 grs.....\$49.50  
 Model 481EL Ensemble—same as 481EL but includes 2 additional "V-Guard" styli, 1 mil for LP's & 2.7 mil for 78 rpm...\$60.00  
 Model 481AA for use with ultra-lightweight arms capable of tracking within  $\frac{1}{4}$  to 3 grams; output .5 mv./cm. of recorded level; "V-Guard" diamond stylus .....\$49.50

Model 481A for use with mono tonearms; tracking force 2 to 5 grams; output .8 mv./cm. of recorded level.....\$48.00  
 Model 481E same as Model 481A but includes two additional "V-Guard" styli, 1-mil diamond for LP's and 2.7-mil diamond for 78's.....\$60.00

## WEATHERS

### C-66 Cartridges

Stress-generator design; 20-20,000 cps  $\pm 2$  db; tracks 1.5 gram; output 5 mv.; chan-

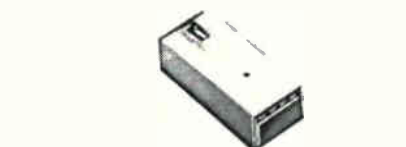

nel separation 35 db; 0.7-mil diamond stylus; 0.3 milligram tip mass; compliance more than  $30 \times 10^{-6}$  cm./dyne @  $\frac{1}{4}$ -gram tracking force,  $15 \times 10^{-6}$  cm./dyne @ 1.2-gram tracking force; matching networks (included) to low-level magnetic input .....\$22.50

# 2 Tonearms

## ADC

### "Pritchard" Tonearm

Has removable plug-in head; walnut wood arm; adjustable rear counterweight; side-



thrust compensator; over-all arm length 10 3/8"; pivot to stylus tip 9"; tracking force 3/4 gram; will accommodate standard cartridges .....\$44.50

## COMPONENTS CORP.

### Model AS Auto-Set Tonearm Kit

Pivot bearing design and precise balance of cartridge eliminates vertical bounce;



spring adjustment of stylus force; continuous adjustment of tracking angle while record is playing; especially for stereo use .....\$9.50

## DYNACO

### Models TA-12 & TA-16 Tonearms

Both tonearms are manufactured by B & O and designed for use with a Stereodyne II



plug-in cartridge having different mounting assembly; has dynamic balance vertically and horizontally enabling constant groove contact; stylus force adjustment to fractions of gram; single hole mounting; combination of low inertial mass and a gyro mount.

TA-12 (12 inch).....\$39.95  
 TA-16 (16 inch professional).....\$49.95  
 TSD-30 3.0 mil diamond cartridge for 78's (separate).....\$19.95  
 TSD-05 (.5 mil diamond cartridge).....\$19.95  
 TSD-07 (.7 mil diamond cartridge).....\$19.95

## EMI

### Model A "Castagna" Tonearm

Features sapphire bearings in both vertical & horizontal gimbals and opposing mag-



nets in post portion of arm. Magnets suspend the weight of arm & cartridge. Has adjustable 8° to 28° tracking angle; stylus pressure gauge (0 to 5 grs.); removable cartridge mounting plate & 5 wire plug-in audio cable.....\$125.00

## EMPIRE

### Model 980 Stereo Balance Arm

Counterbalanced arm allows adjustment for any cartridge from 2-25 grams; stylus



force adjustment 0-8 grams; arm offset at 23.8°; resonant frequency 6 cps; over-all length 12 3/8"; maximum tracking error ± .65°; includes "Dyna-Lift" device which automatically lifts arm from record at end of play; satin gold or satin chrome finish. ....\$50.00

### Model 98DL "Dyna-Lift"

Separate attachment for previous Model 98 tonearms; mechanical device automatically lifts arm from groove at end of record play; action is triggered magnetically.....\$10.00

## GRADO

### "Laboratory Series" Tonearm

Gun-stock walnut wood construction; for 12" records; tracking error ± .5°; low-



frequency resonance 11 cps; minimum tracking force 1/2 gram; has interchangeable cartridge slides and both vertical and lateral balance adjustments.....\$45.00  
 Extra cartridge slide.....\$2.95  
 With Mk I cartridge.....\$115.00  
 With Mk II cartridge.....\$ 90.00  
 With Mk III cartridge.....\$ 80.00  
 With Mk IV cartridge.....\$ 70.00

## GRAY

### Model 208-S "Professional" Tonearm

A viscous-damped design with a slide & modular weights for mounting single-play



stereo or mono cartridges; arm response ± 1 db from 5 cps to upper limit of cartridge; tracking error from 0° at 2.5" radius to 1° 15' at 5.5" radius; resonance vertical & lateral 6 cps; 15" long x 2 15/16" wide .....\$49.50  
 Model 208-S/G is supplied with special head to mount turnaround G-E broadcast cartridge .....\$49.50

### Model 212-TN Tonearm

Viscous damped with slide-in type cartridge assembly for 12" stereo or mono records; vertical resonance 20 cps; hori-

zontal resonance 10 cps at 4 grams, tracking force per 5 x 10<sup>-8</sup> cm./dyne compliance tracking error 1 deg., 28 min. @ 3.75" and 2 deg. 0 min. @ 5.5" radius. Model 212-TN aluminum finish with black trim.....\$35.50  
 Model 212-TG same as Model 212-TN but with grey finish.....\$32.50

## ORTOFON

### Model RMG-212 Stereo Arm

Counterweight is separated from tube by rubber damper to eliminate resonances;



attached to counterweight is adjustable stylus pressure gauge adjustable for 0-7 grams; arm resonance 8 cps; maximum tracking error 1.19°; arm length 12" overall; plug-in head designed for use with any cartridge; employs ball-bearing gimbal suspension .....\$55.00

### Model RMG-212T Stereo Arm

Same as Model RMG-212 except includes pre-drilled tonearm mounting board for Thorens Model TD-124 or TD-121 turntables .....\$60.00

### Model RMG-309 Stereo Arm

Professional 16" stereo arm; tracks at 2 grams with plug-in Ortofon stereo car-

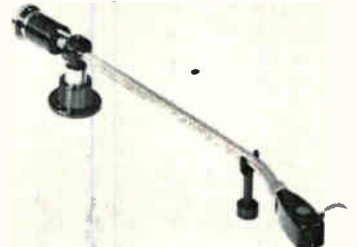

tridge; plug-in shells available to fit standard U. S. stereo cartridges; statically balanced by counterweight with spring-controlled stylus force (no table leveling required); micrometer stylus force adjustment reads directly in grams; adjustable height over mounting plate; rubber damping between arm and counterweight; approx. dimensions 12 3/4" pivot to record center 3" radius rear clearance.....\$60.00

### Model SMG-212 Stereo Arm

12" stereo arm; takes Ortofon or any standard stereo cartridge; tracks at 2 grams; special arm shape makes turntable leveling unnecessary; turntable may be up to 30 degrees out of level before tracking difficulties arise; ball bearings on both horizontal and vertical pivots; adjustable height above mounting plate; unique counterweight adjustment can be calibrated by user for any cartridge to read stylus force directly in grams; approx. dimensions 8 3/8" pivot to record center, 3 1/4" rear clearance radius (max. for heaviest cartridges) .....\$30.00

### Model SKG-212 Stereo Arm

12" stereo arm; takes Ortofon or standard stereo cartridges; adjustable user-calibrated counterweight shows stylus force directly in grams; dimensions same as for Model SMG-212 .....\$20.00

# 2 Tonearms

## REK-O-KUT

### Model S-320 Tonearm

Plugs into amp with permanently attached cable; has "Micropoise" dynamic balance,

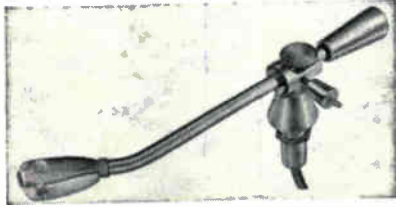

spring-cushioned; calibrated from 0-6 grams; isolated counterweight; includes aluminum 4-wire plug-in shell with cartridge adjustment slide; collar locks shell into arm; single hole mounting; features "Omni-Balance" for optimum bearing loads and lateral balance.....\$34.95

### Model S-340 Tonearm

A modified version of the S-320 tonearm. Tracks at less than 1 gr. Resonance factor is below 12 cps. Removable cartridge shell handles any standard cartridge. Does not have "Micropoise" dynamic balance..\$24.95

### Model S-260 Tonearm

Same as S-320 for 16" table (less "Omni-Balance") .....\$36.95

## SHURE

### Model Shure-SME 3009/Tonearm

Made in England; tracking force ¼ to 6 grams; anti-skating control; precision ball

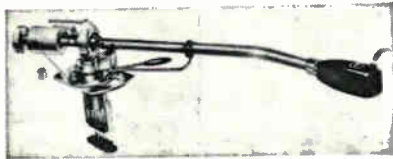

races and knife edge bearings; accurate longitudinal and lateral balance control; minimal tracking error; subaudible resonance; convenient overhang adjustment; lever-operated cueing device; accepts all standard cartridges; 12" version; less cartridge .....\$92.50  
Model Shure-SME 3012 for 16" records....\$102.50

### Model M222/M226 "Studio Dynetic" Arm & Stereo Cartridge

Response 20-20,000 cps  $\pm 2\frac{1}{2}$  db; channel separation better than 20 db at 1000



cps; output voltage 4.5 mv. per channel at 1000 cps; tracking force ¾ to 1½ grams; vertical and lateral compliance  $22 \times 10^{-8}$  cm./dyne; includes M22 stereo cartridge and user-replaceable .0005" dia-

mond stylus .....\$89.50  
Model M226 with 16" arm.....\$89.50

### Models M232 & M236 Tonearm

Accepts all cartridges (mono or stereo); micrometer counterweight; direct-reading



stylus force gauge; slide adjustment for stylus overhang; arm height adjustable; stylus tracking force adjustable 1-8 grams; for 12" records.....\$29.95  
Model M236 for 16" records.....\$31.95

## SONOTONE

### Model T1 Tonearm & Crystal Stereo Cartridge

Economy unit; all plastic manual tonearm; available with compression rear

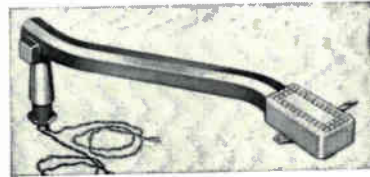

mounting post; tracking force 9-11 grams; includes Model 12 crystal cartridge..\$7.45

### Slim Tonearm & Crystal Stereo/Mono Cartridges

Manual prewired ready to use; spring mounting post; shielded cable; packaged with installation hardware.

Stereo Model T20T1.....\$4.50  
Stereo Model T20T2-S.....\$4.50  
Mono Model T14T-S.....\$3.50

## STANTON

### Model 200 "Unipoise" Tonearm



Ultra-lightweight design for tracking pressure of ¼ gram; simple adjustments balance arm in all planes; has calibrated (0-3 gram) stylus force adjustment; over-all weight with base and pivot assembly 6 oz.; for 12" records.....\$24.00

## THORENS

### Model BTD-12S Tonearm

For 12" records; has exclusive cueing control for lowering and raising arm from turntable; maximum tracking error .5°/inch; offset angle of arm 25° 15'; adjustable counterweight plus built-in calibrated stylus force adjustment (0-8 grams);

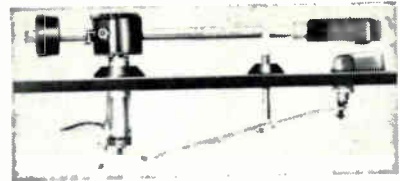

separate cartridge shell and slide assembly for proper spacing of stylus; supplied with mounting board for Thorens TD-124 & TD-121 turntables.....\$40.00

## WEATHERS

### PS-11 Stereo Pick-up System

"Professional" design for use on any high-quality turntable; 20-20,000 cps  $\pm 1$  db;



10-40,000 cps  $\pm 3$  db; compliance  $20 \times 10^{-8}$  cm./dyne; moving mass 0.6 milligram; 40-35 db separation (20-15,000 cps); recommended tracking force ¾-1 gram; output 1 v. with RIAA equalization, 8 mv. @ constant velocity; system includes matched transistorized preamp unit (2¼" h. x 3" w. x 5¼" l.); 0.5-mil diamond stylus; non-resonant bass wood arm (10" from pivot to front, 3" from pivot to rear); statically balanced; full-time vertical & lateral light viscous-damping action.....\$129.50  
Model PS-11-K Same as PS-11 but without tonearm.....\$91.00

### MT-66 Universal Tonearm

Interchangeable plug-in head accepts any make cartridge; mounts on any turntable;



designed for cartridges capable of tracking under 3 grams; full-time lateral & vertical viscous damping; micrometer tracking force adjustment; no skating; no spring biasing; walnut wood finish; 11½" long; rubber tonearm rest included.....\$31.50  
P-1010 plug-in cartridge shell for use with MT-66 tonearm.....\$2.95  
P-675 stylus gauge.....\$2.00  
P-684 3-concentric-ring record cushion; supports 7", 10", 12" records; rubber; black or brown.....\$3.95

**ALWAYS . . . . .**

**take along your copy of this Directory when shopping for hi-fi components. It is a comprehensive reference to technical details and prices.**



# 2 Phono Accessories

## GARRARD

**Model SPG3 Stylus Pressure Gauge**  
Stylus pressure gauge; large, legible scale; complete with 5 gram weight to be used

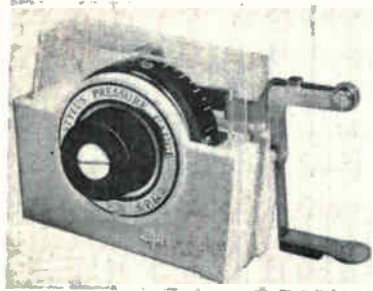

as standard to "zero" unit for complete accuracy .....\$2.95

## GENERAL ELECTRIC

**Model UPX-003C Phono Preamplifier**  
Self-powered converter to convert magnetic cartridges and microphone inputs to tape

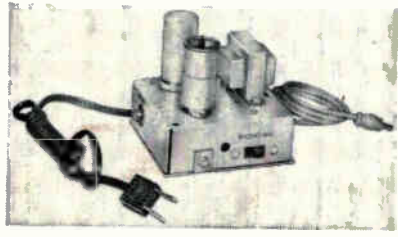

recorders and auxiliary inputs of amplifiers; switch provides proper equalization for mic. and phono; gain 33 db @ 1000 cps; response flat 30 to beyond 15,000 cps. Over-all size 3 3/8" w. x 3 3/8" l. x 3 3/8" h. ....\$14.95

## GRADO

**"Dustat" Record Cleaner**

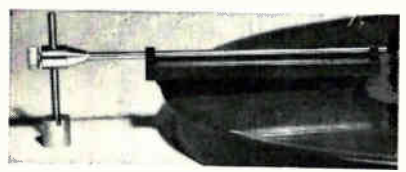

Reduces electrostatic charge and removes dirt from records while playing; contains no radioactive materials.....\$6.95

## LAFAYETTE

**99-1011 Stylus Pressure Gauge**  
Returns with pickup in normal play position;



range 0-30 grams; no spring and minimum of moving parts.....\$0.99

**99-1031 Tonarm Control**  
Lowers tonearm into run-in groove and lifts arm off record at end of play; ideal for cueing; will fit most turntable arms as well as changers with manual features ..... \$1.95

1965 EDITION

## NUCLEAR

**Model 3R500 "Staticmaster"**



Polonium treated jaguar hair brush. Designed to eliminate static and dust from records .....\$14.95

**Model 2U500 w/BFI Positioner**  
Flexible arm with heavy base holds model 2U500 ionizing unit over playing record.



Is supplied complete with ionizing unit .....\$19.75

## ROBINS

**"Disk-Whisk" Kit**

Automatic record cleaner clips to tonearm; has floating nylon brush & mohair cylinder. Anti-static liquid cleans and lubricates. Comes complete with cleaner, liquid, and instructions.....\$2.40

## SHURE

**Model M-61 Stereo Preamp**

Transistorized unit with choice of a.c. line or battery power supply; slide-selector switch provides choice of three equalization inputs: phono, RIAA equalization for conversion of ceramic to magnet input; tape, NAB equalization; and flat amplification for microphone use; gain: 45 db phono, 40 db tape, 63 db microphone. Model M61-1 (for 105-125 v. operation) .....\$27.50  
Model M61-3 (for 30 v. battery, in-



cluded) .....\$26.50

**Model M-60 Stereo Preamp**

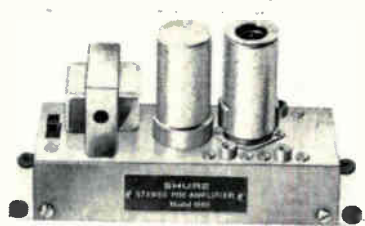

Permits turntable location up to 50 feet from preamplifier; gain 17 db; frequency response 30-80,000 cps  $\pm 1$  db; input impedance 47,000 ohms; output impedance 5000 ohms; hum and noise level better than 64 db below rated output; channel separation better than 30 db; channel balance  $\pm 1$  db; 1-ECC83 (dual function); selenium rectifier.....\$19.95

**Model M65 Conversion Preamp**

Provides equalization with amplification for converting ceramic cartridges to magnetic inputs; 60 db of amplification without equalization; provides preamplification

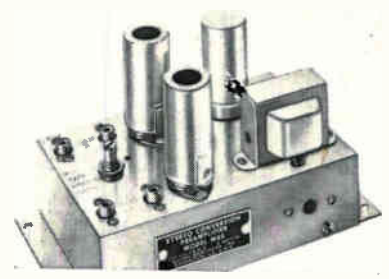

and equalization functions for phono, tape, microphone; gain (phono) 44 db, (special) 45 db, (tape) 40 db, (mic.) 63 db; input impedance 47,000 ohms; output impedance 5000 ohms.....\$24.00

## SWITCHCRAFT

**Transistorized Amplifier**

Miniature size; 9 v. battery operated; "hi-lo" impedance switch: "hi" position 200,000 ohm input impedance & 6 db gain; "lo" position 5000 ohm impedance & 25 db gain; output is high impedance; approx. size of package of cigarettes. Model 501 with 2-conductor phono input jack and 2-conductor output plug.....\$20.00

**Model 328A Audio Equalizer**

Adapts ceramic phono cartridge to the magnetic phono input of any amplifier;



converts signal from ceramic cartridge to a velocity response precisely fitted for RIAA equalization; one needed for mono, two for stereo.....\$1.77

**Color-Coded Phono Plugs**

Low-cost, two-conductor phono plugs with cable clamp and color-coded plastic "snap-on" handles for identification of stereo, hi-fi leads. Model 3508-1 red handle; 3508-2 black handle; 3508-5 white handle.....\$0.15

**Model 306TR Stereo/Mono Mixer**

All-transistorized (9 v. battery) 4-channel high-impedance mixer for microphones, tuners, phonos, etc.; individual gain controls; single mono output for feeding recorder or amplifier; for stereo operation 2 inputs are used per channel; response 20-20,000 cps; gain 6 db.....\$37.50

**Model 301TR Mono Mixer**

Similar to Model 306TR except for mono operation only.....\$30.00

**Model 301 Mono Mixer**

Similar to Model 301TR except does not have transistorized amplifier.....\$19.50

**Model 306 Stereo/Mono Mixer**

Similar to Model 306TR except does not have transistorized amplifier.....\$22.50

# Should Sherwood's new solid-state amplifier be rated at 150 watts? ... 300 watts? ... or 100 watts?

Audio power *should* be one of your major criteria of amplifier performance. The important thing is to use the same yardstick of comparison.

Among responsible component manufacturers, the commonly-accepted expression of audio power today is "MUSIC POWER"—the amplifier's output capability across the full spectrum of orchestral sound.

If you simply like to play with bigger numbers, multiply MUSIC POWER by two (the way some manufacturers do) and you get "PEAK POWER". It's exactly the same rating but it *looks* twice as powerful.

But the really important measurement is "CONTINUOUS SINE-WAVE POWER" with both channels operating simultaneously. This is the *meaningful* measurement, used in laboratory work. It separates the wheat from the chaff.

*Sherwood's new S-9000 delivers 150 watts of MUSIC POWER ... 300 watts of PEAK POWER ... and 100 watts of CONTINUOUS SINE-WAVE POWER at less than 1/2% harmonic distortion. (At normal levels, distortion never exceeds 0.15%).*

Unequaled power—by *any* standard—is just one of the important engineering advances built into the new Sherwood solid-state amplifiers. Here are some more:

*Military-type Silicon Transistors.* Used exclusively throughout Sherwood circuitry. Twice the heat-reliability of ordinary germanium transistors. Safe for even the most confined custom installations.

*Exclusive transistor short-circuit protection.* (Pat. Pend.) New system virtually eliminates transistor failure or fuse replacement due to shorted speaker terminals or other improper operation.

*Additional features:* Phono input noise less than -65db., with no microphonics or hum / Professional Baxandall tone controls / Tape monitoring and tape-head playback facilities / Stereo headphone jack with speaker disabling switch / Glass epoxy circuit boards / Compact size—14" x 4" x 12 1/2" deep.



Wait till you hear Sherwood's new Tanglewood 4-way speaker system! Each six-speaker system handles 75 watts of program material. Unique design of dual, 10" uniflex woofers achieves unprecedented 34-cycle closed-box resonance. Overall response: 29-17,500 cps  $\pm$  2 1/2 db. \$219.50

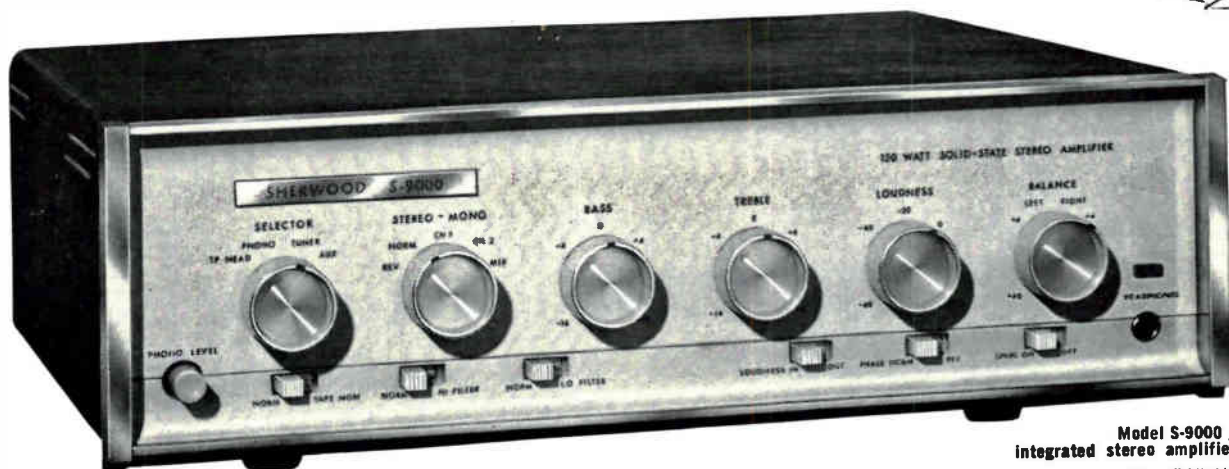

Model S-9000 / solid-state, integrated stereo amplifier / \$299.50  
Prices slightly higher in Far West

For complete specifications and new catalog, write Dept. E-65.

*Sherwood*

HIGH FIDELITY

SHERWOOD ELECTRONIC LABORATORIES, INC., 4300 NORTH CALIFORNIA AVENUE, CHICAGO, ILLINOIS 60618  
CIRCLE NO. 54 ON READER SERVICE CARD

STEREO/HI-FI DIRECTORY

# TUNERS & RECEIVERS



RECEIVERS ..... 51  
 TUNERS ..... 56  
 MULTIPLEX ADAPTERS ..... 69  
 FM ANTENNAS ..... 70

## ALTEC LANSING

### "Astro" AM-FM Stereo Receiver

Combines an AM & FM tuner with FM multiplex circuitry and dual-channel am-

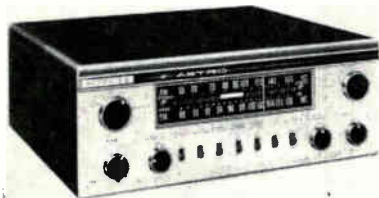

plifier system; power output 27.5 watts/channel; response 20-20,000 cps  $\pm 1$  db; FM sensitivity 2.9  $\mu$ v.; automatic indicator light for stereo; combines tubes and transistors for total of 34; controls: input selector switch for tape head, phono, tape, FM or AM, mode switch for mono or stereo plus selector for speaker or headphones, volume/on-off, balance, loudness, tape monitor, channel reverse, phase reverse, rumble filter, a.f.c., AM bandwidth, bass & treble tone controls; over-all size 5½" x 15" x 14¼"; supplied complete with cabinet .....\$597.00

## BELL

### Model 2445-S2 Stereo Receiver

Combines AM tuner with separate FM stereo tuner, dual preamps & dual 22 w./

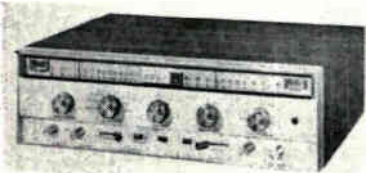

ch. (music power) power amps; features switched a.f.c., individual tuning meters, and stereo indicator light; response 20-20,000 cps  $\pm 1$  db; HD less than 1% @ 1 kc. and 20 w.; hum & noise 76 db below 22 w.; has all conventional controls & inputs; 4-8-16 ohm outputs; FM tuner sensitivity 1.8  $\mu$ v. for 30 db quieting; selectivity -65 db; dist. below 1% @ 100% modulation; image rejection -65 db; response 20-20,000 cps  $\pm 5$  db; channel separation 28 db @ 1000 cps; 57½" x 17½" x 13¼" d.; with case.....\$319.95  
 Model 2445-S1 Similar to the S2 stereo receiver except for different front-panel styling .....\$309.95

### Model 2425-S2 Stereo Receiver

Similar in many ways to Model 2445-S2

1965 EDITION



in that it has separate AM & FM tuners with FM multiplex & stereo amplifiers; the following are variations: 15 w./ch. music power; response 20-20,000 cps  $\pm 2$  db; dist. less than 2% @ 1 kc. & 12 w. r.m.s.; hum & noise 66 db below 15 w.; has 3 dual inputs (mag. phono, aux., tape amp./monitor) instead of 6; outputs 8 & 16 ohms; FM tuner sensitivity 2.5  $\mu$ v. for 30 db quieting; image rejection -38 db; distortion below 1.5% @ 100% modulation; does not have tuning indicators; 19 tubes instead of 23; with case .....\$269.95  
 Model 2425-S1 Similar to the S2 stereo receiver except for different front-panel styling .....\$259.95

### "Imperial 1000" Transistorized FM Stereo Receiver

25 w./ch. continuous sine-wave; response 9-50,000 cps  $\pm 1$  db, 9-100,000 cps



$\pm 3$  db of full output; inputs: ceramic phono (150 mv. sensitivity), mag. phono (1.5 mv.), aux. .5 v., tape monitor .5 v.; 4-8-16 ohm output; FM tuner sensitivity 1.6  $\mu$ v. for 30 db quieting; dist. less than .5% @ 100% mod.; response 20-15,000 cps  $\pm 2.5$  db; capture ratio 2 db; channel separation 30 db from 20-15,000 cps; image rejection over 65 db; has tuning/stereo indicator meter; all conventional controls; automatic stereo/mono switching; 35 transistors, 18 diodes & 3 nuxistor tubes .....(Zone 1) \$529.95

## BIGG OF CALIFORNIA

### CU-98 AM-FM Stereo Receiver

20 w./ch. continuous sine wave with separate AM & FM circuits. FM sensitivity 1.5  $\mu$ v. for 25 db quieting. Response 10-75,000 cps  $\pm 1$  db. Amplifier response 15-65,000 cps  $\pm 1$  db; hum & noise -90 db; 8 ohm output. Has 4 inputs with high-level sensitivity .3 v. for rated output; 12" d. x 5" h. x 15" .....\$229.00

## BOGEN

### RP60 AM-FM Stereo Receiver

Integrated design including dual-channel amplifiers; 30 watts per channel (IHF

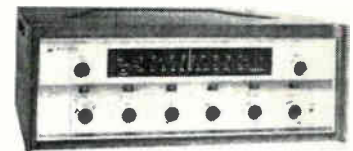

music rating); response 20-20,000 cps  $\pm 1$  db; .6% distortion; hum & noise low-level inputs -60 db. high-level -75 db; FM sensitivity .85  $\mu$ v. for 20 db of quieting (2.5  $\mu$ v. IHF); electronic-eye tuning indicator; stereo headphone output; audio sensitivity low-level inputs 4.5 mv., high-level inputs .5 v.; controls: 6-position selector, 4-position mode, volume, balance, bass, treble, rumble filter, scratch filter, loudness, tape monitor, power, tuning, a.f.c., stereo filter; inputs: magnetic phono, tape aux., tape monitor; multiplex circuit is time-division type with "stereo-minder" indicator, tape recording filter; 20 tubes, 8 crystal diodes, 7 rectifiers; output 4-8-16 ohms with impedance selector; tape output; center-channel: 15½" w. x 5¾" h. x 15" d. ....\$314.95  
 Metal enclosure .....\$ 12.95  
 Walnut cabinet .....\$ 27.95

### RP60 FM-Stereo Receiver

Identical in almost all respects to RP60 but does not include AM tuner circuitry .....\$279.95  
 Metal enclosure .....\$ 12.95  
 Walnut cabinet .....\$ 27.95

### RP100-BM AM-FM Mono Receiver

Integrated design including amplifier; output power 15 watts continuous sine-wave;

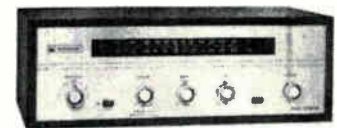

harmonic distortion 2% at rated output response FM & phono 20-20,000 cps  $\pm 1$  db; AM 20-4500 cps  $\pm 1$  db; output impedances 8-16 ohms with tap for line-matching transformers; noise & hum -55 db; FM sensitivity 1.25  $\mu$ v. for 20 db of quieting (3  $\mu$ v. IHF), AM 5  $\mu$ v. for 20 db signal-to-noise ratio; controls: selector with equalization positions, volume, bass, treble, tuning, power, microphone; 13 tubes plus 3 crystal diodes; 15" x 4¾"

# 3 Receivers

x 12 1/2" .....\$186.60  
 Metal enclosure .....\$ 11.95  
 Walnut cabinet .....\$ 26.95

## RP230 AM-FM Stereo Receiver

Combines AM, FM stereo, dual-channel preamps & power amps; 15 w./ch. music pow-

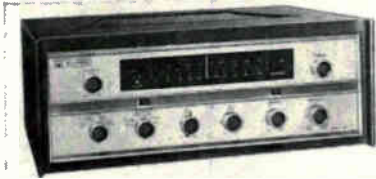

er; response 20-20,000 cps ± 1 db; hum & noise -50 db mag. & tape, -65 db tuner & aux.; FM sensitivity .85 μv. for 20 db of quieting & 3 μv. for 30 db of quieting; has electronic-eye tuning indicator; built-in AM & FM antennas; conventional operating controls & inputs; sensitivity 4.5 m. tape & mag. phono, 5 v. tuner; features time-division type multiplex circuitry & stereo/mono indicator; separation 25 db to 10,000 cps, 20 db @ 10,000 cps & 17 db @ 15,000 cps; 15 1/8" x 5 1/4" x 15" d.; less cabinet .....\$249.95  
 Metal enclosure.....\$ 12.95  
 Walnut cabinet.....\$ 27.95

## RT6000 Transistor FM Receiver

Combines performance of Bogen's Model AT600 amplifier & Model FT60 FM tuner on a single chassis.....\$399.95

## Model RT1000 FM-AM Stereo Receiver

All transistorized with 43 transistors and 22 diodes; 50 w./ch. music power. Has



tuning meter, stereo indicator meter & FM automatic stereo/mono switching. Response 15-45,000 cps ± 1 db; dist. .6% at rated output; hum -80 db; Sensitivity .85 v. for 20 db of quieting; separation 35 db @ 1000 cps; audio sensitivity: mag. phono 3.5 mv., tape head 2 mv., aux. .25 v. Controls: 6-pos. input selector, volume, balance, tuning, bass, treble, loudness, low filter, high filter, tape monitor, mode, phase, a.f.c., power, reverse output. Outputs: 8/16 ohm speakers, tape out, 3rd channel, phones. Inputs: mag phono, tape head, aux., tape monitor. Has tape recorder filter & time-division type multiplex circuitry. 16 3/16" w. x 4 3/8" h. x 15 1/16".....\$549.95  
 Walnut cabinet .....\$ 29.95

## BURSTEIN-APPLEBEE

### Model 300S-5 AM-FM Stereo Receiver

15 w./ch.; response 20-20,000 cps ± 1 db amp., 20-20,000 cps ± .5 db FM tuner, 20-6000 cps ± 3 db AM tuner; separation 30 db; FM sensitivity 2 μv., AM 10 μv. Ten front-panel controls; magic-bar tuning indicator for stereocasts; cabinet size 15" w. x 6 3/4" h. x 13" d.  
 Model 300S-5 without cabinet.....\$179.95  
 Brown metal cover.....\$ 8.95  
 Oiled walnut cabinet.....\$ 14.95

## EICO

### 2536 FM Stereo Receiver

18 w./ch. music power, 14 w./ch. continu-



ous sine wave; 4 pairs inputs, 1 low level (2.3 mv. mag. phono); FM sensitivity 3 μv. for 30 db quieting; stereo sensitivity 3 μv. for synchronization; capture ratio 3 db; HD .6%; channel separation 30 db; amp response 15-40,000 cps ± 1 db; power bandwidth at rated power (1% HD) 30-20,000 cps; IM .2%-1 w., 2%-14 w.; has 8 & 16 ohm outputs; bar-type tuning and stereo program indicator; FM front-end and 4 i.f.'s through to ratio detector are supplied pre-wired & pre-aligned in kit; semi-kit .....\$154.95  
 Factory wired .....\$209.95  
 Metal cover .....\$ 7.50  
 Walnut case .....\$ 19.95

### 2715 FM Mono Receiver

18 w. music power, 14 w. continuous sine wave; 3 inputs, 1 for ceramic/crystal phono

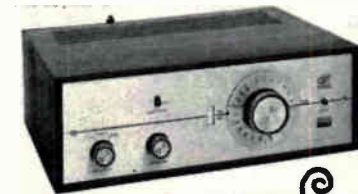

(240 mv. @ 1 megohm); FM sensitivity 3 μv. for 30 db quieting; capture ratio 3 db; HD .6%; power bandwidth at rated power (1% HD) 30-20,000 cps; IM 2%-14 w.; has 8 & 16 ohm & 45 ohm (25 v.) unbalanced outputs; bar-type tuning indicator. Factory wired .....\$129.95  
 Metal cover .....\$ 7.50  
 Walnut case .....\$ 19.95

### 2716 FM Receiver

Includes mono FM tuner & paging amplifier; design identical to Model 2715 but with mic. stages & relay for paging switch at mic. (can be operated by foot switch); features program silencing when paging. Factory wired .....\$149.95  
 Metal cover .....\$ 7.50  
 Walnut case .....\$ 19.95

### Model 3566 FM Stereo Receiver

All-transistor, transformerless design featuring automatic FM stereo/mono switch-



ing. Stereo indicator light, tuning meter, time-switching multiplex circuit; SCA & tape recorder (19 kc.) filters. FM sensitivity 2 μv. for 20 db of quieting. Response 20-15,000 cps; S/N 60 db; capture ratio 4.5 db. Power output 33 w./ch. music power, 30 w./ch. sine wave @ 2% IM, 25 w./ch. sine wave @ 1% IM (all at 8 ohms, -2 db at 16 ohms). HD .16% @ 25 v. & 1000 cps; response 10-60,000 cps ± 1 db; audio sensitivity mag. phono 3 mv. (10 mv. by removing jumper), tape & aux. 18 mv.

Front end supplied prewired and pre-aligned. 16 1/2" w. x 13 1/4" d. x 5" h. Walnut cabinet optional.

Kit .....\$249.95  
 Wired .....\$349.95

## ERIC

### Model 5763 AM-FM Stereo Receiver

Features automatic phase correction & a 2-stage transistorized preamp. Tubes are used for balance of circuit. Has stereo indicator light; local/distance sw.; a.f.c.; tuning indicator. Output 15 w./ch. (30 w./ch.



peak): FM sensitivity 2 μv. for 20 db of quieting; HD 1% at 10 w. (20-20,000 cps). Response: amp. 20-20,000 cps ± 1 db @ 10 w., multiplex 50-15,000 cps ± 1 db; separation 35 db @ 1000 cps; output 8-16 ohms. Input sensitivity: mag. phono low 2 mv., mag. phono high 20 mv., aux. .25 v. 16" w. x 12" d. x 4 1/2".....\$239.95

### Model 5761 AM-FM Stereo Receiver

All-transistor design. Features stereo balance level indicators. Output wattage calibrated indicators; tuning indicator; a.f.c.; power 30 w./ch.; HD less than 1%; response 20-20,000 cps ± 1 db. FM sensitivity 1.5 μv. for 20 db quieting; separation 35 db. Multiplex design—beam switching (coupling) type of modulator. Function selector: mag. phono, AM, FM, FM stereo, Aux. 1, Aux. 2. 5 1/8" x 16" x 14 1/2" d.....\$299.95

### Model 200 FM Mono Receiver

Provided with aux. input jack & front-panel selector sw. to accommodate microphones,



record player, TV sound, etc. Has paging facilities & 4-8-16 ohm output plus high-impedance tap for distant location speakers; a.f.c. 10 w. sine-wave output (20 w. peak). FM sensitivity 3 μv. for 20 db quieting; HD 1% @ 10 w. Amplifier response 20-20,000 cps ± 1 db. 13 1/2" x 4 1/2" x 8 3/8" d.....\$149.95

### "The Palomar" SR-500 FM Receiver

All-transistor FM-stereo design. Has tuning meter, hi & low cut filters. Controls: tuning, function, loudness, balance, bass, treble, on/off, mono/stereo sw. a.f.c., hi-cut, low-cut,



normal/reverse. Amplifier: 25 w./ch. sine-wave; response 10-30,000 cps ± 1 db; HD less than 1%; hum & noise 80 db below full output. Tuner section: 2.5 μv. for 30 db quieting; separation 30 db @ 1 kc. Inputs: mag. phono (sensitivity 2 mv.), tape head (2 mv.), tuner & aux. (.125 v.). 4-8-16 ohm outputs. 16" x 4 3/8" x 13" d. Supplied with cabinet.....\$399.00

**FISHER**

**600-T FM Stereo Receiver**

55 w./ch. music power at .5% HD. Has



novistor tube front-end with balance of circuit transistorized; automatic stereo/mono switching; tuning meter. FM sensitivity 1.8  $\mu$ v. for 30 db of quieting; S/N ratio 70 db (100% mod.); capture ratio 2 db; separation 40 db. Amplifier IM dist. .5% at rated output; power bandwidth 12-35,000 cps; hum & noise -90 db; input sensitivity: phono low 380 mv., phono high 5.5 mv., tape head 1.8 mv., aux. low 210 mv., aux. high 380 mv., tape monitor 800 mv. Features tape monitor, speaker selector sw. 16 1/4" w. x 5 1/8" h. x 11 1/2" d. Less cabinet .....\$595.00

**Model 400 FM Stereo Receiver**

32 1/2 w./ch. music-power control amplifier with multiplex circuitry & "Stereo Beam"



—a stereo/mono indicator light; sensitivity 1.8  $\mu$ v. for 30 db of quieting & 100% mod.; signal-to-noise ratio 70 db; selectivity (alternate channel) 60 db; image rejection 57 db at 100 mc.; HD less than .5%; separation 35 db @ 1000 cps; amplifier IM dist. .8% @ 26 w./ch.; over-all response 25-25,000 cps  $\pm$  1 db; input sensitivity for 12.5 w./ch.: phono low 4.4 mv., phono high 14 mv., tape head 2.8 mv., aux. 280 mv.; has conventional controls, input, output & tuning meter; 17 1/2" x 5 3/4" x 13" d.; less cabinet .....\$329.50

**Model 500C FM Stereo Receiver**

37.5 w./ch. music-power control amplifier with multiplex circuitry & "Stereo Beacon"



(indicates stereo/mono program & automatically switches to stereo or mono operation); sensitivity 1.8  $\mu$ v. for 30 db of quieting; signal-to-noise ratio 70 db; selectivity (alternate channel) 60 db; HD .5%; amplifier IM dist. .7% @ 17.5 w.; over-all response 25-25,000 cps  $\pm$  1.5 db; channel separation @ 1 kc. 50 db; input sensitivity for rated output: phono 3.3 mv., tape head 2.5 mv., aux. 230 mv.; employs time-division multiplex circuitry; has conventional operating controls, inputs & outputs; 17 1/2" x 5 3/4" x 13 1/2" d.; less cabinet.....\$389.50

**Model 800C AM-FM Stereo Receiver**

Similar to Model 500C but with addition of AM tuner; less cabinet.....\$449.50

**HARMAN-KARDON**

**Model FA-10 "Sonata" Receiver**

Combination FM tuner and 10 watt am-

plifier; tuner has Armstrong circuit with limiter and wide-band discriminator, a.f.c., cascade r.f. section; sensitivity: 2.5  $\mu$ v. for 20 db quieting; selectivity. 200 kc. bandwidth, 6 db down; drift  $\pm$  5 kc. maximum; image rejection: 40 db; i.f. rejection: 70 db; distortion less than 1% harmonic and IM standard 75 microsecond de-emphasis 60 db below 100% modulation; radiation within FCC requirements; amplifier frequency response 45 to 20,000 cps  $\pm$  1 db at 10 watts; less than 1% harmonic and less than 2% IM distortion at 10 watts; hum on phono input 60 db below 10 watts; bass and treble controls allow 12 db boost or cut at 50 and 10,000 cps; damping factor: 5; phono input sensitivity 4 millivolts at 1 kc.; 3-position loudness contour; RIAA record equalization, NAB tape equalization for 7 1/2 ips; inputs are phono, tape head, and aux.; tape output; output impedances 8 and 16 ohms; one convenience a.c. receptacle.

.....\$129.95

**HEATH**

**AR-13 Transistor AM-FM Receiver**

Features stereo circuitry; 43 transistors, 16 diodes; automatic FM-stereo switching;

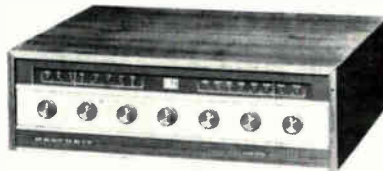

stereo indicator light; 3 stereo inputs (mag. phono, 2 aux.); 2 filtered tape recorder outputs; tuning meter (for AM & FM); local/distant sw.; phase adjust. sw.; SCA filter sw.; noise filter sw.; a.f.c. sw. Supplied with pre-assembled FM front-end & a 3-stage AM-FM i.f. strip. Power/ch. 20 w. @ 8 ohms, 13.5 w. @ 16 ohms, 9 w. @ 4 ohms (Heath rating). Music power output 33 w. @ 8 ohms, 18 w. @ 16 ohms, 16 w. @ 4 ohms (all at .7% HD @ 1 kc.). Power response 10-60,000 cps  $\pm$  3 db @ rated output. HD less than .3% @ 1 kc. IM dist. less than 1% (both at rated output). Separation 60 db @ 1 kc.; input sensitivity (20 w./ch./8 ohm): mag. phono 6 mv., aux. .25 v.; 4-8,16 ohm outputs; FM tuner response 20-15,000 cps  $\pm$  3 db; capture ratio 10 db; sensitivity 3 1/2  $\mu$ v. for 30 db of quieting; 17" l. x 5 3/4" h. x 14 3/4" d. Kit.....\$195.00

**KENWOOD**

**KT-10 AM-FM Stereo Receiver**

All-transistor; automatic FM stereo/mono switching; SCA noise filter; tuning meter;



42 transistors & 22 diodes: a.f.c.; low filter; high filter; 20 w./ch. music power. FM sensitivity 1.9  $\mu$ v. for 20 db quieting; response 20-20,000 cps  $\pm$  1/2 db; separation more than 35 db @ 400 cps; HD less than 1%; audio sensitivity: mag. phono & tape head 1.5 mv., xtal phono 20 mv., aux. & tape play 100 mv.; 17 1/4" w. x 14" d. x 5 1/2" h.....\$299.95

**KW-55 AM-FM Stereo Receiver**

Features FM stereo indicator; a.f.c.; low & high filters; SCA filter; 20 w./ch. music power. FM sensitivity 1.9  $\mu$ v. for 20 db quieting; separation more than 38 db @ 400 cps; HD less than 1%. Audio sensitiv-



ity: mag. phono, tape head 1.5 mv.; xtal phono 15 mv.; aux. & tape play 100 mv. 17 3/4" w. x 14" d. x 5 1/4" h.....\$239.95

**KW-33 AM-FM Stereo Receiver**

Similar in most respects to Model KW-55. 14 w./ch.; separation 31 db @ 400 cps. Does not have tape head or tape play inputs. Has 2-position mode sw. instead of 5-position .....\$189.95

**KLH**

**Model Eight A FM Receiver**

Complete FM receiving system; fully transistorized. Housed in two walnut cabinets 8 7/8" w. x 4" h. x 5 1/2" d. (tuner/amplifier) and 8 7/8" w. x 6" h. x 6 3/4" d. (speaker); interconnected by 30 ft. cable. Tuner/amp features vernier planetary tuning dial, built-in antenna, zero-center tuning meter, and special i.f. transformers. Controls: power on/off, treble and volume. Tuner output for use with mono tape recorder or other equipment and for external 300-ohm antenna. Unit cannot be used to feed multiplex adapter; speaker: high-compliance 3" driver in sealed enclosure; cannot be used with other amplifiers; walnut.....\$119.95

**KNIGHT**

**KN-345 AM-FM Stereo Receiver**

22 w./ch. music power. Features: a.f.c., automatic FM stereo/mono switching; stereo inputs for mag. phono; tape head, aux.; outputs for speakers, headphone, tape recorder. FM sensitivity 2  $\mu$ v. for 20 db quieting; over-all response 30-19,000 cps  $\pm$  1 db; hum & noise -72 db (aux.); 4-8-16 ohm impedance; separation 30 db. 4 1/2" x 16 1/8" x 15 1/2"; less cabinet \$199.95

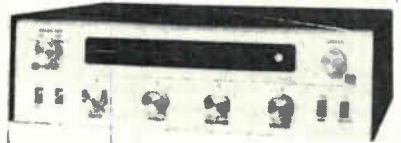

Walnut wood cabinet.....\$ 19.95  
Brown metal cabinet.....\$ 8.95

**KN-330 AM-FM Stereo Receiver**

7 1/2 w./ch. music power. Features automatic FM stereo/mono switching; stereo indicator



light & stereo inputs for phono & aux. FM sensitivity 2  $\mu$ v. for 20 db of quieting. Over-all response 100-12,000 cps  $\pm$  1 db; hum & noise -65 db (for aux.); outputs 8 or 16 ohms; separation 30 db. 4 3/8" x 14 1/2" x 13 1/2". less cabinet.....\$159.95  
Walnut wood case.....\$ 16.95  
Brown metal cabinet.....\$ 6.95

**KN-370 AM-FM Stereo Receiver**

35 w./ch. music power; 20 tubes. 8 diodes & 7 rectifiers; response 20-20,000 cps  $\pm$  1 db; hum & noise down 75 db on tuner & amplifier; down 60 db on magnetic & tape; a.f.c.; stereo phono jack; stereo indicator light; controls: program selector, mode se-

# 3 Receivers

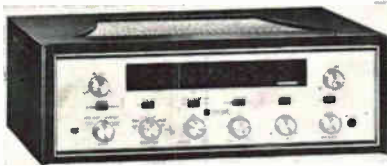

lector, volume, balance, bass-treble, low filter, high filter, loudness, tape monitor, output selector, on-off tuning; less case; 5 1/4" x 15 1/8" x 15".....\$279.95  
Walnut case.....\$ 23.95  
Metal case.....\$ 12.95

## KNIGHT-KIT

### KU-45A AM-FM Stereo Receiver

All-in-one unit consisting of AM-FM multiplex tuner and 32-watt stereo ampli-

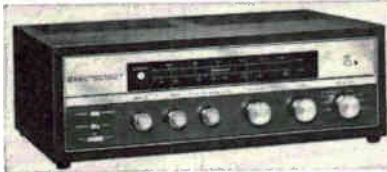

fier; a.f.c.; pre-aligned front end; separate bass and treble controls; tape head input; two aux. inputs; magnetic phono input; stereo/mono switch; sine-wave power output 16 w./ch.; output 4-8-16 ohms, plus 8-16 ohm center-channel output; satin gold and mocha panel; 4 3/4" x 16 1/2" x 13"; less case.  
83YU752 KU-45A Kit.....\$139.95  
83YX021 Wood case.....\$ 14.95  
83YX646 Metal case.....\$ 4.95

## LAFAYETTE

### LR-800 AM-FM Stereo Receiver

Features 35 w./ch. music power; nuvistor front end; stereo indicator (audible tone



signal), variable a.f.c. Bar-type tuning indicators. FM sensitivity 1.5  $\mu$ v. for 20 db quieting. Stereo response 50-15,000 cps  $\pm$  1 db; HD less than .5% @ 1 kc. Amplifier hum & noise -8 db (high level), HD 1% at rated output; 8 & 16 ohm output (sw. selected). Controls: bass, treble, balance, rumble & noise filters, loudness, input selector & mode sw. Has phono-tape & aux. inputs. 17" w. x 5 3/8" h. x 14".....\$199.50

### LA-215 AM-FM Stereo Receiver

6 w./ch. music power featuring stereo indicator (audible tone signal); a.f.c.: FM tuner



sensitivity 3  $\mu$ v. for 20 db quieting; stereo response 50-15,000 cps  $\pm$  2 db; HD FM stereo less than 2% @ 400 cps. Audio sen-

sitivity mag. phono 3.5 mv., crystal phono 30 mv. (both for 4.5 w. output). Amp. hum & noise -75 db for high level; 8 & 16 ohm switched. Has multiplex noise filter. Controls: on/off, volume/balance, bass, treble, tuning selector & mode sw., noise filter, speakers on/off. Stereo inputs for mag. & crystal phono & aux. 16 1/2" w. x 5 1/2" h. x 11 1/2" d.....\$109.50

### LA-230 AM-FM Stereo Receiver

Features 12 w./ch. music power, tuning meters, stereo indicator (audible tone sig-



nal), stereo noise filter. FM sensitivity 3  $\mu$ v. for 20 db quieting. FM separation 25 db @ 400 cps; response 20-20,000 cps  $\pm$  2 db. Amplifier hum & noise: low level -55 db, high level -68 db; 8-16 ohm outputs. Controls: variable a.f.c., on/off, volume, bass, treble, selector, loudness, noise filter, spkr. on/off. 17 1/2" w. x 5 1/2" h. x 12 1/4" d.....\$139.50

## McINTOSH

### MX110 FM Stereo Receiver

Combines FM tuner with multiplex circuitry and stereo preamp; tuner sensitivity 2.5  $\mu$ v. @ 100% modulation; response 20-20,000 cps  $\pm$  1/2 db; distortion less than .5% @ 100% modulation; input sensitivity for preamp aux. 2.5 v., phono 1 &

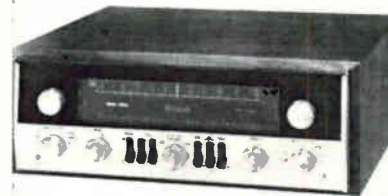

phono 2.5 mv., tape head 2.5 mv., and tape monitor 2.5 v.; preamp response 20-20,000 cps; preamp distortion less than .2% at rated output; hum and noise 80 db below rated output for high-level inputs; operating controls are: input selector, bass & treble tone controls, muting, low- and high-frequency filters, loudness, tape monitor, phasing, tuning, volume, and mode selector.....\$399.00  
Cabinet extra.....\$25.00

## MERRELL

### SR-400 FM Receiver

10 w./ch.; response 20-18,000 cps; tuner sensitivity 1.4  $\mu$ v. for 20 db of quieting;

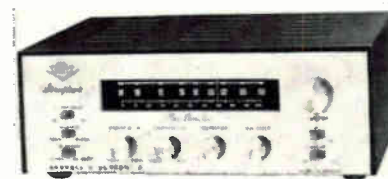

has 10 front-panel controls & separate input for phono.....\$129.95  
Kit.....\$ 69.95  
Case.....\$ 8.95

### SR-436 FM Stereo Receiver

Same as SR-400 except has pre-wired multiplex circuitry.....\$154.95  
Kit.....\$ 89.95

Case.....\$ 8.95

### SR-800 FM-AM Receiver

Same as SR-400 except has AM circuitry with built-in antenna.....\$144.95  
Kit.....\$ 79.95  
Case.....\$ 8.95

### SR-836K FM-AM Stereo Receiver

Same as SR-800 except has pre-wired multiplex circuitry.....\$169.95  
Kit.....\$ 99.95  
Case.....\$ 8.95

## OLSON ELECTRONICS

### Model RA-581 FM Receiver

7 1/2 w./ch.; has magic-bar tuning indicator and a.f.c.; response 50-20,000 cps; output



4.8,16 ohms; 15 3/8" w. x 10 1/2" d. x 5".....\$89.98

## PACO

### ST-26 FM Receiver

Features a.f.c., eye type tuning indicator; phono input & output jack for an external



multiplex adapter; HD 1.5% @ 1 kc.; 4 to 8 ohm output impedance; response 60-15,000 cps  $\pm$  2 db @ 1 w. output; tuner sensitivity 1.5  $\mu$ v. for 20 db of quieting; image ratio 40 db; 13" x 8 3/8" x 3 3/8"; front end pre-aligned; less cabinet; kit.....\$54.95  
Factory wired, less cabinet.....\$69.95  
Metal enclosure.....\$ 4.95  
Walnut enclosure.....\$14.95

## PILOT

### Model 610 FM Stereo Receiver

12 watts per channel (IHF); response 10-30,000 cps  $\pm$  1 db; harmonic distortion 1% (IHF); hum level -80 db; 8-



16 ohms and tape output; input sensitivity: mag. phono 3.5 mv., tape recorder 100 mv.; FM sensitivity 4  $\mu$ v.; capture ratio 8 db; response 20-20,000 cps  $\pm$  1 db; harmonic distortion at 100% modulation 1%; tuning-eye indicator; automatic FM stereo indicator; controls: tuning, balance, separate bass and treble, volume, loudness, tape monitor, mode, selector; 5" x 14 3/4" x 10 3/4"; with cover.....\$199.50

### 602MA11 FM Stereo Receiver

15 watts per channel (IHF); response 10-40,000 cps  $\pm$  1 db; harmonic distortion 1% (IHF); hum level -80 db; 4-8-16 ohms, center-channel, tape outputs;



input sensitivity: mag. phono 12 mv., mag. phono 3 mv. (can be used for tape-head playback), tape recorder 110 mv.; FM sensitivity 3  $\mu$ v.; capture ratio 4 db; response 20-20,000 cps  $\pm$  1 db; harmonic distortion at 100% modulation 1%; tuning-eye indicator; automatic FM stereo indicator; front-panel headphone jack; 5 1/8" x 14 3/8" x 11 1/8"; with cover \$249.50

#### 746 AM-FM Stereo Receiver

30 watts per channel (IHF); response 10-40,000 cps  $\pm$  1 db; harmonic distortion

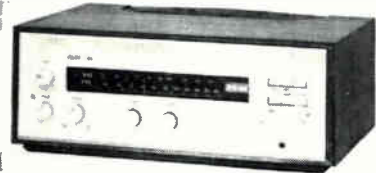

tion 1% (IHF); hum level -80 db; 4-8-16 ohms, center-channel, tape, headphone outputs; input sensitivity: mag. phono 3 mv., mag. phono 12 mv., tape recorder 110 mv., tape head 2 mv.; FM sensitivity 1.8  $\mu$ v.; capture ratio 1 db; response 20-20,000 cps  $\pm$  1 db; harmonic distortion for 100% modulation .2%; AM tuner, 3  $\mu$ v. sensitivity; tuning-meter indicators for AM and FM; automatic FM stereo indicator; 14 separate operating controls; 6 1/4" x 17 3/8" x 13 3/16"; less case \$399.50

#### R-303 AM-FM Stereo Receiver

15 w./ch. music power; response 10-30,000 cps  $\pm$  1 db; HD 1%; hum -80 db; audio sensitivity: mag. phono 3.5 mv., tape rec.



110 mv. Output: 8-16 ohms. Tuner sensitivity 3  $\mu$ v. 30 db quieting; capture ratio 4 db; separation 30 db. Has tuning meters, automatic stereo/mono switching & stereo indicator light. Controls: power/automatic shut-off, spkr. selector, tuning, separate bass & treble, balance, volume, bass compensator, tape monitor, mode, selector; 6" h. x 15 1/16" w. x 12 3/8" .....\$289.50 Oiled walnut cabinet.....\$ 22.50

#### R-707 AM-FM Stereo Receiver

35 w./ch. music power; response 10-30,000 cps; HD 1%; hum -80 db; audio sensi-



tivity: mag. phono 3 mv., tape rec. 150 mv., tape head 2 mv.; output: 4-8-16 ohms. Amplifier is transistorized; tuner sensitivity 3  $\mu$ v. for 30 db quieting; capture ratio 4 db; separation 30 db. Has tuning meters, automatic stereo/mono switching & stereo indicator light. Controls are: power/automatic shut-off, spkr. selector, tuning, separate bass & treble, balance, volume, scratch & rumble filters, loudness, tape monitor, mode, selector. 6" h. x 17 3/16" w. x 14 3/8"

1965 EDITION

.....\$349.50  
Oiled walnut cabinet.....\$ 27.50

#### R-1000 AM-FM Stereo Receiver

55 w./ch. music power; response 10-30,000 cps  $\pm$  2 db; HD 1%; hum -80 db; audio

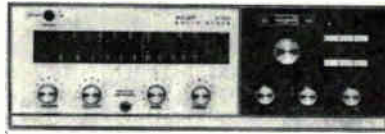

sensitivity: mag. phono 3 mv., mag. phono 12 mv., tape rec. 150 mv., tape head 2 mv.; output: 4-8-16 ohms; amplifier is transistorized. Tuner sensitivity 1.8  $\mu$ v. 30 db quieting; capture ratio 1 db; separation 30 db; has tuning meters, automatic stereo/mono switching & stereo indicator light. Controls are: power/automatic shut-off, speaker selector, tuning, bass, treble, balance, volume, scratch filter, rumble filter, phono input selector; bass compensator, tape monitor, FM muting, stereo/mono, selector & automatic FM stereo/mono; 6 1/8" h. x 17 13/16" w. x 15".....\$449.50 Oiled walnut cabinet.....\$ 34.50

#### RCA

#### MX-7 AM-FM Stereo Receiver

Built-in multiplex circuitry; 15 w./ch. continuous sine-wave (20 w./ch. music pow-



er); features balance control, tuning meter, stereo program indicator; nuvistor FM tuner; surge limiter; tape monitor; local/distance sensitivity switch; a.f.c. switch; dual AM & FM operation; optional remote control; response 30-30,000 cps; HD 1% @ 30 w.; usable sensitivity 2.5  $\mu$ v. for 20 db quieting; FM detector bandwidth 700 kc.; has inputs for phono, tape & aux.; with cabinet .....\$349.50

#### REALISTIC

#### STA-50Y AM-FM Stereo Receiver

FM tuner section—response 20-18,000 cps  $\pm$  2 db; sensitivity 2  $\mu$ v., a.f.c.; sep-

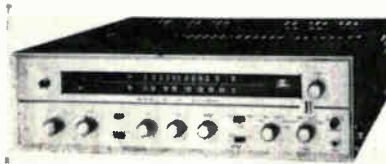

arate i.f. and detection stages; negligible drift with a.f.c.; AM tuner section—tuned r.f. stage, superhet circuit, 3 stages a.v.c., ferrite core antenna; amplifier section—22.5 watts per channel (80 watts mono peaks); response 20-20,000 cps  $\pm$  1 db; distortion .9% total r.m.s. @ 400 cps; IM distortion 1.5% (60/3000 cps 4:1 ratio); sensitivity (at full output) mag. phono 3 mv. @ 1000 cps, tape head 2.2 mv. @ 500 cps, tuner 180 mv. @ 1000 cps; aux. 180 mv. @ 1000 cps, d.c. on all tube filaments; loudness control; 20 tubes.....\$179.95

#### Model STA-7A FM Stereo Receiver

Features built-in multiplex circuitry for stereo reception; tuner section—sensitivity 2.5  $\mu$ v. for 30 db quieting, grounded-grid r.f. stage; ratio detector; amplifier section—12 watts per channel, response 20-20,000

## ASSEMBLE YOUR OWN ALL-TRANSISTOR Schober ELECTRONIC ORGAN



3 NEW MODELS  
Recital \$1500  
Console II \$850  
Spinet \$550

This is the all-new, all-transistor Schober

Recital Model...the most versatile electronic organ available today. Its 32 voices (plus amazing "Library of Stops"), 6 couplers and 5 pitch registers delight professional musicians...make learning easy for beginners. Comparable to ready-built organs selling from \$5000 to \$6000.

The pride and satisfaction of building one of these most pipe-like of electronic organs can now be yours...starting for as low as \$550. The Schober Spinet, only 39 3/4 inches wide, fits into the smallest living room. The new, all-transistor Schober Console II is the aristocrat of "home-size" organs...with two full 61-note manuals, 17 pedals, 22 stops and coupler, 3 pitch registers and authentic theatre voicing.

AND YOU SAVE 50% OR MORE BECAUSE YOU'RE BUYING DIRECTLY FROM THE MANUFACTURER AND PAYING ONLY FOR THE PARTS, NOT COSTLY LABOR.

It's easy to assemble a Schober Organ. No special skills or experience needed. No technical or musical knowledge either. Everything you need is furnished, including the know-how. You supply only simple hand tools and the time.

You can buy the organ section by section...so you needn't spend the whole amount at once.

You can begin playing in an hour, even if you've never played before—with the ingenious Pointer System, available from Schober.

Thousands of men and women—teenagers, too—have already assembled Schober Organs. We're proud to say that many who could afford to buy any organ have chosen Schober because they preferred it musically.

Send for our free Schober Booklet, describing in detail the exciting Schober Organs and optional accessories; it includes a free 7-inch "sampler" record so you can hear before you buy.

### THE Schober Organ CORPORATION

43 West 61st Street, New York, N.Y. 10023

Also available in Canada, Australia, Hong Kong, Mexico, Puerto Rico, and the United Kingdom

THE SCHOBER ORGAN CORP., DEPT. HD-3  
43 West 61st Street, New York, N.Y. 10023

Please send me FREE Schober Booklet and free 7-inch "sampler" record.

Enclosed find \$2.00 for 10-inch quality LP record of Schober Organ music. (\$2.00 refunded with purchase of first kit.)

Name \_\_\_\_\_

Address \_\_\_\_\_

City \_\_\_\_\_ State \_\_\_\_\_ Zip No. \_\_\_\_\_

CIRCLE NO. 52 ON READER SERVICE CARD

# 3 Receivers

cps  $\pm 1$  db, distortion (at full rated output) less than 1% at 400 cps, hum -52 db mag. phono, -72 db aux., sensitivity 850 mv. aux., 4 mv. mag. phono; 14 tubes (11 dual-purpose); output impedances 4, 8, 16 ohms.....\$119.95

## H. H. SCOTT

### Model 345 FM Stereo Receiver

32 w./ch. music power; usable sensitivity (IIF) 2.2  $\mu$ v.; cross-modulation rejection



80 db; S/N ratio 60 db; capture ratio 6 db; separation better than 30 db. 28 w./ch. sine-wave power; HD .8%; Hum and noise -80 db. Front-panel controls: input selector (phono, tape head, extra, FM, and FM subchannel filter); 7-position stereo selector sw.; tone controls; tape monitor sw.; loudness; low-level output speaker sw.; scratch filter; on-off; headphone jack. Has low & high level magnetic phono inputs & center-channel speaker output (will drive 3rd speaker without additional amp).....less than \$365.00

### Model 340B FM Stereo Receiver

Combines FM tuner, multiplex circuitry, dual-channel amplifier system; FM tuner



section same as that used in Model 350D; usable sensitivity 2.2  $\mu$ v., 1  $\mu$ v. for 20 db of quieting; capture ratio 6 db; response 30-15,000 cps  $\pm 1$  db; signal-to-noise ratio 60 db; harmonic distortion .8%; meter-type tuning indicator; subchannel noise filter for multiplex; power amplifier 35 watts per channel (IIF music power); response 20-20,000 cps  $\pm 1$  db; harmonic distortion .8%; preamplifier section has 4 stereo inputs, rumble filter scratch filter, separate bass and treble, tape monitor, subsonic cut-off; loudness control; sensitivity for phono or tape head 3  $\mu$ v.; powered center-channel output for direct connection to loudspeaker; derived center-channel output; front-panel headphone output with speaker/earphone switch; phase reverse; 17 1/2" x 6 1/4" x 16 3/4"; Type "G" case extra; .....less than \$400.00

### 380 AM-FM Stereo Receiver

Same as Model 340B except has additional AM tuner circuitry; less cabinet .....



.....less than \$470.00

## Enclosures

Type "C" metal enclosure.....\$13.95  
Type "C" wood enclosure, walnut or mahogany .....\$24.50  
Type "G" metal enclosure.....\$17.95  
Type "G" enclosure, walnut or mahogany .....\$29.95

## SHERWOOD

### S-8000 IV FM Stereo Receiver

40 w./ch. music power (36 w./ch. sine wave). Features stereo indicator light; source indicator light & interchannel hush. FM sensitivity 1.8  $\mu$ v. for 30 db quieting; capture ratio 2.4 db; separation 40 db; HD .33% (100% mod.). Amplifier response



20-20,000 cps  $\pm 5\%$  at 36 w.; HD .5% @ 36 w. from 20-20,000 cps; IM dist. 1.5% @ 36 w.; hum & noise 75 db below 1 w. output; sensitivity: phono 1.2 mv., aux. .3 v.; damping factor 5; 4, 8, 16 ohm output; inputs: dual-channel phono, tape head, tape monitor, aux. Controls: tuning, loudness, phono gain, bass, treble, stereo balance, hush, on/off, selector, function, tape monitor, phase, lo & hi filter. 16 1/4" w. x 4" h. x 14" .....\$329.50  
Walnut-tone leatherette case.....\$ 9.50  
Walnut wood cabinet.....\$ 29.50

### S-7700 II AM-FM Stereo Receiver

Same as Model S-8000 IV except has additional AM circuitry. Less case.....\$347.50

## STRADFORD

### MXR-388 AM-FM Stereo Receiver

10 w./ch. music power; FM sensitivity 2  $\mu$ v. for 30 db quieting; audio response 15-15,000 cps  $\pm 1$  db; dist. less than 1%; 8 ohm/ch. output; hum 90 db below rated output. Inputs for ceramic or crystal phono cartridge or from output of tape recorder preamp. Over-all size 15 1/2" w. x 7 7/8" h. x 10" .....\$184.50  
Metal case .....\$ 5.00  
Walnut cabinet .....\$ 32.00

### MXR-391 AM-FM Stereo Receiver

15 w./ch. music power. Performance similar to Model MXR-388. Has additional low-level inputs for mag. phono. 12" deep .....\$248.00  
Metal case .....\$ 4.75  
Walnut cabinet .....\$ 31.75

## V-M CORP.

### 1467 AM-FM Stereo Receiver

Combination AM-FM tuner, FM stereo & dual (4 w./ch. music power) audio ampli-

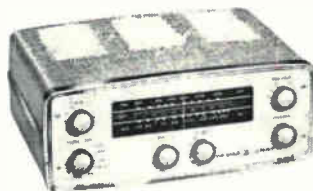

fiers; has tone, balance & loudness controls with stereo indicator light; over-all response 50-20,000 cps; 8 ohms output impedance; sensitivity phono & tape .25 v.; 13 1/2" x 5 3/8" x 12" d. Retail price.....\$179.95

# 3 Tuners

## ALTEC LANSING

### 314A "Emperor Royale" FM Stereo Tuner

Sensitivity 1.2  $\mu$ v. for 20 db of quieting; channel separation 30 db from 50 to 15,000 cps; time-division type multiplex circuitry; supplied with metal cabinet; excise tax included in price.....\$359.00

## BELL

### Model 2419 FM Stereo Tuner

Has stereo/mono indicator, multiplex & storecast filters; sensitivity 3  $\mu$ v. for 30



db quieting; selectivity -6 db @ 240 kc.; dist. less than 1.85% @ 100% modulation; image rejection -55 db; response 20-15,000 cps  $\pm 1$  db; separation 30 db @ 1000 cps; output .5 v. r.m.s.; hum & noise -60 db; 8 tubes; 5 7/8" x 14 1/4" x 10 3/4" d.; with case.....\$149.95

### Model 2441-S1 AM-FM Stereo Tuner

Features twin tuning meters, a.f.c. & multiplex circuitry; FM tuner sensitivity 1.8



$\mu$ v. for 30 db quieting; selectivity -6 db @ 250 kc.; image rejection -65 db; dist. below 1% @ 100% mod.; response 20-20,000 cps  $\pm .5$  db; hum & noise -52 db; AM & FM tuners can be played simultaneously; with case.....\$189.95  
Model 2421-S1 Similar in design & style to 2441-S1 except is economy version; does not include tuning meters; with case .....\$159.95

## BOGEN

### Model TP35 FM Stereo Tuner

Features automatic stereo/mono switching, time-division circuitry & stereo indicator



tuning eye. Usable sensitivity 3  $\mu$ v.; dist. .5%. Response 30-15,000 cps  $\pm .5$  db; hum & noise -60 db; selectivity 220 kc. @ -3 db down; Controls are mono/stereo sw., a.f.c., tuning & power. 15" w. x 11 3/4" d. x 4 3/4" .....\$139.95  
Vinyl-clad metal cabinet.....\$ 14.95



# YOU'VE NEVER HEARD IT SO GOOD!

Announcing another Scott engineering breakthrough . . .  
 the sensational-sounding new Scott 344  
 solid-state tuner / amplifier

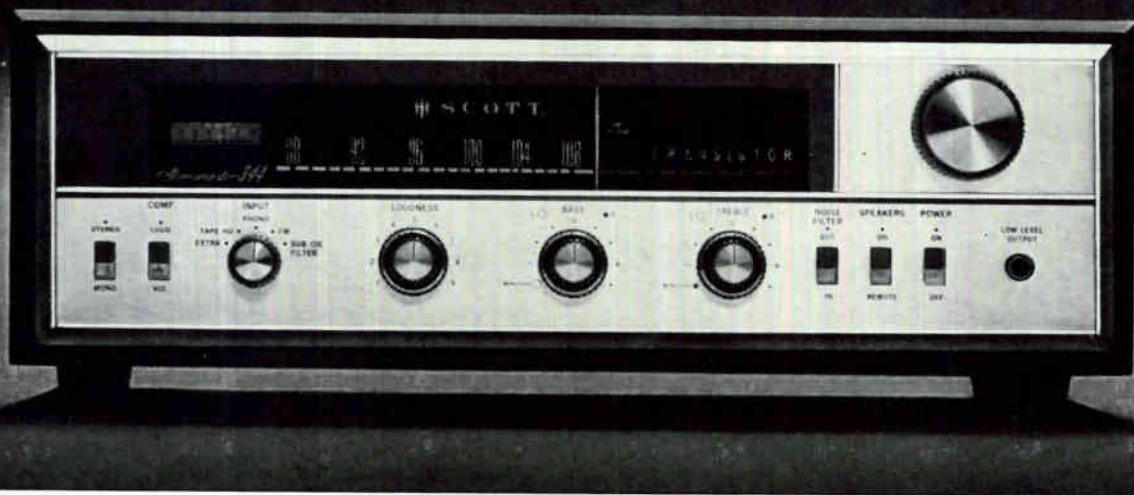

"It's great!", "The sound was fabulous", "I never heard anything like it!" . . . These were the comments of Scott's product evaluation panel, the most critical, exacting, demanding group of audio perfectionists in the industry. The subject of this hard-won praise was the new Scott 344 solid-state tuner/amplifier. Now, Scott confidently invites your own personal evaluation of the 344. See it . . . hear it . . . compare it and decide for yourself if you have ever before experienced sound so clear, so sparkling, so lifelike . . . or if you have ever seen a more handsome unit.

The tuner section is the same as that of Scott's pioneering solid-state 312 FM stereo tuner, of which Audio Magazine (July 1964) said: "It is one of the finest tuners Scott makes. And that means it is one of the finest tuners anywhere." The 344 features Scott silver-plated front end

for maximum sensitivity, all-silicon IF stages for sharpest selectivity, four stages of flat line limiting for the most noise-free FM listening, and Scott-developed Time-Switching series gate multiplex section for the most distinct stereo separation.

The revolutionary amplifier section of this new 344 uses entirely new Scott-developed circuits. These circuits represent significant engineering advances in the state of the art. . . . Peak power capabilities approach one hundred watts, enough to handle the extreme dynamics of any music.

Scott engineers have imaginatively applied space-age miniaturization to achieve a most compact precision instrument. The 344 is as small as an ordinary tuner . . . so it can fit where larger units cannot. Visit your Scott dealer soon . . . but be prepared for a new experience in listening.

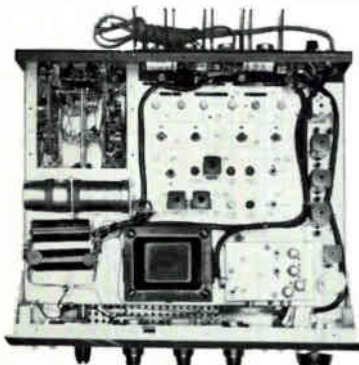

**Tuner Section . . .** Silver-plated, four-nuvistor front end assures high sensitivity with no cross modulation problems. (Audio Magazine reported 2.0 uv IHF sensitivity with 82 db cross modulation rejection!) Flat line limiting makes the 344 virtually impervious to ignition pulse noises and overloading caused by strong local stations. Solid state circuitry assures long trouble-free operation without need for realignment.

**Solid State Amplifier stage . . .** Scott's advanced design gives power to spare for reproducing all the dynamic peaks in the music. Even under high volume conditions the Scott 344 will drive inefficient loudspeakers to full room level. Power rating is a conservative 25 watts per channel. Cool operation and consequent long component life is promoted by efficient heat sinks and Scott's heat-dissipating aluminum chassis. You'll enjoy years of sparkling, transparent transistor sound.

Specifications: FM sensitivity, 2.2 uv; Frequency response, 20-20,000 cps  $\pm$  1 db; Power bandwidth, 25-15,000 cycles at less than 1% THD; 27 transistors, 4 nuvistors; 300 ohm antenna input; 13 front panel controls. Dimensions in optional accessory case, 15 $\frac{1}{2}$ " wide x 13 $\frac{1}{4}$ " deep x 5 $\frac{1}{4}$ " high. Price, \$429.95. Price slightly higher West of the Rockies. Specifications and price subject to change without notice.

Export: Scott International, 111 Powdermill Road, Maynard, Mass. Canada: Atlas Radio Corp., 50 Wingold Ave., Toronto. Cable HIFI

## IMPORTANT FREE OFFER FROM SCOTT



H.H. Scott, Inc., 111 Powdermill Rd., Maynard, Mass.  
 Please send me your new 20-page full-color 1965 Stereo Guide and complete catalog. Include complete information on new consoles by Scott . . . component quality in beautiful, hand-finished cabinets.

Name .....  
 Address .....  
 City ..... Zone ..... State .....



590-10

# 3 Tuners

## Model FT60 FM Tuner

Transistorized stereo design. Sensitivity 2  $\mu$ v. for 20 db of quieting; dist. .5%; separation 35 db @ 1000 cps; Features 4 wide-band i.f. stages, wide-band ratio detector, a.f.c., time-switching multiplex design; tuning meter; stereo indicator light and automatic stereo/mono switching. Usable sensitivity 2.5  $\mu$ v.; response 30-15,000 cps  $\pm$ 1 db; selectivity 225 kc. @ -3 db down. Front-panel controls: mono/stereo sw., a.f.c. & tuning control. Has 15 transistors & 11 diodes. 15" w. x 10" d. x 4 1/4" h. ....\$234.95  
Vinyl-clad walnut metal cabinet...\$ 14.95  
Walnut cabinet .....\$ 27.95



ration 35 db @ 1000 cps; Features 4 wide-band i.f. stages, wide-band ratio detector, a.f.c., time-switching multiplex design; tuning meter; stereo indicator light and automatic stereo/mono switching. Usable sensitivity 2.5  $\mu$ v.; response 30-15,000 cps  $\pm$ 1 db; selectivity 225 kc. @ -3 db down. Front-panel controls: mono/stereo sw., a.f.c. & tuning control. Has 15 transistors & 11 diodes. 15" w. x 10" d. x 4 1/4" h. ....\$234.95  
Vinyl-clad walnut metal cabinet...\$ 14.95  
Walnut cabinet .....\$ 27.95

## BURSTEIN-APPLEBEE

### Model 400A-5 AM-FM Stereo Tuner

FM response 20-20,000 cps  $\pm$ 0.5 db, AM 20-6000 cps  $\pm$ 3 db; distortion .5% IM or harmonic; separation 30 db or better; hum & noise 60 db below 100% modulation. Controls: on-off, a.f.c. on-off, selector (AM, FM, FM stereo), tuning; 8 tubes, 8 semi-conductors. 13 1/2" w. x 10 3/4" d. x 4 3/4" h.  
33D92 tuner less cover.....\$79.95  
33D93 brown metal cover.....\$ 4.95  
33D94 oiled walnut wood cabinet...\$14.95

## CALBEST ELECTRONICS

### Model 9150 AM-FM Stereo Tuner

Both AM & FM tuners can be played simultaneously; has a.f.c.; separate tuning indicators for AM & FM; FM stereo indicator light; FM sensitivity 2.25  $\mu$ v. for 30 db of quieting; output .45 v.; HD 1%: hum & noise -54 db; channel separation 30 db @ 1 kc.; has 13 tubes, 6 crystal diodes, silicon power rectifier; 15" x 9 1/2" x 4 1/2" h. (list price).....\$219.50

## DE WALD

### Model S-803A "Imperial"

AM-FM mono type tuner; FM sensitivity 3  $\mu$ v. for 20 db quieting; frequency re-



sponse 20-20,000 cps  $\pm$ 1 db; a.f.c.; hum 70 db below 1 volt; output 1 volt for 30% modulation; AM sensitivity 75  $\mu$ v. loop sensitivity; bandwidth 7000 cps; 7 tubes plus selenium rectifier; black and gold cabinet; 13" w. x 4 1/2" h. x 9" d. ..\$89.95

### S-1103A AM-FM Stereo Tuner

Has FM multiplex circuitry; FM sensitivity 3  $\mu$ v. for 20 db of quieting; response 20-20,000 cps  $\pm$ 1 db; hum 70 db below 1 v.; cathode-follower (2 1/2 v.) outputs



for operating dual-channel power amplifier; built-in AM ferrite and FM line-cord antennas; controls are mono, FM stereo, function, stereo blend; cabinet black with brass escutcheon; 13 1/2" l. x 4 1/4" h. x 11 1/2" d. ....\$119.95

## DYNACO

### Model FM-1 FM Tuner Kit

Low-distortion, drift-free FM tuner; etched-circuit construction; high usable sensitivity;



EM-84 tuning eye permits precision alignment without test instruments; slug-tuned pre-aligned cils four i.f. stages; balanced-bridge wide-band discriminator; feedback audio stage for 2-volt, low-impedance output; front-panel volume control; cover included; kit.....\$ 79.95  
FM-1/A Factory assembled .....\$119.95  
PM-4 Panel mount accessory kit for any Dynatuner combination .....\$ 4.95  
PK-40 Deluxe panel & knob kit (supplied as standard on FM-3 tuner).....\$ 9.95

### Model FM-3 FM Stereo Tuner Kit

Completely integrated design combining FM-1 tuner & FMX-3 multiplex circuitry;

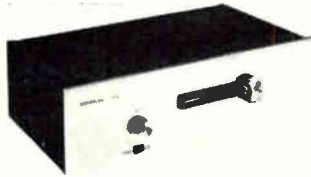

etched circuit boards are used throughout; sensitivity 4  $\mu$ v. for 30 db of quieting at 100% modulation; response 10-40,000 cps  $\pm$ 1 db; noise 70 db below 100% mod.; distortion at 100% mod. .5% IM & HD from 10  $\mu$ v. to .1 v.; has simplified alignment procedure without requiring test instruments; kit.....\$109.95  
Factory wired.....\$169.95

## EICO

### Model ST-97 FM Stereo Tuner

Prewired, pre-aligned front end and i.f. strips; employs wide-band ratio detector;



stereo indicating pilot lamp; controls: tuning, separation, a.f.c.-on-off, stereo/mono, and power; IIF sensitivity 3  $\mu$ v. (1.5  $\mu$ v. for 20 db quieting); signal-to-noise ratio -55 db; harmonic distortion .6%; IM distortion .2%; response 20-15,000 cps; channel separation 30 db; output .7 to 1 volt; 5 1/4" h. x 15 3/4" w. x 11 3/4" d.

Kit .....\$99.95  
Factory wired.....\$149.95

### Model HFT-90A FM Tuner

Sensitivity 1.5 microvolts for 20 db quieting; frequency response 20 to 20,000 cps



$\pm$ 1 db; i.f. bandwidth 260 kc. at 6 db points; detector bandwidth 400 kc.; maximum drift 20 kc. from cold start; hum 60 db below 1 volt; pre-wired front end; pre-aligned front end, i.f., and ratio detector; DM-70 tuning eye that travels along dial; flywheel tuning; a.g.c.; 300 ohms input; outputs are cathode follower to amplifier and multiplex; tubes are ECC85/6AQ8, 3-6AU6, 6AL5, 6C4, 6X4, DM-70.  
Kit .....\$44.95  
Factory wired .....\$69.95  
Cover .....\$3.95

### Model HFT-92A AM-FM Tuner

Combination HFT-90A FM tuner with AM facilities; "eye-tronic" tuning on both AM



and FM; stabilized low-limiting threshold for weaker stations reception; pre-wired, pre-aligned front end; FM sensitivity 1.5  $\mu$ v. for 20 db quieting; AM sensitivity 20  $\mu$ v. for 0.8 volt output with 20 db signal-to-noise ratio; frequency response AM section 20-5000 cps; hum 60 db below 1 volt; AM output 0.8 volt with 20  $\mu$ v. input; AM total harmonic distortion below 2% for 70% modulation.

Kit .....\$64.95  
Wired .....\$99.95

### Model HFT-94A AM Tuner

Matches Model HFT-90A FM tuner; narrow or wide bandwidth selector; sensitivity

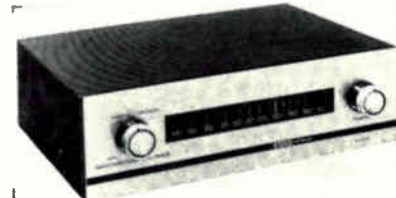

3  $\mu$ v. at 30% modulation for 1 volt out; frequency response 20-9000 cps; less than 1% harmonic distortion at 100% modulation; 8000 ohms output impedance; tubes are 2-6BA6, 6BE6, 12AU7, DM70 exclamation bar tuning eye; 3 3/8" x 12" x 8 1/4" cabinet & panel style similar to model HFT-92A.....\$44.95  
Factory wired.....\$69.95  
Walnut cabinet for Models HFT-90A; HFT-92A; and HFT-94A.....\$12.50

### Model ST-96 FM-AM Tuner

Pre-wired, pre-aligned front end shielded in die-cast housing; includes a.f.c., a.g.c., tuning eye indicator, narrow and wide AM bandwidth, 10 kc. AM whistle filter; FM section sensitivity, 1.5  $\mu$ v. for 20 db quieting; FM frequency response 20-15,000

# QA on Hi-Fi TUNERS & RECEIVERS

By D. von RECKLINGHAUSEN/Chief Research Eng., H. H. Scott, Inc.

**W**HEN corresponding with or talking to present and prospective owners of hi-fi tuners, questions often arise which designers, manufacturers, and hi-fi equipment dealers are called upon to answer. Some of these involve special conditions which require further inquiries into the circumstances but most questions are of a general nature and thus capable of being answered by citing basic principles. Here are ten typical questions that fall into this category.

*What are the advantages of having tuners separate from amplifiers?* Separate tuners can be added to hi-fi systems at any time and can later be traded in for a different model without disturbing the rest of the components in a hi-fi system. They are smaller in size and, in many cases, are more adaptable in specific installations.

*What are the advantages of tuner/amplifier combinations?* These units are easy to install and require no additional interconnection between amplifier and tuner. Also, a small saving can be realized since the tuner and amplifier share a common chassis and a common power supply. High-quality tuner/amplifier combinations available today offer performance in both tuner and amplifier identical to that of separate components.

*What is the meaning of tuner sensitivity?* Tuner sensitivity, measured in microvolts (Institute of High Fidelity rating), indicates the amount of signal required at the tuner's antenna terminals to reduce total noise and distortion to less than 3%. A signal at least three times as large as the rated sensitivity is required for good quality monophonic reception and at least 30 times as large for good quality stereophonic reception. When the tuner is intended for reception of local signals only, the tuner's sensitivity is of very little consequence. However, when distant stations are to be received, a tuner with greater sensitivity, or lower microvolt rating, will in general perform better. Present-day, high-quality tuners exhibit sensitivities which are very close to the maximum possible limit.

*From what distance can I expect reception?* This question is most difficult to answer because it depends, to a large degree, on the surrounding terrain. When the tuner is located in the city, with only an indoor antenna connected, reception of stations up to 20 or 30 miles away can be expected. With an outdoor antenna and surrounding hilly terrain, reception distance would perhaps increase to 40 or 50 miles. When the surrounding terrain is flat and a high-gain outdoor antenna is used in conjunction with a high-sensitivity tuner, reception of stations over 100 miles away is possible and occasional reception of stations several hundred miles away has been reported.

*Can I record stereo radio programs?* A tape recorder can be connected to an FM tuner. Most tuners incorporate a filter so that the supersonic components of the stereo signal will not appear at the recorder output and otherwise inter-

fere and cause beat tones to occur with the supersonic bias oscillator of the tape recorder. In cases where an older tape recorder and an older tuner without such a filter are used together, accessory filters are available which will eliminate the problem.

*What is separation?* Separation, measured in decibels (db), is the ratio between the output voltages of the two channels of a stereophonic tuner with a single channel input. Separation must be great enough so that the signal from one channel does not seriously interfere with the other channel. At least 20 db of separation is required to insure no degradation of stereo quality. A station is required by law to transmit its programs with at least 30 decibels separation, but no such regulation governs the tape recorders, microphones, pickups, or records that the station might use in broadcasting.

*What is multipath?* Multipath exists when the signal from the station can reach the tuner's antenna directly and also by reflection from nearby hills, airplanes, buildings, or other structures. Multipath will result in a fluctuating signal very similar to ghosts observed on a TV set when the antenna is misoriented. Multipath will cause increased noise and also considerably higher distortion when listening to FM-stereo. Both noise and distortion can be reduced considerably if a directional antenna is installed.

*Why do some stations sound poor and others sound good?* Here multipath reception can be a strong contributing factor and a better antenna should be installed. Occasionally certain stations will sound poor in spite of the best antenna and best tuner because these stations are broadcasting poor audio quality at that particular time. They may be playing an old, rare record which unfortunately has some distortion recorded on it, or their pickups, turntables, or even program lines may be temporarily out of order. This, then, is not the fault of the tuner.

*How do you know when a station is transmitting stereo?* Most tuners have an FM-stereo indicator, such as a light or a "magic-eye" tube, which lights up when the FM station transmits its pilot signal. An audible tone or a special tuning-indicator deflection is incorporated in other tuner models. In more sophisticated models, the tuner's circuitry automatically switches between monophonic and stereophonic operation, thereby insuring best performance in each mode.

*How can I improve my FM-stereo performance?* Signal-to-noise ratio of a tuner can always be improved by increasing the amount of signal a tuner receives. For example, the difference in the amount of signal a tuner can obtain from the same antenna located indoors in an apartment building and that located on the roof can be more than 30 times, resulting in a corresponding improvement in signal-to-noise ratio on both mono and stereo. A high-gain antenna will improve signal-to-noise ratio even further.

# No other solid state stereo tuner/amplifier kit has EICO's \$500-\$600 quality...

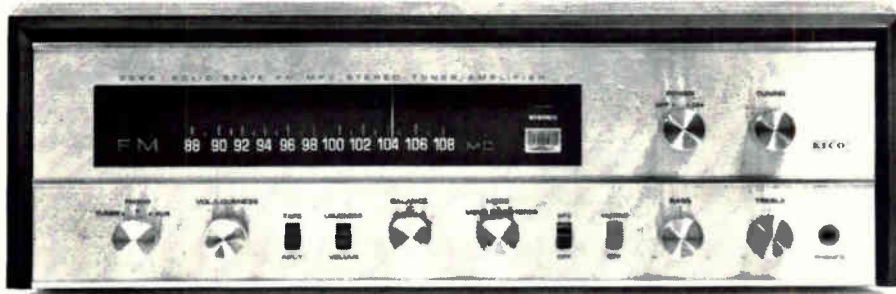

and looks it. (for only \$229<sup>95</sup>)

## Introducing the new 3566 all transistor F.M. MPX Stereo Tuner/Amplifier. Designed throughout to the quality level of the costliest Tuner/Amplifiers on the market.

**SUPERIOR TRANSISTOR SOUND:** Perfect deep bass fidelity, the clarity and detail of exactly reproduced transients... the sweet, airy quality achieved with extremely low distortion and extended frequency response. Plus plentiful reserve power for orchestral crescendos (even with inefficient speaker systems)—all against a velvet quiet background: This is the new transistor sound that is taking over in high fidelity... This is the sound of the superior new EICO 3566.

**UNSURPASSED FM STEREO TUNER PERFORMANCE:** Entirely new FM "Front End" and 4-Stage IF Strip with wideband ratio detector, developed only after the practical requirements of optimum FM Stereo performance were established by experience with earlier transistor designs in the field... Achieves **Minimum Bandwidth Variation with signal level** for consistently high quality reception regardless of signal strength... **Handles even abnormally strong signals without overloading** (a strong local signal won't "blanket" the dial)... **Unsurpassed usable sensitivity** with only slightly more signal required for full 40db quieting. **Time-switching** transistor multiplex circuitry, incorporating separation and balance adjust, achieves outstanding 38db channel separation... completely effective filtering of all types of interference. Noiseless, purely electronic **Automatic Switching** between FM Stereo and FM Mono (controlled by the pilot frequency in stereo broadcast signal), with defeat. **Stereo Indicator Light** gives instantly visible indication of stereo broadcasts... **D'Arsonval tuning meter** gives exact center-of-channel tuning indication... **Adjustable threshold inter-station noise muting** gives you silence between stations while tuning, and infallible stereo program indication. Convenient Muting-Off Switch for weak station reception... **Exactly right AFC pull-in range** permits you to tune in stereo stations accurately with ease. Convenient AFC-Off switch for tuning in weak stations.

**UNSURPASSED STEREO AMPLIFIER/PREAMPLIFIER PERFORMANCE:** Entirely new amplifier/preamplifier circuitry, designed with the highest performance objectives. **Phenomenally low noise, low distortion RIAA phono preamplifiers** with maximum overload resistance. **Low distortion, variable inflection feedback tone controls** permit boost or cut at the extremes of the range without affecting mid-range response or the volume level. Isolated from power amplifier by buffer stages to eliminate loading distortion. **Unique, very low distortion drive of power amplifier output stages**, plus 36db of overall feedback to reduce distortion to an inaudible level. **No output transformers**—giving unrestricted bass response and eliminating transient distortions normally occurring due to output transformer characteristics.

**SIMPLIFIED KIT ASSEMBLY:** You wire only non-critical audio and power supply circuits, mostly on military-style terminal boards for easy check-out... **FM "Front End," 4-stage FM IF strip, and entire multiplex circuit pre-wired and pre-aligned**... Transistor Sockets eliminate risk of transistor heat damage... **This kit can be recommended to beginners!**

**CONTROLS:** Input Selector, Mode (incorporates FM stereo defeat), Volume, Balance, Bass, Treble, Loudness Compensation, Muting-off, AFC-off, Power on-off. **INPUTS:** Mag. Phono, tape, auxiliary, 300 Ω antenna. **OUTPUTS:** left and right speakers, tape, headphones. **INDICATORS:** Illuminated tuning dial, tuning meter, stereo program indicator light. **FUSES:** Line, Left Speaker, Right Speaker, SIZE (HWD): 5 x 16½ x 13¼ inches.

**AMPLIFIER / PREAMPLIFIER SPECIFICATIONS:** POWER: 66 watts total IHF music power output. **IM DISTORTION:** 2% at 30 wpc (watts per channel); 1% at 25 wpc; 0.3% at normal listening level. **IHF POWER BANDWIDTH:** 20-20,000 at 25 wpc, 0.5% harmonic distortion. **HARMONIC DISTORTION:** 0.16% at normal listening level. **FREQUENCY RESPONSE:** ± 1db 10-60,000 cps. **HUM & NOISE:** 70db below 10mV on mag. phono; 70db below rated power on other inputs. **SENSITIVITY:** 3mV on mag. phono, 180mV on other inputs. **SPEAKER CONNECTIONS:** 8-16 ohms.

**FM MPX STEREO TUNER SPECIFICATIONS:** **SENSITIVITY:** 2 microvolts for 30db quieting (IHF Standard), 2.7 microvolts for 40db quieting. **IHF HARMONIC DISTORTION:** 0.5%. **CHANNEL SEPARATION:** 38db. **FREQUENCY RETO-NOISE RATIO:** 60db. **IHF CAPTURE RATIO:** SPONSE: ± 1db 20-15,000 cps. **IHF SIGNAL-4.5db. IMAGE REJECTION:** 50db. **IF & SPURIOUS REJECTION:** 80db. **SCA REJECTION:** 40db. **38 KC SUPPRESSION:** 55 db. **19 KC SUPPRESSION:** 45 db.

EICO 3566 also available factory wired (includes oiled walnut cabinet) \$349.95... optional oiled walnut cabinet for kit \$9.95.

Visit the EICO exhibit in the Pavilion of American Interiors at the World's Fair.

HFSD9

**EICO** EICO Electronic Instrument Co., Inc.  
131-01 39th Avenue, Flushing, N.Y. 11352

Please send 1964 Catalog

Name \_\_\_\_\_

Address \_\_\_\_\_

City \_\_\_\_\_ Zone \_\_\_\_\_ State \_\_\_\_\_

CIRCLE NO. 20 ON READER SERVICE CARD



cps; FM output level 1 v. for 5 μv. input, 30% mod.; AM output 1 v. for 3 μv. input. 30% mod.; 157<sub>a</sub>" x 5" x 14". Has

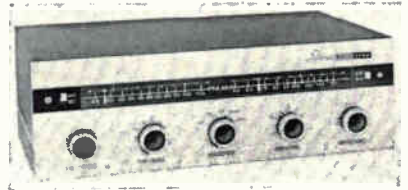

separate AM & FM tuners (kit).....\$89.95  
Factory wired and tested.....\$129.95

### 2200 FM Stereo Tuner

Sensitivity 3 μv. for 30 db quieting; stereo sensitivity 3 μv. for synchronization; HD .6%; channel separation 30 db; response 20-15,000 cps ± 1 db; front-end and 4 i.f.'s



through ratio detector supplied pre-wired & pre-aligned in kit; audio output 1.5 v.; has bar-type tuning & stereo program indicator; semi-kit .....\$ 92.50  
Factory wired .....\$119.95  
Metal cover .....\$ 7.50  
Walnut case .....\$ 19.95

### ERIC

### ST-100 FM-Stereo Tuner

All-transistor design. Sensitivity 2.5 μv. for 20 db quieting; response 20-53,000 cps ± 1



db; separation 30 db from 20 to 15,000 cps; dist. less than 1% at 100% modulation. Has balanced ratio detector, a.f.c., stereo indicator light. Automatic switching between FM & stereo operation; multiplex filters supplied with cabinet. Photo shows tuner above SA-100 amp. 10" x 7½" d. x 2½" .....\$115.00

### "The Madera" ST-300 FM-Stereo Tuner



STEREO/HI-FI DIRECTORY

All-transistor design. Has a.f.c. & tuning meter. Sensitivity 2.5  $\mu$ v. for 30 db of quieting; HD below 1% @ 100% mod.; tuner bandwidth 340 kc.; image rejection 65 db. Photo shows tuner below SA-400 amplifier. \$199.00

### FISHER

#### FM-100-C FM Stereo Tuner

Features automatic stereo/mono switching; transistorized "time-division" multiplex cir-

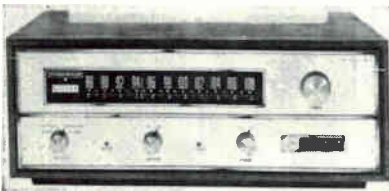

cuit; controls: on/off, tuning; 3-position mode sw. & 3-position input selector. Response 20-15,000 cps. Sensitivity: 1.8  $\mu$ v. for 30 db quieting. HD .5% (100% mod.); separation 40 db at 1 kc.  $4\frac{1}{16}$ " x  $1\frac{1}{8}$ " w. x  $1\frac{1}{8}$ " d. Less cabinet.....\$249.50

#### FM-200-C FM Stereo Tuner

Features automatic stereo-mono switching; automatic stereo broadcast scanner (mutes mono stations to permit only reception of stereo stations); tuning meter; nuvistor front-end & transistorized "time division" multiplex circuit. Response 20-15,000 cps; sensitivity 1.8  $\mu$ v. for 30 db quieting; HD .4% (100% mod.); separation 40 db @ 1 kc. Similar in appearance to FM-100-C.  $4\frac{1}{16}$ " h. x  $15\frac{1}{8}$ " h. x  $11\frac{1}{8}$ " w. Less cabinet .....\$299.50

#### FM-90-B FM Stereo Tuner

Has automatic stereo/mono indicator, tuning meter; "time-division" multiplex cir-

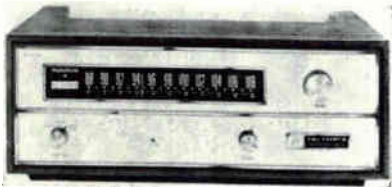

cuitry. Response 20-15,000 cps; sensitivity 2.0  $\mu$ v.; separation 35 db at 1 kc. HD .5% (100% mod.).  $15\frac{1}{8}$ " w. x  $4\frac{1}{16}$ " h. x  $11\frac{1}{8}$ " d. Less cabinet.....\$179.50

#### TFM-300 FM Stereo Tuner

Has nuvistor front-end with balance of circuit transistorized. Has automatic stereo/

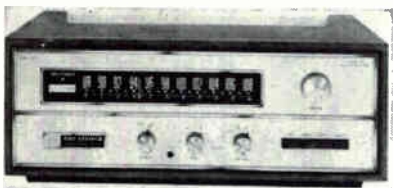

mono switching; variable threshold muting; tuning meter. Sensitivity 1.8  $\mu$ v. for 30 db quieting; S/N ratio 70 db (100% mod.); HD .4% (400 cps, 100% mod.); separation 40 db; capture ratio 2 db.  $15\frac{1}{8}$ " w. x  $4\frac{1}{16}$ " h. x  $11\frac{1}{8}$ " d. Less cabinet.....\$299.50

#### KM-60 FM Stereo Tuner Kit

Sensitivity 1.8  $\mu$ v. for 30 db quieting (1.2  $\mu$ v. for 20 db of quieting); HD less than .5% at 400 cps & 100% modulation; controls: on/off, tuning, mono/stereo selector, stereo filter. Has multiplex circuitry.  $15\frac{1}{8}$ " w. x  $4\frac{1}{16}$ " h. x 13"; less cabinet.

1965 EDITION



Kit .....\$169.50

#### Model R-200 AM-FM Stereo Tuner

Multiplex design based on time-division system with automatic stereo/mono switch-



ing; FM usable sensitivity 1.6  $\mu$ v. (1HF) 300 ohm line with 100% modulation; response 20-15,000 cps  $\pm$ 1 db; harmonic distortion less than .15% at rated output of 2 volts; AM tuner sensitivity 5  $\mu$ v.; 15 tubes, 15 diodes, one bridge-type selenium rectifier; controls: tuning, stereo filter, selector, muting, AM bandwidth, FM-antenna; has "Stereo Beacon" indicator and tuning meter;  $15\frac{1}{8}$ " w. x 13" d. x  $4\frac{1}{16}$ " h.; less cabinet.....\$299.50

#### Model FM-1000 FM Stereo Tuner

Studio Standard Series; features built-in multiplex circuitry; 1.5  $\mu$ v. sensitivity;



four tuned circuits; seven i.f. stages; 5 limiters; 1.3 db capture ratio; a.f.c.; drift .004% (with a.f.c.) & .02% (without a.f.c.) .....\$429.50

#### MF-300 Remote Control FM Stereo Tuner

Features a remote control for station tuning; "Tune-O-Matic" uses a center-of-



channel detector, synchronous motor with gear train; tuner has "Stereo Beacon", a stereo/mono indicator light; supplied with 40' cable & remote-control station selector unit (RK-10); transmitter-receiver Model RK-20 is optional equipment (not supplied) and is used to remotely control both volume-"on-off" & tuning; tuner performance same as FM-200C;  $15\frac{1}{8}$ " x  $4\frac{1}{16}$ " x 13" d.; less cabinet .....\$359.50  
 RK-20 Wireless remote control.....\$129.50  
 RK-15 Wired remote accessory unit; controls volume, tuning, & "on-off"; each station .....\$ 14.95  
 MF-320 Includes wireless remote control, MF-300 tuner, and one-piece control panel in walnut cabinet.....\$513.95

### HARMAN-KARDON

#### "Citation III-X" FM Stereo Tuner

Includes FM multiplex circuitry; sensitivi-

# BEST HI-FI VALUES EICO

are to be found at your EICO distributor who offers you a wide selection of professional quality EICO high fidelity equipment. Buy it in semi-kit form to save money and at the same time become familiar enough with it to service it yourself. Or, you can still save money by buying factory-wired EICO products with the assurance you are getting the best Hi-Fi value at any price. Complete EICO line of tuners, amplifiers, speakers and tape recorders headed by the new solid state 3566 FM-MPX automatic stereo tuner/amplifier.

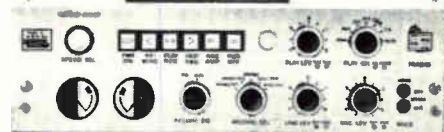
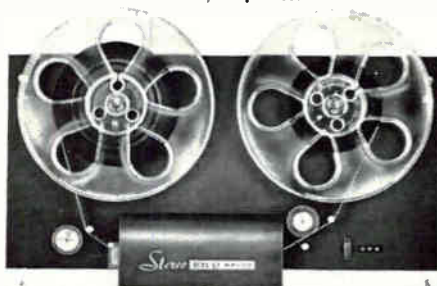

RP-100 solid state 4-track stereo tape recorder deck • Top professional quality • 3-motor drive • 3 high performance heads. Kit only \$299.95, wired \$450.



2536 FM MPX STEREO TUNER/AMPLIFIER combines a superb-FM-MPX stereo tuner with a virtually distortion-free 36-watt stereo amplifier. Kit \$154.95, wired \$209.95.

ST 70 70-watt integrated stereo amplifier kit \$99.95, wired \$149.95.



ST 40 40-watt integrated stereo amplifier kit \$79.95, wired \$129.95.



12-watt Hi-Fi system HF90A FM tuner, kit \$44.95, wired \$69.95. HF12A amplifier, kit, \$39.95 wired \$59.95. BOTH for only \$84.90 kit, \$119.90 wired.

EICO Electronic Instrument Co., Inc.  
 131-01 39th Avenue, Flushing, N.Y. 11352

Please send 1964 Catalog **HFD9**

Name \_\_\_\_\_

Address \_\_\_\_\_

City \_\_\_\_\_ Zone \_\_\_\_\_ State \_\_\_\_\_

CIRCLE NO. 20 ON READER SERVICE CARD

# 3 Tuners

ty .65  $\mu$ v. for 20 db of quieting, -1.65



$\mu$ v. (IHF); response 1-52,000 cps  $\pm$  .5 db; distortion less than .1% at 100% modulation; wide-band Foster-Seeley type discriminator; controls—on-off, loudness, a.f.c. on-off, interchannel muting, tuning, local/distance switch; includes balance and level tuning meters; response of multiplex circuit 10-15,000 cps  $\pm$  1/2 db; channel separation -30 db from 10 to 15,000 cps; 14 7/8" x 6" x 12 1/4" d.; has stereo/mono indicator light.

Kit .....\$230.00  
Factory wired.....\$325.00  
Walnut enclosure.....\$ 29.95

## Model F1000T Transistorized FM Stereo Tuner

Features interchannel muting circuit with threshold adjustment and front-panel defeat



switch; tuning meter; time-switching type multiplex circuit; printed-circuit construction and automatic stereo/mono selector (works automatically depending on stereo or mono program being transmitted); sensitivity 2  $\mu$ v. for 30 db of quieting; image rejection 60 db; response 5-53,000 cps  $\pm$  1/4 db (without 38 kc. notch filter); dist. less than .1% at 100% mod.; signal-to-noise ratio 60 db at 100% mod.; front-panel controls: a.f.c. defeat, interchannel muting, stereo defeat sw., 3-pos. (local-suburban-distance) sw. & "on-off"; rear-panel control: interchannel muting & automatic stereo signal threshold adjustments; 18 transistors, 8 diodes; 14 1/16" x 3 3/8" x 8" d.....\$299.95  
Walnut cabinet.....\$ 19.95

## HEATH

### Model AJ-11 AM-FM Tuner

FM sensitivity 2.5  $\mu$ v. for 20 db quieting; AM output 1 volt for 750  $\mu$ v. input; harmonic

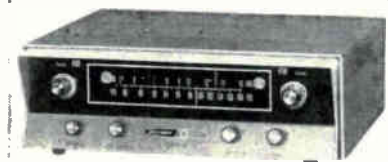

distortion less than 1%; AM broad and narrow tuning; independent AM & FM tuning controls; AM and FM level control on rear-chassis apron; a.f.c.; cathode-follower output; tubes 2-6BA6, 1-6BE6, 2-6BN8, 2-6ME5, 1-6CY5, 1-6EZ8, 3-6AU6; full-wave voltage-doubler power supply. Has separate AM & FM circuits. Kit .....\$ 69.95

### Model AJ-12 FM Stereo Tuner

Features FM multiplex circuitry, stereo indicator light, phase control, adjustable a.f.c.,



filtered output, tuning indicator & circuit-board type assembly; front end is supplied assembled & pre-aligned; output voltage 1 v.; image ratio -45 db; HD less than 1%; response 20-20,000 cps  $\pm$  1 db; a.f.c. correction factor 100 kc./v.; AM suppression -27 db; hum & noise -48 db; sensitivity 3.5  $\mu$ v. for 30 db of quieting; separation 30 db @ 1 kc.; has cathode-follower outputs (kit) .....\$ 69.95

### Model AJ-32 AM-FM Stereo Tuner

Features FM multiplex circuitry; stereo phase control; stereo indicator light; variable a.f.c.; printed-circuit construction; filtered output; built-in antennas; front end is pre-assembled & pre-aligned; FM output 1



v.; image ratio -45 db; HD less than 1%; i.f. rejection -65 db; response 20-20,000 cps  $\pm$  1 db; a.f.c. correction factor 100 kc./v.; AM suppression -27 db; hum & noise -48 db; sensitivity 3.5  $\mu$ v. for 30 db of quieting; has cathode-follower outputs (kit) .....\$ 89.95

### Model AJ-41 Tuner Kit

Complete AM, FM, FM stereo; features stereo indicator light; separate AM and



FM tuning meters; FM squelch circuit; FM response 20-20,000 cps  $\pm$  2 db; 2 $\mu$ v. sensitivity for 20 db of quieting; uses three printed-circuit boards and pre-assembled, pre-aligned FM tuning unit; 5 1/4" h. x 15 1/2" w. x 14 1/2" (kit)..\$119.95

### Model AJ-13 FM-Stereo Tuner

Features a.f.c. on-off sw.; selector sw. (on-off, FM, stereo) & tuning control. Sensitivity

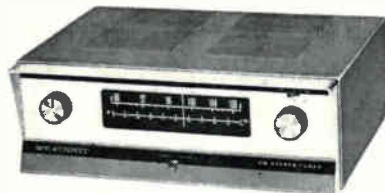

2.5  $\mu$ v. for 20 db of quieting; mono response 30-20,000 cps  $\pm$  1 db, stereo response 50-15,000 cps  $\pm$  2 db. HD 1% at 1000 cps; separation 25 db at 1000 cps. Has stereo indicator light. Kit .....\$49.95

### Model AJ-33 Transistor AM-FM Tuner

Features stereo circuitry, 20 transistors, 10 diodes, a.f.c., stereo indicator light; filtered

stereo tape recorder outputs; a.g.c., adj. FM squelch; tuning meter and pre-built, pre-

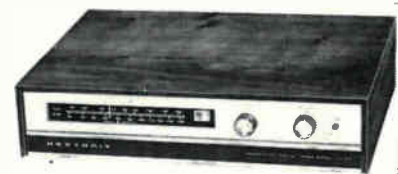

aligned FM front-end & AM-FM i.f. circuit. Has emitter-follower output of .5 v. Sensitivity 3.5  $\mu$ v. for 30 db of quieting; response 20-20,000 cps  $\pm$  1 db; HD less than 1%; channel separation 30 db @ 1 kc.; 15 1/8" w. x 3 3/4" h. x 11 1/2". Kit .....\$99.95

### Model AJ-43 Transistor AM-FM Tuner

Features stereo circuitry; automatic stereo switching, stereo indicator light. Pre-assembled FM tuning unit & 4-stage i.f. circuit board; separate AM & FM tuning meters, filtered stereo tape recorder outputs; a.f.c., a.g.c., stereo phase control. Has 25 transistors & 9 diodes. Built-in AM & FM antenna. All secondary controls are under hinged



front-panel. FM sensitivity 1.5  $\mu$ v. for 20 db of quieting; 2  $\mu$ v. for 30 db of quieting; image rejection 35 db; i.f. rejection 80 db; capture ratio 7.5 db; Bandwidth 300 kc. at 6 db down (full quieting). HD less than 1% (full quieting), emitter-follower output, output voltage .5 v. Separation 40 db at 50 cps to 2 kc., 30 db @ 10,000 cps & 25 db @ 15 kc. Hum & noise -55 db. Kit .....\$119.95

### Model AJ-53 AM Tuner

Features "fidelity" selector switch with choice of "normal" bandwidth and sensi-



tivity or wide-band reception. Has self-powered circuit with enough audio output for "private" earphone listening independent of hi-fi amplifier. Kit.....\$29.95

### Model AJ-63 FM Tuner

Mono design; convertible to stereo by addition of AC-11 multiplex adapter; has a.f.c.

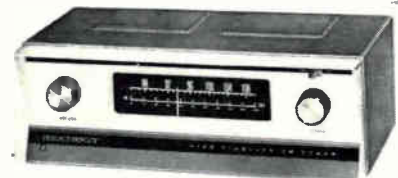

& cathode-follower output; tuning unit is pre-assembled & pre-aligned; sensitivity 3.5  $\mu$ v. for 30 db of quieting; image ratio 45 db; a.f.c. correction factor 75 kc./v.; AM suppression 25 db; response 20-20,000 cps  $\pm$  2 db; HD less than 1.5%; IM 1%; output .5 v. 4 1/16" x 13 1/2" x 6". Kit.....\$39.95

**KARG**

**"Tunematic" XT-1A FM Tuner**

Sensitivity 2 microvolts for 20 db quieting on 300 ohm input; frequency response 15 to 30,000 cps  $\pm 0.5$  db, including de-emphasis; i.f. bandwidth 180 kc. flat top, 240 kc. at 6 db points; IM distortion 0.5% maximum at 100% modulation; crystal-controlled oscillator with separate crystals for receiving each of up to 12 stations; tuning accuracy within .025% of correct carrier frequency at any combination of line voltage and temperature from 95 to 135 volts and  $-55^{\circ}$  to  $90^{\circ}$  C; inputs: balanced 300 ohms, 75 ohm coaxial, internal antenna; outputs: 3-volt cathode follower, 0.3-volt (adjustable) 600 ohm line; 0.3-volt multiplex; 16" w x 5 1/2" h x 5 1/2" d (in metal enclosure); includes metal cabinet. Twelve-channel model.....\$229.95

**Model FMX-9 FM Stereo Tuner**

Has 9" slide-rule dial; tuning indicator; background signal filter; a.v.c. switch;

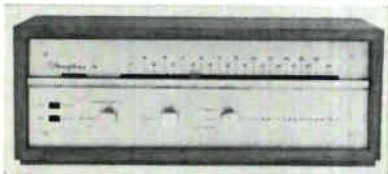

stereo indicator light; stereo-mono-standby switch; sensitivity 2.2  $\mu$ v. (HIF) or .8  $\mu$ v. for 20 db of quieting; response 40-15,000 cps  $\pm 1$  db; harmonic distortion under 1.5%; multiplex channel separation 33 db; 5" h. x 15 3/4" w. x 5 1/2" deep. ....\$179.95

**SCT-3 FM Stereo Tuner**

Features automatic stereo signal indicator, automatic stereo/mono switching; sensitiv-

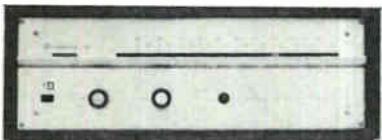

ity 2.2  $\mu$ v. HIF, .8  $\mu$ v. for 20 db of quieting; response 40-15,000 cps  $\pm 1$  db; channel separation 33 db; S/N ratio 48 db with 50  $\mu$ v. input; HD under 1.5%; controls: on/off, volume, tuning, selector (mono, stereo, standby); ant. inputs 300 ohm balanced & 75 ohm coax; outputs: stereo 1.5 v. @ 10,000 ohms, mono .5 v. @ 2000 ohms; 5" x 15 3/4" x 5 1/2" d.; with metal cabinet .....\$149.50 Walnut wood cabinet.....\$ 19.95

**KENWOOD**

**TK-500 FM Stereo Tuner**

Transistor design with nuvistor front-end. Features automatic FM stereo/mono switching; SCA noise filter; tuning meter; sensitivity .6  $\mu$ v. for 20 db of quieting; response 20-20,000 cps  $\pm 1/2$  db; separation better

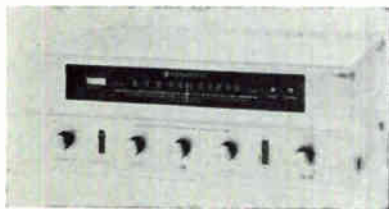

than 35 db @ 1000 cps; HD .6%. Output voltage is 2 v. @ 100% modulation. 15 1/4" w. x 12 1/4" d. x 5 3/4" h. ....\$199.95

**KW-550 AM-FM Stereo Tuner**

Similar in appearance & operation to Model

*the sound approach to quality*



**KENWOOD**

... a name that is rapidly being recognized as synonymous with superior quality and highest performance, has a "new look" with all-new, advanced circuitry. Years of research by master engineers has resulted in these seven new components that are preferred by selective high fidelity enthusiasts.



**KW-10 ALL TRANSISTOR AM/FM AUTOMATIC STEREO RECEIVER** features an exclusive automatic protection circuit (U.S. Patent pending). Total 40 watts music power.



**KW-55 AM/FM STEREO MULTIPLEX RECEIVER** has an exclusive FM stereo indicator, 4 wideband IF stages with 3 limiters and wideband ratio detector. Total 40 watts music power.

**KW-33 AM/FM STEREO MULTIPLEX RECEIVER** with exclusive FM stereo monitor system features SCA noise eliminator and front-panel stereo headset jack. Total 28 watts music power.

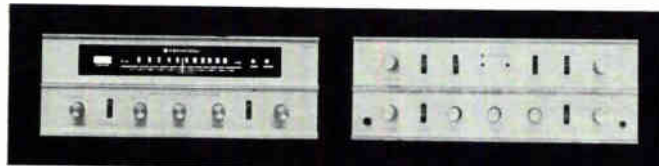

**TK-500 TRANSISTORIZED AUTOMATIC FM STEREO TUNER** features nuvistor cascode front-end, 5 IF stages, automatic relay switching to proper mode and inter-station muting.

**TK-400 ALL TRANSISTOR STEREO AMPLIFIER** has the exclusive automatic protection circuit (U.S. Patent pending) and output transformerless circuit. Total 80 watts music power.



**KW-550 FM AUTOMATIC STEREO MULTIPLEX TUNER** with automatic relay switching to proper mode has 5 wideband FM IF stages with 4 limiters, nuvistor cascode front-end.

**KW-220 INTEGRATED STEREO AMPLIFIER** features 2 sets of terminals for each MAG and AUX and direct tape monitor system. Total 100 watts music power.

**KENWOOD provides the extra features and maximum performance capabilities expected from highest priced units at a pleasant, lower cost.**

*Visit your franchise KENWOOD dealer*



**KENWOOD ELECTRONICS, INC.**

NEW YORK OFFICE: 212 FIFTH AVENUE, NEW YORK, N.Y. 10010, MURRAY HILL 6-1590  
LOS ANGELES OFFICE: 3700 S. BROADWAY PL., LOS ANGELES, CALIF. 90007, AD 2-7217

# 3 Tuners

TK-500 except all tube operation instead of transistorized .....\$169.95

## KLH

### Model Eighteen FM-Multiplex Tuner

Fully transistorized with built-in antenna, designed as an accessory for Models Eleven, Fifteen, and any quality phono system that can accommodate an FM stereo tuner; vernier planetary tuning, zero-center tuning meter, and signal beacon. Controls: power on/off-volume, mono/stereo, SCA filter switch; 300-ohm input terminals for ext. antenna; 8 7/8" w. x 4" h. x 5 3/8" d.; walnut .....\$119.95

## KNIGHT

### KN-255A AM-FM Stereo Tuner

16 transistors, 8 diodes, 1 selenium rectifier; FM sensitivity 2  $\mu$ v. for 20 db of quieting;



response 20-20,000 cps  $\pm$  5 db; distortion .5% at 100% modulation; hum -58 db below 100% modulation; outputs: two low impedance & 2 high impedance for stereo taping off-the-air; stereo indicator light; tuning meter; matches KN-950A stereo amplifier; less case.....\$139.95  
Walnut case.....\$ 12.95  
Metal case.....\$ 5.95

### KN-265 AM-FM Stereo Tuner

17 transistors, 8 diodes, 1 selenium rectifier; FM sensitivity 2  $\mu$ v. for 30 db of quieting;



response 20-25,000 cps  $\pm$  5 db; distortion .5% at 100% modulation; hum -58 db below 100% modulation; FM bandwidth 300 kc.; stereo separation 30 db; outputs: two low impedance & 2 high impedance for stereo taping off-the-air; stereo indicator light; tuning meter; matches KN-999 stereo amplifier; less case.....\$179.95  
Walnut case.....\$ 14.95  
Metal case.....\$ 5.95

### KN-245A AM-FM Stereo Tuner

9 tubes, 8 diodes, 1 silicon rectifier; FM sensitivity 2  $\mu$ v. for 20 db of quieting; re-



sponse 20-20,000 cps  $\pm$  1 db; distortion 1% at 100% modulation; hum -55 db; FM bandwidth 280 kc.; stereo separation 30 db; combination tuning indicator and stereo indicator light; outputs: mono or stereo; matches KN-940A stereo amplifier; less case .....\$99.95

## KNIGHT-KIT

### Model KG-35 FM Tuner

FM tuner kit with printed circuitry; sensitivity 4  $\mu$ v. for 30 db of quieting (IHF);



output 2 volts at 1000  $\mu$ v. input; i.f. bandwidth 200 kc.; distortion less than 0.6%; output jacks for amplifier and tape recorder; cathode-follower main output; output for stereo multiplex adapters. Features pre-aligned r.f. and i.f. coils. Has 3-position selector switch (on-off, FM, and FM with a.f.c.).

83YX408-KG-35 (kit) .....\$35.95  
83YX019 Metal case.....\$ 3.95  
83YX018 Deluxe walnut case.....\$ 9.95  
83YX022 Economy walnut case.....\$ 4.95

### Model KG-50 AM-FM Stereo Tuner

FM sensitivity 3  $\mu$ v. (IHF) for 30 db of quieting; ratio detector; separation 30 db;



response 50-15,000 cps; hum and noise 50 db below 1 volt; ferrite loop antenna; has cathode-follower outputs.

83YX720 KG-50 (kit).....\$69.95  
83YX019 Metal case.....\$ 3.95  
83YX018 Deluxe walnut case.....\$ 9.95  
83YX022 Economy walnut case.....\$ 4.95

### Model KG-65 AM-FM Tuner

Tuned r.f. stage on FM; a.f.c.; cathode-follower output plus output for stereo

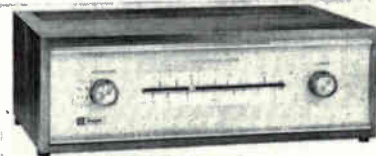

multiplex adapter; flywheel tuning; built-in ferrite antenna; time saving printed-circuit boards; neon-glow dial pointer; sensitivity 4  $\mu$ v. for 30 db of quieting (IHF); 3  $\mu$ v. sensitivity for 10 db signal-to-noise ratio on AM; response 20-20,000 cps; tubes: 6AN8; 6BE6, 6BA7, 12AT7, 2-6AU6, ECC82/12AU7, 6AL5; 6X4 rectifier.

83YX315-KG-65 (kit).....\$49.95  
83YX019 Metal case.....\$ 3.95  
83YX018 Deluxe walnut case.....\$ 9.95  
83YX022 Economy walnut case.....\$ 4.95

### KG-765 Transistor AM-FM Stereo Tuner

Factory aligned front end and i.f. strip;



positive a.f.c., a.g.c., and multiplex indicator; 14 transistors, 18 diodes; t.r.f. FM front end; IHF antenna sensitivity 2.5  $\mu$ v. for 30 db of quieting; response 20-20,000 cps; hum and noise 60 db below 1 volt  
83YX765 KG-765 (kit).....\$ 99.95  
Assembled.....\$149.95

83YX081 Deluxe walnut case.....\$ 12.95  
83YX082 Economy walnut case.....\$ 6.95  
83YX084 Metal case.....\$ 4.95

## LAFAYETTE

### LT-250 FM Stereo Tuner

Features automatic stereo indicator light & an audible tone stereo search indicator



(through both speakers). Has tuning indicator; multiplex noise filter; variable a.f.c. Response 20-20,000 cps; channel separation 38 db @ 400 cps; less than 1% dist. Controls: mode selector (mono, stereo search, FM stereo, FM stereo noise filter), a.f.c., on/off, tuning blend control. Complete with dark beige enclosure. 12 3/4" w. x 4 3/4" h. x 9 1/2" .....\$83.95

### LT-325 AM-FM Stereo Tuner

Features stereo tuning indicator & an audible tone stereo search indicator (through



both speakers). Less than 1% dist.; channel separation 38 db @ 400 cps. Controls: mode selector (AM, FM, FM stereo & stereo search), variable a.f.c., on/off, multiplex noise filter on/off, tuning. Supplied with dark beige enclosure.....\$93.95

## LEAK

### "Trough-Line 3" FM Mono Tuner

Has a.f.c. & trough-line tuning indicator. Sensitivity 1.5  $\mu$ v. for 20 db quieting; out-



put 1 v. r.m.s. cathode-follower; local/distance sw.; 11 1/2" x 4 3/4" x 8 1/4" d.....\$149.00

## MARANTZ

### Model 10-FM Stereo Tuner

Has multiplex feature, unique oscilloscope tuning indicator, and all i.f. alignment ad-

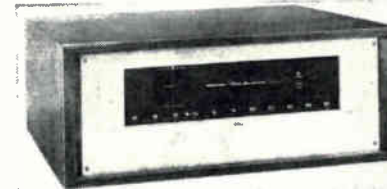

justments have been completely eliminated; uses "Butterworth" bandpass filters in i.f.; Alternate channel rejection, 150 db; tube changes and component aging will not detune i.f.; sensitivity 2  $\mu$ v. for 40 db of quieting; harmonic distortion, input to output, less than .5%; Separation in excess of



30 db throughout freq. range; front panel 15 3/8" x 5 3/4"; chassis 14 3/8" w. x 5 1/4" h. x 15" d. ....\$650.00

**McINTOSH**

**MR67 FM Stereo Tuner**

Features nuvistor tube for 1st r.f. stage; a stereo program indicator light; multi-



path signal indicator; signal-strength indicator; station tuning indicator; response 20-20,000 cps  $\pm$  1/2 db; usable sensitivity better than 2.5  $\mu$ v. @ 100% modulation (3% total noise & distortion); i.f. bandwidth 200 kc. flat top response (-3 db at 200 kc.); dist. less than .5% @ 100% modulation  $\pm$  75 kc. deviation; capture ratio 1.7 db @ 100% modulation; hum better than 70 db below 100% modulation; output 2.5 v.; channel separation 30 db @ 1000 cps; peak-detecting, self-matrixing multiplex circuit is used; 16" wide x 5 7/16" high x 13" deep. ....\$299.00  
Cabinet extra.....\$ 25.00

**MR71 FM Stereo Tuner**

Features automatic stereo/mono switching; multipath signal indicator; stereo indicator



light, tuning meter & signal-strength indicator. Sensitivity 2.5  $\mu$ v. for 20 db of quieting; response 20-20,000 cps  $\pm$  .5 db. Dist. less than .5% @ 100% modulation; capture ratio 1.5 db @ 100% modulation; hum -70 db; output 2.5 v. (low impedance); separation 30 db @ 1000 cps. Peak-detecting, self-matrixing multiplex circuitry. Has SCA & multiplex filters. Front panel size 16" x 5 7/16" with chassis 13" deep. ....\$399.00  
Walnut cabinet.....\$ 25.00

**MI-2 Multi-path/Tuning Indicator**

To be used with an FM tuner to detect & display multi-path signals; by rotating or



repositioning FM antenna, multi-path distortion can be reduced; also can be used as tuning indicator and an audio display indicator; a 3" cathode-ray tube is heart of unit; over-all dimensions: 15 3/8" x 5 3/4" x 11 1/2" d. ....\$219.00  
Cabinet extra.....\$ 25.00

**MERRELL**

**ST-360 FM Tuner**

Sensitivity 1.4  $\mu$ v. for 20 db quieting; distortion less than 1%; has a.f.c. & 300-ohm

1965 EDITION



balanced input; kit is supplied with front end pre-wired and pre-aligned.....\$69.95  
Kit .....\$39.95  
Case .....\$ 4.95

**ST-396 FM-Stereo Tuner**

Same as ST-360 except includes multiplex circuitry .....\$99.95  
Kit .....\$54.95  
Case .....\$ 4.95

**NATIONAL**

**Model 1000 AM-FM Tuner Kit**

Armstrong FM circuit with Foster-Seeley discriminator; sensitivity: FM, 5 microvolts for 30 db quieting; AM 25 microvolts; a.f.c. with defeat provision; frequency response; FM, 20 to 20,000 cps  $\pm$  0.5 db; AM, 20 to 8000 cps  $\pm$  3 db; distortion: less than 1% on FM; bandwidth: FM, 200 kc.; AM 8 kc.; hum level:



-60 db; output voltage: FM 2 volts for 100% modulation, AM 1 volt; tubes: 2-12AT7, 6BE6, 6BA6, 2-6AU6, 6AL5; one selenium rectifier; 10 3/4" w. x 4" h. x 8" d. ....\$31.85  
Metal enclosure.....\$ 5.95

**Model 1100 FM Tuner Kit**

Specifications similar to FM section of Model 1000 AM-FM tuner.....\$25.50  
Metal enclosure.....\$ 5.95

**OLSON ELECTRONICS**

**Model RA-580 AM-FM Stereo Tuner**

Features tuning meter, FM noise filter, and a.f.c. Sensitivity 2  $\mu$ v. for 20 db of quieting.



Response 20-20,000 cps. 14 9/16" w. x 10 3/8" d. x 5 1/8" .....\$79.98

**Model RA-628 FM Stereo Tuner**



Separation 30 db @ 1000 cps; circuit employs 7 tubes and 5 diodes. Has meter-type tuning indicator; 13 1/2" w. x 9" d. x 4 3/4" .....\$64.99

*A New Dimension...  
...IN MUSIC*

AVAILABLE COMPLETELY ASSEMBLED OR IN A KIT FORM

**AUDIO-COLOR**

Add visual excitement to hi fi or stereo system with AUDIO-COLOR... a transistorized unit that can be easily attached to your hi fi, stereo, tape recorder... even most radios.

A moving panorama of color casts dancing images on a soft frosted screen as the music plays. Brilliance of light reflects the various volumes as it rises and falls with each beat of the music. AUDIO-COLOR is simple to build... screwdriver and soldering iron are all the tools you'll need.

Now you can see your favorite recordings or stereo tapes with the AUDIO-COLOR... a real conversation piece for music lovers and electronics enthusiasts alike.

Kit w/walnut finished cabinet.....\$39.95  
Completely assembled unit in walnut finished cabinet \$49.95

Complete instructions included / Shipped Railway Express Collect—Send check or money order to:

**CONAR** Division of National Radio Institute, Dept. AW5C  
3939 Wisconsin Ave., Washington, D.C. 20016  
**CIRCLE NO. 42 ON READER SERVICE PAGE**

WRITE FOR OUR PRICE NOW.  
YOU'LL BE GLAD YOU DID.

- Easy pay plan.  
Up to 24 mos. to pay
- 15-day money-back guarantee.
  - Full 2-year Warranty—Parts & Labor.
  - Franchised all lines. We ship from stock.
  - Trade-ins highest allowance—Send your list.
  - 19th year of reliable service—world-wide.
  - We guarantee "WE WILL NOT BE UNDERSOLD."

save over 40% on hi-fi



**RECORDING TAPE**

The Most Trusted Name in Sound

TYPE				3-11	12+
10A	3"	225'	Acetate	.35	.32
703C1	5'	900'	Acetate	1.14	1.05
702C1	7"	1200'	Acetate	1.39	1.29
708C1	7"	1800'	Mylar	2.39	2.29
710C1	7"	2400'	Ten Mylar	3.95	3.75

Write for types not shown. Any assortment permitted for quantity price.

Deduct additional 5% for 100 + quantities.

Add 15¢ per reel shipping and handling. 10¢ 25+ reels, continental U.S.A.



1797-A 1st Ave.  
New York, N.Y. • 10028

**CIRCLE NO. 28 ON READER SERVICE CARD**

# 3 Tuners

## PACO

### ST-55MX FM Stereo Tuner

Features a.f.c. & tuning eye indicator; sensitivity 2  $\mu$ v. for 20 db quieting; HD less

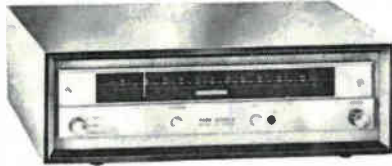

than 1% from 20-20,000 cps; bandwidth over 200 kc.; separation 30 db; supplied less cabinet; 15 3/8" x 11 3/4" x 5 3/8". Kit with pre-aligned multiplex circuitry.....\$109.95  
Semi-kit with pre-aligned multiplex, r.f., i.f. and discriminator circuits.....\$139.95  
Factory assembled, with enclosure.....\$159.95  
Matte finish metal enclosure.....\$ 7.95

### ST-55 FM Tuner

Similar in design, size, and appearance to Model ST-55MX, except does not have multiplex circuitry; less enclosure; kit.....\$69.95  
Semi-kit with r.f., i.f. and discriminator sections pre-aligned, less enclosure.....\$79.95  
Factory assembled with enclosure.....\$99.95

### MXP Multiplex Conversion Kit

Multiplex circuitry to convert Model ST-55 FM tuner to stereo operation; designed for installation on chassis of ST-55; kit.....\$39.95

### ST-25MX FM Stereo Tuner

Features Compactron tube in multiplex section; has 1 v. output; a.f.c.; eye tube tuning

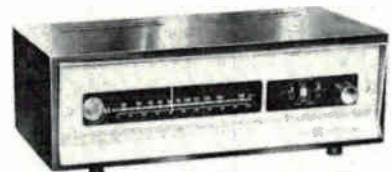

indicator; sensitivity 5  $\mu$ v. for 30 db of quieting; response 30-15,000 cps  $\pm$  2 db; image ratio 40 db; HD 1% @ 100  $\mu$ v. input; 13" x 8 3/4" x 3 7/8"; less enclosure; kit has front end pre-aligned.....\$69.95  
Factory assembled, less enclosure.....\$99.95  
Metal enclosure.....\$ 4.95  
Walnut enclosure.....\$14.95

### ST-25 FM Tuner

Similar in design, size, and appearance to Model ST-25MX except does not have multiplex circuitry; kit.....\$42.95  
Factory built, less enclosure.....\$59.95

## PILOT

### Model "Mark IV" FM Tuner

Sensitivity 4  $\mu$ v.; harmonic distortion 1% at 100% modulation; response 20-20,000



cps  $\pm$  1 db; capture ratio 8 db; selectivity 15 db; two i.f. stages; controls are power on-off and tuning; 5 1/2" x 9 3/4" x 3 1/2"; supplied with enclosure.....\$59.95

### Model 280B Stereo Tuner

Same as Model "Mark IV" except has

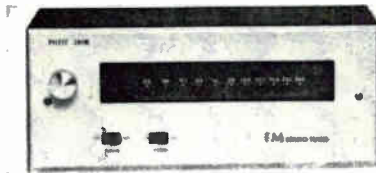

multiplex circuitry; channel separation 30 db; has additional control: stereo in/out; supplied with enclosure; 5" x 11 1/8" x 9 1/4" .....\$99.50

### Model T88 FM Stereo Tuner

Sensitivity 1.8  $\mu$ v. 30 db quieting. Response 20-20,000 cps; HD .2%; capture ratio 1 db; separation 30 db; has tuning meter, automatic stereo/mono switching & stereo indicator light. Controls: power, tuning, selector, FM muting, automatic FM stereo/mono. rear panel level; 6" h. x 15 1/4" w. x 12" .....\$199.50  
Oiled walnut cabinet.....\$ 22.50

## REALISTIC

### Model TM-8C AM-FM Stereo Tuner

Features built-in multiplex circuitry for stereo reception; FM section—1.5  $\mu$ v. for



30 db of quieting  $\pm$  75 kc. deviation (100% modulation), response 20-20,000 cps, tuned r.f. stage, two limiters, wide-band ratio detector, a.f.c.; AM section—antenna terminal sensitivity 2  $\mu$ v. for 20 db signal-to-noise ratio at 30% modulation, 75  $\mu$ v. meter with ferrite core antenna; bandwidth 9.5 kc.; response 20-9500 cps; 12 tubes plus rectifier (incl. multiplex); tuning meters: 14 1/4" x 5" x 10" .....\$79.95

### Model T-4B AM-FM Tuner

Can be used for both mono and stereo systems; FM sensitivity 2  $\mu$ v. for 30 db quieting at 100% modulation; response 20-20,000 cps; harmonic distortion .5% at full output; Armstrong-type circuitry with double-tuned limiter and triode mixer; AM section has ultra-quiet r.f. stage, broadband



tuned i.f. stage, germanium diode detector, sensitive ferrite core antenna, has provisions for multiplex adapter; 11 9/16" x 4 3/8" x 8 13/16" .....\$49.95

## H. H. SCOTT

### Model 350D FM Stereo Tuner

Usable sensitivity 2.3  $\mu$ v.; includes built-in multiplex section; 80 db rejection spurious



response; 6 db capture ratio; automatic multiplex reception; special circuitry to eliminate whistles when making tape recordings; sub-channel noise filter reduces noise on sub-channel without affecting system's frequency response; stereo noise filter reduces noise without affecting stereo separation; has sensitive tuning indicator and stereo indicator; Type "C" case extra. ....less than \$225.00

### Model 333B AM-FM Stereo Tuner

Separate FM and AM tuners; could be used for FM-AM simulcasts; FM usable



sensitivity 2.5  $\mu$ v.; capture ratio 6 db; response 30-15,000 cps  $\pm$  1 db; signal-to-noise ratio 60 db; harmonic distortion .8%; sensitivity 1  $\mu$ v. for 20 db of quieting; tuning meter, subchannel noise filter for multiplex; switchable a.g.c.; "Sonic Monitor" stereo program indicator; 15 1/2" w. x 5 1/4" h. x 13 1/4" d.; Type "C" case extra. ....less than \$290.00

### Model 4310 FM Stereo Tuner

Usable sensitivity 1.9  $\mu$ v.; signal-to-noise ratio 60 db; harmonic distortion .5%; re-

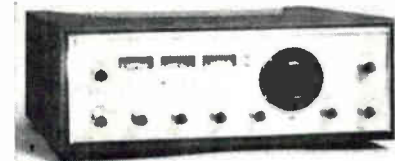

sponse 30-15,000 cps (limit of IITF standard of measurement)  $\pm$  1 db; capture ratio 2.2 db; sensitivity .75  $\mu$ v. for 20 db of quieting; subchannel noise filter for multiplex; switchable a.g.c.; relay-activated squelch; noise filter; automatic program indicator. Features 3 separate meters, tuning meter, right & left channel level indicators .....\$475.00

### Model LT-110B FM Stereo Tuner

Usable sensitivity 2.2  $\mu$ v.; capture ratio 6 db; special circuitry to permit flawless tape

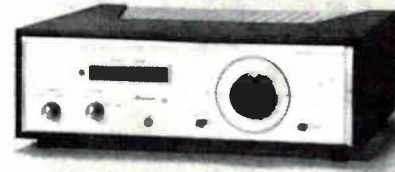

recording; multiplex section pre-assembled and pre-aligned; stereo noise filter and subchannel noise filter same as Model 350D; all wires pre-cut to correct length; tube sockets, terminals, etc. are pre-riveted at factory; 15 1/2" x 5 1/4" x 13 1/4"; Type "C" case extra.

Kit.....less than \$140.00

### 312 Transistorized FM Tuner

Features stereo operation, special stereo noise filters; stereo indicator light; tuning



meter; front-panel tape recorder output jacks; separate level controls for ea. channel;

4-nuvistor front-end & silicon transistors in i.f. circuit. Usable sensitivity (IHF) 2.2  $\mu\text{v.}$ ; cross-modulation rejection 80 db; S/N ratio 65 db; capture ratio 4 db; selectivity 30 db; separation 35 db. Has two front-panel controls: function (off, normal, sub. ch. filter, stereo noise filter) and selector (mono & automatic stereo) .....less than \$260.00

### 310E FM Stereo Tuner

Features time-switching multiplex circuitry; automatic stereo/mono switching; tuning

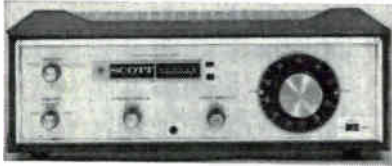

meter; stereo/mono program light indicator; interstation noise suppressor using an electronically controlled mechanical relay with threshold level control; usable (IHF) sensitivity 1.9  $\mu\text{v.}$ ; signal-to-noise ratio 65 db below 100% mod.; HD .5%; response 30-15,000 cps  $\pm 1$  db; capture ratio 2.2 db; separation 30 db; has conventional operating controls; 15 1/2" x 5 1/4" x 13 1/4" d.; less cabinet.....\$279.95

### 4312 Transistorized FM Stereo Tuner

Features time-switching multiplex circuitry; interstation noise suppression; automatic



stereo/mono switching; usable sensitivity (IHF) 1.9  $\mu\text{v.}$ ; signal-to-noise ratio 65 db; HD .5%; response 20-20,000 cps  $\pm 1$  db; capture ratio 2 db; separation 30 db; has tuning meter; 28 transistors, 22 diodes & a 4-nuvistor tube front-end; 17 1/2" x 6 1/2" x 16 1/4" d.; less cabinet.....\$365.00

### SHERWOOD

#### Model S-3000 V FM Stereo Tuner

Has 11 tubes plus rectifier; circuitry same as S-2100 II except AM circuits are omitted;

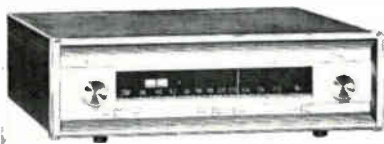

14" x 4" x 10 1/2" d.; less case.....\$165.00  
With walnut leatherette case.....\$172.50

#### Model S-3000 III FM Tuner

Similar in appearance to S-3000 V; adaptable for FM stereo multiplex with insertion (internally) of A-3MX multiplex adapter; circuitry same as S-3000 V FM section; 14" x 4" x 10 1/2" d.; less case.....\$120.50  
With walnut leatherette case.....\$128.00

#### S-2100 II AM-FM Stereo Tuner

Features stereo indicator light; low-distortion

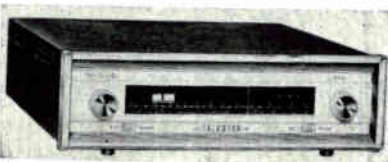

FM multiplex circuitry; FM interchannel hush; zero-center tuning meter; sensitivity: FM .95  $\mu\text{v.}$  for 20 db quieting, 1.8  $\mu\text{v.}$  for -30 db noise & distortion (IHF); AM 2  $\mu\text{v.}$  @ 60% mod. for .5-v. output; selectivity: FM 200 kc. @ -3 db, AM wide 15 kc. @ -6 db, AM narrow 5 kc. @ -6 db; FM detector 1 mc. peak-to-peak; capture ratio 24 db; FM dist. .33% @ 100% mod.; 14 tubes plus silicon rectifier & 9 diodes; 14" x 4" x 12 1/2" d.; less case .....\$209.50  
With walnut leatherette case.....\$217.00

#### Model S-2000 IV AM-FM Tuner

Has 12 tubes plus rectifier; circuitry same as S-2100 II except multiplex circuits omitted;



14" x 4" x 10 1/2" d.; less case.....\$170.50  
With walnut leatherette case.....\$178.00  
Also available mounted on 5 1/4" or 3 1/2" rack panel .....\$178.00

### TEECO

#### Model "Corsair 289" FM Tuner

Mono design with multiplex output jack; response 20-20,000 cps  $\pm 1$  db; sensitivity



2  $\mu\text{v.}$  for 30 db of quieting; hum 55 db below 100% modulation; has a.f.c. defeat switch; tubes: 2-12AT7, 6CB6, 6HS6, 6AL5 plus selenium rectifier; 9 1/4" x 6 1/2" x 4 1/8" .....\$ 56.60

#### Model MXT286 FM Stereo Tuner

Has stereo indicator light and automatic stereo/mono reception if desired; controls



are: separation, balance, stereo/mono, a.f.c. & tuning; response 15-15,000 cps  $\pm 1$  db; sensitivity 2  $\mu\text{v.}$  for 30 db of quieting; separation 30 db. ....\$121.95

### V-M CORP.

#### 1465-2 AM-FM Tuner

FM stereo and FM-AM tuner; response FM 20-20,000 cps  $\pm 1/2$  db; sensitivity



FM 10  $\mu\text{v.}$  for 20 db of quieting; distortion less than 1% harmonic on FM; size 5 1/2" h. x 13 1/2" w. x 12" d. Retail price .....\$139.95

## 3 Multiplex Adapters

### CALBEST ELECTRONICS

#### Model MXA 614 Multiplex Adapter

Self-powered; separation 30 db from 50 to 15,000 cps with wide-band tuners; 25 db with narrow-band tuners; less than 1% HD; has automatic mono-stereo switching; stereo indicator light; input voltage .25 to 5 volts peak-to-peak; 5 1/4" long x 5 1/4" wide x 9" deep.....\$79.95

### DYNACO

#### FMX-3 Stereo Multiplex Adapter

Permits fully automatic conversion of FM-1 Dynatuner to stereo operation; fits on tuner chassis; powered by tuner; two tubes and four diodes in doubler system provide 30 db separation; includes dual-beam "Stereocator" tuning eye; dual volume controls for both channels, replacing standard FM-1 components; tuning station automatically switches adapter to stereo or mono operation; tape recorder filters. FMX-3 Kit .....\$ 29.95

### EICO

#### Model MX-99 FM Multiplex Adapter

Free from phase-distorting filters; designed to required suppression of all spuri-



ous signals including SCA (67-kc.) background-music carrier, re-inserted 38-kc. subcarrier, 19-kc. pilot carrier, and all harmonics thereof; will synchronize with any usable output from an FM tuner and will demodulate, without significant distortion, tuner outputs as high as 5 volts p-p; self-powered; provides automatic stereo/mono operation; includes low-impedance cathode-follower outputs; lamp indicates when station is broadcasting multiplex stereo; separation 30 db between channels; over-all gain of unity is provided from input to output on both mono and stereo, about unity on mono; for use with company's Models HFT-90A, HFT-92A, ST-96 and any other component-quality ratio-detector FM tuners equipped with multiplex output. Has 15 kc. low-pass filters; 9 1/8" x 6 3/8" x 3 3/8"; less cover.

Kit .....\$39.95  
Wired .....\$64.95  
E-9 cover.....\$2.95

### FISHER

#### Model MPX-200 Multiplex Adapter

Designed for use with all high-quality FM tuners and receivers; may be concealed in any out-of-the-way space near the component; special control for matching to any tuner or receiver to be set only at time of original installation; standard connecting cables terminating in pin-plugs on both ends; 12" w. x 4" h. x 3 1/2" d.....\$69.50

#### Model MPX-100 Multiplex Adapter

For use with any tuners or receivers



having a multiplex output; "Stereo Beacon" indicates if station is broadcasting stereo; selector switch for mono/stereo; self-powered; 4 7/8" x 14 1/8" x 12"; less cabinet .....\$79.50  
Walnut or mahogany cabinet.....\$14.95

### HEATH

#### Model AC-11 Multiplex Adapter

Three-tube design with self-contained silicon-rectifier power supply; response 50-15,000 cps; cathode-follower outputs for each channel; has "on-off" switch and separation control.

Model AC-11A Black.....\$24.95  
Model AC-11B Tan.....\$24.95

### KLH

#### Model Thirteen Multiplex Adapter

Combines with Model Eight FM receiving system to provide FM-stereo reception as well as reproduction of stereo discs & tapes; completely transistorized; includes power amplifier (for right channel—left channel amplifier and speaker in Model Eight), stereo preamp, multiplex decoder. Stereo inputs: magnetic cartridge, tape recorder. Outputs: speaker & stereo record. Controls: selector switch, stereo master volume, treble, mono/stereo mode, audible tone for stereo reception, SCA filter switch. Can only be used with Model Eight aux. or Model Thirteen speakers. 7 3/8" w. x 6 1/2" d. x 6 1/2" h.; walnut veneer.....\$104.00  
Complete unit with interconnecting cable, matching speaker, enclosure.....\$149.00

### KORTING

#### Model 23911 Multiplex Adapter

Completely transistorized, 117 v. operation; designed for use with any FM stereo tuner; channel separation 35-50 db; 5 1/2" x 3 3/4" x 1 1/2".....\$39.95

### PACO

#### Model MX100 Multiplex Adapter

Pre-aligned kit; designed for use with all FM tuners; response 15-15,000 cps ±1

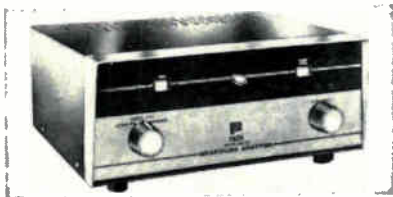

db; output level 1.5 v.; front panel controls: switch for stereo/mono; dimension control; noise-filter switch; four tubes plus two diodes; 9" w. x 8 1/4" d. x 3 1/2" h. ....\$49.95  
Factory wired.....\$69.95

### TEECO

#### Model 285 FM Multiplex Adapter

Response 15-15,000 cps; separation 30 db; hum & noise —65 db; tubes 2—12AU7 plus 2 diodes & 2 silicon rectifiers; controls are: "off-on", separation, and stereo/mono; 4 3/8" l. x 8 1/2" d. x 4 1/8".....\$57.70

## 3 FM Antennas

### APPARATUS DEVELOPMENT

#### FM/Q "Metropolitan"

Designed for city and suburban FM stereo multiplex; broadband yagi; 300 ohms; five

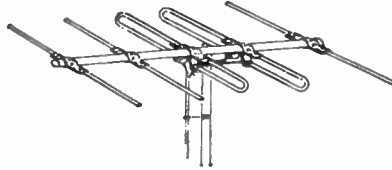

elements; rustproof construction featuring all-aluminum assembly.....\$14.95

#### FM/Q "Dynaplex" Antenna

Broadband coverage 8 1/2" db gain; high front-to-back rejection; 100% rustproof design with all stainless steel hardware; single .....\$32.50  
Two-bay stacked.....\$66.96

#### FM/Q "Junior" Antenna

72 or 300 ohm FM operation; forward gain: 6 1/2 db average; 88 to 108 mc. range; minimum interference and noise pickup; aluminum construction; 65"x67"; 4 1/2" lbs. ....\$19.96

#### FM/Q "Super Mark I"

12-element wideband yagi; delivers optimum gain without booster for highest S/N

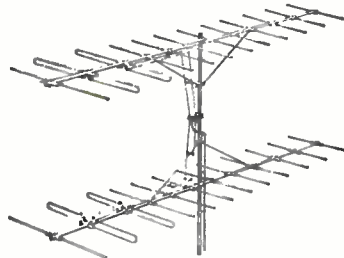

level; stainless steel hardware for rustproof permanence; 12 db gain; 300 ohms..\$49.96  
Two-bay stacked array with stacking harness, 14 1/2 ft. mast, complete installation kit.....\$149.96

#### FM/Q "Long Ranger"

Designed for single-frequency operation in long distance fringe reception; forward gain: 12 db; 10-element yagi design; operating bandwidth: 5 mc.....\$49.96

#### FM/Q Dipole & Reflector

Heavy duty seamless drawn aluminum tubing, hardware, 3 db gain ideal for city and metropolitan reception.....\$7.50

#### FM/Q Crossed Dipole Turnstile

Omnidirectional duo-dipoles for local or city service.....\$10.50

#### FM/Q Cub

Folded dipole FM antenna designed for local service; rugged construction.....\$5.98

#### FM/Q 300/72 Ohm Baluns

Outdoor mast mounting and indoor models designed to be used in converting from the standard 300 ohm to 72 ohm impedances; equipped with BNC coax cable connectors; strong "U" bolt mounting.  
Outdoor .....\$11.95  
Indoor .....\$ 6.98

### B&K

#### Model ST7B FM Antenna

Omnidirectional 7-element design for improved reception of FM multiplex signals;

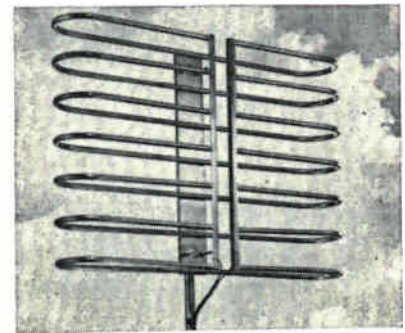

can be used indoors or outdoors; aluminum construction; 30" w. x 22" h. x 5 1/2" d.; comes complete with hardware.....\$24.95

### CHANNEL MASTER

#### 4400G Turnstile Antenna Kit



Omnidirectional; for metropolitan and suburban areas; includes all mounting hardware; 50-foot lead-in; swivel base mount; guy ring and clamp, 50-foot guy wire, etc. ....\$13.75  
4403-G antenna only.....\$ 9.03

#### Model 4401G "Futuramic" Antenna



Same as Model 4402G except 5-element .....\$16.50

#### Model 4402G "Futuramic" Antenna



Directional twin-driven Z-match dipoles; for extreme fringe areas; ten elements .....\$27.65

#### Model 4404G "Futuramic" Antenna

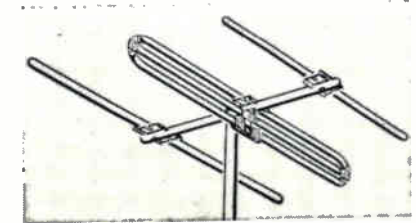

Same as Model 4402G except 3-element .....\$12.50

**Model 4405G "Sigma" Antenna**

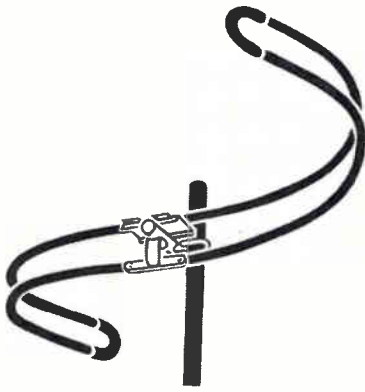

S-type; omni-directional design for metropolitan and suburban reception.....\$7.36

**4406G "Sigma" Antenna Kit**

Same as Model 4405G but includes accessories: 5-foot mast, 50-foot transmission line, swivel base mount, guy ring, 50-foot guy wire, etc. ....\$12.08

**"Omni-Ray" Antennas**

Unique antenna design features bidirectional figure-8 reception pattern which can be



rotated in 22.5° steps; antenna does not move, just reception pattern; beam is aimed for strongest signal pick-up, beam the null to knock out interference; provides strong pick-up of FM stereo stations lying in different directions—without rotator; control console located at set.

Model 3620 stacked antenna with connector rods assembled.....\$34.95

Model 3622G kit, includes stacked antenna, wall mount, mast, special transmission wire & insulators.....\$39.95

Model 3621G single-bay kit with wall mount, mast, special transmission line & insulators .....\$26.95

**Model 4407G FM "Rondo"**

Omnidirectional design using 3 diamond-shaped individual dipoles; maximum gain

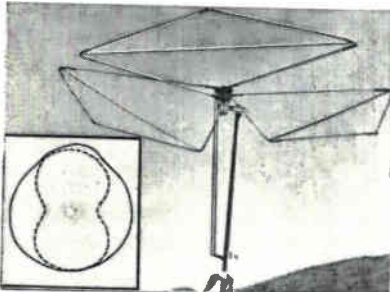

compares favorably with the strongest sides of their turnstile antenna but provides up to 7.4 db more gain than the turnstile antenna's weak side; polar reception pattern is more uniform.....\$15.70

**Model 0023B "Telstar" Booster**

High-gain, antenna-mounted, transistorized booster for FM & TV; has four-set coupler, 117-v. operation.....\$39.95  
Model 0025 Similar in design but for FM only; has 2-set coupler.....\$29.95



*the best seat in the house...*

... and it's right in your living room if your FM is equipped with a

**FINCO® AWARD WINNING FM ANTENNA**

Broadcasting authorities agree that an outdoor antenna is absolutely essential for the reception of full quality monaural and multiplex FM sound.

A FINCO FM antenna will deliver a clean undistorted signal and bring in more stations, regardless of location.

Guarantee yourself the best seat in the house for tonight's FM concert... install a fidelity-phased FINCO FM antenna.

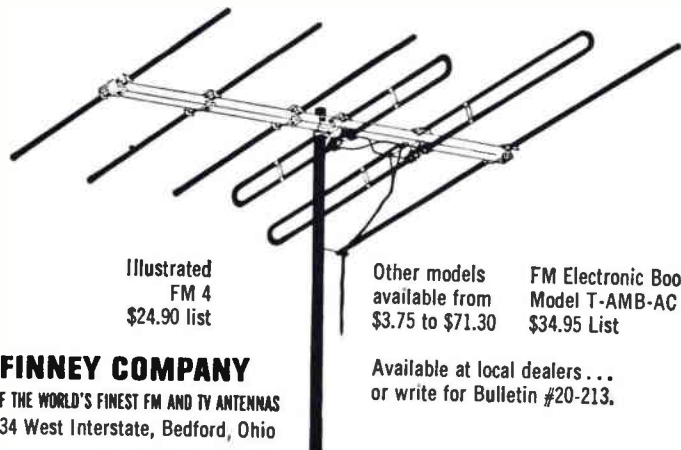

Illustrated  
FM 4  
\$24.90 list

Other models  
available from  
\$3.75 to \$71.30

FM Electronic Booster  
Model T-AMB-AC  
\$34.95 List

**THE FINNEY COMPANY**

PRODUCERS OF THE WORLD'S FINEST FM AND TV ANTENNAS  
Dept. HD, 34 West Interstate, Bedford, Ohio

Available at local dealers...  
or write for Bulletin #20-213.

CIRCLE NO. 23 ON READER SERVICE CARD

# 3 FM Antennas

## FINCO

### Model FM-4G Antenna

Twin drive FM antenna with impedance control "T" match stubs; aluminum construction with gold corrosive-resistant finish "Corodizing"; 6-element, wideband (88 to 108 mc.) yagi.....\$24.90

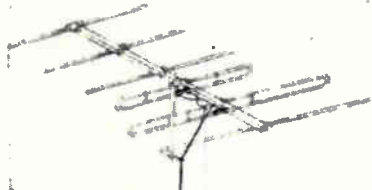

struction with gold corrosive-resistant finish "Corodizing"; 6-element, wideband (88 to 108 mc.) yagi.....\$24.90

### Model FMT-1 Antenna

All-direction FM antenna kit with two folded dipoles at right angles with quarter wave phasing stub for 360 degree pick-up pattern without rotation; supplied with 50 ft. of 300-ohm twin-lead 5 ft. mast, and mounting hardware; gold Corodized; 6 lbs.....\$13.20

### Model FM-2 Antenna

FM antenna kit with folded dipole and reflector; up to 3½ db gain; aluminum construction; supplied with 5 ft. mast, 50 ft. of 300-ohm twin-lead, and mounting hardware; 6½ lbs.....\$14.50  
Model FM-FDR (antenna only).....\$7.23

### Model FM-3 Antenna

Broadband 4 element FM yagi; narrow directivity pattern; aluminum construction; gold Corodized; 5 lbs.....\$13.50

### Model FM-5

10-element deluxe gold Corodized antenna; twin drive elements; maximum gain

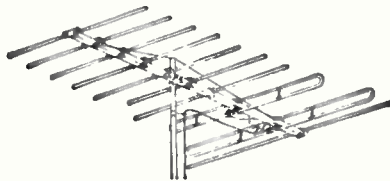

over full FM band; wt. 8½ lbs.....\$36.35

### Model FMT-A

Mounts on TV mast; preassembled, snap-out design; matched for all-directional signal pickup; kit includes FM antenna, 50' twin-lead, 2 mast insulators, 3 screw-in insulators, mounting brackets. Similar to model FMT-1 but mounts on your own TV mast; gold Corodized.....\$13.20  
Model FMT (antenna only).....\$9.95

### Model FM Stereo S



All-direction S-type design; high gain; gold Corodized. ....\$3.75  
SK-Kit includes 50 feet of 300-ohm twin-lead; one mast stand-off insulator; four screw-eye stand-off insulators.....\$5.75

### Bi-directional FM Antennas

Model FM4-4BD—a folded dipole & 2 directors at each end of 10' boom; av. gain

6.5 db.....\$28.95  
Model FM3-3BD—a folded dipole & a single director at each end of 4' boom; av. gain 4.3 db.....\$16.50  
With roof-mount kit.....\$22.50  
With chimney-mount kit.....\$24.60  
Model FM2-2BD—a folded dipole at each end of 3' boom; average gain 3 decibels .....\$11.50  
With roof-mount kit.....\$17.50  
With chimney-mount kit.....\$19.60

### Model T-AMB-AC "Nova-Tron"

Completely transistorized FM booster; will match any Finco antenna; 300-ohm balanced input with output for four TV or

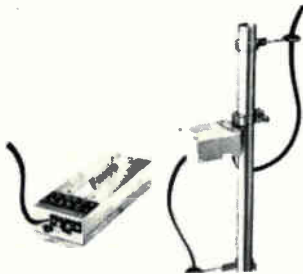

FM sets; gain for 1 set, 15 db; remote power supply at set; a.c.-operated.....\$34.95

## GALLO

### EA-4 FM Antenna

FM indoor antenna-amplifier system; non-directive; 75-ohm coaxial cable output; over-



all gain (98 mc.) 21 db; passband 86-110 mc.; 117 v. a.c. operated; plastic cabinet 6½" x 3¼" x 1½".....\$14.95

## GC ELECTRONICS

### Fringe Master FM Deluxe

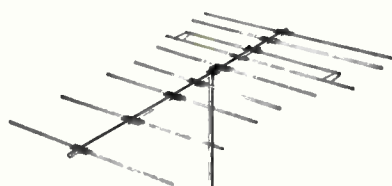

Broadband T-match, 300-ohm design; covers 88-108 mc. & has 8 "solid ssembled" elements .....\$14.10

## JERROLD

### Model FMX FM Range Extender

One-tube, all FM preamp; connects between antenna lead-in and tuner; provides

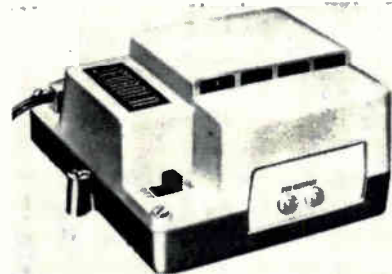

20 db boost; has its own power supply .....\$18.95

### Model DSA-FM FM Antenna Preamp

Mast-mounted outdoor FM preamplifier for reception of distant FM stations; gain 25 db minimum; bandwidth 88-108 mc., frequency response 1 db max. p/v; input impedance 75 or 300 ohms; output impedance 75 or 300 ohms; maximum output 0.5 v. r.m.s.; tubes: 6BQ7A, 6CB6 .....\$99.50

Model 406A Indoor version with same electrical specifications as DSA-FM except for self-contained power supply; 3" x 4" x 10½" .....\$69.95

### Model TX FM Antenna Coupler

Passive-type bandpass filter; separates FM & TV signals from a TV antenna with negligible signal losses; 300-ohm impedance .....\$5.95

### Model APM-101 TV/FM Preamp

Completely transistorized, mast-mounted with remote power supply; input and out-

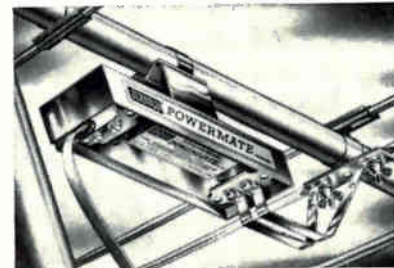

put 300 ohms balanced; basically a TV booster but provides 12 to 18.2 db on FM band; power consumption 3 watts; 2N1742 transistor .....\$39.95

### LPM-102 TV/FM Preamp

Economy version of AMP-101. Similar, but not recommended for areas with strong TV channels .....\$29.95

### Model MF-2 Antenna Coupler

Passive-type which simply divides signal for TV and FM; circuit loss 4 db.....\$4.50

### Model MF-4 Antenna Coupler

Similar to Model MF-2 but will divide into 4 signals, FM or TV.....\$5.75

### TA-24 TV/FM Amplified 4-Set Coupler

Supplies strong signals to as many as four TV and/or FM sets from single antenna. Transistor circuit amplifies signals and provides proper match and isolation. Each set gets 3 to 8 db more signal than it would have received if connected directly to antenna; effective for improving FM stereo signals .....\$24.95

### TA-12 TV/FM Amplified 2-Set Coupler

Similar to TA-24 but supplies signal to only two sets .....\$17.95

### Model ACL-200 "Challenger" TV/FM Broadband Amp

Has high overload capabilities, preventing interference from strong local FM stations;



features single 300-ohm antenna input and choice of 300-75 ohm output; amplifier operates from 117 volts a.c.; circuit uses

two low-noise 6DJ8 frame-grid tubes giving high output with exclusive match in 300-ohm side .....\$64.95

**SRX FM Antenna Amplifier**

Increases FM signal power by 15.5 db average. Extends range of FM stereo reception. Includes input filter which isolates TV from FM signals. May be used with either FM or broadband TV antenna. Two outputs to permit both FM and TV sets to be connected. (Note: May interfere with reception of TV channel 6.) .....\$29.95

**JFD ELECTRONICS**

**AFM100 Antenna Kit**

"Stereo-Cone" antenna with roof mount;

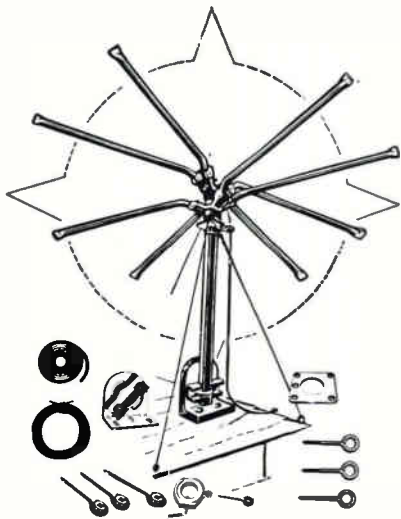

includes misc. hardware; 50 feet of 300-ohm twin-lead; for all-new installations .....\$15.95

**AFM150 Antenna Kit**

Gold-alodized "Stereo-Cone" antenna including misc. hardware; for existing TV-antenna installations.....\$11.95

**AFM175 Antenna Kit**

Same as Model AFM150 but includes 50 feet of 300-ohm twin-lead plus additional hardware .....\$13.95

**AFM200 Folded Dipole Kit**

Gold-alodized stereo folded dipole and reflector kit for all-new installations; in-

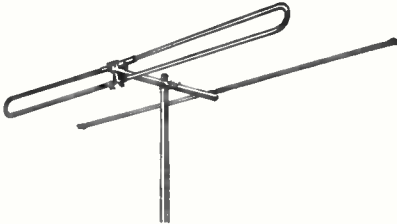

cludes misc. hardware; 50 feet of 300-ohm twin-lead .....\$13.85

**AFM450 "S" Antenna**

Gold-alodized stereo all-direction "S" kit

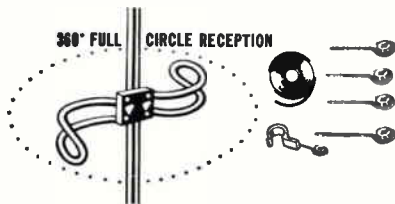

for existing TV-antenna installations \$6.95

**AFM250 Dipole Antenna**

Gold-alodized stereo folded dipole and reflector antenna only.....\$8.60

**AFM475 "S" Antenna**

Gold-alodized deluxe stereo all-direction kit for existing TV-antenna installations .....\$8.95

**AFM350 Yagi Antenna**

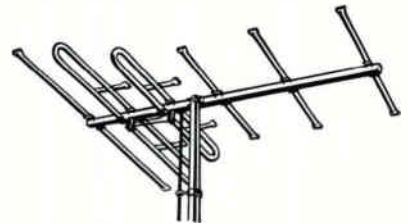

Gold-alodized six-element wide-spaced yagi for fringe FM areas.....\$23.50

**AFM650 Yagi Antenna**

Gold-alodized stereo ten-element wide-spaced yagi for deep fringe FM areas \$32.50

**AFM400 "S" Antenna**

Gold-alodized stereo all-direction "S" kit for new installations; includes misc. hardware, mast, 50 feet of 300-ohm twin-lead, guy wire & base mount.....\$11.95

**Log-Periodic FM Antennas**

Frequency independent full-wave dipole "L" cell. Operates on the fundamental & harmonic modes. Provides 64% more gain than conventional FM yagis. LPL-FM4 4-cell system, up to 125 miles coverage .....\$19.95

**Don't let a "STEREO-DEAF" FM Stereo Antenna Spoil Your FM Stereo Enjoyment**

*Install the New Stereo-Engineered*

**JFD LPL-FM LOG PERIODIC ANTENNA**

- features full-wave log-periodic L-dipole system.
- derived from the powerful logarithmic periodic array used to track America's missiles and satellites through space—discovered by the Antenna Research Laboratories of the University of Illinois.

The all-new JFD LPL-FM antenna is log-periodic engineered to give you the clean gain, directional selectivity, and wideband response your system needs for fidelity FM stereo or mono performance.

The secret is in the full-wave log periodic L-dipole cells that work with amazing frequency-independent efficiency and directivity over the entire 88-108 mc. FM/FM stereo range. Result: the purest FM sound your system has ever reproduced—on every station—up to 175 miles away!

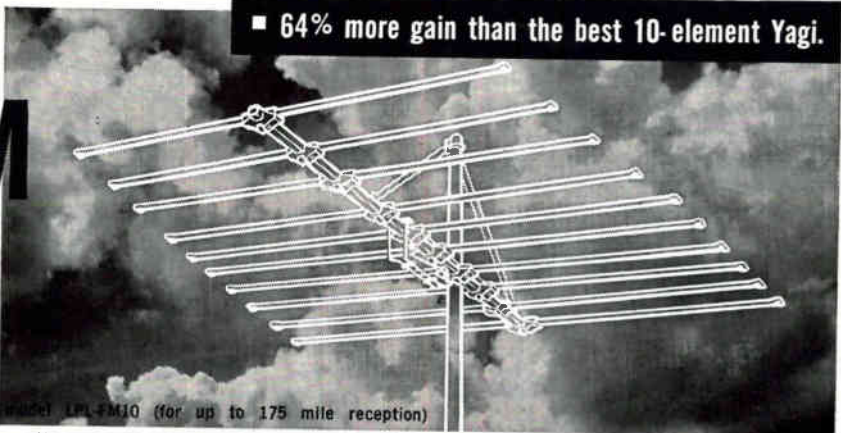

—AND FOR THE ULTIMATE IN MULTI-FM SYSTEM LISTENING . . .



model FT-1 \$34.95, list  
Consists of transistorized  
Amplifier and Power Supply

Install the new JFD FM Antenna Distribution-Amplifier, FT-1, and feed two stereo or mono receivers with sparkling FM. Space-age all-transistor circuitry gives you up to 18 db. of amplification without overloading. No controls or adjustments. Uses standard 117 V.A.C.

Write for the technical specs, charts, patterns and data that tell all.  
**CIRCLE NO. 29 ON READER SERVICE CARD**

**FOUR LPL-FM ANTENNAS TO CHOOSE FROM**

model	range (up to)	list
LPL-FM10 (illustrated)	to 175 miles	\$49.95
LPL-FM8	to 150 miles	\$39.95
LPL-FM6	to 125 miles	\$29.95
LPL-FM4	to 75 miles	\$19.95

**HAVE YOU HEARD ABOUT THE NEW JFD TV/FM SIGNAL SEPARATOR MODEL SS-TVFM?**

It electronically combines your present TV antenna lead-in with the JFD FM Log Periodic lead-in—so only one down-lead is needed. Also—it separates the TV/FM signal of the new combination TV/FM antennas for input to TV set and FM system. only \$5.95, list

**JFD ELECTRONICS CORPORATION**  
15th Avenue at 62nd Street, Brooklyn, N. Y. 11219

# 4 Tape Machines

imum wow & flutter: .06% @ 15 ips, .09% @ 7.5 ips, 18% @ 3.75 ips; timing accuracy 99.8% for synchronous motor; signal-to-noise ratio 56 db @ 15 ips, 54 db @ 7.5 ips, 51 db @ 3.75 ips; overall distortion less than 1.5%; inputs—two high-impedance input channels, mic. or



phono and mic or play; cathode-follower-type output; controls—forward, stop, play/record, thread/idle, stop, rewind switch, bias lock, mic. 1 play, mic. 2 phono, treble, bass, play/record, equalization (three speeds), reel size switch. Model 701 Full-track mono.....\$635.00 Model 702 Half-track mono.....\$525.00 Model 712 Two-track stereo.....\$775.00 Model 714C Four-track stereo with two and four-track stereo playback.....\$795.00 Complete series of players-only available.

## "BX800" "Broadcaster" Series

Record and playback frequency response 30-28,000 cps  $\pm 2$  db @ 15 ips; 30-16,



000 cps  $\pm 2$  db @ 7.5 ips; 30-8000 cps  $\pm 3$  db @ 3.75 ips; direct off-the-tape third head monitor; A-B switch; sound-on-sound with stereo models; "Touch" control with all-electric relay and solenoid operation; remote-control facilities; photocell automatic stop in all functions; standard rack mount; tape speeds 15, 7.5 & 3.75 ips (1 1/2 ips available); handles up to 10 1/2" reels; maximum wow & flutter .06% @ 15 ips, .09% @ 7.5 ips, .18% @ 3.75 ips; timing accuracy 99.8%; signal-to-noise ratio (NAB) 60 db @ 15 ips and 7.5 ips, 55 db @ 3.75 ips; distortion (over-all off tape) less than 1.5%; inputs: two input channels, either low impedance microphone or balanced bridge; output 600-ohm balanced line output and cathode-follower output; controls: push-button—stop, rewind, play, & forward; rotary—mic., phono, record (P and R position), play, A-B, equalization (three speeds); switches—cue, reel size, power on-off; 19" w. x 7 1/2" d. x 14" h. Model "BX801" Full-track mono \$1035.00 Model "BX802" Half-track mono \$ 945.00 Model "BX822" Two-track stereo \$1395.00 Model "BX824" Four-track stereo \$1340.00

**SS1400 Series Solid-State Recorders**  
Accommodates 14" reels, quarter-inch tape, and half-inch and one-inch tape for industrial models. Can be remote-controlled.

Front-panel speed shift, photocell automatic stop in all models; three motors, differential braking; three speeds; adjustable braking to accommodate many different types of tape; wow & flutter .06% @ 15 ips, .09% @ 7 1/2 ips. Synchronous drive motor. Available with either solid-state mono electronics or stereo control center.

- SS1401 Full-track mono.....\$1640.00
  - SS1402 Half-track mono.....\$1550.00
  - SS1422 Two-track stereo.....\$1880.00
  - SS1424 Quarter-track stereo.....\$1880.00
  - SS1444 Four-channel in-line.....\$3320.00
  - SS1483 Three-channel half-inch.....\$3500.00
- Complete series of players-only available.

## DUAL

### TG12A Four-Track Stereo Recorder

Three-speed (1 1/2, 3.75, 7.5 ips) stereo/mono record/playback with dual-channel amplifiers & speakers; has automatic shut-off; response 40-20,000 cps @ 7.5 ips, 40-16,000 cps @ 3.75 ips; signal-to-noise ratio 52 db @ 7.5 ips; wow & flutter .15% @ 7.5 ips; features sound-on-sound & sound-with-sound; 13" x 15" x 10".....\$349.95 TG-12 Deck only.....\$245.00

## DYNACO

### Transistorized Tape Recorder

Imported from B&O of Denmark; fully transistorized, 3-speed complete recorder with built-in power amplifiers; three inputs (200-ohm mike, RIAA equalized phono, radio tuner) mixed via professional-type slide potentiometers; provision for sound-on-sound and echo; two vu meters; hysteresis synchronous motor; separate record and playback heads; tape-input monitoring; preamp output; 40-16,000 cps  $\pm 2$  db; r.m.s. flutter less than 0.075%; peak-to-peak flutter less than 0.2%; S/N ratio 50 db.....\$498.00

## EICO

### Model RP-100 Tape Deck

Provides stereo/mono 1/4-track record, playback, erase; also 1/2-track stereo/mono



playback; speeds 7 1/2" and 3 3/4" ips; takes 7" reels; separate record/playback heads; separate record and playback transistor electronics to monitor while recording; permits sound-on-sound recording; dual meters; push-button controls; rewind and fast forward 1200' per minute; frequency response 30-15,000 cps  $\pm 2$  db at 7 1/2 ips, 30-10,000 cps  $\pm 2$  db at 3 3/4 ips; timing accuracy 0.3%; has automatic end-of-tape switch; wow and flutter under .15% r.m.s. at 7 1/2 ips, under .2% r.m.s. at 3 3/4 ips. ....\$450.00 Model RP-100K (semi-kit includes transport assembled, control electronics and stereo playback amplifiers in kit form) ..... \$299.95

### Model 2400 Tape Recorder

Dual speed (3.75 & 7.5 ips); stereo/mono 1/4-track erase, record & playback; 1/2-track mono playback; has combined erase, record & playback head; response 30-17,000 cps

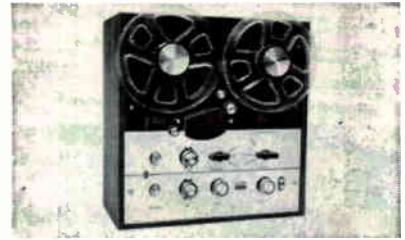

$\pm 3$  db @ 7.5 ips; 30-12,000 cps @ 3.75 ips; wow & flutter .2% @ 7.5 ips; has recording level indicators, counter, mixing mic. & line level controls; end of tape stop; signal-to-noise ratio —45 db @ 7.5 ips; with walnut base; kit .....\$199.95 Factory wired .....\$269.95

## EMERSON

### MM313 Mono Recorder

4-speed (7 1/2, 3 3/4, 1 1/2 & 1 1/8 ips); half-track erase head & half-track record/play-



back head. Has p.a. provision; 4" speaker; ceramic or crystal mic. input; record-level indicator; S/N ratio 40 db; external speaker output 3.2 to 4 ohms; 2 1/2 w. music power output; 8 3/8" h. x 12 1/8" d. x 14 1/8" w. Supplied with ceramic microphone .....\$79.95

### MM314 Mono Recorder

Similar in style & design to Model MM313 except has transistorized amplifiers. Response 50-12,000 cps @ 7 1/2 ips; S/N 45 db. ....\$89.95

### MM316 Mono Recorder

Same as Model MM316 except has digital counter & tone control.....\$99.95

### MM317 Mono Recorder

Similar to Model MM313 except has transistorized amplifiers, ceramic or low-imped-



ance dynamic mic. input; response 50-15,000 cps @ 7 1/2 ips; restyled transport; 8" x 4" speaker; S/N 45 db; vu meter; 8 1/2" h. x 12 1/8" d. x 21" w. Supplied with ceramic mic. ....\$129.95

### SS333 Stereo Recorder

4-track & 2-track stereo record/playback; mono record/playback; 4 speed (7 1/2, 3 3/4, 1 1/2 & 1 1/8 ips); transistorized; dual ampli-



two low-noise 6DJ8 frame-grid tubes giving high output with exclusive match in 300-ohm side .....\$64.95

**SRX FM Antenna Amplifier**

Increases FM signal power by 15.5 db average. Extends range of FM stereo reception. Includes input filter which isolates TV from FM signals. May be used with either FM or broadband TV antenna. Two outputs to permit both FM and TV sets to be connected. (Note: May interfere with reception of TV channel 6.) .....\$29.95

**JFD ELECTRONICS**

**AFM100 Antenna Kit**

"Stereo-Cone" antenna with roof mount;

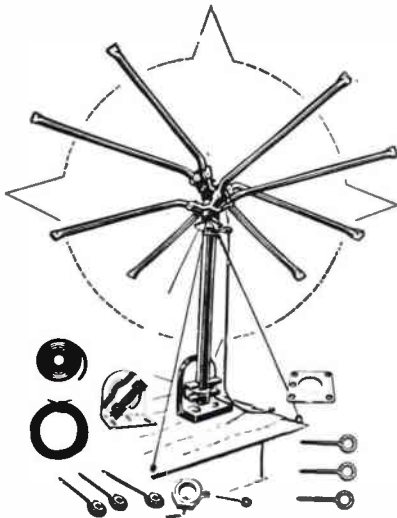

includes misc. hardware; 50 feet of 300-ohm twin-lead; for all-new installations .....\$15.95

**AFM150 Antenna Kit**

Gold-alodized "Stereo-Cone" antenna including misc. hardware; for existing TV-antenna installations.....\$11.95

**AFM175 Antenna Kit**

Same as Model AFM150 but includes 50 feet of 300-ohm twin-lead plus additional hardware .....\$13.95

**AFM200 Folded Dipole Kit**

Gold-alodized stereo folded dipole and reflector kit for all-new installations; in-

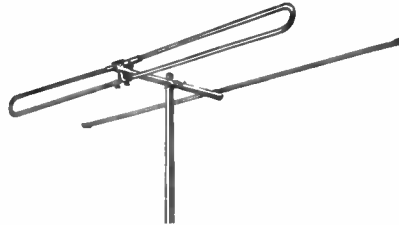

cludes misc. hardware; 50 feet of 300-ohm twin-lead .....\$13.85

**AFM450 "S" Antenna**

Gold-alodized stereo all-direction "S" kit

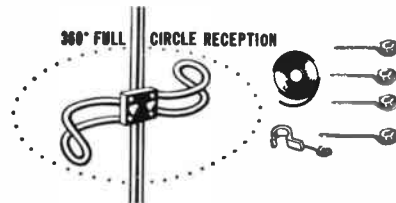

for existing TV-antenna installations \$6.95

**AFM250 Dipole Antenna**

Gold-alodized stereo folded dipole and reflector antenna only.....\$8.60

**AFM475 "S" Antenna**

Gold-alodized deluxe stereo all-direction kit for existing TV-antenna installations .....\$8.95

**AFM350 Yagi Antenna**

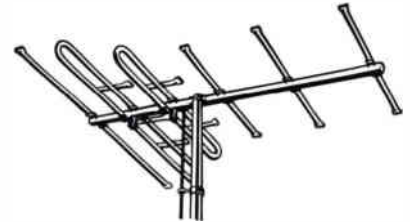

Gold-alodized six-element wide-spaced yagi for fringe FM areas.....\$23.50

**AFM650 Yagi Antenna**

Gold-alodized stereo ten-element wide-spaced yagi for deep fringe FM areas \$32.50

**AFM400 "S" Antenna**

Gold-alodized stereo all-direction "S" kit for new installations; includes misc. hardware, mast, 50 feet of 300-ohm twin-lead, guy wire & base mount.....\$11.95

**Log-Periodic FM Antennas**

Frequency independent full-wave dipole "L" cell. Operates on the fundamental & harmonic modes. Provides 64% more gain than conventional FM yagis. LPL-FM4 4-cell system, up to 125 miles coverage .....\$19.95

**Don't let a "STEREO-DEAF" FM Stereo Antenna Spoil Your FM Stereo Enjoyment**

*Install the New Stereo-Engineered*

**JFD LPL-FM**

**LOG PERIODIC ANTENNA**

- features full-wave log-periodic L-dipole system.
- derived from the powerful logarithmic periodic array used to track America's missiles and satellites through space—discovered by the Antenna Research Laboratories of the University of Illinois.

The all-new JFD LPL-FM antenna is log-periodic engineered to give you the clean gain, directional selectivity, and wideband response your system needs for fidelity FM stereo or mono performance.

The secret is in the full-wave log periodic L-dipole cells that work with amazing frequency-independent efficiency and directivity over the entire 88-108 mc. FM/FM stereo range. Result: the purest FM sound your system has ever reproduced—on every station—up to 175 miles away!

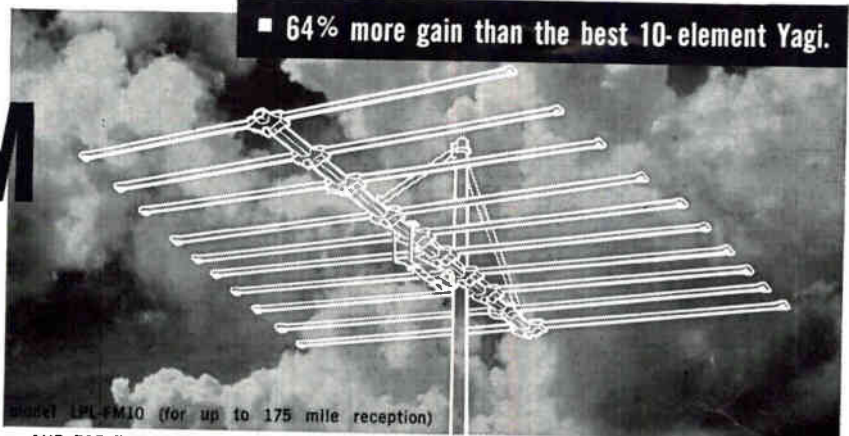

Model LPL-FM10 (for up to 175 mile reception)  
—AND FOR THE ULTIMATE IN MULTI-FM SYSTEM LISTENING...



model FT-1 \$34.95, list  
Consists of transistorized Amplifier and Power Supply

Install the new JFD FM Antenna Distribution Amplifier, FT-1, and feed two stereo or mono receivers with sparkling FM. Space-age all-transistor circuitry gives you up to 18 db. of amplification without overloading. No controls or adjustments. Uses standard 117 V.A.C.

Write for the technical specs, charts, patterns and data that tell all.

**FOUR LPL-FM ANTENNAS TO CHOOSE FROM**

model	range (up to)	list
LPL-FM10 (illustrated)	to 175 miles	\$49.95
LPL-FM8	to 150 miles	\$39.95
LPL-FM6	to 125 miles	\$29.95
LPL-FM4	to 75 miles	\$19.95

**HAVE YOU HEARD ABOUT THE NEW JFD TV/FM SIGNAL SEPARATOR MODEL SS-TVFM?**

It electronically combines your present TV antenna lead-in with the JFD FM Log Periodic lead-in—so only one down-lead is needed. Also—it separates the TV/FM signal of the new combination TV/FM antennas for input to TV set and FM system, only \$5.95, list

**JFD ELECTRONICS CORPORATION**  
15th Avenue at 62nd Street, Brooklyn, N. Y. 11219

**What  
do you hear  
from your  
FM?**

**Just as much as your FM  
antenna lets you hear!**

**That's a fact.**

The antenna built into your FM receiver can pull in only very close stations. And it may not do that with always complete clarity. If you'd like to tune in more (and more distant) FM stations clearly, you definitely need a high gain outdoor FM antenna. Kitchen table model or expensive stereo rig, the story's the same.

FM stereo, in fact, is a *weaker* signal than monaural FM; it "cries for" an antenna. A directional antenna, too, for clean FM stereo reception, since your built-in antenna pulls in signals from *all* directions and may lose your stereo effect.

Inexpensive, lasting solution! The totally new RCA 500 FM antenna just developed by experts with long, long electronics experience. This 8-element yagi-type antenna receives 88 to 108 MC, has a VSWR of 1.25:1 and a flat-frequency response across the entire band with an average 8 db gain. Acute directivity removes interference.

Your RCA dealer will happily explain in words of one syllable what better things you'll hear from your FM with an RCA 500 FM antenna. **Listen!**

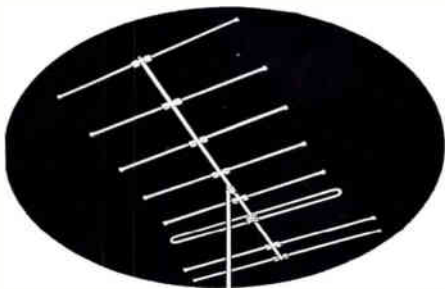

**RCA Parts and Accessories**



**The Most Trusted Name  
in Sound**

CIRCLE NO. 68 ON READER SERVICE CARD

## 3 FM Antennas

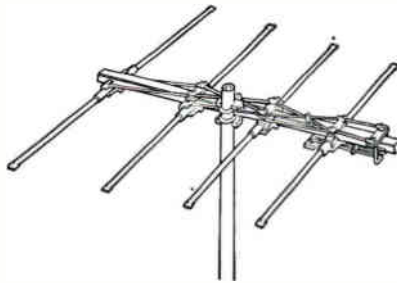

LPL-FM6 6-cell system, 125 miles....\$29.95  
LPL-FM8 8-cell system, 150 miles....\$39.95



LPL-FM10 10-cell system, 175 miles \$49.95

### RCA

**Model 500 FM Antenna**  
Eight-element, yagi-type antenna; v.s.w.r.



1.25:1; flat frequency response across entire band; average 8 db gain.....\$24.00

### TACO

**Model 615 Bi-Directional Yagi**  
Bi-directional yagi for stereo multiplex reception; designed especially for locations where signals are desired from two approximately opposite directions.....\$12.95

**610 Ten-Element Yagi**  
Similar to 644B but with gain of 8-9½ db.  
Silver aluminum.....\$30.70  
Gold anodized.....\$36.70

**650 Dipole Reflector Antenna**  
Folded dipole with reflector for medium to low signal-strength areas.....\$7.50  
650M includes antenna & 1¼" x 5' aluminum mast.....\$9.75

**GC677M Turnstile Antenna**  
Omnidirectional (360°); for metropolitan areas; gold permanized finish.....\$10.95  
KC677M mounting kit including antenna, 5' x 1¼" aluminum mast, guy wire, 50' lead-in, base mount, guy anchor.....\$17.95

**644B Six-Element Yagi**  
For fringe & multi-path problem areas; has

74

high gain & broadband coverage; gain over 7 db.  
Silver aluminum.....\$21.20  
Gold anodized.....\$26.20

**FMP-8 Eight-Element FM Paralog**  
High-gain, narrow-lobe Paralog for fringe areas. Unusually flat response and excellent front-to-back ratio. Designed for FM to prevent multi-path problems, eliminate hiss, and provide full-separation stereo....\$29.95

**FMP-10 Ten-Element FM Paralog**  
Similar to FMP-8, but higher gain. For deep fringe areas .....\$39.95

**FMP-16 Sixteen-Element FM Paralog**  
Similar to FMP-8 but much higher gain .....\$59.95

**G626-A "S" Antenna**  
Omnidirectional (360°); for metropolitan existing mast; gold anodized; designed for



25 mile coverage.....\$6.95  
KG262-A mounting kit including antenna, 50' lead-in, stand-off & 3 stand-off insulators .....\$8.95  
KBG626-A mounting kit including antenna, 1" x 4' gold iridized bi-mount, 50' lead-in, support legs & stand-offs.....\$12.50

### WINEGARD

**SF-8 FM Antenna**  
High-gain, directional FM and FM stereo antenna for deep fringe and fringe area

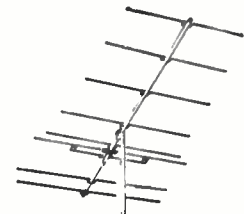

reception; average gain of +8 db across entire FM band; v.s.w.r. of 1.25:1 assures good impedance match; sharp directivity, high front-to-back ratio with absence of interfering side lobes; gold anodized elements with iridized hardware.....\$23.65

**AP-320 Stereotron Amplifier**  
FM antenna preamplifier designed to boost the signal by a minimum of +18 db; two 13CW4 nuvistors are used; mounts directly on driven element of antenna; built-in two-set coupler and a.c. receptacle on power supply; 300 ohms in and out.....\$39.95

**FM3A "Turnstile"**  
Non-directional FM antenna for local and primary reception areas; gold anodized



STEREO/HI-FI DIRECTORY

elements; complete kit includes antenna, universal roof mount with leak-proof fasteners; 50' of 300-ohm twinlead; and all mounting hardware.....\$18.85

**AP-375 Stereotron Amplifier**

Same as Model AP-320 but 75 ohms in and out for use with coax cable.....\$44.95

**FM3T Offset "Turnstile"**

Antenna only; same as Model FM3A but with offset mount; up to four bays can be stacked without using stacking bars \$12.50

**FR-1K FM "Ranger" Antenna**

Non-directional FM antenna for local and primary reception areas; gold anodized ele-

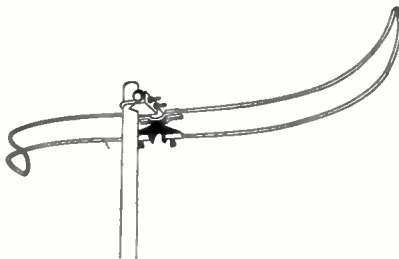

ments and iridized hardware; offset mount for easy installation on mast with TV antenna or on separate mast; wrap-around mast clamp; complete kit includes antenna, 50' 300-ohm twinlead, and 3 stand-offs.....\$8.95

**Model FR-1**

Antenna only, same as Model FR-1K \$6.95

**RD-300 "Red-Head" Amplifier**

Transistorized FM antenna preamplifier for fringe areas; designed to boost signal by an average of +18 db; fully protected against damage due to lightning flashes, static discharges, and power line surges; v.s.w.r. better than 1.5:1; mounts on any antenna mast or side of house; built-in two-set coupler; housed in red polystyrene case.....\$29.95

**CA-FMB Coupler**

Designed to couple a TV and an FM antenna on the same mast with a single downlead and to split the signal to run separate lines to the TV and FM sets; TV & FM are isolated from each other; insertion loss .5 db on TV and 1 db on FM; housed in waterproof high-impact polystyrene case; can be mounted with stainless steel bracket or mounting screws provided.....\$4.50

**FM-318 FM "Supercharger"**

Boosts FM signal 8 times. For secondary fringe & deep fringe areas. Transistorized

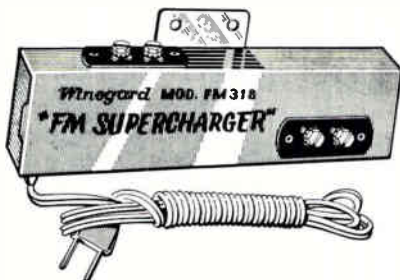

design with 17 db min. gain & 300 ohms input & output. Response flat  $\pm 1/2$  db, 88-108 mc.....\$17.95

**TR2-13 General-Purpose Trap**

Designed to attenuate any selected frequency in the v.h.f. TV-FM bands for the purpose

of eliminating interference without affecting adjacent frequencies; can be used to attenuate strong local TV station overriding a weak FM station; consists of three independent traps which together cover entire v.h.f. TV-FM spectrum; any trap can be used individually or in conjunction with the others; housed in waterproof high-impact polystyrene case; can be mounted on mast or inside; 300 ohms in and out.....\$7.50

**K2-FM Antenna**

FM directional antenna for local and suburban reception areas; ideal for use with a



rotor for close-in areas; factory pre-assembled; has wrap-around mast clamp.....\$5.05

**K5-FM Antenna**

FM directional antenna for primary and near fringe reception areas; high-gain 5-

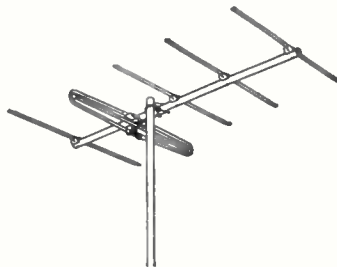

element yagi; ideal for use with a rotor; factory pre-assembled; has wrap-around mast clamp.....\$13.80

**TR7-213 Trap & High-Pass Filter**

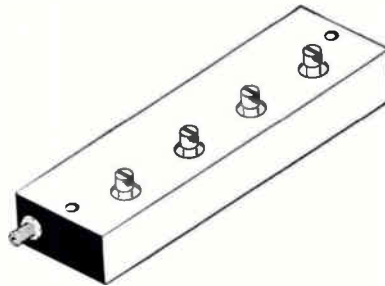

Similar to Model TR2-13 but 75 ohms in and out for use with coax cable.....\$19.95

**EC-230 Color-Coupler**

Transistorized two-set coupler designed to split signal to run separate lines to TV and

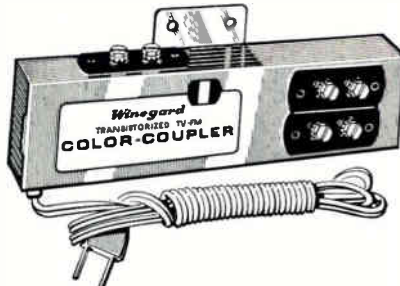

FM sets without signal loss; minimum of +7 db gain provides enough signal for each outlet, even in deep fringe areas; each outlet isolated from the other by 15 db; can also be used for two TV or two FM sets; mounts on wall.....\$17.95

**HOW GOOD IS THIS WINEGARD FM STEREOTRON ANTENNA?**

**SO GOOD IT'S GUARANTEED!**

**GUARANTEED** to be the most effective, best built FM antenna made —

**GUARANTEED** to bring in 85% of all FM stations in a 200 mile radius when used with the Stereotron antenna amplifier

**GUARANTEED** you will be 100% satisfied or your money back.

The Winegard Stereotron FM antenna will improve the performance of even the most expensive FM or FM stereo tuner. It is the most powerful receiving device you can own and will bring in FM signals up out of the hiss and noise with utmost clarity. Stereotron has an exceptionally high front to back ratio which shuts out multi-path distortion. Has extremely high gain and is highly directive.

If you want the very finest in FM or FM stereo sound, get a **GUARANTEED Stereotron** today.

**STEREOTRON ANTENNA Model SF-8** — \$23.65. Stereotron nuvistor amplifier Model AP-300—input 300 ohms, output 300 ohms. Can be used with any FM antenna—\$39.95.

Amplifier Model AP-375 for use with coax cable, input 300 ohms, output 75 ohms — \$44.95

Write now for technical specs, gain charts, polar patterns, VSWR, etc., and get **FREE FM STATION LOG AND MAP.**

*World's most complete line of FM and TV antennas, FM-TV couplers and amplifiers.*

**Winegard Co.**

D-3018-A Kirkwood Blvd., Burlington, Iowa  
CIRCLE NO. 67 ON READER SERVICE CARD

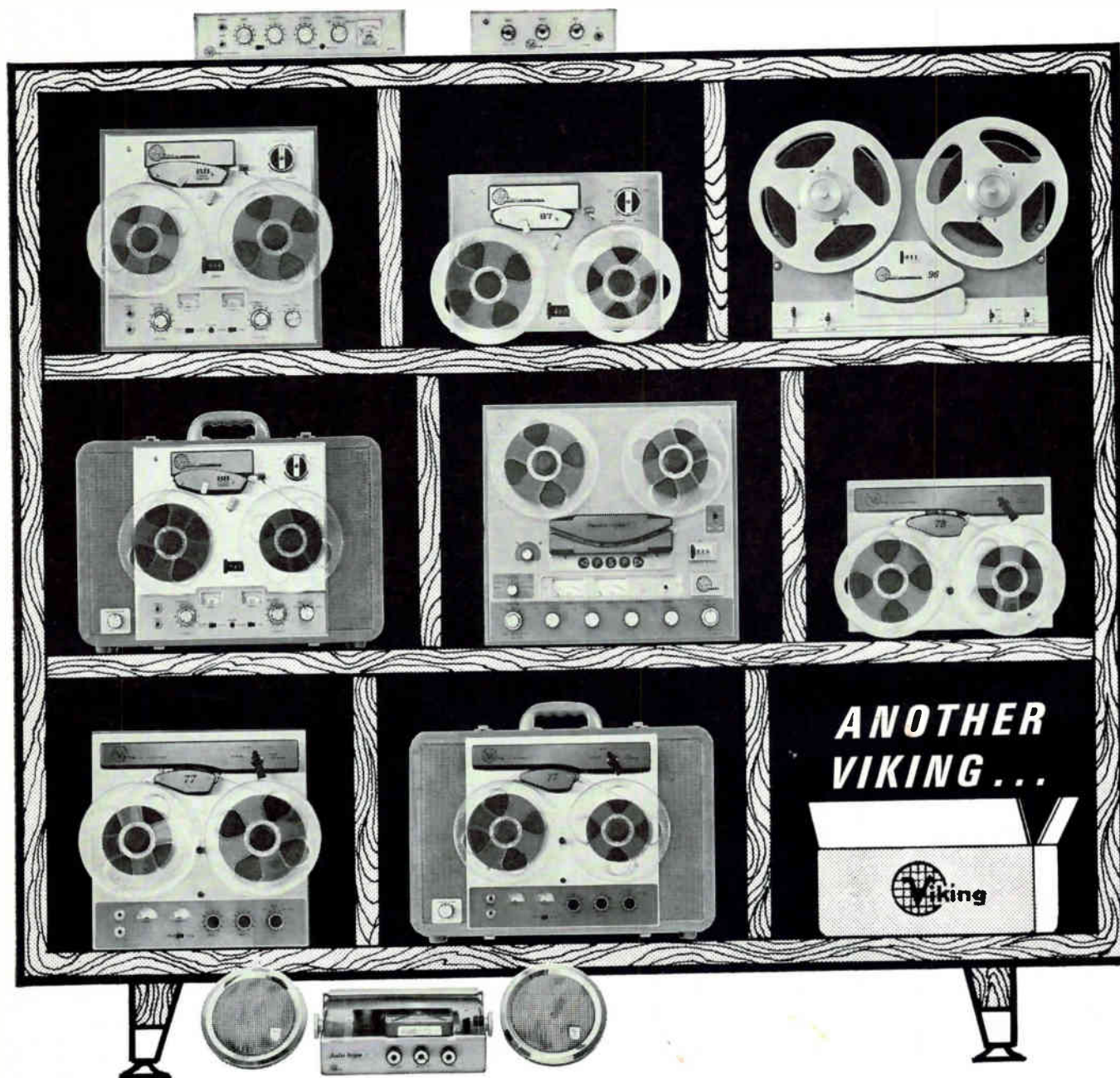

**ANOTHER  
VIKING...**

## AND ANOTHER...

ever felt confused about adding tape to your music system?

It's really quite simple. Jaunt over to your Viking dealer. He'll cheerfully explain the virtues of tape recording. And he'll show you a Viking model designed to play tape, or to record and

play, or to play forward and reverse — automatically.

Then you pick the Viking model you like best with complete confidence because you know that each is **MADE BY SKILLED AMERICAN CRAFTSMEN.**

RP83 Amplifier PA94 Amplifier  
88 Stereo Compact 87 Tape Transport Studio 96  
880 Portable Stereo Compact Retro-Matic 220 78 Tape Transport  
77 Stereo Compact 770 Portable Stereo Compact  
Auto-Tape 500



**Viking** OF MINNEAPOLIS, INC.

9600 Aldrich Avenue So. Minneapolis, Minn. 55420

CIRCLE NO. 64 ON READER SERVICE CARD

RECORDERS	}	.....77
PLAYERS		
TRANSPORTS		
TAPE ACCESSORIES		.....106
RAW TAPE		.....110

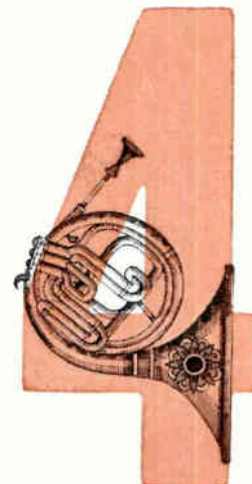

# TAPE MACHINES

*Special Feature*

## Q & A ON HI-FI TAPE RECORDERS...94

### AMERICAN GELOSO

#### TR-711 Portable Recorder

Transistorized; dual-speed (3 3/4 & 1 1/2 ips), dual-track mono design. Response 100-6000



cps. .25 w. output; S/N 20 db; wow & flutter .5%. Has combination level & battery condition meter; 2 1/4" speaker. Features monitor facilities when recording; 2 hrs. recording time; uses 6 penlight cells for life of 30 hrs. Supplied with remote-control mic, dual earphone & carrying case. 2" x 6" x 7". Optional equipment includes 117-v. a.c. adapter, telephone pickup & others; less Fed. Ex. Tax.....\$199.95

#### G3-10 Tape Recorder

3-speed (3 3/4, 1 1/2 & 1 5/16 ips), dual-track mono; 117-v. operation. Features 5" reel,



counter, level meter. Response 50-12,000 cps; S/N 50 db; wow & flutter .2%. Supplied with remote-control mic but is available with either remote foot pedal or hand controls and earphone; 6" h. x 8" x 12", wt. 13 lbs; less Fed. Ex. Tax.....\$249.95

#### 61 Portable Recorder

Transistorized, mono, battery or a.c. operated; dual speed (1 1/2 & 3 3/4 ips); vu meter, battery condition indicator; radio & mic. inputs; has provision for projector synchronizer. Response 80-7000 cps; S/N 20



db; wow & flutter .3%; 150 mw. output. 2 3/4" x 6" x 7"; wt. 5 lbs. Supplied with dynamic mic, earphone; batteries & carrying case.....\$179.95

#### 4-10 Tape Recorder

3-speed (3 3/4, 1 1/2 & 1 5/16 ips); transistorized, 117-v. operation; 5" reel; mono de-



sign. Response 40-12,000 cps @ 3 3/4 ips; S/N 50 db; wow & flutter .2%; 2.5 w. output. Features output jacks for monitoring, earphone, ext. spkr.; input jacks for remote mic., radio, remote foot pedal, telephone pickup, counter, vu meters. 12 3/4" w. x 5" h. x 11" d. wt. 12 1/2 lbs. Supplied with remote-control mic.....\$269.95

#### G-258/A Tape Recorder

3-speed (3 3/4, 1 1/2 & 1 5/16 ips) mono, 117-v., dual-track design. Response 50-12,000 cps; S/N 50 db; wow & flutter .2%. Has level meter, counter & uses 5" reel. 13 1/2" x 8 1/2" x 6". Appearance similar to Model 3-10. wt. 6 lbs. Supplied with mic..\$199.95

### AMPEX

#### PR-10 Series Tape Recorders

Two-speed compact design with 4-position head assembly with separate erase, record & playback heads; extra position for optional 4-track stereo playback or special requirements; has 3" vu meters; response 30-15,000 cps ±2 db @ 15 ips, 40-12,000 cps @ 7.5 ips, 40-6000 cps @ 3.75 ips; signal-to-

noise ratio 55 db @ 15 & 7.5 ips (half-track or 2-track), 50 db @ 3.75 ips; wow & flutter .15% @ 15 ips, .18% @ 7.5 ips, .25% @ 3.75 ips; output +4 dbm into 600-ohm balanced or unbalanced load; rack space: transport 8 3/4" x 19" x 6" d.; electronics 5 1/4" x 19" x 5 5/8" d.

Model PR-10-1 full or half-track; single channel electronics include built-in mixer to mix line and mic or two mics; has two inputs—low-imp. microphone & unbalanced bridging with provisions for plug-in line transformer or low-imp. plug-in microphone preamp; without case.

Cat. #96001-09 full track 7.5 & 15 ips. ....\$1045.00

Cat. #96001-03 half track 3.75 & 7.5 ips. ....\$1045.00

Cat. #96001-01 half track 7.5 & 15 ips. ....\$1045.00



Model PR-10-2 two channel, fits same rack space as PR-10-1; stereo or mono recording; has one input per channel; inputs are unbalanced bridging with provision for plug-in line transformers or low-impedance plug-in mic. preamps; features sound-on-sound, cue tracks, and other special effects. Cat. #9600-03 two track, 3.75 & 7.5 ips. ....\$1245.00

Cat. #96000-01 two track 7.5 & 15 ips. ....\$1245.00

Remote control (in box with 30' cord) .....\$75.00

Cat. #4018004-01 four track 3 3/4 & 7.5 ips.

Has three 4-track record-erase-playback heads, a 2-track playback head & a head switch. Has 1 line input for each channel. Microphone preamps or line transformers may be used with line inputs.....\$1295.00

#### Model 2015 Speaker System

Designed to match 1000 & 2000 series tape recorders. Has 8" extended-range & 3" tweeter speakers with crossover at 2000 cps. Ported design with high-freq. attenuator & 15' cord. Available in walnut cab. with charcoal or cane grille cloth.....\$79.00 each

#### "Fine Line" F-44 Series Recorders

Four-track stereo and mono recorder/player; records 4-track stereo & mono; plays 4-track stereo and 4-track mono half-track and full-track tapes; has three separate heads, erase, record, playback; automatic set

# 4 Tape Machines

shut-off actuated by end of tape; dual speed 7.5 & 3.75 ips; record/playback response 50-15,000 cps  $\pm$  2 db @ 7.5 ips; signal-to-noise ratio better than 53 db @ 7.5 ips; flutter & wow under 0.15% @ 7.5 ips; outputs approx. 1 v. r.m.s. from cathode-follower.

Model F-4450 unmounted deck with record/playback preamplifiers.....\$549.50  
Model F-4460 tape deck mounted in port-



able brown luggage case; includes record/playback preamplifiers.....\$595.00  
Model 4470 tape deck with pair of low-level



amplifiers & speakers mounted in portable brown luggage case.....\$695.00

## Model UST-4 Tape Recorder

2-speed 7½ & 3¾ ips; records 4-track stereo & mono; plays 4-track stereo half-



track & mono. Has built-in amplifiers & twin 5" x 7" speakers. Response 50-15,000 cps  $\pm$  4 db @ 7½ ips; flutter & wow .2% @ 7½ ips; S/N 42 db. Power output 6 w. peak, 3.2 ohms. Preamp output 1 v. high impedance. Has 2 high-impedance mic. inputs & 2 high-impedance radio-phono. Features edit (pause) control for setting recording levels prior to recording. Will play in vertical and horizontal positions.....\$299.00

## Model 1000 Series Tape Recorders

3-speed (7½, 3¾, 1½ ips) design featuring semi-automatic reverse. A manually operated switch permits reverse direction play at any point on the tape. Has automatic shutoff at the end of reel. digital counter, transistorized stereo preamps & power amplifiers; built-in speakers. Records 4-track stereo & mono; plays 4-track stereo & mono, half-track mono & full-track mono. Response 40-17,000 cps  $\pm$  3 db @ 7½ ips; S/N 49 db @ 7½ ips; power output 4 w./ch. continuous r.m.s.; flutter & wow



.12%. Model 1050 tape deck with stereo preamps for custom installations....\$349.00  
Model 1070 portable self-contained system, brown vinyl-clad wood cabinet, carrying handle, dust cover; and one high-impedance omnidirectional dynamic mic.....\$399.00  
Model 1080 same as Model 1050 except has walnut cabinet.....\$369.00

## Model 1015 Speaker System

Matching design for 1000 & 2000 series recorders. Has 5½" woofer, 5½" wide-range & 2½" tweeter with 400-cps crossover. Ported design with 2-position attenuator sw. & 15' cord. 17½" x 13" x 4½". Available in walnut cabinet with charcoal or cane grille cloth.....\$89.00 pair

## Model 2000 Series Tape Recorders

3-speed (7½, 3¾ & 1½ ips) design featuring automatic tape threading, automatic



end-of-reel tape reverse, and manual switch for tape reverse at any time desired. Machine adds inaudible pulse onto any tape which is then used to actuate end-of-reel reversal. 2400' tape at 3¾ ips will provide 6 hr. of continuous play. Has automatic shutoff and optional slide-projector actuator, built-in preamps, power amps & speakers. Records 4-track stereo & mono, plays 4-track stereo & 4-track, half-track & full-track mono. Response 30-18,000 cps  $\pm$  2 db @ 7½ ips; S/N 52 db @ 7½ ips; power output 8 w./ch. continuous r.m.s. Flutter & wow .08% @ 7½ ips. Model 2050 tape deck with stereo preamps for custom installation.....\$439.00

Model 2070 portable self-contained system; black vinyl-clad wood cabinet, carrying handle, dust cover & one omnidirectional mic.....\$499.00  
Model 2080 same as Model 2050 except has walnut cabinet.....\$469.00

## Model 622 Portable Speaker/Amp

Designed for use with Model 602 Series re-



recorder; 10-watt amplifier with frequency response of 20 to 20,000 cps  $\pm$  0.5 db; hum and noise 70 db below 10 watts; harmonic distortion less than 1%; speaker frequency response: 65 to 10,000 cps; level and tone controls; a.c. convenience outlet; external speaker jack bypasses internal speaker; input impedance 20,000 ohms; output impedance 12 ohms; 13" x 16" x 8".....\$189.50

## Model 602-2 Stereo Recorder

Stereophonic tape recorder using Model 602-1 tape transport and two Model 602-1

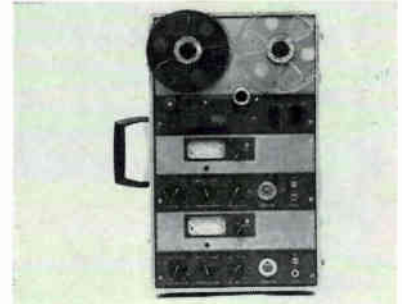

electronic chassis for stereo record/playback; two-track erase head, record and playback heads; all performance specifications identical to Model 602-1.

Cat. # 6022-01 7.5 ips, portable case.....\$875.00  
Cat. # 6022-07 3.75 ips, portable case.....\$875.00  
Cat. # 6022-02 7.5 ips, supplied unmounted.....\$795.00

## Model 2044 Amplifier/Speaker

For use with F-44 Series tape units; includes 10-watt power amplifier, woofer, tweeter, and crossover network in a brown portable



luggage case; response 70-13,000 cps essentially flat.....\$179.50

## Model 602-1 Mono Recorder

Full-track or half-track recorder; 3 heads; erase, record, playback; frequency re-



sponse: 40 to 15,000 cps, 40 to 10,000 cps  $\pm$  2 db, no more than 4 db down at 15,000 cps; wow and flutter under 0.17% r.m.s.; signal-to-noise ratio: full track, over 57 db below peak recording level at 3% total harmonic distortion; half track, over 55 db; vu meter; separate record and playback preamplifiers; reel size: 7"; timing accuracy:  $\pm$  3.6 seconds in 30 minute recording; microphone and high level inputs with full mixing provisions; vertical or horizontal operation; separate playback preamp permits instantaneous comparison between incoming program material and

actual recording; headphones jack; output: +4 dbm into 600 ohm load from tapes recorded at program level.

- Cat. #602-01 Half-track, 7.5 ips, portable case .....\$625.00
- Cat. #602-17 Half-track, 3.75 ips, portable case .....\$625.00
- Cat. #602-03 Half-track, 7.5 ips, un-mounted .....\$575.00
- Cat. #602-02 Full-track, 7.5 ips, portable case .....\$625.00
- Cat. #602-04 Full-track, 7.5 ips, un-mounted .....\$575.00
- Cat. #602-04 Full-track, 3.75 ips, un-mounted .....\$575.00

**AMPLIFIER CORP.**

**Model 312 "Transflyweight" Transistorized Recorders**

Operates from small dry replaceable or rechargeable batteries; multi-purpose vu



meter; battery-operated amplifier; single head for recording and playback; 5" reel; rewind indicator; 8 lbs.; attache carrying case.

- Model 312-AV Dual-track; 15/16 ips; 50-2500 cps; flutter 0.25%.....\$488.00
- Model 312-BV Dual-track; 1 1/8 ips; 50-4000 cps; flutter 0.2% .....\$438.00
- Model 312-CV Dual-track; 3.75 ips; 50-7500 cps; flutter 0.15% .....\$448.00
- Model 312-TDV Dual-track; 7.5 ips; 50-10,000 cps; flutter 0.1% .....\$458.00
- Model 312-SDV Single-track; 7.5 ips; 50-10,000 cps; flutter 0.1% .....\$458.00
- Model 312-EV Single-track; 15 ips; 50-15,000 cps; flutter 0.1% .....\$498.00
- With aluminum case add .....\$ 31.00

**Model 312-ST "Transflyweight" Stereo Recorder**

Portable design; battery operated; will record and play back stereo or mono; 1/4

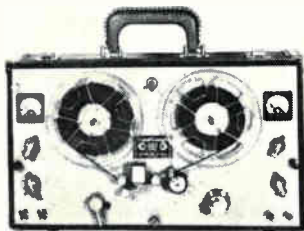

track; 5" reel size; single play/record head; response 50-10,000 cps ± 2 db @ 7.5 ips; signal-to-noise ratio 55 db; wow and flutter .1% @ 7.5 ips; microphone (50/200 ohm) only input per channel with 4 millivolts sensitivity; (15,000 ohm) 2.5 v. output per channel; has 30 transistors; built-in vu meters for each channel; rechargeable batteries; single-speed (15/16, 1 1/8, 3.75, 7.5, or 15 ips) design; prices range from \$624.00 to \$684.00. 110 volt a.c. power pack.....\$30.00

**Model 612 "TransMagnetite" Transistorized Recorders**

Transistorized portable tape recorder; spring-wound motor; multi-purpose vu meter; battery-operated amplifier; 5" reel size; rewind indicator; 17 lbs.

- Model 612-AV Dual-track; 15/16 ips; 300-



- 2500 cps; flutter 0.25% .....\$495.00
- Model 612-BV Dual-track; 1 1/8 ips; 100-3000 cps; flutter 0.2% .....\$445.00
- Model 612-CV Dual-track; 3.75 ips; 50-7500 cps; flutter 0.15% .....\$455.00
- Model 612-TDV Dual-track; 7.5 ips; 50-10,000 cps; flutter 0.1% .....\$465.00
- Model SDV Single-track; 7.5 ips; 50-10,000 cps; flutter 0.1% .....\$465.00
- Model 612-EV Single-track; 15 ips; 50-15,000 cps; flutter 0.1%.....\$505.00
- In weatherite sealed aluminum case add. ....\$ 50.00

**BELL**

**Model T-347 Tape Recorder**

Includes dual-channel record/playback pre-amps; does not have power amps or speakers; records & plays back 4-track mono or stereo; has built-in variable echo for any desired reverberation; provides "Duo-Sound" permitting any mono program to be recorded on second channel; features two speeds (7.5 & 3.75 ips), sound-on-sound, 3 motors, vu meters, counter, 3 separate 1/4-track heads (record, playback & erase); response 40-16,000 cps ± 3 db @ 7.5 ips, 40-12,000 cps ± 3 db @ 3.75 ips; signal-to-noise ratio better than 50 db @ peak recording (3% HD); flutter less than .2% @ 7.5 ips; 15 1/4" w. x 13 1/2" front-to-back, 5" below mounting surface & 2" above.....\$319.95

- Model T-310 Tape transport, mono record/playback (preamplifier not included) .....\$149.95
- Model T-333 Tape transport, 4-track stereo record/playback (or 2-track stereo playback (preamplifier not included) .....\$179.95

**Model RT-360 Duplicator/Recorder**

Features "Duo-Sound", echo effect, sound-on-sound & tape duplication; (stereo &



mono program material can be transferred from one tape to a blank tape); has 3 separate 1/4-track heads (erase, playback, record); index counter; automatic end-of-tape stop; 4 w./ch. power amplifiers & two removable cover-mounted 6" x 9" speakers; response 40-16,000 cps ± 3 db @ 7.5 ips; signal-to-noise ratio 50 db at peak record signal (3% HI); wow & flutter less than .2% @ 7.5 ips; input sensitivity: aux. 3 mv., mic. 3 mv., mag. phono 12 mv.: will record/playback 4-track stereo/mono @ 7.5 or 3.75 ips .....\$449.95

- DK-1 Consists of two separate heavy-duty 4-pole, 4-coil motors to permit use of 10 1/2" reels and self-duplicating function on RT-360.....\$49.95
- Low-impedance headphones.....\$29.95
- Wide-range microphone.....\$20.00

**BRENELL**

**Mark IV & IVB Tape Decks**

Tape deck chassis; dual track; takes up to 4 heads for record, playback, and erase; 3 speeds; 3 motors; frequency response: 3.75 ips, 50 to 6000 cps; 7.5 ips, 50 to 12,000 cps; 15 ips, 30 to 15,000 cps (all ±3 db); flutter and wow less than 0.2%; tuning eye level indicator; dual track operation for up to 7" reel; requires preamp and amplifier; speed change by screw-on 2:1 ratio capstan sleeve and slow-fast stepped flywheel and motor pulley assem-



bly; Mumetal heads; mechanical brakes; 2 knob control, interlocked; digital counter; fast rewind; size 15" x 11 1/2" x 3 3/4" d; mounting: from horizontal up to 85° slant. Mark IV. 1 upper track erase head; 1 upper track record/playback head; (mono) .....\$144.50  
Mark IVB. 1 upper, 1 lower track erase head; 1 upper, 1 lower track record/playback head; (staggered stereo).....\$182.87

**Mark 5 Series Tape Deck**

Four speed (1 1/8, 3.75, 7.5 & 15 ips); two switches control record, playback, wind & rewind; has revolution counter; normally deck is supplied fitted with one erase and one record/playback head (upper track in operation); provision is made for extra heads to be mounted easily when required for special purposes.

- Mark 5 Mono record/playback.....\$169.50
- Mark 5B Stereo record/playback.....\$199.50

**Mark 5 Record/Playback Amplifier**

Primarily designed for use with Brenell tape decks; frequency compensation is to CCIR standards at 7.5 & 15 ips; 7 watts output; two amplifiers required for stereo operation; has high-frequency tone control; microphone input 2-5 mv. into 2 megohms; tuner-phono 250 mv. into 700,000 ohms; tubes—EF86, ECC83, EL84, EZ80, EM81; size 15" w. x 4 1/2" h. x 5" d.; supplied without power supply. ....\$ 84.60  
With power supply.....\$109.50

**BUTOBA**

**Model MT-5 Portable Tape Recorder**

Completely transistorized; two-speed (3.75 & 1 1/8 ips); two-track mono design; made



in Germany; has tone controls, volume level indicator; speaker output 1.2 w.; 7 transistors plus 2 diodes; operates from 8 flashlight batteries, accessories available for other power sources; response 50-13,000 cps @ 3.75 ips, 60-5000 cps @ 1 1/8 ips; signal-to-noise ratio 40 db; handles 5" reels; 9" x 12" x 6"; wt. 12

# 4 Tape Machines

lbs. with batteries; supplied complete with dynamic microphone and carrying strap. ....\$199.95

## Model MT-7 Transistorized Portable Tape Recorder

Transistorized, battery-operated, two-speed (3.75 and 1 7/8 ips); two-track mono de-



sign; product of West Germany; volume level indicator; operates from 4 flashlight batteries, accessories available for other power sources; response 60-12,000 cps @ 3.75 ips; signal-to-noise ratio 40 db; 3" reels; 12" x 8" x 3"; 7 lbs.; supplied with dynamic microphone and carrying handle; accessories available.....\$99.95

## CONCERTONE

### Model 400 "Cosmopolitan" Radio/Recorder

Portable, transistorized, battery or 117 v. a.c.-operated, 2-speed (1 7/8 & 3 3/4 ips),



half-track design. Uses 5" reels and has 3 3/8" x 2 3/4" speaker; a stop-start dynamic-type microphone equipped with remote-control switch (foot sw. optional). Response 150-3500 cps @ 1 7/8 ips, 150-7000 cps @ 3 3/4 ips. Wow & flutter .6%. Output 300 mw. Has built-in AM receiver that can be used as a radio-only if desired; four 1.5-v. batteries provide 15 hours continuous use. Has dual-purpose recording level & battery condition meter & indexing tape counter. 11 1/8" x 7 7/8" x 3 3/8". wt. 10 pounds.....\$197.50

### Series 800 Tape Recorder

Features 6 heads (2 play, 2 record, 2 erase); "Reverse-O-Matic" (play or record 4-track



stereo tapes in either direction automatically). Features remote controllable & built-in add sound and add echo. 2 speed (3 3/4 & 7 1/2 ips). Response 30-18,000 cps @ 7 1/2 ips; Flutter & wow less than .2% r.m.s. @ 7 1/2 ips; S/N 50 db; output level 1 v. Has 2 line & 2 mic inputs & transistorized record & play preamps. 19 1/4" h. x 14 1/4" w. x 8 3/8" d.

Model 801 is self-contained with integral speakers and 5. w. monitor amplifiers in carrying case, complete with 2 dynamic mics .....\$399.95

Model 802 tape deck. Does not have carrying case and speaker/amplifiers; microphones are optional equipment. 14 1/8" h. x 13" w. x 5 1/8" d. ....\$349.95

## CONCORD

### Model 104 Portable Recorder

Two-speed (7.5 & 3.75 ips), dual-track monaural design; response 50-12,000 cps;



wow & flutter max. .25% @ 7.5 ips & .3% @ 3.75 ips; has 2 inputs (mic. & aux.); two outputs—earphone & 3.7-ohm external speaker; built-in amplifier with 10" x 2 1/2" speaker; takes up to 7" reels; 5 1/8" x 12 1/8" x 11 3/8"; 117-v. a.c. operated; comes complete with crystal mic. & crystal earphone .....\$99.95

### Model 220 Mono Tape Recorder

Three speeds (7.5, 3.75, 1 7/8 ips); permits playing time of 2 hours at 7.5 ips with



2400 foot, 7" tape; response 40-15,000 cps @ 7.5 ips; 40-5000 @ 1 7/8 ips; built-in 4" x 6" speaker; electronic-eye level indicator; digital tape counter; includes dynamic microphone and earphones; adapter available for synchronizing sound to film; 12" x 13" x 7 1/2" .....\$149.95

### Model 550-4 Tape Recorder

Transistorized preamps; 3-speed (7.5, 3.75, 1 7/8 ips) design with built-in amplifiers and



speakers; record/playback, 1/4-track stereo or mono; separate erase & record/play stacked heads; response 40-16,000 cps ± 2 db @ 7.5 ips, 50-7000 cps ± 3 db @ 1 7/8

ips; wow & flutter .2% r.m.s. @ 7.5 ips, .35% @ 1 7/8 ips; signal-to-noise ratio better than -50 db; HD less than 2% @ 3 db below rated output; two inputs/ch. (47-ohm to ext. amp and 8 ohms to ext. spkr.); 30A5 output tubes are used; speakers one 4" x 6" and one 6 1/4" in case cover for remote placement; 5w./ch. output; takes up to 7" reels & has 2 vu meters; features sound-on-sound recording; supplied with two dynamic mics. & mahogany carrying case; over-all-size 9 3/8" h. x 13 3/8" d. x 14" .....\$319.95

### Model 440 Stereo Recorder

Same as Model 550-4 except 2-track design. Response 50-15,000 cps ± 2 db @ 7 1/2 ips. S/N 40 db.....\$239.95

### Model 330 Portable Recorder

All-transistor, battery operated, 2-speed (1 7/8 & 3 3/4 ips), mono, full-track design.



Features automatic voice-operated start/stop; automatic slide advance; automatic movie sync and automatic threading. Optional 117 v. a.c. operation; up to 6 hrs. playing time; 5" reels; vu meter & battery condition indicator. Response 50-10,000 cps. Uses "D" type batteries. Supplied with stop/start mic., leather pouch, earphone, special slide-projector plug, sensing tape. 12" x 8 3/4" x 3 3/4". 6 lbs.....\$199.95  
AC-3 117 v. a.c. adapter.....\$14.95  
FT-2 Remote foot control.....\$14.95  
TP-2 Telephone pickup.....\$ 7.95

### Model 884 Tape Recorder

All-transistor, 3-speed (1 7/8, 3 3/4 & 7 1/2 ips) design with separate 1/4-track record



& playback heads. Features 2 separate record & 2 playback preamps; A-B switch for comparing source versus tape when monitoring; sound-on-sound, vu meters. Two 7" speakers & 7 1/2 w./ch. stereo amplifier. Response 30-20,000 cps @ 7 1/2 ips; S/N 60 db; wow & flutter .15% @ 7 1/2 ips; HD 1.5% at 30 db below rated output. Input mic (20 kohm) & aux. (100 kohm). Supplied with 2 dynamic mics, extension cord for right-channel extension speaker \$449.95

## CRAIG PANORAMA

### TR-306 Tape Recorder

Compact mono battery-operated 8-transistor design; will record and play back 4-track tape; 3 speeds (1 5/8, 1 7/8 & 3 3/4 ips); has automatic cut-off & vu meter, built-in a.c. adapter, digital counter. Will record and play 4-track stereo with matching amplifier



.....\$199.95

**TR-404 Tape Recorder**

All-transistor, battery operated; 2" x 5" x 3 1/2", 1 1/2 lbs.; operates on four standard



penlite batteries. Comes equipped with leather carrying case, shoulder strap & microphone .....\$39.95

**CROWN**

**SS700 Series Solid-State Recorders**

Three heads with push-button transport: operate, fast-forward, rewind, and stop. Three motors, differential magnetic braking, automatic stop, three speeds. Handles up to 10 1/2" reels; wow & flutter .09% @

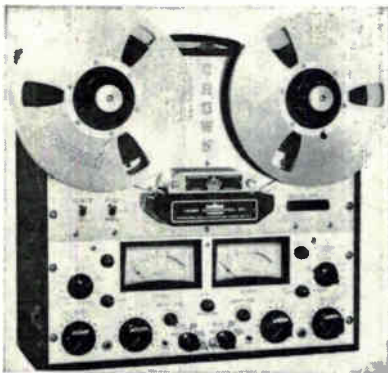

7 1/2 ips. Synchronous-drive motor. Available with either mono electronics or stereo control center. Performance on quarter-track stereo: response at 7 1/2 ips 50-25,000 cps ±2 db; S/N 54 db. Six-channel stereo control center. Basic unit with 6 unbalanced line inputs, 2 mixing inputs per channel with a selection of aux. line, microphone, or RIAA equalization. Outputs 0 level 600 ohm unbalanced or up to +18 dbm with headphone amp. Controls: input #1, input #2, input #3, input #4, output channel #1, output channel #2, play, record, read bias, read erase channels #1 and #2, three-speed equalization, bass & treble controls, also output selector for source, tape, tape output, or source and tape. Two 5-inch vu meters.

SS701 Full-track mono.....\$750.00  
 SS702 Half-track mono.....\$750.00  
 SS722 Two-track stereo.....\$895.00  
 SS724 Quarter-track stereo.....\$895.00  
 Complete series of players-only available.

**"Mus-O-Matic" Series**



Automatic, self-reversing transport; player only; playback response 30-15,000 cps ±2 db @ 7.5 ips, 30-11,000 cps &

3.75 ips; three-motor mechanism with hysteresis synchronous capstan motor; foolproof automatic self-reversing system; standard rack mounting 7.5 & 3.75 ips; controls—rewind, stop, operate, forward; power on/off; operate switch on-off; transistor preamp, cathode-follower output; 19" w. x 7 1/2" d. x 12 1/2" h.  
 Model "A314" Half-track mono.....\$495.00  
 Model "A324" Four-track stereo..\$520.00

**SS800 Series Solid-State Recorders**

Can be remote-controlled. Front-panel speed shift, photocell automatic stop. Three



motors, differential magnetic braking, three speeds. Handles up to 10 1/2" reels; wow & flutter .06% at 15 ips, .09% at 7 1/2 ips. Available with either mono electronics or stereo control center. Performance on quarter-track stereo: record/play response at 7 1/2 ips 30-30,000 cps ±2 db. Six-channel stereo control center. Basic unit with 6 unbalanced line inputs, 2 mixing inputs per channel with a selection of auxiliary, line, microphone, or RIAA equalization. Outputs 0 level 600 ohm unbalanced or up to +18 dbm with headphone amp. Controls: input #1, input #2, input #3, input #4, output channel #1, output channel #2, play, record, read bias, read erase channels #1 and #2, three-speed equalization, bass & treble controls, also output selector for source, tape, tape output, or source and tape; two 5-inch vu meters. Available with low-impedance mic. input and balanced 600-ohm output.

SS801 Full-track mono.....\$1050.00  
 SS802 Two-track mono.....\$ 985.00  
 SS822 Two-track stereo.....\$1295.00  
 SS824 Quarter-track stereo.....\$1295.00  
 SS844 Four-channel in-line.....\$2800.00  
 Complete series of players-only available.

**SS1000 Solid-State Recorders**

Can be remote-controlled; photocell automatic stop; three motors; differential magnetic braking; three speeds; adjustable braking to accommodate many different types of tape. Accommodates 7 to 10 1/2" reels; wow & flutter .06% @ 15 ips, .09% @ 7 1/2 ips. Synchronous-drive motor. Available with either solid-state mono electronics or stereo control center.

SS1001 Full-track mono.....\$1540.00  
 SS1002 Half-track mono.....\$1450.00  
 SS1022 Two-track stereo.....\$1780.00  
 SS1024 Quarter-track stereo.....\$1780.00  
 SS1044 Four-channel in-line.....\$3220.00  
 Complete series of players-only available.

**700 Series Tape Recorders**

Record and play response 20-30,000 cps ±2 db @ 15 ips; 30-17,000 cps ±2 db @ 7.5 ips; and 30-9,000 cps ±3 db @ 3.75 ips; has three-motor transport; differential magnetic braking; automatic stop; separate bass & treble boost on record and playback; d.c. filaments; three-speed record/play equalization; 15, 7.5, & 3.75 ips (1 1/8 ips available); fast forward and rewind, 1200' in 38 sec.; handles up to 10 1/2" reels; max-

**— first choice  
of those who  
demand the best!**

**SOLID  
STATE  
RECORDERS**

WITH MODULAR DESIGN FOR THE  
 ULTIMATE IN QUALITY + DEPEND-  
 ABILITY + PERFORMANCE —  
 PRICED \$495 TO \$11,091

- 👑 **SS700 SERIES**—Designed for the serious audiophile.
- 👑 **SS800 SERIES** — Designed to please the most critical in listening or recording.
- 👑 **BX800 SERIES** — Designed especially for broadcast use.
- 👑 **SS1000 SERIES** — Designed for ultimate in lab, data and other professional recording.
- 👑 **SS1400 SERIES** — Designed for extra-duty lab, data and industrial use... 14" reels.
- 👑 **SA300 SERIES**—Designed with automatic reversing for continuous background music systems.
- 👑 **SA1300 SERIES** — Designed with automatic reversing for extra-long continuous playback... 14" reels.
- 👑 **M4SS SERIES**—Designed for recording and sound studios. Duplicates up to 4 copies from master tape.

**103 MODELS TO  
 SATISFY YOUR  
 RECORDER NEEDS  
 — INDIVIDUAL  
 PERFORMANCE  
 RECORD SUPPLIED  
 WITH EACH CROWN**

WRITE DEPT. ST-09

**1718 Mishawaka Rd. • Elkhart, Ind.**  
**CIRCLE NO. 17 ON READER SERVICE CARD**

# 4 Tape Machines

imum wow & flutter: .06% @ 15 ips, .09% @ 7.5 ips, .18% @ 3.75 ips; timing accuracy 99.8% for synchronous motor; signal-to-noise ratio 56 db @ 15 ips, 54 db @ 7.5 ips, 51 db @ 3.75 ips; overall distortion less than 1.5%; inputs—two high-impedance input channels, mic. or



phono and mic or play; cathode-follower-type output; controls—forward, stop, play/record, thread/idle, stop, rewind switch, bias lock, mic. 1 play, mic. 2 phono, treble, bass, play/record, equalization (three speeds), reel size switch. Model 701 Full-track mono.....\$635.00 Model 702 Half-track mono.....\$525.00 Model 712 Two-track stereo.....\$775.00 Model 714C Four-track stereo with two and four-track stereo playback.....\$795.00 Complete series of players-only available.

## "BX800" "Broadcaster" Series

Record and playback frequency response 30-28,000 cps  $\pm 2$  db @ 15 ips; 30-16,



000 cps  $\pm 2$  db @ 7.5 ips; 30-8000 cps  $\pm 3$  db @ 3.75 ips; direct off-the-tape third head monitor; A-B switch; sound-on-sound with stereo models; "Touch" control with all-electric relay and solenoid operation; remote-control facilities; photocell automatic stop in all functions; standard rack mount; tape speeds 15, 7.5 & 3.75 ips (1 1/2 ips available); handles up to 10 1/2" reels; maximum wow & flutter .06% @ 15 ips, .09% @ 7.5 ips, .18% @ 3.75 ips; timing accuracy 99.8%; signal-to-noise ratio (NAB) 60 db @ 15 ips and 7.5 ips, 55 db @ 3.75 ips; distortion (over-all off tape) less than 1.5%; inputs: two input channels, either low impedance microphone or balanced bridge; output 600-ohm balanced line output and cathode-follower output; controls: push-button—stop, rewind, play, & forward; rotary—mic., phono, record (P and R position), play, A-B, equalization (three speeds); switches—cue, reel size, power on-off; 19" w. x 7 1/2" d. x 14" h. Model "BX801" Full-track mono \$1035.00 Model "BX802" Half-track mono \$ 945.00 Model "BX822" Two-track stereo \$1395.00 Model "BX824" Four-track stereo \$1340.00

## SS1400 Series Solid-State Recorders

Accommodates 14" reels, quarter-inch tape, and half-inch and one-inch tape for industrial models. Can be remote-controlled.

Front-panel speed shift, photocell automatic stop in all models; three motors, differential braking; three speeds; adjustable braking to accommodate many different types of tape; wow & flutter .06% @ 15 ips, .09% @ 7 1/2 ips. Synchronous drive motor. Available with either solid-state mono electronics or stereo control center.

SS1401 Full-track mono.....\$1640.00  
SS1402 Half-track mono.....\$1550.00  
SS1422 Two-track stereo.....\$1880.00  
SS1424 Quarter-track stereo.....\$1880.00  
SS1444 Four-channel in-line.....\$3320.00  
SS1483 Three-channel half-inch...\$3500.00  
Complete series of players-only available.

## DUAL

### TG12A Four-Track Stereo Recorder

Three-speed (1 1/2, 3.75, 7.5 ips) stereo/mono record/playback with dual-channel amplifiers & speakers; has automatic shut-off; response 40-20,000 cps @ 7.5 ips, 40-16,000 cps @ 3.75 ips; signal-to-noise ratio 52 db @ 7.5 ips; wow & flutter .15% @ 7.5 ips; features sound-on-sound & sound-with-sound; 13" x 15" x 10".....\$349.95  
TG-12 Deck only.....\$245.00

## DYNACO

### Transistorized Tape Recorder

Imported from B&O of Denmark; fully transistorized, 3-speed complete recorder with built-in power amplifiers; three inputs (200-ohm mike, RIAA equalized phono, radio tuner) mixed via professional-type slide potentiometers; provision for sound-on-sound and echo; two vu meters; hysteresis synchronous motor; separate record and playback heads; tape-input monitoring; preamp output; 40-16,000 cps  $\pm 2$  db; r.m.s. flutter less than 0.075%; peak-to-peak flutter less than 0.2%; S/N ratio 50 db.....\$498.00

## EICO

### Model RP-100 Tape Deck

Provides stereo/mono 1/4-track record, playback, erase; also 1/2-track stereo/mono

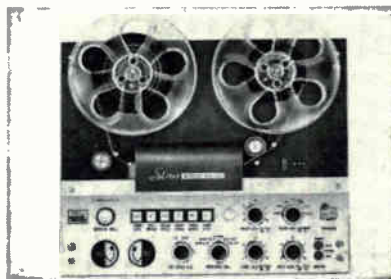

playback; speeds 7 1/2" and 3 3/4" ips; takes 7" reels; separate record/playback heads; separate record and playback transistor electronics to monitor while recording; permits sound-on-sound recording; dual meters; push-button controls; rewind and fast forward 1200' per minute; frequency response 30-15,000 cps  $\pm 2$  db at 7 1/2 ips, 30-10,000 cps  $\pm 2$  db at 3 3/4 ips; timing accuracy 0.3%; has automatic end-of-tape switch; wow and flutter under .15% r.m.s. at 7 1/2 ips, under .2% r.m.s. at 3 3/4 ips.....\$450.00  
Model RP-100K (semi-kit includes transport assembled, control electronics and stereo playback amplifiers in kit form).....\$299.95

### Model 2400 Tape Recorder

Dual speed (3.75 & 7.5 ips); stereo/mono 1/4-track erase, record & playback; 1/2-track mono playback; has combined erase, record & playback head; response 30-17,000 cps



$\pm 3$  db @ 7.5 ips; 30-12,000 cps @ 3.75 ips; wow & flutter .2% @ 7.5 ips; has recording level indicators, counter, mixing mic. & line level controls; end of tape stop; signal-to-noise ratio —45 db @ 7.5 ips; with walnut base; kit .....\$199.95  
Factory wired .....\$269.95

## EMERSON

### MM313 Mono Recorder

4-speed (7 1/2, 3 3/4, 1 1/2 & 1 1/8 ips); half-track erase head & half-track record/play-



back head. Has p.a. provision; 4" speaker; ceramic or crystal mic. input; record-level indicator; S/N ratio 40 db; external speaker output 3.2 to 4 ohms; 2 1/2" w. music power output; 8 3/8" h. x 12 1/8" d. x 14 1/8" w. Supplied with ceramic microphone .....\$79.95

### MM314 Mono Recorder

Similar in style & design to Model MM313 except has transistorized amplifiers. Response 50-12,000 cps @ 7 1/2 ips; S/N 45 db. ....\$89.95

### MM316 Mono Recorder

Same as Model MM316 except has digital counter & tone control.....\$99.95

### MM317 Mono Recorder

Similar to Model MM313 except has transistorized amplifiers, ceramic or low-imped-



ance dynamic mic. input; response 50-15,000 cps @ 7 1/2 ips; restyled transport; 8" x 4" speaker; S/N 45 db; vu meter; 8 1/2" h. x 12 1/8" d. x 21" w. Supplied with ceramic mic. ....\$129.95

### SS333 Stereo Recorder

4-track & 2-track stereo record/playback; mono record/playback; 4 speed (7 1/2, 3 3/4, 1 1/2 & 1 1/8 ips); transistorized; dual ampli-

fiers & speakers; sound-with-sound; digital counter; p.a. facilities; automatic shut-off; pause control. Response 50-18,000 cps @ 7½ ips; S/N 45 db; 2½" w. music power/ch.; has two 8" x 4" speakers; 2 mic. & 2 high-level inputs; two heads (¼-track stereo erase & ¼-track stereo record/play). 8½" h. x 12¼" x 21" w. Style similar to Model MM317. Supplied with two ceramic microphones .....\$199.95

### ESTEY

#### Model 20 Tape Recorder

Mono dual-track record/playback, 2-speed (7.5 & 3.75 ips) design; has neon record-



level indicator, complete amplifier system, and an 8" x 4" speaker; response 100-12,000 cps ± 2 db @ 7.5 ips; output 2.5 w. music power; ceramic mic included; 12½" x 16½" x 7½" .....\$99.95

#### Model 30 Tape Recorder

Mono dual-track record/playback, 2-speed (7.5 & 3.75 ips) design; has digital counter,



complete amplifier system, an 8" x 4" speaker, a single high-level input and 2 additional outputs for external speakers; response 100-12,000 cps ± 2 db @ 7.5 ips; output 2.5 w. music power; supplied with special demonstration tape and ceramic mic.; 12½" x 16½" x 7½" .....\$129.95

#### Model 50 Tape Recorder

Stereo record/playback, 4-track, 2-speed (7.5 & 3.75 ips) design; features sound-

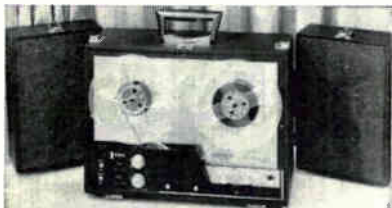

with-sound; dual channel amplifiers; detachable wing speakers; digital counter; two external speaker jacks; response 100-12,000 cps ± 2 db; power 3.5 w. music/channel; supplied with special demonstration tape and two ceramic mics.; 22½" x 11½" x 8" d. ....\$249.95

#### Model 70 Tape Recorder

Stereo record/playback, 4-track, 2-speed (7.5 & 3.75 ips) design; features sound-on-



sound, sound-with-sound; 4-track mono record; stereo amplifier; detachable 5" x 7"

wing speakers; recording level meters & digital counter; response 50-15,000 cps ± 2 db @ 7.5 ips, 50-10,000 cps ± 2 db @ 3.75 ips; output 10 watts music power per channel; supplied with special demonstration tape and two crystal mics; 21" x 12" x 11½" .....\$349.95

#### Model T-91 Stereo Tape Recorder

3-speed (7½, 3¾ & 1½ ips) design features pause control with pause lock, auto-



matic shut-off & end-of-tape warning buzzer, tape counter; sound-on-sound; sound-with-sound; vu level meters. Response 40-18,000 cps ± 2 db @ 7½ ips; wow & flutter less than .2% r.m.s. @ 7½ ips; 12½ w/ch. music power. Has stereo amplifier system & removable sound column speaker system with 4 speakers in ea. system. Has high & low level inputs & 3 heads. 22½ h. x 12¾" l. x 10¾" w. ....\$499.95

### FANON-MASCO

#### FTR-409 "Ambassador" Recorder

3-speed (7½, 3¾ & 1½ ips) 4-track stereo recorder with amplifiers & speakers. Fea-

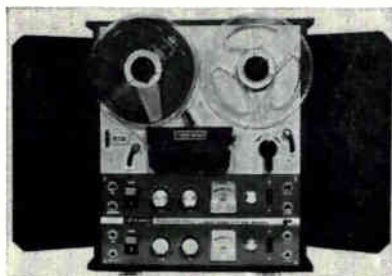

tures sound-with-sound; vu meters; counter; automatic shut-off; 6" oval speakers; pause control. Records 4-track stereo & mono. Response 40-14,000 cps @ 7½ ips; S/N 50 db; separation 50 db. 17" h. x 15" w. x 10½" d. Supplied with 2 dynamic microphones .....\$299.95

#### FTR-408 "Envoy" Recorder

Dual-speed (7½ & 3¾ ips) mono, dual-track design. Features 5" reels; level indicator; mic & radio inputs; 4" speaker. Response 200-9000 cps @ 7½ ips; S/N 38 db; 1 w. output; wow & flutter .3%. 12½" x 9" x 6", wt. 11 lbs. Supplied with dynamic mic .....\$69.95

#### FTR-404 "Diplomat" Recorder

Dual-speed (3¾ & 7½ ips) mono design; dual track; 7" reels; vu level meter; counter; 6" oval speaker; high-level input. Response 100-12,000 cps @ 7½ ips; 3.5 w. output; S/N 48 db; wow & flutter .25% r.m.s.; separation 45 db; 15" w. x 12½" d. x 6¼" h. Supplied with dynamic mic .....\$109.95

#### FTR-403 "Escort" Portable Recorder

Battery operated or a.c. with adapter; 3¾" reels; dual-speed (3¾ & 1½ ips); level

meter; battery life indicator; 4 hours recording. Response 150-8000 cps; 250 mw. output; S/N 40 db; wow & flutter .3%. Uses 6 "D" cells with life of 15 hrs. 5" x 9" x 3", wt. 5 lbs. Supplied with remote-control dynamic mic, earphone & radio connector cable. Optional equipment: a.c. power adapter, remote-control foot sw., telephone pickup, leather case with shoulder strap.....\$99.95

#### FTR-406 "Courier" Portable Recorder

Battery or a.c. operated; dual-speed (3¾ & 1½ ips); double-track mono design; 5" reel; 4 hours of recording; transistorized. Response 100-8000 cps; 350 mw. output; S/N 40 db. Uses six "C" batteries for 8 hrs. continuous battery life. 11" x 10½" x 3¼" h., wt. 9 lbs. Supplied with remote-control mic & earphone. Optional equipment: remote-control foot switch & telephone pickup.....\$114.95

### FERROGRAPH

#### Series 5 Stereo Recorder

Features two speeds (7.5 & 3.75 ips); 3 motors; automatic stop; 2 recording am-



plifiers and 2 separate playback preamps; each channel may be used separately (recording or playback without affecting the other); wow & flutter less than .15% at 7.5 ips; response 40-15,000 cps ± 2 db @ 7.5 ips and 50-10,000 cps ± 2 db @ 3.75 ips; signal-to-noise ratio unweighted including hum 52 db; has dual inputs (2 mv. & 50 mv. r.m.s.); records, mono or stereo; plays back quarter-, half- or full-track mono and twin-track stereo or quarter-track stereo; output from preamps approx. 1.0 v. (1 kohm) r.m.s. each track. Model 5/424.....\$595.00

#### Series 5 Mono Recorder

Two-speed (3.75 & 7.5 ips), 3-motor design; wow & flutter .16%; response 40-10,000 cps ± 3 db @ 3.75 ips, 40-15,000 cps @ 7.5 ips; dual inputs (.003 v. & 1 v. peak); output speaker or 2½ v. @ 15 ohms; includes amplifier & speaker. Model 5A/N.....\$425.00

### FREEMAN

#### 200 Transistorized Tape Recorder

Features automatic reverse and/or automatic continuous play in both directions;



automatic shut-off in manual modes; 4 heads with playback "off-the-tape" monitor while recording; 4-channel mixer with 4-input level controls; all transistorized; 600 ohm balanced line cathode-follower outputs plug, built-in monitor speakers; two 5-pound roller bearing flutter filters & 10 pound flywheel; 3 speeds (3.75, 7.5 & 15 ips); re-

# 4 Tape Machines

sponse 35-20,000 cps @ 15 ips, 35-13,000 cps @ 3.75 ips; wow & flutter .12% @ 7.5 ips; signal-to-noise ratio 50 db; crosstalk -55 db @ 1000 cps; has 2 high-impedance mic. & 2 high-level inputs; four 600-ohm (1.2 v. r.m.s.) outputs; 17" x 17½" x 7½" d.; 28 semiconductors.....\$549.50  
C-246 Walnut cabinet extra (can also be used for Models 800, 600 & 400).....\$99.50  
200-DPA tape deck & preamps.....\$495.00

## 800 Stereo Tape Recorder

4-track, 3-speed (1½, 3¾ & 7½ ips) design. Wow & flutter less than .15% @



7½ ips; response 40-16,000 cps @ 7½ ips. Output 5 w./ch. music power; S/N 40 db. Has 2 ea. inputs mic & radio/phono. Has dual vu record meters & digital counters and built-in stereo speakers; plays/records any combination of stereo or mono. Features sound-with-sound and automatic head demagnetizer.....\$299.50  
S-40A External portable speakers.....pair \$69.50  
1400 4-channel preamp/mixer.....\$24.95  
DM166 Broadcast dynamic mic.....\$39.95

## 600 "Senior" Portable Recorder

Features ½-track mono record/playback; all transistor; speeds 7½, 3¾, 1½ ips. Re-



sponse 65-15,000 cps @ 7½ ips; wow & flutter .25% r.m.s. @ 7½ ips; output 650 mw. S/N -40 db @ 3% HD. Input mic & radio/phono. Outputs: monitor earphone & to ext. spkr. Has dual-purpose vu meter for record level & battery condition. Operates from 6 penlight size "A-A" batteries or directly from 117-v. a.c. line; supplied with leather case, remote control mic., earphone, batteries, telephone pickup; 7½" x 9" x 3"; wt. 8½ lbs.....\$199.50  
5566-1A Battery charger.....\$24.50  
5566-2 Foot control.....\$14.50  
S-20 8" portable ext. speaker.....\$39.50

## 550 "Senior"

Similar to Model 660 "Senior" except output is 500 mw.; optional 117-v. a.c. adapter. 2 hrs. recording time @ 1½ ips. 6" x 10" x 2¾". wt. 5½ lbs.; includes leather case,

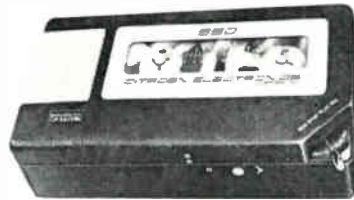

remote control mic., earphone, telephone pickup, batteries.....\$159.50  
5566-1A Battery charger & a.c. adapter.....\$24.50  
5566-2 Foot control.....\$14.50

## 600 Tape Recorder

Features three speeds (3.75, 7.5, 15 ips); automatic shut-off; 3-head design; dual vu



meters; 7" reel; suitable for any combination of 4 & 2 track stereo and/or mono record & playback modes; sound-with-sound; includes stereo amplifiers & speakers; response 40-20,000 cps @ 15 ips, 40-12,000 cps @ 3.75 ips; signal-to-noise ratio 50 db; wow & flutter .15% @ 7.5 ips; 2 high-imp. mic & 2 high-level line inputs; 17½" w. x 19" h. ....\$449.50

## GRAETZ

### Model M50K Tape Recorder

Four-track, two-speed (7.5 & 3.75 ips) record/play stereo design; has mono or stereo inputs for microphone, radio, phono; external speaker outputs; has provision for foot-control pause accessory; response essentially flat from 40 cps to beyond audibility; wow & flutter less than ± .5%; includes built-in preamp and power amplifier for both channels; 5 watts total output; single speaker; built-in mixing facil-



ity; electrical tape end stop; adapter cord available which permits tracks 1 & 3 or 2 & 4 to be played simultaneously through the built-in speaker; also available is a polytonal sound blender adapter for trick recordings, sound-on-sound, or sound-with-sound; tubes—6FG6, 2-6227, 2-12-AX7, 2-6AB4, 2-6DL5.....\$399.90

## HEATH

### Model AD-22A Tape Recorder Kit

Four-track stereo/mono record and playback; two inputs per channel with mixing controls; fast forward and rewind; has 3-digit counter; two speeds (7.5 & 3.75 ips); wow and flutter .2% or less at 7.5 ips, .03% or less at 3.75 ips; frequency response 40-18,000 cps ± 2 db at 7.5 ips;

harmonic distortion 1% or less; signal-to-noise level 45 db or better; 12" w. x 15" l. x 9" h. (7" below & 1½" above



mounting board); tape deck and amplifiers for record and playback.....\$139.95  
Model ADA-22-1 Luggage-type case .....\$37.50

## INTER-MARK

### "Cipher VII" Stereo Tape Recorder

Four-track, 3-speed (1½, 3.75, 7.5 ips) design; response 35-15,000 cps @ 7.5 ips, 25-

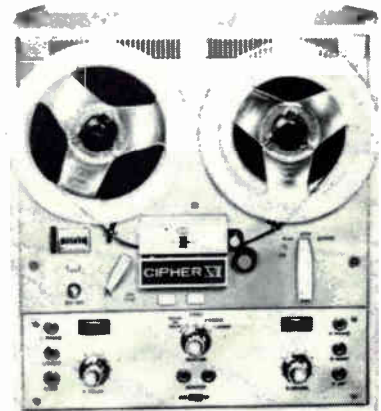

7000 cps @ 1½ ips; signal-to-noise ratio 50 db; wow & flutter .2% @ 7.5 ips; input impedance 10,000 ohm mic. & 250,000 ohm hi level; 5 w. output; features 2 vu meters, counter, 2 dynamic mics, automatic type shut-off & facilities for sound-on-sound; speakers are housed in separate cabinets; 20" x 15½" x 7¾".....\$274.95

### "Cipher VII-D" Tape Recorder

Same as "Cipher VII" except includes tape deck with stereo recording amplifier. Has automatic end-of-reel shut-off. 16½" x 15" w. x 7" d.....\$199.95

### "Cipher VI" Tape Recorder

Dual-speed (7½" & 3¾ ips); 4-track stereo & mono record and playback. Has

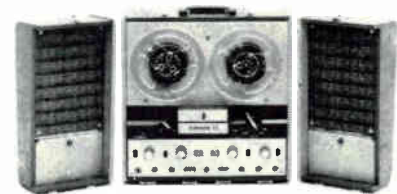

pause control; vu meters; counter; built-in amplifiers & speakers. Response 60-14,000 cps @ 7½ ips; flutter & wow .2% @ 7½ ips; S/N 45 db. Inputs for 2 mics. & 2 high level. Can be used as p.a. system. Complete with carrying case & 2 dynamic microphones. 16" w. x 16" x 11" d.....\$239.95

### "Cipher V" Tape Recorder

Two-speed (1½ & 3.75 ips) dual-track mono design; features automatic pause, re-

(Continued on page 88)

# Master Electronics faster with RCA Home Training

NEW, EASY WAY TO BEGIN WITH "AUTOTEXT" PROGRAMMED INSTRUCTION  
HERE'S WHAT YOU GET!

**40** fascinating  
THEORY LESSONS.



Here are all the basic principles of radio and electronics in easy-to-understand language, fully illustrated!

**40** exciting  
EXPERIMENT LESSONS.



Each contains hundreds of absorbing, experiments and construction techniques to help you learn easier!

**40** complete  
SERVICE PRACTICES.



Filled with practical, time-saving, money-saving servicing tips to use throughout your training!

PLUS ALL THIS AT NO EXTRA COST...

**15 KITS!**

to build a Multimeter, AM Receiver and Signal Generator. Kits contain new parts for experiments, integrated so as to demonstrate what you learn in the lessons and to help you develop technical skills. Each kit is fun to put together! Compare what RCA gives you with any other school!



### MULTIMETER

A sensitive precision measuring instrument you build and use on the job. Big 4½" meter with 50 micro-amp meter movement. 20,000 ohms-per-volt sensitivity d-c, 6,667 a-c.



### AM RECEIVER

Have the satisfaction of building your own AM radio with this high quality 6-tube superheterodyne set. Big 5" speaker, fine tone!

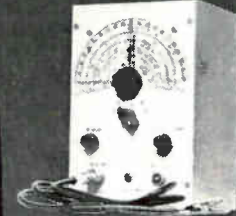

### SIGNAL GENERATOR

A "must" for aligning and trouble-shooting receivers. Build it for your own use. 170 KC to 50 MC fundamental frequencies for all radio and TV work.

Begin your training the faster, easier way with new "Autotext" programmed instruction. You learn almost automatically—and go on to advanced training sooner than you ever thought possible! Practical work with the very first lesson. Liberal Tuition Plan. Pay only as you learn. No long term contracts to sign! No monthly installments required!

Complete selection of Home Training Courses to choose from: TV Servicing • Color TV • Transistors • Communications Electronics • FCC License Preparation • Mobile Communications • Automation Electronics • Digital Techniques • Nuclear Instrumentation • Automatic Controls • Industrial Applications • Drafting • Computer Programming.

### CLASSROOM TRAINING ALSO AVAILABLE

RCA Institutes Resident School in New York City and RCA Technical Institute in Cherry Hill (near Camden), New Jersey offer training that will prepare you to work in rewarding positions in fields such as automation, communications, television, computers, and other industrial and advanced electronic applications. You are eligible even if you haven't completed high school. Check Classroom training and information will be rushed to you.

Send postcard for free illustrated book today!  
Specify home training or classroom training!

RCA INSTITUTES, INC., Dept. SH-94  
350 West 4th St., New York 14, N. Y.



THE MOST TRUSTED NAME  
IN ELECTRONICS

# 4 Tape Machines

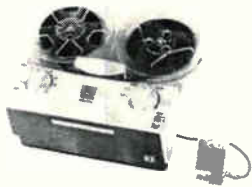

recording level light, 5" reel, 6" x 3" speaker; frequency range 70-8000 cps @ 3.75 ips, 70-4000 cps @ 1 7/8 ips; supplied with dynamic mic, flight-type luggage carrier, earphone; 5 1/2" x 9 1/2" w. x 8 1/2" d.; 9 1/2 lbs. ....\$79.50

## "Cipher I" Tape Recorder

Three-speed (7.5, 3.75, 1 7/8 ips), mono two-track design; features recording level light,



counter. 6" x 4" speaker; output 5 w.; frequency range 70-13,000 cps @ 7.5 ips, 70-4000 @ 1 7/8 ips; supplied with monitoring earphone, dynamic mic, and leatherette covered wood cabinet; 6 1/2" h. x 13 7/8" w. x 13" d. ....\$139.95

## "Denon 800" Tape Recorder

Dual-speed (7 1/2 & 3 3/4 ips). 4- & 2-track stereo/mono record & playback. Features

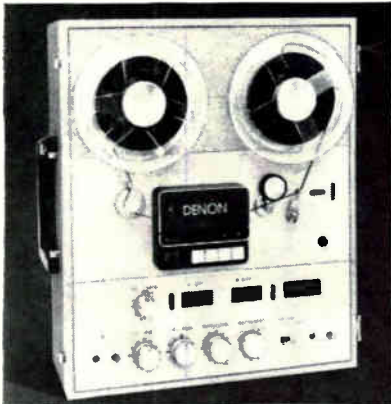

record/playback preamps; sound-on-sound; echo; line & mic. mixing; counter; automatic end-of-reel shut-off; 3 input jacks for each channel (radio, phono, mic); output jacks for ext. amplifier. Response 30-15,000 cps @ 7 1/2 ips; wow & flutter .15% @ 7 1/2 ips; S/N -52 db for 4-track stereo; separation 45 db. Has 4-track plug-in heads, erase, record, and playback. (2-track optional). 19 1/2" x 16 1/2" x 9".....\$499.95

## KNIGHT

### KN-4003 Record/Play Preamp

All-transistor; designed to be used with KN-4000A tape transport. Can be installed within transport if desired. Features dual-channel operation to record & play 4-track stereo or mono; sound-on-sound; echoes; vu meters; headphone jack. Response 40-17,000 cps ± 3 db @ 7 1/2 ips; S/N 50 db below record level; high-level phono/tuner inputs;

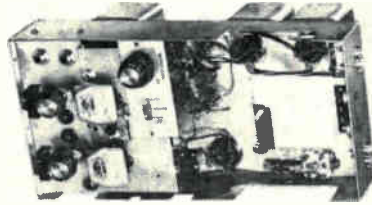

5 1/4" x 12 1/2" x 6 3/4".  
79RX895-R .....\$119.95

### KN-4400 Stereo Recorder

Features 4-track stereo & mono; 2 speeds (7 1/2 x 3 3/4 ips); 2 heads, 4-track record/



play & erase; dual-channel preamps; response 40-17,000 cps ± 3 db @ 7 1/2 ips; flutter & wow less than .2%; S/N more than 40 db. 13" x 13" x 6 1/4". Requires 12 1/2" square cut-out.

79 RU 882-R .....\$149.88  
79 RU 871-R Carrying case .....\$ 19.95

### KN 4000A 4-Track Tape Transport

3.75 and 7.5 ips; three motors; separate erase, record, playback heads; push-but-

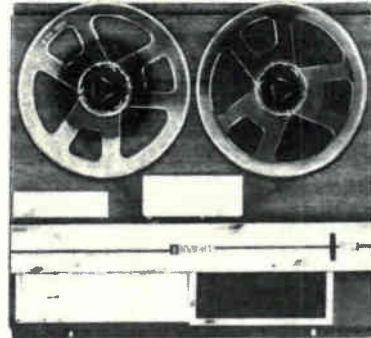

ton controls; makes 4-track stereo and mono recordings with KN-4003 preamp; digital tape counter; flutter less than .25% @ 7.5 ips; 13 1/2" x 15 1/4" x 7" desert beige and sand gold.....\$129.95  
Carrying case for KN-4000 and KN-4002A .....\$24.95

## KORTING

### Model 260 Tape Deck-Preamps

Stereo, 4-track with 2 heads; similar to TR3000 but does not include mics, speakers, and power amps; does have preamplifiers for record & playback.....\$219.95

Model 270DC with gray carrying case .....\$229.95

### Model 88-B Portable Recorder

Transistorized battery or a.c.-operated; amplifier operates 80 hours & motor up to 20 hours on one set of batteries. Plays 70 min.

on 1/4" dual-track tape; 2 1/2" reel; 1 7/8 ips; 10 mw. output. Response 100-6000 cps; mic. serves as speaker on playback. Supplied with remote-control mic., earphone. Various accessories, including carrying case, ext.

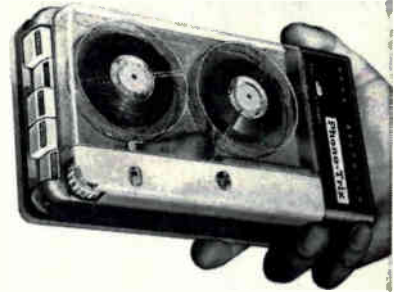

amp. speaker, telephone adapter, foot control, 117-v. a.c. adapter, etc., available. 1 7/8" x 4 1/4" x 7 1/2" .....\$69.95

### TR2000 Tape Recorder

Similar in design & performance to Model TR3000 except has only single channel am-



plifier & speaker; has stereo heads for 2nd channel record & playback; can convert stereo tapes to mono for self playback; 14 1/4" w. x 12 1/2" d. x 7 1/2" h.; supplied with one low-impedance dynamic mic. & gray carrying case.....\$199.95

### TR3000 Tape Recorder

Two-speed (7.5 & 3.75 ips); plays 4-track & 2-track stereo & mono; records 4-track



stereo & mono; has stereo amplifiers & speakers; features p.a. amplifier & sound-on-sound dubbing; response 30-20,000 cps ± 3 db @ 7.5 ips, 40-15,000 cps @ 3.75 ips; wow & flutter .2% @ 7.5 ips; S/N ratio 45 db; 10 w. output; 16 1/2" x 12" d. x 6 1/4" h.; supplied with two low-impedance mics.....\$299.95

### TR4000 Transistorized Tape Recorder

Three-speed (7.5, 3.75 & 1 7/8 ips); 4-track record & playback with stereo amplifiers & speakers; features 3 heads (erase, record,



playback); separate bass & treble controls in record position; one knob for synchronized dubbing; completely transistorized; record level meters; remote pause; variable echo or reverb effects; response 30-20,000 cps @ 7.5 ips, 40-7000 cps @ 1 1/2 ips ±3 db; wow & flutter .1% @ 7.5 ips; S/N ratio 45 db; 10 watts audio output; 117 v. operation; 18" x 13" d. x 8" h.; supplied with two low-impedance microphones .....\$399.95

**Model 212 "Conferette" Recorder**

Features talk/listen/stop/reverse/review/erase remotely controlled from microphone;



phone; battery operated transistorized; for voice only; has battery level indicator; built-in loudspeaker; automatic end-of-reel stop; 6 1/4 lbs.; 3 1/4" h. x 5 1/2" d. x 12 3/4" w.; 117 v.; 12 or 6 v. auto battery adapters available .....\$169.95  
Model 216 Similar to Model 212 but designed for 117 v. a.c. operation or from rechargeable batteries or direct from car battery; has built-in battery recharger. .... \$199.95

**KOUYOH**

**"Saxon 555" Tape Recorder**

All-transistor. 3-speed (1 1/2, 3 3/4, 7 1/2 ips) portable design. Has 5" reels, record level



meter, counter and will operate from six standard "D" cell batteries. 12 v. auto battery via cigarette lighter, or 117 v. a.c. Response 100-10,000 cps @ 7 1/2 ips. Has inputs for radio, phono, foot-operated remote control, telephone pickup. Mono design with built-in 3" x 6" speaker (1 w. output) & 3 heads for dual-track operation. Complete with dynamic remote-control mic., earphones, leather case, batteries, cigarette lighter connector cord. Optional equipment: foot sw., telephone pickup, ext. speaker 11 1/4" x 10 1/2" x 3 1/2". 13.3 lbs. ....\$169.95

**"Deus 630" Tape Recorder**

All-transistor. 2-speed (1 1/2 & 3 3/4 ips) portable design. Operates on six 1.5 v. penlight cells or 117 v. a.c. Response 100-7000 cps @ 3 3/4 ips. Has 2 heads for dual-track operation, record level meter, 3" speaker (1 w. output), 3 1/4" reels. Accessories supplied & optional same as model "Saxon 555." 8" x 6 3/8" x 3 3/8" .....\$89.95

**LAFAYETTE**

**Model RK-142 Tape Recorder**

Two-speed (3.75 & 7.5 ips), dual-track mono record/playback design; has 4" x 6" speaker, record level indicator, provision



for external speaker; signal-to-noise ratio 42 db @ 7.5 ips; wow and flutter .2% or better @ 7.5 ips; complete with dynamic microphone and case; 11 3/4" x 9 7/8" x 7 1/8" .....\$59.95

**"Criterion 1000" Recorder**

Records 4-track stereo and mono; plays 2- & 4-track stereo & 4-track mono. Features



3 speeds (7 1/2, 3 3/4 & 1 1/2 ips); transistorized stereo preamps; automatic shut-off. Response 50-15,000 cps ±3 db @ 7 1/2 ips; S/N 50 db; wow & flutter .2% @ 7 1/2 ips. Has 2 mic. & 2 high-level inputs; two 6" x 4" oval speakers. 6 w./ch. output; counter; level meters; mic./radio mixer control; record/play & erase heads. Supplied with 2 dynamic mics & teakwood cabinet. 17 1/4" w. x 7 1/4" h. x 12 3/4" .....\$199.50

**Model RK-141 Tape Deck**

Two-speed (7.5 & 3.75 ips) with two-channel (stereo) six-transistor preamps (3



transistors per channel); response 50-15,000 cps ±2.5 db @ 7.5 ips; 50-9000 cps @ 3.75 ips; wow and flutter .15% @ 7.5 ips; signal-to-noise ratio 50 db; output .5 v.; 14 3/8" w. x 5" h. x 10 3/8" d.; walnut base or carrying case available at extra cost.....\$59.50

**Model RK-137A Tape Recorder**

Two-speed (3.75 & 7.5 ips) four-track recorder & playback design; features



pause button, electronic switching between tracks 1-4 and 3-2; separate record and

erase heads; vu meter; will record and playback mono 4-track; has amplifiers and speaker for single channel playback; will play back stereo with external second-channel audio system that has input for tape head; signal-to-noise ratio 42 db; outputs for extension speaker, monitor, and second-channel stereo playback; furnished complete with removable top cover & microphone; 13 1/2" w. x 6 1/2" h. x 10 3/4" d. ....\$89.50

**Model RK-675 Tape Recorder**

Deluxe push-button 4-track, 2-speed (7.5 & 3.75 ips); records 4-track stereo and 4-track mono; features sound-with-sound recording; automatic shut-off of tape transport; two-channel transistorized preamps and vacuum-tube power amps; response 40-18,000 cps @ 7.5 ips, 40-12,000 cps @ 3.75 ips; signal-to-noise ratio 45 db; wow and flutter less than 0.2% @ 7.5 ips; controls: pause, two record buttons with safety interlocks, push-button, rewind/stop/play, stop/fast forward, tone control switch, 2 volume controls; has two 4" x 6" speakers; four input jacks; four output jacks; complete with simulated leather case and two microphones; 16 1/2" w. x 7" h. x 12 1/4" d. ....\$179.95

**Model RK-650 Tape Recorder**

Four-track, 2-speed (7.5 & 3.75 ips) push-button operated; will record and play back



stereo or mono; features sound-with-sound recording; automatic tape cut-off switch; separate record/play and erase heads; index counter and level indicators each channel; dual-channel transistorized preamps, vacuum-tube power amps for record and playback (speaker not included); response 40-18,000 cps @ 7.5 ips, 40-12,000 cps @ 3.75 ips; wow & flutter less than .2% @ 7.5 ips; signal-to-noise ratio 45 db; audio output 2 watts/channel; 15 1/2" w. x 6 1/4" h. x 11 1/4" d. (5 1/2" below panel); less case.....\$109.95  
With carrying case.....\$124.95

**RK-600A Tape Recorder**

Two-speed (7 1/2 & 3 3/4 ips), 4-track design. Records 4- & 2-track stereo. Plays 4-



& 2-track stereo, 2-track & full-track mono. Features separate record/playback & erase heads; pause control; individual level indicators; hi & low level inputs for mic., tuners, etc.; monitor outputs; sound-with-

# 4 Tape Machines

sound. Response 40-15,000 cps @ 7½ ips; separation 45 db; wow & flutter .25%; S/N 45 db; 1.5 w./ch. output. Supplied complete with built-in amplifiers & two 4" x 6" oval speakers, vinyl covered case & 2 dynamic microphones .....\$129.50

## LUCOR

### Model 1200 Stereo Recorder

Records mono or stereo, 4-track or single track; dual speed 7.5 ips & 3.75 ips; has 2



preamps, 2 power amps (7½ w./chan.), & 2 (5" x 7") speakers; input impedance 50 K & 500 K; output 8 ohms; wow & flutter .18% @ 7.5 ips & .2% @ 3.75 ips; response 30-20,000 cps ± 2 db @ 7.5 ips & 40-15,000 cps @ 3.75 ips; has public address facilities; balance meter & level meters; 17" x 15" x 8½"; 7" reels; will sell for less than.....\$350.00

## MAGNECORD

### "1022" Stereo Tape Recorder

Similar to Model "1021" in design & performance but for stereo operation. 2-speed



(7½ & 15 ips); wow & flutter .17% @ 7½ ips, .15% @ 15 ips; response 30-16,000 cps ± 2 db @ 7½ ips & 35-22,000 cps @ 15 ips. Heads: selectable 2-channel erase, 2-channel record, 2-channel play & ¼-track play .....\$739.00  
With case.....\$799.00

### "1024" Stereo Tape Recorder

Similar in design & performance to Model "1021" except for stereo operation. ¼-track stereo or 4-track mono operation. Heads selectable ¼-track erase, ¼-track record, ¼-track play. Optional 2-channel stereo play head available installed in 4th head position. Inputs: mic. (50 kohms), high impedance mixing bridge & aux. bridge. Outputs: emitter-follower & aux. emitter-follower (.5 v.).....\$595.00  
With 4th head installed.....\$620.00  
Case .....\$ 60.00

### "1028" Stereo Tape Recorder

2-speed (7½ & 15 ips) tube design. Wow & flutter .15% @ 7½ ips & .1% @ 15 ips; response 35-16,000 cps ± 2 db @ 7½ ips & 35-18,000 cps @ 15 ips; S/N 55 db; reels



5", 7" & 10½"; rewind time 2400' in less than 1 minute. Inputs: high & low imp. mics & high-impedance balanced & unbalanced bridge. Outputs: cathode-follower, 2.5 v. & 150/600 ohms balanced. 17% w. x 12% h. x 12" d.

"1028-2X" 2-track stereo or ½-track mono; less case .....\$ 995.00  
"1028-24X" with 4th head (¼-track stereo play), less case .....\$1075.00  
"1028-4X" ¼-track stereo or 4-track mono, less case .....\$ 995.00  
"1028-42X" with 4th head (2-track stereo play), less case .....\$1075.00  
Case optional.....\$ 50.00

### "1048" Stereo Tape Recorder

Same as Model "1028" except for taped speeds 3¼ & 7½ ips; response 40-16,000 cps ± 2 db @ 7½ ips. 12" deep. Available versions & prices same as Model "1028" tape recorder.

### "1021" Mono Tape Recorder

Two-speed (3¼ & 7½ ips) mono recorder; full-track record & erase and half- or full-



track playback. Wow & flutter .2% @ 7½ ips; response 45-18,000 cps ± 2 db @ 7½ ips; S/N 53db for both speeds. Inputs: low-imp. mic., balanced bridge, unbalanced bridge, mixing bridge & aux. bridge. Outputs: 150/600 ohm balanced & aux. A & B unbalanced. All-transistor design featuring built-in cueing speaker with separate volume control & amp. (amp will drive an external speaker); phone jacks; mixing input with separate gain control; simultaneous record & playback; adjustable impedance input & output transformers; vu meter; remote "start/stop." Transport size 19" w. 10½" h. x 7½" d; amplifier size 19" w. x 5¼" h. x 12" d. ....\$659.00  
With case .....\$719.00

## MARTEL

### Model 301 Mono Recorder

4-speed (7½, 3¼, 1½ & 1¼ ips); transistorized ½-track portable design. Has dual-purpose record level vu meter & battery condition indicator, pause control, 5" reel capacity, remote-control mic; radio, phono & mic. inputs; six 1.5-v. "D" batteries; 4" x 5" speaker. Response 60-14,000 cps @ 7½ ips; S/N 40 db; playing time 8 hrs. @ 1¼ ips; 12" x 5¼" x 10¼"; 12½



lbs. ....\$199.50

## MIRANDA

### Model "Nocturne" Recorder

Records 4-track stereo with separate tone & volume controls & recording indicators for



each channel. 4 input jacks permit simultaneous recording from 4 different sound sources. For playback has two built-in monitor speakers. 3-speed (1½, 3¼ & 7½ ips). Response 40-18,000 cps ± 3 db @ 7½ ips; S/N -41 db; wow & flutter .2% @ 7½ ips; channel separation 50 db; 5 w./ch. output. Has two 4" x 6" oval speakers, in teakwood cabinet and is supplied with one mic. ....\$249.95

### Model "Sorrento" Recorder

4-track, stereo, 2-speed (3¼ & 7½ ips) design with transistorized amplifiers. Features



sound-with-sound & record & playback 4-track stereo or mono; vu meters & pause switch. Response 30-18,000 cps ± 5 db @ 7½ ips; HD .2%; flutter & wow .2% @ 7½ ips. Outputs: preamps .3 v., speakers 7 w. Has 21 transistors & 19 diodes. 9½" h. x 17% w. x 15¼" d.....\$399.95  
Dynamic mic. (optional).....\$ 19.95  
Remote control (optional) permits rewind, stop, playback, fast forward, plus separate volume controls & 16' extension cord .....\$ 34.95



**Model "Mirandetta C" Portable Recorder**

2-speed (3 3/4 & 1 7/8 ips); dual-track, battery or 117-v. a.c. operated. Dual-purpose



recording level & battery quality indicator with digital counter. Response 200-6000 cps  $\pm$  5 db; wow & flutter .3%; 2 3/4" x 4" speaker (500 mw. @ 5% dist.); S/N 40 db. Uses 3" reel, 4 D-cell batteries & has 6 transistors & 1 diode; 9 3/8" x 8 7/16" x 3 1/4". wt. 7 1/4 lbs. Supplied with remote-control dynamic mic., leather carrying strap, shoulder grip, and a.c. cord....\$169.95  
Carrying case.....\$ 11.95  
Foot control.....\$ 6.95  
Telephone pickup.....\$ 5.95

**NORELCO**

**"Continental 101" Portable Recorder**

Transistorized, 2-track, 1 7/8 ips design. Response 80-8000 cps; S/N 45 db. 6 D-type



batteries are used to provide 40 hours of recording. Uses 4" tape reel for 3 hrs. recording. Has combination level & battery condition indicator & dynamic mic. Wt. 7 lbs. 11" w. x 3 3/4" d. x 8".....\$99.50  
Accessories available: Leather carrying case, remote mic. sw., a.c. adapter & headphones.

**"Continental 301" Tape Recorder**

Completely transistorized, 4-track, 4-speed (7.5, 3.75, 1 7/8 & 1 5/16 ips) with 2-channel



preamplifiers & monaural power amp. & speaker; has facilities for 4-track mono/stereo record & 4-track mono playback; the 2nd stereo channel playback is made from preamps through any hi-fi system; response 60-16,000 cps @ 7.5 ips, 60-4500 cps @ 1 5/16 ips; signal-to-noise better than -40 db; wow & flutter .14% @ 7.5 ips; features 2-channel mixing, automatic end of tape stop & can be used as a p.a. amplifier;

16 1/2" x 15 1/2" x 8 1/2"; supplied with cardioid pattern dynamic mic.....\$199.50

**"Continental 401" Tape Recorder**

Completely transistorized, 4-track stereo/mono record & playback; 4-speed (7.5,



3.75, 1 7/8, & 1 5/16 ips); includes complete stereo amplifiers & two speakers (1 speaker in cover); can be used as p.a. amplifier, and has interlock pause button, mixing facilities, multiplexing facilities; stacked heads; automatic end of tape stop & sound-on-sound; response 50-18,000 cps @ 7.5 ips, 60-4500 cps @ 1 5/16 ips; signal-to-noise better than -48 db; wow & flutter less than .14% @ 7.5 ips. ....\$299.50

**OKI**

**Model 111 Mono Recorder**

2-track, 2-speed (7 1/2 & 3 3/4 ips) design featuring transistorized, output-transform-



erless amplifier; pause control; counter; level meter; mic. & aux. inputs; 5" speaker. Response 60-13,000 cps @ 7 1/2 ips; S/N 40 db; 1.5 w. output; wow & flutter .2% @ 7 1/2 ips. Has two heads (1/2-track record/play & erase). 11 1/2" w. x 2 3/4" h. x 6". With dynamic mic. Less than \$130.00

**Model 222 Mono Recorder**

4-track, 2-speed (7 1/2 & 3 3/4 ips) design featuring transistorized OTL amplifier; pause control; counter; vu meter; mic. & aux. inputs; sound-on-sound; sound-with-sound; 5" speaker. Response 50-15,000 cps @ 7 1/2 ips; S/N 47 db; 1.5 w. output; wow & flutter .12% r.m.s. @ 7 1/2 ips. Has 2 heads: 1/4-track 2-channel stereo record/play & erase heads for 4-track mono record/play & 4-track stereo playback through external preamps; separation 50 db. 11 7/8" x 12 3/8" h. x 7" d. Supplied with one dynamic mic. ....Less than \$190.00

**Model 555 Stereo Recorder**

4-track, 2-speed (7 1/2 & 3 3/4 ips) design featuring transistorized OTL amplifiers;



**HOW LONG CAN WE STAY NEW?**



**FOREVER!**

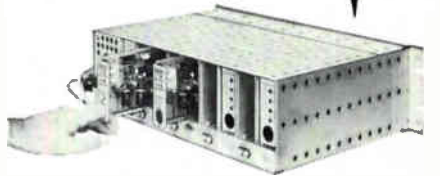

BUY THE NEW 1024

**M**agnecord

**\$595**

Plagued with a tape recorder that becomes outdated every year? Looking for a recorder that is built to give you maximum performance FOREVER? Then INVESTigate the NEW 1024! Examine the back. Notice the long life features . . . our unique cards for example. Expandable electronics can accommodate such accessories as a voice operated relay, slide synchronizer, cuer, and other devices, all mounted on electronic cards. These cards fit spaces provided for them in the electronic assembly and are easily removed and inserted. With such superb advancements, Magnecord 1024 remains NEW year after year. You get highest quality at a price that seems ridiculously low.

MAGNECORD SALES DEPARTMENT

MIDWESTERN INSTRUMENTS, INC.

Subsidiary of the TELEX Corporation

P. O. Box 7509 / Tulsa, Okla. 74105

# 4 Tape Machines

detachable stereo speakers; sound-on-sound; sound-with-sound; automatic shut-off; counter; 2 vu meters; p.a. operation; dual mic. & aux. inputs. Response 20-22,000 cps @ 7½ ips; S/N 50 db; 3 w./ch. output; ch. separation 60 db; dual 6½" x 2" speakers; wow & flutter .12% @ 7½ ips. Dual heads: ½-track stereo record/playback & erase for 4-track individual mono & stereo record/playback. Supplied with 2 dynamic mics. Optional equipment: transistorized cigarette lighter inverter for 12-v. operation. Over-all size 11¾" w. x 13¾" h. x 12½" d. with speakers. ....Less than \$370.00

## Model 333 Stereo Recorder

4-track, 2-speed (7½ & 3¾ ips) design featuring transistorized OTL amplifier, de-

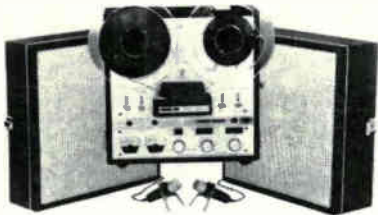

detachable stereo speakers; pause control; sound-on-sound; sound-with-sound; 2 vu meters; dual mic. & aux. inputs; response 50-15,000 cps @ 7½ ips; S/N 47 db; 1.5 w./ch.; two 5" speakers; wow & flutter .12% r.m.s. @ 7½ ips. Has ¼-track record/play & erase heads for 4-track individual mono & stereo record/playback. Supplied complete with 2 dynamic mics. 11¾" w. x 12¾" h. x 12½" d. ....Less than \$300.00

## RCA

### "Fortnighter" (1YC1) Tape Recorder

Similar in design & performance to Model 3YD1 except does not include stereo power amps & speakers; preamps are, however, included; 7½" w. x 9¾" d. x 11¾". ....\$169.95

### "Trendliner II" (1YB2) Recorder

Four-track, 2-speed (3.75 & 1½ ips) mono record/playback design for use with tape cartridge; features start and stop by remote control (remote switch on microphone); digital tape counter; dual-ray recording monitor; earphone jack; complete with ceramic microphone; similar in appearance to Model 1YB1; response 50-15,000 cps @ 3.75 ips at preamp; 7½" h. x 9¾" w. x 11¾" d. ....\$129.95

### "Prompter" (1YB1) Tape Recorder

Similar in design & performance to Model 1YB2 except does not have remote control;



all tape cartridge machines provide 2 hours playing time at 3.75 ips & 4 hours @ 1½ ips .....\$ 99.95

### "Cordon Bleu" (3YD1) Recorder

Record/playback cartridge design; features

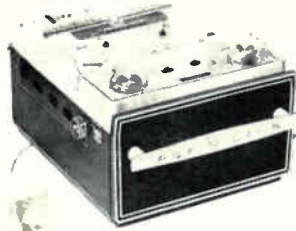

stereo & mono 4-track record/playback; 2-speed (3.75 & 1½ ips); digital counter; has dual speakers, one in removable lid on 10' cord; response 50-15,000 cps @ 3.75 ips at preamp; supplied with 2 ceramic microphones; 17½ lbs. 8¾" h. x 9¾" w. x 11¾" d. ....\$199.95

## REALISTIC

### Model TR-270 Tape Recorder

Two-speed (3.75 & 7.5 ips), two-track mono design; level indicators; inputs for microphone and radio; separate erase and record heads; built-in amplifier and speaker; response 40-12,000 cps; microphone and case included. ....\$59.95

## REVERE-WOLLENSAK

### Automatic Tape Recorders

Completely automatic tape changing system; automatically threads the tape, plays,

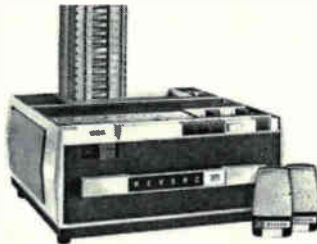

rewinds, rejects the completed cartridge and repeats the process through as many as 20 stereo music selections during a 15-hour period; speed 1½ ips; cartridge 3¾" square x ½" thick; features new type recording head 50th diameter of a strand of human hair; specially developed magnetic tape; precision index counter; wow & flutter 0.3%; S/N ratio 48 db; music power output 9 w. per channel; 5 watts continuous @ 5% HD; inputs: microphone 2 mv. @ 10 mcs. phono-radio 1 v. @ 1 meg; outputs: aux. 1 v. nominal. speaker 8 ohms; response 40-15,000 cps ± 3 db @ 1½ ips; 7" x 14½" x 14¼" (approx.); weight approx. 32 lbs.

M-2 Recorder-player with 2 mics....\$399.00

M-3 Player only.....\$329.00

M-20 Recorder-player deck model with 2 mics. ....\$339.00

M-30 Player only, deck model.....\$269.00

### Model 1580 Tape Recorder



Records and plays back 2- and 4-track mono and stereo tapes; includes complete system—preamps, power amplifiers, speak-

ers; will record sound-with-sound (play one channel, record other channel); can be used as p.a. system; output jacks for extension speakers and from preamps; automatic shut-off; counter; independent tone and volume controls; two speeds (3.75 & 7.5 ips); response 40-18,000 cps ± 3 db @ 7.5 ips, 40-13,000 cps @ 3.75 ips; crosstalk -50 db; signal-to-noise ratio greater than 48 db; wow & flutter less than .3%; power output 5 watts continuous sine wave @ 5% harmonic distortion per channel; 6½" x 10¼" x 11¾"; wt. 26 lbs.; complete with two microphones, slipover vinyl cover, accessory cords .....\$319.00

### Model 1570 Tape Recorder

Monophonic version of the Model 1580; has same basic features & specifications; available only through audio-visual dealers; less than .....\$200.00

### Model 1515-4 Recorder

Plays 2- and 4-track stereo & records up to four separate mono tracks; dual speed (7.5



& 3.75 ips); recording indicator; index counter; includes mono record preamp & stereo playback preamps; does not include power amps or speakers; response 30-20,000 cps ± 3 db @ 7.5 ips; 30-15,000 cps @ 3.75 ips; wow & flutter 0.3%; S/N ratio 48 db; signal from preamp output: 0.5-1.5 volts; crosstalk 50 db; 6½" x 10¼" x 11¾"; complete with microphone & cords. ....\$199.00

### Model 1500 Mono Recorder

Mono version of Model 1515-4 except includes power amp & speaker; response 40-15,000 cps ± 3 db @ 7.5 ips; 40-8000 cps @ 3.75 ips.....\$179.00

### Model T-3000 Mono Recorder

Features digital counter, external speaker output, external amplifier output, record



indicator; two speeds (7.5 & 3.75 ips); automatic shut-off; has provisions for remote foot pedal; durable metal and Royalite case; designed as a two-track mono record/playback system with power amplifier & speaker; response 40-15,000 cps ± 3 db @ 7.5 ips; 50-8000 cps @ 3.75 ips; wow & flutter .3%; S/N ratio 46 db; inputs: low-level 2 mv., 10 megohms; high-level 1 v., 1 megohm; power output 8 watts music power output; 7½" x 14" x 14½"; available only through audio-visual dealers; less than .....\$176.00

### Model T-1980 Stereo Recorder

Records & plays 2- & 4-track mono & stereo tapes; features digital counter, two- & four-track head control; external speaker output; external amplifier output; hi-level input; low-level input; sound-with-sound; public address; 3.75 & 7.5 ips speeds; two internal  
(Continued on page 98)



## Cracked cadenzas in your concerto?

...then "bargain" recording tape's no bargain!

Mistakes you can buy cheap. And tape-making mistakes you're almost sure to get in recording tape sold dirt cheap without the manufacturer's name. The dangers for audiophiles? Fade out of high and low frequencies. Distortion. Background hiss. Even tape flaking, or worse, abrasiveness that can damage your recorder. Worth the gamble? Hardly.

You can make fine performance, long-life crystal-clear recordings a certainty by specifying "SCOTCH" BRAND Recording Tapes. All "SCOTCH" Tapes must pass over 100 quality tests to earn their "brand"... tests no bargain tape could hope to pass!

Thinner, more flexible coatings of high-

potency oxides assure intimate tape-to-head contact for sharp resolution. Precision uniformity of coatings assures full frequency sensitivity, wide dynamic range, *plus* identical recording characteristics inch after inch, tape after tape. Lifetime Silicone lubrication further assures smooth

tape travel, prevents squeal, protects against head and tape wear. Complete selection of all purpose tapes—from standard to triple lengths, with up to 6 hours recording time at 3¾ ips.

**See your dealer. And ask about the new "SCOTCH" Self-Threading Reel. Remember . . . on SCOTCH® BRAND Recording Tape, you hear it crystal clear.**



**Magnetic Products Division** 

"SCOTCH" AND THE PLAID DESIGN ARE REG. TMS OF 3M CO., ST. PAUL 19, MINN. © 1964. 3M CO.

# QA on Hi-Fi TAPE RECORDERS

By HERMAN BURSTEIN

**T**HE prospective purchaser of a tape machine usually has many questions to ask, and the man who already owns one has at least as many more. The answers, of course, are valuable in helping the individual buy a machine suited to his needs and in helping him get the best use of it.

*I have a mono audio system and want to add a tape recorder. Should it be a stereo or mono machine?* There are several advantages in getting a stereo unit. You'll be ready in case you convert the rest of your system to stereo. As a rule, stereo machines and most prerecorded tapes are  $\frac{1}{4}$ -track designs. This means that you can operate on four mono tracks rather than just two—providing twice as much time per reel of tape. Stereo machines are more versatile than mono units, providing such features as sound-on-sound or sound-with-sound.

*I am considering a stereo tape recorder that is available with either  $\frac{1}{2}$ -track or  $\frac{1}{4}$ -track heads. What are the pros and cons of each track width?* For home use the net advantage probably lies with  $\frac{1}{4}$ -track heads. True, the  $\frac{1}{2}$ -track ones tend to offer higher signal-to-noise ratio and greater freedom from dropouts because they span more tape. But advances in head and tape technology have greatly offset this superiority. For a given amount of head misalignment,  $\frac{1}{4}$ -track heads produce less treble loss. They are virtually standard for home use and are consonant with prerecorded tape. They offer twice as much operating time per reel of tape by permitting the tape to be used in two directions; and by virtue of this, they avoid the nuisance of having to rewind the tape after operation in one direction. However, if you plan to edit (cut up) tapes, you can operate only in one direction and then might as well use  $\frac{1}{2}$ -track heads.

*I am interested only in playing prerecorded tapes through my hi-fi system, and not in making recordings. What kind of tape machine should I get?* Purchase what is known as a tape player. If your hi-fi system has an input marked "tape head", you can buy just a transport (deck) with a playback head (without the amplifiers) and run a cable from the head to this input. Otherwise you have to buy a machine that includes a playback preamplifier in order to supply the necessary amplification and equalization (bass boost).

*What are the relative merits of separate record and playback heads and of a single head that performs both functions?* Use of separate heads permits each to be optimized for its specific function, tending to provide somewhat better performance, particularly with respect to signal-to-noise ratio. Separate heads allow instant monitoring of what is being recorded *on the tape* (although a few machines forego this advantage because they don't include separate record and playback electronics). And they facilitate alignment of the machine. A single record-playback head is cheaper, entails simpler electronics (no point in having separate record and playback amplifiers) and thus further reduces

cost and eliminates the problem of a difference in head alignment between the record and playback heads and consequent treble loss.

*What tape speeds are desirable and suitable for home use?*  $7\frac{1}{2}$  ips is considered sufficient and still necessary for high fidelity, which entails not only broad, flat frequency response, but also a high signal-to-noise ratio, low distortion, and low wow and flutter. Little is to be gained in home use by going to 15 ips.  $7\frac{1}{2}$  ips is now strongly challenged by  $3\frac{3}{4}$  ips owing to improvements in heads, machines, techniques, and tapes. Even  $1\frac{1}{8}$  ips is becoming a contender for serious recording.

*What are the pros and cons of a vu meter versus a magic-eye tube for use as a record-level indicator?* The vu meter indicates average level and, if its scale is graduated in decibels (as a true vu meter is), it facilitates adjustment of recording level by a given desired amount. But as a mechanical device it understates signal peaks and may lead the operator into recording at levels producing excessive distortion. The magic-eye, being an electronic device, follows peaks and thus gives better warning of distortion-producing levels. Also the magic-eye is less expensive.

*What are the pros and cons of a transport with separate motors for driving the capstan and the reels versus a transport with a single motor?* For maximum ruggedness, constructional simplicity, ultra-fast winding, minimum wow and flutter, and accurate speed, professional units employ separate motors. But in home use, extreme ruggedness and ultra-fast winding are secondary considerations, supplanted by the need for compactness, lightness, and economy, which call for one motor. At the same time it has been found that proper mechanical design enables a single motor to achieve very good motion: low wow and flutter, and accurate speed. On balance, for home use, a single-motor transport is not necessarily inferior.

*Why do some tape machines use pressure pads and what are their advantages?* To keep the tape tight against the heads and thus prevent treble loss and poor erasure, many home machines use pressure pads. Superior machines, however, partly or completely avoid pressure pads by using a system of tape tension (exerted by the reels) and tape guides to maintain tape-to-head contact; such a system is more costly. Elimination of pressure pads reduces wow and flutter, head wear, tape wear, and the chance of tape squeal. Some machines employ pressure pads only in the case of the tape erase head or at a point external to the heads, thus essentially avoiding the problems associated with pressure pads.

*How narrow a gap should the record playback heads have?* The most vital aspect of gap width is treble response, requiring a narrow gap in *playback* (not in recording). For response substantially flat to 15,000 cycles, the playback



## The commanding presence of Sony sound

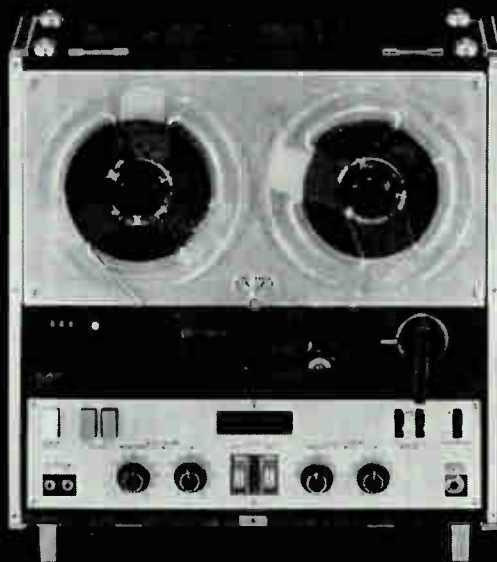

Now enter the world of the professional. With the **Sony Sterecorder 600**, a superbly engineered instrument with 3-head design, you are master of the most exacting stereophonic tape recording techniques.

Professional in every detail, from its modular circuitry to its 3-head design, this superb 4-track stereophonic and monophonic recording and playback unit provides such versatile features as: ■ vertical and horizontal operating positions ■ sound on sound ■ tape and source monitor switch ■ full 7" reel capacity ■ microphone and line mixing ■ magnetic phono and FM stereo inputs ■ 2 V.U. meters ■ hysteresis-synchronous drive motors ■ dynamically balanced capstan flywheel ■ automatic shut off ■ pause control and digital tape counter—all indispensable to the discriminating recording enthusiast. Less than \$450,\* complete with carrying case and two Sony F-87 cardioid dynamic microphones.

**SONY**

**SUPERSCOPE**

*The Tapeway to Stereo*

Multiplex Ready!

\* Yes, less than \$450!

Sony tape recorders, the most complete line of quality recording equipment in the world, start at less than \$79.50. For literature or name of nearest dealer, write Superscope, Inc., Sun Valley, Calif. In New York, visit the Sony Salon, 585 Fifth Avenue.

**CIRCLE NO. 58 ON READER SERVICE CARD**

head's gap should be no wider than about .00025" at 7½ ips, about .000125" at 3¾ ips, and about .000060" at 1½ ips (assuming that treble losses in recording are not so profound as to prevent such response). Heads with gaps as small as .000040" are employed to permit response to about 10,000 cps at 15/16 ips. For recording and erasure, the heads should have relatively wide gaps. Where a separate head is used for recording its gap is typically about .00025" to .00100". The gap of an erase head is about .005".

*What and why is NAB equalization?* Magnetic phenomena involving the tape and the heads produce steep treble and bass losses in recording and playback. These losses are overcome by treble boost applied mainly or only in recording and bass boost mainly or only in playback. The NAB standard (officially) specifies how much bass boost should be used in playback at 15 ips: commencing (up 3 db) at 3180 cycles and rising 6 db per octave until it levels off (3 db from maximum) at 50 cycles. The standard further provides that record equalization should then be tailored to provide essentially flat response on a record-playback basis: flat within 1 db between 100 and 7500 cps and no more than 4 db down at 50 and 15,000 cps. It has been found practical to apply the NAB standard to 7½ ips as well (unofficially). But lower speeds require different playback equalization in order to maintain good treble response and good signal-to-noise and distortion characteristics.

*For recording, how should I connect my audio system to my tape machine?* Ideally, the signal should be taken at a point where distortion is least, frequency response is wide and flat, and the signal is unaffected by settings of the system's gain and tone controls and by the load presented by the tape recorder. Virtually all audio systems of the component type (preamps, integrated amplifiers, receivers) provide such a take-off point, usually marked "tape output". If your system is a commercial console without a jack to feed a tape recorder, it will be necessary to have a service technician make the connection. The least desirable course, although often followed in the case of commercial consoles, is to tap the signal off the speaker leads.

*For playback, how should I connect my tape machine to my audio system?* A component system will have one or more high-level input jacks marked "tape input", "auxiliary", "radio", etc. The tape machine can be connected to any one of these. If yours is a commercial console and has no input jack available, an audio technician can install one, together with a switch to disconnect the other signal sources (radio and phono).

*What kind and brand of tape should I use?* Instead of 1.5-mil tape, which comes 1200 feet to the 7" reel, you may want one of the thinner, extended play tapes running between 1800 and 3600 feet to the reel. But the latter have less strength, greater print-through, and greater susceptibility to dropouts because of a thinner oxide. The thinner tapes are generally Mylar (polyester film), which is more resistant than acetate to the ravages of time and use. Conventional 1.5-mil tape comes in either acetate or Mylar, the latter costing more. You have a choice between name-brand tapes at premium prices or off-brand tape at reduced prices. Among the possible advantages of premium tape are better frequency response, less noise, higher output, lower distortion, fewer dropouts, lower print-through, greater stability of magnetic characteristics, greater dimensional accuracy and stability (resistance to stretching, curling, cupping, etc.), a smoother surface for maintaining intimate tape-to-head contact and minimizing head wear, greater strength, greater resistance of the oxide to rub-off and flaking, better ability to withstand temperature and humidity extremes. Where noise or print-through problems are severe, there are special high-output tapes and low print-through tapes; however, the gain in one aspect of performance will probably entail a sacrifice in another; thus a high-output tape may not have quite as good treble response. You must assess for

yourself the relative advantages and disadvantages of each choice of tape.

*What kind of microphone should I use?* The crystal or ceramic microphones ordinarily furnished with home tape machines usually can be improved on by a dynamic microphone in the price class of about \$40 and upward. The perfectionist may be willing to spend \$200 or more for a condenser microphone. An omnidirectional microphone is probably the best choice for all-around use, although in a noisy location you may want a cardioid, which discriminates against sound behind it. Or you might find a bi-polar (usually ribbon) mike useful; this discriminates against sounds to either side. For stereo, definitely use mikes of identical brand and model, preferably a matched pair. A high-impedance microphone is generally satisfactory unless your cable to the tape recorder exceeds about 12 feet; then there is danger of treble loss. For a long cable run you need a low-impedance microphone, with a step-up transformer at the tape recorder end of the cable.

*What care should I give the tape heads in order to get the best use and most life from them?* Clean and demagnetize them after about every 8 hours of use. Employ quality tape with sufficient lubricant to minimize head wear. You can apply to the heads sparing quantities of lubricant specially sold for this purpose. Avoid tape-to-head contact during rapid winding; if there is no tape lifter, remove the tape from the loading slot and wind directly from reel to reel. Avoid scratching the heads, exposing them to a strong magnetic field (such as that of a bulk eraser), or subjecting them to mechanical shocks or temperature extremes. Have azimuth checked and aligned, if necessary, whenever the machine is serviced.

*What factors can cause exaggerated or deficient treble?* Deficient treble is more likely and may be due to: excessive bias current fed to the record head, incorrect equalization in recording and/or playback, failure to change equalization with change in tape speed, wear of the playback head gap and resultant widening, azimuth misalignment, separation of the tape from the head due to dirt or tape oxide on the heads, inadequate pressure-pad force, or insufficient tape tension where pads aren't used, magnetization of the heads, use of tape of poor quality, excessive cable length between the head and tape electronics or between the tape electronics and the following amplifier, or improperly set tone controls.

Excessive treble may be due to insufficient bias current, incorrect equalization, use of tape not intended for audio (such as instrumentation tape), or improperly set tone controls.

*What factors can cause exaggerated or deficient bass?* Improper bass response may be due to incorrect equalization, particularly in playback; to a defective head; or to a mis-set tone control. Improper playback equalization is the most likely cause.

*What factors can cause noise?* Tubes (or transistors), particularly in the early stages of the tape electronics, are the prime causes. Resistors in the early stages are apt to be culprits. A magnetized tape head tends to record noise on the tape and also to produce noise in playback. In recording, a principal source of noise is distortion in the oscillator waveform, possibly due to a defective oscillator tube, a defective oscillator transformer, inadequate design, or unmatched or defective resistors and/or capacitors. Incomplete erasure is a form of noise and may be due to a defective erase head, insufficient drive current to the head, too high an oscillator frequency, an excessive recording level, or misalignment of the erase head so that it doesn't fully span the recorded track. Print-through, another form of noise, may be due to excessive recording level, injudicious choice of too thin a tape, or storage of the tape in an excessively warm place. In a stereo machine, crosstalk may result from poor isolation between the two sections of a tape head or between the two channels of the tape electronics.



Model 555 4 track stereo record and playback. Less than \$370



Model 222 4 track monophonic record and stereo playback. Less than \$190

**Very clever,  
these**



**tape recorders**



Model 111 Monophonic record and playback. Less than \$130



Model 333 4 track stereo record and playback. Less than \$300

**...and they're guaranteed one full year.**

These OKI solid state Tape Recorders are geniuses in creating sound of magnificent dimension because they have an all transistor amplifier; no tubes. They operate either vertically or horizontally with easy individual push button controls. They weigh less than any other recording instrument in this category. OKI stereo recorders come completely equipped with four-speaker, crossover network systems.

And yet OKI solid-state Tape Recorders, both stereo and monaural cost far less than you'd imagine.

Why not visit your dealer today and see for yourself.



Send for more information and the name of your nearest OKI Tape Recorder dealer.

Name \_\_\_\_\_

Address \_\_\_\_\_

City \_\_\_\_\_ State \_\_\_\_\_ Zip # \_\_\_\_\_

**CHANCELLOR ELECTRONICS INC.**  
457 Chancellor Ave., Newark, N. J.

SHFD-65

# 4 Tape Machines

speakers; two external speakers; provision for remote foot pedal; response 40-18,000 cps  $\pm$  3 db @ 7.5 ips; 40-13,000 cps @ 3.75 ips; wow & flutter 0.3%; S/N ratio 48 db; crosstalk 50 db; power output 22 watts total (11 watts music power per channel); 5 watts continuous at 5% harmonic distortion; inputs: low-level 2 mv., 10 megohms.



hi-level 1 v., 1 megohm; outputs: 8 ohms, preamp 0.5-1.5 volts; 2 1/4" x 13 3/4" x 9 1/2" .....\$379.00

## Model T-1981 Tape Deck

Utilizes the basic Model T-1980 assembly housed in cadmium steel enclosure with satellite chrome mounting frame; unit is designed for custom installations; same specifications as for the Model T-1980. ....\$349.00

## Model T-1780D Stereo Deck

Deck version of Model 1580; contains a stereo record/playback preamp designed to supply approx. 1.5 volts output; satellite chrome mounting frame facilitates custom installation; features stereo record/playback; provision for foot pedal; automatic shut-off; two- & four-track head control; record indicators; hi-level input; low-level input; sound-with-sound; low impedance preamp output; 3.75 & 7.5 ips; response 40-18,000 cps  $\pm$  3 db @ 7.5 ips; 40-13,000 cps @ 3.75 ips; wow & flutter 0.3%; S/N ratio 48 db; crosstalk 50 db; inputs: low-level 2 mv., 10 megohms; hi-level 1 v., 1 megohm; output 0.5-1.5 volts; 13 3/4" w. x 14" x 5 1/2" below mounting flange, 1 3/4" above. ....\$269.00

## Model T-1400 Mono Recorder

Features digital counter; external speaker output; external amplifier; record indicator; two speeds (3.75 & 7.5 ips); provisions for remote foot pedal; response 40-13,000 cps  $\pm$  3 db @ 7.5 ips; 40-8000 cps @ 3.75 ips; wow & flutter 0.35% for both speeds; S/N ratio 48 db; audio output 8 watts music power @ 5% distortion; 6 1/2" x 10 1/4" x 11 3/4" .....\$149.00

## Model T-524 Mono Recorder

Complete (amplifier & speaker) two-track system; features record level indicators; four speeds (1 1/2, 1%, 3.75 & 7.5 ips); low-level & hi-level inputs; external speaker output; two record indicators; 5" x 7" speaker; 3 watt music power output @ 5% distortion; response 80-12,000 cps; S/N ratio 45 db; wow & flutter 0.3%; 7" x 13" x 10". ....\$99.00

## Model 600 Portable Recorder

Battery-operated, transistorized design featuring remote "start-stop" sv. on mic.; vu meter for record level & battery condition; 2 speeds (1 1/2 & 3 3/4 ips). Response 250-5000 cps  $\pm$  5 db @ 3 3/4 ips; Wow & flutter .7% @ 3 3/4 ips; S/N 40 db; 200 mw. output. For 1/2-track record/play. Has 8 ohm



2 1/2" x 3 3/4" speaker, 9 v. & six 1 1/2-v. penlight batteries & output for ext. speaker; 3 inputs (mic., remote & ext. power). 2 hrs. playing time (600' tape, 3" reel @ 1 1/2 ips). Supplied with mic & batteries. 8 1/2" x 8 1/2" x 2 1/4". wt. 4 1/4 lbs. ....\$119.00  
Accessories available: leather carrying case, shoulder strap, earphone, telephone pickup, foot sw., 12-v. automotive adapter & 117 v. a.c. converter/charger.

## Model 1220 Tape Recorder

2 & 4-track (7 1/2 & 3 3/4 ips) mono design. Features counter, automatic shut-off, vu



meter, monitor facilities, storage compartment. Will play 7" reels with cover closed. Response 50-17,000 cps  $\pm$  3 db @ 7 1/2 ips, 50-8000 cps @ 3 3/4 ips; wow & flutter .3% r.m.s.; S/N 45 db; output 3 w. music power. Has 2 inputs (mic. & radio/phone) & both preamp & external 8-ohm speaker outputs. Supplied with microphone. 17 1/2" x 14" x 8" .....\$129.00

## Model 1280 Tape Recorder

2 & 4-track, 2-speed (3 3/4 & 7 1/2 ips) stereo and mono record/playback; vu meters, de-



tachable wing speakers; monitor facilities; storage compartment. Response 50-17,000 cps  $\pm$  3 db @ 7 1/2 ips, 50-8000 cps @ 3 3/4 ips; wow & flutter .3% r.m.s.; S/N 45 db; output 3 w./ch. music power. Has 2 inputs (mic & radio/phone) & both preamp & external 8-ohm speaker outputs. 17 1/2" w. x 14" d. x 10 1/2" h. (7 1/2" h. without spkr. cover); supplied with 2 dynamic mics. ....\$199.00

## Model 1281 Tape Recorder

Same as Model 1280 except does not include cabinet, wing speakers & mics. ....\$169.00

## M-4 "Cartridge" Tape Recorder

Automatic cartridge changer. Will play 48 minutes/stereo cartridge & up to 96 minutes/mono (15 hours/loading). Single speed 1 1/2 ips, 2-track stereo or mono record/playback. Response 40-15,000 cps  $\pm$  3 db; wow & flutter .3%; S/N 48 db. Has 2 dual-channel inputs (mic & radio/phone)



& 2 outputs ea. channel. (Preamp 1 v. & external speaker, 9 w./ch. music power, 5 w./ch. sine wave @ 5% HD). Supplied with 2 ext. speaker systems (ca. 6" x 9" elliptical & 3" tweeter). 19" x 10 1/4" x 5 3/4". Recorder 16" x 15 1/2" x 8 1/2". ....\$459.00

## RICOH

### "Commentator" Portable Tape Recorder

All-transistor, battery operated, 2-speed (3 3/4 & 1 1/2 ips), double-track mono design. Has dual-purpose record level & battery



condition meter; 2" x 4" speaker; dynamic mic. or tuner input, 3 1/4" reels. Operates from six 1 1/2 v. batteries with optional 117 v. a.c. adapter. Response 200-6000 cps @ 3 3/4 ips. Supplied with remote control microphone, telephone pickup, earphone, leather carrying case; 5" x 9 1/4" x 3 3/4". 5 lbs. ....\$109.95  
A.c. adapter .....\$14.95  
Telephone pickup .....\$ 5.95  
Foot switch .....\$ 8.95

## ROBERTS

### Model 1600 Tape Recorder

Half-track, mono, 3-speed (7 1/2, 3 3/4 & 1 1/2 ips) design with amp & 4" x 6" (8

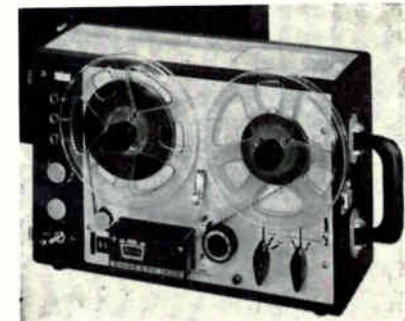



ohm) speaker. Has level meter, edit guide, pause control, 2 heads (record/playback & erase). Response 50-15,000 cps  $\pm 4$  db; S/N -45 db; 2 w. output; wow & flutter .2%. 15 1/4" x 10 1/2" x 8 1/2" .....\$169.95

**Model 400 Stereo Recorder**

Features replay double reverse for automatic, continuous 4-track stereo tape replay; repeat (replays any part of tape over & over); sound-on-sound; sound-with-sound; special bias for FM recording. Dual speed (7 1/2 & 3 3/4 ips). Has stereo amplifier, two 6" (8 ohm) speakers; 2 vu meters; automatic stop; edit guide; 3 heads (record-play-erase). Response 40-18,000 cps  $\pm 3$  db; S/N -45 db; 8 w./ch. output; 2 v. preamp output; wow & flutter .1%; ch. separation 50 db. 17 1/4" x 16" x 12 1/4" .....\$699.95

**Model 770 Stereo Recorder**

Features mute-monitor p.a. sw.; 3-speed (7 1/2, 3 3/4 & 1 1/2 ips); automatic stop; pause edit; stereo amplifiers; two 5" x 7" (8 ohm) speakers; 3 heads (record/playback-erase-special bias). Response 40-22,000 cps  $\pm 2$  db; S/N -50 db; 3 w./ch. output; wow & flutter .12%; ch. separation 65 db; 20 1/2" x 13 1/4" x 11" .....\$499.95

**Model 720 Stereo Recorder**

Features sound-with-sound; stereo amplifiers; two 4" (8 ohm) speakers; 3-speed

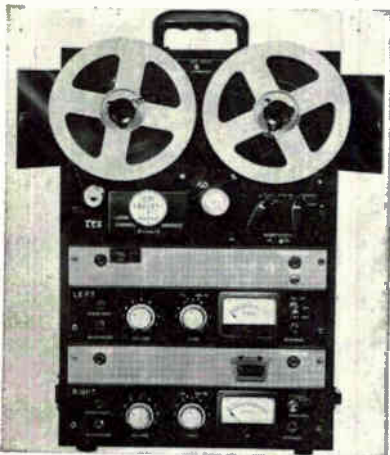

(7 1/2, 3 3/4 & 1 1/2 ips); automatic stop; pause edit; 2 heads (record/playback-erase). Response 40-15,000 cps  $\pm 2$  db; S/N 50 db; 3 w./ch. output; wow & flutter .12%; ch. separation 60 db; 20" x 14" x 9".....\$399.95

**Model 1660-D Stereo Recorder**

Tape deck with record/playback preamps. Features dual speed (7 1/2 & 3 3/4 ips); auto-



matic stop; two vu meters; edit guide; pause control. Response 30-18,000 cps  $\pm 3$  db; S/N -45 db; wow & flutter .2%; ch. separation 55 db; has 2 heads (record/playback & erase); 15" x 12 1/2" x 8" .....\$249.95

**Model 455-D Stereo Recorder**

Tape deck with stereo preamps. Has 2-speeds (7 1/2 & 3 3/4 ips); two vu meters; automatic stop; edit guide; 3 heads (record/playback/erase). Response 40-15,000 cps  $\pm 3$  db; S/N -45 db; 2 v. preamp output; wow & flutter .15%; ch. separation 50 db; 16 1/4" x 14" x 9".....\$499.95

**Model 1770-D Stereo Recorder**

Tape deck with stereo preamps. Has 3 speeds (7 1/2, 3 3/4 & 1 1/2 ips); two vu meters; automatic stop; pause control. 3 heads (record/playback, erase & a special bias head). Response 30-22,000 cps  $\pm 3$  db @ 7 1/2 ips & 40-12,000 cps  $\pm 3$  db @ 1 1/2 ips; S/N -45 db; wow & flutter .12%; ch. separation -55 db; 15" x 12 1/2" x 9" .....\$379.95

**Model 330 Stereo Recorder**

Features sound-on-sound; sound-with-sound; has 3 heads (record-playback-erase);



two vu meters; counter; stereo amplifier & 2 speakers.....\$349.95

**Model 4000-D Stereo Recorder**

Tape deck with stereo preamps. Features "Reversatile" replay & repeat, as in Model 400. Has dual speed (7 1/2 & 3 3/4 ips); two vu meters; automatic stop; edit guide; 3 heads (record, play, erase). Response 40-18,000 cps  $\pm 3$  db; S/N -45 db; wow & flutter .1%; ch. separation 50 db; 16 3/4" x 14" x 9" .....\$599.95

**Model 455 Stereo Recorder**

Features sound-on-sound, sound-with-sound; echo; 3 heads (record, play, erase);

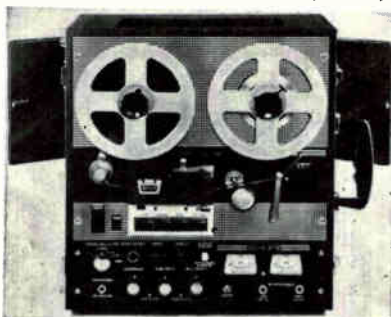

optional remote-control accessory & 10 1/2" reel adapter. 2-speed (7 1/2 & 3 3/4 ips) design with stereo amplifier & two 5" x 7" (8 ohm) speakers. Has automatic stop and edit guide. Response 40-17,000 cps  $\pm 3$  db; S/N -45 db; wow & flutter .15%; 8 w./ch. output; 2 v. preamp output; ch. separation 50 db; 18" x 17" x 11 1/2" .....\$599.95

**Model 1670 Stereo Recorder**

2-speed (7 1/2 & 3 3/4 ips) design with stereo amplifier & two 8" coax. (8 ohm) speakers. Has automatic stop; two vu meters; edit guide; pause control; special bias for FM

recording. Response 30-22,000 cps  $\pm 3$  db; S/N -45 db; 2 1/2 w./ch. output; wow & flutter .2%; ch. separation -55 db. Has 2 heads (record/play, erase); features sound-with-sound: 30" x 14 1/4" x 7" .....\$359.95

**Model 1640 Stereo Recorder**

2-speed (7 1/2 & 3 3/4 ips) design with amplifiers & two 5" x 7" (8 ohm) speakers. Has

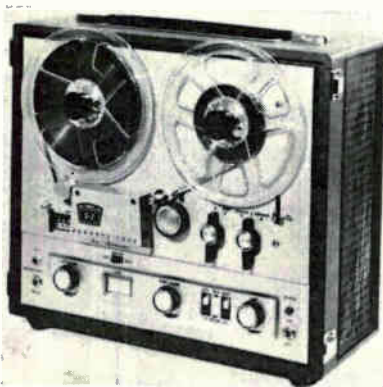

vu meters; automatic stop; edit guide; pause control; 2 heads (record/playback & erase). Response 40-18,000 cps  $\pm 3$  db; S/N -45 db; 2 1/2 w./ch. output; wow & flutter .2%; ch. separation -55 db; features sound-with-sound; 16 1/4" x 13 3/4" x 7 1/2" .....\$259.95

**Model 192 Mono Recorder**

Full-track or half-track 2 speed (7 1/2 & 3 3/4 ips) with changeover option; 2 heads (record/play & erase); amplifier; 4" x 6" (8 ohm) speaker. Has vu meter; pause control. Response 40-15,000 cps  $\pm 2$  db; S/N -50 db; 3 w. output; wow & flutter .18%; 5 1/4" x 14 1/2" x 9 1/4" .....\$349.95

**Model 1055 Tape Recorder**

Quarter-track with 4-track stereo; 2-speed (7 1/2 & 3 3/4 ips) design with stereo amplifiers & two 4" (8 ohm) speakers. Has level meter, automatic stop, edit guide, pause control. Response 50-15,000 cps  $\pm 3$  db; S/N -42 db; 2 1/2 w./ch. output; wow & flutter .2%; channel separation -50 db. Has 2 heads (record/play & erase). 13 1/4" x 13 1/4" x 9 1/4" .....\$199.95

**Model 1650 Stereo Recorder**

2-speed (7 1/2 & 3 3/4 ips) design with stereo amp & two 5" x 7" (8 ohm) speakers. Has two vu meters; automatic stop; edit guide; pause control; 2 heads (record/playback, erase). Response 30-18,000 cps  $\pm 3$  db; S/N -45 db; 2 1/2 w./ch. power; wow & flutter .2%; ch. separation -55 db. Features sound-with-sound & 3-way speaker switch. 16 1/4" x 13 3/4" x 7 1/2". Similar in appearance to Model 1640.....\$299.95

Note: All Roberts stereo models record 4-track stereo, play back 4-track & half-track stereo; record 4-track mono; play back 4-track, half-track & full-track mono. 15 ips speed optional on all models.

**SONY**

**Model 777-S2 Tape Recorder**

All-transistorized 2-track record and 2-and 4-track playback; 2-speed (7.5 & 3.75 ips) design; features special "Electro-Bilateral" head construction; three motors; complete remote control; sound-on-sound; mike & line mixing; tape and source monitoring; 3" vu meters; response 50-15,000 cps  $\pm 2$  db @ 7.5 ips; signal-to-noise ratio 50 db; flutter & wow less than .15% @ 7.5 ips; has built-in stereo preamp and out-

# 4 Tape Machines



put jacks for connection to external power amps; 16" w. x 17 1/4" h. x 9" d.; weight 43 lbs. ....\$695.00

## Model 777-S4 Tape Recorder

Same as Model 777-S2 except 4-track stereo record and 2- and 4-track playback .....\$695.00

## Model 200 Tape Recorder

Four-track stereo/mono record/playback system; features built-in stereo amplifier &



speakers (15' separation); 2 vu meters; sound-on-sound; two speeds (7.5 & 3.75 ips) & counter; response 50-14,000 cps @ 7.5 ips; flutter & wow less than .19% @ 7.5 ips; signal-to-noise ratio 45 db; inputs: 2 mic & 2 high-level line; supplied with two F-96 dynamic mics.....\$239.45

## Model 200A "Sterecorder"

Compact version of Model 200. Identical except for its stereo speaker system. Has



2 built-in speakers with adjustable sound deflection panels. Complete with portable carrying case & 2 dynamic mics.....\$169.50

## Model 211-TS "Slide Sync" Tape Recorder

Has built-in electronic slide sync pulse generator for programming an automatic slide



projector; does not require metallic stripping on tape; features sound-on-sound; built-in amp & speaker; two speeds (3.75 & 1 1/2 ips); response 70-8000 cps; inputs: mic & high-level; outputs external speaker, high-impedance earphone monitor & automatic projector; 10" w. x 8 1/4" x 4 1/4"; supplied with microphone & projector connecting cord .....\$139.50

## SRA-2L Stereo Recording Amp

For use with Model 263-E tape deck; amplifier will provide all facilities for 4-track stereo or mono record and playback; has stereo or individual channel selector switch equalization for both 7 1/2 & 3 3/4 ips; dual vu meter record level indicators; inputs for magnetic phono, microphone and radio; separate volume controls for line microphone mixing; response 30-18,000 cps @ 7.5 ips with 263-E; 12 1/8" w. x 8 1/2" d. x 3 3/8" h.....\$109.50

## Model 263-E Tape Deck

Features 2-speed (7 1/2 & 3 3/4 ips); 4-track stereo or mono; built-in stereo preamps;



3-head design; automatic shutoff; automatic tape lifter; pause control; 7" reels & digital counter. Response: heads capable of 30-18,000 cps @ 7 1/2 ips; flutter & wow less than .17% @ 7 1/2 ips. Half-track erase, record, playback heads. 14" w. x 11" d. x 6 1/2" h. Walnut cabinet base.....\$129.50

## Model SRA-3 Recording Amp

Designed as a companion to Model 263-E tape deck; for 4-track stereo & mono recording & playback. Also compatible with earlier Models 262-D & 263-D tape decks. Has microphone & high-level inputs. Response 30-18,000 cps.....\$109.50

## Model 905-A "Voice Command" Recorder

Battery operated, transistorized design that starts & stops by voice command. Has



a.g.c. which automatically re-adjusts gain for changes in recording level. Has 4 rechargeable pen-size batteries; monitor speaker; remote stop/start sw. on mic. Features 2-speed (3 3/4 & 1 1/2 ips); mic & aux. inputs; 3 1/4" reels; response 90-9500 cps. Supplied with detachable amplifier/speaker unit, leather case & batteries.....\$129.50

## SSA-777 Amplifier/Speaker System

Designed for use with Models 777-S2 and 777-S4 tape recorders; all-transistorized

OTL power amplifier with 8" speaker and infinite baffle; features bass, treble, level controls, plus high-level input and provision for external speaker; supplied with portable case .....\$175.00

## Model 250 Tape Recorder

All-transistor stereo design; with record & playback preamps. 4-track; vu meters; auto-



matic shutoff; automatic tape lifters; single-knob operation; 7 1/2 & 3 3/4 ips; flutter & wow .19% @ 7 1/2 ips; response 50-14,000 cps; S/N 50 db. Has mic. & line inputs. 14 1/2" w. x 6 1/2" d. x 9" h.....\$119.50

## Model MX-777 Mixer

Accessory for Models 777-S2 and 777-S4 tape recorders; six-channel all-transistor

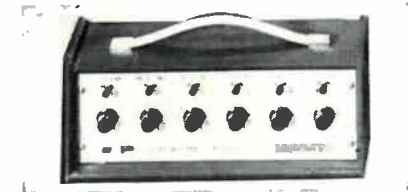

stereo/mono design; contains six matching transformers for balanced microphone inputs and recorder outputs plus individual level controls; channel selector switch for each input; switch for mixing one microphone into both channels; complete with case .....\$175.00

## Model 102 Tape Recorder

Two-track mono, 2-speed (7.5 & 3.75 ips) design; features built-in amplifier & speak-



er; mike & line mixing; vu meter; pause control; response 50-12,000 cps @ 7.5 ips; flutter and wow less than .2% @ 7.5 ips; inputs mic. & line; outputs line & external speaker; supplied with F-96 dynamic mic .....\$129.45

## Model 600 Tape Recorder

Four-track stereo/mono record/playback design; features two speeds (7.5 & 3.75 ips); mic. & line mixing; source & tape monitoring; two vu meters (switchable for

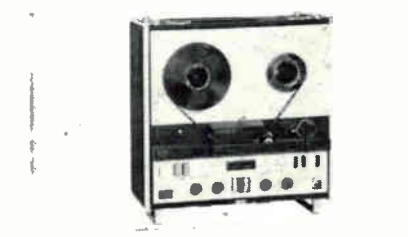

INTRODUCING  
THE  
INCOMPARABLE  
CONCERTONE  
800



And beyond compare it is. There's simply no other way to describe Concertone's incomparable Series 800. It's unique in the stereo tape recorder field. Only the Concertone 800 has six heads. (Let's you record and play in both directions continuously without flipping reels.) Double Reverse-o-matic® plays any tape automatically to and fro for as long as you wish. Simple, too. Easy push button operation. Built-in echo control, sound on

sound control, two dynamic microphones, twin speakers, three motor system, center capstan drive. And there's more. In fact, we have a brochure crammed with facts. Send for it. You'll be amazed that the incomparable Concertone 800 (portable or tape deck) gives you so much. Prices start at \$379.95. For full details write to Concertone, Box 3227, South El Monte, California.

CONCERTONE 

**This  
“speaker”  
isn’t  
listed  
in your  
Directory.**



It's *HiFi/Stereo Review*—favorite spokesman on the subject of high fidelity for over 150,000 audiophiles and music lovers everywhere.

And *how* it speaks up! Straight from the shoulder—with impartial laboratory reports on new hifi/stereo equipment. Good verdict or bad, you always get invaluable information that will guide you to the finest components in your price range, throughout the next twelve months!

Our record reviewers are equally outspoken. Each month, they listen to 150 or more of the latest recordings and tapes, mono and stereo, in every musical category from classical to jazz, and report their verdicts unflinchingly. Some releases are praised highly—others are thumbed down. Result? You'll avoid disappointment—make every dollar count—as you add outstanding selections to your music library.

Over 150,000 regular monthly readers like the way *HiFi/Stereo Review* speaks out in their behalf—and so will you! You'll also like the informative profiles on your favorite artists...and the wide scope of engrossing features on the world of music. Lively—abundantly illustrated!

Indispensable for every audiophile and music lover, *HiFi/Stereo Review* is now available to you at a very special low price...

**SPECIAL INTRODUCTORY OFFER**

**12** issues of *HiFi/Stereo Review*  
**\$2.95** (REGULAR RATES:  
 ...only **50¢** a month  
**5** a year—  
**50¢** a month)

**FILL IN, DETACH AND MAIL THIS POSTPAID CARD TODAY!**

***Bonus!***

If you enclose payment with your order, saving us billing costs, we will add **2 EXTRA ISSUES** to your subscription! That's 14 in all for the same low **\$2.95!**

If card has already been used, write to:  
 HiFi/Stereo Review, Dept. 3-0050  
 434 So. Wabash Ave., Chicago, Ill. 60605

reacting input or recorded signal); sound-with-sound; sound-on-sound; automatic shut-off; cathode-follower line outputs & special equalized magnetic phono input; response 30-18,000 cps @ 7.5 ips; S/N ratio 50 db; wow & flutter .17% @ 7.5 ips; inputs: two high-level line, 2 mics or magnetic phono (switch selected); outputs: two 600-ohm "0" db line, 600-ohm binaural earphone monitor; supplied with carrying case & two Model F-87 dynamic cardioid pattern mics; has stereo preamps but does not have built-in power amps or speakers .....\$449.95

### Model 111 Tape Recorder

Mono 2-speed (3.75 & 1 7/8 ips) design featuring record level indicators; 5" reel capac-



ity; pause control; built-in amplifier and speaker; response 70-8000 cps @ 3.75 ips; high-impedance microphone and radio inputs and output for external, 8-ohm, 2-watt speaker; 8 3/4" w. x 7 3/4" x 4 1/4"; wt. 10 lbs.; complete with microphone and carrying bag .....\$79.50

### Model 500 Tape Recorder

Four-track stereo/mono record & playback; 2-speed (7.5 & 3.75 ips) design; has built-

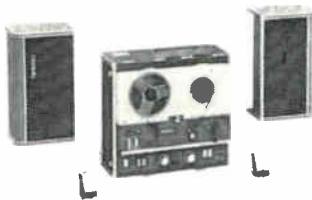

in stereo amplifiers & speakers which can be detached for 15' separation; features mic & line mixing; sound-on-sound; two vu meters; automatic end-of-reel shut-off; response 50-14,000 cps  $\pm$  2 db @ 7.5 ips; S/N ratio 50 db; wow & flutter .17% @ 7.5 ips; inputs: 2 mic & 2 high-level aux.; outputs: two 600-ohm line, two 8-ohm ext. speakers, 8-ohm binaural headphone jack; supplied with carrying case & two F-87 dynamic cardioid pattern microphones .....\$399.45

### Model 801-A Battery-Operated Portable

Two-speed (3.75 & 1 7/8 ips) with 5" reel capacity; features remote stop/start switch;



vu meter for both recording level & battery condition indication; built-in amp & speaker; requires 1.5 watts, 9 v. d.c.; response 90-9000; inputs: mic., aux. line; output: earphone monitor; 13 lbs.; 12 3/4" x 1 3/4" x

3 1/2".....	\$249.95
Fitted leather carrying case.....	\$ 10.00
Footswitch (attached to variable back-spacing lever on recorder).....	\$ 19.50
Car battery converter (plus 12 v. into cig. lighter).....	\$ 19.50
A.C. converter.....	\$ 24.50
Three-input mixer.....	\$ 22.50

### TANDBERG

#### Series 8 Tape Recorders

Two-speed (3.75 & 1 7/8 ips) mono design; response 40-10,000 cps  $\pm$  2 db @ 3.75



ips, 40-5500 cps  $\pm$  2 db @ 1 7/8 ips; wow & flutter better than .2% @ 3.75 ips; built-in 7" x 4" speaker; 3 watt output; signal-to-noise ratio 50 db below max. recording level; has recording level indicator; crystal microphone, four-digit counter; 15" l. x 11 3/4" w. x 6 3/4" h.

Model 821 Two-track.....	\$219.50
Model 821F Two-track with built-in solenoids; foot pedal for remote control.....	\$294.50
Model 841 Four-track.....	\$237.50
Model 841F Four-track with built-in solenoids; foot pedal for remote control.....	\$312.50
TC-58 Luggage-type carrying case.....	\$24.50

#### Model 74B Tape Recorder

Three-speed (7.5, 3.75, & 1 7/8 ips), 4-track stereo & mono record/playback with out-



put amplifiers & stereo 7" x 4" built-in speakers; has automatic tape stop, pause control, counter, level indicators. Permits sound-on-sound. Response 30-16,000 cps  $\pm$  2 db @ 7.5 ips; 40-10,000 cps @ 3.75 ips & 55-5000 cps @ 1 7/8 ips. Wow & flutter .15% @ 7.5 ips, .2% @ 3.75 ips, .3% @ 1 7/8 ips; inputs 2 mics, .00125 v. r.m.s., 3.3 megohms—2 line, adjustable .007-7 v. r.m.s., 500,000 ohms. Signal-to-noise ratio at least 55 db. Playback outputs 4 ohms. Has teakwood cabinet with TC57B luggage carrying case.....\$449.50  
CM-6 Crystal mic. (30-12,000 cps) \$ 15.00

#### Models 64 & 62 Tape Recorders

Record/playback machine; three speeds (7.5, 3.75 & 1 7/8 ips); four-track stereo/mono record & 2- and 4-track stereo/mono playback; has separate record, playback, erase heads; built-in facilities for sound-on-sound, echo effects, track adding, direct monitor, and remote control; features FM-MX filter input for direct recording of FM multiplex stereo programs; dual-channel record & playback preamps; response 30-16,000 cps  $\pm$  2 db @ 7.5 ips;

# WRITE FOR QUOTATION

FACTORY SEALED CARTONS  
FRANCHISED DISTRIBUTOR  
QUICK SHIPMENT

the  
'MOST' IN  
DISCOUNTS  
ON ANY HI-FI  
COMPONENTS

## SOUND REPRODUCTION INC.

34 New Street, Newark, N. J. (07102)

(201) Mitchell 2-6816

CIRCLE NO. 56 ON READER SERVICE CARD



### WOLLENSAK Tape Recorders

deliver a wallop bigger than many twice its size. WE HAVE THE MOST COMPLETE SELECTION ANYWHERE. NEW MODELS INCLUDE 524, 1220, 600, 1400, 1414, 1500, 1515, 1280, 1281, 1580, 1780, 1980, 1981. Your order receives our prompt attention. FANTASTIC PRICES for name brand and special purpose magnetic tapes!

REQUEST COMPLETE TAPE RECORDER DISCOUNT SHEET

#### EICO new Transistor Stereo/Mono 4-track Tape Deck

Model RP 100W  
Completely assembled, wired and tested with 3 heads, and stereo record and stereo playback pre-amplifiers.

Model RP 100K  
Semi-Kit includes transport completely assembled and tested with 3 heads, and control electronics, stereo record, and stereo playback pre-amplifiers in easy-to-assembly kit form.

We now have the EICO 2400 series, 3 motor decks in both factory and kit form. Write SAXITONE for low quotes on EICO decks.

#### TAPE STORAGE OR CARRYING CASE

reg. 9.95, now 5.95  
Heavy wood construction, waterproof vinyl covering. Holds up to 24 tapes.)

reg. 2.75, now 1.79  
(Pressed cardboard, holds 10 tapes or 60 45 rpm records.)

#### SAXITONE RECORDING TAPE

275' Plastic, 3" reel.....	.35
600' acetate (plastic), 5 inch.....	.70
600' MYLAR 5 inch reel.....	.75
900' MYLAR (Polyester), 5 inch.....	.89
1200' MYLAR, 1/2 mil, 5 inch reel.....	1.18
1200' acetate (plastic), 7 inch.....	.99
1300' MYLAR, 1 1/2 mil (strong).....	.98
1800' acetate (plastic) 7 inch.....	1.19
1800' MYLAR 1 mil, thick, 7 inch.....	1.59
2400' MYLAR, untensitized, 7 inch.....	2.79
2400' MYLAR, tensitized, 7 inch.....	2.79
3600' MYLAR, tensitized, 7 inch.....	3.89
Revere M-2 blank cartridge tapes.....	3.33
30% off Revere automatic music tapes	

Plus Postage (Greater discounts to quantity buyers.)

SAVE 30-60%  
4-track stereo music on tape  
FREE 50-PAGE CATALOG

SAXITONE

1776 Columbia Road, N. W., Washington 9, D. C.  
CIRCLE NO. 51 ON READER SERVICE CARD

# 4 Tape Machines

40-11,000 cps  $\pm$  2 db @ 3.75 ips; 50-5500 cps  $\pm$  2 db @ 1 7/8 ips; output 1.5 v. cathode-followers; flutter & wow .1% r.m.s.

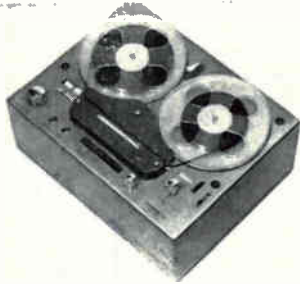

@ 7.5 ips; signal-to-noise ratio at least 55 db; has two each microphone, hi-level, & hi-level with filter inputs.

Model 64 .....\$498.00  
Model 62 Same as Model 64 but with half-track heads .....\$498.00

## Model 65 Stereo Playback Deck

Three-speed (7.5, 3.75, 1 7/8 ips), 4-track stereo playback tape deck; response 30-

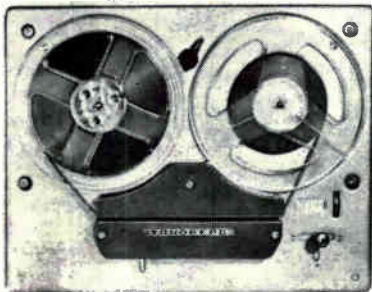

20,000 cps @ 7.5 ips, 30-15,000 cps @ 3.75 ips, 50-7000 cps @ 1 7/8 ips; hysteresis synchronous motor; lever knob for playback, fast forward, fast reverse; 4-digit revolving counter; complete mechanical drive; 16" x 12" x 6". .....\$199.50

## TRUVOX

### PD-100 Stereo Tape Recorder

Three-speed (7 1/2, 3 3/4 & 1 7/8 ips) unit with 3 motors; three heads with off-the-tape monitoring during record; built-in echo; sound-on-sound; separate mixing line & mic. inputs each channel, auto-reset 4-digit counter; built-in splicing plate; independent vu meter ea. chan.; monitor headphones; jacks. Response 30-20,000 cps  $\pm$  3 db @ 7 1/2 ips; 30-12,000 cps  $\pm$  3 db @ 3 3/4 ips; 50-80,000 cps  $\pm$  3 db; wow & flutter less than 0.1% @ 7 1/2 ips. Signal-

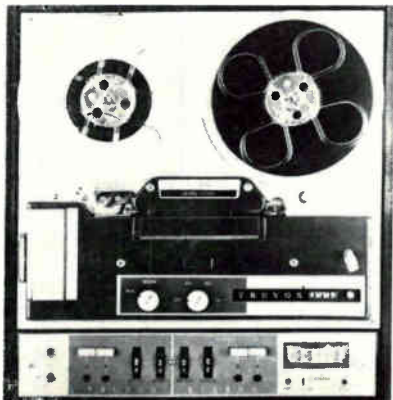

to-noise ratio 50 db; channel separation 55 db. Inputs per channel: 1-mv. 2-meg. mic., and 150-mv 0.5-meg. line. Bias freq. 90 kc. Less microphones & base.....\$399.50  
Oil-Finished walnut base.....\$ 20.00

## UHER

### Model 4000S Portable Tape Recorder

All-transistor, 2-track, 4-speed (7 1/2, 3 3/4, 1 7/8 & 1 5/16 ips) mono design; powered by



four flashlight cells or rechargeable battery (6-24 v.) or separate 115-volt power supply; electromagnetic start/stop remote control by means of microphone or remote switch; vu meter and power supply indicator; acoustic switch available for sound control for start and stop of tape; response 40-22,000 cps  $\pm$  3 db @ 7 1/2 ips; 40-17,000 cps @ 3 3/4 ips; 40-10,000 cps @ 1 7/8 ips; 40-4500 cps @ 1 5/16 ips; wow & flutter .15% @ 7 1/2 ips; output speaker 1 watt; inputs: microphone .1 mv. @ 1000 ohms; radio 1 mv. @ 20,000 ohms; phono 50 mv. @ 1 megohm; 3 hours playing time with flashlight cells; 10 1/2" x 8 1/2" x 3 1/4"; weight without batteries 6 lbs.; complete with remote control dynamic microphone, leather case, shoulder strap, a.c. power unit, battery charger, and "Dryfit" storage battery .....\$399.95

### "Universal S" Tape Recorder

Standard half-track mono recorder; 3 speeds 1 5/16, 1 7/8, 3 3/4 ips; basically designed for voice recording but has 40-16,000 cps response at 3 3/4 ips; digital counter; automatic tape stop; low-impedance microphone input; high-impedance inputs for mic., telephone pickup, radio/phono; outputs for earphones; external amplifier and speaker; connections for voice-operated control and slide-projector synchronizer; response 40-4000 at 1 5/16 ips; 40-8000 cps at 1 7/8 ips; signal-to-noise ratio 45 db; wow & flutter .3% @ 3 3/4 ips; output (speaker) 3 watts; sensitivity .1 mv./200 ohms for mic.; 1 mv. 22,000 ohms for radio, 100 mv./2 meg-ohms for phono; features include relay/solenoid control system permitting remote control of record, play, and tape motion; 24 lbs.; includes remote control, dynamic microphone, dust cover, trick key, and carrying case .....\$254.95

### "Universal 5000" Recorder

All-transistor, 2-track, 3-speed (1 5/16, 1 7/8 & 3 3/4 ips), 6" reel design. Response 40-

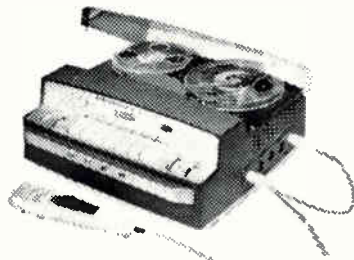

16,000 cps @ 3 3/4 ips; S/N 50 db; wow & flutter .2% @ 3 3/4 ips; output 2.5 w. Has digital counter, automatic recording level control, provisions for automatic slide pro-

jector control; vu meter & inputs for low-impedance mic., radio, phono, telephone pickup, loudspeaker & earphones; 6" x 10" x 12" .....\$299.95

## Model 8000 Tape Recorder

Four-track stereo/mono record & playback; completely transistorized; separate record/playback heads; features built-in impulse transmitter for automatic slide-projector synchronization; echo effect; remote control; sound-on-sound; automatic shut-off; has built-in stereo speakers, 2 w./ch.; 3 mic. inputs; radio & phono inputs; headphone output; 2 remote speaker outputs; 4 speeds (7.5, 3.75, 1 7/8 & 1 5/16 ips); will accept 7" reels; response 50-20,000 cps  $\pm$  3 db @ 7.5 ips & 50-4000 cps @ 1 5/16 ips; wow & flutter .15% @ 7.5 ips; 117-volt a.c. operation; 14" x 15" x 7"; 23 lbs.; supplied with one dynamic mic. & portable case.....\$419.95

## VERNON

### Model 47/26 Transistorized Stereo Recorder

Completely self-contained with amplifiers and 5 speakers; vertical mtg. kit; flush

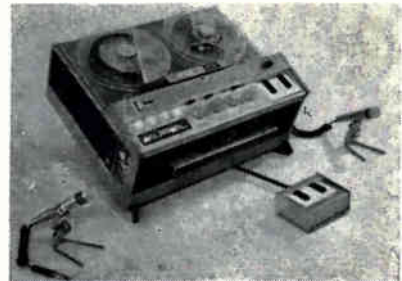

mounting kit; 2 omnidirectional dynamic mics; features 47 transistors, 26 diodes; 10 w./ch.; vu meters; 3 separate heads; 3 motors; automatic shut-off; automatic rewind & replay; 3 inputs/ch. with intermix; can be used as p.a. system & for sound-on-sound and echo effects; two speed (7.5 & 3.75 ips); response 30-20,000 cps  $\pm$  3 db @ 7.5 ips, 30-15,000 cps @ 3.75 ips; signal-to-noise 50 db @ 7.5 ips; flutter & wow less than .15% @ 7.5 ips; HD 1%; crosstalk -45 db; bias freq. 85 kc.; input jacks: mic. (10K), radio (1 meg.), aux. (250K); 15 1/2" x 13 1/2" x 7 3/8" .....\$600.00  
Remote control unit (piano keyboard type) .....\$ 25.00

## VIKING

### Model 87 Series Tape Decks

Two-speed (7.5 & 3.75 ips); 4-pole motor hysteresis synchronous motor available



at extra cost); flutter & wow .2% r.m.s.; long-term speed regulation .5%; digital counter and tape run-out switch; handles up to 7" reels; wt. 12 1/2 lbs.; panel size 13" x 9 1/2".

Model 87P Playback only, half-track mono head .....\$138.00  
Model 87R Record/playback, half-track mono, 2 heads.....\$144.00  
Model 87Q Playback only 1/2- & 1/4-track mono & stereo, 1 head.....\$141.05  
Model 87RQ Record 1/2-track mono, playback 1/4- & 1/2-track mono & stereo; 3

heads .....\$165.00  
 Model 87ES Record/playback 1/2-track mono & stereo, 2 heads.....\$157.85  
 Model 87RMQ Record 1/4-track, playback 1/4- & 1/2-track mono & stereo, 3 heads .....\$170.30  
 Model 87 ERQ Record 1/2-track, playback 1/4 & 1/2-track mono & stereo, 3 heads .....\$178.65  
 Model 87ESM Record/playback 1/2-track mono & stereo, 3 heads.....\$185.50

Prices quoted are for tape decks only; for recording with Model 87RQ, ERQ, RMQ, & ESM, use RP83-3 record/playback amplifier; for other models use RP83. For stereo design, use two amplifiers.

**Model 87 "Super-Pro" Tape Recorders**

All models supplied with carrying case; additional bottom chassis permits input and output connections to be made from front; center storage compartment; all models record and play mono and stereo; all three-head models permit sound-with-sound and sound-on-sound recording.

Model 87ES tape deck with two RP83 amplifiers .....\$382.35  
 Model 87ERQ tape deck with two RP83-3 amplifiers .....\$407.15  
 Model 87RMQ tape deck with two RP83-3 amplifiers .....\$398.80  
 Model 87ESM tape deck with two RP83-3 amplifiers .....\$414.00

**Model 88 "Stereo Compact" Tape Recorders**

Same as "Super-Pro" series except single dual-channel preamp system is used; con-

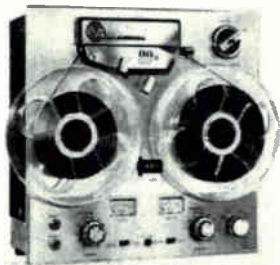

trols: record/playback, gain control, function selector, stereo microphone inputs, stereo/mono switch, record warning light, normal-duplicate switch (can record directly from heads of another deck); two vu meters; sound-on-sound, sound-with-sound; Series 88 tape decks have head-shift control. Two models available Model 88 RMQ Three 1/4-track heads. Records 1/4-track only, stereo/mono. Plays 1/4- or 1/2-track stereo or mono.....\$139.95  
 Model 88ERQ 1/2-track erase & record heads, 1/4-track playback head. Records 1/2-track mono or stereo. Plays 1/2-track or 1/4-track mono or stereo.....\$347.95  
 Oiled walnut enclosure.....\$ 15.95

**Model 880 Stereo Compact**

Same as Model 88 except has transistorized

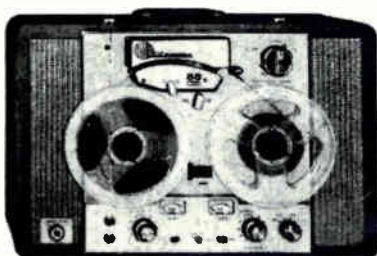

stereo power amplifiers & stereo speakers. Model RMQ 1/4-track record/play....\$425.00  
 Model ERQ 1/2-track record & 1/2 & 1/4-track play.....\$433.00

**Model RP83 Record/Playback Preamp**

Response: recording, 30-16,000 cps ±3 db @ 7.5 ips; 30-12,000 cps @ 3.75 ips;

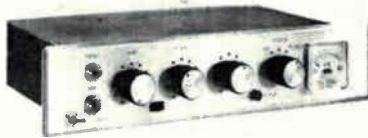

playback, 25-20,000 cps @ 7.5 ips, 25-14,000 cps @ 3.75 ips; output 1 v. to power amplifier; monitor output 1 v. to headphones; high- and low-level inputs with individual level controls; vu meter; 3-position selector switch; playback output level controls; signal-to-noise ratio 50 db @ 7.5 ips with harmonic recorded 6 db below saturation; harmonic distortion 1%; tube design. 11 1/8" x 2 3/16" x 5 1/2" d. behind panel; two required for stereo operation; for use with 2-head designs.....\$92.50

**Model RP83-3 Record/Playback Preamp**

Same as Model RP83 except for 3-head designs. ....\$94.50

**"Retro-Matic" 220 Tape Recorder**

Features two-directional automatic playback; remote control; simultaneous recording & playback; photoelectric run-out sensor; level meters; 7.5 ips & 3.75 ips dual-speed, quarter-track stereo operation: response 20-25,000 cps ±3 db record/playback @ 7.5 ips; monitor output 6 w./ch. to 4 or 8 ohm speakers or 4 to 600 ohm phones; output to music system 1 v./ch. low impedance; input sensitivity: high



level. 100 mv., 250K; low level, 1 mv., 2 megohms; 55 db signal-to-noise ratio; dist. 1% at "0" vu; flutter & wow less than .2% r.m.s. @ 7.5 ips; 7" reel size; 15" h. x 16" w. x 8" d. behind panel.....\$860.00

Remote control center.....\$ 59.95  
 Walnut case.....\$ 31.95

**Model 77 Tape Recorder**

Dual speed (7 1/2 & 3 3/4 ips); 1/4-track mono or stereo record/playback; with re-

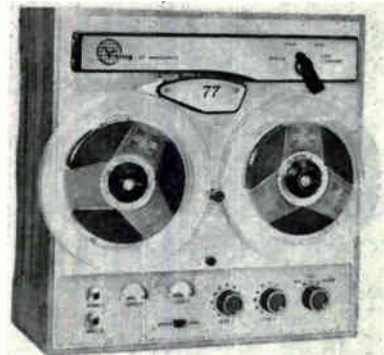

cord & playback stereo preamps. Has high-level input (200 mv.) & low-level (1 mv.); vu meters; 2 hyperbolic contour heads (erase & record/playback). Will play back half-track mono. Response 50-16,000 cps ±3 db @ 7 1/2 ips; S/N 50 db; HD 1% flutter & wow .2% @ 7 1/2 ips; output from preamp is 1 v.; 13" x 13" x 6 1/4" .....\$239.95  
 Oiled walnut cabinet.....\$ 15.95

**Model 770 Tape Recorder**

Same as Model 77 but includes transistorized 2 w./ch. stereo power amp & 2 wide-range

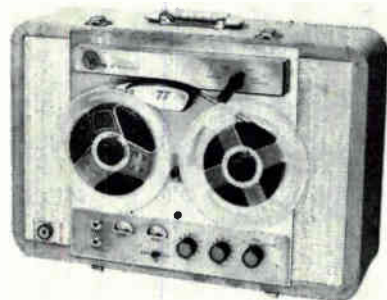

built-in speakers. Has vinyl case with detachable cover.....\$325.00

**C-800 Spkr./Amp System**

Portable case with built-in power amps & spkrs. for Models 77 & 88.....\$99.50

**Model 96 Professional Tape Deck**

Rugged design, 10 1/2" reel capacity; choice of dual-speed operation (7 1/2-15 ips, 7 1/2-3 3/4 ips, or 3 3/4-1 1/2 ips). Has connector for remote control of play-stop, fast forward-stop-rewind. Will accept up to 4 heads—

**erase tape without rewinding!**

**AEROVOX PROFESSIONAL HEAVY-DUTY DEGAUSSER**

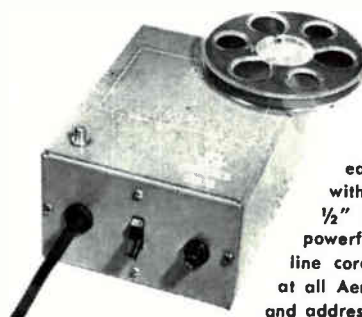

Acclaimed by leading hi-fi magazines. Quickest and easiest to use. Completely erases new and old tape . . . without rewinding! Handles all 7" and 10" spools up to 1/2" widths. Operates from any 110 VAC supply. Most powerful demagnetizing field of any device. Comes with 6' line cord and screw-in fuse; shipping wt. 15 lbs. Available at all Aerovox Parts Distributors at \$49.95 net. Write for name and address of nearest distributor.

**AEROVOX CORPORATION, Distributor Division, New Bedford, Mass.**

CIRCLE NO. 3 ON READER SERVICE CARD

any choice. S/N 55 db @ 7½ ips; flutter & wow .1% @ 7½ ips. Face plate 19" x 12¼". Price varies depending on heads used—ranging from \$552.00 for a dual ½-track design to \$599.00 for 4-head ¼-track combination.

**RP62VU Record/Play Preamp**

For use with Model 96 tape deck. Two needed for stereo operation. Inputs: high-impedance mic & radio or phono. Output .7 v. high impedance. 19" w. x 5¾" h. x 7" d.....\$143.75

**RP62VU—3 Record/Play Preamp**

Same as RP62VU except for use with 3-head tape transport.....\$145.75

**Model 78 Tape Deck**

Two speed (7½ & 3¾ ips); 4-pole motor; flutter & wow less than .2% r.m.s.; speed regulation .5%; 7" reel max. Can be used vertically or horizontally. Will accommodate

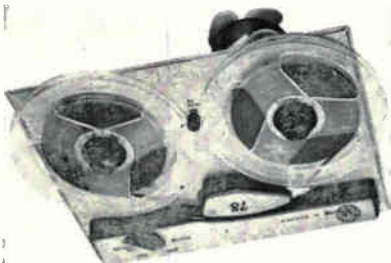

up to 3 separate heads. Panel 13" w. x 9½" h. x 3¾" deep behind panel (front knob clearance 1⅜").

- Model 78P Playback only ½-track mono .....\$85.00
  - Model 78R Record/play ½-track mono .....\$90.00
  - Model 78Q Playback only ¼-track mono or stereo .....\$101.00
  - Model 78RQ Record/play ½-track mono; play ¼-track stereo & mono.....\$113.80
  - Model 78HQ Record/play ¼-track stereo & mono .....\$110.50
  - Model 78RM Record/play/monitor ½-track mono.....\$ 99.05
  - Model 78S Playback only ½-track stereo or mono .....\$102.80
  - Model 78ES Record/play ½-track stereo & mono.....\$113.55
- For record/play preamps use Model RP83 or RP83-3.

**V-M CORP.**

**1471 Tape Recorder**

4-track stereo or mono record/playback system including stereo preamps. Features



3-speed (7½, 3¾ & 1⅞ ips); sound-with-sound; automatic shut-off; pause button; monitor sw.; level indicators; counter; with external power amp & speaker can be used as a p.a. system. Response 50-15,000 cps; S/N 50 db; separation 50 db; wow & flutter .3% r.m.s. at 7½ ips; inputs permit recording from mic., phono, radio, or TV. 8" h. x 13" w. x 14¼" d.....\$179.95  
Model 1471 Aluminum case.....\$ 12.50

**4 Tape Accessories**

**AEROVOX**

**Model 710 Degausser**

Will demagnetize magnetic tape up to 10" reels, 1" wide, without rewinding; heavy-

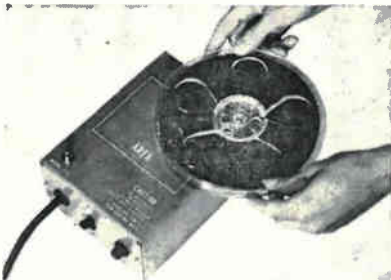

duty design; 110-130 v., 10 amps ....\$49.95

**AMPLIFIER CORP.**

**Model 150A "Magneraser" Junior**

Bulk-type magnetic tape eraser; field intensity 750 gauss; duty cycle on one min.,



off five min.; can also be used to demagnetize sound film up to 35 mm. on plastic or metal reels; 4¾" x 4¾" x 2½"; 117-v. operation .....\$18.95

**Model 200C "Magneraser"**

Bulk tape eraser; operating voltage 100-130 volts; operating frequency 50-60 cps; 2" high, 4" dia.

Model 200C.....\$24.00  
Also available: Model 220C, identical in price and specifications except for operating voltage of 200-260 volts.

**Model 300A "Magneraser" Senior**

Heavy-duty design; 800 gauss; on 7 min., off 7 min.; for use on reels up to 10½"



and ¼" and ½" wide tapes as well as sound films up to 35 mm.; 7" dia. x 3¾"; 117-v. operation.....\$49.00

**AUDIOTAPE**

**Audio Head Alignment Tape**

Prerecorded at 2 kc., 10 kc., 15 kc., recorded at 15" per second; intervals between tones are 5 seconds duration; 300 ft. on 4" reel.....\$10.00

**Audio Head Demagnetizer**

Demagnetizes tape recorder heads; re-



quires only plug-in to conventional a.c. outlet .....\$10.00

**AUDIOTEX**

**Model 30-114 Tape Demagnetizer**

Handles all reel sizes up to 10½"; crases to -52 db level; complete with 6-foot

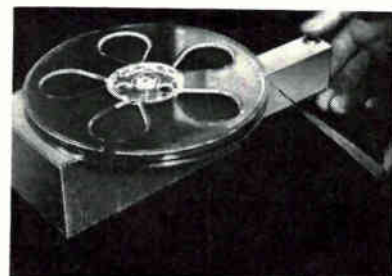

cord; on-off push-button.....\$33.00

**Model 30-112 Head Demagnetizer**

Has curved top to reach most heads; soft plastic coating on tip to prevent head



damage; built-in push-button switch; 6-foot cord.....\$11.95

**CONCERTONE**

**Model 18 Head Demagnetizer**

Pencil-type will demagnetize any tape recorder head .....\$4.95

**Tape Timer-Strobe**

For determining accuracy of tape speed; uses dial and features strobe for instant visual speed check; times length of tape in minutes and seconds.....\$18.95

**DUBBINGS ELECTRONICS**

**TapeStrobe**



Chrome-plated stroboscopic wheel, ground to .0003" accuracy.

- Model A 7.5-15-30 ips.....\$22.50
  - Model B 3.75-7.5-15 ips.....\$22.50
  - Model C 1½-3.75-7.5-15 ips.....\$24.50
- For 50 cycles operation, add \$5.00 to each of the above-quoted prices.



**FANON-MASCO**

**RA-34 Head Demagnetizer**

117-v. a.c. operated; 4 1/2" l. x 2" dia., wt. 8 oz.....\$4.50

**RA-33 Bulk Tape Eraser**

117-v. a.c. operated; flux density of 3500 gauss @ 1 cm. 5 1/2" x 5 1/2" x 4 1/2" h.....\$19.95

**KNIGHT-KIT**

**KP-70 Record/Playback Preamp**

Separate record/playback sections allow 2- or 3-head operation, monitoring record-



ing, sound-on-sound, recording with echo chamber effect; 6-position selector switch for playback and record each channel, or stereo record and playback; vu meters for both functions; adjustable high frequency recording pre-emphasis; printed circuits; record section sensitivity .0005 volt at mic. input, .080 volt at aux. for maximum recording level; record distortion less than 0.3% at maximum record level; bias oscillator 65 kc; master gain and individual channel balance control.  
83YU916—KP-70 (kit).....\$ 89.95  
83YX936 Metal case.....\$ 4.95  
83YU559 Factory wired.....\$139.95

**LAFAYETTE**

**99-6194 Miniature Tape Heads**

Two-piece set consisting of one record/playback and one erase tape head; de-



signed for use in dual-track miniature tape recorders or for experimentation; response 100-7000 cps ±5 db; signal-to-noise ratio better than 45 db; bias system a.c. and d.c.; impedance 5500 ohms at 1 kc.; d.c. resistance 169 ohms; 1 1/16" w. x 7/16" h. x 3/32" d. (approx.).....\$3.95

**99-1516 Bulk Tape Eraser**

Provides tape noise level 4-6 db below noise level from recorder erase heads:



pilot light; fused; draws 6 1/2 amps; 110-120 volts, 60-cycle a.c. operation.....\$18.95

**MICROTRAN**

**Model HD-40M Tape Head Demagnetizer**



Will remove permanent magnetization; reduces noise level and harmonic distortion; improves signal-to-noise ratio; high-impact epoxy molded; 4" l. x 1 1/4" dia.....\$6.15

**Model HD-11M Bulk Eraser**

Heavy-duty magnetic tape eraser for tapes up to 1/2"; noise level is reduced below



level of standard erase head; accepts reels from 5" to 10 1/2"; high-impact epoxy molded; 7" l. x 3 1/2" w. x 3 1/4" h.....\$18.95

**NORTRONICS**

**Model P-6 Conversion Kit**

Converts all Pentron mono and 2-track stereo tape recorders to 4-track stereo playback; patch cord and jack set to connect to external stereo playback amplifier included.....\$29.70

**Model P-7 Conversion Kit**

For Pentron recorders; includes 4-track stereo erase head; replaces mono erase head; used with P-6, permits stereo erase during stereo recording.....\$15.00

**Model R-67 Conversion Kit**

Converts Roberts, Metzner, Akai, and Terrecorder tape recorders to 4-track stereo

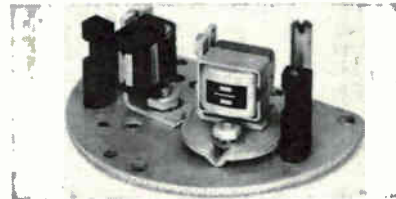

playback while retaining existing mono record/play capabilities; allows 4-track stereo recording with additional amplifier (not included).....\$39.00

**Model W-2 Conversion Kit**

Converts Webeor Series 210, 2020, 2100, 2600, and 2700 to 4-track stereo playback only; may not be used for recording unless external amplifiers are used (not included).....\$27.50

**Model W-6 Conversion Kit**

Converts all Webeor 2800, 2900, 2000 Series (except 2020) to stereo playback; assembly includes head-shifter to play back 2-track and 4-track tapes; original mono recording and playback are retained.....\$36.00

**Model W-7 Conversion Kit**

For Webeor 2800, 2900, and old 2000 Series (except 2020); 4-track stereo erase head; replaces mono erase head; used with W-6, permits stereo recording when additional amplifier (not included) is used; original 2-track mono erase facilities are retained.....\$18.00

**Model WR-40 Conversion Kit**

Converts all mono Wollensak and Revere tape recorders to 4-track stereo playback; a tape head playback amplifier such as the Model PL-100 is required for playback of

**PRECISION HI-FI ACCESSORIES**



**HUM-BUCKING TELEPHONE PICKUP COIL**

Hum free transcription, no connection to telephone, rugged cast case.

**MODEL HP-70 NET \$6.95**

**TAPE RECORDING HEAD DEMAGNETIZER**

Removes permanent magnetism, protects tape from erasure, minimizes noise and distortion, extended pole piece — easy access.



**MODEL HD-40M NET \$6.15**

**MAGNETIC TAPE ERASER**

Bulk erasure of recorded tape, restores tape like new, reduces noise, reel size to 10 1/2" x 1/2" W, epoxy case, sealed for life.



**MODEL HD-11M NET \$18.95**

**STEREO 3RD CHANNEL OUTPUT TRANSFORMER**

Add speaker to fill "hole-in-middle". Matches impedance, polarity and power level. Rating 30 watts. Response 40 to 20,000 C.P.S.



**MODEL HM-90 NET \$6.33**

**MICROTRAN company, inc.**

145 E. Mineola Ave., Valley Stream, N. Y.

CIRCLE NO. 40 ON READER SERVICE CARD

**Why?**

**DO THOUSANDS OF HI-FI ENTHUSIASTS BUY FROM AUDIO UNLIMITED**

**It's Obvious!**

- LOWEST PRICES
- FAST SERVICE
- FACTORY SEALED UNITS
- FULLY INSURED SHIPMENTS
- UP TO 2 YEAR MANUFACTURERS' WARRANTY
- PACKAGE DEALS—SAVE MORE
- FREE PARKING for our customers
- FRANCHISED DISTRIBUTORS

Write for **FREE Catalog Today**

**SEND US YOUR LIST FOR OUR AIR MAIL QUOTE TODAY**

Visit Our Showroom and Warehouse

**AUDIO unlimited, inc.**  
715-Z Second Ave., (Nr. 38) New York 16, N. Y.  
3 blocks from the U.N.

CIRCLE NO. 10 ON READER SERVICE CARD

## 4 Tape Accessories



second channel (not included).....\$32.50

### Model WR-35 Conversion Kit

Converts all stereo Wollensak and Revere 2-track tape recorders to 4-track stereo playback .....\$25.50

### Model WR-60 Conversion Kit

Converts all 2-track Wollensak and Revere models to 4-track stereo; includes three-

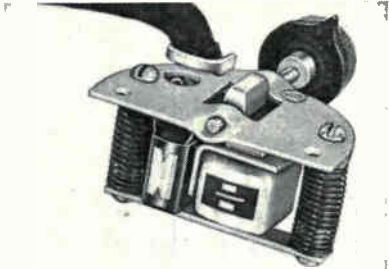

position head shifter for 2-track stereo, 4-track stereo, and 4-track mono operation; allows stereo recording with additional amplifier (not included).....\$49.50

### T60F Oscillator Transformer

For 12AU7A tube circuit use with all record, record/playback, and erase heads listed; freq. range 70-100 kc. depending on impedance .....\$4.50

### Model T60E Oscillator Transformer

65-kc. bias for recording and erase current for either high or low impedance heads; one-tube oscillator circuit diagram included .....\$4.50

### Model T60-T2 Oscillator Transformer

Similar to Model T60E but designed for transistor circuitry; 40-100 kc.; will de-

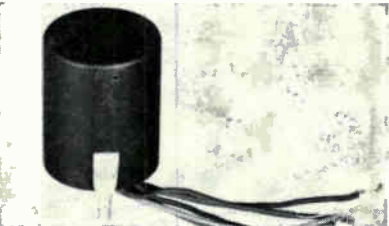

liver 25 to 150 volts to erase and record heads .....\$4.50

### Model AT-100 Alignment Tape

7.5 ips full-track for checking record/play heads of all types; 40-10,000 cps; recorded for checking azimuth, equalization, and head wear.....\$4.95

### 1000 Series Record/Play Heads

Four-track stereo, laminated core, high-quality heads with all-metal hyperbolic

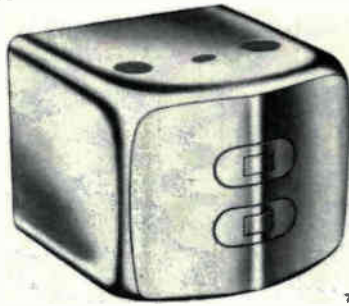

face construction; replaces older CSQ, TLB & TLD-1 designs.

#1000—High impedance; 800 mhy. inductance; 100  $\mu$ n. gap; for use with vacuum-tube circuits; no-mount type .....\$21.00

#1001—Medium impedance; 400 mhy. inductance; 100  $\mu$ n. gap; for use with vacuum-tube or transistor circuits; no-mount type .....\$21.00

#1002—Low impedance; 100 mhy. inductance; 100  $\mu$ n. gap; for use with transistor circuits; no-mount type .....\$21.00  
All above with rear mount.....\$22.50

### Model RPE-20 Replacement Kit

Direct replacement mono record/play and erase kit for Wollensak and Revere re-



corders; complete assembly mounted on special plate, wired and ready to install ..... \$15.60

### Model WR-30 Conversion Kit

Converts all mono Wollensak & Revere tape recorders to full-track record/play.....\$57.00

### Model V-6 Conversion Kit

Converts all mono and 2-track stereo V-M recorders to 4-track playback; includes patch cord and jack set for connecting to external stereo playback amplifier.....\$25.50

### Model V-7 Conversion Kit

For V-M recorders; 4-track stereo erase head; replaces mono erase head; used with V-6, permits stereo erase during stereo recording; includes synchronizing cable, isolation capacitor, and erase jack .....\$14.50

### 1200 Series Record, Record/Play Heads

Four-track stereo, laminated-core heads with all-metal, hyperbolic face construction; replaces older TLB, CSQ, and 1100 styles. Appearance same as Model 1000.

#1200 High impedance; 800 mhy. inductance; 100  $\mu$ n gap; for use with vacuum-tube circuits. No-mount type.....\$28.20

#1201 Medium impedance; 400 mhy. inductance; 100  $\mu$ n. gap; for use with vacuum-tube or transistor circuits. No-mount type .....\$28.20

#1202 Low impedance, 100 mhy. inductance; 100  $\mu$ n. gap; for use with transistor circuits. No-mount type .....\$28.20

#1203 Low impedance record only; 50 mhy. inductance; 500  $\mu$ n. gap; for use with vacuum-tube or transistor circuits. No-mount type .....\$28.20

#1205 Medium impedance; 200 mhy. inductance; 500  $\mu$ n. gap; for use with vacuum-tube circuits. No-mount type \$28.20

#1207 Medium-low impedance; 200 mhy.

inductance; 100  $\mu$ n. gap; for use with transistor circuits. No-mount type.....\$28.20  
Same as above with rear mount.....\$29.70

### 1800 Series Record/Play Heads

Two-track stereo; laminated core; all-metal heads; hyperbolic face construction; replaces older TLA and TLD-S styles.

#1800—High impedance; 800 mhy. inductance; 100  $\mu$ n. gap; for use with vacuum-tube circuits; no-mount type .....\$23.30

#1801—Medium impedance; 400 mhy. inductance; 100  $\mu$ n. gap; for use with

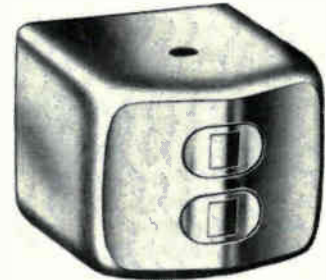

vacuum-tube or transistor circuits; no-mount type .....\$23.30

#1802—Low impedance; 100 mhy. inductance; 100  $\mu$ n. gap; for use with transistor circuits; no-mount type.....\$23.30  
Same as #1800, #1801, #1802 except rear mount .....\$24.80

### 2600 Series Record/Play Heads

Two-track mono; laminated core; heads with all metal hyperbolic face construction; replaces older SLA style.

#2600—High impedance; 800 mhy. inductance; 100  $\mu$ n. gap; for use with vacuum-tube circuits; no-mount type .....\$15.90

#2601—Medium impedance; 400 mhy. inductance; 100  $\mu$ n. gap; for use with

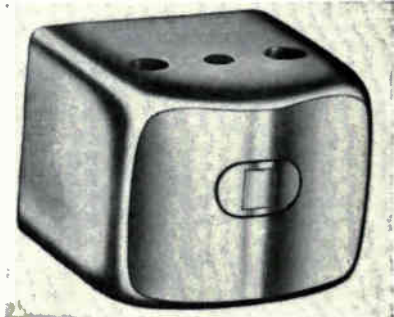

vacuum-tube or transistor circuits; no-mount type .....\$15.90

#2602—Low impedance; 100 mhy. inductance; 100  $\mu$ n. gap; for use with transistor circuits; no-mount type.....\$15.90

#2603—Special record only head; 50 mhy. inductance; 500  $\mu$ n. gap; for use with vacuum-tube or transistor circuits; no-mount type .....\$15.90

### 3000 Series Record/Play Heads

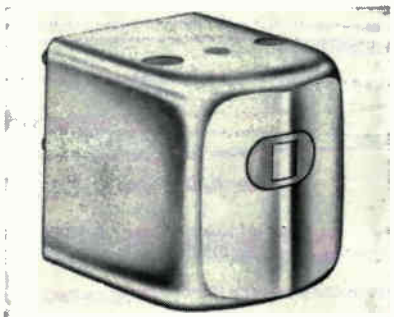

Two-track mono; laminated core, all-metal heads, hyperbolic face construction; replaces older SLS style.  
 #3000—High impedance; 800 mhy. inductance; 100  $\mu$ in. gap; for use with vacuum-tube circuits; no-mount type .....\$8.40  
 #3001—Medium impedance; 400 mhy. inductance; 100  $\mu$ in. gap; for use with vacuum-tube or transistor circuits; no-mount type .....\$8.40  
 Same as #3000 and #3001 except rear mount .....\$9.90

**3100 Series Record/Play Heads**

Two-track mono; solid core heads with cylindrical metal face construction; center track.  
 #3100 High imp.; 1000 mhy.; 160  $\mu$ in.



gap for use with vacuum-tube circuits; no-mount type .....\$8.40  
 #3101, Med. imp.; 400 mhy.; 160  $\mu$ in. gap; for use with vacuum-tube or transistor circuits; no-mount type .....\$8.40  
 Same as above with rear mount .....\$9.90

**3200 Series Record, Record/Play Heads**

Two-track mono, laminated core heads with all-metal hyperbolic face construction; replaces older SLS style.  
 #3200 High impedance. 800 mhy. inductance; 100  $\mu$ in. gap; for use with vacuum-tube circuits. No-mount type .....\$15.90  
 #3201 Medium impedance; 400 mhy. inductance; 100  $\mu$ in. gap; for use with vacuum-tube or transistor circuits. No-mount type .....\$15.90  
 #3203 Low impedance record only; 50 mhy. inductance; 500  $\mu$ in. gap; for use with vacuum-tube or transistor circuits. No-mount type .....\$15.90  
 Same as above with rear mount .....\$17.40

**4100 Series Record/Play Heads**

Full-track mono; laminated core heads with plastic, hyperbolic face construction; replaces older SF style.  
 #4100—Medium impedance; 250 mhy. in-

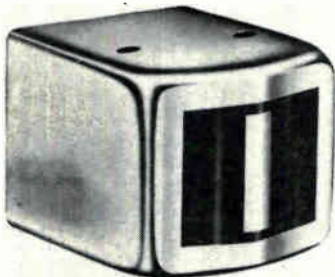

ductance; 160  $\mu$ in. gap; for use with vacuum-tube or transistor circuits; no-mount type .....\$34.70  
 #4101—Special record only head; 70 mhy. inductance; 500  $\mu$ in. gap; for use with vacuum-tube or transistor circuits; no-mount type .....\$34.70  
 Same as #4100 and #4101 except rear mount .....\$36.20

**5601 Series Record/Play Heads**

Four-channel; laminated core heads with all-metal hyperbolic face construction.  
 #5601 Special record-only head; low im-

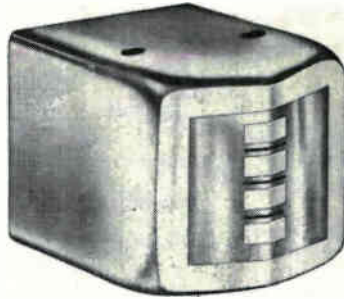

pedance 50 mhy.; 500  $\mu$ in. gap spacer; for use with vacuum-tube or transistor circuits; no-mount type .....\$99.00  
 #5602 Low imp.; 90 mhy.; 100  $\mu$ in. gap spacer; for use with vacuum-tube or transistor circuits; no-mount type .....\$99.00  
 #5603 Med. imp.; 370 mhy.; 100  $\mu$ in. gap spacer; for use with vacuum-tube or transistor circuits; no-mount type .....\$99.00  
 Same as above with rear mount .....\$105.00

**1400 Series Erase Heads**

Four-track stereo; laminated core; double gap; premium quality with full metal face construction; replaces older SEQ and SE-50 styles.  
 #1400—High impedance; 80 mhy. inductance; 30,000 ohms impedance at 60 kc.;

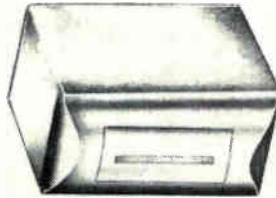

for use with vacuum-tube circuits; 60 kc. operating voltage; 90-150 volts; no-mount type .....\$12.00  
 #1401—Medium impedance; 10 mhy. inductance; 2800 ohms impedance at 60 kc.; for use with vacuum-tube or transistor circuits; 60 kc. operating voltage; 28-42 volts; no-mount type .....\$12.00  
 Same as #1400 and #1401 except rear mount .....\$13.50

**3600 Series Erase Heads**

Two-track mono; laminated core; premium quality with full metal face con-

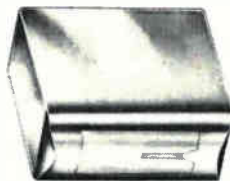

struction; double gap; replaces older MEH and ME-100 styles.  
 #3600—High impedance; 80 mhy. inductance; 25,000 ohms impedance at 60 kc.; for use with vacuum-tube circuits; 60 kc. operating voltage; 100-150 volts; no-mount type .....\$8.00  
 #3601—Medium impedance; 8 mhy. inductance; 2000 ohms impedance at 60 kc.; for use with vacuum-tube or transistor circuits; 60 kc. operating voltage; 32-48 volts; no-mount type .....\$8.00  
 Same as #3600 and #3601 except rear mount .....\$9.50

**4400 Series Erase Heads**

Full-track mono; laminated core; double gap; premium quality with full metal face construction; replaces older MEF and ME-250 styles.  
 #4400—High impedance; 40 mhy. inductance; 12,000 ohms impedance at 60 kc.;

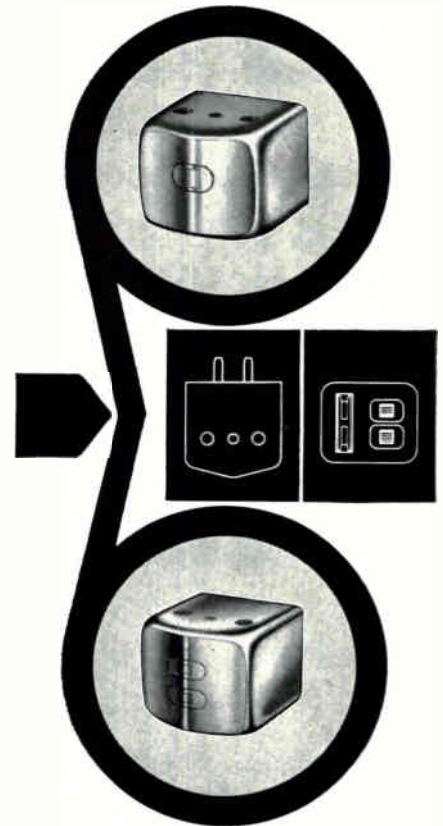

**NORTRONICS ANNOUNCES...  
 New Line of Tape Heads!**

For true broadcast quality and maximum enjoyment from your investment in tape equipment, replace worn heads with a new Nortronics Premium Series head! Available for more than 500 popular tape recorders, these moderately priced, laminated core replacement heads have highly polished, all-metal faces, and offer extended high frequency response, even at slower tape speeds. Other features include deposited quartz gaps and low-loss core structures.

**ALL TAPE HEADS WEAR OUT!**

Check today for head wear—both Nortronics Premium line replacement heads and "Quik-Kit" mounting hardware are correctly matched to your recorder, and are available from your Hi-Fi Dealer, Radio-TV Serviceman or Camera Store!

"Music sounds best on Tape—  
 Tape Sounds Best with Nortronics Heads!"

**Nortronics**

8159 Tenth Ave. N., Minneapolis, Minn. 55427

Write today for your FREE copy of NORTRONICS  
 Tape Head Replacement Guide.

Name \_\_\_\_\_  
 Address \_\_\_\_\_  
 City \_\_\_\_\_ State \_\_\_\_\_  
 I own a \_\_\_\_\_ Model \_\_\_\_\_ tape recorder

CIRCLE NO. 44 ON READER SERVICE CARD

## 4 Tape Accessories

for use with vacuum-tube circuits; 60 kc. operating voltage: 100-150 volts; no-mount type.....\$14.00  
#4401—Medium impedance; 3.6 mhy. inductance; 1000 ohms impedance at 60 kc.; for use with vacuum-tube or transistor circuits; 60 kc. operating voltage: 32-48

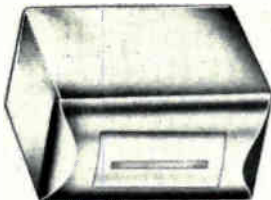

volts; no-mount type.....\$14.00  
Same as #4000 and #4001 except rear mount .....\$15.50

### 2200 Series Erase Heads

Two-track stereo; laminated core; double gap; premium quality with full metal face construction; replaces older SEH and SE-100 styles.

#2200—High impedance; 80 mhy. inductance; 25,000 ohms impedance at 60 kc.;

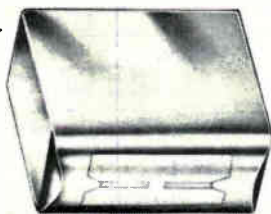

for use with vacuum-tube circuits; 60 kc. operating voltage: 100-150 volts; no-mount type .....\$12.00  
#2201—Medium impedance; 8 mhy. inductance; 2000 ohms impedance at 60 kc.; for use with vacuum-tube or transistor circuits; 60 kc. operating voltage: 32-48 volts; no-mount type.....\$12.00  
Same as #2200 and #2201 except rear mount .....\$13.50

## ROBINS

### Model ME-55 Eraser



Hand-held bulk eraser for 1/4" tapes .....\$16.66

### Model TK-5 Strobetape Kit

Consists of five lengths of 25-inch nonmagnetic leader tape with strobe markings plus small neon light which flickers at a rate of 120 times per second; designed to be spliced into a roll of tape and the strobe markings will indicate relative speed of the tape machine .....\$2.25

### Model TS-8D Deluxe Tape Splicer

Cuts tape diagonally; features "See-Thru"

windows indicating cut and trim positions; blade centering adjustment; unit has replaceable cutter cartridge and blade.....\$12.75

### Model ME-99 Bulk Tape Eraser

Demagnetize up to 1/2" wide; can erase background noise on old tapes; takes up to



10 1/2" reels; size 3 3/4" x 5 1/4" x 6 3/4" .....\$43.50

### Model ME-77 Bulk Tape Eraser

Low-cost version of Model ME-99; accepts reels up to 7" .....\$24.50

### Model TS-4S Tape Splicer

Similar in performance to Model TS-8D. Does not have "See-Thru" windows; sup-



plied with roll of 3/8" x 100" splicing tape .....\$9.50

### Model HD-6 Head Demagnetizer

Allows user to demagnetize tape recorder



heads; plugs into a.c. line.....\$10.00

### Model HD-3 Head Demagnetizer

Low-cost version of Model HD-6 demagnetizer .....\$6.00

## SCHOBER

### Model RV-2 "Reverbatape"

An electronic reverberation system using a special design multi-head tape recorder; re-

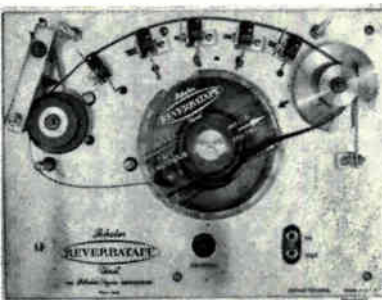

verberation time 5-6 sec.; repetition rate 9.1 per sec. (110 msec.); 500,000 ohm input impedance; emitter-follower output; gain 1; maximum signal 4 v. r.m.s. sine wave; has 1 record, 3 playback, 1 erase heads & 19 transistors.....\$279.95  
Available in kit form.....\$140.00

## 4 Raw Tape

## AMERICAN

### Acetate Base (1.5-mil)

1-A 150', 3" reel.....\$ .55  
2-A 250', 3 1/4" reel.....\$ .75  
3-A 300', 4" reel.....\$1.10  
6-A 600', 5" reel.....\$1.75  
12-A 1200', 7" reel.....\$2.75  
15-A 1500', 7" reel.....\$3.50

### Acetate Base Long-Play (1-mil)

L-2A 225', 3" reel.....\$ .70  
L-3A 350', 3 1/4" reel .....\$1.00  
L-4A 450', 4" reel.....\$1.40  
L-9A 900', 5" reel.....\$2.50  
L-18A 1800', 7" reel.....\$4.10  
L-20A 2000', 7" reel.....\$5.17

### Mylar Base Long-Play (1-mil)

L-2M 225', 3" reel.....\$ .75  
L-3M 350', 3 1/4" reel.....\$1.15  
L-9M 900', 5" reel.....\$2.70  
L-18M 1800', 7" reel.....\$4.60  
L-20M 2000', 7" reel.....\$5.80

### Mylar Base (1.5-mil)

1-M 150', 3" reel.....\$ .60  
6-M 600', 5" reel.....\$2.10  
12-M 1200', 7" reel.....\$3.35

### Mylar Base Double-Play Tensitized (.5-mil)

D-3MT 300', 3" reel.....\$1.25  
D-5MT 500', 3" reel.....\$1.60  
D-6MT 600', 4" reel.....\$2.30  
D-12MT 1200', 5" reel.....\$4.30  
D-18MT 1800', 5" reel.....\$5.90  
D-24MT 2400', 7" reel.....\$7.50  
D-30MT 3000', 7" reel.....\$9.50  
D-36MT 3600', 7" reel.....\$10.95

### Mylar Base Double-Play (.5-mil)

D-12MS 1200', 5" reel.....\$2.75  
D-24MS 2400', 7" reel.....\$5.10

### Acetate High-Output (1.5-mil)

HO-6A 600', 5" reel.....\$2.25  
HO-12A 1200', 7" reel.....\$3.50

### Mylar High Output (1.5-mil)

HO-6M 600', 5" reel.....\$2.65  
HO-12M 1200', 7" reel.....\$4.25

### Acetate Low-Print "Master" (1.5-mil)

LP-12A 1200', 7" reel.....\$4.40

### Mylar Low-Print "Master" (1.5-mil)

LP-12M 1200', 7" reel.....\$7.70

## AMPEX

### Series 500 Recording Tape

Available on .5, 1, and 1.5-mil Mylar in regular and slow-speed oxides; designed for super-critical home recording.

Regular Oxide:

Type 531-13 on 1.5 mil, 600', 5" reel .....\$2.65

Type 531-15 on 1.5 mil, 1200', 7" reel .....\$4.25

Type 541-13 on 1.0 mil, 900', 5" reel .....\$3.40

Type 541-15 on 1.0 mil, 1800', 7" reel .....\$6.20

Type 541-15M on 1.0 mil, 1200', 7" reel .....\$3.50

Type 551-13 on 0.5 mil, 1200', 5" reel .....\$5.45

Type 551-15 on 0.5 mil, 2400', 7" reel.....\$9.50

**Slow-Speed Oxide:**

Type 536-15 on 1.5 mil, 1200', 7" reel.....\$4.75

Type 545-15 on 1.0 mil, 1800', 7" reel.....\$6.90

Type 545-15M on 1.0 mil, 1200', 7" reel.....\$3.95

Type 556-15 on 0.5 mil, 2400', 7" reel.....\$10.75

**Series 900 Recording Tape**

Designed for large-library home recording.  
Type 911 1.5-mil acetate.

150', 3" reel.....\$0.65

600', 5" reel.....\$1.75

1200', 7" reel.....\$2.95

Type 921 1.0-mil acetate.

225', 3" reel.....\$0.80

900', 5" reel.....\$2.50

1800', 7" reel.....\$4.25

Type 931 1.5-mil Mylar.

600', 5" reel.....\$2.25

1200', 7" reel.....\$3.65

Type 941 1.0-mil Mylar.

225', 3" reel.....\$1.00

900', 5" reel.....\$2.85

1800', 7" reel.....\$4.95

Type 951 0.5-mil tensilized Mylar.

300', 3" reel.....\$1.35

1200', 5" reel.....\$4.50

2400', 7" reel.....\$7.95

**AUDIOTAPE**

**Master 1.5-mil Mylar Tape**

Made on 1.5 mil Mylar base; durable in wide temperature range.

Type 671M, 600 ft., 5" reel.....\$3.20

Type 1271M, 1200 ft., 7" reel.....\$5.10

**Double Recording (1.5-mil tempered Mylar)**

Made on tempered Mylar; allows twice as much recording per reel; stronger than double length tape.

Type 331T, 300 ft., 3" reel.....\$ 1.60

Type 631-T, 600 ft., 3 1/4" reel.....\$ 2.95

Type 1231T, 1200 ft., 5" reel.....\$ 5.45

Type 2431T, 2400 ft., 7" reel.....\$ 9.50

**Triple Recording ("tempered" Mylar)**

Three times as much recording time per reel; 1-mil cellulose acetate base; maximum extra strength as other "tempered" Mylar tapes.

Type 633T, 600 ft., 3 1/4" reel.....\$2.95

Type 1833T, 1800 ft., 5" reel.....\$6.95

Type 3633T, 3600 ft., 7" reel.....\$11.95

**Longer Recording (1-mil plastic base)**

Provides 50% more recording time per reel; 1-mil cellulose acetate base; maximum economy for applications where high strength is not required.

Type 941, 900 ft., 5" plastic reel.....\$3.50

Type 1841, 1800 ft., 7" plastic reel.....\$5.50

**Longer Recording (1-mil Mylar)**

Made on 1-mil Mylar polyester film; provides 50% more recording time per reel; exceptional strength and durability plus longer storage life.

Type 261, 225 ft., 3" plastic reel.....\$1.00

Type 961, 900 ft., 5" plastic reel.....\$3.60

Type 1861, 1800 ft., 7" reel.....\$ 6.20

Type 3661FS, 3600 ft., 10 1/2" fiberglass (EIA) reel.....\$14.40

**Standard Recording (1.5-mil Mylar)**

High-strength super-durable magnetic tape that meets the highest professional standards of performance; withstands extreme temperatures; virtually immune to humidity; gives maximum tape life under any conditions of use or storage.

Type 671, 600 ft., 5" plastic reel.....\$2.65

Type 1271, 1200 ft., 7" reel.....\$4.25

Type 2571R, 2500 ft., 10 1/2" aluminum reel.....\$11.20

Type 2571FS, 2500 ft., 10 1/2" fiberglass reel (EIA).....\$11.20

**Double Recording (.5-mil Mylar)**

Made on .5-mil Mylar; twice as much recording time per reel as standard plastic-base tape; suitable for extended-play applications where tape tension is not excessive.

Type 1231, 1200 ft., 5" reel.....\$3.50

Type 2431, 2400 ft., 7" reel.....\$6.50

**Master Plastic-Base Tape**

Made on 1.5 mil acetate base.

Type 651M, 600 ft., 5" reel.....\$2.75

Type 1251M, 1200 ft., 7" plastic reel.....\$4.30

Type 2551FS-M, 2500 ft., 10 1/2" fiberglass.....\$12.50

**Standard Recording (plastic base)**

Professional-quality recording tape; maximum fidelity, uniformity, frequency response and freedom from noise and distortion; 1.5 mil acetate.

Type 151, 150 ft., 3" plastic reel.....\$ .70

Type 351, 300 ft., 4" plastic reel.....\$1.35

Type 651, 600 ft., 5" plastic reel.....\$2.25

Type 1251, 1200 ft., 7" plastic reel.....\$3.50

Type 2551R, 2500 ft., 10 1/2" reel.....\$10.90

Type 2551FS, 2500 ft., 10 1/2" fiberglass reel (EIA).....\$10.90

**BURGESS**

**Series No. 111 1.5-mil Plastic**

111-1.5 150', 3" reel.....\$0.70

111-2.5 250', 3 1/4" reel.....\$1.25

111-3 300', 4" reel.....\$1.35

111-6 600', 5" reel.....\$2.25

111-8.5 850', 5 1/4" reel.....\$2.85

111-12 1200', 7" reel.....\$3.50

111-24R 2400', 10 1/2" reel.....\$10.90

111-24RPS 2400', 10 1/2" reel.....\$10.90

111-48R 4800', 14" reel.....\$22.10

**Series No. 190 1.0-mil Extra-Play Plastic**

190-2.25 225', 3" reel.....\$0.90

190-9 900', 5" reel.....\$3.50

190-12 1200', 5 3/4" reel.....\$4.25

190-15 1500', 7" reel.....\$4.50

190-18 1800', 7" reel.....\$5.50

190-36R 3600', 10 1/2" reel.....\$12.85

190-72R 7200', 14" reel.....\$26.00

**Series No. 102 1.5-mil Mylar**

102-6 600', 5" reel.....\$2.65

102-8.5 850', 5 1/4" reel.....\$4.25

102-12 1200', 7" reel.....\$4.25

102-24R 2400', 10 1/2" reel.....\$11.20

102-24H 2400', 10 1/2" reel.....\$8.80

102-24RPS 2400', 10 1/2" reel.....\$11.20

102-48R 4800', 14" reel.....\$24.50

**Series No. 150 1.0-mil Extra-Play Mylar**

150-2.25 225', 3" reel.....\$1.00

150-3.75 375', 3 1/4" reel.....\$1.75

150-9 900', 5" reel.....\$3.60

150-12 1200', 5 3/4" reel.....\$4.65

150-15 1500', 7" reel.....\$5.15

150-18 1800', 7" reel.....\$6.20

150-36R 3600', 10 1/2" reel.....\$14.40

150-36RPS 3600', 10 1/2" reel.....\$14.40

150-72R 7200', 14" reel.....\$30.00

**Series No. 200 .5-mil Double-Length Tensilized Mylar**

200-3 300', 3" reel.....\$1.60

200-6 600', 4" reel.....\$3.05

200-12 1200', 5" reel.....\$5.45

200-17 1700', 5 1/4" reel.....\$7.05

200-24 2400', 7" reel.....\$9.50

200-48R 4800', 10 1/2" reel.....\$22.00

200-48RPS 4800', 10 1/2" reel.....\$22.00

**Series No. 290 .5-mil Double-Length Tensilized Mylar**

290-6 600', 3 1/4" reel.....\$2.50

290-36 3600', 7" reel.....\$11.95

**Series No. 131 1.5-mil Plastic**

131-12 1200', 7" reel.....\$4.40

131-24R 2400', 10 1/2" reel.....\$12.40

131-48R 4800', 14" reel.....\$26.00

**Series No. 138 1.5-mil Mylar**

138-12 1200', 7" reel.....\$5.10

138-24R 2400', 10 1/2" reel.....\$13.50

138-48R 4800', 14" reel.....\$34.00

**Series No. 175 1.5-mil Polyvinyl Chloride Film Base**

175-6 600', 5" reel.....\$2.40

175-12 1200', 7" reel.....\$3.75

**Series No. 141 1.5-mil Plastic**

141-6 600', 5" reel.....\$1.75

141-12 1200', 7" reel.....\$2.95

**Series No. 140 1.0-mil Extra-Play Plastic**

140-9 900', 5" reel.....\$2.50

140-18 1800' 7" reel.....\$4.25

**Series No. 142 1.0-mil Extra-Play Mylar**

142-9 900', 5" reel.....\$2.85

142-18 1800', 7" reel.....\$4.95

**Series No. 144 .5-mil Double-Length Mylar**

144-12 1200', 5" reel.....\$4.50

144-24 2400', 7" reel.....\$7.95

**EASTMAN**

**A303 Low-Print Tape**

For mastering & general purpose recording. 1/4-inch, 1.5-mil Durol triacetate base.

150', 3" reel.....\$0.85

625', 5" reel.....\$2.25

1250', 7" reel.....\$3.50

**A203 Extra Play Tape**

General purpose, 1/4-inch, 1-mil Durol triacetate base.

900', 5" reel.....\$3.50

1800', 7" reel.....\$5.50

**P203 Extra Length Tape**

General purpose, 1/4-inch, 1-mil polyester base.

900', 5" reel.....\$3.60

1800', 7" reel.....\$6.20

**A304 Low-Noise Tape**

High output, 1/4-inch, 1.5-mil Durol triacetate base.

625', 5" reel.....\$2.25

1250' 7" reel.....\$3.50

**P105 Triple Length Tape**

General purpose, 1/4-inch, 0.5-mil polyester base.

600', 3 1/4" reel.....\$2.95

1800', 5" reel.....\$6.95

3600', 7" reel.....\$11.95

**P103 Double Length Tape**



General purpose, ¼-inch, 0.5-mil polyester base.

400', 3" reel.....	\$2.10
1250', 5" reel.....	\$5.45
2500', 7" reel.....	\$9.50

### FERRODYNAMICS

#### 3" Reels

15C3 150' 1.5-mil acetate.....	\$1.64
10C3 225' 1-mil acetate.....	\$1.72
10C3M 225' 1-mil Mylar.....	\$1.87
5C3M 300' .5-mil Mylar.....	\$1.04

#### 3¼" Reels

5C3.2M 600' .5-mil Mylar.....	\$1.79
-------------------------------	--------

#### 5" Reels

15D5 600 feet 1.5-mil acetate.....	\$1.35
10D5 900 feet 1-mil acetate.....	\$1.65
10D5M 900 feet 1-mil Mylar.....	\$2.00
5D7M 2400 feet .5-mil Mylar.....	\$2.80
15D5M 600 feet 1.5-mil Mylar.....	\$2.80

#### 7" Reels

15D7 1200 feet 1.5-mil acetate.....	\$2.10
10D7 1800 feet 1-mil acetate.....	\$2.85
10D7M 1800 feet 1-mil Mylar.....	\$3.50
5D7M 2400 feet .5-mil Mylar.....	\$4.60
5D7MT 2400 feet .5-mil tensilized Mylar.....	\$6.15
15D7M 1200 feet 1.5-mil Mylar.....	\$3.75
5D7MT Special 3600 feet .5-mil tensilized Mylar.....	\$10.95

#### 10½" Reels

15D10 2400 feet 1.5-mil acetate.....	\$7.35
10D10 3600 feet 1-mil acetate.....	\$8.20
10D10M 3600 feet 1-mil tensilized polyester.....	\$10.90

### RCA

#### "Red Seal" Series 1-mil Long-Play Plastic Base

10A-9 900 feet, 5" reel.....	\$ 3.50
10A-18 1800 feet, 7" reel.....	\$ 5.50
10A-36NPR 3600 feet, 10½" NAB plastic reel.....	\$12.85

#### 1.5-mil Professional-Grade Plastic Base

15A-1.5 150 feet, 3" reel.....	\$ 0.70
15A-3 300 feet, 4" reel.....	\$ 1.35
15A-6 600 feet, 5" reel.....	\$ 2.25
15A-12 1200 feet, 7" reel.....	\$ 3.50
15A-24NPR 2400 feet, 10½" reel.....	\$10.90

#### Mylar (Polyester) Tensilized Extra- Long Play

5TM-3 300 feet, 3" reel.....	\$ 1.60
5TM-6 600 feet, 4" reel.....	\$ 3.05
5TM-6A 600 feet, 3¼" reel.....	\$ 2.95
5TM-12 1200 feet, 5" reel.....	\$ 4.75

5TM-24 2400 feet, 7" reel.....	\$ 8.75
5TM-48NPR 4800 feet, 10½" reel.....	\$20.50

#### Mylar (Polyester) 1-mil Long-Play

10M-2.25 225 feet, 3" reel.....	\$ 1.00
10M-9 900 feet, 5" reel.....	\$ 3.60
10M-18 1800 feet, 7" reel.....	\$ 6.20
10M-36NPR 3600 feet, 10½" reel.....	\$14.40

#### Mylar (Polyester) 1.5-mil Professional-Grade

15M-6 600 feet, 5" reel.....	\$ 2.65
15M-12 1200 feet, 7" reel.....	\$ 4.25
15M-24NPR 2400 feet, 10½" reel.....	\$11.20

#### "Vibrant Series" Full-Frequency Recordings Acetate (plastic) Base

V15-A-6 600 feet, 1.5-mil, 5" reel.....	\$1.75
V15-A-12 1200 feet, 1.5-mil, 7" reel.....	\$2.95
V10-A-9 900 feet, 1-mil, 5" reel.....	\$2.50
V10-A-18 1800 feet, 1-mil, 7" reel.....	\$4.25

#### Mylar (Polyester) Base

V10M-9 900 feet, 1-mil, 5" reel.....	\$2.85
V10M-18 1800 feet, 1-mil, 7" reel.....	\$4.95
V5TM-12 1200 feet, tensilized, 5".....	\$4.50
V5TM-24 2400 feet, tensilized, 7" reel.....	\$7.95

### SARKES TARZIAN

#### "Standard Play" 1.5-mil Acetate Tape

1131-01 150 feet, 3" reel.....	\$ .65
1131-06 600 feet, 5" reel.....	\$ 2.10
1131-12 1200 feet, 7" reel.....	\$ 3.50
1131-24R 2400 foot reel.....	\$10.25

#### "Long Play" 1-mil Acetate Tape

1121-02 225 feet, 3" reel.....	\$ .90
1121-09 900 feet, 5" reel.....	\$ 3.15
1121-18 1800 feet, 7" reel.....	\$ 5.15
1121-36R 3600 foot reel.....	\$12.00

#### "Long Play" 1-mil Mylar Tape

1321-02 225 feet, 3" reel.....	\$ 1.00
1321-09 900 feet, 5" reel.....	\$ 3.60
1321-18 1800 feet, 7" reel.....	\$ 6.20
1321-36R 3600 foot reel.....	\$14.70

#### "Extra Long Play" .5-mil Mylar Tape

1411-03 300', 3" reel.....	\$ 1.60
1411-06 600', 3¼" reel.....	\$ 2.90
1411-12 1200', 5" reel.....	\$ 5.45
1411-24 2400', 7" reel.....	\$ 9.50

### "SCOTCH" TAPES

#### No. 111 "All-Purpose" Tape

Excellent freq. response, low modulation noise & high sensitivity; silicone lubrication process; 1.5-mil acetate backing.

111-150 150', 3" reel.....	\$ 0.70
111-300 300', 4" reel.....	\$ 1.35
111-600 600', 5" reel.....	\$ 2.25
111-1200 1200', 7" reel.....	\$ 3.50
111-2500-RO 2500', 10½" reel.....	\$10.80

#### No. 102 "All-Purpose" Tape

For applications where extreme toughness

& improved resistance to the effects of excessive temperature and humidity change are required; high-strength polyester film backing; magnetic characteristics identical to No. 111 also features 1.5-mil polyester backing.

102-600 600', 5" reel.....	\$ 2.65
102-1200 1200', 7" reel.....	\$ 4.25
102-2500-RO 2500', 10½" reel.....	\$11.35

#### No. 120 "High-Output" Tape

Signal-to-noise ratio of from 6 to 12 db greater than conventional recording tapes; designed for critical recording applications where greater signal strength is essential; 1.5-mil acetate backing.

120-300 300', 4" reel.....	\$ 1.35
120-600 600', 5" reel.....	\$ 2.25
120-1200 1200', 7" reel.....	\$ 3.50
120-2500-RO 2500', 10½" reel.....	\$10.80

#### No. 131 "Low-Print" Tape

Acetate backing; reduces print-through to a point below noise level on most professional machines.

131-1200 1200', 7" reel.....	\$ 4.40
131-2500-RO 2500', 10½" reel.....	\$12.20

#### No. 138 "Low-Print" Tape

Same recording characteristics as No. 131 but has tough 1.5-mil polyester backing.

138-1200 1200', 7" reel.....	\$ 5.10
138-2500-RO 2500', 10½" reel.....	\$13.90

#### No. 200 Recording Tape

Double-length, double-strength tape with tensilized polyester backing.

200-1200 1200', 5" reel.....	\$ 5.45
200-2400 2400', 7" reel.....	\$ 9.50
200-4800-RPS 4800', 10½" reel.....	\$22.00

#### No. 140 "Stereo-Quality" Tape

Extra-length tape which provides 50% more playing time; similar to No. 141; 1-mil acetate backing.

140-900 900', 5" reel.....	\$2.50
140-1800 1800', 7" reel.....	\$4.25

#### No. 141 "Stereo-Quality, Acetate"

High potency oxide particles assure maximum frequency response; 1.5-mil acetate backing.

141-600 600', 5" reel.....	\$1.75
141-1200 1200', 7" reel.....	\$2.95

#### No. 142 "Stereo-Quality" Tape

Extra-length, extra-strength tape similar to No. 141 with 1-mil polyester base.

142-900 900', 5" reel.....	\$2.85
142-1800 1800', 7" reel.....	\$4.95

#### No. 144 "Double-Length, Double-Strength"

Stereo quality, double-strength; .5-mil tensilized polyester backing.

144-1200 1200', 5" reel.....	\$4.50
144-2400 2400', 7" reel.....	\$7.95

#### No. 190 "Extra-Length" Tape

High-potency oxide coating only half as thick as standard coatings (but with equivalent magnetic properties) coupled with a thinner backing of tough acetate; approximately 30% thinner than conventional acetate tape, nearly 80% as strong; 50% increase in recording and playback time with no noticeable print-through effect; magnetic properties are virtually identical to those of No. 111 magnetic tape.

190-900 900', 5" reel.....	\$ 3.50
190-1800 1800', 7" reel.....	\$ 5.50
190-3600-RO 3600', 10½" reel.....	\$12.80

#### No. 150 "Extra-Length, Extra-Strength"

Magnetic recording tape offering 50% more recording time and featuring 1-mil polyester backing for improved resistance

### Please Note .....

All prices quoted are those submitted by the manufacturer and unless otherwise noted are audiophile net and subject to change without notice. Because of shipping costs, prices do vary across the country. Prices listed are those prevailing in the company's immediate manufacturing area.

to changes in temperature and humidity and also for greater strength.

150-900 900', 5" reel ....\$ 3.60  
 150-1800 1800', 7" reel ....\$ 6.20  
 150-3600-RO 3600', 10½" reel ....\$14.35

**No. 290 "Triple-Length" Tape**

The tape that gives maximum play on a given reel size. Especially suited for continuous recording of lengthy conferences, meetings, conventions; .5-mil tensilized polyester backing.

290-1800 1800', 5" reel .....\$ 6.95  
 290-3600 3600', 7" reel .....\$11.95

**"Living Letters" Tape**

Packaged in plastic containers: three tape lengths available for variety of uses, providing up to maximum recording time on a 3" reel. Plastic container provides high-impact, re-usable mailer.

111-150-LL 150', 3" reel .....\$0.90  
 200-300-LL 300', 3" reel .....\$1.85  
 290-600-LL 600', 3" reel .....\$2.95

**SOUNDCRAFT**

**"Standard" Tape**

1.5-mil acetate base; professional quality; economy priced.

S-1 150 ft., 3" reel.....\$0.70  
 S-6 600 ft., 5" reel.....\$2.10  
 S-9 900 ft., 5¾" reel.....\$2.73  
 S-12 1200 ft., 7" reel.....\$3.50  
 S-25RM\* 2500 ft., 10½" reel.....\$10.25

**"Standard-50" Tape**

Long-play version of "Standard" tape on 1-mil acetate base.

S5-2 225 ft., 3" reel.....\$0.90  
 S5-9 900 ft., 5" reel.....\$3.29  
 S5-18 1800 ft., 7" reel.....\$5.17  
 S5-36RM\* 3600 ft., 10½" reel.....\$12.04

**"Lifetime" Tape**

For use where utmost strength and quality are necessary; 1.5-mil Mylar base; "Micro-polished" oxide coating for perfect high-frequency response.

L-1 150 ft., 3" reel.....\$0.75  
 L-6 600 ft., 5" reel.....\$2.65  
 L-12 1200 ft., 7" reel.....\$4.25  
 L-25RM\* 2500 ft., 10½" reel.....\$11.20

**"Plus-50" Tape**

Made on 1-mil Mylar for 50% more playing time per reel; combines long play with great tape strength.

PL-2 225 ft., 3" reel.....\$1.00  
 PL-9 900 ft., 5" reel.....\$3.40  
 PL-18 1800 ft., 7" reel.....\$5.80  
 PL-3RM\* 3600 ft., 10½" reel.....\$13.75

**"Triple-Play" Tape**

.5-mil Mylar base

TP-6 600 ft.....\$2.29  
 TP-24 2400 ft.....\$6.96  
 TP-36 3600 ft.....\$10.00

**"Plus-100-X" Tape**

Similar to "Triple-Play" but with twice the tensile strength; base is .5-mil Mylar.

XP-3X 300 ft., 3" reel.....\$1.60  
 XP-18X 1800 ft., 5¾" reel.....\$7.48  
 XP-24X 2400 ft., 7" reel.....\$9.50  
 XP-48XRM 4800 ft., 10½" reel.....\$22.00

**"Golden Tone" Tape**

High quality special tape; 25% more high-frequency out & 7 db better signal-to-noise ratio; 7" reel.

GTA-12 1.5-mil acetate base, 1200'....\$4.70  
 GTM-18T 1-mil tensilized Mylar base, 1800' .....\$7.50  
 GTM-24T .5-mil tensilized Mylar base, 2400' .....\$11.40

\*Also available with ¾" & 3" center opening.

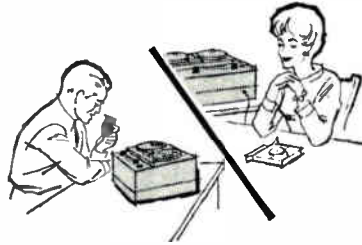

**WHY**  
**you should buy and enjoy**  
**TARZIAN TAPE**

Most of its users say that Tarzian Tape is the finest tape you can buy for the entire range of audio recording purposes, from stereo music to school work. Tape dealers who sell Tarzian Tape do so because they believe it is a very good product for you, the user—not because we give them fancy advertising support and free premiums.

The package for Tarzian Tape is strictly functional, not ornate. The price is standard: not cheap like "white box," not artificially high because of some "magic ingredient." The quality is professional, not because you run a recording studio or a radio station, but because any good tape recorder deserves it and any discriminating pair of ears appreciates it.

Insist on Tarzian Tape... depend on it for long lasting, professional quality performance whatever your recording assignment.

**FREE**... Tarzian's "Lower the Cost of Fun With Tape Recording" contains 32 illustrated pages of tape tips. Send for your free copy.

ITEM	Reel Size	Length (Feet)	Code Number	
Standard Play	3"	150	1131-01	
	5"	600	1131-06	
Acetate Tape	7"	1200	1131-12	
	Reel	2400	1131-24R	
		2400	1131-24H	
	Long Play	3"	225	1121-02
5"		900	1121-09	
Acetate Tape	7"	1800	1121-18	
	Reel	3600	1121-36R	
		3600	1121-36H	
	Long Play	3"	225	1321-02
5"		900	1321-09	
Mylar Tape	7"	1800	1321-18	
	Reel	3600	1321-36R	
		3600	1321-36H	
	Extra Long Play 0.5 Mil	3"	300	1411-03
3¾"		600	1411-06	
Mylar Tape (Tensilized)		5"	1200	1411-12
		7"	2400	1411-24



**SARKES TARZIAN Inc.**

World's Leading Manufacturers of TV and FM Tuners • Closed Circuit TV Systems • Broadcast Equipment • Air Trimmers • FM Radios • Magnetic Recording Tape • Semiconductor Devices

**MAGNETIC TAPE DIVISION • BLOOMINGTON, INDIANA**

Export: Ad Auriema, Inc., N.Y. • Canada: E. J. Piggott Enterprises Ltd., Toronto, Ont.

**CIRCLE NO. 50 ON READER SERVICE PAGE**

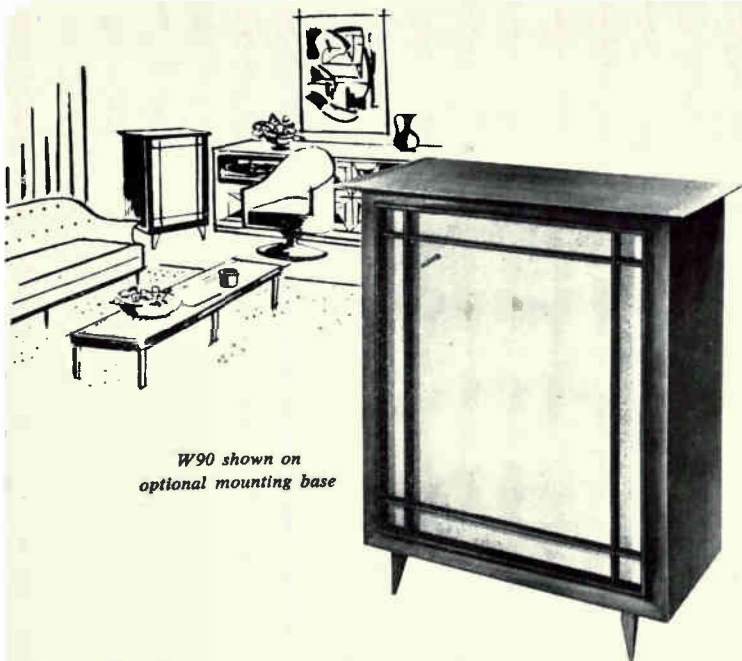

W90 shown on optional mounting base

**W90** 6-speaker system (two 12½" bass, two 5½" mid-range, two Super 3 treble), superbly matched and integrated with a magnificent sand-filled enclosure. The impact of the great Wharfedale systems used in G. A. Briggs' notable live vs. recorded demonstrations, now in a new format—neither compact nor large, to sound well and look well in any living room. Maximum performance through advanced acoustical techniques—speakers with polystyrene facing—enclosures with tuned and distributed ports. Now restyled with decorator bouclé fabric grille and handsomely finished table top. **Oiled or Polished Walnut, \$272.50; Utility model, \$256.50.**

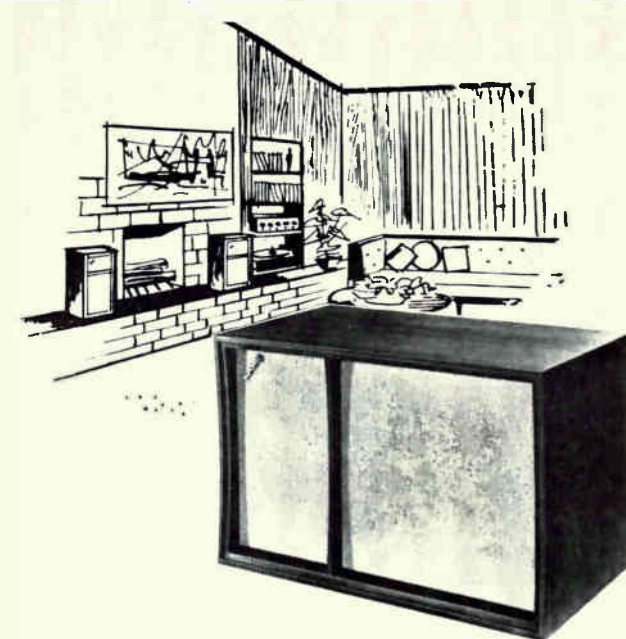

**W60** Full-range 2-speaker system (12½" bass; 5" mid-range tweeter) in exclusive sand-filled enclosure.

The original Achromatic system, W60 continues to be the most popular Wharfedale model. Its high standing was established by comparative tests against speaker systems of every calibre. New magnetic materials, a more compliant cone surround, and other developments have now added luster to its recognized acoustical qualities. Fine furniture detailing, including new decorator-selected champagne bouclé grille fabric. **Oiled or Polished Walnut, \$122.50; Utility model, \$106.50.**

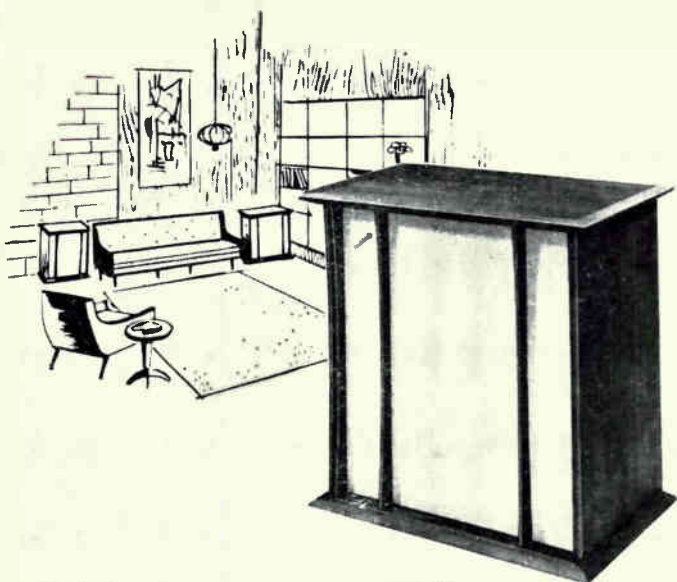

**W70** Full-range 3-speaker system (12½" bass; 10¼" mid-range; Super 3 treble) in exclusive sand-filled enclosure.

An unusually versatile system providing excellent bass, transparent highs and the fullness of a superb mid-range. Recent technical advances make it compatible with the latest electronic equipment, including solid state. Now restyled with champagne bouclé grille and decorative table top and base... an attractive addition to any listening room. **Oiled or Polished Walnut, \$172.50; Utility model, \$153.50.**

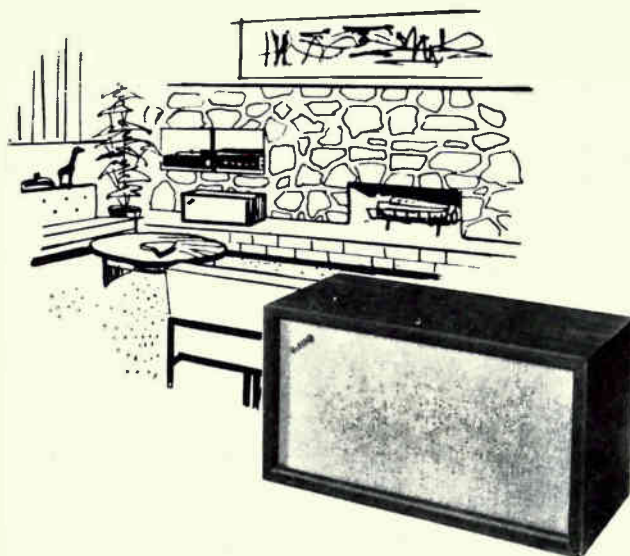

**W40** Full-range 2-speaker system (10½" low frequency; 5" mid-range tweeter) in exclusive sand-filled enclosure.

Now, W40 incorporates a highly advanced 10½" bass speaker with extremely high flux density magnet, providing excellent low end. Highs are reproduced without stridency through the same cone-type 5" tweeter as in the W60. Restyled with distinctive champagne bouclé grille and decorative molding, it is admirably suited to any music system where space must be carefully utilized, but quality is required. **Oiled or Polished Walnut, \$83.50; Utility model, \$72.50.**

#### WHARFEDALE COMPONENT LOUDSPEAKERS

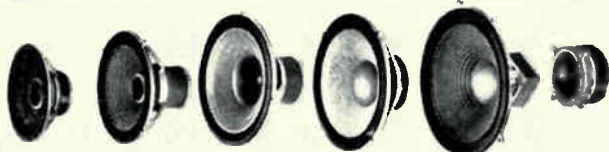

Full Range 8" Super 8	Full Range 10" Super 10	Full Range 12" Super 12	Woofer W 12/RS	Woofer W 15/RS	Tweeter Super 3
RS/DD	RS/DD	RS/DD	\$52.50	\$89.50	\$26.50
\$26.50	\$47.50	\$89.50			

Newest Achromatics



by **Wharfedale**

For Comparator Guide and swatch of new grille fabric, write Wharfedale, Div. of British Industries Corp., Port Washington, N.Y.



# SPEAKERS & CABINETS

LOUDSPEAKERS  
ENCLOSURES  
SPEAKER SYSTEMS  
CROSSOVER NETWORKS } ..... 115

*Special Feature*

Q & A ON HI-FI SPEAKERS ..... 135

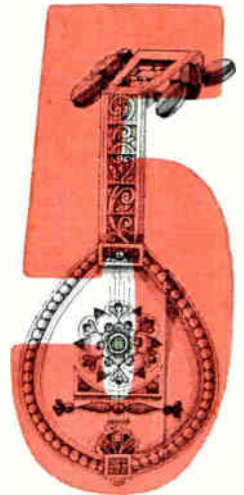

## ACOUSTIC RESEARCH

### Model AR-2

Acoustic suspension two-way system; 42-14,000 cps  $\pm 5$  db; down 10 db at 30 and



16,000 cps; 10-inch woofer and 2-5" tweeters, built-in crossover; 8 ohms impedance; harmonic distortion at 10 watts under 2% to 60 cps, under 3% to 50 cps; recommended amplifier power: at least 25 watts per stereo channel; bookshelf type; 13 1/2" x 24" x 11 1/2"; 33 lbs; hardwood veneer. Bottom side unfinished.

Mahogany or birch.....\$ 96.00  
Walnut, cherry, or korina.....\$102.00  
Unfinished pine.....\$ 89.00

### Model AR-2a

Consists of speakers in AR-2 and the Model AR-3 super-tweeter. Four sides finished.

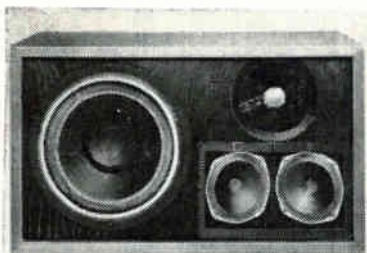

Oiled walnut, walnut, cherry, oiled teak, or korina .....\$128.00  
Mahogany or birch .....\$122.00  
Unfinished pine .....\$109.00

### Model AR-3

Acoustic suspension three-way system; 38 to 1000 cps,  $\pm 1 1/2$  db; 1000 to 20,000 cps,  $\pm 2$  db; usable range down to 30 cps; one 12" woofer, one 2" and one 1 3/8" dome radiator for mid and high frequencies; built-in three-way crossover with level controls for mid and high ranges; 4 ohms impedance; less than 2% harmonic distortion from 60 to 20,000 cps at 20 watts input, less than 3% to 42 cps; recommended am-



plifier power, at least 25 watts per stereo channel; 14" by 11 3/8" by 25"; 60 lbs.; 3/4" hardwood veneer.

Mahogany or birch .....\$216.00  
Walnut, oiled walnut, cherry, korina, or oiled teak .....\$225.00  
Unfinished pine .....\$203.00

## ADC

### Model ADC-18 Speaker System

Features unique rectangular woofer; frequency range 20-20,000 cps; has walnut

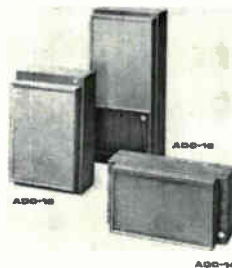

cabinet; 40" x 17" x 12 1/2" .....\$250.00

### Model ADC-16 Speaker System

Has rectangular woofer; frequency range 30-20,000 cps; 27 1/2" x 17" x 12 1/2" .....\$220.00

### Model ADC-14 Speaker System

Compact design with frequency range of 38-20,000 cps; walnut cabinet; 25" x 13 1/2" x 12 1/2" .....\$175.00

### Model 325 Speaker System

Bookshelf design; 2-way system with 6" cone woofer (59 cps resonance) & 3" high-compliance cone tweeter with center dome. Response 45-20,000 cps  $\pm 4$  db; power requirements 10 to 60 w.; 8 ohms; LC crossover network. 19" x 10 1/2" x 8"; 3/4" oiled walnut.....\$49.50

### Model 303-A "Brentwood" System

Bookshelf design with 8" high-compliance woofer, with wide-dispersion, high-flux Mylar dome tweeter. Response 35-20,000

cps  $\pm 3$  db; power requirements 6 to 60 w.; 8 ohms. 23 3/4" x 13" x 11 3/4". Oiled walnut .....\$95.00

## ALTEC LANSING

### Model 50A "Bi-Acoustic" Horn

Dust-, water-, and weather-proof for outdoor applications; provides coaxial type

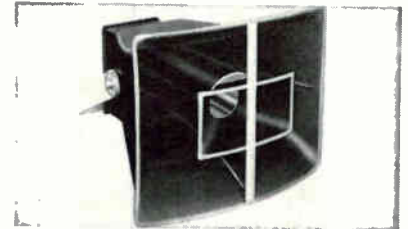

sound distribution; 30 watts; 175-12,000 cps; Fiberglass housing; 12 1/2" x 15 1/2" x 17 1/4" .....\$66.00

### Model 412C

12-inch Biflex cone-type speaker with second compliance ring in the center of the



cone to give mechanical crossover at 1000 cycles and permit 2-way performance with a single voice coil; 20 watts; 40 to 15,000 cycles; 8-ohms impedance; 3-inch edge-wound ribbon voice coil; cast aluminum frame. ....\$57.00

### Model 415C "Biflex" Speaker

15-inch Biflex cone-type speaker with second compliance ring in the center of the



cone to give mechanical crossover at 1000 cycles and permit 2-way performance with a single voice coil; 25 watts; 30 to 14,000 cycles; 8-ohms impedance; 3-inch edge-wound ribbon voice coil; cast aluminum frame; free-air resonance 25 cps.....\$67.50

# 5 Speakers & Cabinets

## Model 511B "Sectoral" Horn

Designed to load 804A driver down to 500 cps with upper limit at 22,000 cps:

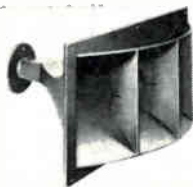

cast of heavy resonant-free aluminum; dispersion 90° horizontal and 40° vertical .....\$36.00

## Model 811B "Sectoral" Horn

Similar to Model 511B except cut-off is at 800 cps; used with 804A driver and 800 cps crossover to complement either one 803B or one or two 414A bass speakers .....\$24.00

## Model 601C "Duplex"

12-inch two-way speaker; 12-inch woofer with a high frequency driver and horn in



a single heavy cast frame; complete with 3000 cycle crossover network, frequency response from 30 to 22,000 cycles; 25 watts continuous sine-wave power; 8 ohms; cone resonance 27 cps .....\$114.00

## Model 602C "Duplex"

Coaxial 15-inch speaker; range from 20 to 22,000 cps; 15-inch woofer and a newly



designed exponential sectoral horn coupled to a high frequency driver through a 3000 cps dividing network; 25 watts continuous sine-wave power; 8 ohms; cone resonance 27 cps .....\$132.00

## Model 803B Woofer

15-inch woofer; power rating 30 watts; 16-ohms impedance; response 20-1600 cps;



special rim compliance prevents cone breakup; 3-inch diameter copper cone ribbon voice coil is edge-wound; cast aluminum frame; free-air resonance 25 cps .....\$63.00

## Model 414A Bass Speaker

A 12" equivalent of Model 803B; response 30-4000 cps depending on crossover used .....\$54.00

## Model 605A Duplex

15" coaxial speaker; 35 watts continuous sine-wave and up to 50 watts peak power; 16 ohm impedance; magnet weight 2 1/2 lbs.



low frequency, 1/2 lb. high frequency; depth 10"; response 20-20,000 cps; free-air resonance 25 cps .....\$168.00

## Model 755C 8" "Pancake" Speaker

Wide-angle sound dispersion; 15 watts;



response 40-15,000 cps; 8 ohms; 2" voice coil; cone resonance 52 cps; depth 2 1/4" .....\$32.25

## Model 804A Driver Systems

Extends to 22,000 cps; features ribbon voice coil & aluminum alloy diaphragm; 16 ohms; 30 watts; can be used with 811B horn & N-800E (800 cps) crossover;

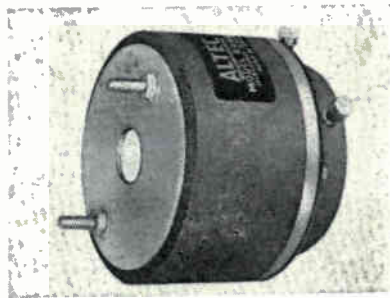

for woofer use 803B or 415C Biflex speaker; the 804A driver can also combine with 511B sectoral horn & N-5001D (500 cps) crossover; use either one or two 803B bass speakers .....\$57.00

## Model 831A "Capistrano" System

Incorporates the 15" 803B woofer in bass reflex enclosure, an 800 cps network, and



the 804A high frequency driver with 811B sectoral horn; frequency range from 35 to 22,000 cps; 30 watts; 16 ohms; 30" h.

x 47" w. x 23 1/2" d.; in walnut or mahogany .....\$399.00

## Model 835B "Monterey Junior"

Has 402B speaker & 2000B high-freq. speaker; crossover 2000 cps; response 45-



18,000 cps; 16 ohms; 15 w. power rating; cabinet bass reflex type; 11 1/4" x 23" x 11 1/4" d.; walnut or blonde .....\$88.50

## Model 836A "Lido" Speaker System

Bookshelf design; speakers have radiating area of over 76 sq. inches; extended fre-

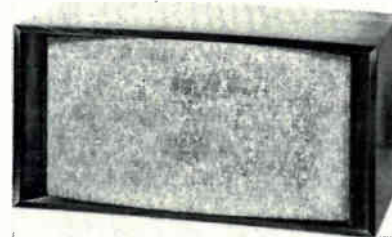

quency response; high efficiency; 12 7/8" x 26" x 12 7/8"; 15 watt power rating; available in walnut .....\$112.50

## Model 841A "Coronado" Speaker System

Has a 414 12" bass speaker & 3000 sectoral horn & driver; response 40-22,000 cps; 20



w. power rating; N-3000 crossover network is used; walnut. 30" x 19" x 14" d. ....\$204.00

## Model A-7 "Voice of the Theatre" System

Utility model of the Altec 2-way theatre system; employs a direct radiating expo-

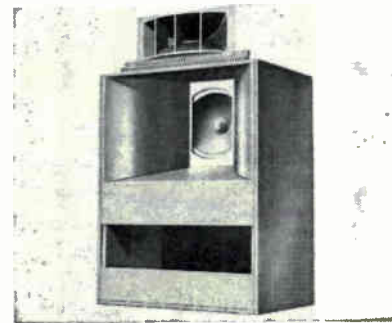

nential horn enclosure combined with a modified bass reflex principle; 15" 803B woofer, N-800D 800 cps crossover network, and 804A driver with 811B horn; frequency range from 35 to 22,000 cps;

If you think you can't afford the best high fidelity components available, bar none, check these three independent magazine surveys.\*

They agree on their choices of the *best* turntable and the *best* loudspeakers – moderately priced AR's.

	TURNTABLE	LOUDSPEAKERS
<b>Popular Science</b> (Sept. 1963)	AR two-speed	AR-3's
<b>Bravo!</b> (Fall 1963)	AR two-speed	AR-3's
<b>hi-fi/tape systems</b> (1964)	AR two-speed	AR-3's



*The AR turntable—less than 1/2 the cost of other arm-turntable systems over which it was chosen.*

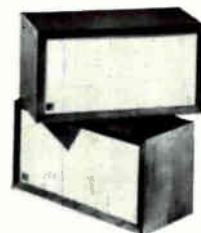

*AR-3 loudspeakers—less than 1/3 the cost of other speakers over which they were chosen.*

\*The Bravo survey introduced its selection of top components with: "If music is so deeply your passion that it makes you intolerant of all compromise...you may enter that rarified area of audio where nothing matters but the dedicated pursuit of perfection."

The Popular Science panel tried to eliminate frills, and limited its choice to compact speakers for reasons of practicality in the home, but stated: "Where there was a more expensive component that produced a detectable improvement in sound, it was chosen."

The Hi-Fi/Tape Systems survey referred to its choices as "the least expensive way to obtain state-of-the-art performance."



The Popular Science survey also recommended Roy Allison's *High Fidelity Systems — A User's Guide* (AR Library Vol. 1, \$1). This book may be purchased at many AR dealers', or you may order it directly with the coupon below.

ACOUSTIC RESEARCH, INC., 24 Thorndike Street, Cambridge, Massachusetts 02141

- Please send me Allison's *High Fidelity Systems — A User's Guide*. I enclose \$1 in cash or check only, and /or
- Please send me free literature on AR products, plus the complete lists of components chosen by each magazine.

Name \_\_\_\_\_ Address \_\_\_\_\_

CIRCLE NO. 1 ON READER SERVICE CARD

# 5 Speakers & Cabinets

30 watts power rating; 16 ohms impedance; horizontal dispersion 90°; vertical dispersion 40°; 6 db adjustable high-frequency attenuation: 30" w x 24" d x 52 1/4" h; gray finish.....\$288.00

## Model 2000B Tweeter

Direct-radiating; aluminum dome and paper cone; built-in capacitor crossover;



power capacity 14 watts; frequency range 1500-18,000 cps; 8 ohms.....\$22.50

## Model 3000B Tweeter

Aluminum diaphragm; multicell-type horn; 20 watts when used with N-3000E net-



work; response 3000-22,000 cps; 8-ohms impedance; edge-wise wound voice coil; requires 3000 cycle crossover network; dispersion 90° horizontal, 40° vertical; 3 3/16" h. x 4 7/8" w. x 4 7/16" d.....\$40.50

## 838A "Carmel" Speaker System

Two-way system, infinite baffle design; combining two 414A bass speakers and one



804A driver mounted on 811B horn; response 30-22,000 cps; 30 watts power rating; N-800E crossover is used; available in walnut; decorator's base available in place of legs at extra cost; 29 3/4" h. x 35" l. x 17 3/4" d. ....\$337.50

## 837A "Avalon" Speaker System

Identical to Model 838A except only one 414A speaker is used.....\$289.50

## Model 854A/B Speaker Cabinet

Same as Model 838A except cabinet only; will house any Altec Biflex or Duplex 12" or 15" speaker.....\$114.00

## N-500D Dividing Network

Designed for use with 804A h.f. driver &

511B horn; 12 db/octave slope; externally mounted h.f. shelving control has four steps of 1 1/2 db for adjustment to room acoustics; 16 ohms; 500 cps crossover; 2 3/4" h. x 6 1/4" w. x 6 3/4" d. ....\$52.50

## N-800E Dividing Network

Same as 500D except 800 cps crossover for use with 804A driver & 811B horn; 6" h. x 4 3/4" w. x 2 3/8" d. ....\$46.50

## N-3000E Dividing Network

Designed especially for 3000B h.f. speaker; 8 ohms; attenuation 10 db continuously variable; 3000 cps crossover; 2 3/16" h. x 4 7/8" w. x 2 3/16" d. ....\$21.00

## Model 802D H.F. Driver

Response 500-22,000 cps; 16 ohm impedance; 1.75" v.c.; 30 w. power with N-500D



or N-800D network; use N-500D with 511A or 511B horn for 500 cps crossover & N-800D with 811B horn for 800 cps crossover; 4 1/2" dia., 3 1/16" deep.....\$75.00

## Model A7-500 Speaker Systems

Similar in design & appearance to Model A7. Has 802D driver & 511B sectoral horn with 500 cps crossover. 54 1/4" h. x 30" w. x 24" d. Theatre gray. wt. 142 lbs..\$315.00

## ARGOS

### Model TX-1 2-Way System

Bookshelf system with walnut wood-grain vinyl finish; 24" h. x 11" w. x 9"; 8" 45-cps

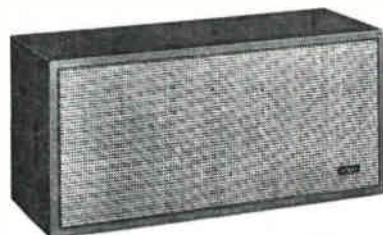

woofer, 3 1/2" tweeter (Jensen) with crossover network; tube vented; response 45-17,000 cps; 8 ohms.....\$29.95  
Model TX-1E Enclosure only.....\$19.95

### Model TX-2 2-Way System

Bookshelf system with oiled walnut enclosure; 24" h. x 11" w. x 9"; 8" 45-cps woofer, 3 1/2" tweeter (Jensen) with crossover network; tube vented; response 45-17,000 cps; 8 ohms.....\$44.50  
Model TX-2E Enclosure only.....\$29.95

### Model TX-3 2-Way System

Enclosure has walnut wood-grain vinyl finish; 12" woofer, 3 1/2" tweeter (Jensen) with crossover network; tube vented; response 50-17,000 cps; 8 ohms.....\$39.95  
Model TX-3E Enclosure only.....\$24.95

### Model TX-4 3-Way System

Bookshelf or floor model size in oiled walnut; 25" h. x 14 3/4" w. x 9" d.; 12" woofer, 8" solid-back midrange, 3 1/2" direct-

radiator type tweeter (Jensen) with crossover network; tube vented; response 35-17,000 cps; 8 ohms.....\$79.95  
Model TX-4E Enclosure only.....\$39.95

## Model HFWB-8SV "Space Saver"

Compact music extension speaker system with built-in volume control; 8" woofer,



3 1/2" tweeter (Jensen) with crossover network; 8 ohms; enclosure in either walnut or whitened birch finish; 12" h. x 18" w. x 3 3/4" d.....\$17.95

## Model PHF-1 "Petite"

Mounts on wall, stands on table or floor; 12" h. x 18" w. x 3 1/4" d.; oiled walnut

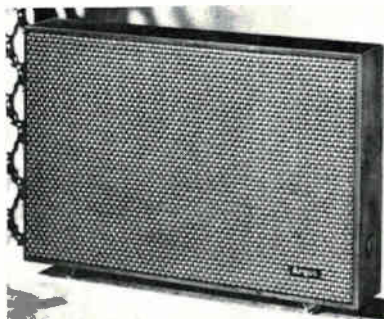

enclosure houses Jensen-designed woofer and tweeter; crossover network; response 50-17,000 cps; recessed volume control; 8 ohms .....\$29.95

## Model TX-5 2-Way System

Compact "cube" measuring 13 3/8" h. x 12 3/8" w. x 10" d.; oiled walnut enclosure; 8" woofer, 3 1/2" tweeter (Jensen); crossover network; response 50-17,000 cps; 8 ohms .....\$32.50

## Model PAT-10 "Patio" Outdoor Speaker

Redwood enclosure, cane grille, marine-grade plywood; full-range 8-ohm 8" mois-

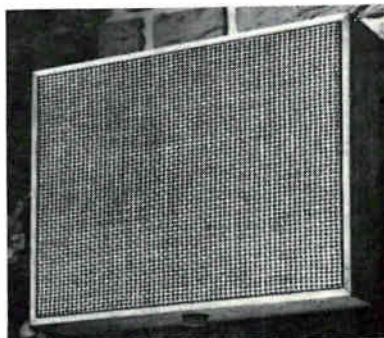

ture-resistant speaker; built-in volume control. Size 10 1/2" h. x 14" w. x 3 1/2" d. ....\$14.95

## Model TX-12 3-Way System

Floor model system of oiled walnut; 24" x 19" x 5 5/8"; cane grille; curved metal legs; includes 12" woofer, 8" midrange, 3 1/2"

# HOBSON'S CHOICE? NEVER AGAIN!

If, in 1631, you went to rent a horse from Thomas Hobson at Cambridge, England, you took the horse that stood next to the door. And no other. Period. Hence, Hobson's Choice means No Choice.

And, as recently as 1961, if you went to buy a true high fidelity stereo phono cartridge, you bought the Shure M3D Stereo Dynetic. Just as the critics and musicians did. It was acknowledged as the ONLY choice for the critical listener.

Since then, Shure has developed several models of their Stereo Dynetic cartridges—each designed for optimum performance in specific kinds of systems, each designed for a specific kind of *porte-monnaie*.

We trust this brief recitation of the significant features covering the various members of the Shure cartridge family will help guide you to the best choice for you.

## THE CARTRIDGE



V-15



M55E



M44



M7/N21D

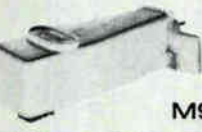

M99



M3D

## ITS FUNCTION, ITS FEATURES . . .

The ultimate! 15° tracking and Bi-Radial Elliptical stylus reduces Tracing (pinch effect), IM and Harmonic Distortion to unprecedented lows. Scratch-proof. Extraordinary quality control throughout. Literally handmade and individually tested. In a class by itself for reproducing music from mono as well as stereo discs.

Designed to give professional performance! Elliptical diamond stylus and new 15° vertical tracking angle provide freedom from distortion. Low Mass. Scratch-proof. Similar to V-15, except that it is made under standard quality control conditions.

A premium quality cartridge at a modest price. 15° tracking angle conforms to the 15° RIAA and EIA proposed standard cutting angle recently adopted by most recording companies. IM and Harmonic distortion are remarkably low . . . cross-talk between channels is negated in critical low and mid-frequency ranges.

A top-rated cartridge featuring the highly compliant N21D tubular stylus. Noted for its sweet, "singing" quality throughout the audible spectrum and especially its singular recreation of clean mid-range sounds (where most of the music really "happens".) Budget-priced, too.

A unique Stereo-Dynetic cartridge head shell assembly for Garrard and Miracord automatic turntable owners. The cartridge "floats" on counterbalancing springs . . . makes the stylus scratch-proof . . . ends tone arm "bounce."

A best-seller with extremely musical and transparent sound at rock-bottom price. Tracks at pressures as high as 6 grams, as low as 3 grams. The original famous Shure Dynetic Cartridge.

## IS YOUR BEST SELECTION

If your tone arm tracks at 1½ grams or less (either with manual or automatic turntable)—and if you want the very best, regardless of price, this is without question your cartridge. It is designed for the purist . . . the perfectionist whose entire system must be composed of the finest equipment in every category. Shure's finest cartridge. \$62.50.

If you seek outstanding performance and your tonearm will track at forces of ¾ to 1½ grams, the M55E will satisfy—beautifully. Will actually improve the sound from your high fidelity system! (Unless you're using the V-15, Shure's finest cartridge.) A special value at \$35.50.

If you track between ¾ and 1½ grams, the M44-5 with .0005" stylus represents a best-buy investment. If you track between 1½ and 3 grams, the M44-7 is for you . . . particularly if you have a great number of older records. Both have "scratch-proof" retractile stylus. Either model under \$25.00.

For 2 to 2½ gram tracking. Especially fine if your present set-up sounds "muddy." At less than \$20.00, it is truly an outstanding buy. (Also, if you own regular M7D, you can upgrade it for higher compliance and lighter tracking by installing an N21D stylus.)

If floor vibration is a problem. Saves your records. Models for Garrard Laboratory Type "A", AT-6, AT-60 and Model 50 automatic turntables and Miracord Model 10 or 10H turntables. Under \$25.00 including head shell, .0007" diamond stylus.

If cost is the dominant factor. Lowest price of any Shure Stereo Dynetic cartridge (about \$16.00) . . . with almost universal application. Can be used with any changer. Very rugged.

**SHURE**

*Stereo Dynetic*®

HIGH FIDELITY PHONO CARTRIDGES . . . WORLD STANDARD WHEREVER SOUND QUALITY IS PARAMOUNT  
Shure Brothers, Inc., 222 Hartrey Ave., Evanston, Illinois

# 5 Speakers & Cabinets



tweeter (Jensen) with crossover network; tube vented; response 40-17,000 cps; 8 ohms .....\$54.95

## ARGUS-X

### X-3B Speaker System

Shelf model using two Argus-X 8" speakers with multi-segmented suspensions, dual cones, and double-wound voice coils and two 2" super tweeters; response 28-20,000 cps; oiled walnut finish all four sides; 25" x 14" x 11" d.....\$200.00

### X-5B Speaker System

Floor model with 3" detachable pedestal; has three Argus-X speakers with multi-segmented suspensions, dual cones, and double-wound voice coils and two 2" super tweeters; response 18-20,000 cps; oiled walnut finish; 18" x 24" x 16" d.....\$300.00

### "Custom 500" Speaker System

Variable dynamic infinite damping speaker enclosure with one 15" & one 12" woofer, two 8" midrange, and 4 tweeters. Response below 15 to above 20,000 cps. Available in almost any finish. 24" x 34" x 16" \$450.00

### "Custom Concert Grand" System

Has twice the speaker complement of the "Custom 500." 32" x 48" x 18" ....\$900.00

## ATLAS SOUND

### Model DC-5

Six-watt weather-resistant cone-type projector; response 120-7000 cps; 8 ohm



impedance; 14" long, 7" diameter, 5" cone .....\$14.25

### Model W-6

15-watt cone speaker; response 100-8000 cps; 120° dispersion; finish & dimensions same as WT-6.....\$27.00  
Model SS-4 Speaker stand for W-6 and

WT-6 (extends to over 6' in height) .....\$13.50

### Model WT-6 "Coax-Projector"

Two-way system with two drivers, two horns; built-in electronic crossover filter;

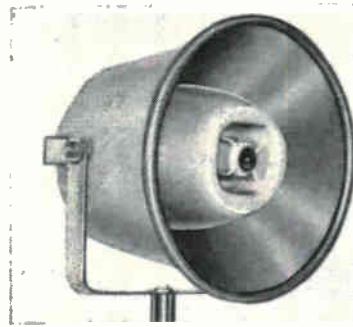

15 watts; response 100-15,000 cps; 8 ohms; 120 degree dispersion; crossover 1000 cps; bell opening 15"; over-all depth 12"; beige enamel finish.....\$36.00

### Model HR-3 Super-Tweeter

Response 2000-17,500 cps; may be used with any 12-16 ohm crossover network;



music power rating 35 watts; 7½" w. x 3" h. x 6½" d.; baffle board opening 2" x 6".....\$15.00

### Model WR-7 "Decorette"

Two-way system with woofer, cone tweeter, and crossover network in metal enclosure;



speakers weatherproofed for patio & outdoor use in sheltered location; power 15 watts; response 70-15,000 cps; impedance 8 ohms; 18" l. x 8" w. x 5½" h.; light beige spatter finish; contrasting grille cloth; wall mounting brackets included....\$22.50

## AUDIO-TECH

### Model ME-12 Speaker System

For floor or bookshelf use; has 12" woofer and 3" cone-type tweeter; balance control for tweeter supplied; frequency response 40-20,000 cps; capacity 30 watts; woofer magnet strength 12,500 gauss;

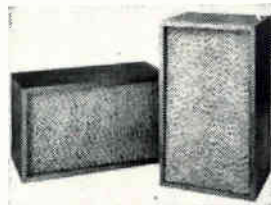

24"x12"x14"; available in oiled walnut; fused to protect against speaker overload .....\$129.50

### Model JA-15 Speaker System

Floor use; has 15" cone woofer and

tweeter; tweeter balance control, LC crossover network; impedance 8 ohms; frequency response 32-20,000 cps; power capacity 30 watts; 29"x26"x16"; fused to protect against overload.....\$250.00

## BIGG OF CALIFORNIA

### Model BR-12-HST



Three-way system has 12" woofer, mid-range, tweeter, crossover network; bass-reflex cabinet.....\$109.95

### Model CH-16



Corner compression speaker system; employs air compression principle; 17½"x9"x17" .....\$34.96

### Model BR-1528T Profundo

Bass-reflex cabinet system; 30"x16½"x33" .....\$159.95

### Model 14-P Enclosure

Infinite baffle; frequency response 30-18,000 cps; power rating 50 watts program



material; has compression woofer, mid-range and tweeter with triple crossover network and brilliance control; mounts horizontally or vertically; 13" w. x 12" d. x 25½" h.....\$79.95

## BOZAK

### B-207A Two-Way Coaxial Speaker

Coaxial speaker; 15" mounting frame; depth 7"; for use with amplifiers 20 watts or more; 40-20,000 cps; 8-ohm impedance; composed of B-199A woofer and B-200Y twin-tweeter; crossover at 2500

cps; fits standard cut-outs for 12" and 15" speakers; infinite baffle enclosure recommended, minimum 5 cu. feet, optimum 9 cu. feet.....\$94.50

**B-209B Mid-Range Speaker**

Mid-range speaker; 6½" diameter, 3½" deep; unique "sandwich" cone; for 20- to 40-watt systems with Bozak crossover network; 200 to 3500 cps; 8- and 16-ohm models available; 1½-lb. Alnico V magnet; rubber suspension gives superb transient response.....\$52.50

**B-200Y Tweeter**

Twin-cone tweeters for use with amplifiers 20 watts or more; 2000-20,000 cps;



8-ohm impedance (two 16-ohm sections in parallel); two 8-oz. Alnico V magnets; direct-radiating dual cones; 120° radiation; rubber damping prevents peaking and metallic harshness.....\$33.50

**B-199A Woofer**

12" woofer; 5¾" deep; variable-density cone; for use with amplifiers 20 watts or more; 40-4500 cps; 8 or 16 ohm impedance; 1½-lb. Alnico V magnet; unique voice-coil construction; cast aluminum frame.....\$54.50

**B-300 Speaker System**

Infinite baffle enclosure; ¾" plywood; one B-207A 15" coaxial speaker; 40-20,-

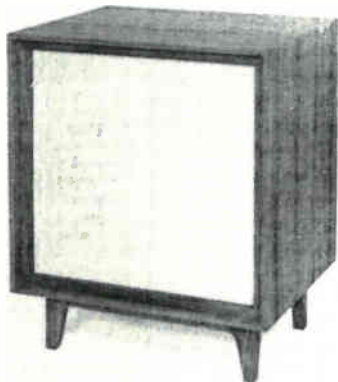

000 cps; can convert to model B-302A. Styling same as C-305 equip. cabinets.  
 B-300 Urban—24" w. x 20" d. x 30" h.: walnut or mahogany.....\$179.50  
 B-300 Urban (Enclosure only).....\$ 85.50  
 B-300 French Provincial—28" w. x 19" d. x 31" h.: cherry.....\$215.50  
 B-300 French Provincial (Enclosure only) .....\$121.00  
 B-300 Italian Provincial; 24" w. x 18½" d. x 31" h.: cherry.....\$199.50  
 B-300 Early American; 24" w. x 17" d. x 30¼" h.; hand-rubbed maple.....\$187.00

**B-302A Speaker System**

Similar to B-300 with addition of B-209B mid-range speaker and N-10102A crossover network.  
 B302A Urban 24" w. x 20" d. x 30¼" h. ....\$261.50

**Now Save  
\$5.90 to \$14.90  
with Argos  
STEREO PAIR PRICING!**

These high fidelity speaker systems, individually cost 27% to 43% less than systems of comparable performance . . . and even less when bought in pairs.

Save  
\$5.90



**TX-1 two-way bookshelf-sized system**

- Special 45 cycle, 8" woofer; 3½" tweeter; crossover network.
- Overall 45-17,000 cycle response.
- Walnut wood-grain vinyl finish 24" x 11" x 9" deep enclosure.
- Miniature legs provided.
- Audiofile net each—\$29.95; pair \$54.00.

Save  
\$6.00



**TX-5 two-way modern module speaker system**

- A contemporary "fits—anywhere" 12¾" x 13¾" x 10" deep walnut cabinet.
- 8" woofer; 3½" tweeter; crossover network.
- Response 50-17,000 cycles.
- Attractive cane grille.
- Audiofile net each—\$32.50; pair \$59.00.

Save  
\$9.95



**TX-12 three-way console speaker system**

- 12" woofer; 8" solid back midrange; 3½" tweeter; crossover network.
- Response 40-17,000 cycles.
- Handsome 24" x 19" x 5¾" walnut cabinet.
- Graceful brass legs.
- Audiofile net each—\$54.95; pair \$99.95.

Save  
\$14.90



**TX-4 three-way deluxe speaker system**

- Covers the full tonal range from 35-17,000 cycles.
- Has 12" woofer; 8" solid back midrange; 3½" direct radiator type tweeter.
- Beautifully sculptured 25" x 14¾" x 9" deep hand-rubbed, oiled walnut enclosure.
- Distinctive cane grille.
- Audiofile net each—\$79.95; pair \$145.00.

See them at your  
High Fidelity Dealer or send  
for free catalog—Write Dept. K-65

**Argos**  
PRODUCTS COMPANY  
600 So. Sycamore Street  
Genoa, Illinois 60135

*Quality by design in sound reproduction*

CIRCLE NO. 5 ON READER SERVICE CARD

**FEEL FREE.....**

**to write any of the manufacturers whose products are listed for additional details.**

**Addresses of manufacturers and distributors are given on page 6.**

# 5 Speakers & Cabinets

B302A French Provincial 28" w. x 19" d. x 31½" h. ....\$297.50  
 B-302A Italian Provincial: 24" w. x 18½" d. x 31" h.; cherry.....\$281.50  
 B-302A Early American: 24" w. x 17" d. x 30¼" h.; hand-rubbed maple.....\$269.00

## B-200YA Tweeter Array

Eight cone-type tweeters; power rating 60-watts; 1500 to 20,000 cps; 8-ohm im-



pedance; eight 8-oz. Alnico V magnets; cast aluminum frame; 180° horizontal dispersion at 16 kc.....\$142.50

## B-800 Full-Range Speaker

8" speaker; 8 or 16 ohm impedance 50-15,000 cps; 8½" dia. x 3¼" deep; for use with amplifiers 15 watts or more.....\$47.50

## B-305 Speaker System

Walnut or mahogany infinite-baffle enclosure; 35-20,000 cps; 3-way speaker sys-



tem; 800 cps and 2500 cps crossover frequencies; two B-207A coaxial speakers, one B-209B mid-range speaker; wide-angle listening area of 120°; 16-ohm impedance; 36" w. x 20" d. x 30" h.

B-305 Urban—walnut or mahogany .....\$397.50  
 B-305 French Provincial—cherry.....\$440.00  
 B-305 Urban (Enclosure only).....\$126.50  
 B-305 French Provincial (Enclosure only) .....\$169.50

## N-10102A Crossover Network

Universal dividing network; convertible for B-302A or B-305 system; 800 and 2500 cps crossover; 8 or 16 ohms; can be converted to 400 and 2500 cps crossover for 8-ohm system by addition of N-25 .....\$29.50

## N-103 Crossover Network

Crossover 400 and 2500 cps; 16 ohms; used on B-305 system.....\$37.50

## N-104 Crossover Network

Crossover 400 and 2500 cps; 8 ohms; used on B-310AP system.....\$37.50

## N-25 Crossover Network

Capacitor bank for use with N-10102 when 400-2500 cps crossover and 8 ohms is desired.....\$11.60

## B-1000 "Bard" Outdoor Portable Speaker

Rigid 18" dia. hemispheric housing; 21" high, 12" front-to-back; 22 lbs.; input by

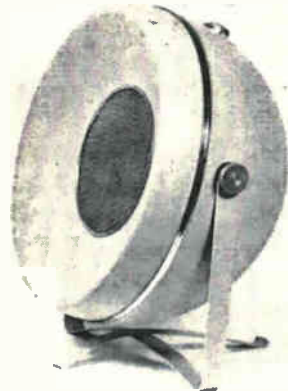

phone jack (plug supplied); 8 ohms; power input 40 watts max; response 80-15,000 cps; B-800 driver; adjustable friction-type trunnion; weatherproof cone; sandalwood beige or white eggshell with gold trim.....\$79.50

## P-305P

Contains two B-207A, one B-209B and crossover network mounted on a ¾" panel; 8 cu. foot cavity required; panel 24" h. x 34½" w.....\$279.50

## P-310AP

Contains four B-199A, two B-209B, one B-200YA and crossover network mounted on a ¾" panel; 16 cu. foot cavity required; panel 47" h. x 31" w.....\$555.00

## Model 2000 "Sonata No. 1" Speaker System

Bookshelf type with B-800 8" full-range speaker, B-200Y dual-tweeter, and type



N-1 crossover network; useful frequency 50-20,000 cps; 8 ohms; to be used with amplifiers 15 watts or more; 14" h. x 23½" w. x 11½" d.; available in walnut or mahogany.....\$134.50

## Model 4000 "Symphony No. 1" Speaker System

Has two B-199A woofers, one B-800 full-range 8" speaker; eight B-200 tweeters;

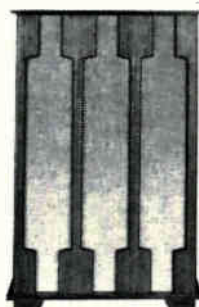

and special crossover network; useful frequency 35-20,000 cps; crossovers at 400 and 1500 cps; 8 ohms; for use with am-

plifiers 30 watts or more; 44" h. x 28" w. x 16" d.; available in walnut or mahogany. ....\$495.00

## Bozak Panel Systems P-302AP

Contains one B-207A, one B-209B, and crossover networks mounted on a ¾" panel; 5 cu. foot cavity required; panel 27½" h. x 23" w. ....\$182.50

## CABINART

### Mark 3 Speaker System

Bass-reflex horn-loaded bookshelf design; dual-cone 8" extended-range speaker in-

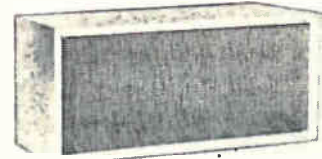

cluding 3" whizzer cone; 15 watts power rating; response 70-19,000 cps ± 7 db; free-air resonance 65 cps; 9½" d. x 11" h. x 23" l.

Oiled walnut.....\$27.00  
 Unfinished birch.....\$19.50

### Mark 5 Speaker System

Bass-reflex 3-way system with electrical crossovers and brilliance control; includes 8" woofer, 5" mid-range, and 3" tweeter; 25 watts power rating; response 60-19,000 cps; 9½" d. x 11" h. x 22" l.

Oiled walnut.....\$36.00  
 Unfinished birch.....\$29.50

## CHANNEL MASTER

### Model 6633 Speaker System

Ducted-port enclosure; 8" speaker with 2" coax tweeter; electrical crossover 3000 cps;



10 watts; 8 ohms; 23½" x 10" x 11" deep; available in walnut finished formica.....\$52.50

### Model 6636 "Slim Jim" Speaker System

Bookshelf speaker 5" deep; patented "acoustic transformer" dynamic air cou-



pling; response 50-15,000 cps; 8½" x 15" x 5" d.; walnut finished formica.....\$29.95

## CONAR

### 3SP Center-Channel System

For use with any stereo amplifier. Provides left plus right center signal. Fills hole in the middle with speakers 16" to 20" apart. Response 40-17,000 cps; 25 w. capacity; 8



### HiFi/Stereo Review

June, 1964

"...the designers of the E-V TWO were aiming for a smooth, uncolored sound, and they have succeeded very well. Overall the E-V TWO is a very smooth and musical reproducer."

### Radio-Electronics

February, 1964

"In brief, the E-V TWO's produce a quite spectacular sound with a big, low-down bass...that is the best, to my ears, that Electro-Voice has yet produced."

### POPULAR SCIENCE

June, 1964

"They effortlessly fill my large listening room with clean, well-balanced sound."

© 1964, Popular Science Publishing Co., Inc.

### AUDIO

April, 1964

"...the Electro-Voice Model SIX is as close in sound to a Patrician as one can come without being a Patrician. You listen."

### high fidelity

April, 1964

"Reproducing test tones, the Model SIX was found to have a remarkably smooth, clean and uniform response across the audio range!..."

But whatever one's personal listening tastes are, it would seem there is an E-V model to suit them."

### The American Record Guide

December, 1963

"(I) have found them to be smooth and easy-to-listen-to...I found the top end very smooth and silky, not overbright, and also it extended well beyond the 15-kc. claim of the manufacturer."

# If Speakers Could Blush, Ours Would!

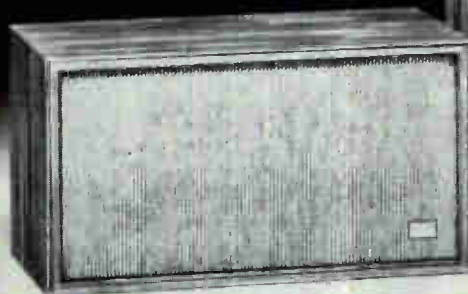

E-V TWO  
\$120.00

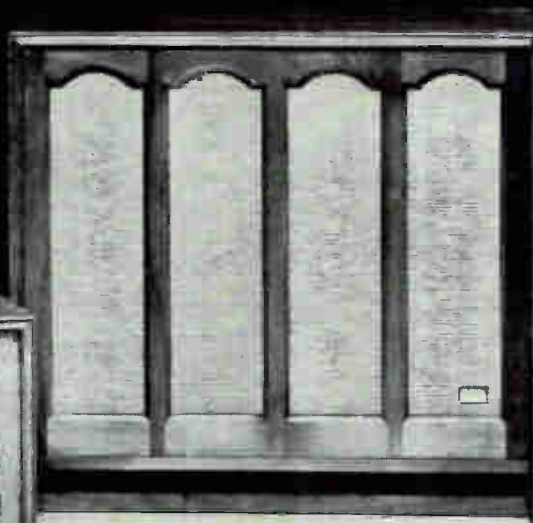

E-V SIX  
\$297.00

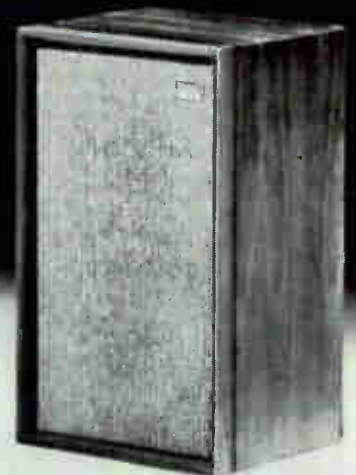

E-V FOUR  
\$151.87

*Read what the critics say about the new E-V TWO, E-V FOUR and E-V SIX acoustic suspension speaker systems. Then conduct your own impartial listening test. For a complete set of review reprints, plus the name of your nearest franchised E-V hi-fi showroom, write us today.*

ELECTRO-VOICE, INC., Dept. 1044EE, Buchanan, Michigan 49107  
CIRCLE NO. 21 ON READER SERVICE CARD

**Electro-Voice**<sup>®</sup>  
SETTING NEW STANDARDS IN SOUND

# 5 Speakers & Cabinets

## Model T35

Compression type driver with horn; frequency response to 20 kc; 16 ohms im-

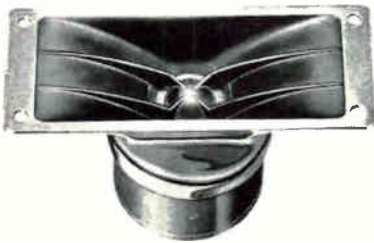

pedance: sensitivity 56 db; 6.8 oz. magnet; crossover 3500 cps; size 2" h. x 5 1/4" w. x 2 1/4" d.; driver diameter 2 1/4".....\$32.00

## Model T350

Compression-type driver with horn; response to 23,000 cps; 16 ohms impedance;



sensitivity 60 db; 1 lb. magnet; crossover 3500 cps; 2 7/8" h. x 7 1/2" w. x 4 1/2" d.; driver diameter 3 1/2".....\$58.00

## Model LS12 12" Speaker

Response 40-14,000 cps; EIA sensitivity rating 45 db; free-air resonance 65 cps;



power handling capacity 40 watts peak; impedance 8 ohms; mechanical crossover 6000 cps; 12 1/4" dia., 3 1/2" deep; 11" baffle opening .....\$22.50

## Model LS15 15" Speaker

Wide-range design 35-14,000 cps; 40 watts peak capacity; free-air resonance 50 cps;



crossover—mechanical at 4500 cps; 8 ohms impedance; 6 1/2" deep.....\$29.50

## Model LT12 12" Speaker

Three-way speaker; combines design fea-



tures of Wolverine full-range speakers plus "deep-dish" cone and HF1 tweeter; response 40-18,000 cps; power handling capacity 40 watts peak; free-air resonance 60 cps; EIA sensitivity 45 db; impedance 8 ohms; mechanical crossover 2000 cps; electrical crossover 3500 cps; built-in crossover and three-position tonal balance switch; 12 1/4" dia., 5 1/2" deep. ....\$36.00

## Model MF1 Mid-Range Step-Up Kit

Provides increased output in presence range; consists of MR11 driver and CR10

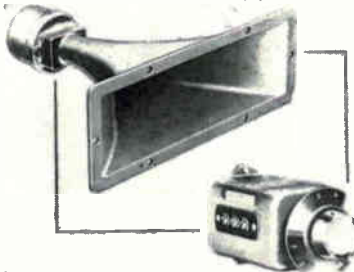

crossover-level control; requires baffle opening 9 1/2" x 3".....\$30.00

## Wolverine LT-8 8" Speaker

Has 3 separate radiating elements with an electrical crossover at 5000 cps and a me-



chanical crossover at 2000 cps. Resonant freq. 65 cps; response 45-18,000 cps; 8 ohms; 40 watt peak power. Woofer has 2" v.c. & dome horn tweeter 1" v.c. Sensitivity 45 db. Has a high-freq. level control..\$33.00

## Wolverine LS8 8" Speaker

Dual-cone 8" wide-range speaker; response 45-14,000 cps; power rating 40 w. peak;



resonance 75 cps; impedance 8 ohms; 3 1/2" deep .....\$21.00

## Model SP12B "Radax Twelve"



12" dual-cone; capacity 60 watts peak; response 35-15,000 cps; resonance 40-50 cps; 16 ohms impedance; sensitivity 49 db; 1 lb.,

6 oz. ceramic magnet; crossover 4500 cps; baffle opening 11"; depth 6 3/4".....\$39.25

## "Musicaster" Outdoor Speaker

Weatherproof speaker for outdoor use; frequency response 60 to 13,000 cps; imped-

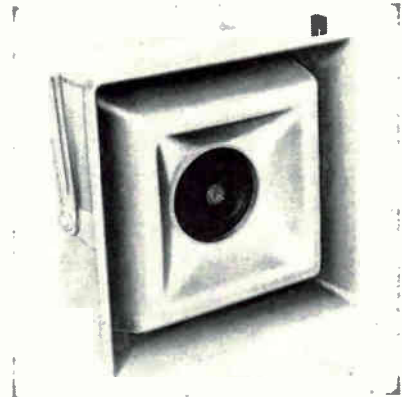

ance 8 ohms; dispersion 120°; uses back loaded folded horn design; diecast aluminum horn; 21 1/2" h. x 21 1/2" w. x 8 1/2" d.; shipping weight 34 lbs.....\$75.00

## "Musicaster II"

Same features as "Musicaster" except has v.h.f. driver to extend range to 18,000 cps. ....\$105.00

## "Soundcaster" Speaker

Portable design for outdoor applications. All parts are weatherproof. Has dual-cone

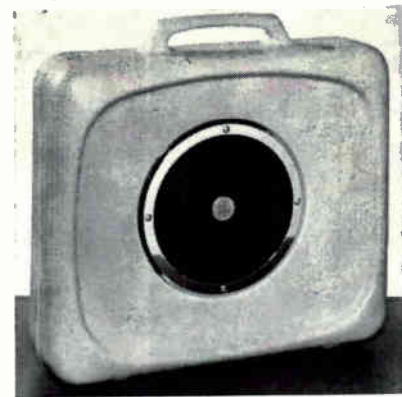

8" speaker. Response 70-13,000 cps; 30 watts peak power; 8 ohms; sensitivity 46 db. Mechanical crossover is at 6000 cps. 16 3/4" h. x 17" w. x 5 7/8" d.....\$36.00

## "Stereon 850" Speaker System

Three-way speaker system designed to complement "Patrician 800" or "Georgian 400" to expand to stereo; uses mid-bass, treble, and very-high-frequency components of the "Patrician 800" (SP12, T250 with 8HD) and T350) with crossover and level controls; response 100-23,000 cps; 17" w. x 16 7/8" x 30" h.; mahogany, walnut, unfinished birch.....\$375.00

## Model 8HD Diffraction Horn

Diffraction principle effects 120° dispersion; crossover 700-800 cps; cut-off 600



cps; intended specifically for T10A & T25A drivers; 15" h. x 4 1/2" w. x 8 1/4" d. ....\$22.00



***And they're all made by Empire***

The company that's always years ahead in the designing and engineering of high fidelity components. Its Grenadier Speaker . . . a divergent lens speaker system. The first loudspeaker designed and engineered for stereophonic reproduction that lets you sit anywhere—hear everything. Its Empire Troubador . . . a classic, set a new standard in record playback performance . . . judged by experts to be the finest available. Its 880p and 880pe (Elliptical) Cartridges . . . acclaimed by every equipment reviewer that tested it to be the best money can buy. For actual performance proof, go 'round to your HiFi dealer. For complete literature...write to Empire.

**EMPIRE**

"World's Most Perfect High Fidelity Components"

Empire Scientific Corp., 845 Stewart Ave., Garden City, L.I., N.Y./Export: EMEC, Plainview, L.I., N.Y./Canada, Empire Scientific Corp., Ltd., 1476 Eglinton West, Toronto

# 5 Speakers & Cabinets

## Model MC8 8" Speaker

Dual-cone design; response 50-13,000 cps; 24 watts peak capacity; 75 cps resonance;

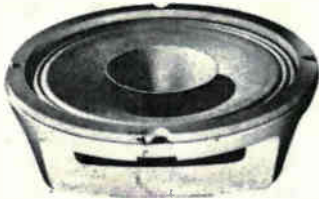

crossover—mechanical at 6000 cps; 8 ohms; 3 9/16" deep .....\$15.00

## Model BB1 & BB4 Building Block Kits

Additive kits to expand mid- and high-frequencies of existing system; each package is complete with matched crossover unit, AT37 level control, wiring harness, and full instructions.

BB1 Tweeter (T35, X36).....\$47.00  
BB4 Mid-Range (T25A, 8HD, X8).....\$115.00

## Model HF1 High-Frequency Step-Up Kit

Extends range beyond audible limit; consists of TW35 tweeter and CR35 crossover-

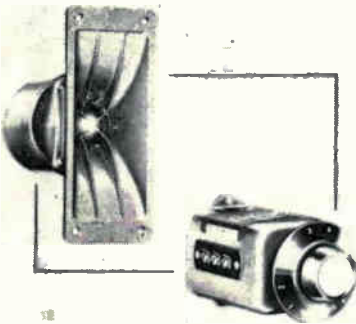

level control; response 3500-18,000 cps; requires opening 1 3/4" x 4 1/4" .....\$28.00

## The "Coronet" Speaker Kit

Pre-finished kit assembled without tools; available with any 8" full-range speaker;

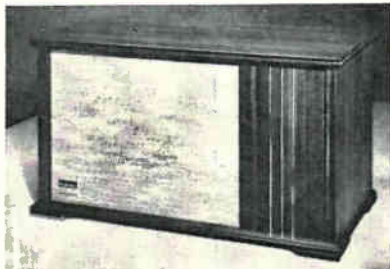

has provision for adding tweeter, crossover & level control; available in walnut finish; 12 1/2" x 22 1/4" x 10 7/8" d.

Coronet I with Michigan MC8 speaker .....\$47.00  
Coronet II with Wolverine LS8 speaker .....\$52.00  
Coronet III with SP8B speaker.....\$62.00

## The "Marquis 300"

Bridges the gap between low-resonance units and high-efficiency systems: direct-radiator acoustical phase inverter design

with 3-way speaker system: SP12B coaxial crossing over at 800 cps to compression horn mid-range, crossing over at 3500 cps to compression-type tweeter; L-pad used for level adjustment; 29 1/2" h. x 19" w. x 15 1/8" d.; oiled-walnut finish.....\$240.00

## Model X8 Crossover

Single crossover, 800 cps; 16 ohms impedance in and out.....\$42.50

## Model X36 Crossover

For use with v.h.f. drivers; crossover 3500 cps; impedance 16 ohms in and out..\$13.00

## Model X1020 Crossover

For use with 30 w. woofers; crossover of 100 or 200 cps allowing speakers to be used as "super woofers" with any existing system; 16 ohms impedance in and out..\$50.00

## Model X1835 Crossover

Full half-section throughout; crossover points 100, 800, 3500 cps; impedances 16 ohms in and out; 17" h. x 9 1/2" w. x 3 3/4" d. ....\$80.00

## "Georgian 400" Speaker System

Completely compression-operated four-way system; uses 18W 18" low-frequency



driver which crosses over at 250 cps to 8" speaker which reproduces mid-bass range; 800 cps crossover feeds frequencies from 800-3500 cps into T25A driver with 8HD diffraction horn; above 3500 cps the T350 "Super Sonax" v.h.f. driver takes over to provide extended high frequencies out to and beyond the range of audibility; system includes crossover network using full half-sections throughout and three AT37 L-pad attenuators for adjustment of presence and brilliance to balance room acoustics; impedance 16 ohms; power handling capacity 35 watts program, 70 watts peak; available in walnut, mahogany, cherry; 42" h. x 28" w. x 21" d.....\$495.00

## "Marquis" Enclosure

Designed to produce optimum results with separate 12" driver, full-range coaxial, and



extended range three-way speaker system; enclosure only; 29 1/2" h. x 19" w. x 15 1/8" d.; mahogany or oiled-walnut.....\$85.00

## KD Enclosure Kits

Kits of pre-cut clear-grain birch for building standard EV enclosures; complete with glue, screws, and detailed instruction book. KD6 "Aristocrat"; takes 12" full range speakers or 2- and 3-way systems using

12" woofers; 36 lbs.....\$53.25  
KD9 "Marquis"; takes all 12" speakers plus EV Models BB1, BB3 and BB4 building-block kits; 29 3/8" h. x 19" w. x 14 1/2" d. ....\$57.50

## Enclosure Construction Plans

"Aristocrat" .....\$2.00  
"Marquis" .....\$2.00  
"Patrician" .....\$2.00

## "Sentry I" Speaker System

Designed specifically for monitor use in recording & broadcast studios; wall or ceiling

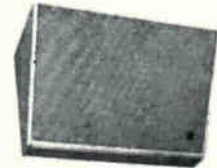

mounting with 12" speaker, diffraction horn high-frequency driver; response 30-20,000 cps; has matching transformer; 16, 150 & 600 ohm impedance; hardwood cabinet, unfinished; 21 3/4" x 37" x 17" d. ....\$248.33

## "Sentry II" Speaker System

Same design as "Sentry I" except cabinet is rectangular; finished all four sides; 32" x 20" x 13" .....\$265.00

## The "E-V Two"

Two-way system combining 12" woofer and compression-type high-freq. driver in totally sealed enclosure; has step-type level control; response 30-15,000 cps; crossover at 800 cps; 60 watts peak; 8 ohms; 14" h. x 25" w. x 13 1/2" d.; complete in oiled walnut or mahogany.....\$115.00  
Also available in kit form with all parts supplied; cabinet is pre-cut & pre-finished in oiled walnut.....\$97.00

## The "E-V Six"

High-efficiency 4-way system with special 18" foam-cone woofer; an 8" driver to cover 250-800 cps; a combination driver & diffraction horn to cover 800-3500 cps; and a compression v.h.f. driver and diffraction horn; response 30-20,000 cps; 70 watts peak; 8 ohms; has 4-way crossover; 30" h. x 32" w. x 17 1/2" d.; walnut or mahogany in traditional styling.....\$290.00

## EMI

### Model 319 Speaker System

Bookshelf design, completely enclosed and heavily damped, 2-way system; low freq.



speaker 13 1/2" x 8 1/8" elliptical with aluminum center cone and high-compliance suspension; tweeter 3 3/8" cone design; response 50-15,000 cps; 8 ohms; 23" x 11 1/2" x 10 3/4" d.; in oiled walnut.....\$99.75  
Unfinished gum wood.....\$94.75

### Model 630 Speaker System

Similar in appearance and design to Model

319; has 10 3/4" x 6 1/2" low-frequency speaker; response 60-15,000 cps; 20 1/2" x 11" x 9 3/8" deep; in oiled walnut.....\$69.75  
Unfinished gum wood.....\$64.75

**Model DLS 529 Speaker System**

Bookshelf type; walnut veneer with metal grille; 24"x13"x12 1/4"d; combines one

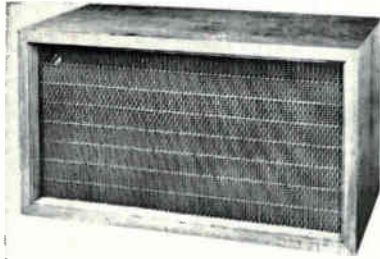

woofer (13 1/2"x8 1/8" elliptical driver with aluminum cone, plastic suspension) and two 3 1/2" tweeters; crossover operates from 4500 cps upward; response 40-15,000 cps; high-efficiency-type system; made by EMI of England.....\$159.00

**Model 711A 3-Way System**

Four separate speakers are used, a 13 1/2" x 8 1/8" elliptical woofer with 1 1/2" v.c. and

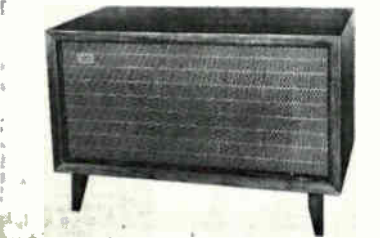

aluminum cone, a 10 3/4" x 6 1/2" mid-range, and a pair of 3 3/8" high-freq. speakers; has an LC crossover network (1200 & 6000 cps) and a 4 push-button level control; adjustable pedestal base is included for either horizontal or vertical operation; 28 1/2" x 14 1/4" x 15" d; 8 ohms.....\$249.00

**Model 812 Speaker System**

2-way design with a 6 1/2" & a 3 3/8" cone-type speakers. Crossover 4500 cps; response



80-15,000 cps; 8 ohms; 14 1/2" x 10 1/2" x 8" d.; walnut cab.....\$49.95

**Model 1 Baffle Speaker System**



For custom installations—3/4" baffle board supplied with all components (identical to those in Model DLS-529; mounted and

wired. Recommended for use with 1 3/4 cu. ft. air-tight enclosure; 11 1/8" x 22 3/8" x 4 ohm impedance.....\$115.00

**Stereoscope Model DLS-1**

Monitor loudspeakers with built-in amplifiers; EMI 25-watt amplifier (0.1% distortion) is installed in the base of each column enclosure; requires use of 4 adjustable frequency correcting networks to attain uniform frequency response 30-15,000 cps (adjusted at factory); woofer cone resonance 25 cps; 2 tweeters; by arranging the 3 speakers vertically one above the other, the horizontal polar characteristic is maintained uniformly over a wide range of frequencies; column is mounted on 4 casters so it can be moved easily; 50"x13 1/4"x17"; wt 110 lbs.....\$594.00

**EMPIRE**

**Model 8000 "Grenadier" Speaker System**

Features 12" high-compliance woofer with 4" v.c.; direct-radiator midrange & domed tweeter. Response 30-20,000 cps; 8 ohm impedance; power capacity 100 w. music power. 29" h. x 15 1/4" dia. ....\$180.00



**Model 9000 "Royal Grenadier"**

Similar in design to Model 8000 except has a 15" woofer; response 20-20,000 cps; 29" h. x 22" dia. walnut. ....\$250.00

Model 9000M with marble top.....\$260.00

**Model 8200 "Grenadier"**

Bookshelf design with same speaker system & performance as Model 8000. 24 3/4"



w. x 14" h. x 12 1/2". Walnut.....\$180.00

**FISHER**

**Model XP-1A Speaker System**

Consists of 12" woofer, 5" mid-range, 3 1/2" cone tweeter; crossover has air coils



and oil-filled capacitors; woofer can be used independently; power capacity 60 watts; frequency response 30 cps—in audibility; brilliance control rear of cabinet; 13 1/2" x 24" x 11 3/4"; 40 pounds.

Walnut, mahogany, cherry.....\$129.50  
Unfinished birch .....\$124.50

**Model XP-4A 3-way Speaker System**

Four speakers, 12" woofer with 2" voice coil, 2-5" mid-range, 2" hemispherical



high-frequency unit covering angle of 120 degrees; balance controls for middle and high frequencies; 3-way crossover; 8 ohms; response 30 cps to beyond audibility; 12 1/2" x 24 1/2" x 14".

Mahogany, walnut or cherry.....\$199.50  
Unfinished birch.....\$189.50

**XP-5 Speaker System**

Two-way system with 8" woofer (25 cps free-air resonance) & a 2 1/2" wide-disper-

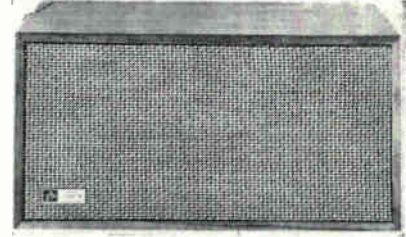

sion cone tweeter. Response 38-18,500 cps; 8 ohms; 2000 cps crossover; 10" x 20" x 9" d.

Oiled walnut .....\$54.50  
Unfinished birch .....\$49.50

**Model XP-10 Console Speaker System**

Features 3 speakers: 15" woofer, 8" mid-range, 2" dome-type tweeter; has 3-way



L/C crossover (200 & 2500 cps); response 28 cps to beyond audibility; walnut finish; 30 1/4" x 24 3/8" x 14 1/8" d.....\$249.50

**Model KS-1 "StrataKit" Speaker System**

Three speakers, 10" woofer with 4 1/2 lb. magnet structure, 5" mid-range, 3" super-



# 5 Speakers & Cabinets

tweeter; three-way crossover; response 40-18,000 cps; "Slim-Line" design; 18" x 24" x 5 1/4" deep; kit.  
 Unfinished birch .....\$59.50  
 Unfinished walnut .....\$64.50  
 Assembled finished birch .....\$84.50  
 Assembled finished walnut .....\$89.50

## KS-2 "Slim-Line" Speaker Kit

Features 3 speakers: 12" woofer, 5" butyl-coated mid-range, 3" cone-type tweeter:



response 35 cps to beyond audibility; 3-way L/C crossover (1200 & 2800 cps); has continuously variable tweeter balance control; 25" x 20" x 6 1/2" d.  
 Unfinished birch kit.....\$ 89.50  
 Unfinished walnut kit.....\$ 94.50

## Model XP-2A Speaker System

Three-way system with 10" bass speaker, 5" mid-range, and 3 1/2" tweeter; three-way crossover; 22" x 12" x 11 1/4" deep; similar in appearance to Model XP-1A; available in mahogany, walnut, cherry.....\$84.50  
 Unfinished birch .....\$79.50

## FRAZIER

### "Del Mar" Speaker System

Response 40-15,000 cps with 8-ohm output impedance; 23 3/8" w. x 23 3/4" h. (including



legs) x 11 3/8" d.; walnut finish .....\$79.50  
 "Del Mar II" with extra 1200-cps crossover, attenuator & horn tweeter.....\$109.50  
 Model F-8-3X Utility full-range version (black box) modified Helmholtz type 15 w. power capacity; 19" w. x 23 3/8" h. x 11 3/8" .....\$ 57.00  
 Model F-8-3Y Wide-range utility version (black box); response 40-17,000 cps, with "Del-Mar II" components added.....\$ 87.00

### "Super Midget" Speaker System

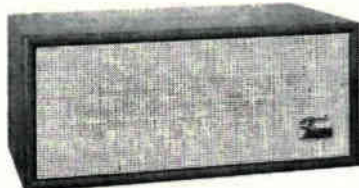

Response 52-12,000 cps, 10 w. power capacity with 8-ohm output impedance: 15 7/8" x 7 3/16" x 9 1/2" d.; walnut finish .....\$29.95  
 Unfinished birch.....\$26.95

### "Monte Carlo" Speaker System

Response 50-15,000 cps, 12 w. continuous power capacity and 8-ohm output impedance; has four concealed plastic feet; shipped two to the carton; 15 7/8" x 10 3/4" x 11 3/8" d.; walnut finish.....\$49.75 ea.  
 Unfinished walnut.....\$42.50 ea.

### "La Fiesta" Speaker System

Response 50-15,000 cps with 8-ohm output; Helmholtz-type resonator; 23 3/8" x 10 1/2" x 11 3/8" d.; packed in matched pairs for stereo; walnut finish 4 sides .....\$74.50 ea.  
 Unfinished walnut.....\$65.00 ea.

### F-3T Ceiling Speaker

For flush-mounting 360° radiation; has 8" woofer & 3 1/2" tweeter; 50-12,000 cps; 15 watts capacity; 8 ohms; 13 1/2" sq., 3 3/8" into ceiling & 2 1/8" below; 9" dia. cut-out required .....\$40.00

### "Corsair" Speaker Systems

Has 10" woofer & cone-type tweeter; woofer has 30 cps free-air resonance; crossover at 2000 cps (12-db attenuation each side); high-frequency attenuator; requires 1/2 w. to drive & will handle 20 w.; 8-ohm impedance; 11 1/8" w. x 23 3/8" h. x 11 3/8" d.; oiled walnut with cane fabric type grille. "Corsair I" 30-15,000 cps.....\$119.95  
 "Corsair II" 30-17,000 cps.....\$129.95

### "Bel-Aire" Speaker System

Thin-line design; response 50-12,000 cps; input 1/2 w. for normal listening; power

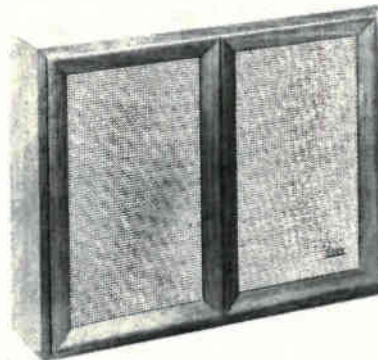

capacity 20 watts; 16 ohms; 23 3/8" w. x 19" h. x 5 1/2" d.; oiled walnut.....\$59.95

### "Mark V" Speaker System

Has a special 12" woofer, two mid-range cone speakers, and a high-frequency horn along with separate attenuators for mid-range and treble response; input 1/2 w. required for normal listening; power capacity 20 w.; 16 ohms; response 30-17,000 cps; crossover at 200 and 3300 cps; 14" w. x 26 1/2" h. x 12".  
 Oiled walnut with cane fiber type grille .....\$169.95  
 Black utility design for custom installations .....\$139.95

## GOODMANS

### "Triaxiom" Series

Complete range of three-way speakers for every preference and budget; response 20-20,000 cps (unless noted otherwise); "Rigidflex" woofer cones; axially mounted compression tweeter.

Triaxiom 8 (8", 40-20,000 cps, 15 watts) .....\$ 29.50  
 Triaxiom 100C (12", 20 watts).....\$ 34.50  
 Triaxiom 250C (12", cone resonance 35 cps, 35 watts) .....\$ 64.50  
 Triaxiom 550C (12", cone resonance 35 cps, 45 watts) .....\$ 79.50  
 Triaxiom 555C (15", cone resonance 25 cps, 50 watts) .....\$ 89.50  
 Twinaxiette 8 (8" twin-cone, 40-18,000 cps, 15 watts).....\$ 18.95

### B-4 "Perfectionist"

3-way system—10" floating piston-hyperbolic woofer, 6" closed-back direct radiator

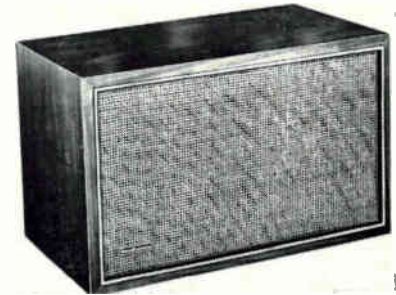

midrange & 3 1/2" closed-back tweeter. Response 40-18,000 cps; capacity 20 watts music power; 8-16 ohm impedance; walnut finish; 24" l. x 14" h. x 12" .....\$66.00

### B-5 "Perfectionist"

3-way system—12" woofer, midrange & wide angle exponential compression horn. Response 25-20,000 cps; 35 w. music power; 8-16 ohm impedance; Size same as Model B-4 .....\$120.00

### "Maximus 1" Speaker System

Specially designed "Maximus" woofer crosses over at 900 cps to a back-loaded

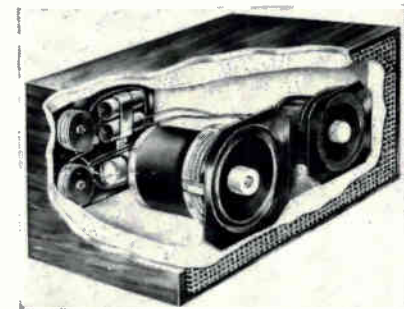

midrange/high freq. unit. Response 45-20,000 cps; 15 w.; L/C crossover, 10 1/2" x 5 1/2" x 7 1/4".....\$59.50

### "Maximus 2" Speaker System

Handles twice the power of "Maximus 1." Has 2 "Maximus" woofers. Response 35-20,000 cps. 14 1/2" x 11" x 8".....\$109.00

### "Maximus 3" Speaker System

Employs 4 "Maximus" woofers & 2 mid-range/high freq. units. Response 30-20,000 cps; 60 watts; Dist. less than 1/2% 150-

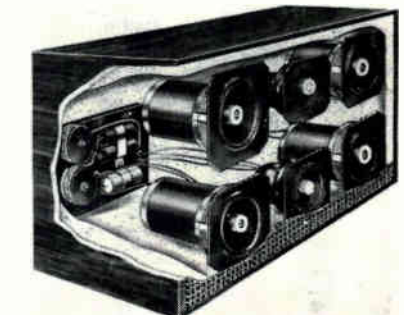

***We aim at the Six***

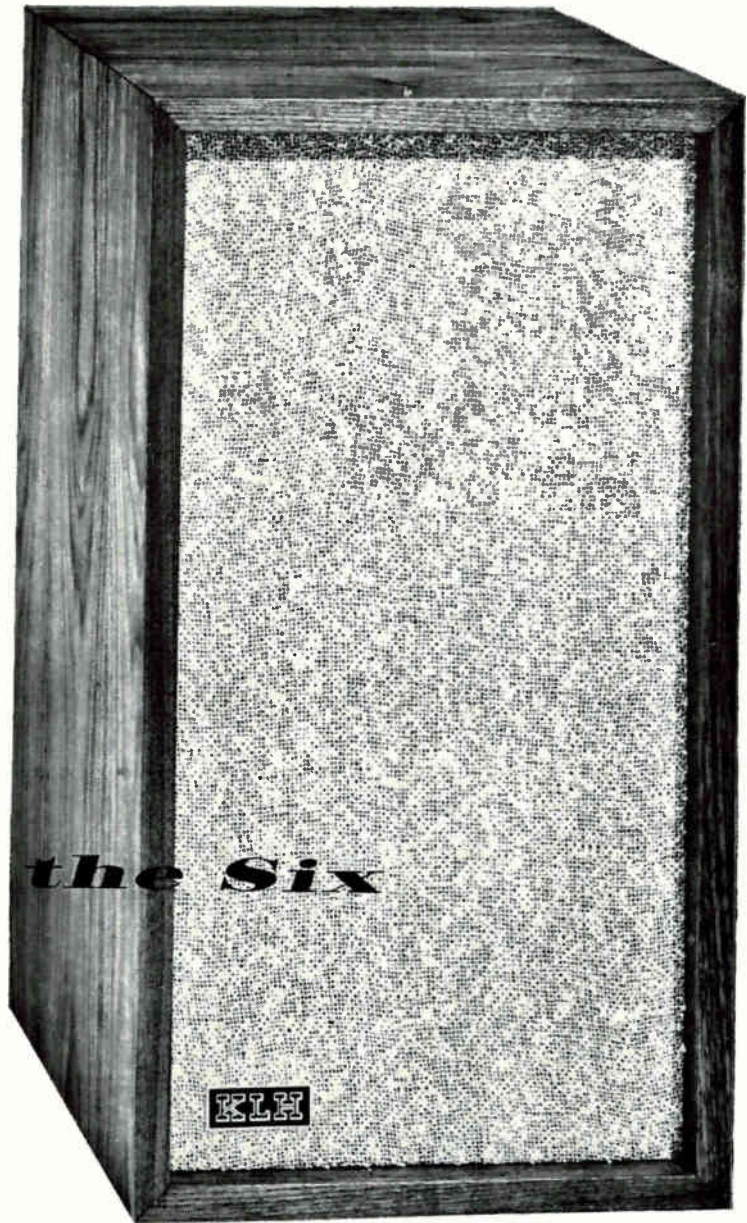

KLH makes speaker systems that sell from \$50 to \$1140. Each of these systems delivers the cleanest, best balanced performance you can buy for the price.

But the one by which we judge every new product we make is the Model Six.

How does such a modestly priced speaker become the standard bearer for an entire line?

It isn't just that the Six is a magnificent speaker. More than any other speaker we have ever made, the Model Six embodies the qualities that the name KLH stands for — an engineering approach that separates the trivial from the important; cuts through the accepted to find the exceptional — a patient, painstaking effort to give you cleaner, finer performance at lower cost.

We aim at the Six because it gives you the highest quality of performance, *per dollar*, of any speaker we make. Or anybody else makes.

That's why we call the Model Six:

the lowest priced speaker  
you can be satisfied with  
for the rest of your life.



CIRCLE NO. 31 ON READER SERVICE CARD

KLH RESEARCH AND DEVELOPMENT CORPORATION  
30 CROSS STREET, CAMBRIDGE 38, MASSACHUSETTS

# 5 Speakers & Cabinets

20,000 cps (5% @ 30 cps); 18" x 12 3/4" x 10" .....\$169.00

## Axiom 80

9 1/2" speaker, 20 to 20,000 cps; 15 watts peak power handling; fundamental resonance 20 cps; flux density 17,000 gauss; utilizes 3 pairs of double action cantilevers to provide a custom built, hand assembled, true free-edge cone speaker to handle lowest bass tones with minimum distortion .....\$69.95

## GRADO

### "Laboratory Standard" Speaker System

Response 25-20,000 cps; power 5 w. mini-



mum, 75 w. peak maximum; 8 ohms: 16" w. x 20" h. x 10". Supplied with 3/4" walnut wood cabinet.....\$150.00

### "Mini-Lab" Speaker System

Response 45-17,000 cps; power 5 w. mini-

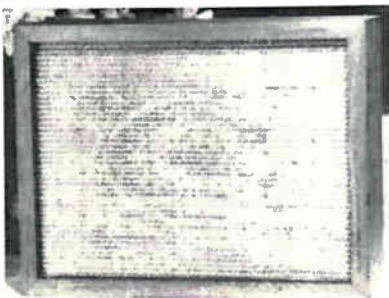

mum, 30 w. peak maximum; 16 ohms: 11" w. x 14" h. x 5".....\$49.50

## HARTLEY

### Model 218MS 18" Woofer

Response 15-3000 cps. Has heavy cast aluminum frame, 14 lb. Alcomax III magnet.



tri-polymer cone with magnetic suspension .....\$195.00

### Model 220 MS 10" Speaker

Full-range speaker; heavy cast-aluminum basket; 6.1 lb. Alcomax II magnet; 16,000 lines/sq. in. flux density; tri-polymer cone



with magnetic suspension; 8-ohm voice coil; response at low end to 16 cps...\$135.00

### Model 312 12" Speaker

Cast aluminum frame; polymerized cone; double-U cloth suspension; 5 3/4 lb. mag-



net; full-range 25-20,000 cps; 8 ohms .....\$99.95

### Model 310 Speaker

Chemically treated polymerized paper-cone version of Model 220MS speaker less "Magnetic Suspension".....\$85.00

### Capri Shelf Model Enclosure

Totally enclosed cabinet containing 35' absorbent material; 24" x 13 1/2" x 12";



in oiled natural walnut with bamboo grille, finished on all sides.

With Model 310 speaker.....\$130.00  
With Model 220MS speaker.....\$180.00

### Concertmaster Speaker Systems

Mark III oiled-walnut modern design with Model 218MS & 220MS speakers. Acousti-

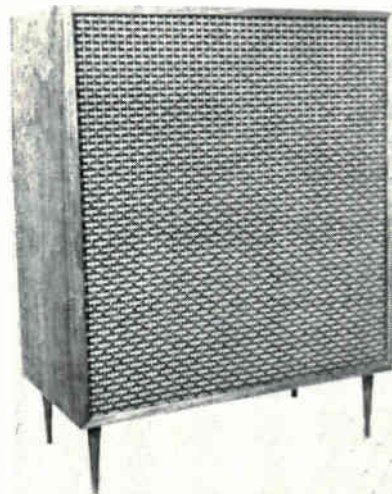

cally treated with Soundsorbers; 38" h. x 29" w. x 16"; crossover @ 250 cps.

.....\$495.00  
Mark IV Same as Mark III except traditional design.....\$25.00

## Holton "A" Enclosure

For use with 220MS speaker; heavily braced, damped cabinet in natural woods;



24"x13"x34" over-all dimensions including legs.

Cabinet with 220MS speaker.....\$245.00

Cabinet with 310 speaker.....\$195.00

Cabinet with 312 speaker.....\$215.00

Cabinet with two 220MS speakers, cross-over, and Soundsorbers.....\$395.00

## Holton, Jr. Speaker System

Uses Model 220MS speaker; oiled, rubbed walnut finish with cane front grille; also available with new 310 speaker which is chemically-treated version of Model 220-MS; frequency response 25-25,000 cps.; power capacity 25 watts; Model 310 speaker has dome-shaped center high frequency radiator; 10" diameter; 30"x15" x12" over-all dimensions.

With Model 220MS speaker.....\$195.00

With Model 310 speaker.....\$135.00

With Model 312 speaker.....\$155.00

## HEATH

### Model AS-2AU Speaker System

Acoustic-suspension design in infinite baffle; uses 4 speakers—10" woofer, 2-5" cross-

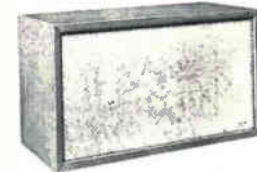

fire mid-range & super tweeter; has built-in crossover network; response 40-20,000 cps ± 5 db; 8 ohms; recommended min. power 20 w.; LC crossover 2000 & 7500 cps; dispersion 90°; has individual level controls for tweeter & mid-range; cabinet factory pre-assembled; 13 1/2" x 24" x 11 1/2" d.; kit unfinished hardwood .....\$89.95  
Finished walnut .....\$99.95

### AS-2U Acoustic Suspension System

Frequency response 40-15,000 cps ± 5 db; crossover frequency 2000 cps; recommend-

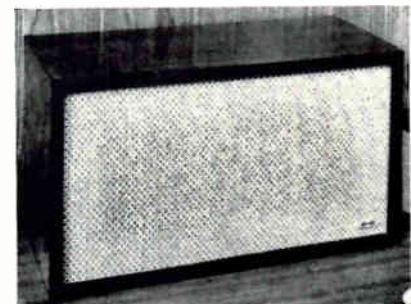

ed amplifier power 20-40 watts; 2-5" cone tweeters mounted in array; 10" acoustic suspension woofer has 1.1 lb. Alnico V magnet; resonant frequency when mounted 58 cps; horizontal dispersion 90 degrees; shpg. wt. 44 lbs.; cabinet factory pre-assembled; unfinished kit.....\$72.95



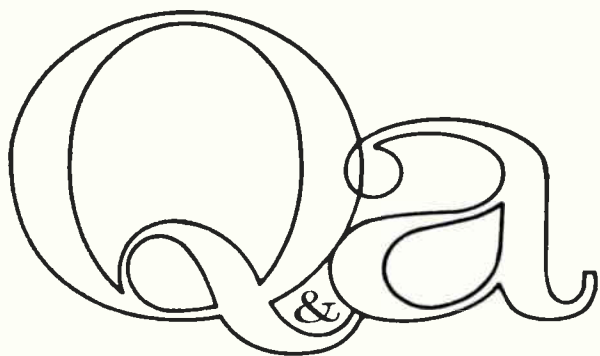

# on Hi-Fi SPEAKERS

By FRED W. NICHOLS/Electro-Voice, Inc.

**S**INCE our firm makes speakers and speaker systems, we receive hundreds of letters from audiophiles who want information to enable them to use their existing speakers to better advantage or permit them to make a satisfactory selection of a new speaker to go with their present hi-fi systems. Typical, and most frequently asked, are:

*I am using an amplifier rated at 70 watts with a speaker rated at 30 watts. Is there a possibility of damaging my speaker?* Under normal operating conditions there is little chance that your speaker would be damaged. The efficiency of most high-fidelity speakers is such that the sound from the speaker would be deafening before the speaker power limit is reached. There is one area of caution, however. If connecting cables are removed from their sockets while the equipment is on, there is the possibility that a momentarily ungrounded cable would introduce a burst of hum into the equipment which might drive the amplifier to full output. Putting even as much as 30 watts of 60-cycle hum into a 30-watt speaker might be harmful under certain conditions.

*Does a 30-watt speaker, for example, require a 30-watt amplifier for proper operation?* A speaker's peak power rating is the maximum power which the speaker can handle safely, much as a highway speed limit is the maximum speed for safety. Exceeding either limit is risky business. During normal home listening, the speaker's power rating is seldom approached. A high-efficiency speaker requires only a watt or two from the amplifier for average listening level. Some components have both a program-material and peak-power rating, with the peak rating approximately twice program rating. If only one power capacity is stated, make sure you know which rating it is.

*Then why does literature on certain speakers, especially compact systems, state that a 12- to 20-watt amplifier is required?* Compact or acoustic-suspension speaker systems are a breed apart from other types of high-fidelity systems. However, the same set of acoustic laws applies. Low-frequency response, enclosure size, and system efficiency are directly related. In order to reduce enclosure size without losing low-frequency response, efficiency *must* be sacrificed. Although compact systems are engineered for the best balance of these three variables, compact-system efficiency is generally lower than that of large, traditionally designed high-efficiency components. For this reason, a compact system may require several times the amplifier output required by a high-efficiency speaker for the same acoustic output. Using at least a 20-watt amplifier assures that the amplifier will be able to supply the needed power well within its ratings, and thus minimizes distortion which increases very rapidly as the amplifier's rated power is reached.

*Why can't I put a conventional speaker in a small enclosure to make a compact system?* You can—if you don't

mind a loss of bass response. Woofers for small enclosures require certain design considerations which are not incorporated in conventional speakers. To get the best performance of which your speaker is capable, you should mount your speaker in the enclosure recommended for it by the manufacturer. Most speaker manufacturers offer plans of recommended enclosures to home constructors.

*I've heard a great deal about the advantages of transistor amplifiers. Is there any specific difference in speaker performance when a transistor amplifier is used?* In addition to reduced heat and improved long-term stability of transistor amplifiers, there is one major improvement in speaker performance which is usually discernible in listening tests. Because the damping factor of a well-designed transistor amplifier remains high even at low frequencies, the speaker's low-frequency response is often "tighter" than with a tube-type amplifier. This effect is particularly noticeable with compact systems which have less inherent control of cone movement. This tight control may be a major portion of what is often called "transistor sound." Some inexpensive transistor amplifiers have greatest output at 4 ohms. Available power at 8 or 16 ohms may be substantially reduced. Be sure to check the amplifier's rated power at the output impedance you plan to use.

*Should the impedance of an "add-on" driver be the same as the full-range speaker's impedance?* Although drivers with different impedances may be used together, their impedances should be the same for best results. One major reason for this stipulation is found in the design of the associated crossover network. When a crossover feeds a driver which does not have the same impedance as the crossover design, the crossover frequency shifts substantially. This can result in peaks or dips around the crossover frequency, rather than the smooth response which would result if all components had the same rated impedance.

*What is the best way to add extension speakers to my stereo system?* If you wish to have stereo sound in another location, then it is simply a matter of adding speakers in parallel with your present stereo speakers. In order to maintain a proper amplifier match, the speaker connections should be moved to the next lower amplifier tap. For example, two 16-ohm speakers connected in parallel should be hooked up to the 8-ohm tap. If speakers of mixed impedance are used, a little experimentation will usually indicate which impedance tap gives the best performance.

When a single speaker is used at remote locations, a mono signal is preferred so that no signal information is lost as would be the case if only one stereo channel were used to feed the remote speaker. Some stereo amplifiers have a center-channel power output which is usually a mono blending of the stereo channels. In addition to powering a center-channel speaker, this output may be used to drive remote loudspeakers.

# 5 Speakers & Cabinets

## Model AS-41 Speaker System

11" x 8" x 6 1/2" d.; in finished or unfinished cabinets; features 6" x 9" extended-range dual-cone speaker, 6.8 oz. magnet; response 60-16,000 cps; handles 12 watts

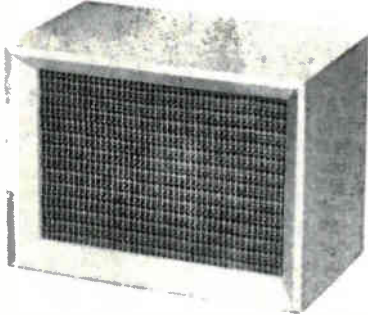

peak; impedance 8 ohms; for use as extension speaker or for converting mono system to stereo; 8 lbs.; cabinet factory pre-assembled; kit.

Model AS-41U (unfinished).....\$10.95  
Model AS-41W (walnut).....\$12.95

## Model AS-51 Speaker System

Ducted-port bass reflex bookshelf style enclosure; frequency response: 50 to 12,000



cps  $\pm 5$  db; power rating: 25 watts of program material; impedance: 16 ohms; 8" Jensen low-frequency speaker with 6.8 oz. Alnico V magnet, Jensen high-frequency horn-loaded compression driver with 4.7 oz. Alnico V magnet; built-in high pass filter and L-pad; 1/2" plywood; factory pre-assembled cabinet 11 1/2" x 23" x 11 1/4" d.

Unfinished kit.....\$39.95  
Model AS-51W (walnut kit).....\$46.95

## AS-10 Acoustic Suspension System

Utilizes acoustic suspension principle; 10" acoustic suspension bass speaker and two

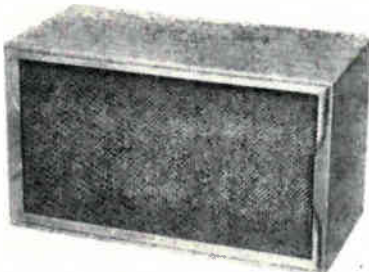

3 1/2" cone-type high-frequency speakers, housed in infinite baffle enclosure, covering 30-15,000 cps; "dispersal-array" of tweeter permits either upright or horizontal operation; high-frequency control allows adjustment of highs; cabinets are factory-assembled and finished on four sides; kit assembly involves wiring simple crossover network and installing speakers; unfinished kit.....\$59.95  
Model AS-10W (walnut).....\$64.95

## AS-21 "Legato-Compact" System

New speaker system retains performance characteristics of the earlier model while

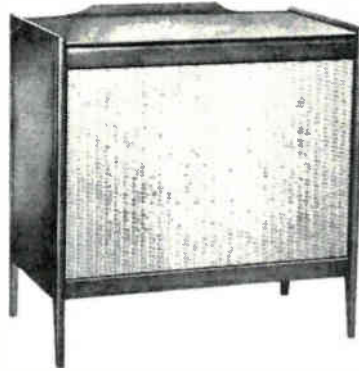

adding contemporary styling and compact size; two 12" Altec Lansing low-frequency speakers cover 30-800 cps; Altec Lansing exponential horn and high-frequency driver cover 800-22,000 cps; high-efficiency speakers permit use of 3-watt amplifiers to drive system; handles up to 30 watts program material; factory-assembled cabinets in pre-finished walnut; cabinet of 3/4" furniture-grade plywood; crossover network factory wired; 32" x 19" x 32 1/8"; 142 lbs.

Model AS-21W (walnut kit).....\$239.95  
Model AS-31 All components except cabinet for custom installation.....\$184.95

## Model AS-22U "Profile" System

Slim design; 5" deep; will stand on floor, set vertically or horizontally on table or bookshelf, or hang on wall; 3-way system; 10" woofer, 6" mid-range, 3 1/2" tweeter; closed back; cabinet factory pre-assembled; kit (unfinished whitewood).....\$49.95  
Model AS-22W (walnut).....\$54.95

## Model AS-81 Speaker System

Features a 6" woofer & 3" tweeter. Power capacity 6 w. peak; 8 ohm imp.; response



65-14,500 cps  $\pm 6$  db. Cabinet is supplied completely assembled, 10 3/4" w. x 6 1/2" h. x 6 1/2" d.

Model AS-81U Unfinished Kit.....\$17.50  
Model AS-81W Walnut finish kit.....\$19.95

## IONOVAC

### Model DuK-20

Compact, full-range speaker system; can be used as bookshelf unit, upright for



floor mounting; horizontally on thin-line legs (end-table height); speakers include Model DuK-5 high-frequency tweeter, two mid-range speakers covering 800-3500 cps; one 12" high-compliance woofer; 30" x 14" x 13" .....\$187.50  
Stand for Model DuK-20.....\$ 15.00

### Model DuK-5

High-frequency tweeter & power supply; response 3500-20,000 cps; employs no

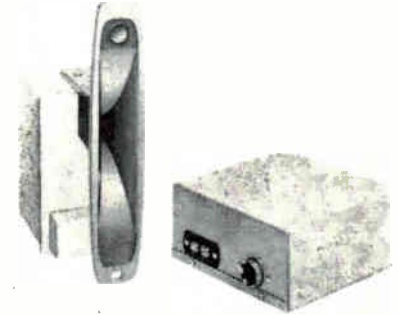

moving parts; produces sound by electrically charging air by means of sound-generating cell; horn is 9" high; power supply 2 5/8" x 2 3/8" x 5 3/8".....\$69.00

### Model DuK-10

"Add-On" speaker baffle unit consisting of Model DuK-5 high-frequency speaker and power supply; modulator and horn built into baffle with acoustic lens; 13 1/2" x 11".....\$79.50

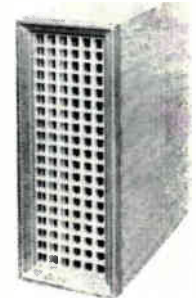

### Model DuK-50

Wide-range bookshelf speaker system; includes Model DuK-5 tweeter plus specially engineered 8" high-compliance speaker for all frequencies below 3500 cps...\$139.50  
Models 10 through 50 available in variety of fine woods with decorator tones.

### Model DuK-60

Full-range 3-way system; impedance 8 ohms; crossovers 800 & 3500 cps; 40 watts; tweeter is an Ionovac (ionized air)



type design; mid-range 8" direct radiator; woofers, two 12" high-compliance, 2" voice-coil designs; system incorporates two variable controls for level adjustment of "mids" and "highs"; available in walnut, cherry, mahogany, blonde finishes, over-all size 51" h. x 21" w. x 13" d.; wt. 68 lbs .....\$246.00

**Model DuK-30**

Wide-range columnar for corner mounting; includes Model DuK-5 tweeter, two mid-range speakers, one 12" high-compliance woofer; speaker baffle designed specifically for corner mounting; similar in shape to Model DuK-40; 48" x 15 3/8" x 11" .....\$199.50

**Model DuK-40**

"Stereo-Vac" small, columnar-type baffle housing the Model DuK-5 tweeter in addition to a specially engineered 8" high-compliance loudspeaker for all frequencies below 3500 cps. Unit measures 37" high x 12 1/2" wide x 9 1/2" deep; similar to Model DuK-30 above .....\$149.50



**JANSZEN**

**Model Z-600 Speaker System**

Model 350 woofer with two 130 electrostatic speakers sealed in a fiberglass-filled

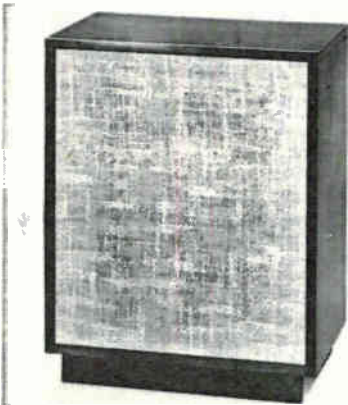

enclosure; includes power supply and high-pass filter; response 30 to beyond 30,000 cps; LRC high pass filter; has mechanical woofer roll-off & broad crossover region (1000-2000 cps); 70° H.F. dispersion; 8 ohms; 26 3/8" h. x 20" w. x 13" d.; walnut and oiled-walnut finish.....\$195.00

**Model 33 Electrostatic Speaker System**

Mid- and high-range only; 1200 to beyond 30,000 cps; less than .5% HD @ 50 watts

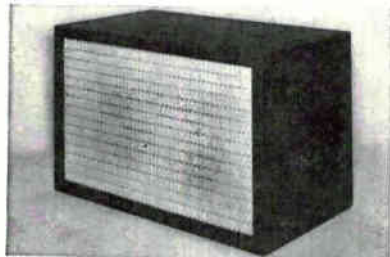

input below 10,000 cps; will handle 100 watts music power; includes built-in power supply; 8 ohms impedance.  
Model 33OW Oiled walnut.....\$68.25  
Model 33U Unfinished, black.....\$59.95

**Model 130 Tweeter**

Push-pull, constant charge electrostatic tweeter; capacity 50 watts; frequency response 500 to 30,000 cps; harmonic distortion less than 0.5% at 50 watts input

below 10,000 cps; dispersion 120°; a.c.-operated bias supply, LRC high-pass filter;



power supply draws 2 watts, 117 volt 60 cycle a.c.; size 7 1/4" x 22" x 13"; shpg. wt. 16 lbs.

- Model 130B (Birch).....\$179.00
- Model 130M (Mahogany).....\$184.00
- Model 130W (Walnut).....\$188.00
- Model 130UA (Flat Black).....\$169.00
- Model 130U (Flat Black in rectangular cabinet 7 1/4" x 23 1/2" x 10").....\$161.00

**Model 350 Dynamic Woofer**

11" cone woofer designed for use with 2.2-cubic foot (or larger) fiberglass-filled



enclosure; frequency range 30 to 2000 cps with mechanical roll-off above 2000 cps; fundamental woofer resonance 45 cps; magnet structure weighs 3 1/4 lbs.; flux density 10,800 gauss; power handling; up to 100 watts peak on complex music; impedance 8 ohms.....\$37.00

**Model Z-400 Shelf Speaker**

Combination high range electrostatic and 11" woofer; each electrostatic element has 176 push-pull sheathed conductors; woofer is sealed in enclosed fiberglass-filled baffle; power handling capacity up to 100 watts on music; magnet weighs 3 1/4 lbs.; frequency response 30-30,000 cps; LRC high-pass filter for tweeter only; crossover

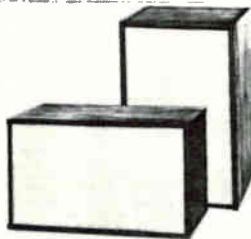

region 1000-2000 cps; high frequency dispersion 60°; impedance 8 ohms; 15" x 26" x 13 1/4"; 54 lbs.

- Model Z-400M Mahogany.....\$159.50
- Model Z-400B Maple (birch finish) .....\$159.50
- Model Z-400OW Oil Walnut.....\$159.50
- Model Z-400W Lacquered Walnut \$159.50
- Model Z-400U Utility.....\$144.50

**Model Z-500 Speaker System**

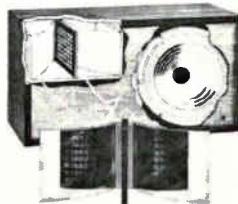

Single push-pull radiator version of electrostatic mid/high-range tweeter combined with 11" dynamic woofer; response 30-30,000 cps; 72° sound dispersion of tweeters; sound from both sides of flat radiator deflects toward listener from parabolic curved walls that form tweeter housing; built-in power supply and high-pass filter drive electrostatic tweeter; 24 3/4" l. x 13 1/2" h. x 11 3/4" d.; available in walnut, mahogany, maple, or birch; prices start at .....\$124.95

**JanKit 41**

Consists of electrostatic two-element model mid/high frequency driver supplied in



cabinet and Model 350 woofer both mounted on single panel mounting board; designed for custom installations; cabinet should be at least 2 cubic feet in volume; over-all dimensions 19 1/2" h. x 16" w. x 7 1/2" d. ....\$114.95

**JanKit 51**

Combines Model 350 11" dynamic woofer & one Model 33U single-radiator electro-



static mid/high-range tweeter mounted on 1/2" wood panel for custom installation; 30 to beyond 30,000 cps; 8 ohms, with broad crossover 1000-2000 cps; includes built-in power supply & high-pass filter; 20 1/4" x 16" x 7".....\$94.95

**JENSEN**

**PR-50 Bookshelf Speaker System**

2-way design. 5 1/4" low freq. & a modified E-10 ultra tweeter. Response 40-20,000 cps;



crossover 2000 cps; 8 ohms; power capacity 30 w. 7 3/4" d. x 9 3/8" h. x 18 1/8". Walnut finish .....\$69.50

**PR-150 Speaker System**

12" woofer (15 cps resonance) with MII-400 aspheric "Sono-Dome" midrange/v.h.f. speaker. Response 25-20,000 cps;

# 5 Speakers & Cabinets

crossover 2000 cps; power capacity 35 w. 8 ohms. 11 1/4" d. x 14" h. x 25".  
 Oiled walnut .....\$119.50  
 Unfinished .....\$ 99.50

## PR-400 Speaker System

3-way system. 15" Flexair woofer (20-1000 cps  $\pm$  2 db), MH-400 midrange, E-100



"Sono-Dome" tweeter (7-20 kc.). Response 20-20,000 cps; crossovers 1000 & 5000 cps. Power capacity 40 w. 8 ohms. 14 1/2" d. x 29 1/2" h. x 34". Walnut finish.....\$297.50

## PF/2 Thin Speaker System

Four-way, 5-speaker design. Polyform woofer, midrange, 2 tweeters & "Sono-



Dome" ultra tweeter. Response 20 cps to beyond audibility; crossovers 600-4000-6000 cps; power capacity 25 w. 8 ohms. 22 1/4" w. x 26 3/8" h. x 3 3/8" .....\$159.50

## Model TF-3 3-Way Speaker System

Bookshelf system; has 10" woofer, 2-3 1/2" midrange units, and spherical sec-



tor tweeter; crossovers at 2000 and 10,000 cps; power rating 25 watts; high frequency control on rear; impedance 8 ohms; 13 1/2" x 23 3/4" x 11 3/8"; 38 lbs.  
 TF-3 (unfinished).....\$ 94.25  
 TF-3 (oiled-walnut).....\$109.95

## Model KT-33 Components Kit

Complete with instructions for building enclosure and installing speakers; includes C12-NF 12" woofer, P8-UM 8" midrange,

RP-103B compression driver tweeter, hi-frequency control, crossover network; with cabinet-building directions.....\$90.00

## Model KTF-3 Speaker Kit

Includes a high-compliance woofer; two special midrange units; ultra tweeter; M.F./H.F. balance control; crossover network; enclosure vent tube: complete enclosure construction details.....\$67.00

## Model C12-NF "Flexair" Woofer

12" cone woofer; power rating 30 watts; frequency response in Jensen Bass-Super-



flex cabinet 20 to 2000 cps; Flexair suspension system; resonance 20 cps; impedance 16 ohms .....\$42.50

## Model G-600

Triaxial 15" 3-way speaker; 35 watts; response 30 cps to upper hearing limit;



16-ohm impedance; 3 1/2 lb. DP-Alnico-V magnet; 15" cone woofer; throbore compression-driver mid-channel unit with separate horn for 1000 to 4000 cps range; compression super-tweeter; tweeter and midrange controls; depth 11 1/8"; shipping weight 33 lbs.....\$157.50

## Model X-20 "Slim" Compact System

Includes one woofer and two tweeters; 6-watt rating; can be used with 4.8, or



16 ohm outputs; 12 7/8" h. x 15 3/8" w. x 2 3/8" d.; 11 1/2 lbs.; oiled-walnut finish.....\$49.50

## Model P6-TX

Six inch extended range speaker: 6 1/4" diameter, 3 9/16" deep, 5 1/4" baffle opening; 7.5 watts; 3.2 ohms; 3.16 oz. Alnico V magnet; voice coil diameter 3/4" .....\$6.00

## Model P8-QF "Flexair" Woofer

High-compliance 8" woofer; can be used with P35-VAH or RP-103B tweeter; cross-

over to 2000 cps; power rating 25 watts; 16 ohm impedance.....\$25.50

## Model P8-RL

8" woofer; 4" deep; 6 3/4" baffle cutout required; 20 watts; 50 to 3000 cps; 8-ohm impedance; 65 cps, viscous edge damped diaphragm .....\$9.75

## Model P8-RM Mid-Range

8" direct radiator mid-range; power rating 40 watts; uniform output from 200 to 4000 cps; cover provides acoustic isolation; 1/2 lb. DP-Alnico-V magnet; impedance 16 ohms; 5" deep .....\$13.60

## Model P8-UM Mid-Range

8" direct radiator mid-range power rating 30 watts; for 600 to 4000 cps range; cover provides acoustic isolation; 2 1/2 oz. DP-Alnico-V magnet; impedance 16 ohms; over-all depth of speaker 4 1/2" .....\$8.45

## Models P10SX, P12-SX

Extended range speakers; P10-SX is 10", 5 1/4" deep, 8 3/4" baffle opening required; Model P12-SX is 12", 6 1/16" deep, 10 1/2" baffle opening required; P10-SX is 12 watts, P12-SX is 13 watts; 8-ohms impedance; 4.64 oz. Alnico-V magnets in both models; 1" diameter voice coils.  
 P10-SX .....\$11.25  
 P12-SX .....\$12.00

## Model P12-RL

12" woofer; 6 1/16" deep, 10 1/2" diameter baffle cutout required; 20 watts; 40 to



2500 cps; 16-ohm impedance; resonance 60 cps. ....\$14.25

## Model P15-LF "Flexair" Woofer

15" cone woofer; power rating 40 watts; frequency response in Jensen Bass-Superflex cabinet 16 to 2000 cps; Flexair suspension system; resonance 16 cps; impedance 16 ohms .....\$79.50

## Model P35-VAH

Direct radiating cone type tweeter; 3 1/2" square x 2 1/8" deep, 3 1/8" diameter baffle



cutout required; 15 watts; response 2000 to 14,000 cps; 16-ohms.....\$4.00 Net

## Model G-610B

Triaxial 15" 3-way speaker; 40 watts; 16-ohm impedance; crossovers at 600 and 4000 cps; heavy duty curvilinear diaphragm unit for lows, compression driver unit for mid-range and compression driver for high end; baffle opening 13 1/4"; depth

10 1/4"; crossover and control networks .....\$296.50

**Model HF-100A**

Weatherproof coaxial speaker; low- and high-frequency units enclosed in projector

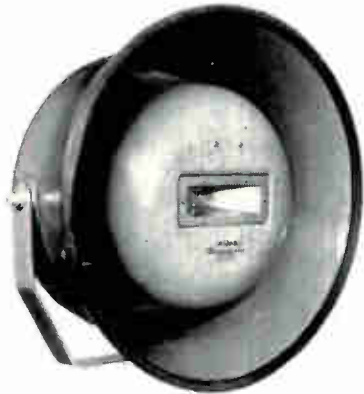

made of glass fibre with aluminum outer horn; 25 watts; 60 to 15,000 cps; 16-ohm impedance; 8" woofer and horn-loaded compression driver high-frequency unit; 2000 cps crossover; 2 3/8" diameter, 11 3/8" deep .....\$77.70

**Model RP-103B**

Compression type tweeter; cloth base plastic diaphragm; 30 watts; 2000 to 15,000



cps; 16-ohm impedance; shipping weight 3 lbs; 3" x 7 1/4" x 6 5/16"; baffle cutout 6" x 2". .....\$17.50

**Model RP-302A**

High frequency unit covering the range from 4000 cps to the highest audible frequencies; coverage angle 120°; impedance 16 ohms; for use with A-402 network; 40 watts power rating, 2 1/4 lbs. ....\$36.00

**Model E10 Ultra Tweeter**

Plastic dome radiator from 10,000 cps to beyond audibility; for use with 4-16 ohm speakers up to 30 w.; has built-in crossover; 16 ohms; 4 1/4" o.d., 2" deep.....\$21.50

**"Delta" Series Loudspeakers**

Model DL-220 3-element 12" coaxial design. Compression, omnidirectional h.f.



horn, midrange secondary modulator, low frequency resonance 25 cps. Response 25-16,000 cps; 8 ohms; 20 w. 5 1/16" deep.....\$34.75

Model DL-120 dual-cone, 12" speaker. Similar to DL-220 except without h.f. horn. Response 40-15,000 cps; 8 ohms; 20 w. ....\$21.50

1965 EDITION



# atten shun

In Britain,

the symbol of precision drill is the Royal Guards. Such precise accuracy and faultless skill can be found in every Leak High Fidelity instrument. In fact, many editors refer to Leak's construction as the "military assembly."

This is another reason why Leak products are universally used in professional applications—where durability and performance cannot be compromised.

If you are of the esoteric few, seeking the ultimate in quality components, may we post to you authentic TEST REPORTS on Leak equipment? Then, visit the listening salon of your nearest Leak Authorized Specialist . . . for in the final analysis, listening under "home conditions" is the indisputable test.

See the dramatic yet graceful exterior designs of Leak equipment . . . the new "deco-discs and deco-plates" for interior color coordination . . . features which won the coveted international medals of the Fashion Foundation of America and the British Council of Industrial Design. If you haven't as yet heard the revolutionary Leak "piston-action" Sandwich Speaker System . . . by all means do so now!

Though Leak equipment is first in quality it is reasonably priced!

Leak "Varislope II" Control Center	\$129.50
Leak "Stereo 30" Solid State Integrated Amp.	\$249.50
Leak "Stereo 60" Basic Amplifier	\$219.00
Leak "Stereo 20" Basic Amplifier	\$149.00
Leak "Trough Line 3" FM Tuner	\$149.00
Leak MKII Sandwich Speaker System	\$199.00

prices slightly higher west of the Mississippi



**LEAK**  
ENGINEERING | RESEARCH | MANUFACTURING



FASHION FOUNDATION OF AMERICA'S GOLD MEDAL FOR DISTINCTIVE STYLING.

Exclusive U.S. Representatives:

For TEST REPORTS and descriptive literature write Dept. D-3  
**ERCONA CORPORATION,**  
432 Park Ave. So., New York 16, N. Y.

CIRCLE NO. 69 ON READER SERVICE CARD

# 5 Speakers & Cabinets

**Model DL-80 dual-cone 8" speaker.** Response 50-15,000 cps; 8 ohms; 20 w.; 3 1/8" deep .....\$15.25

**Model SG-80 Dual-Cone 8" Speaker**  
Has Flexair woofer with concentrically mounted auxiliary cone for high end; re-



sponse 40-12,000 cps; 12 watt program capacity; 3 3/8" depth; 8 ohms.....\$19.75

**Model SG-84 8" Coax**  
Flexair woofer combined with electrically independent direct radiator tweeter provides



response 40-14,000 cps; has h.f. balance control; built-in crossover at 2000 cps; 12 watt program rating; 8 ohms; 3 3/8" depth .....\$29.50

**Model SG-88 8" Coax Speaker**  
Features low crossover compression driver horn-loaded tweeter in an 8" unit; electrical



crossover from high-compliance low-resonance Flexair woofer is 2000 cps; frequency range 35-15,000 cps; has h.f. balance control; 20 watts program capacity; 8 ohms. ....\$42.50

**Model TW-22 Tweeter**  
Response 2000 to 14,000 cps; use crossover frequency of 2000 to 4000 cps; 16



ohms; 3 1/2" cutout; to be used with 25-watt systems.....\$10.75

**Model A-61 600 cps Crossover**  
Two channel, 180° constant-resistance type with 12 db/octave attenuation; crossover point at 600 cps; 5 1/4"h.x7"w.x4 1/8"d.;

5 1/4 lbs.....\$24.50

**Model A-204 2000 cps Crossover**  
Two-channel type; high-pass section transmits everything over 2000 cps to tweeter, everything below to woofer; 180° constant-resistance type; 4 3/8"h.x3 1/2"w.x3 1/4"d.; 2 1/2 lbs.....\$14.40

**Model A-402 4000 cps Crossover**  
Two-channel type; high-pass transmits everything above 4000 cps to tweeter, everything below to woofer; 180° constant-resistance type; 4 3/8"h.x3 1/2"w.x3 1/4"d.; 3 lbs. ....\$13.95

**Model A-640 Crossover**  
Crossover unit for 3-way systems with crossovers at 600 and 4000 cps; power rating 40 watts; 12 db/octave slope; impedance 16 ohms; 5 1/4"x7"x4 3/8".....\$35.00

**Model ST-946 Balance Control**  
Provides attenuation of tweeter in systems with power ratings up to 30 watts; impedance 16 ohms.....\$4.00

**Model ST-947 Balance Control**  
Provides attenuation of tweeter and mid-range in systems with power ratings up to 40 watts; impedance 16 ohms.....\$5.50

**Model SG-210 3-Element 12" Coax**  
Two-way, 3-element system; Flexair woofer provides high compliance and low reso-



nance; has curvilinear-radiator separate tweeter & mechanically coupled mid-range radiator; electrical crossover at 2000 cps; h.f. control on cord for external mounting; frequency range 20-14,000 cps; 20 watts program capacity; 8 ohms.....\$43.50

**Model SG-220 3-Element 12" Coax**  
Features compression-driver horn-loaded super-tweeter in conjunction with mechan-



ically coupled mid-range radiator and Flexair high-compliance low resonance woofer; electrical crossover at 4000 cps; frequency range 20-15,000 cps; h.f. balance control; 20 watts program capacity; 8 ohms....\$52.00

**Model SG-222 Multicell Horn 12" Coax**  
Compression driver tweeter horn extends through woofer core and terminates in six-



cell mouth for wide angular dispersion of high frequencies; has low electrical and

acoustical crossover frequency of 2000 cps; h.f. level control; response 30-15,000 cps; 25 watts program capacity; 8 ohms....\$69.50

**Model SG-223 Reflex Horn 12" Coax**  
Two-way coaxial speaker with horn-loaded low-crossover tweeter and high-compliance



low-resonance Flexair woofer; electrical crossover to reflex horn tweeter 2000 cps; has h.f. control; response range 20-15,000 cps; 30 watts program capacity; 8 ohms. ....\$76.50

**SG-300 "Triaxial" Speaker**  
12" design with 3 independent speakers. SG-300 woofer (20 cps resonance), 6"

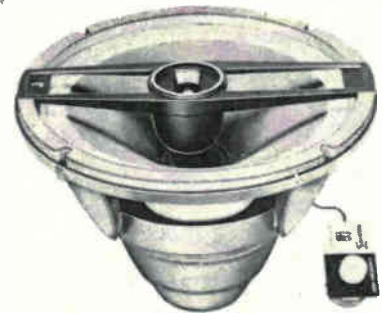

long midrange horn & tweeter. Has a balance control to either boost or attenuate high frequencies. Response 20-20,000 cps; crossovers 600 & 4000 cps; power capacity 40 w.; 8 ohms; 8 1/8" deep.....\$99.50

**Model X-11 Speaker System**  
Two-way system; has built-in hangers on back for easy wall mounting; bass response

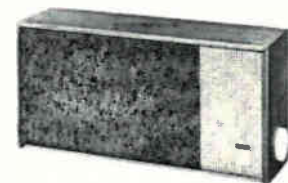

comes from special woofer with moving system matched to enclosure; 3" tweeter provides highs to 14,000 cps; high-efficiency design rated at 6 watt capacity; has volume control; walnut finish; impedance 4 to 16 ohms; 6 3/8" x 13 1/8" x 4".....\$34.50

**Model TF-4 Speaker System**  
Five-speaker, 4-way bookshelf design; response ranges from 25 cps to inaudibility;

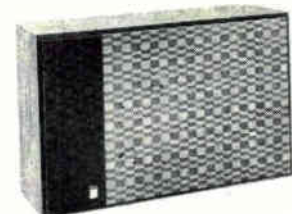

crossovers at 600, 4000, 9000 cps; has high-compliance Flexair woofer, 8" mid-range, two tweeter units, and "Sono-Dome" ultra-tweeter; high frequency control on back; 25 watts capacity; 8 ohms; 16" x 25 1/2" x 8 1/2"; choice of rattan or two-tone grille

fabrics; oiled walnut.....\$129.50  
 Model TF-4U Unfinished gum hardwood;  
 choice of rattan or two-tone grille fabrics  
 .....\$104.50

**Model RP-41 Mid-Range**

Compression-driver horn-loaded mid-range unit for 400 to 4000 cps range; power rating 40 watts with 400-600 cps crossover; impedance 16 ohms; 7¼" deep; baffle cutout 8½" diameter .....\$49.50

**KARLSON**

**Model X-15 Speaker System**

Features an internal curved paneling, a heavy-duty 15" speaker and a coaxially

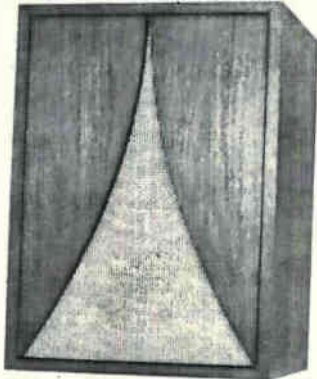

mounted tweeter. Response 12 cps to beyond audibility; dispersion 160° in the horizontal plane and 120° in elevation with axis tilted upward. Capacity 100 watts music power, 60 w. continuous at 400 cps. Will handle peak transients up to 150 watts. Efficiency 40%, can be used with any power amplifier. Design follows patented acoustic coupling with tapered opening. 27¾" x 19¾" x 14".

X-15 Oiled walnut.....\$249.50  
 X-15UB Unfinished birch.....\$234.95  
 X-15UT Utility charcoal gray.....\$224.50

**Model AP-9C Asymmetric Projector**

Flush mounting ceiling speaker which projects sound forward in very broad fan-like

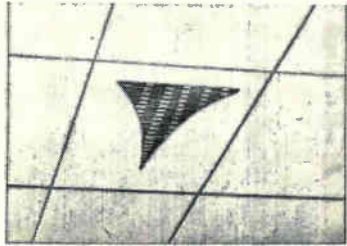

beam horizontally and narrow in the vertical plane with highs directed to most distant points. May also be mounted on a variety of surfaces with round face plate, commonly used with 12" speakers. For stereo use in home, office, auditoriums, and commercial applications. Response 50-15,000 cps, 12 w., dynamic range 100 db, 12 db feedback rejection in positions behind speakers. 8 ohms. 12" x 12" face plate, 6¼" deep. White satin finish .....\$29.50

**Model "12" Speaker Enclosures**

Same coupling and dispersion features as Model "15" but dynamic range of bass slightly reduced; fundamental loading extends to ⅓ speaker resonance instead of ½; response to 20 cps obtainable with high-compliance speakers; 24¾" x 16¾" x 13¾"; 44 lbs.; for 12" speakers; 10" with adapter.

Model 12WG Oiled walnut with full-grille front .....\$99.60

Model 12U Unfinished birch.....\$69.50  
 Model 12BSCU Unfinished particle board for built-in installations; without trim or feet .....\$49.50  
 Model 12K Birch kit.....\$49.50  
 Model 12BSCK Basic kit.....\$31.95

**Model "8" Speaker Enclosures**

Designed for use with 8" speakers. Characteristics similar to Model "12"; bass to 40 cps obtainable with good 8" speakers. 17¼" x 11¾" x 9½".

8-WG Walnut finish on birch, full grille .....\$37.50  
 8-U Unfinished birch.....\$29.95  
 8-K Birch kit.....\$21.95

**Model AP-W Asymmetric Projector**

Designed for wall mounting. Applicable to large auditoriums, lecture halls, etc. and for economical installations of commercial stereo and background music. Response 75-15,000 cps, 12 w. 140° dispersion in horizontal plane controlled in vertical as in Model AP-9C; 100 db dynamic range; 8 ohms. 15½" x 10½" x 8". Sand finish white, others on special order.....\$49.50

**Model "15" Speaker Cabinets**

Designed for use with all 15" speakers; less than 11" in depth and will extend bass to

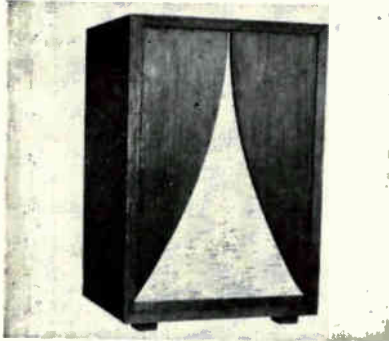

½ mechanical resonance of these speakers; improved high-frequency dispersion to 120°; 22½" x 33" x 18". Can also be used with 12" speakers and adapter.

15-WT Oiled walnut with tapered front .....\$229.00  
 15-WG Oiled walnut with full grille .....\$229.00  
 15-U Unfinished birch.....\$99.50  
 15-K Deluxe birch kit.....\$69.50  
 15-BSC-U Unfinished basic unit in high density particle board, no trim.....\$69.50  
 15-BSC-K Basic kit for above.....\$44.95

**KLH**

**Model Four Speaker System**

Full-range, two-way system housed in 13½"h. x 25"w. x 12"d. cabinet; low

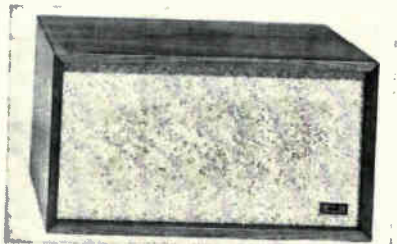

frequency speaker is 16-ohm 12" acoustic suspension type; two high-frequency speakers are 1¾" cone-type direct radiators; LCR crossover network is integral part of system; permits increase or decrease of 2.5 db in the levels above 1500 cps and above 6000 cps; provision is made to allow connection to high-and-low-frequency sections separately; 16 ohms im-

pedance; hardwood enclosures finished all four sides.

Unfinished fir .....\$209.00  
 Mahogany, unfinished birch.....\$224.00  
 Walnut, oiled walnut .....\$231.00

**Model Seven Speaker System**

Full-range, two-way system housed in 24¾"h. x 21½"w. x 11¾"d. cabinet;



low-frequency speaker is 12" acoustic suspension type; high-frequency section contains two 1¾" cone-type direct radiators; LCR crossover network is integral part of system and has provisions to increase or decrease high-frequency level 2½ db; impedance 8 ohms.

Unfinished birch.....\$189.00  
 Mahogany .....\$196.00  
 Walnut, oiled walnut.....\$203.00

**Model Nine Electrostatic**

Electrostatic speaker system that reproduces entire audio range; for adequate re-



production of very low frequencies total radiating area of 28 sq. ft. is used (14 sq. ft. in rear); radiation front and rear is equal; consists of two complete full-range speakers with built-in power supplies and step-up transformers; two sections can be joined or separated completely for use in stereo systems; impedance nominal 16 ohms and is primarily resistive in audio range; maximum 30 ohms, minimum 16 ohms; recommended amplifier power per section 40 to 75 watts; 70"x23½"x2¾" each panel; mahogany, walnut, oiled walnut...\$1140.00

**Model Seventeen**

Full-range, two-way system with 10" long-excursion acoustic suspension woofer and 1¾" direct-radiator tweeter with electrostatic suspension; LCR crossover network is integral part of system and permits an increase or decrease of 2½ db in high-frequency level without shelving in crossover region; grille cloth is removable to permit user to change as desired. 11¾" w. x 23¾" h. x 8¾" d.; finished all four sides; oiled walnut.....\$69.95

**Model Six Speaker System**

Full-range, two-way system housed in 23½" w. x 12½" h. x 11½" d. cabinet; low-frequency speaker is 12" acoustic suspension type; high-frequency section contains single direct radiator with 1¾" cone; LCR crossover network is integral part of system and has provisions to increase or decrease high-frequency level

# 5 Speakers & Cabinets

2½ db; impedance 8 ohms; cabinet similar in appearance to Model Four speaker system; hardwood enclosures finished all four sides.

- Unfinished fir .....\$119.00
- Unfinished birch .....\$124.00
- Mahogany .....\$129.00
- Walnut, oiled walnut, cherry .....\$134.00

## Model Fourteen S

Dual system using high-compliance, full-range direct radiators each having effective



diameter of 3"; a passive network reshapes power output of amplifier to match low-frequency power requirements of drivers; designed with 8 ohms impedance and for use with 12 to 30 watt amplifiers; 14" x 18" x 3¾"; oiled walnut enclosure of ducted-port design.....\$49.50

## Model Fourteen B

Full-range speaker system; identical to Model Fourteen S except for cabinet shape; 8" x 14" x 8¼" .....\$49.50

## KLIPSCH

### Klipschorn Corner Speaker System

Employs folded corner horn bass section, straight axis mid-range, and tweeter horns; response 32.7-21,000 cps; ideal for mono



or stereo especially when used with compatible third speaker bridged for center speaker use; over 30 acoustic watts output can be delivered; priced from \$514 for "Decorator's Model" in unfinished fir to \$852 for hand-rubbed systems. All models are functionally identical.

### Cornwall II 3-Way Speaker System

Exceptionally smooth response down to 30 cps; for use as primary speaker for stereo or as center speaker with Klipschorns in a 3-speaker array; enclosure-type bass with ported exhaust unloading at approximately 8 cps; diaphragm motion and distortion minimal above 16 cps; improved horn-type mid-range and tweeter afford accurate reproduction of transients;

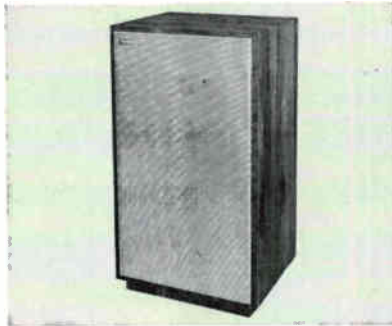

standard model uses same drive system as Klipschorn; also available with horizontal base for use as lowboy; finished on all four sides; priced from \$408 for finished fine furniture grade to \$311 for "Decorator's Model" in fir.

### Model H (Heresy) System

Total enclosure bass system with same mid-range and tweeter horns as Cornwall II; response 45-20,000 cps; diaphragm motion and FM distortion held to minimum;

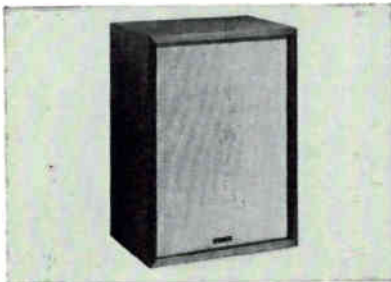

finished on all four sides; compatible with all other Klipsch models for stereo; priced from \$221 for full three-way system with network to \$188 in theater black.

## KNIGHT

### Model KN-612HC 3-Way High-Compliance Speaker

Woofer is 12" cone type; compression type tweeter; "whizzer" mid-range; built-



in electronic crossover; power capacity 50 watts; over-all response 35-20,000 cps.; woofer magnet 4.6 pound ceramic; 8 ohms. ....\$59.95

### Model KN-615HC 12" Speaker

Mechanical and electrical crossovers at 2000 and 3500 cps respectively; free-air resonance 20 cps; response 25-20,000 cps; impedance 16 ohms; rated power capacity 70 watts .....\$69.95

### KN-839 Full-Range 8" 3-Way Speaker

8" woofer, 3½" whizzer, and compression horn-type tweeter with level control; me-



chanical crossover 2000 cps, electrical crossover 4000 cps; response 45-18,000 cps; 8 ohms .....\$19.95

### KN-809A 2-Way 8" Speaker



Die-cast frame speaker with separate mid-range cone. Response 50-12,000 cps; 15 w. program capacity; 8 ohms.....\$8.95

### KN-830HC 3-Way 12" Speaker



High-compliance design; with mid-range cone & high freq. tweeter; woofer resonance 25 cps; response 25-18,000 cps; 8 ohms; 20 watts program capacity.....\$22.50

### KN-822HC 2-Way Speaker

High-compliance design with separate mid-



range cone. 25 cps resonance. Response 25-14,000 cps; 8 ohms; 20 w. program capacity .....\$12.95

### KN-888HC 3-Way 12" Speaker





**JBL PRESENTS THE  
SOLID STATE STEREO  
GRAPHIC CONTROLLER**

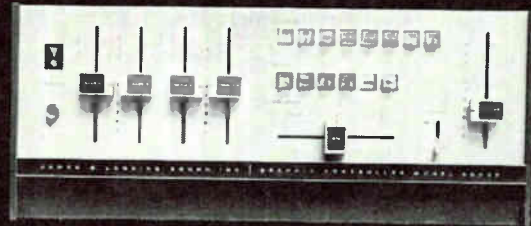
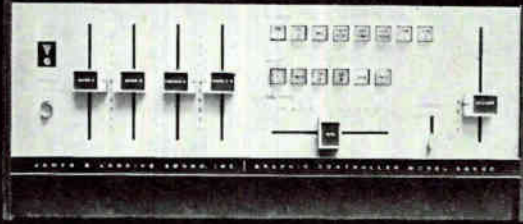

**A TOUR DE FORCE OF CREATIVE ENGINEERING**

Straightline controls. Pushbutton selectors. Inputs in front as well as back. Take a look and wonder...*Isn't this the way it should have been done in the first place?* The JBL design staff started fresh. Clean slate. No restrictions, prejudices or preconceptions. With cold objectivity they regarded the functions of a preamplifier/control center, re-evaluated its relationship to a human operator, weighed every conceivable feature. Straightline controls give immediate visual indication of setting. Even from a distance. Direction of movement seems intuitive. Up to increase, down to attenuate. Slide to one side or the other to balance channels. Pushbutton selectors permit instant comparison, switching from one source (top bank) or mode (lower bank) to another without passing through intermediate positions. Pushed button lights up. Controls are so arranged that those most frequently used are most accessible. Human engineering. Front-panel inputs permit sampling and comparing components, connection of portable units without disrupting permanent rear-chassis connections. Front jacks are behind a

flip-down door which also conceals occasionally used facilities such as a headphone jack, fuse, filters, system gain, level and balancing controls. The Graphic Controller includes a 1,000 cycle test tone generator to be used for speaker balancing, placement and orientation. An Aural Null Stereo Balancer accessory provides a very precise means for balancing speakers, and also the two signals from your stereo pickup. Performance-wise—in terms of response, distortion, hum—the JBL solid state Graphic Controller is the finest instrument of its kind you can buy. As has been said of other JBL products, "It's the result of doing everything right." In fact the Graphic Controller is so *right* in every respect, so well built, so well engineered that yours might very well become a family heirloom. There's much more to be said about the SG520. You'll find a complete description in Bulletin SL801-2. Write for your free copy and the name of the Authorized JBL Audio Specialist in your community.

The Graphic Controller is designed, engineered and manufactured by:



**JAMES B. LANSING SOUND, INC., LOS ANGELES 39, CALIFORNIA**

**CIRCLE NO. 36 ON READER SERVICE CARD**

## 5 Speakers & Cabinets

High-compliance design with separate mid-range cone & high freq. tweeter. 25 cps resonance freq. Response 20-19,000 cps; 25 w. program capacity; 8 ohms.....\$34.95

### KN-2281 Speaker System

High-compliance bookshelf design with 10" woofer & two 3 1/2" direct radiator tweeters with H.F. level control; 8 ohms; response 35-15,000 cps. 13" x 23" x 10". 3/4" oiled walnut finish with cane grille.....\$49.95

### KN-2300A Speaker System

Acoustic suspension design with 12" high-compliance woofer, a compression mid-

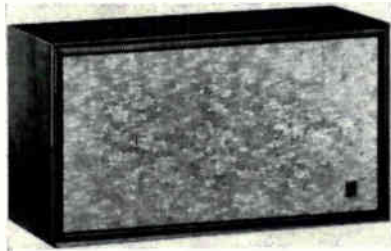

range horn & a dome-type tweeter with h.f. level control. Response 25-20,000 cps. Requires 10 w./ch. amplifier; 8 ohms impedance; 14" x 25" x 12".....\$79.95

### KN-2260K Speaker System Kit

Has 12" high-compliance woofer, 8" mid-range & a compression horn tweeter with pre-assembled electrical crossovers. Cabinet 17" x 25" x 8". Kit.....\$59.95  
Pre-assembled .....\$69.95

### KN-2350 Speaker System

Acoustic-suspension bookshelf design with 12" high-compliance woofer (15 cps free-air resonance), a dome-type mid-range with level control & a dome-type tweeter with its level control. Response 20-20,000 cps. 14 w./ch. amplifier required. 8 ohms impedance. 14" x 25" x 12".....\$99.95

## LAFAYETTE

### Model SK-58

12" coaxial speaker; power rating: 20 watts; frequency response: 30 to 15,000 cps; impedance: 8 ohms.....\$29.50 Net

### SK-128

8" Duaxial full range speaker; power rating 20 watts integrated program material; over-all frequency response 40 to 16,000 cps  $\pm 3$  db; resonance 45 to 65 cps; crossover 2500 cps; brilliance control; recommended enclosure bass reflex; impedance 8 ohms.....\$19.50

### 99-0022 Crossover Network

Crossover network for two-way and three-way systems; 8 or 16 ohms; crossover rate 6 db per octave; crossover frequencies for two-way systems are 2000, 3000, and 5000 cps; for three-way systems 350 and 2000-3000 cps; 350 and 5000 cps; 700 and 2000-3000 cps, 700 and 5000 cps; mid-frequency and treble level controls; metal cabinet; removable front panel for mounting level controls on front or side of speaker enclosure.....\$14.95

### 99-0053 Speaker Switch

7-position speaker selector switch; can switch up to 3 speakers in 7 combinations (1, 2, 3, 1-2, 2-3, 1-3, all); compensates for changes in impedances without need

for dummy load resistors; mounted on 2 3/4" x 4 1/2" electrical outlet plate; heavy duty silvered contacts and terminal board with screw terminals.....\$1.39

### Model CAB-19 Enclosure

Bass reflex design accommodates 2- and 3-way speaker systems; cut-outs for 15" and 8" speakers with adapter boards for 12" and 5" speakers; size: (less 7" legs) 23 1/2" w. x 28 3/8" h. x 16 3/4" d.; 3/4" birch; finishes: mahogany, blonde.

Net  
Assembled, finished (CAB-19) .....\$49.50  
Assembled, unfinished (CAB-13).....\$39.50  
Kit form (CK-10) .....\$29.50

### Model HK-3

Metal-cased 3" cone tweeter; power rating: 20 watts; frequency response: 2000 to 16,000 cps; impedance: 8-16 ohms; for use with crossover network, having crossover point of 2000 cps.....\$5.95 Net

### Model SK-253 Tweeter

Compression-type wide-angle radiator for high frequencies; frequency response 1500

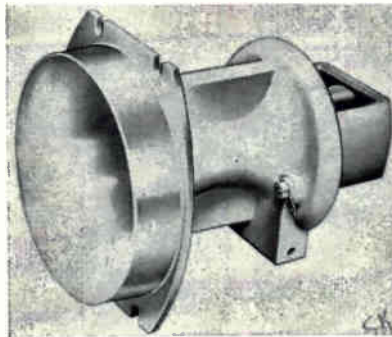

to 20,000 cps; recommended crossover 2500 cps; power rating 20 watts in 3-way system; voice coil impedance 8 ohms....\$9.95

### Model SK-180 "Trihelix" Speaker

10", 3-way speaker with 3 mechanically and electronically independent speakers mounted within single 10" frame; 2" tweeter; 5" mid-range; built-in electrical crossover at 1500 and 5000 cps; response 20-20,000 cps; 30-12,000 cps  $\pm 3$  db; free air resonance 35-55 cps; 8 ohms; 20 watts 99-0020W .....\$32.50

### Model SK-97 Coaxial Speaker

6 1/2" woofer; 2" tweeter; response 50 to 16,000 cps; woofer resonance 70 cps; impedance 8 ohms; power rating 8-10 watts; screw-type terminals; requires 5 1/2" diameter cut-out .....\$6.95

### Model SK-98 Two-Way Speaker

Dual-cone 8" speaker; response 40 to 16,000 cps; sensitivity 99.5 db/watt; resonance 55-70 cps; impedance 8 ohms; screw-type terminals; requires 6 3/4" diameter cut-out .....\$9.95

### "Slenderette II" Speaker System

Three-speaker, 3-way system; has 8" high-compliance woofer, a 6" mid-range driver, and a 3" tweeter; crossover 400 & 2000 cps; response 50-15,000 cps; 18 watts continuous sine-wave capacity; supplied in walnut finish, all four sides, and with wall mtg. bracket; 21 1/4" x 14 1/4" x 4 1/2" d. ....\$29.95

### SK-216W Speaker

12" 3-way design made in England; woofer, midrange radiator, and tweeter are axially mounted; 20-20,000 cps; 5 lb. ceramic magnet; 3" voice-coil; has 2000 cps mechanical crossover and 5000 cps electrical crossover; free air resonance



35 cps; 16 ohms; with brilliance control .....\$54.50

### Model "Eliptoflex" Speaker System

Bookshelf design enclosure with Model SK-210W 3-way speaker; cabinet finished all four sides; 14" h. x 23 3/8" w. x 13 1/16" d.; available in mahogany, walnut, blonde

.....\$64.50  
Unfinished birch .....\$59.50  
Same cabinet with Model SK-180 10" Trihelix speaker .....\$66.50  
Cabinet only .....\$36.50

### "Slenderette III" Speaker System

Dual speaker, 2-way system; has 6 1/2" high-compliance woofer and a 2 1/2" cone tweeter with crossover network; freq. response 50-10,000 cps; 8 ohms; 12" x 18" x 5 1/4" d.; walnut finish on all four sides .....\$19.50

### SK-130 8" Wide-Range Speaker

Response 40-18,000 cps; 15 watts; free-air resonance 55 cps; 1" voice-coil; 16 ohms; made in England; 4" deep .....\$12.95

### Model SK-215 15" 3-Way Speaker

Built in England; has 6 lb. ceramic magnet; free-edge cone suspension; 3" main

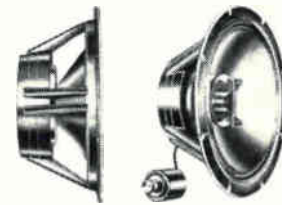

voice coil; 12 db/octave crossover network with high-frequency level control; horn-loaded tweeter; free-air resonance 25 cps; response 20-20,000 cps; crossover 200 & 5000 cps; 50 watt capacity; 16 ohms; depth 6 1/2" .....\$64.50

### Model SK-216 12" 3-Way Speaker

Identical to SK-215 speaker except 12" dia.; free-air resonance 35 cps; depth 5 1/2" .....\$54.50

### "Decorette II" Speaker System

Five-speaker, 3-way slim design; 2-8" woofers, 6" open back mid-range (500-



7500 cps) driver, dome lens compression horn tweeter (1000-10,000 cps) and 3 1/2" cone-type tweeter (5000-35,000 cps); response 40-20,000 cps; 30 watts continuous power capacity; 8 ohms; 25" h. x 17" l. x 4 3/4" w.; walnut finish and with four 1" dia. legs.....\$59.95

**"Mini-Duct" Speaker System**

Ducted port bookshelf enclosure with Model SK-128 8" Biaxial speaker; cabinet finished on all four sides; 23" w. x 11 1/2" h. x 1 1/8" d.; available in walnut, ma-



hogany .....\$39.50  
 Unfinished birch .....\$37.50  
 Cabinet only; reducing boards are supplied so that cabinet will accept 8" woofer, a 6" midrange, and variety of tweeters .....\$24.95  
 Cabinet only (unfinished birch).....\$21.50  
 Cabinet supplied with SK-98 8" wide-range speaker .....\$34.25

**Model SK-210W "Sovereign 12" Speaker**

12" 3-way system; made in England; 2 1/4" lb. ceramic magnet; compression-driver



tweeter; free-air resonance 35 cps; response 30-20,000 cps; 30 watts; 3" aluminum voice-coil; 16 ohms; woofer, mid-range radiator, tweeter axially mounted; has high-frequency L-pad level control, .....\$42.50

**"Decorette III" Speaker System**

3-way design; 12" polyfoam woofer (35 cps resonance), 6" closed-back midrange,



3 1/2" sealed cone-type super tweeter. Bass reflex enclosure with tube-type duct. Response 30-30,000 cps; crossover 5000 cps; 25 w. power capacity; 8 ohms. Has 3/4" wood; woofer covers up to 2000 cps & midrange 2000-5000 cps. 14" x 24" x 12" d. Oiled walnut.....\$79.95

**"Decorette V" Speaker System**

5-speaker system; four 6 1/2" low-resonance speakers & one 2 1/2" cone-type tweeter. Response 50-18,000 cps; 15 w. continuous power capacity; 8 ohms; supplied in walnut cabinet with removable legs. 17 3/4" w. x 21 3/4" h. x 4 1/4" .....\$39.95

**LAHTI**

**U-2 Speaker System**

Fully enclosed system with 8" woofer, 3" cone tweeter & capacitive crossover at 3000 cps. Patented design has woofer front-loaded by an inverted exponential horn terminating in a 2 3/4" dia. sharp-edged radiating opening. Response 95-15,000 cps

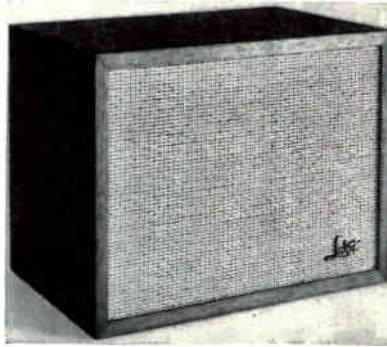

±5db. 9 1/4" h. x 11 3/4" w. x 7 3/4" d.  
 Oiled walnut finish.....\$39.95  
 Unfinished chipboard.....\$29.95

**U-33 Speaker System**

Utilizes patented pressure-velocity principle (same as U-2); 10" woofer, 8" mid-range, two 3" tweeters with mechanical and etched RLC crossover network; 8 ohms; response 60-14,000 cps ±6 db in anechoic environment 180° solid angle. 11 3/4" x 17 1/4" x 7 3/4" d.  
 Oiled walnut finish.....\$89.95  
 Unfinished chipboard.....\$74.95

**JAMES B. LANSING**

**Model C-36 Speaker Enclosure**

Bass-reflex design; will accept any 8", 12", or 15" speaker; available in mahog-



any, Korina, tawny walnut, oiled walnut, ebony; 28 3/4" x 19 3/8" x 15 7/8" deep, with 5" legs.....\$93.00  
 Model D36002 (D123, 075, N2600 installed) .....\$261.00  
 Model D36123 (D123 installed).....\$171.00  
 Model D36LE8T (LE8T installed) \$165.00

**Model 130A 15" Woofer**

15" low frequency driver; power rating: 25 watts; free cone resonance: 29 cps; response 30-2000 cps; impedance: 16 ohms; designed as low frequency unit in conjunction with 175DLH driver and Model N1200 dividing network for systems crossing over at 1200 cps; depth 5 3/8".....\$96.00

**N400, N600, N1200 Crossover**

A three position switch adjusts intensity of high-frequency transducer in 3 db steps; rate of attenuation around crossover, 12 db per octave; input and output impedance, 16 ohms; crossover frequency: N400,



500 cps; N600, 600 cps; N1200, 1200 cps.  
 N400 .....\$84.00  
 N600 .....\$60.00  
 N1200 .....\$42.00

**LX2 Crossover Network**

Matches LE20 tweeter to a variety of extended-range speakers, such as the D216 or D123 Continuously variable high-frequency attenuation. Can be used with speakers rated 8 to 16 ohms impedance.....\$18.00

**"Lancer 77" Speaker System**

Similar to "Lancer 33" except slightly larger with 2-way speaker system installed. Ten-inch low-frequency driver plus 2" piston tweeter with crossover. Adjustable high-frequency intensity. 14" x 23 1/2" x 11 1/4" .....\$147.00

**Model C52 "Opus" Enclosure**

May be placed in either vertical or horizontal position; available with LE14C



and other systems; 28" x 14" x 14 1/4"; available in tawny walnut, oiled walnut, mahogany, Danish teak, ebony; cabinet only .....\$126.00

**Model "Olympus" Speaker System**

Combines Model LE15A low-frequency driver, Model LX5 dividing network;

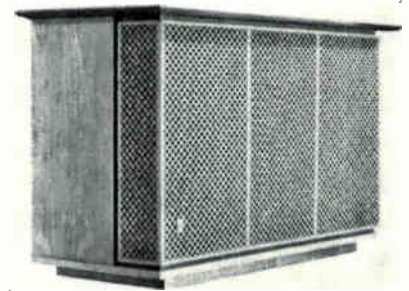

500 cps crossover; and Model LE85 high-frequency driver; enclosure alone weighs 100 lbs: available with any of five different grille fabrics or with wooden fretwork grille, hand-carved in Orient; wood finishes—dark mahogany, tawny walnut, oiled walnut, Danish teak, or ebony; size 19 3/4" x 40" x 27 1/4"; (cloth grille). Enclosure only .....\$198.00  
 Enclosure with Oriental hand-carved wooden grille.....\$258.00  
 Enclosure with wooden grille and S7 system .....\$645.00

**Model D216 8" Speaker**

8" loudspeaker with 2" edgewound and dural center dome; cone resonance 50 cps; power rating 12 watts; 16 ohms; (8 ohms available: model D208); depth 2 7/8" .....\$36.00

**Model LE10A L.F. Speaker**

Generates powerful bass in enclosures as small as 1 cu. ft.; edge wound copper ribbon voice coil; resonance 15 cps; capacity 30 watts; impedance 16 ohms.....\$57.00

**Model LE30 Tweeter**

Assembly to complement LE10A; for use with LX3-1 network; impedance 16 ohms; capacity 30 watts .....\$57.00

**Model LE14C Integrated System**

Covers entire audible spectrum; may be used in enclosures as small as 1.7 cu. ft.;

# 5 Speakers & Cabinets

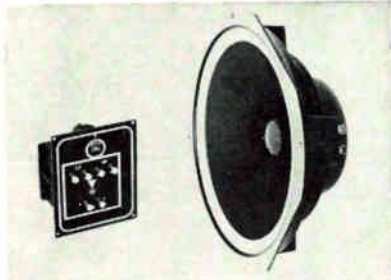

system impedance 16 ohms; crossover frequency 1200 cps; power capacity 30 watts with network .....\$150.00

### Model LE20 Tweeter

May be used with most JBL transducers; minimum crossover frequency when used



with LX2 network 1500 cps; impedance 8-16 ohms; diameter 4<sup>3</sup>/<sub>16</sub>" .....\$33.00

### Model LE8T 8" Full-Range Speaker

Full-range 8" transducer; acoustically treated cone to extend high-frequency re-



sponse; designed for use in small enclosures of minimum dimensions; frame is cast aluminum, non-resonant; front or rear mounting; "Lans-a-Loy" suspension permits long linear cone excursions for maximum low-frequency response; response 30-20,000 cps; power capacity 20 watts; resonance 37 cps; impedance 16 ohms; depth 4<sup>3</sup>/<sub>8</sub>" .....\$66.00

### S5 System

Consists of LE10A 10" low-frequency driver, the LE30 wide band high-frequency

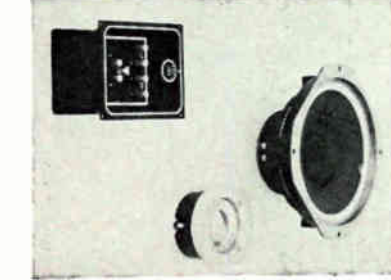

driver, and matching LX3 network; designed for use in small sealed enclosures or infinite baffle installations; free air cone resonance of LE10A, 15 cps; upper fre-

quency limit of LE30, beyond audibility.  
LE10A .....\$57.00  
LE30 .....\$57.00  
LX3 .....\$21.00

### Model C43

Rear-loading horn for professional and built-in use; will house 15-inch extended



range loudspeakers and two-way systems; in rough theater black only; 48" h. x 24" w. x 24" d. ....\$102.00

### Model 537-509 Horn-Lens Assembly

Horn-lens assembly for use with 375 high-frequency driver; provides wide horizontal

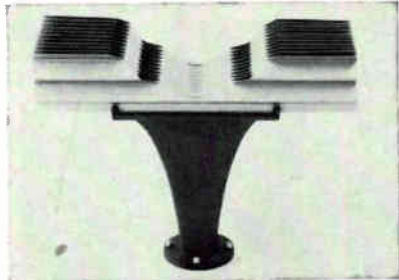

and narrow vertical diffusion; over-all length 16<sup>1</sup>/<sub>2</sub>" .....\$99.00

### Model 375 High-Frequency Driver

High-frequency driver; power rating 60 watts above 300 cps; impedance 16 ohms; diameter 7"; depth 5<sup>3</sup>/<sub>8</sub>" .....\$228.00

### Model 175-DLH

Driver-horn lens assembly; power rating: 25 watts above 1200 cps; impedance: 16 ohms; combination driver-horn incorporating an acoustic lens for distributing

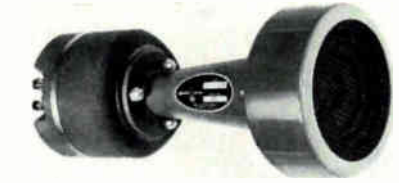

sound over a 90 degree solid angle; designed for use with N1200; baffle hole 5<sup>3</sup>/<sub>8</sub>"; over-all length 11<sup>1</sup>/<sub>2</sub>" .....\$129.00

### Model N-7000 Crossover Network

Dividing network; crossover 7000 cps; nominal impedance 16 ohms; 12 db/octave; variable attenuation control; dimensions: 3<sup>1</sup>/<sub>4</sub>" x 3<sup>1</sup>/<sub>4</sub>" x 2<sup>3</sup>/<sub>4</sub>" .....\$27.00

### Model O75 Tweeter

High-frequency speaker; power rating: 20 watts above 2500 cps; impedance: 16 ohms; high-frequency driver of "Annular Ring" design for re-inforcing the performance of extended range speakers from 2500

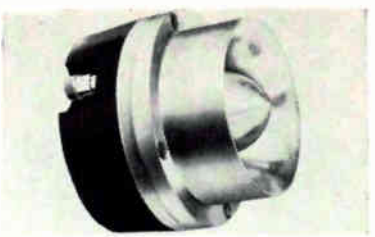

cps; used in conjunction with Model N2400, N2600 dividing network; baffle hole 3<sup>3</sup>/<sub>16</sub>"; over-all length 3<sup>1</sup>/<sub>4</sub>" .....\$63.00

### Model N-2600 Crossover Network

Dual-impedance crossover providing 2500-cps crossover with input impedance of 16 ohms and output impedances to woofer and tweeter of 16 or 32 ohms; 12 db/octave slope; tweeter level control: 4<sup>3</sup>/<sub>4</sub>" x 6" x 3<sup>1</sup>/<sub>2</sub>" .....\$27.00  
Model N2400 (same as N2600 but without dual impedance feature) .....\$24.00

### Model C51 "Apollo" Enclosure

Designed to accept variety of JBL extended-range speakers and two-way speaker



systems; available in mahogany, tawny walnut, oiled walnut, Danish teak, ebony; 23<sup>3</sup>/<sub>8</sub>" x 26<sup>1</sup>/<sub>2</sub>" x 18"; with fretwork grille .....\$225.00  
With cloth grille .....\$174.00

### Model C53 Enclosure

Available with LE8T, LE14C, or S5 speaker systems installed; available in

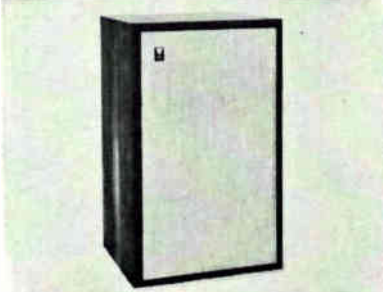

tawny walnut, oiled walnut, ebony; 14" x 23<sup>3</sup>/<sub>4</sub>" x 11<sup>3</sup>/<sub>4</sub>" .....\$48.00  
With LE14C installed .....\$198.00

### Model C54 "Trimline" Enclosure

Combines an 8" extended-range cone speaker (LE8T) with an 8" passive low-frequency radiator; 25 watt capacity; 16 ohms impedance; finished all four sides;



may be used free-standing or hung on wall; 23 3/4" x 20" x 5 1/8" deep; less legs .....\$117.00

### Model C-35 Enclosure

Bass reflex enclosure; designed for 12" and 15" speakers and two-way systems; 38 1/2"

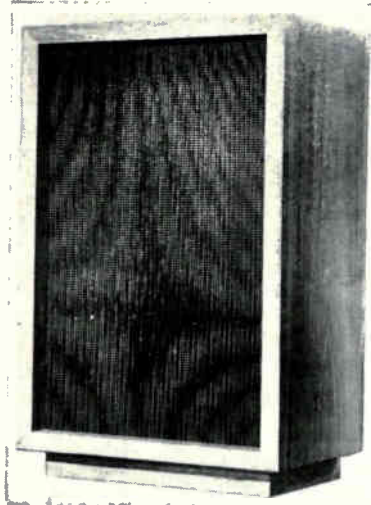

h. x 16" d. x 23 3/8" w.....\$150.00  
 Model D35001 (Model C-35 enclosure with 130A woofer, 175DLH horn-driver, N1200 crossover) .....\$417.00  
 Model D35002 (Model C-35 enclosure with D123 12" speaker, 075 tweeter, N2600 crossover) .....\$318.00  
 Model D35030 (Model C-35 enclosure with D130 15" speaker, 075 tweeter, N2600 crossover) .....\$348.00

### Model 150-4C 15" Woofer

Response 30-1000 cps; 30 watts; 27 cps resonance; for use in folded-horn enclosures with a 500 cps network; features 4" edge wound voice coil; depth 6 1/16"; 16 ohms impedance .....\$138.00

### Model C-38 Speaker Enclosure

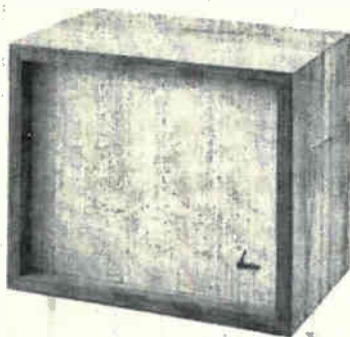

Lowboy version of Model C-36; 24 3/8" x 23 3/4" x 15 7/8" .....\$93.00  
 Prices and speaker combinations same as Model C-36.

### Model D44000 "Paragon" Speaker System

Enclosure has convex refractor panel; contains 2 full-range speaker systems, each consisting of LE15A, 375, 075; 35 1/4" x 103 3/8" x 24" .....\$2250.00

### Model D30085 "Hartsfield"

Horn-load system with acoustic lens; front-loaded folded corner horn driven by 150-4C bass driver; frequencies above 500 cps reproduced by 375 driver with cast

exponential horn and serpentine acoustic lens .....\$993.00

### Model C-37 Enclosure

Lowboy version of Model C-35; 28 7/8" x 36" x 16" .....\$156.00  
 Model D37001 (130A, 175DLH, N1200 installed) .....\$423.00  
 Model D37030 (D130, 075, N2600 installed) .....\$354.00  
 Model D37002 (D123, 075, N2600 installed) .....\$324.00  
 Model D37130 (D130 installed).....\$264.00

### Model C-34 Enclosure

Rear-loaded corner console horn; accommodates 15" speaker or two-way system; size 30 3/4" h. x 22 1/4" d. x 23 3/4" w.; wide variety of woods and finishes; 6-foot exponential folded horn; corner placement not required; designed primarily for two-way speaker system use.....\$201.00

### Model D45202 "Metregon" System

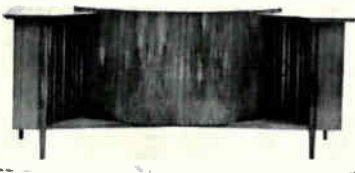

Stereo system consisting of D123's, 075's, N2400's; 30" x 74" x 22 1/2" .....\$933.00  
 Model D45203 (D130's).....\$804.00  
 Model D45205 (130A's, 275's, N600's) .....\$1248.00

### Model C-34 Speaker System

Rear-loaded exponential horn for use with extended-range 15" loudspeakers and 2-way systems.

Model D34001 (130A, 175DLH, N1200 installed) .....\$468.00  
 Model D34030 (D130, 075, N2600 installed) .....\$399.00

### Model D-123 12" Speaker

Single cone wide-range 12" loudspeaker; power rating: 20 watts; free cone reso-



nance: 35 cps; impedance: 16 ohms; features 3" aluminum voice coil and dural center dome to stiffen piston assembly; shallow curvilinear cone aids dispersion of highs; depth 3 3/8" .....\$72.00

### SE402 Solid-State Energizer

Transistorized device which takes the place of conventional stereo power amplifier; en-



energizer is supplied with plug-in equalizer board which precisely controls response characteristics and damping factor for best possible performance in conjunction with a particular JBL loudspeaker system & enclosure; individual equalizer boards are available to match each JBL speaker/enclosure combination; energizer is non-microphonic and generates negligible heat so it can be installed directly in one of the

stereo speaker enclosures; resulting integrated combination becomes an energizer/transducer; available as an integral component of JBL energizer/transducers or as a separate unit for installation in existing JBL speaker systems; with matching circuit board for any pair of JBL speaker systems. ....\$216.00

### Model "Lancer 33" Speaker System

Bookshelf-type, ducted-port design; Type LE8T full-range speaker; response below



35 cps to over 15,000 cps; power handling capacity 6 watts minimum; 12 3/4" x 23 1/4" x 11 3/4" .....\$93.00

### Model D-130 15" Speaker

Single cone extended range 15" speaker; power rating: 25 watts; free cone reso-



nance: 37 cps; impedance: 16 ohms; 4" aluminum voice coil and 4" dural center dome; shallow curvilinear cone for dispersion of highs; depth 5 1/2" .....\$102.00

### Model D-131 12" Speaker

Single cone wide-range 12" loudspeaker; 16 ohms; 4" aluminum voice coil and dural center dome; shallow curvilinear cone for dispersion of highs.....\$96.00

### Model C-40 "Harkness"

Lowboy version of Model C-34.....\$201.00  
 Model D40001 (130A, 175DLH, N1200 installed) .....\$468.00  
 Model D40030 (D130, 075, N2600 installed) .....\$399.00

## LEAK

### "Sandwich" Speaker System

Completely sealed, air-tight enclosure with dual high-efficiency speakers (1 l.f. & 1 h.f.); response 30-18,500 cps ±2.5 db; 50 watts continuous power capacity; 15 ohms impedance; free-air resonance 19 cps; crossover 800 cps; both speakers have special polyfoam cone with thin aluminum "sandwich" skins for added strength and reduced breakup distortion; 15" x 26" x 12" d.; choice of Scandinavian woods .....\$199.00

## LEONHARDT

### Model LH-500 "Concert Master"

Basic cylindrical shape with wood trim provides full 180-degree sound dispersion; response 25-20,000 cps; 8 ohms. Power handling capacity is 20 watts average program material (45 watts peak). Speaker is fused for protection against accidental overloads. 37" h. x 16" w. x 12" .....\$159.95

# 5 Speakers & Cabinets

## Model LH-190 "Stereo Sound Stage"

Cylinder design with full 180-degree sound dispersion; response 35-18,000 cps; 8 ohms; fused. Power handling capacity 15 w. average program material (35 w. peaks); 10" dia., 24½" high. Cane, classic contemporary, white finishes, all with brass trim, .....\$85.00  
Also available: chain hanger kit for suspending speaker from the ceiling .....\$12.50



## Model LH-101 "Micro-Sonic"

Curved design with matching wall brackets allows wall or corner mounting at any angle. Response 45-16,000 cps; 8 ohms; Power handling capacity is 12 watts average program material (25 watts peak). Fused for protection against accidental overloads. 12½" h. x 8" w. x 6". Finishes arc cane, classic.....\$34.95  
With built-in volume control .....\$39.50



## MARCOR

### Model 415 Speaker System

Combines a soft suspension (32 oz. magnet) woofer, a special 3" tweeter with "acoustic mirror" (a reflecting device for greater h.f. sound dispersion); response 35-17,500 cps; horizontal dispersion ± 2 db across 140° @ 8000 cps, ± 3 db across 130° @ 10,000 cps; crossover at 1500 cps; 8 ohms; fuse protected; 11¼" x 11¼" x 23¾"; available in walnut or cherry...\$88.50  
Mahogany .....\$84.50

## MINNEAPOLIS

### F-69-HFD Dual-Cone Speaker

6" x 9" high-compliance oval speaker; fits most cut-outs in automobile rear decks; response 50-17,000 cps; power handling ability 10 watts program material; impedance 3.2 to 10 ohms.....\$11.25  
Also available as rear-seat kit with grille, mounting hardware, and fader control with wiring harness.....\$14.25

### Model K-120 12" Speaker

12" coaxial construction; response 30 cps to beyond audibility; impedance 8 ohms; power handling ability 15 w. program, 30 w. peak.....\$31.50

### MMS-8-F "Music Mini" 8" Speaker

Designed for indoor and outdoor applications; impedance 8 ohms; power handling 8 watts; has knock-out plug for mounting volume control on top or bottom and for universal transformer mounting.....\$19.95

### K-12-HFD 12" Dual-Cone Speaker

8 ohms impedance; 15 watt program material; response 30-13,000 cps; free air resonance 35 cps.....\$21.00

### Model K-12-HFW 12" Woofer

Ideal for use with Model D-40HFT tweeter as two-way system or Model D-4-HFT tweeter and Model F-8-HF midrange as

three-way system; 8 ohm impedance; 15 watt program material; response 30-4000 cps; free-air resonance 35 cps.....\$19.50

### Model F-8-HFD 8" Dual-Cone Speaker

Inner cone has mechanical crossover at 8000 cps; 8 ohms impedance; 10 watt program material; response 40-17,000 cps; free-air resonance 50 cps.....\$12.00

### Model F-8-HF 8" Wide-Range Speaker

Impedance 8 ohms; 10 watt program material; response 40-13,000 cps; free-air resonance 50 cps.....\$10.80

### Model D-4-HFT 4" Tweeter

Impedance 8 ohms; 15 watt program material; response 2000 cps to beyond audibility .....\$6.75

## MURRAY-TONE

### Model "CG" Speaker System

A cavity-generated spherical sound system design; has solid wood panel in front permitting 360° sound dispersion; response 30-17,000 cps; 8 w. program material capacity; 8 ohms; available in maple, limed oak, or walnut .....\$29.95

## OLSON ELECTRONICS

### Model S-541 12" Woofer

Slim-line design; 20 watt capacity; response 30-3500 cps; 8 ohms.....\$13.95;  
2 for \$26.50

### S-548 (Castle Bell) 8" Speaker

Features double-wound voice coil; flexedge cone plus exponential high-frequency whizzer; full-range sound; response 30-15,000 cps; 12 watt capacity; 8 ohms.....\$5.98

### Model S-599 Horn Tweeter

Enclosed in metal housing; can be mounted to front of cabinet or on attached stand;



requires 3" mounting hole; response to 15,000 cps; 8 ohms; 4" x 3½".....\$3.49;  
2 for \$6.00

### Model S-496 Coaxial Speaker

6½" design. Response 50-16,000 cps. Features 2" shielded tweeter and LC-type crossover network; capacity 10 watts; 8 ohms .....\$6.85

### Model S-570 Speaker System

Response 50-18,000 cps; oiled-walnut cabinet; high-compliance 8" woofer and special horn-loaded compression driver tweeter; built-in crossover; 10" h. x 18" w. x 6¼"; capacity 15 watts; 8 ohms.....\$37.88

### Model S-573 Speaker System

12" 3-way system; response 35-16,000 cps; has horn tweeter and whizzer cone mid-range; crossover at 2000 & 3500 cps; tweeter has level control; capacity 20 watts (40 watts peak); 8 ohms.....\$29.98

## PACO

### L-3 Bookshelf Speaker System

Has two high-efficiency speakers; supplied

in semi-kit form; cabinet is built and finished in walnut; 13¾" x 7¼" x 6¼" .....\$19.95

## L-4 Speaker System

Has three 6" woofer/mid-range speakers & tweeter; woofers are special designs having 3 struts bonded to front of cone to eliminate edge distortion; they have ball diffusers bonded to front of voice coil for better sound dispersion; cone resonance 40 cps; response 45-18,000 cps; 8 ohms impedance; 6½" d. x 20" x 26¾"; walnut.....\$99.95

## PILOT

### SA-1 Speaker System

3-way system, 8" woofer, rolls off at 2000 cps; 3" mid-range from 2000-10,000 cps & a 3½" super tweeter re-inforces mid-range & extends to 20,000 cps. Response 50-20,000 cps; 8 ohms; crossovers 2000 & 4000 cps; 30 w. power capacity. Has high-freq. attenuator; 11½" h. x 18" w. x 9". Oiled walnut.....\$69.50

### SA-2 Speaker System

3-way system, 12" woofer, 3½" mid-range & 3½" super tweeter. Both 3½" speakers self-enclosed. Response 50-20,000 cps; 8 ohms; 37½ w. power capacity; crossovers at 2000 & 4000 cps. Has high-freq. attenuator; 15½" h. x 22" w. x 10½". Oiled walnut .....\$99.50

### SA-3 Speaker System

3-way system, 12" Air-Flex heavy-duty woofer, 2 self-baffled 3½" mid-range & two 3½" super tweeters. Response 40-20,000 cps; 8 ohms; 62½ w. power rating; crossover at 2000 & 4000 cps. Has individual balance controls for mid-range & tweeters. 15" h. x 25¾" w. x 12". Oiled walnut .....\$129.50

### SL-1 Speaker System

Slim, 3-way design, 10" woofer, two 3½" mid-range & two 3½" super tweeters. Response 50-20,000 cps; 8 ohms; 25 w. power capacity; crossover at 2000 & 4000 cps. Has high-freq. attenuator. 24" h. x 17" w. x 6¼". Oiled walnut.....\$89.50

### SA-4 Speaker System

3-way design, two 5" woofers, 3½" mid-range & 3½" super tweeter. Response 70-20,000 cps; 8 ohms; 15 w. power capacity; crossover 2000 & 4000 cps. 12½" h. x 15½" w. x 5". Oiled walnut.....\$49.50

## QUAM-NICHOLS

### Model 6A21X Speaker

6½" dual-cone, extended-range speaker; capacity 5 watts; response 75-15,000 cps ± 5 db; 8-ohms; depth 2¾".....\$8.95 List

### Model 69C6X Speaker

6" x 9" dual-cone, extended-range speaker; capacity 12 watts; frequency response 50-15,000 cps ± 5 db; 8-ohms. Baffle opening 5¾" x 8½" x 3" deep.....\$13.95 List

### Model 8A4CO 8" Coaxial

Dual-cone type speaker with built-in crossover network; 50-50,000 cps ± 5 db; 10 watt rating; resonance 70 cps; 4½" deep .....\$22.95

### Model 10C12X Speaker

10" dual-cone, extended range speaker; capacity 15 watts; response 40-15,000 cps ± 5 db; 8-ohms; depth 3¾".....\$24.00 List

### Model 8C12X Speaker

8" extended-range design; 15 w. capacity; 50-14,000 cps ± 5 db; 3¾" deep.....\$20.00

### Model 12C12X Speaker

12" dual-cone, extended-range speaker; capacity 18 watts; response 30-16,000 cps  $\pm$  5 db; 8-ohms; depth 4 1/2".....\$26.00 List

### Model 12A6CO 12" Coaxial

Dual-cone type speaker with built-in crossover network; 50-15,000 cps  $\pm$  5 db; 14 watt rating; resonance 65 cps; 6 1/16" deep .....\$34.50

### Model 15C12CO 15" Coaxial

Dual-cone type speaker with built-in crossover network; 25-18,000 cps  $\pm$  5 db; 25 watt rating; resonance 50 cps; 7 3/4" deep .....\$52.50

## REALISTIC

### "Solo-I" Speaker System

2-way speaker system with 8" woofer and coaxially mounted "whizzer"; frequency response 50-14,000 cps; 14 1/2" x 11" x 10 1/2"; shpg. wt. 12 lbs.; mahogany..\$19.95 Oiled-walnut .....\$19.95

### "Solo-II" Speaker System

Consists of specially designed 8" speaker; frequency response 40-16,000 cps; 8 ohms; 20" x 11" x 10"; mahogany or oiled walnut .....\$29.95

### "Electrostat-4A" Speaker System

Has 4 electrostatic elements plus mid-range cone speaker, woofer, crossover network, balancing controls; frequency response 30-25,000 cps; 8 ohms impedance; cabinet is 27" x 13 3/4" x 12 1/2"; 43 lbs. Mahogany or oiled-walnut .....\$79.95

### "Solo-3" Speaker System

Consists of specially designed 8" speaker; response 40-16,000 cps; 8 ohms impedance; 20" x 11" x 10"; mahogany or oiled-walnut .....\$39.95

### "Electrostat-2" Speaker System

Features four-element electrostatic tweeter with built-in crossover and attenuator; response 45-25,000 cps; high-compliance 8" woofer; 120 degrees dispersion; 22 1/2" x 13" x 12 1/2"; oiled walnut or mahogany .....\$59.95

### "Electrostat-5" Speaker System

Combination "slim design" enclosure (5 1/2" deep) with woofer and two electrostatic tweeters; response 50-20,000 cps; 8 ohms; 12 watts; high-frequency level control; walnut finish with cane-type grille; 16" x 16" x 5 1/2".....\$34.95

### "Solo 4" Speaker System

Compact, rear-loaded reflex-type enclosure; response 100-12,000 cps; 8 ohms; 10 watts power handling capacity; oiled-walnut finish; 6 1/2" x 7 1/2" x 15 3/4" .....\$12.95

## R.G.F.

### Model 100 "The Carnegie" Speaker System

High compliance, high efficiency 3-way system. Response 20-22,000 cps. Impedance frequency response 26-20,000 cps  $\pm$  4 1/2 db utilizing 12" M-222 woofer. LC crossover at 650 & 5000 cps. Minimum power amplifier 3 watts; 22 1/4" w. x 17 1/4" d. x 26 1/2" h. Oiled walnut (6% extra any finish) .....\$239.60

### Model 3 Speaker System

Two-way system with 10" high-compliance bifacial woofer. Response 26-20,000 cps. Impedance frequency response 38-1000 cps  $\pm$  4 db; 1000-18,000 cps  $\pm$  3 1/2 db. 8 ohms; minimum amplifier 3 watts. 14" x

11" d. x 26": walnut .....\$99.70

### Model 104 Speaker System

Same components as above. Impedance frequency response 38-20,000 cps  $\pm$  4 1/2 db.

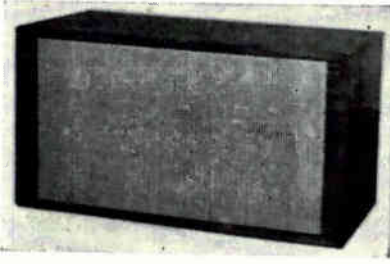

14" x 11" d. x 26". Oiled walnut (optional finishes as above).....\$199.60

### M-222 Speaker

12" duo-coaxial high-compliance woofer with 2 tweeters and 2500 cps LC crossover;



impedance frequency response 24-22,000 cps  $\pm$  3 1/2 db. ....\$98.70

### M-10 Speaker

10" bifacial high-compliance woofer; response 28-20,000 cps; impedance frequency



response 36-1000  $\pm$  3 1/2 db, 1000-18,000 cps  $\pm$  3 db; minimum amplifier 3 watts .....\$69.50

### M-08 Speaker

8" bifacial high-compliance woofer; response 30-20,000 cps; impedance frequency response 800-18,000 cps  $\pm$  4 db; 40-800 cps  $\pm$  4 1/2 db. Minimum amplifier 4 watts .....\$49.70

## ROCKFORD

### Model 128 Speaker Enclosure

Bookshelf type vented-port design for 8" speaker; 20 1/4" x 9" x 10"; finished on all four sides; walnut, mahogany, blonde, or ebony .....\$25.50 Model 212 Same as 128 except will accommodate 12" speaker; 12" x 14 3/4" x 24" .....\$35.00

### Model 108 Speaker Enclosure

Vented-port design for 8" speaker & tweeter; 12" x 24" x 12"; same finishes

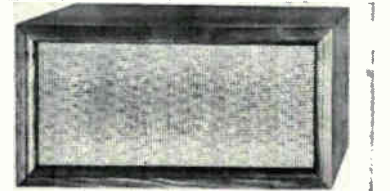

as Model 128.....\$32.50

### Model 112 Speaker Enclosure

Vented-port design for 12" speaker & tweeter; 16" x 24" x 13 1/2".....\$48.00

## SCHOBER

### Model LSS-10 Speaker System

Designed primarily for use with electronic organs; one Electro-Voice SP12B 12" bass speaker plus LS-8 8" treble speaker with 6000 cps mechanical crossover and "whizzer" cone plus 300 cps electrical LC crossover network; response 32-13,000 cps; 40 watts organ tone or 20 watts average program material; ducted port enclosure tuned to 32 cps; 8 or 16 ohm impedance; 24" x 19" x 36"; sold direct only and as a semi-kit. 3/4" birch veneer plywood.



Model LSS-10 (Unfinished).....\$125.00 Model LSS-10W (Walnut finish).....\$150.00 Model LSS-10S (Finish of customer's choice) .....\$165.00 Model LSS-10K Kit including speakers, crossover, & construction plans for cabinet .....\$69.50

## H. H. SCOTT

### Model S-2 Speaker System

Three-way system using a 12" high-compliance woofer; two midrange drivers mounted on acoustically isolated, angled mounting boards; high-dispersion spherical tweeter; multiple crossover networks; response over entire audible range; continuous tweeter and midrange controls; 23 3/4" x 14 1/2" x 12 1/2".

Unfinished pine.....\$179.95 Unfinished hardwood.....\$189.95 Mahogany, walnut.....\$199.95

### Model S-3 Speaker System

Three-way system, bookshelf size; uses high-compliance 10" woofer; midrange

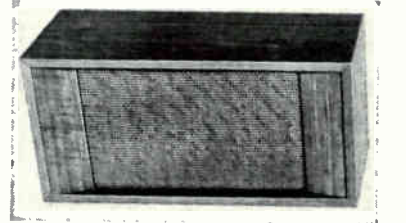

driver; special high-dispersion tweeter; multiple crossover networks with continuous tweeter and midrange controls to provide extended frequency response over entire audible range; size 23 1/2" x 11 3/4" x 9 3/4".

Unfinished pine.....\$119.95 Unfinished hardwood.....\$129.95 Mahogany, walnut.....\$134.95

### Model S-5 Speaker System

Two-way loudspeaker system employing a specially designed low-resonance woofer and tweeter; has crossover network and high-frequency level control; 8 ohm impedance; response 60-15,000 cps  $\pm$  5 db; 10" x 16" x 6 3/4"; .....less than \$60.00

## SHERWOOD

### Model SR3 "Ravinia" Speaker System

Three-way design; 12" woofer with free

# 5 Speakers & Cabinets

air resonance of 21 cps; 8" mid-range; 3" cone tweeter; electrical crossover network 12 db/octave, 60 & 3500 cps; response 45-17,500 cps  $\pm 2\frac{1}{2}$  db; 12-16 ohms; 50 watts program material; 1M distortion less than .5% at 5 watts input; harmonic distortion 4% at 30 cps with 10 watts input; brilliance level control;  $3\frac{1}{8}$ " dia. port to re-inforce low end; all speakers mount from front; cabinet walls 1" thick; 15" x 26 $\frac{1}{4}$ " x 13 $\frac{1}{4}$ ".

SR3W Walnut finish.....\$139.50  
 SR3B Unfinished birch.....\$129.50  
 SR3U Utility design, less grille.....\$119.50  
 SR3K Three-speakers & crossover, less cabinet .....\$79.50  
 Consolette legs.....\$19.95  
 Island pedestal.....\$ 9.95

**Model SR2 "Berkshire" Speaker System**  
 Same as "Ravinia" except for size (24" x 13" x 9 $\frac{1}{2}$ "); response 53-17,500 cps  $\pm$



2 $\frac{1}{2}$  db; handles 50 watts program material; 10 watts min. recommended; walnut finish.....\$99.50  
 Unfinished birch .....\$89.50  
 Utility Blk., no grille.....\$89.50  
 Three speakers & crossover kit.....\$69.50

**"Tanglewood" Speaker System**  
 4-way system: two 10" woofers with staggered resonance (17 $\frac{1}{2}$  & 18 $\frac{1}{2}$  cps resonance); crossover 200 cps to an 8" mid-woofer; crossover 600 cps to 8" midrange & crossover 3500 cps to 3" ring-radiator tweeter. Each speaker individually chambered. Response 29-17,500 cps  $\pm 2\frac{1}{2}$  db; 75 w. capacity; 8 ohms; has brilliance level control; 24" w. x 31" h. x 13" d.  
 SR4-W Walnut .....\$219.50  
 SR4-B Birch unfinished.....\$209.50  
 SR4-U Black lacquer, no grille.....\$199.50  
 SR4-K Kit, 6 spkrs. & crossovers.....\$109.50

## SONOTONE

**Model T-64 Tweeter**  
 Elliptical cone tweeter; power rating: 20 watts average program above 2000 cps; frequency response (in baffle): 800 to 17,000 cps; impedance: 15 ohms at 10,000 cps; flux density: 12,000 gauss;  $\frac{3}{4}$ " aluminium voice coil; designed primarily for 2000 cps crossover; 6" x 4".....\$12.00

**Model WR8-BH 8" Speaker**  
 Power rating 20 watts average program, frequency range 55 to 15,000 cps; resonance 70 cps; impedance 8 ohms; flux density 12,000 gauss; 1" voice coil.....\$13.50

**Model CA-12A Speaker**  
 Coaxial 12" loudspeaker; inductor-capacitor dividing network; elliptical tweeter; frequency range 35 to 20,000 cycles; resonant frequency: 50 cycles; crossover frequency: 2000 cycles; power handling: 40 watts average program, 80 watts peak; flux density: woofer—12,000 gauss; tweeter—9500 gauss; impedance 16 ohms.....\$31.00

**Model W-12 Speaker**  
 Same 12" woofer used in CA-12A coaxial loudspeaker; frequency range 35 to 7000 cycles; resonant frequency 50 cycles; power handling 40 watts average program 80 watts peak; flux density 12,000 gauss; impedance 16 ohms.....\$19.00

**SE-880 & SE-80 Speaker Systems**  
 $\frac{3}{4}$ " non-resonant panels, oiled walnut; lock-mitre joints; "Tufflex" acoustical lining; sculptured finished grille cloth; low frequency design.  
 Beverly Hills Model SE-880. Response 45-20,000 cps; power handling 40 watts (80 watts peak); 8 to 16 ohms; two 8" coaxial cone type; 11" x 24" x 17 $\frac{1}{2}$ ".....\$69.75  
 Scarsdale Model SE-80. Response 45-20,000 cps; power handling 20 watts (40 watts peak); 8 ohms; 8" coaxial cone type; 11 $\frac{1}{2}$ " x 12 $\frac{1}{2}$ " x 20 $\frac{1}{2}$ ".....\$49.75

## SONY

**SSA-3 Integrated Amp/Speaker System**  
 Two-way speaker system with 20 w. music power, all-transistor preamp/power amp;



has inputs for phono cartridge, tape head & aux.; response 25-20,000 cps; walnut cabinet; 11 $\frac{1}{4}$ " x 23 $\frac{1}{2}$ " x 11 $\frac{1}{4}$ " d.....\$119.45

## TANDBERG

**Model CS40 Speaker System**  
 Contemporary style corner speaker system; frequency response: 60 to 16,000 cps; uses single 8" coaxial speaker with mechanical crossover and metal diffusion grille for dispersion of highs; copper ring used in air gap of speaker magnet to reduce self-inductance of voice coil for high frequency response at full energy; light weight permits mounting of enclosure near ceiling; rear of enclosure constructed with one-piece  $\frac{3}{4}$ " plywood with 90 degree corner bend; volume of enclosure: 4 cubic feet; size: 39.4" h. x 20.9" w. x 9.46" d.; weight: 27 $\frac{1}{2}$  lbs.; finishes: light elm or fine grain mahogany.....\$87.50

**Model 165BK 8" Dual-Cone Speaker**  
 Main cone has extra tweeter cone; flux density 11,000 gauss; maximum applied voltage 5 volts; efficiency 5%.....\$21.50

**Model 165B 8" Coaxial Speaker**  
 Consists of bass and mid-range unit with tweeter coaxially mounted; built-in 12 db/octave filter with crossover frequency at 3000 cps .....\$31.50

## TANNOY

**"Belvedere" Speaker System**  
 Dual-ported bass reflex design; may be used vertically or horizontally; 26" x 12" x 18"; walnut.  
 Enclosure only.....\$60.00  
 Enclosure with 12" Dual-Concentric Monitor speaker.....\$200.00  
 Enclosure with 10" Dual-Concentric Monitor speaker.....\$177.25

**10" Dual-Concentric Monitor Speaker**  
 Coaxial speaker—tweeter voice-coil diameter 2", woofer voice-coil diameter 2 $\frac{1}{2}$ "; re-



sponse 20-30,000 cps; IM product less than 2%; crossover frequency 1800 cps; resonance 27 cps; magnet assembly 6 $\frac{1}{4}$  lbs.; polar distribution -2 db @ 10,000 cps for 60 degrees; power handling capacity 20 watts; adjustable high-frequency control; impedance 16 ohms; recommended mounting infinite baffle type as low as 1 $\frac{1}{2}$  cu ft.; shipping weight 13 lbs.....\$112.75

**12" Dual-Concentric Monitor Speaker**  
 Coaxial speaker with bass resonance of 35 cps; IM distortion less than 2%; tweeter



voice-coil diameter 2"; woofer v.c. diameter 2"; woofer designed for true piston operation; surround treated with stable lossy resin to prevent subsidiary resonance; power rating 30 watts; flux density 11,500 gauss for woofer, 15,000 gauss for tweeter; dispersion at 60° -3 db at 10,000 cps; crossover 1700 cps; 16 ohms; response 25-20,000 cps; depth 7 $\frac{1}{2}$ ".....\$138.00

**15" Dual-Concentric Monitor Speaker**  
 Coaxial speaker with bass resonance of 32 cps; IM distortion less than 2%; tweeter voice coil 2" dia.; woofer voice coil 2" dia.; woofer designed for true piston operation; surround treated with stable lossy resin to prevent subsidiary resonance; power rating 50 watts; flux density 13,500 gauss for woofer, 18,000 gauss for tweeter; dispersion at 60° -4 db at 10,000 cps; crossover 1000 cps; 16 ohms; response 23-20,000 cps; depth 9".....\$179.00

**"Belvedere" Senior Speaker System**  
 Designed for use with 15" Dual-Concentric Monitor speaker in stereo reproduction; baffle available for use with 12" speaker; 31 $\frac{1}{2}$ " x 23 $\frac{3}{4}$ " x 16"; walnut or mahogany.  
 Enclosure only.....\$87.50  
 Enclosure with 12" Dual-Concentric Monitor speaker.....\$231.00  
 Enclosure with 15" Dual Concentric Monitor speaker.....\$268.50

**"Dalton" Enclosure**  
 Infinite-baffle type designed for use with either 10" or 12" Dual-Concentric Monitor speakers; 23 $\frac{3}{4}$ " x 23 $\frac{3}{4}$ " x 16"; solid back-to-front legs 2 $\frac{1}{2}$ " high; oiled walnut only .....\$75.00  
 Enclosure with 12" Dual-Concentric Monitor speaker.....\$215.00

**"Berkeley" Enclosure**  
 Infinite baffle, 3 $\frac{1}{2}$  cubic feet; designed for use with the 10" Dual-Concentric Monitor speaker; 23" x 24" x 11 $\frac{3}{4}$ "; solid base 2 $\frac{1}{2}$ " high; oiled walnut only.  
 Enclosure only.....\$62.00  
 Enclosure with 10" Dual-Concentric Monitor speaker .....\$176.75



### Model "GRF" Speaker System

Designed especially for use with 15" Dual-Concentric Monitor speaker: horn-loaded; response 30-20,000 cps  $\pm 3$  db; 50 watts; 8% approx. efficiency; effective loading down to 30 cps; 42" x 23 1/2" x 17 1/2"; oiled-walnut .....\$385.00  
Enclosure only.....\$206.00

### "Cadet" Speaker System

Infinite-baffle approx. 1 1/2 cu. feet; operates on principle of pressure loading and acoustic absorption of back radiation; designed to be used with 10" Dual-Concentric Monitor speaker; 23 3/4" x 13 1/2" x 11"; oiled-walnut only; with speaker .....\$145.00

### "Cornetta" Speaker System

Horn-loaded enclosure designed around the 10" Dual-Concentric Monitor speaker. Response 30-20,000 cps  $\pm 3$  db; power handling capacity 20 w.; effective loading down to 30 cps; 34 3/4" h. x 16 1/8" d. x 18 1/2" w. Walnut finish.....\$269.50  
Enclosure only.....\$155.00

## UNIVERSITY

### Model UXT-5 Super Tweeter

Response from 4500 to 17,500 cps; dispersion 120° horizontal and 50° vertical; 8 ohms; power rating 25-50 watts depending on crossover.....\$21.00

### Model HF-206 Hypersonic Tweeter

Response 3500 cps to beyond audibility; dispersion 120° horizontal and 50° vertical; power rating 25-50 watts depending on crossover; 8 ohms; 6" x 3 3/16" x 6 3/16" .....\$33.00

### "Diffusicone-12" Wide-Range Speaker

Response 28-15,000 cps; power rating 35 watts; 8-16 ohms; 7 1/8" deep.....\$39.75

### Model 6201 Coaxial Speaker

Compression tweeter and 12" woofer; response 28-18,500 cps; built-in crossover network with "Brilliance" control; power rating 30 watts; 8-16 ohms; 6 3/8" deep .....\$57.75

### Model 312 "Diffaxial" Speaker

Sphericon tweeter is projected through the center of the 12" woofer; mid-range reproduction is handled by "Diffusicone" section; built-in crossover network and variable "Brilliance" control; mechanical crossover at 1000 cps and electrical at 5000 cps; response 28-40,000 cps; power rating 35 watts; 8-16 ohms; 6 3/8" deep .....\$73.00

### Model 315-C Wide-Range Speaker

15" woofer with T-50 "Hypersonic" driver and horn; response 25-20,000 cps; adjustable tweeter balance; 6 1/2 lbs. of Alnico V magnet material; power rating 50 watts; 8-16 ohms; 12" deep.....\$156.00

### Model 4401 Tweeter

One-piece die-cast horn with 120° horizontal and 50° vertical dispersion; hermetically sealed construction; response 2000-15,000 cps; 8 ohms; power rating 25 watts; 6" x 2 3/4" x 6 3/16" .....\$18.00

### "Medallion XII" Speaker System

3-way speaker system consisting of 12" high-compliance woofer, 8" mid-range, Sphericon super tweeter; frequency response 28-22,000 cps; snap-on speaker grilles to match Provincial, Modern, or

Contemporary furnishings; mahogany, walnut, oiled-walnut, fruitwood; grilles separate .....\$139.95  
Unfinished .....\$134.95  
Select-A-Style frame for French Provincial in fruitwood.....\$ 14.95  
Select-A-Style frame for Early American in fruitwood .....\$ 14.95  
Select-A-Style frame for Italian Provincial in mahog., wal., oiled walnut, fruitwood .....\$ 14.95  
Select-A-Style frame for Swedish Modern in mahog., wal., oiled walnut, fruitwood .....\$ 14.95  
Above styles unfinished .....\$ 13.95  
Select-A-Style frame for Contemporary in mahogany, walnut, oiled walnut, fruitwood .....\$ 9.95  
Unfinished .....\$ 8.95  
Wool base for Medallion XII (all finishes) .....\$ 14.95  
Unfinished base .....\$ 13.95

### "Medallion Monitor" System

3-way system. 12" high compliance woofer, 8" mid-range, direct-radiator Sphericon



super tweeter. Crossover 6 db/octave.  
Oiled walnut .....\$129.00

### T-202 "Sphericon" Super Tweeter

Domed phenolic diaphragm and spherical diffractor; frequency response 3000-44,000 cps; 120° dispersion; 4 3/8" diameter; built-in crossover network; 3 lbs.....\$24.95

### Model T-203 "Sphericon" Super Tweeter

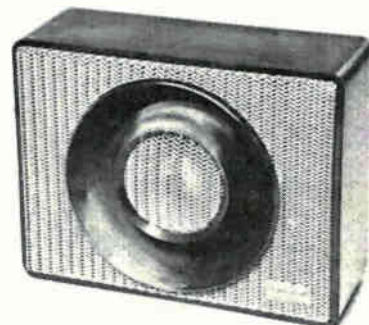

Similar to Model T-202 except housed in case for exterior use; 30 watt rating; 8 ohm impedance.

Model T-203E (ebony).....\$24.95  
Model T-203W (walnut).....\$24.95

### Model S-9S 15" Speaker System

Consists of Model C-15W, Model T-30 "Cobreflex", Model HF-206 speakers; front-loaded folded-horn type; assembled and wired; unfinished; 40" x 30" x 24". .....\$340.00

### Model 308 3-way "Diffaxial" Speaker

Employs compression tweeter and 8" woofer; mechanical crossover at 1000 cps and electrical at 5000 cps; response 30-17,000 cps; power rating 35 watts; 8-16

**BASIC SPECIFICATION**

"Monitor" Dual Concentrics:  
Models  
10", 12", and 15"

Frequency response  
30-20,000 cps  $\pm 3$ dB

Polar Distribution for  
60° inc. angle -4dB  
at 10,000 cps

Write for full details.

**NOVELTY  
IN SPEAKERS**

High Fidelity speakers need not and should not be complicated. They must, however, be designed as complete systems including the enclosure rather than be a collection of individual units and cross-over networks, with the increased possibility of error and the lack of necessary equipment for tests in the home when finally assembled.

Few people would obtain a motor-car by buying the engine, chassis, body etc. and assembling it at home. They would rightly regard this as a job for expert engineers — and so with loudspeakers, where naturalness not novelty is the desired result.

**TANNOY**

**DUAL  
CONCENTRIC  
SPEAKERS**

TANNOY (AMERICA) LTD. P.O. BOX 177, EAST NORWICH, N.Y., U.S.A.  
TANNOY (CANADA) LTD. 36 WELLINGTON STREET EAST, TORONTO 1, ONTARIO, CANADA  
CIRCLE NO. 59 ON READER SERVICE CARD

# 5 Speakers & Cabinets

ohms; 6 1/8" deep.....\$42.00

## "Diffusicon-8"

Response from 30-15,000 cps; power rating 35 watts; 8-16 ohms; 4 1/2" deep.....\$28.00

## Model MM2-PPS Speaker

Completely waterproof for use at swimming pools. Polypropylene plastic housing; heavy



18-foot cable with third wire for grounding; power capacity 30 watts; impedance 16 ohms; bracket or flush mounted. \$44.55

## "Mustang" Speakers

Model M-8. 8" high efficiency; 8 ohms. 2 1/2" deep. Response 70-10,000 cps. Han-



dles 30 w. ....\$19.00

Model M-8D. 8" high-efficiency dual-range speaker. 8 ohms. 2 1/2" deep; response 70-



12,000 cps; crossover at 1500 (mechanical). Handles 30 w .....\$19.50

Model M-12. 12" high efficiency; 8 ohms; 3 3/8" deep; response 35-10,000 cps. Han-



dles 30 w .....\$20.50

Model M-12D. 12" high-efficiency dual-range speaker. 8 ohms. 3 3/8" deep. Re-



sponse 35-14,000 cps; crossover at 1500 cps (mechanical). Handles 30 w .....\$21.00  
Model M-12T. 12", 3-way diffraxial. 8 ohms. 3 3/8" deep; response 35-40,000 cps.



Crossovers at 1500 & 4500 cps. Handles 30 w .....\$32.00

## "Companionette" Speaker System

Two-way speaker system; 8" high-compliance woofer; direct-radiator tweeter; 1.1 cubic foot enclosure; response 40-17,000 cps; crossover frequency 2000 cps; power capacity 30 watts program material; 8 ohms; 16" x 11" x 11"; oiled walnut .....\$69.95

## "Mini-Flex" Speaker System

Three-way speaker system with special viscous-treated moving seal type woofer



cone rim suspension; dual-cone mid-range; high-frequency speaker; separate level controls for mid-range and tweeter; response 35-20,000 cps; crossovers at 1000 & 7000 cps (6db/octave slope); power capacity 30 watts; 8 ohms; cabinet .4 cubic foot; 15" x 9 1/16" x 5 3/16"; oiled walnut.....\$69.95

## "Mini-Flex II" Speaker System

Special 6 1/2" woofer with 3 1/2" mid-range cone and super tweeter. Crossovers



at 800 & 2000 cps. Response 45-18,000 cps. 8 ohms. Handles 30 watts. 0.4 cu. ft. enclosure 15" x 8 1/2" x 6" d. ....\$49.95

## "Senior II" Speaker System

Three-way speaker system; 12" woofer. 3 1/2" mid-range, Spheron super tweeter; response 30-22,000 cps; 8 or 16 ohms; crossover 3000 cps; brilliance control; 25" x 15 1/8" x 12 1/8".  
Oiled walnut .....\$99.50  
Unfinished .....\$89.50

## "Companion II" Speaker System

Three-way speaker system with RRL ("Radiation Resistance Loading"); has 10" woofer, 3" mid-range, 3 1/2" tweeter; response 35-18,000 cps; 8 or 16 ohms; crossover at 3000 cps.  
Oiled walnut .....\$79.50  
Unfinished .....\$69.50

## Model T-50 Hypersonic Driver

Heavy duty high efficiency driver for use with H-600 horn; response from 600 cycles



to inaudibility; 8 ohms; 1 3/8"-18 throat; 4 1/2" diameter; 4 1/8" deep.....\$49.50

## "Syl-O-Ette" Speaker System

Two-way speaker system in ultra-thin decorator-styled cabinet; choice of inter-

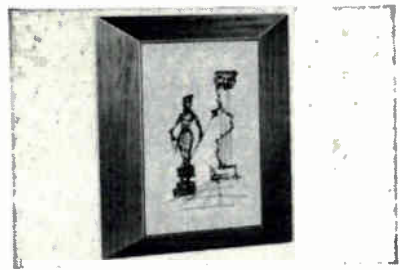

changeable grille fabric frames; may be used on wall or floor, horizontally or vertically; 8" woofer, 6 1/2" mid-range, subsidiary tweeter-radiator; response 40-20,000 cps; power capacity 30 watts program material; crossover at 500 cps; 23" w. x 29" h. x 4" d. Oiled walnut with decorator cane grille.....\$ 99.95  
Unfinished with decorator cane grille.....\$ 95.95  
Walnut with petit point grille.....\$109.90  
Unfinished with petit point grille....\$105.90  
Oiled walnut with neo-classic grille.....\$ 99.95  
Unfinished with neo-classic grille..\$ 95.95

## "Tri-Planar" Speaker System

Three-way, ultra-thin system with 2 woofer panel radiators (234 sq. in. radiation) and a 2 3/4" tweeter; open-back doublet-type design; response 45-17,000 cps; 4-8 ohms; power rating 20 watts; 15" x 23" x 1 3/4".  
.....\$79.95

## "Classic Dual-12" Speaker System

Similar in styling to "Classic Mark II" but more compact; three-way system; 12" large-excursion woofer, 12" high-compliance woofer/mid-range; Spheron super



tweeter; response 30-40,000 cps; 4 or 8 ohms; RRL tuned ducted-port enclosure; 2.8 cubic feet; 3-step mid-range control and continuously variable tweeter control; power capacity 50 watts program material; 23 3/4" x 31 1/4" x 15 1/2"; oiled walnut .....\$229.50

## "Classic Mark II" Speaker System

Three-way high-compliance speaker system; 15" woofer, 8" mid-range; Spheron super tweeter; response virtually flat

from 20-40,000 cps; power requirements 10 to 60 watts; crossover 150 cps; 4-8 ohms; has presence and brilliance controls; 35" w. x 28 1/4" h. (with legs) x 17 1/2" d.; oiled walnut.....\$295.00

**"Classic Mark II" Speaker System**

French Provincial design. Radiation resistance loaded. 15" woofer, 8" mid-range &

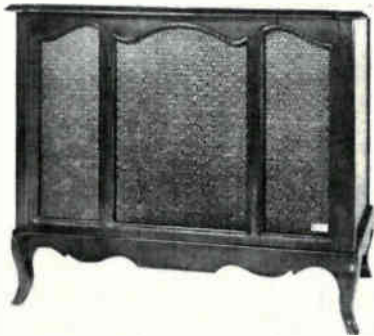

Sphericon super tweeter. Response 20-40,000 cps. Use with 10 to 60 w. amp. 36" x 29" x 16" d. Fruitwood finished cherry .....\$325.00

**Model T-30 Driver**

Mid-range and high-frequency driver for use in 2, 3, or 4-way systems; response



200 to 15,000 cps; use with H-600 or "Cobreflex" horns; 8 ohms; 3 1/2" diameter; 3 1/4" deep.....\$30.00

**Model H-600 Horn**

Mid-range and high-frequency horn with 600 cps cut-off; die-cast design with reciprocating flare design for uniform dispersion; fits any driver with standard 1 3/8"-18 throat .....\$19.00

**Model C-8W 8" Woofer**

For use as woofer in compact system or as mid-range in low-cost three-way system; suitable for crossover to 5000 cps; response to 50 cps with proper baffling; power rating 25 watts; 8 ohms; 4 1/4" deep....\$15.00

**Model C-8M 8" Mid-Range Speaker**

Response 500-5000 cps; power rating 50 watts program material; depth 4 1/4" .....\$16.95

**Model C-12SW Dual Voice Coil Woofer**

12" adjustable response woofer; high end may be limited to 700, 2500 or 5000 cps to complement tweeter; 1 1/2 lb. Alnico V magnet; response 30 to 6000 cps; 8 ohms; power rating 30 watts; 6 1/2" deep..\$39.50

**Model C-15W Woofer**

15" dual impedance woofer; may be used in any system from 4 to 20 ohms; response from below 25 to 1500 cps; power rating 50 watts; 6 lb. Alnico V magnet; 10 1/2" deep .....\$85.00

**Model C-12HC Dual Voice Coil Woofer**

High compliance 12" woofer; "Uniferrox-7" magnet material; response to 3000 cps permits use in two-way systems; dual impedance coil; 4-20 ohms; power rating 60 watts; 5 1/2" d. ....\$49.50

**Model C-15HC Dual Voice Coil Woofer**

High compliance 15" woofer; "Uniferrox-7" magnet material; response to 800 cps; dual impedance coil; 4-20 ohms; operating power should be from 10 watts up. 8 1/2" deep .....\$89.50

**N-1 Adjustable High Pass Filter**

Two-way dividing network with tweeter control; crossovers at 2500, 5000, and 10,000 cps at 8 ohms; 1250, 2500, 5000, at 16 ohms; 5000 and 10,000 cps at 4 ohms; fits panels up to 3/4" thick; 3 3/4" x 3" .....\$14.00

**Models N-2A and N-2B Networks**

Adjustable L/C dividing networks; N-2A is 6 db/octave two-way L/C network; may be used in pairs as 12 db/octave network or singly as 12 db/octave low or high-pass filter; crossover 350 or 700 cps at 8-16 ohms; 700 cps at 4 ohms; N-2B is 6 db/octave two-way L/C network; may be used in pairs as 12 db/octave network or singly as 12 db/octave low or high-pass filter; crossovers are 1250, 2500, or 5000 cps at 8 ohms; 2500 or 5000 cps at 16 ohms; 2500 cps at 4 ohms; N-2A and N-2B may be used in combination for three-way systems.

Model N-2A .....\$18.00  
Model N-2B .....\$14.00

**Model AP-8 Balance Control**

Attenuator pad to regulate speakers of different efficiencies and for balancing sound for room acoustics and personal taste; ideal for N-2A and N-2B networks..\$3.95

**Model A-1 Stereo Adapter Network**

Provides means of using single woofer for both stereo channels; not suitable for dual voice-coil speakers; phasing switch included .....\$30.00

**Model N-3 "Acoustic Baton"**

Three-way L/C dividing network with variable controls for high and mid-range;



crossover between woofer and mid-range either at 350 or 700 cps; tweeter crossover at 5000 cps; fits panels up to 3/4" thick; 8 ohms; 7" x 5" x 3".....\$32.00

**Model MLC Speaker System**

Weatherproof coaxial speaker for outdoor use; frequency response 150-15,000 cps; power rating 15 watts; impedance 8 ohms; dispersion 120 degrees; 12 3/4" x 9 1/8" x 10 1/8" .....\$34.50

**Model WLC Outdoor Speaker**

50-15,000 cps; 30 watts; 90 degree dispersion; completely weatherproof; hi-fi quality; 8 ohms.....\$150.00

**Model CLC Outdoor Speaker**

Balanced "compression" folded-horn design; completely weatherproof; response 55-14,000 cps; 30-watt power capacity; 120 degree dispersion; 8 ohms; 22 3/4" x 12 1/16" deep .....\$69.95

creates big sounds from a small package

Sound MAGIC comes from  
A real **PRO**

Big console sounds from a bookshelf size speaker system? Sounds impossible? No, it sounds great! But, UTAH magic doesn't stop there with the all new PRO. Like the chameleon, the PRO also changes colors to match any changing room decor. The front of this beautiful Walnut cabinet has a snap out grille, which can be changed in seconds. A wide selection of decorator color fabrics are available, and the grilles can be changed to accent any room color scheme. PRO IS TRULY COMPACT. It's dimensions of 12" x 12" x 24" pack the finest acoustical engineering found anywhere. This 3-speaker high-compliance system attests to the real magic of UTAH electronic sound engineering.

**Exciting PRO features:**

- Bookshelf size, console sound
- Snap-out accent grille
- Acoustic suspension, high-compliance woofer in a sealed cabinet
- Hand-rubbed 3/4" walnut veneer cabinet
- Advanced acoustic engineering
- Components—3 Utah Speakers, a 10" woofer, 8" midrange, 3 1/2" tweeter (adjustable level)
- Sealed enclosure—heavily damped with fiberglass
- Power rating—40 watts
- Impedance—8 ohms
- Frequency Response—30/19,500 cps

**Model PRO**  
**\$99.50**  
net

**utah**  
HUNTINGTON, INDIANA

# 5 Speakers & Cabinets

## "Cobreflex" Horn

Designed for use as mid-range horn in three-way systems or as high frequency horn in two-way systems; crossover as low as 350 cps; 120° horizontal and 60° vertical dispersion .....\$24.15

## UTAH

### Fabulous G Series Speakers

G8J (8" extended range, 50-14,000 cps, 12 w.) .....\$ 8.28  
 G15R (15" woofer, 20-4000 cps, 40 w.) .....\$34.05  
 G12P5 (12" coaxial, 35-19,500 cps, 30 w.) .....\$34.50

### Dual-Diameter Speakers

Dual-cone speakers with single voice coil and magnet structure; impedance 8 ohms. D81A (8" full range, 40-16,000 cps, 18 w.) .....\$14.25  
 D12LA (12" full range, 30-16,000 cps, 18 w.) .....\$16.20  
 All speaker power ratings are peak audio watts.

### Crossover Networks

LC type designs for 2- or 3-way systems; air-core coils; potted can assembly; use one 2500 cps model for 2-way system; use one 600 cps and one 5000 cps for 3-way system; for "G Series" speakers use 8-ohm crossover; for "Continental Series" use 16-ohm crossover; 2 3/8" x 2" x 2". X-608 (8 ohms, 600 cps).....\$8.75  
 X-5008 (8 ohms, 5000 cps).....\$8.75

### Model SH4 "Thin" Speaker System

Can be used on bookshelf or mounted vertically or horizontally on wall; 45-

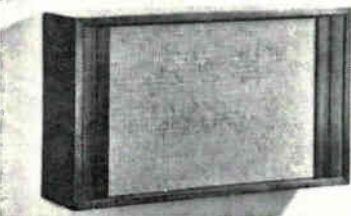

17,000 cps; 12 watts audio peak power; oversize voice-coil 8" woofer and high-efficiency tweeter; 12" x 20" x 4 13/16"; 8-ohm system; walnut finish.....\$29.97

### "Celesta" Series Speakers

C8JC-1 Extended range 8", 35-15,000 cps. Res. freq. 65 cps; 30 w. peak audio .....\$11.95  
 C8JC-2 Two-way 8" coax; 35-19,000 cps. Res. freq. 65 cps; 30 w. peak audio .....\$12.95



C8JC-3 Three-way 8" coax; 35-20,000 cps. Res. freq. 65 cps; 30 w. peak audio

.....\$17.95  
 C12JC-1 Extended range 12"; 30-14,000 cps. Res. freq. 50 cps; 35 w. peak audio .....\$15.95  
 C12PC-2 Two-way 12" coax; 25-19,000 cps. Res. freq. 50 cps; 45 w. peak audio .....\$18.95  
 C12PC-3 Three-way 12" coax; 25-20,000 cps. Res. freq. 50 cps; 45 watts peak audio .....\$24.95  
 All 8" speakers are 3 9/16" deep and all 12" 5 1/16" deep.

### Model SH5A "Huntington" 3-way System

Small bookshelf system with 8" woofer, 6" midrange, 5" tweeter; response 35-17,500 cps; 13 1/2" x 22" x 6"; peak audio power; 18 watts; walnut veneer.....\$49.95

### Model PT2 Speaker System

Wall-mounted design 12" x 18" x 3"; bass reflex port; uses 8" woofer and 3" x

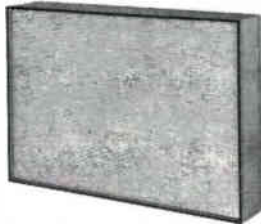

5" tweeter; crossover at 2000 cps; 8 ohms; 8 watts peak power; walnut, blonde, or mahogany finishes .....\$16.32

### Model PT4 Speaker System

Deluxe version of PT2; has two 3 1/2" tweeters for response to 18,500 cps; will handle 10 watts audio peak power; 12" x 20" x 3 1/2"; walnut finish.....\$19.95

### "Heritage I" Speaker System

Bookshelf design with 3 speakers—12" woofer & two 5" tweeters. 30-18,500 cps; 40 watt capacity; 8 ohms; LC-type crossover. Made of 3/4" walnut veneer plywood with 1" fiberglass on 3 inside surfaces. 15" h. x 28" w. x 14". Model HS1W.....\$79.95

### "Heritage II" Speaker System

Floor design with legs. Has 4 speakers. Response 25-20,000 cps; 50 watt music power; 8 ohms; LC crossover network. Made of 3/4" walnut veneer plywood with 1" fiberglass on 3 inside surfaces. 26" h. x 21" w. x 18 3/4". Model HS2W.....\$139.90

### "Heritage III" Speaker System

Floor design with legs. Has 8 speakers. Response 20-20,000 cps; 80 w. music



power; 8 ohms; LC-type crossover. Made of 3/4" walnut veneer plywood and 1" fiberglass on 3 inside surfaces. 26" h. x 33" w. x 18 3/4". Model HS3W.....\$199.90

## VITAVOX

### 12" & 15" Speakers

AK120 12" full-range; resonance 45 cps; 15 ohm; 30 watts.....\$ 75.00  
 Model AK121 12" woofer; resonance 40 cps; 15 ohm; 30 watts.....\$ 85.00  
 Model K15/40 15" wide-range; resonance 45 cps; 15 ohm; 35 watts.....\$125.00  
 Model K15/40 15" woofer, resonance 35 cps; 15 ohm; 35 watts.....\$135.00  
 Model DU120 12" dual-magnet coaxial full-range speaker; response below 30 to above 18 kc.; 15 ohm.....\$ 95.00

## V-M CORP.

### Model 62 "Silhouette"

Combines a 10" woofer, 6" mid-range, and 3 1/2" tweeter with ultra-thin enclosure that can be hung on wall, built into wall, or left free standing; response 30-16,000 cps; crossover 600 cps and 5000 cps; 25 watts program power rating; 8 ohms; 26 3/4" h. x 20 1/2" w. x 4 3/4" d.; walnut finish Retail price.....\$85.00

### Model 32 Speaker System

Has two 6" and one 3" speakers; response 60-12,000 cps; 10 watt program power rating; 4 ohm impedance; 9" h. x 18" w. x 8 3/8" d.; walnut or mahogany finish Retail price.....\$39.95

### Model 42 Speaker System

Dual system with 6" woofer & 3 1/2" tweeter; sealed cabinet design; response 50-14,000 cps; crossover 2500 cps; 8 ohms; 15 watts music power capacity; 20" x 15" x 4 1/8" d.; add 1 1/2" for legs. Retail price.....\$49.95

### Model 43 Speaker System

Slim design; 6" woofer & 3 1/2" tweeter; response 50-14,000 cps; crossover 2500 cps; power 15 w. program; 8 ohms; walnut with cane grille; 20" h. x 15" w. x 4 1/2" (21 3/16" with legs). Retail price.....\$49.95

### Model 33 Speaker System

Shelf design; 6" woofer, 5 1/2" mid-range, 3 1/2" tweeter. Response 50-14,000 cps; crossover at 2500 cps; power 10 w. program; 8 ohms. Hardwood walnut finish with cane grille; 8 3/8" h. x 15 3/8" w. x 5 1/4" Retail price.....\$29.95

## WHARFEDALE

### Model W40 Mk II

Can be used vertically or horizontally; sand-filled panels; 10" low-frequency driver; 5"



tweeter; 23 1/2" x 12 1/2" x 10 1/8" deep; available in oiled or polished walnut; 8 ohms; power requirements 5 w. or more; crossover 1500 cps; has treble control. Speakers are physically isolated from each other .....\$83.50  
 Unfinished utility model (birch).....\$72.50

### Super 3 Tweeter

Conc-type 3" tweeter: flux density 14,500 gauss, total flux 75,500 gauss; smooth high-frequency response is achieved by eliminat-

# WHAT SCIENTIST IN HIS RIGHT MIND

## WOULD TURN HIS BACK ON FAME AND FORTUNE...MOVE TO HOPE, ARKANSAS...AND DEVOTE HIS LIFE TO BUILDING THE WORLD'S MOST PERFECT SPEAKER SYSTEMS?

**PAUL W. KLIPSCH, SCIENTIST, ENGINEER, FANATIC.** A man holding patents on everything from electronic instruments to the world famous KLIPSCHORN and Klipsch speaker systems.

Klipsch built his first loudspeaker back in 1920 from earphones and a long cardboard tube. For the next 19 years he immersed himself in the study of basic speaker design principles.

By 1939 Klipsch had finally synthesized the basic laws of physics into the most theoretically correct loudspeaker ever designed.

Now the job was to make the prototype. In Klipsch own words, "I built her with a borrowed not-too-sharp handsaw, hundreds of screws and plenty of elbow grease. I filled my mistakes with glue and sawdust and whatever else you fill cracks with. I don't know how I did it, but the baby was air tight . . . and damned efficient!"

But Klipsch wasn't completely satisfied.

For 8 years he labored at perfecting the bass response (30 to 400 cps). Finally he got what he wanted . . . smooth, undistorted sound and magnificent bass fundamentals so low and powerful that they could reproduce even the Tibia pedal tones of a huge pipe organ.



Accurate reproduction of the important mid-range (400-5000 cps) underwent even more research and design analysis. Klipsch spent 15 years developing this mid-range horn and the

tweeter (5000 to 20,000 cps) to their present state of perfection.

**CHOICE OF THE EXPERTS**—The result of this 23 year labor of love is the KLIPSCHORN. Acclaimed by audio experts as the finest speaker system in the world, because of its unique high efficiency exponential corner-horn design. Continually chosen

by leading professional musicians as the only system which can truly recreate the total sound of a great symphony orchestra at concert hall listening levels.

The KLIPSCHORN has the lowest distortion and widest full power frequency response of any speaker system in the world . . . 1/10 of 1% FM distortion\* from 30 to 20,000 cycles per second at over 115 decibels of sound output. It would take a loudspeaker 8 times larger than the KLIPSCHORN to accomplish anywhere near the same sound quality.

The KLIPSCHORN is neither a shoe-box nor a clothes closet. There is absolutely no compromise made in the endeavor to achieve audio perfection. It is not too small or too large. It is the optimum size for the reproduction of music.

The KLIPSCHORN is not a bargain basement system. It retails from \$514 to over \$800. But if you are a music lover with a truly discriminating ear . . . or if you seek to cultivate one . . . the KLIPSCHORN is made for you. Ultimately you'll be satisfied with nothing less, price be hanged.



**WIDE STAGE STEREO AND THE HERSEY**—When Paul Klipsch heard ordinary two-speaker stereo, he immediately realized it was painfully inadequate. He knew that to really reproduce a live performance, the whole wall of the living room must come alive with sound.

In his laboratory he developed Wide Stage Stereo. To achieve this kind of stereo experts have long recognized the need for three full range speakers . . . two located diagonally in the corners and one in the center. For a center speaker, Klipsch developed his first non-corner speaker, which he appropriately christened his Hersey.

Naturally, the Hersey is a Klipsch quality low distortion high output speaker. It is a 3-way system with 1/10 of 1% distortion\* throughout its 50 to 20,000 cps range.

Klipsch enthusiasts with space problems soon began to use the Hersey (by now dignified

with the nom de plume, Model H) independently of its larger brother. As one apartment dweller said, "When I realized I couldn't use a KLIPSCHORN, I knew the only other speaker to own was the Hersey."



The Hersey is 11" x 15" x 21". Its retail price is \$221.

**QUELLING A CONTROVERSY**—For years a controversy had raged among speaker designers as to which was best, a horn or an enclosure type speaker. Klipsch had proved the answer to that one with the KLIPSCHORN. But now he was challenged to create an enclosure type speaker.



He set as his goal "maximum performance per cubic foot." The result was the beautiful Cornwall. Easily the finest enclosure speaker ever produced.

This loudspeaker is a 3-way system with extremely smooth response from 30 to 20,000 cps. The Cornwall is only 6 dbi less efficient than the mighty KLIPSCHORN. It has the lowest distortion\* of any enclosure system available. The Cornwall may be purchased for \$416.

We sincerely hope you will listen to our systems and compare them with others. You will then know why Klipsch is acknowledged as creator of the speakers by which all others must be judged.

Please send me complete information on the KLIPSCHORN, Hersey and Cornwall speaker systems. Also include the name of my nearest Klipsch Authorized Audio Expert

**KLIPSCH & ASSOCIATES**  
Box 96D  
Hope, Arkansas



NAME \_\_\_\_\_  
ADDRESS \_\_\_\_\_  
CITY \_\_\_\_\_ STATE \_\_\_\_\_  
OCCUPATION \_\_\_\_\_ AGE \_\_\_\_\_

\*In Klipsch speakers all forms of distortion are minimized especially FM and AM distortion which are many times as objectionable as simple harmonic distortion. Technical papers are available on this subject.

# 5 Speakers & Cabinets



ing the conventional centering device; may be used with 2- or 3-way systems as high-frequency tweeter; impedance 8 ohms; 2 1/4" deep .....\$26.50

### Model W60 Mk II

Shelf-size speaker system with sand-filled panel, containing 12 1/2" and 5" speakers.



matched to enclosure; resonance 25 cycles; 8 ohms; oiled or polished walnut. Power required 5 w. or more; crossover 1500 cps. Has treble attenuator. 14 1/2" x 13" x 24" .....\$122.50  
Sanded unfinished birch.....\$106.50

### Model W70 Mk II

3-way sand-filled panel system; 12 1/2" low-freq. driver, 10 1/4" midrange & 3" cone-type tweeter. Resonance of woofer 25 cps, of midrange 27 cps. 8 ohms. Requires 6 w. to drive; crossover 1500 & 6000 cps (LC type). Has treble attenuator. Oiled or pol-

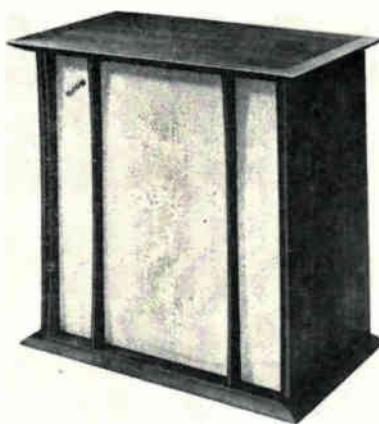

ished walnut: 23 3/8" h. x 24" w. x 14 1/2" d .....\$172.50  
Sanded birch utility model.....\$153.50

### Model W90 Mk II

Features sand-filled enclosure & a dual 3-way, 6-speaker system: 2-12 1/2" low-freq. drivers, 2-5 1/2" midrange & 2-3" cone tweeters. Resonance freq. of woofer 25 cps. Crossovers at 500 & 6000 cps (LC type). 8 ohms. Requires 12 w. to drive & has treble and midrange attenuators. Oiled or polished walnut.....\$272.50  
Sanded birch utility model.....\$256.50

### Mounting Base

For use with Models W60, W70, W90 systems; two leg assemblies are supplied with connecting dowel; can be used with speakers mounted vertically or horizontally by shortening the connecting dowel; available in walnut .....\$10.50  
Unfinished sanded birch model.....\$ 9.50

### Super 8/RS/DD Full-Range

Cone type 8" speaker with aluminum voice coil; bass resonance 50-60 cps; 10-15 ohms impedance; flux density 14,500 gauss, total flux 60,000 gauss. Depth 3" .....\$26.50

### Super 10RS/DD Full-Range

10" dia. speaker; 10-15 ohms; resonance 38-43 cps; depth 5 1/4" .....\$47.50

### Super 12RS/DD Full-Range

12" dia. speaker; 12-15 ohms; resonance 26-36 cps; depth 7" .....\$89.50

### Model W12/RS Woofer

Low-frequency speaker; 12" dia. 12-15 ohms; resonance 26-34 cps; speaker depth 6 1/2" .....\$52.50

### Model W15/RS Woofer

Low-frequency speaker; 15" dia.; 15 ohms; resonance 26-32 cps; depth 7 1/2" .....\$89.50

## WIGO

### Model FW-2 Crossover Network

Crossover at 5000 cps.....\$5.00

### Model ER-85 Full Range Speaker

8" extended range; capacity 15 watts; frequency response 40 to 15,000 cps; resonance 70 cps; 16 ohms impedance; 5 1/4 oz. magnet; flux density 10,000; baffle opening 7 3/4"; depth 4 3/4"; shpg. wt. 4 1/2 lbs. ....\$21.00

### Model ERD-12

12" extended range; capacity 30 watts; frequency response 30 to 15,000 cps; resonance 40 cps; 16 ohms impedance; 8 lb. 13 oz. magnet; flux density 12,500; baffle opening 10 1/2"; depth 6 3/8"; shpg. wt. 13 lbs. ....\$59.50

### Model CX-2 Twin Tweeter Array

Dual cone-tweeter assembly kit converts ERD-12 to CX-212; complete with high pass filters, terminals, cables, hardware, instructions; wt. 1 1/2 lbs.....\$20.00

### Model CX-212 Coaxial Speaker

Model ERD-12 speaker with model CX-2 dual cone-tweeter assembly attached raising response to 18,000 cps; all other specifications identical; shpg. wt. 14 1/2 lbs.; includes Model FW-2 crossover network. ....\$79.50

### Model TW-400 Tweeter

4" cone tweeter; capacity 10 watts; frequency response 2000 to 18,000 cps; 8 and 16 ohms impedance; 3 oz. magnet; flux density 8000; baffle opening 3 3/8"; wt. 1 1/4 lbs. ....\$12.50

### Model WD-12 Deluxe Woofer

12"; capacity 30 watts; frequency response 25 to 3500 cps; resonance 35 cps; 16 ohms impedance; 1 lb., 13 oz. magnet; flux density 12,500; baffle opening 10 1/2"; depth 6 3/8"; wt. 13 lbs.....\$59.50

## DIRECTORY OF HIFI MANUFACTURERS

Continued from page 8

STANTON—Pickering and Co., Inc. ....	38, 46, 48	TRUVOX—Benjamin Electronic Sound Corp. ....	104
Sunnyside Blvd., Plainview, L.I., N.Y.		80 Swalm St., Westbury, N.Y.	
STEREOSONICS INC. ....	174	TURNER CO., THE ..... 164	
39-43 46th St., Long Island City 4, N.Y.		Cedar Rapids, Iowa	
STRAFORD—Trutone Electronics, Inc. ....	56	UHER—Martel Electronics Sales, Inc. ....	104
14660 Raymer St., Van Nuys, Calif. 91405		2356 S. Cotner Ave., Los Angeles, Calif. 90064	
SUPEREX ELECTRONICS CORP. ....	174	ULTRAUDIO—Oberline, Inc. ....	30
4-6 Radford Pl., Yonkers, N.Y.		P.O. Box 921, Beverly Hills, Calif.	
SWITCHCRAFT, INC. ....	49, 175	UNIVERSITY—LTV University, Div. Ling-Temco-Vought, Inc.....	151, 165
5555 N. Elston Ave., Chicago 30, Ill.		9500 W. Reno, Oklahoma City, Okla. 73101	
TACO (TECHNICAL APPLIANCE CORP.)—Div. of Jerrold		UTAH ELECTRONICS—Div. of Utah-American Corp. ....	154
Electronics Corp. ....	74	1124 E. Franklin St., Huntington, Ind.	
Sherburne, N.Y.		VERNON AUDIO—Div. of Vernon Photographic Corp. ....	104
TANDBERG OF AMERICA, INC. ....	103, 150	144 E. Kingsbridge Rd., Mt. Vernon, N.Y.	
8 Third Ave., Pelham, N.Y.		VIKING OF MINNEAPOLIS, INC. ....	104
TANNOY (AMERICA) LIMITED ..... 150		9600 Aldrich Ave. S., Minneapolis, Minn. 55420	
Box 177, East Norwich, L.I., N.Y.		VITAVOX—Ercona Corp. ....	154
TEECO—Trutone Electronics, Inc. ....	30, 69, 70	432 Park Ave. S., New York, N.Y. 10016	
14660 Raymer St., Van Nuys, Calif. 91405		V-M CORP. ....	30, 40, 56, 69, 106, 154
TELEX—Div. of Telex, Inc. ....	175	P.O. Box 659, Benton Harbor, Mich. 49023	
3054 Excelsior Blvd., Minneapolis, Minn. 55416		WEATHERS—TelePro Industries, Inc. ....	40, 46, 48
THORENS—Elpa Marketing Industries, Inc. ....	38, 48	Cherry Hill Industrial Center, Cherry Hill, N.J. 08034	
New Hyde Park, N.Y.		WHARFEDALE—Div. of British Industries Corp. ....	154
		80 Shore Rd., Port Washington, N.Y.	
		WIGO—United Audio ..... 156	
		12 W. 18th St., New York, N.Y. 10011	
		WINEGARD COMPANY ..... 74	
		3000 Kirkwood St., Burlington, Iowa 52602	

# ACCESSORIES

**MICROPHONES .....157**  
**EQUIPMENT CABINETS.....166**  
**MISCELLANEOUS .....171**

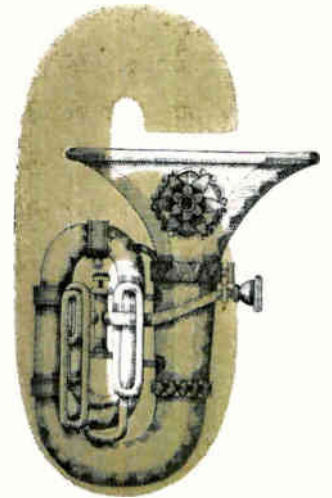

**AKG**

**D-12 Dynamic Microphone**

Directional type with cardioid characteristics. 40-15,000 cps  $\pm 3$  db. Front-to-back



ratio, 18 db over entire frequency range. Impedance 50-250 ohms. Sensitivity -77 db (1 volt/dyne/cm.<sup>2</sup>).....\$99.00

**D-19E Dynamic Microphone**

Cardioid type; multi-impedance; 5-pin Cannon connector; 40-16,000 cps  $\pm 3$  db.



Impedance 50, 200 ohm or Hi-Z. Sensitivity -75 db (1 volt/dyne/cm.<sup>2</sup>). With speech/music switch .....\$65.00

**D-24B Dynamic Microphone**

Directional type with cardioid characteristics. With bass roll-off switch. Frequency range 30-16,000 cps  $\pm 2.5$  db. Impedance 60 or 200 ohms. Sensitivity -75 db (1 volt/dyne/cm.<sup>2</sup>) .....\$150.00

**D-19C Dynamic Microphone**

Cardioid type 40-16,000 cps  $\pm 3$  db. Impedance 60 or 200 ohms. Sensitivity -75 db (1 volt/dyne/cm.<sup>2</sup>). With speech/



music switch .....\$58.00

**ALTEC LANSING**

**Model 681A Microphone**

General-purpose, moving-coil dynamic design; response 50-18,000 cps; output im-



pedance 150/250 or 20,000 ohms (specify impedance); output -55 dbm/10 dynes/cm.<sup>2</sup>; omnidirectional; 1 1/8" dia. at top, 7 1/8" long; dark green baked enamel and brushed chrome; comes complete with 15-foot cord .....\$46.50  
 Desk stand extra.....\$15.00  
 "On-off" switch kit.....\$8.25

**Model 682A Microphone**

Similar in design and style to Model 681A; response 45-20,000 cps; output impedance 30/50, 150/250, and 20,000 ohms (selectable by cable plug); two-tone baked enamel finish, black and dark green, dark brown and platinum, or brushed chrome; has sintered bronze filter for protection against moisture and blasting.....\$54.00

**Model 683A Microphone**

Similar in style to Model 681A; cardioid dynamic design; response 45-15,000 cps; 30/50, 150/250, and 20,000 ohms (selectable by cable plug); output -54 dbm/10 dynes/cm.<sup>2</sup>; front-to-back discrimination 20 db; same finishes available as for Model 682A; has sintered bronze filter for protection against moisture and blasting .....\$76.50

**AMERICAN MICROPHONE**

**Model D4L Microphone**

Dynamic type; response 60-12,000 cps; output level -52 db @ 50 ohms impedance; omni-directional; height 4"; 12 1/2' cable; low-impedance; rugged.....\$16.80  
 D4LS with slide switch.....\$18.60  
 D4LE with adapter for boom or gooseneck mounting .....\$19.71

**Model D4H Microphone**

Dynamic type; response 60-12,000 cps; output level -52 db @ 40,000 ohms; omnidirectional; height 4"; 12 1/2' single-conductor cable; high-impedance, rugged type .....\$18.60  
 D4HS with slide switch.....\$21.30  
 D4HE with adapter for boom or gooseneck mounting.....\$19.11

**Model D-10 Microphone**

Dynamic type; omnidirectional general purpose; plastic diaphragm; high or low impedance; frequency response 60-12,000 cps; output level is -57 db.....\$17.70

**Model D11 Microphone**

Omnidirectional, dynamic hand-held general-purpose type; 80-10,000 cps; push-to-talk switch; 2 3/8" dia. x 2" x 5"; includes 15' three-conductor shielded cable.  
 D11H high impedance .....\$21.60  
 D11-L 50 ohms .....\$21.60

**Model D-12 Microphone**

Dynamic type; compact 3 25/32" long; response 60-12,000 cps; output level -55 db @ high impedance; includes lavalier and accessories.  
 D12H high impedance .....\$35.70  
 D12L 50 ohms .....\$35.70  
 D12HE same as D12H with adapter for boom or gooseneck mounting .....\$36.21  
 D12LE same as D12L with adapter for boom or gooseneck mounting.....\$36.21

**Model D22 Microphone**

Dynamic type; frequency response 50 to 12,000 cps; omnidirectional; output level



-55 db at high impedance; impedance may be adjusted for either 50 ohms or high impedance; over-all height 8 1/4"; 25' single conductor cable.....\$59.70

# 6 Microphones

## Model D33 Microphone

Dynamic type; frequency response 40 to 15,000 cps; output level -55 db at 50 ohms impedance; impedance may be adjusted for either 50 ohms or 250 ohms; 18' 2-conductor cable; over-all height 8 1/4" .....\$78.00

## Model D44 Microphone

Dynamic type with shock-mount suspension for boom use; response 30-14,000 cps; output level -55 db @ 50 ohms impedance; omni-directional; height 6 3/4" .....\$141.00  
WS2A windscreen for D44 .....\$ 6.60

## Model D55 Microphone

All-purpose unidirectional dynamic design; 50-12,000 cps; impedance may be changed



to low or high; 7 1/2" long x 1 1/8" dia. ....\$51.00

## Model D76 Microphone

Cardioid dynamic design; professional version of Model D55; 40-15,000 cps; low impedance only.....\$117.00

## Model R331 Microphone

Ribbon type; frequency response 50 to 12,000 cps; bi-directional; output level



-60 db at high impedance; variable high-low impedance; height 6 1/2"; 25' single-conductor cable.

Model R331 .....\$84.00

## 206 Series Microphones

Ceramic all-purpose designs with clip-on stand and neck cord; high impedance type microphone.

B206 ceramic .....\$4.77  
B206S with on-off switch.....\$5.97  
B206E with adapter for boom or gooseneck mounting .....\$5.28

## B213S Microphones

Ceramic hand-held microphones; response 80-9000 cps; high-impedance; 5-foot coiled



cord; ceramic with d.p.s.t. push-to-talk switch .....\$10.05

## ASTATIC

### 988 "Vogue" Dynamic Microphone

Omnidirectional design with "pop-proof" and "blast-proof" diaphragm; insensitive



to moisture and temperature; convertible from hand to stand to lavalier use; detachable cable connector; response 40-17,000 cps; impedance selector for 50-150-250 ohms; output -56 db at 1 mw./10 dynes/cm.<sup>2</sup>; furnished complete with 20-foot cable, stand adapter, lavalier assembly; 9 11/32" h. x 1 9/32" dia.....\$150.00

### 888 "Tempo" Dynamic Microphone

Similar to Model 988 except response 50-15,000 cps; impedance selector for 50-200-



high-impedance; output -58 db. ....\$110.00

### 788 "Metro" Dynamic Microphone

Similar to Model 988 except response 60-13,000 cps; impedance 150 or high-imped-



ance; output -58 db; has built-in "on-off" switch .....\$79.50

### Model 77 Series Microphones

Dynamic cardioid design; front-to-back pickup differential 18 db; rugged and in-



sensitive to temperature and moisture; blast-proof diaphragm; essentially flat from 30-15,000 cps; impedance selector switch: high-impedance position (40,000 ohms), open circuit voltage -52 db @ 1 volt/dyne/cm.<sup>2</sup>; low-impedance position (30-50 ohms) power level into 50 ohms -52 db @ 1 mw./10 dynes/cm.<sup>2</sup>; medium-impedance position (150-250 ohms), -53 db.

Model 77 .....\$82.50  
Model 77L .....\$72.50  
Model G77 Complete with grip-to-talk desk stand, 8-foot cable.....\$97.45  
Model 77 (Gold finish).....\$92.50  
Model 77L (Gold finish).....\$82.50  
All "L" models furnished less "on-off" switch, cable, and adapter; intended for use with the company's Model G grip-to-talk desk stand.

## AUDIOTEX

### Model 30-900 Microphone

Designed for tape-recorder applications; comes complete with clip-on stand, 6-foot cable, RCA-type phono pin plug, and adapter for standard plug installations; response flat from 40-12,000 cps; high output .....\$16.50

## DYNACO

### Models 50 & 53 Microphones

Both models are ribbon; bidirectional; B & O manufactured; response  $\pm 2.5$  db 30-13,000 cps; output 56 db below 1 volt/ $\mu$ bar at high impedance or with matching transformer; 7/8" x 1 3/16"; switch provides music, close-talk, and off positions.  
Model 50 (50 ohms balanced only).....\$59.95  
Model 53 (with matching transformer for 50 and 250 ohms balanced, 40,000 ohms unbalanced) .....\$69.95  
Model SS-1 Stereo spacer & dual mount for 50 or 53 microphones .....\$14.95  
MT-1 matching transformer (50-50,000 ohms) .....\$14.95

### Model 200 Microphone

Dual-ribbon mike designed by B & O for stereo operation; bidirectional with figure-8



pattern; top section can be rotated through 100° with respect to lower section so optimum 90° angle or any point in between may be chosen; lower section includes phasing switch and another for music, normal operation and a close-talk position; response 30-13,000 cps  $\pm 2$  db; in "talk" position response is rolled off 3 db/octave below 1 kc.; impedance 150/200 ohms; sensitivity Gm = -156 db; 10" x 1 3/16" .....\$149.95  
Model 100 Mono version .....\$ 89.95  
MT-2 Matching transformer (dual-200 ohm to high-Z) .....\$ 24.95

## ELECTRO-VOICE

### Model 729 Ceramic Microphone

Cardioid design; wide-angle front pick-up; response 60-8000 cps; high-impedance; on-



off switch; output -60 db; 7 3/4" l. x 1 1/2" w. x 1 1/8" d.; single-conductor shielded 8 1/2 ft. cable; also available with relay operating switch and three-conductor (one shielded) cable.....\$24.50

### Model 654A Slim-Trim Broadcast

Dynamic omnidirectional; frequency response 50 to 16,000 cps; output -58 db; impedance 150 ohms; gray; 18 foot cable; size 7" x 1"; net weight 15 1/2 oz. ....\$100.00

### Model 664 Cardioid Microphone

Dynamic; unidirectional; frequency re-



sponse 40 to 15,000 cps; output -58 db; 150 ohm and high impedance; diaphragm shielded from dust; filter to minimize wind blast; on-off switch; pressure cast case; as-



sembly includes hinge; 16 foot cable; size 7 1/4" x 1 1/8"; weight 26 oz.  
 Chrome finish .....\$85.00  
 Model 664G Gold finish.....\$90.00

**Model 623 Slim Microphone**

Dynamic; omnidirectional; frequency response 60 to 12,000 cps; output -56 db;



high and low impedance; cast case; hinge head; on-off switch; built-in MC-4 connector 3/8"-27 thread; satin chrome; 16 foot cable; size 7 1/2" x 1 1/4"; weight 15 oz.  
 .....\$57.00

**Model 666 Super Cardioid**

Dynamic; unidirectional; for boom, stand, or hand use; frequency response 30 to 16,000 cps; output -58 db; impedance 150 ohms, taps for 50 and 250 ohms; variable



directivity increases working distance yet permits closeup without distortion; cast aluminum case; gray; 20 foot cable; built-in Cannon UA-3 connector; includes clamp-on stand mount with 3/8"-27 thread and 1/2" pipe thread adapter.....\$255.00

**Model 665 Cardioid Microphone**

Lower cost professional microphone incorporating same design features as Model 666; appearance similar to Model 664 .....\$150.00

**Model 655C Slim-Trim TV Dynamic**

Response 40-20,000 cps; output -58 db; can be used on stand, in hand, or on boom;



easily concealed in studio props; pop-proof grille; impedances 50, 150, 250 ohms; impedance easily changed; clamp-on stand mount includes 3/8"-27 thread and 1/2" pipe thread adapter; 10 1/2" long, 1" dia.; 20-foot cable .....\$200.00

**Model 641 Dynamic Mike**

Dynamic type; high output level; wide range response; for p.a., home recording, communications; integral on-off switch; response 70-10,000 cps; output level -57 db; omnidirectional; 16-foot cable; Hi-Z or balanced 150 ohms (matches standard low impedances) .....\$35.00

**Model 636 "Slimair" Dynamic**

For p.a., recording, and general use; response 60-13,000 cps; output -58 db;



pop-proof head; wide pickup range; on-off switch; satin chrome finish; tiltable head; Hi-Z or Lo-Z by changing one wire in connector; 16-foot cable; 10 1/4" long including stud; 1 1/8" max. dia.....\$72.50  
 Model 636G Gold finish.....\$77.50

**Model 715 "Century" Ceramic**

Use in any position (in hand, on table, on stand, or overhead); ceramic element;

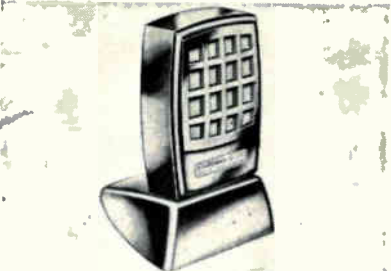

60-7000 cps; output -55 db; Hi-Z; 5-foot cable; nondirectional; rugged and lightweight; 3" x 2 3/16" x 1" .....\$13.00  
 Model 715S With switch.....\$15.00  
 Model 715SR With relay control switch .....\$17.50

**Model 805 Contact Mike**



For guitar, banjo, other stringed instruments; Hi-Z; sealed crystal; chrome finish; 15-foot cable.....\$20.00

**Model 644 "Sound Spot" Mike**

Combination cardioid & distributed front opening having better than 2.5 times the

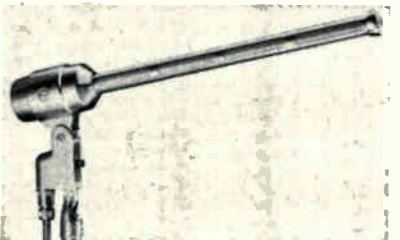

working distance of pressure-type microphone; 20 db cancellation rear & sides above 700 cps; cardioid pattern below 700 cps; response 40-10,000 cps; output -53 db; dual

high & low impedance selectable; 2 3/16" x 1 1/8" .....\$110.00

**Model 676 Cardioid Dynamic Mike**

Response 40-15,000 cps; output -58 db; 150 ohms or high impedance, changed in



cable connector; has 3-position switch which controls low-frequency attenuation to overcome rumble & feedback; 7 3/8" x 1 1/4" .....\$100.00

**Model 630 Dynamic Mike**

Response 60-11,000 cps; output -55 db; has "off-on" switch; available in high-im-



pedance or 150 ohms (matches 50-250 ohms); low impedance balanced to ground; 2" x 6 1/2" .....\$52.50

**Model 624 Dynamic Lavalier**

Response 100-7000 cps; output -56 db; features wire mesh head acoustically treated

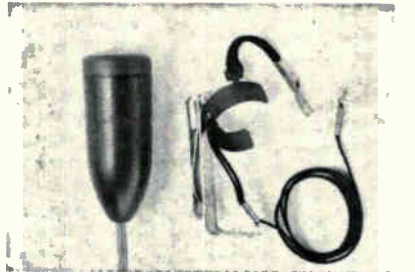

for wind & moisture protection; available in high impedance or 150 ohms; not balanced to ground; 3 3/8" x 1 1/8" .....\$42.50

**Model 615 "Century" Dynamic Mike**

Omnidirectional design; will withstand extreme temperatures, humidity, corrosion,

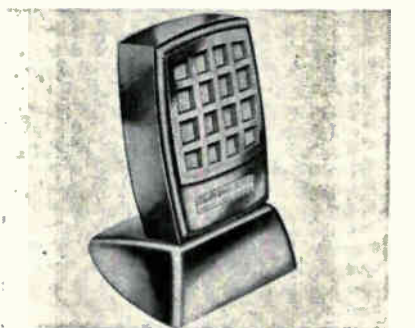

and shock; response 80-8000 cps; output -55 db; available in high- or low-impedance (50-250 ohms); low impedance not balanced to ground; 3" x 2 3/16" x 1" ..\$25.50

**Model 727 Slim Ceramic**

Similar in appearance to Model 729; withstands extremes of temperature and humidity; response 60-8000 cps; output -55

# 6 Microphones

db; high-impedance only; 5-foot cable; available with or without on-off switch; 7 3/4" x 1 3/8" x 1 1/2"; supplied with desk stand and floor stand coupler.....\$18.00  
Model 727SR With relay control switch .....\$20.00

## Model 712 Ceramic Mike

Low-cost ceramic unit; meets need for p.a., home recording, paging, general use; hand-



held; moisture-sealed ceramic; response 70-7000 cps; high output -55 db; Hi-Z; 3" x 2 1/4" x 1 3/8"; 5-foot cable.....\$7.50

## 502A Matching Transformer

For use where long cable runs are required. Designed for low-impedance microphones



(50, 150, 250 or 500 ohms) to 40,000 ohm amplifier input. 30-20,000 cps.....\$17.50

## Model 649B Microphone

Dynamic, miniaturized, rugged lavalier design. Response 100-9000 cps  $\pm$  5 db:

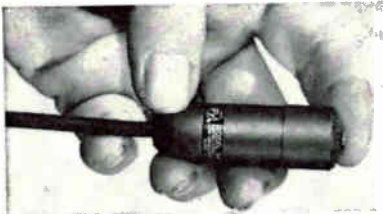

matches all low-impedance 50 through 250 ohms. Line balanced to grd. & phased. Sensitivity -155 db. Omnidirectional. Supplied with neck cord assembly & 30' 2-conductor shielded cable; 2 1/4" long x 3/4" dia. ....\$105.00

## Model 638 Microphone

Omnidirectional, dynamic design. Response 70-10,000 cps. Supplied either in 150 ohms



or Hi-Z. Output (150 ohms) -57 db (0 db = 1 mw./10 dynes/cm.<sup>2</sup>); (Hi-Z) -57 db (0 db = 1 v./dyne/cm.<sup>2</sup>). Sensi-

tivity approx. -152 db. Has 6' cable. 3 1/4" l. x 3 13/16" h. ....\$33.50

## Model 355 Windscreen

Designed for use with Models 655C, 654A, 636, 623 & 926. Reduces wind blast with-



out altering freq. response. Acts also as a protective device.....\$11.00

## Model 647A Microphone

Omnidirectional, dynamic lavalier design. Response 70-10,000 cps; Hi & Lo imped-



ance selected at cable. Sensitivity -155 db; output (Lo. imp.) -61 db (0 db = 1 mw./10 dynes/cm.<sup>2</sup>). Supplied with 18 ft. 3-conductor shielded cable, neck cord & belt clip; 3 3/4" long x 3/4" dia.....\$82.50

## Model 335A Blast Filter

Designed for use with Models 630, 635,

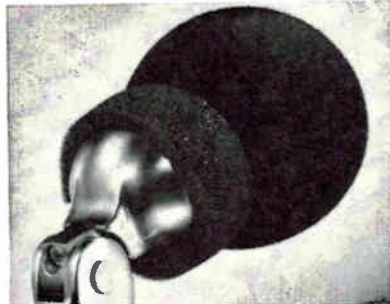

641, 638 & 634 microphones. Will not affect freq. response.....\$12.50

## Model 524A Windscreen

Designed for use with Models 664 & 666.



Also protects against dust, magnetic particles & mechanical shock.....\$12.00

## FARGRAM

### Parabolic Microphone



Reflector design for use with transistorized battery-operated tape recorders. Spun aluminum 24" reflector with sighting gunsight on microphone. Impedance 200 ohms; reflector depth 5"; wt. 5 lbs; at 100 ft. from 500-5000 cps sensitivity of mic. is increased 15 db with reflector. To be used with any heavy-duty camera tripod with pan-tilt head. Supplied with mic., reflector & gunsight, microphone holder.....\$89.50

## KNIGHT

### KN-4500 Dynamic Microphone

All directional pickup pattern; high impedance; output -55 db; response 60-12,000 cps; 10' cable; phone plug; 7 1/2" x 1 1/4"; includes desk stand.....\$24.75

## LAFAYETTE

### 99-4532 Stereo Dynamic Mike



Two separate dynamic mike elements within single housing; sw. for stereo or mono operation; omnidirectional pattern 90 degrees apart for full pickup within 360 degree arc; response 50-15,000 cps; essentially flat 80-10,000 cps; impedance 50,000 ohms .....\$17.95

## OLSON ELECTRONICS

### M-163 Crystal Microphone

Made in England; plastic case with fold-



away handle; output -50 db; response 40-6000 cps; six-foot shielded cable.....\$1.49

## PML

### EK-61 Condenser Microphone

Imported from Sweden; a super-miniature design (2 3/8" in height) supplied with separate power supply to be clipped to belt; omni-directional characteristics with Mylar-type diaphragm; output impedance 30/50, 150/200, 600, or Hi-Z; response 30-18,000 cps  $\pm$  3 db; sensitivity -50 db; S/N ratio -58 db @ 2000 cps; noise level 14 phons. ....\$99.50

Model EC-61 Cardioid sound pattern .....\$109.50  
Battery power supply.....\$39.50  
A.C. power supply, 117 v. operation .....\$49.50

## RCA

### 77-DX Polydirectional Microphone

Features uni-directional, bi-directional, or non-directional pickup patterns changed by a selector switch; three frequency response variations on the basic pickup patterns may also be obtained, thus nine different directional characteristics may be utilized; output impedance is factory connected for 250 ohms but may be reconnected for 30 to



150 ohms; effective output levels are -50 dbm in the bi-directional pattern, -53 dbm in the uni- and non-direction patterns (EIA ratings, -144 db, -147 db, and -150 db respectively); response 30-20,000 cps; hum level pickup -128 dbm; supplied with 30 feet of three-conductor shielded cable, less plug; 1 1/2" x 3 3/4" x 2 1/4" d. Satin chrome finish .....\$206.00  
Low-luster gray finish.....\$197.00

**BK-6B Dynamic Microphone**

Lightweight (23 oz.) microphone 2 9/16" x 1 5/16" in size; effective output level is -67



dbm (EIA rating, -158 db); response 60-15,000 cps; 250-ohm output impedance may be changed to 30 or 150 ohms by a change of cable connections; hum pickup is low (-112 dbm); supplied with 30' of three-conductor cable, less connector; has lanyard & fastener.....\$86.00

**SK-46 Velocity Microphone**

An economy ribbon design for indoor use; has good frequency response (40-15,000



cps) and bi-directional pickup characteristics; output impedance 200 ohms but may be reconnected to 15,000 ohms; effective output level is -58 dbm at 250 ohms (EIA rating, -150 db) or -60 dbm at 15,000 ohms; supplied with 25' of two-conductor cable, less connector.....\$49.50

**BK-1A Pressure Microphone**

Ideal for outdoor use; offers smooth response for both voice and music; provides uniform response from 50-15,000 cps; swivel mounting can be used to control directional characteristics; vertical position is



non-direction, the horizontal position is semi-direction; output impedance is 250 ohms, but 30 and 150 ohm connections are

# Who says a professional-grade, ribbon-type mike has to cost a small fortune?

Most audio engineers agree that microphones with ribbon-type generating elements give the best acoustic performance obtainable... the smoothest, most distortion-free response over the broadest frequency range.

Most ribbon-type mikes are therefore quite expensive... up in the hundreds of dollars.

But not the RCA SK-46. It gives you a frequency-response of 40 to 15,000 cps

...and it costs only **\$49.50\***

*What's so special about ribbon-type mikes?*

There are 7 basic types of microphone generating elements: ribbon, condenser, magnetic, dynamic, ceramic, crystal and carbon. RCA sells all 7, so we can be relatively impartial about the advantages of the ribbon type.

A typical ribbon element (special aluminum alloy foil 0.0001" thick) weighs only about 0.25 milligram—hundreds of times lighter than generating elements in, say, dynamic and condenser mikes. The ribbon, in fact, is as light as the air mass that moves it, which accounts for its exceptional sensitivity.

In fact, of all 7 types of generating elements, the ribbon-type element is superior in:

- ★ Smoothness of response
- ★ Breadth of frequency range
- ★ Immunity to shock and vibration
- ★ Adaptability to various impedances



RCA SK-46 ribbon-type microphone

- ★ Low hum pickup
  - ★ Immunity to temperature and humidity variations
- That's why most of them cost so much.

**But now you can get the remarkable RCA SK-46 bi-directional ribbon-type mike at Your Local Authorized RCA Microphone Distributor — For Only \$49.50\*.**

For full technical information—or the name and address of your nearest distributor—write: RCA Electronic Components and Devices, Dept. 451, 415 So. 5th St., Harrison, New Jersey.

\*Optional Distributor Resale Price

RCA Electronic Components and Devices, Harrison, N. J.



**The Most Trusted Name in Electronics**

# 6 Microphones

included; effective output level is -56 dbm (EIA rating, -48 db); hum pickup is below -112 dbm; supplied with 30' of three-conductor cable, less connector.....\$73.50

## SK-45B Talk-Back Microphone

Ideal for talk-back, cue, and p.a. use; dynamic microphone is essentially non-directional with a -56 db output level (EIA rating, -147 db) when connected for 150 to 200 ohm balanced output, and -58 db when connected for 15,000 ohms output; response 70-12,000 cps; supplied with 25' of cable, less connector.....\$45.00

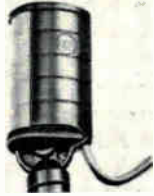

SK-39A Utility Microphone

Inexpensive dynamic microphone for cue and talk-back applications; plastic diaphragm is impervious to moisture and rain; response 60-10,000 cps; output level -55 dbm (EIA rating, -150 db); can be used with amplifiers having 150-250 ohm input; 15 oz.; supplied with 25' two-conductor cable. ....\$23.40



SK-11A Velocity Microphone

General-purpose ribbon design with bi-directional characteristics; response 20-20,000 cps; effective output level -56 dbm @ 1000 cps (EIA rating, -147 db); output can be connected for 30, 150, and 250 ohm operation; three-position switch permits selection of desired frequency ranges for voice and music.....\$131.25



SK-5B Uni-Axial Microphone

Ribbon instrument designed for high noise areas; maximum sensitivity is in the major



mechanical axis producing an extremely directional cardioid pattern; response 30-20,000 cps; effective output level -56 dbm (EIA rating, -150 db); output is connected for 250 ohms but may be changed to 30 or 150 ohms; supplied with 30' of three-conductor cable, less connector; windscreen available for outdoor use.....\$146.50

## RESLO

### CD Dynamic Microphone

Cardioid characteristics; ideally suited for general audio recording; has flexible stem for head orientation; front-to-rear discrimination of 10 db is achieved at mid-frequencies; supplied with optional perspex ring baffle which adds "presence" around 5 kc. ( $\pm 3$  db); response 100-10,000 cps  $\pm 5$  db; sensitivity 49 db below 1 v./dyne/cm<sup>2</sup> @ 40,000 ohms.  
Model CDM 250/600 ohms.....\$99.95  
Model CDH 30/50 ohms & Hi-Z.....\$99.95

### Model V.M.C. Microphone

Dynamic design for rugged voice applications; response 100-15,000 cps  $\pm 5$  db with peak at 5000 cps for maximum speech presence; 15 ohms; with "on-off" switch..\$79.95

### Type CR Ribbon Microphone

Cardioid characteristics; response 60 cps (-5 db) to 16,000 cps (+ 4 db); cardioid response 15-20 db; front-to-back discrimination over 1800-12,500 cps (30 db @ 5000-6000 cps); available with either 250/600 ohm or 30/50 ohm/Hi-Z impedances.....\$99.95

### Type RB Miniature Ribbon Mic

For general recording purposes; response 30-16,000 cps  $\pm 3$  db; features ability to fit alternative combination of acoustic "correction" pads to alter response characteristics; has figure-8 pickup pattern; sensitivity 58 db below 1 v./dyne/cm.<sup>2</sup> @ 40,000 ohms; available in either 250/600 ohm or 50 ohm/Hi-Z impedances.....\$99.95

### Type PR Ribbon Microphone

Designed for tape recorder use; plastic foam acoustic damping pads (removable) are incorporated for close speaking and to give reduction in high-frequency rear pickup; response 100-10,000 cps  $\pm 5$  db; has modified figure-8 response with pads fitted; sensitivity 60 db below 1 v./dyne/cm.<sup>2</sup> @ 40,000 ohms; available in either 250/600 ohm or 30/50 ohm/Hi-Z impedances.....\$89.95

## SHURE

### Model 315 Gradient Microphone

Ribbon type; bi-directional; frequency response 50 to 12,000 cps; output -59.5 db



at 30-50 ohms; -60 db at 150-250 ohms, -57 db at high impedance; 3-position impedance switch; Alnico V magnet; die-cast zinc case; satin chrome finish; self-adjust swivel;  $\frac{3}{8}$ "-27 thread; Amphenol MC3M connector equivalent; 20 foot 2-conductor shielded cable; size 6" x 1  $\frac{1}{2}$ " x 1  $\frac{1}{8}$ "; wt. 1 lb., shpg., 3  $\frac{1}{4}$  lbs.  
.....\$89.50  
Model 315S with switch.....\$91.50

### Model 55SW "Unidyne" Microphone

Dynamic type; uni-directional; frequency response 50 to 15,000 cps; output: -54 db



at 35-50 ohms, -55 at 150-250 ohms; -57 at 35,000 ohms; 3-position impedance switch; Alnico V magnet; die-cast zinc case, satin chrome finish; Amphenol MC3M connector equivalent; self-adjust swivel;  $\frac{3}{8}$ "-27 thread; on/off switch; 20 foot 2-conductor shielded cable; size 7  $\frac{3}{8}$ " x 2  $\frac{1}{4}$ " x 3  $\frac{1}{16}$ "; wt. 3  $\frac{1}{8}$  lbs., shpg. 4  $\frac{1}{2}$  lbs.  
.....\$85.00  
Model 55S without switch.....\$83.00

### Model 330 "Uni-Ron" Microphone

Ribbon type; uni-directional; frequency output: -60 db at 50 ohms, -59 db at



150 and 250 ohms; 3-position impedance switch; Alnico V magnet; die-cast zinc case; satin chrome finish; self-adjust swivel;  $\frac{3}{8}$ "-27 thread; live rubber shock mount; Cannon XL-3-11 connector; 20 foot 2-conductor shielded cable; size 3  $\frac{3}{4}$ " x 1  $\frac{1}{4}$ " x 1  $\frac{1}{8}$ "; wt. 1  $\frac{1}{2}$  lbs., shpg., 4 lbs.  
.....\$120.00

### 430 "Commando" Microphone

Controlled magnetic type; omni-directional; frequency response 60 to 10,000



cps; output: Lo-Z, -54 db; Hi-Z, -55 db; changeable pin jacks give choice of 2 impedances: 150-250 ohms or high impedance; polystyrene and die-cast zinc case; satin-chrome and gray finish; A25 type swivel adapter;  $\frac{3}{8}$ "-27 thread; Amphenol MC2M connector; 15 foot 2-conductor shielded cable; press-to-talk switch, locking plate furnished; size 6  $\frac{1}{2}$ " long; top diameter 1  $\frac{1}{4}$ "; handle  $\frac{3}{4}$ " .....\$38.50

### Model 300 Bi-directional Microphone

Multi-impedance ribbon design with special anti-breath filter; response 40-15,000 cps  $\pm 2 \frac{1}{2}$  db; output 30-50 ohms -59 db, 150-250 ohms -60 db; high impedance -57 db; equipped with multi-impedance switch for 30-50 ohms, 150-250



150 ohms; effective output levels are -50 dbm in the bi-directional pattern, -53 dbm in the uni- and non-direction patterns (EIA ratings, -144 db, -147 db, and -150 db respectively); response 30-20,000 cps; hum level pickup -128 dbm; supplied with 30 feet of three-conductor shielded cable, less plug; 1 1/2" x 3 3/4" x 2 1/4" d. Satin chrome finish .....\$206.00  
Low-luster gray finish.....\$197.00

**BK-6B Dynamic Microphone**

Lightweight (23 oz.) microphone 2 9/16" x 1 5/16" in size; effective output level is -67



dbm (EIA rating, -158 db); response 60-15,000 cps; 250-ohm output impedance may be changed to 30 or 150 ohms by a change of cable connections; hum pickup is low (-112 dbm); supplied with 30' of three-conductor cable, less connector; has lanyard & fastener.....\$86.00

**SK-46 Velocity Microphone**

An economy ribbon design for indoor use; has good frequency response (40-15,000



cps) and bi-directional pickup characteristics; output impedance 200 ohms but may be reconnected to 15,000 ohms; effective output level is -58 dbm at 250 ohms (EIA rating, -150 db) or -60 dbm at 15,000 ohms; supplied with 25' of two-conductor cable, less connector.....\$49.50

**BK-1A Pressure Microphone**

Ideal for outdoor use; offers smooth response for both voice and music; provides uniform response from 50-15,000 cps; swivel mounting can be used to control directional characteristics; vertical position is



non-direction, the horizontal position is semi-direction; output impedance is 250 ohms, but 30 and 150 ohm connections are

# Who says a professional-grade, ribbon-type mike has to cost a small fortune?

Most audio engineers agree that microphones with ribbon-type generating elements give the best acoustic performance obtainable... the smoothest, most distortion-free response over the broadest frequency range.

Most ribbon-type mikes are therefore quite expensive... up in the hundreds of dollars.

But not the RCA SK-46. It gives you a frequency-response of 40 to 15,000 cps

...and it costs only **\$49.50\***

*What's so special about ribbon-type mikes?*

There are 7 basic types of microphone generating elements: ribbon, condenser, magnetic, dynamic, ceramic, crystal and carbon. RCA sells all 7, so we can be relatively impartial about the advantages of the ribbon type.

A typical ribbon element (special aluminum alloy foil 0.0001" thick) weighs only about 0.25 milligram—hundreds of times lighter than generating elements in, say, dynamic and condenser mikes. The ribbon, in fact, is as light as the air mass that moves it, which accounts for its exceptional sensitivity.

In fact, of all 7 types of generating elements, the ribbon-type element is superior in:

- ★ Smoothness of response
- ★ Breadth of frequency range
- ★ Immunity to shock and vibration
- ★ Adaptability to various impedances



RCA SK-46 ribbon-type microphone

- ★ Low hum pickup
- ★ Immunity to temperature and humidity variations

That's why most of them cost so much.

**But now you can get the remarkable RCA SK-46 bi-directional ribbon-type mike at Your Local Authorized RCA Microphone Distributor — For Only \$49.50\*.**

For full technical information—or the name and address of your nearest distributor—write: RCA Electronic Components and Devices, Dept. 451, 415 So. 5th St., Harrison, New Jersey.

\*Optional Distributor Resale Price

RCA Electronic Components and Devices, Harrison, N. J.



**The Most Trusted Name in Electronics**

# 6 Microphones

included; effective output level is -56 dbm (EIA rating, -48 db); hum pickup is below -112 dbm; supplied with 30' of three-conductor cable, less connector.....\$73.50

## SK-45B Talk-Back Microphone

Ideal for talk-back, cue, and p.a. use; dynamic microphone is essentially non-directional with a -56 db output level (EIA rating, -147 db) when connected for 150 to 200 ohm balanced output, and -58 db when connected for 15,000 ohms output; response 70-12,000 cps; supplied with 25' of cable, less connector.....\$45.00

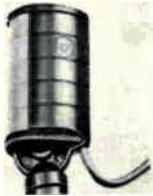

SK-39A Utility Microphone

## SK-39A Utility Microphone

Inexpensive dynamic microphone for cue and talk-back applications; plastic dia-



phragm is impervious to moisture and rain; response 60-10,000 cps; output level -55 dbm (EIA rating, -150 db); can be used with amplifiers having 150-250 ohm input; 15 oz.; supplied with 25' two-conductor cable. ....\$23.40

## BK-11A Velocity Microphone

General-purpose ribbon design with bi-directional characteristics; response 20-20,000



cps; effective output level -56 dbm @ 1000 cps (EIA rating, -147 db); output can be connected for 30, 150, and 250 ohm operation; three-position switch permits selection of desired frequency ranges for voice and music.....\$131.25

## BK-5B Uni-Axial Microphone



Ribbon instrument designed for high noise areas; maximum sensitivity is in the major

mechanical axis producing an extremely directional cardioid pattern; response 30-20,000 cps; effective output level -56 dbm (EIA rating, -150 db); output is connected for 250 ohms but may be changed to 30 or 150 ohms; supplied with 30' of three-conductor cable, less connector; windscreen available for outdoor use.....\$146.50

## RESLO

### CD Dynamic Microphone

Cardioid characteristics; ideally suited for general audio recording; has flexible stem for head orientation; front-to-rear discrimination of 10 db is achieved at mid-frequencies; supplied with optional perspex ring baffle which adds "presence" around 5 kc. ( $\pm 3$  db); response 100-10,000 cps  $\pm 5$  db; sensitivity 49 db below 1 v./dyne/cm<sup>2</sup> @ 40,000 ohms.  
Model CDM 250/600 ohms.....\$99.95  
Model CDH 30/50 ohms & Hi-Z.....\$99.95

### Model V.M.C. Microphone

Dynamic design for rugged voice applications; response 100-15,000 cps  $\pm 5$  db with peak at 5000 cps for maximum speech presence; 15 ohms; with "on-off" switch..\$79.95

### Type CR Ribbon Microphone

Cardioid characteristics; response 60 cps (-5 db) to 16,000 cps (+4 db); cardioid response 15-20 db; front-to-back discrimination over 1800-12,500 cps (30 db @ 5000-6000 cps); available with either 250/600 ohm or 30/50 ohm/Hi-Z impedances.....\$99.95

### Type RB Miniature Ribbon Mic

For general recording purposes; response 30-16,000 cps  $\pm 3$  db; features ability to fit alternative combination of acoustic "correction" pads to alter response characteristics; has figure-8 pickup pattern; sensitivity 58 db below 1 v./dyne/cm<sup>2</sup> @ 40,000 ohms; available in either 250/600 ohm or 50 ohm/Hi-Z impedances.....\$99.95

### Type PR Ribbon Microphone

Designed for tape recorder use; plastic foam acoustic damping pads (removable) are incorporated for close speaking and to give reduction in high-frequency rear pickup; response 100-10,000 cps  $\pm 5$  db; has modified figure-8 response with pads fitted; sensitivity 60 db below 1 v./dyne/cm<sup>2</sup> @ 40,000 ohms; available in either 250/600 ohm or 30/50 ohm/Hi-Z impedances.....\$89.95

## SHURE

### Model 315 Gradient Microphone

Ribbon type; bi-directional; frequency response 50 to 12,000 cps; output -59.5 db



at 30-50 ohms; -60 db at 150-250 ohms, -57 db at high impedance; 3-position impedance switch; Alnico V magnet; die-cast zinc case; satin chrome finish; self-adjust swivel;  $\frac{3}{8}$ "-27 thread; Amphenol MC3M connector equivalent; 20 foot 2-conductor shielded cable; size 6" x 1 $\frac{1}{2}$ " x 1 $\frac{1}{8}$ "; wt. 1 lb., shpg., 3 $\frac{1}{4}$  lbs. ....\$89.50  
Model 315S with switch.....\$91.50

### Model 55SW "Unidyne" Microphone

Dynamic type; uni-directional; frequency response 50 to 15,000 cps; output: -54 db



at 35-50 ohms, -55 at 150-250 ohms; -57 at 35,000 ohms; 3-position impedance switch; Alnico V magnet; die-cast zinc case, satin chrome finish; Amphenol MC3M connector equivalent; self-adjust swivel;  $\frac{3}{8}$ "-27 thread; on/off switch; 20 foot 2-conductor shielded cable; size 7 $\frac{3}{8}$ " x 2 $\frac{1}{4}$ " x 3 $\frac{1}{16}$ "; wt. 3 $\frac{1}{8}$  lbs., shpg. 4 $\frac{1}{2}$  lbs. ....\$85.00  
Model 55S without switch.....\$83.00

### Model 330 "Uni-Ron" Microphone

Ribbon type; uni-directional; frequency output: -60 db at 50 ohms, -59 db at



150 and 250 ohms; 3-position impedance switch; Alnico V magnet; die-cast zinc case; satin chrome finish; self-adjust swivel;  $\frac{3}{8}$ "-27 thread; live rubber shock mount; Cannon XL-3-11 connector; 20 foot 2-conductor shielded cable; size 3 $\frac{3}{4}$ " x 1 $\frac{1}{4}$ " x 1 $\frac{1}{8}$ "; wt. 1 $\frac{1}{2}$  lbs., shpg., 4 lbs. ....\$120.00

### 430 "Commando" Microphone

Controlled magnetic type; omni-directional; frequency response 60 to 10,000



cps; output: Lo-Z, -54 db; Hi-Z, -55 db; changeable pin jacks give choice of 2 impedances: 150-250 ohms or high impedance; polystyrene and die-cast zinc case; satin-chrome and gray finish; A25 type swivel adapter;  $\frac{3}{8}$ "-27 thread; Amphenol MC2M connector; 15 foot 2-conductor shielded cable; press-to-talk switch, locking plate furnished; size 6 $\frac{1}{2}$ " long; top diameter 1 $\frac{1}{4}$ "; handle  $\frac{3}{4}$ " .....\$38.50

### Model 300 Bi-directional Microphone

Multi-impedance ribbon design with special anti-breath filter; response 40-15,000 cps  $\pm 2\frac{1}{2}$  db; output 30-50 ohms -59 db, 150-250 ohms -60 db; high impedance -57 db; equipped with multi-impedance switch for 30-50 ohms, 150-250



ohms, and 35,000 ohms; equally sensitive front and rear with sides down 15 to 20 db; has shock mounting; supplied with 20-foot cable and switch to adjust frequency characteristics; 6" h. x 1<sup>1</sup>/<sub>16</sub>" x 2<sup>1</sup>/<sub>16</sub>" d. ....\$150.00

### 333 Uni-directional Microphone

Ribbon design; response 30-15,000 cps  $\pm$  2<sup>1</sup>/<sub>2</sub> db; output 50 ohm -60 db, 150 ohm



-59 db, 250 ohm -59 db; response at rear down 12-20 db; multi-impedance switch and adjustment for frequency characteristics; shock mounted; supplied with 20-foot cable; 7<sup>5</sup>/<sub>32</sub>" h. x 1<sup>1</sup>/<sub>8</sub>" w. x 1<sup>1</sup>/<sub>8</sub>" d. ....\$250.00

### 540S "Sonodyne II" Microphone

Dynamic type; uni-directional; response 60-10,000 cps (provisions for altering re-



sponse to increase voice intelligibility); output: -57 db at 50-250 ohms, -52.5 db at high impedance; adjusts for high or low impedance; modern die-cast zinc and Armo-Dur case; satin chrome and black finish; self-adjusting "lifetime" swivel; 15-foot, 2-conductor shielded cable; 6-3/32" x 1-21/32" x 2-9/16".....\$49.95

### Model 245 "Uniplex" Microphone

Ceramic type; uni-directional; response 50-7000 cps; output -59 db; high imped-



ance; die-cast zinc case; includes swivel adapter; 15-foot single-conductor shielded cable; 4<sup>3</sup>/<sub>4</sub>" x 1<sup>1</sup>/<sub>8</sub>"; wt. <sup>3</sup>/<sub>8</sub> lb. ....\$35.00  
Model 245S (with "on-off" switch)..\$37.00

### 575S "Versadyne" Microphone

Dynamic type; omni-directional; response 40-15,000 cps; output: high impedance



-59 db, low impedance -62 db; choice of high or low impedance versions; black Armo-Dur body with satin anodized cap and stainless steel grille; furnished with special stand adapter; on-off switch; attached 7-foot single-conductor shielded cable; 4<sup>3</sup>/<sub>4</sub>" x 1<sup>1</sup>/<sub>4</sub>".

Model 575S (high impedance).....\$24.00

Model 575SB (low impedance).....\$21.00

Model 275S "Versaplex" (ceramic version) .....\$15.00

### 578 Omnidyne Ultra-Slim Probe

Designed as a dynamic omnidirectional type p.a. microphone; response 50-17,000 cps;



output: -59 db high impedance, -60 db low impedance; built-in wire mesh "pop" filter reduces breath noises; dual impedance (200 ohms & high); <sup>3</sup>/<sub>8</sub>" dia., 7<sup>3</sup>/<sub>8</sub>" over-all length; complete with "on-off" switch and special slip-in swivel stand adapter; available in matched pairs for stereo recording (matching to  $\pm$  1 db in level and  $\pm$  1<sup>1</sup>/<sub>2</sub> db in frequency response).....\$82.50

Model 578S. As above, but mounted on permanent swivel base, with Cannon XL3-11 type cable connector.....\$90.00

### Model 570 Lavalier Microphone

Miniature size professional-quality dynamic microphone designed for lavalier use; fea-

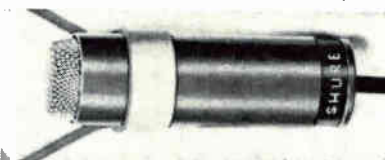

tures special "shaped" response; output -59 db; reduces pickup of clothing and cable noise; lightweight, flexible, 30' microphone cable attached; response 50-12,000 cps with rising response to 6000 cps; impedance 150 ohms to match low-impedance inputs; omnidirectional, <sup>3</sup>/<sub>8</sub>" dia. x 2<sup>1</sup>/<sub>2</sub>" over-all length; net weight 2 oz.....\$95.00  
Model 570S. Similar to above, but with on/off sw. 5<sup>3</sup>/<sub>32</sub>" long by <sup>3</sup>/<sub>8</sub>" dia.....\$105.00

### Model 561 Dynamic Microphone

Compact, tamper-proof dynamic microphone for direct mounting on flexible gooseneck or fixed pipe to conceal and protect cable; extremely rugged, dynamic cartridge; response 40-10,000 cps, rising characteristics to 4500 cps; output -56 db; dual impedance 150 & 250 ohms; 2<sup>1</sup>/<sub>4</sub>" long x 1<sup>2</sup>/<sub>64</sub>" dia.; 5 ounces.....\$32.50

### 576 Omnidirectional Dynamic Mike

Dynamic probe microphone featuring wide-range response for voice & music; ultra-slim



<sup>3</sup>/<sub>8</sub>" dia. x 8<sup>1</sup>/<sub>8</sub>" long; response 40-29,000 cps; dual impedance 50 & 150 ohms; output: -60 db; complete with slip-in swivel adapter that permits tilting microphone 90° from vertical to horizontal; also ideal as hand-held mic.; available in matched pairs for stereo, broadcasting and recording .....\$175.00

### Model 550S "Probe-Dyne" Microphone

Rugged, omnidirectional, dynamic design. Response 40-15,000 cps; output 57.5 db for low imp. & 58.5 db for high imp.; dual impedance, choice of 50-250 ohms & high; complete with on/off sw., swivel & 18' cable.

Chrome finish.....\$69.00

Gold finish.....\$79.00

### Model 545 "Unidyne III" Microphone

Dynamic type; cardioid; frequency response 15-15,000 cps; output -57 db



low level, -55 db high level; dual impedance; 18' three-conductor shielded cable; 6" x 2" .....\$85.00

Model 545S "Unidyne III"; as shown above, but mounted on permanent swivel base with on/off switch.....\$89.95

### Model 710 Crystal Microphone

Hand-held for voice frequencies; response 60-9000 cps; output 50 db; high impedance; semi-directional.

Model 710A.....\$12.00

Model 710S (with switch).....\$14.00

## SONOTONE

### Model CM-10A "Ceramik"

Ceramic microphone; frequency response 50 to over 11,000 cps  $\pm$  2 db; sensitivity 56 db below 1.0 volt per microbar; omnidirectional; high impedance; includes 7 feet of shielded cable with phone plug; does not include stand; 5<sup>1</sup>/<sub>8</sub>" x 1<sup>1</sup>/<sub>16</sub>" diameter at grille.....\$17.50

Model CM-11A: for use where greater sensitivity is desired. Specification same as for model CM-10A except: over-all frequency response, 80 to 9000 cps  $\pm$  2 db. Sensitivity 53 db below 1.0 volt per microbar .....\$17.50

Model CMS-10 mike stand: table and stored use .....\$5.00

### Model CM-40 & CMO41 Microphones

Ceramic microphone in plastic case; equipped with swing-type stand; -50 db

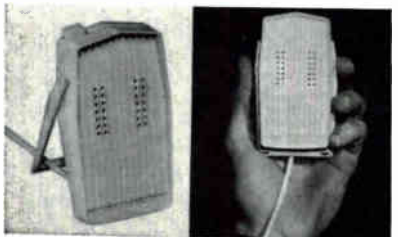

output; response 40-8000 cps; 7-foot, 2-conductor cable.

Model CM-40 without push-to-talk switch .....\$ 9.90

Model CM-41 with push-to-talk switch .....\$11.90

# 6 Microphones

## Model CM-12A Microphone

Ceramic microphone; low impedance output includes transformer; 150 ohms impedance; -63.5 db output; frequency response to 8000 cps; push-to-talk button; chrome-finished table stand with swivel mount furnished at extra cost.....\$29.50  
Table stand .....\$ 5.00

## Model CMT-10A or CMT-11A Matched Twin Microphones

For stereo tape use; ceramic type; acoustically matched to 2 db; Model CMT-10A has frequency response 50 to over 11,000 cps; Model CMT-11A has frequency response 80-9000 cps; Model CMT-10A output level -56 db.....\$35.50 pair

## CM-1018 Microphone

Low-impedance ceramic microphone for taping and communications applications; response 50-10,000 cps; sensitivity -56 db; impedance 500k (usable to 250k) .....\$18.50

## CM-1050WR Microphone

Wide-range, low-impedance microphone, for voice and music applications; response 50-10,000 cps; sensitivity -58 db; impedance 250k although usable down to 33k .....\$18.50

## CM-1050SR Microphone

Speech range, low-impedance microphone, designed for speech applications; response 170-9500 cps; sensitivity -62 db; impedance 33k although usable down to 10k .....\$18.50

## CMT-1050WR Matched Twin Microphones

Matched twins—low-impedance ceramic microphones designed for music and speech taping in stereo; acoustically matched to ± 2 db; response 50-10,000 cps; sensitivity -56 db; impedance 250k (usable to 33k) .....\$37.50

## CMC-1050WR Microphone

Wide-range, low-impedance ceramic microphone with matching stand; response 50-10,000 cps; sensitivity -58 db; impedance 250k (usable to 33k).....\$23.50

## SONY

### F-81 Dynamic Microphone

Same as Model F-87 except has smoother response .....\$ 29.50

### F-32 Dynamic Microphone

Has omni-directional pattern & bass cut switch; with switch in "music" position, response is essentially flat; with switch in "voice" position, response is attenuated 8 db at 50 cps & 60 db at 100 cps.....\$ 27.50

### F-75 Dynamic Telemicrophone

Highly directional design with transistor monitoring amp built into pistol grip. A 3-pos. sw. permits low-freq. attenuation.



Response 30-14,000 cps; impedance 150, 250, and 10 kohms, balanced or unbalanced. Complete with one 18" sound probe for up to 75' pickup, one 34" sound probe for 150' pickup, headset & carrying case .....\$395.00

### F-91 Omnidirectional Mic

Dynamic design featuring switch-selected 150, 250, or 10 kohms impedance, balanced or unbalanced. Response 40-20,000 cps. Output -58 db. Complete with desk stand, floor stand holder & case.....\$149.50

### F-113 Cardioid Mic

Dynamic design featuring switch-selected 150, 250, or 10 kohms impedance, balanced or unbalanced. Response 30-16,000 cps, output -57 db. Complete with desk stand, floor stand holder, windscreens & case .....\$249.50

### F-96 Dynamic Microphone



Wide-range, high-impedance; features thin tapered design .....\$ 17.50

### F-87 Dynamic Microphone

High impedance with cardioid directional characteristics; has built-in table stand &



floor-stand adapter insert.....\$ 22.50

## TURNER

### Model 141-11 Microphone

Lightweight crystal model; ideal for tape recorder use; chrome finish; for use in

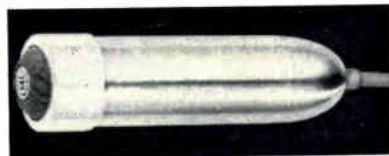

hand, on stand, or as lavalier mic; response 60-10,000 cps; output level -52 db; 6' single-conductor cable; molded phone plug and phone plug adapter; accessories extra.....\$ 9.00  
L14CH Lavalier assembly.....\$ 3.60  
144-CH Desk stand.....\$ 3.30

### Model 304C Ceramic Microphone

Supplied complete with desk stand, stand adapter, lavalier clip, 12' single-shielded



conductor; response 60-10,000 cps; output level -60 db.....List \$16.50

### Model 401 Dynamic Microphone

Omnidirectional design; high-frequency response adjustable from 20,000 cps down to



10,000 cps and low end from 40 to 160 cps; has neutral blue-gray finish with 20' three-conductor shielded cable; choice of high or 150-ohm impedance; 10 1/2" x 1"; output level -60 db at high impedance .....\$75.00

Model 402 Same as 401 but with shorting-type on-off switch.....\$78.00  
Model 4022 Matching desk stand.....\$ 4.80

### Model 607 & 608 Microphone

Response 60-8500 cps; output level -55 db; high impedance.....\$ 8.00  
Model 608 Same as Model 607 except output level -45 db.....\$ 4.80

### Model 707 Microphone

Small tape recorder microphone in satin-chrome finish, die-cast case with 6' cable; for use as hand or desk unit; response 60-10,000 cps; output -54 db.....\$ 7.50

### Model 403 Dynamic Microphone

Omnidirectional design; response 50-13,000 cps; output level -60 db; choice of 150 ohms or high impedance; has 20' three-conductor shielded cable with Cannon connector; available in silver or gold....\$48.00  
Model 404 Same as Model 403 but with on-off switch.....\$51.00

### Model 220A Microphone

Dynamic adjustable lavalier microphone designed for AM, FM, and TV broadcast use;



combination output impedance of 50 or 200 ohms selected at terminal end of cable; response 60-20,000 cps; output -90 db at 50 ohms; has 25' cable.....\$75.00

### Model 500 Dynamic Microphone

Cardioid design; response 40-15,000 cps; output -55 db; high or 150 ohm imped-

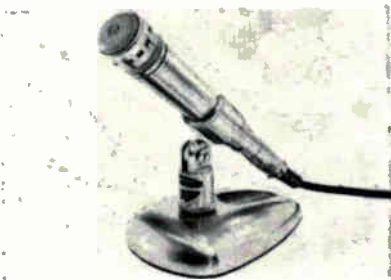

ance, selected at cable end; 20' cable.  
.....List \$84.00  
Model S-500 with switch.....List \$87.50  
Model C-7 stand.....List \$ 9.50

### Model 58 & 58A Lavalier Microphone

Dynamic type with essentially non-directional pickup pattern; designed for use



where freedom of movement is required; weighs 3½ oz., 4" long.

Model 58 High or 150 ohms, selected at end of cable; output level -60 db with high impedance; response 60-13,000 cps for high impedance & 60-18,000 cps for low impedance; 3-conductor, 25' shielded cable .....\$34.20

Model 58A 50 or 200 ohm impedance selected at end of cable; response 60-18,000 cps; 3-conductor, 25' shielded cable .....\$34.20

### Model 95D Microphone

Dynamic p.a. microphone; available with "on-off" switch; complete with 20-foot



cable; response 100-10,000 cps; output -58 db; choice of 50, 200 or high ohms .....\$22.50

### Model 500-04 Microphone

Matched cardioid dynamic microphone set for stereo or mono recording. Available in satin chrome finish or Roman gold, with phone plugs; response 40-15,000 cps. Choice of Hi or 150 ohms impedance. Output level -55 db; Has special wind screens for out-of-doors recording. Per set .....\$99.50

### Model 907 & 908 Microphone

Economy unit for tape recorders; durable polystyrene; hand or desk use; weighted to avoid tipping; ceramic model (907) for use where heat and humidity are problems; Model 908 response 60-8500 cps; output level -45 db; high impedance; Model 907 response 60-8500 cps; output level -55 db; high impedance design. ....\$ 4.80

### Model 80 on C-4 Stand

For home recording, paging, amateur use; crystal microphone; 7-foot cable supplied:



response 80-7000 cps; output -54 db; high impedance .....\$ 9.57  
Matching C-4 stand .....\$ 3.90

## UNIVERSITY

### Model 1000 Cardioid Microphone

Variable impedance, dynamic design. Response 30-16,000 cps; 50,200, or 20,000 ohms impedance; sensitivity -147 db; output level 50 & 200 ohms; -54 db/1 mw./10 dynes/cm.<sup>2</sup>; 20,000 ohms 17 mv.



/10 dynes/cm.<sup>2</sup>; hum reference -120 db /001 gauss; 1½" dia.; shock mounting with stand adapter.....\$81.00  
Model 1040 shock mtg. with switch & stand adapter.....\$87.00  
Model 1050 shock mtg. with switch, swivel & stand adapter.....\$91.20  
Model 1100 with stand adapter.....\$74.40  
Model 1140 with switch & stand adapter .....\$81.72  
Model 1150 with switch, swivel & stand adapter .....\$85.80

### Model 2000 Omnidirectional Microphone

Variable impedance, dynamic design. Response 50-14,000 cps; 50 or 20,000 ohms;



sensitivity -143 db; output level 50 ohms: 50 db/1mw./10 dynes/cm.<sup>2</sup>; 20,000 ohms 28 mv./10 dynes/cm.<sup>2</sup>; hum reference -120 db/001 gauss; 1¾" dia. For home recording. With stand adapter.....\$23.10

### Model 8000 Cardioid Microphone

Variable impedance, dynamic design. Shock mounted for home recording. Response



70-15,000 cps; 30/50-20,000 ohms; sensitivity -154 db; output level 50 ohms: 60/1 mw./10 microbar, 20,000 ohms 8.5 mw./10 microbar; 1¾" dia.; with stand adapter .....\$29.95

### Model 2140 Omnidirectional Microphone

Variable impedance, dynamic design. Response 30-20,000 cps; imp. 50, 200, or



20,000 ohms; sensitivity -148 db; output level 50 & 200 ohms: -55 db/1 mw./10 dynes/cm.<sup>2</sup>; 20,000 ohms 16 mv./10 dynes/cm.<sup>2</sup>; hum reference -120 db/001 gauss. 1½" dia.; with sw. & stand adapter .....\$45.36  
Model 2150 with switch, swivel & stand adapter .....\$46.74  
Model 2200 shock mtg.....\$43.74  
Model 2240 shock mtg. with sw.....\$49.80  
Model 2250 shock mtg. with sw., swivel & stand adapter.....\$51.18  
Model 4040 50-20,000 cps with sw. & stand adapter.....\$63.64  
Model 4050 50-20,000 cps with sw., swivel & stand adapter.....\$65.48  
Model 2100 lavalier or hand-held design with neck cord.....\$39.30  
Model 4000 lavalier or hand-held design with neck cord; response 50-2000 cps .....\$54.96  
Model 4080 lavalier design with neck cord;



60-20,000 cps; 50 or 200 ohms impedance .....\$52.96

# Turner's New Cardioid



## They're perfectly matched

New manufacturing methods make all Turner 500's uniform and identical in performance. And that's what you need for in-the-home stereo recording with the professional flair. This uniformity is something you'll have to pay plenty for ... unless you buy Turner's sensibly priced new Dynamic Cardioid 500! So improve the performance of your entire sound system without devastating your budget. Get the Model 500 ... just \$84.00, list price.

### Model 58

A natural for applications requiring freedom and mobility. Doubles as desk mike with stand ... \$57.00, list price.

### Model 95

The perfect PA mike for church, school, club or high quality recording. On-off switch available, 20' cable supplied ... \$37.50, list price.



**THE TURNER MICROPHONE COMPANY**  
900 17th Street N.E.  
Cedar Rapids, Iowa

Gentlemen:

Please send me the Turner Catalog, free.

Name \_\_\_\_\_

Address \_\_\_\_\_

City \_\_\_\_\_

State \_\_\_\_\_

IN CANADA: Tri-Tel Associates, Ltd.  
81 Sheppard Ave. West  
Willowdale, Ontario

CIRCLE NO. 60 ON READER SERVICE CARD 165

# 6 Equipment Cabinets

## ACOUSTI-CRAFT

### Capri Symphony Stereo Group

Consists of Model 1415 IPS twin speaker enclosures 4.5 cu. ft. each, and Model

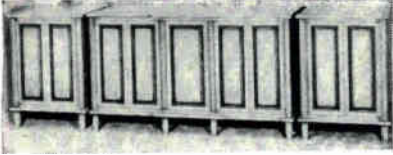

1400 EIP or EIPS equipment enclosure; 3/4" hardwood birch or walnut veneer; eight finishes available.

Model 1400EIPS Equipment cabinet; 31"x41"x20 1/4" .....\$247.50

Model 1415IPSD Speaker enclosure (bass reflex); 31"x22 1/2"x20 1/4" .....\$140.00

Model 1415IPHS Speaker enclosure (horn loaded); 31"x22 1/2"x20 1/4" .....\$152.00

Model 1400EIP Equipment enclosure; 31"x58"x20 1/4" .....\$350.00

### Heritage Symphony Stereo Ensemble

Consists of Model 1915PS and 1915 bass reflex and horn loaded 4.5 cu. ft. speaker



enclosures, and Model 1900EP or 1900EPS equipment cabinet; eight finishes available.

Model 1900 EPS Equipment cabinet; 30 3/4"x40"x20 1/4" .....\$247.50

Model 1915 PS Speaker enclosure (bass reflex); 30 3/4"x23"x20 1/4" .....\$110.00

Model 1915PHS Speaker enclosure (horn loaded); 30 3/4"x23"x20 1/4" .....\$122.00

Model 1900EP Equipment cabinet; 30 3/4"x58"x20 1/4" .....\$350.00

### Colonial Symphony Stereo Ensemble

Consists of equipment cabinet and twin speaker enclosures; holds all equipment for stereo; 3/4" hardwood birch veneer; eight finishes; enclosures are bass reflex or horn loaded.

Model 1800EAS Equipment cabinet; 30 1/2"x40 1/4"x20 1/4" .....\$247.50

Model 1815AS Speaker enclosure (bass reflex); 30 1/2"x23 3/4"x20 1/4" .....\$110.00

Model 1815AHS Speaker enclosure (horn loaded); 30 1/2"x23 3/4"x20 1/4" .....\$122.00

Model 1800EA Equipment cabinet; 30 1/2"x58"x20 1/4" .....\$350.00

### Model Florentine

Italian Provincial design constructed as a single unit of walnut wood only; center sec-

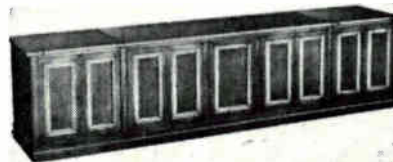

tion has lift top for vertical mounting of equipment and touch-latch accordion front doors providing access to storage area; panel doors cover speaker housings (one at each end); cut-out for 12" woofer & blocked for 3" round tweeter opening; de-

tailed base with casters; 96 1/4"x23 1/2"x20 1/8" deep; 325 lbs.; to opening 53 1/2"x17"; two storage areas 17"x7 1/4"x17" d.; available in various finishes.

Model 4400 EIPD .....\$690.00

### Model Parisienne

Contemporary design constructed as single unit of walnut only; center area has lift top

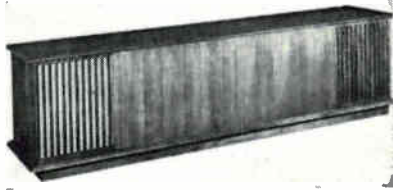

for vertical mounting of equipment; has standard bass-reflex enclosures, one at each end; cut-out for 12" woofer with blocked 3" round tweeter opening; recessed kick base with casters; 98 1/2"x26 1/4"x20 1/2" deep; 325 lbs.; equip. area 3 sections 18" wide x 17" deep; available in various finishes.

Model 5500 EM .....\$690.00

### Madrid Stereo Combo

Old Spanish design; full banded 1" top; solid hardwood (birch only) detailed panel;



touch-latch doors; horizontal mounting of equipment with pull-out changer drawer & upright record storage (storage area can be converted to pull-out drawer for tape recorder at additional cost); dual adjustable-port speaker enclosures (at each end of cabinet); cut-out for 12" woofer and blocked for 4 1/2"x5" tweeter opening; over-all size 75"x28 1/2"x20 3/4" deep; equip. area single compartment 36" w. x 17" deep; 240 lbs.; available in various finishes.

Model 7700 ESD .....\$550.00

### Model Regency

Similar to the "Madrid" but French Provincial design; 75"x30 3/4"x20 1/8" deep.

Model 4600 EFD .....\$480.00

### Mediterranean Group

Consists of Model 5400EIP equipment cabinet; two lift-top lids; three compart-

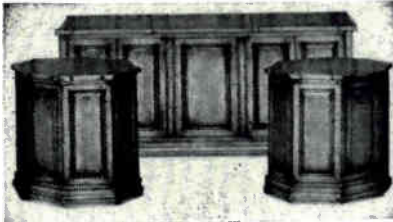

ments; vertical mounted doors; flat record storage both sides; raised base with casters; 58"x23 1/2"x20"; and speaker enclosure Model 5412IPSD; drum-table style; octagonal shape; raised base with casters; folding doors; 3/4" walnut; available in variety of finishes; 12" speaker; 23 1/2"x22 1/2"x22 1/2".

Model 5400EIP equipment cabinet.....\$390.00

Model 5412IPSD speaker cabinet.....\$200.00

### Stereo Combo Series

Each is a complete, built-in unit in different stylings.

Model 3900EP Heritage Combo in American Provincial style; 31"x75"x21 1/2".



Model 3900EPD with bass reflex enclosures .....\$430.00

Model 3900EPH with horn loaded enclosures .....\$454.00

Model 3800EA Colonial Combo in Early American style; available with raised base and casters only; 31"x75"x21 1/2".



Model 3800EA with bass reflex enclosures .....\$400.00

Model 3800EAH with horn loaded enclosures .....\$424.00

Model 3400EIP Capri Combo in Italian Provincial style; 31"x75"x21 1/2".

Model 3400EIPD with bass reflex enclosures .....\$430.00

Model 3400EIPH with horn loaded enclosures .....\$454.00

Model 6400EIP Empress stereo combination; raised base with casters; solid top,

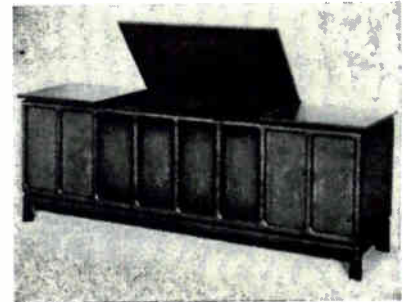

doors on speaker compartments; for 12" speaker; bass reflex design; walnut or birch; 75"x29 1/2"x20" .....\$475.00

Model 6400EIPH with horn loaded enclosure .....\$499.00

## AUDIO ORIGINALS

### Model 202B Cabinet

Contemporary design; has adjustable 2-position equipment shelf; space for chang-



er or turntable; speaker area 25 3/4" x 14 1/2"; equipment shelf 33" x 15" (6" or 9" positions); available in oiled walnut; shipped knocked down, easily assembled; over-all size 64" x 32 1/2" x 15" d.....\$69.50

### Model 303 Cabinet

Scandinavian design featuring pull-out

record player shelf; speaker area 25 3/4" x 16 1/4"; component shelves 17 1/8" wide (5 1/2" or 7 1/2" positions); pull-out shelf 17 3/8" wide; over-all size 72 1/2" x 32 1/2"

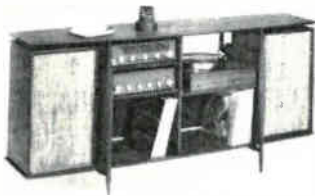

x 16"; available in oiled walnut; shipped knocked down, easily assembled.....\$119.50

**Model 404 Cabinet**

Has 2 large drawers, one with mounting board for changer, the other for record



storage or tape recorder; drawer fronts available with cane cloth or wood veneer; blank panel is included for components; over-all size 41" x 30" x 19 1/2" d.; equipment area 37 1/4" x 16" d. x 8"; drawer mounting board 17 1/2" w. x 16" d.; supplied knocked down.....\$99.50

**BARZILAY**

**"Design One" Cabinet**

Combination of K61 equipment cabinet & two K62 speaker cabinets. All sections

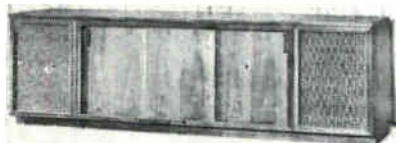

made of black walnut, pre-polished but unfinished. 8' l. x 18 1/2" d. x 28 3/4" h.

Kit .....\$269.50  
 Factory assembled Model 100E.....\$432.00  
 K61 equip. cabinet provides 5' of record & tape storage behind 3 sliding doors. Optional front or top mounting of audio equip. Has single top lift. Over-all size 57" l. x 18" w. ea. x 21 1/4" h. Kit.....\$161.50  
 Factory assembled Model 161.....\$256.00  
 K62 speaker cabinet 19" w. x 28 3/4" h. Kit .....\$54.00 ea.  
 Factory assembled Model 162.....\$88.00 ea.

**"Design Two" Cabinet**

Single design with two center sections for equip. & 2 speaker cabinets. Top or front

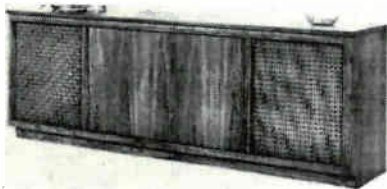

mounting of components. Has sliding door & lift top. Black walnut 81" l. x 28 3/4" h. x 18 3/4" d. Center section 18 1/2" w.  
 Kit .....\$199.50  
 Factory assembled Model C150.....\$360.00

**Model H500 Cabinet**

Two end speaker doors swing to the center when set is in use. Accepts electronics, turntable; 2-12" speakers; 26" h. x 75" w. x

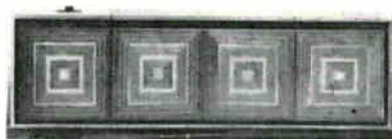

18" .....\$275.00

**Model 300E Cabinet**

Three separate cabinets with 3-section center equipment cabinet & top lift & doors.



Walnut: 30" h. x 96" w. x 20" d....\$575.00  
 Model 3061 Equip. cab.....\$316.00  
 Model 3062 Spkr. cab. for 15" & 12" speakers .....\$130.00

**Model 97E Cabinet**

Low 8' design consists of 9067 tambour-door cabinet & two 9011 spkr. cabs. on a



cradle base for 12" or 8" spkr. Mtg. panel & pull-out drawer optional. 22" h. x 18" d. ....\$310.00

**Model 809 Cabinet**

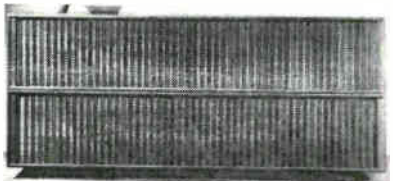

6' equipment cabinet.....\$173.00  
 Model 809K with kick base.....\$186.00  
 Model 809KRS record storage only..\$192.00  
 These units can be stacked or mounted on wall. Matching spkr. cabinets available.

**Model 950E Cabinet**

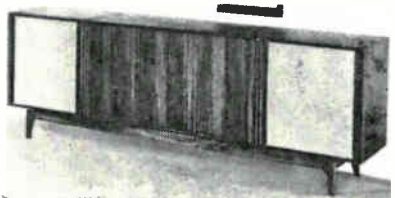

3-piece ensemble 8' long. Has top lift & paneled tambour doors.....\$480.00  
 Model 9561 Equip. cab.....\$251.00  
 Model 9562 Spkr. cab.....\$ 83.00

**Model 80E Cabinet**

8' ensemble consists of 8061 equip. cab. and two 8062 speaker cabs. Has tambour doors & lift top. Tape drawer optional.

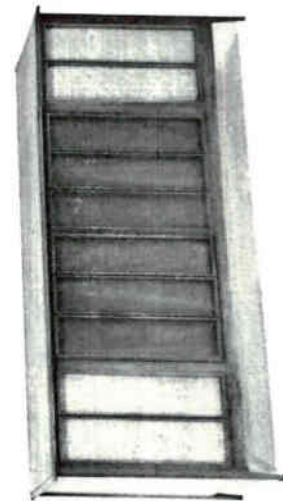
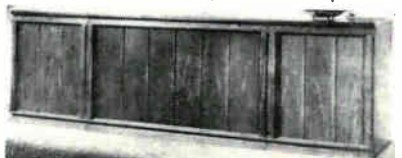

MODEL 606-D  
 stunning all-in-one stereo component center

Our new collection is now available ...

equipment cabinets • speaker enclosures • consoles • cabinets galore. Danish and Provincial styles in new decorator finishes.

see your dealer or write for free brochure

546 S. Meridian • Indianapolis, Ind.  
**CIRCLE NO. 9 ON READER SERVICE CARD**

1959 through 1963 issues of Stereo/Hi-Fi Directory are still available. Order your copy by sending \$1.00 plus 15¢ shipping and handling to:

**Ziff-Davis**  
**Service Division**  
**589 Broadway**  
**New York, N.Y. 10012**

# 6 Equipment Cabinets

29" h. x 20" d. ....\$598.00  
 Model 8061 Equip. cab. ....\$294.00  
 Model 8062 Spkr. cab. for 15" or 12" speakers. Bass reflex design. ....\$152.00

## Model 900 Cabinet

Classic Moorish arches of solid walnut. Speaker sections are bottomless for anti-

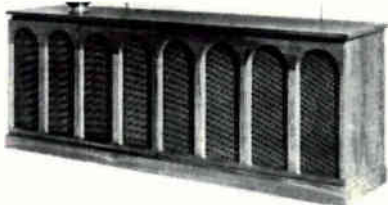

feedback insertion of enclosed systems. 29 1/2" h. x 78" w. x 18" d. ....\$429.50  
 Model 900S Same with built-in speaker enclosures for 15" or 12" spkr. ....\$449.50

## Model 800 Cabinet

Has 4 tambour doors, one 2-section equipment area & 2 spkr. housings with bottom-

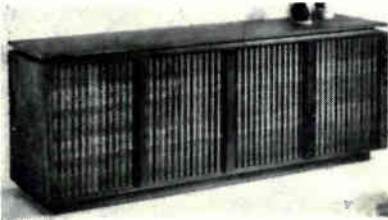

less design. Separate enclosed spkr. systems are placed inside for anti-feedback operation. 29" h. x 78" w. x 20" d. ....\$429.50  
 Model 800-811 Same but includes 2 separate 12" spkr. enclosures. ....\$486.50  
 Model 800EC Same but 2 additional equipment compartments in place of speaker sections. Has 3 lift tops. ....\$515.00

## Model 200E Cabinet

3 separate section design with front doors

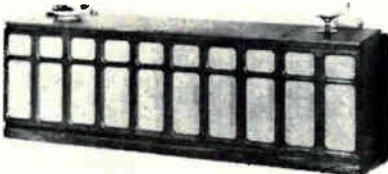

& lift top. 29" w. x 29" h. x 20" d. ....\$545.00  
 Model 2061 Equip. cab. ....\$300.00  
 Model 2062 Spkr. cabinet for 15" or 12" spkrs. ....\$124.00

## "Sarabande" Collection

Model C-1000 "Da Vinci" Hand finished walnut with 4 raised-panel folding doors.



Left side of center section supplied with panel & shelves for components. Right side

has pull-out drawer for record player & record storage. End sections accept 12" or 15" spkrs. 29" h. x 77 1/4" w. x 20" d. ....\$539.00

Model C-2200 "Athenia" Greek & Mediterranean motifs. Has center section top lift

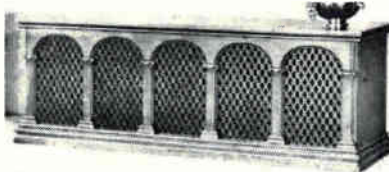

with 12" spkr. ea. end. 26 1/2" h. x 78" w. x 18" d. Antique walnut finish. ....\$450.00  
 Model C-3300 "Acanthus" Mediterranean accent. End doors swing around sides to



reveal speaker enclosures for 12" or 15" designs. Ctr. doors unfold for access to components. Antique walnut. 29" h. x 78" w. x 20" d. ....\$499.00

Model C-4400 "Sevilla" Solid oak doors. Spanish design. End doors fold flat against

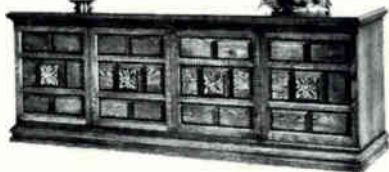

sides to reveal spkr. enclosures for 12" or 15" designs. Compartment area available from front. 29" h. x 78 1/2" w. x 20" d. ....\$519.00

## BOZAK

### Model C-305U Equipment Cabinet

"Urban" styling; with double doors and single or double top lifts; over-all size 30" h. x 36 1/2" w. x 20" d.; available in walnut or mahogany. ....\$185.00

### Model C-305FP Equipment Cabinet

Similar to Model C-305U except French Provincial styling; over-all size 31" h. x 40" w. x 20" d.; available in cherry. ....\$285.00

### Model C-305IP Equipment Cabinet

Similar to Model C-305U except Italian Provincial styling; over-all size 38" w. x 20" d. x 31" h.; available in cherry. ....\$245.00

### Model C-305EA Equipment Cabinet

Similar to Model C-305U except Early American styling; over-all size 38 1/2" w. x 19 1/4" d. x 30 1/4" h.; available in hand-rubbed maple. ....\$189.50  
 Matching speaker enclosure available for all cabinets.

## FURN-a-KIT

Various cabinet designs are supplied in kit form; available from 2' to 7' wide in 1' steps for speakers, equipment, or combinations. Kits are supplied sanded.

### 7-Foot Contemporary Kit

Designed to house stereo speakers, tuner, amplifier, tape recorder, turntable, and record storage cabinet. ....\$185.00

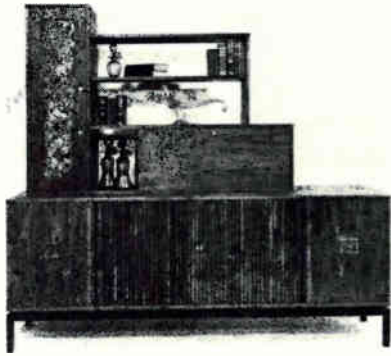

Contemporary hutch with drop-lid bar & storage area. ....\$116.50

## GRECO

### "Montoro" Custom Cabinet

Custom cabinet for individualized requirements; includes cut-outs; Italian Provincial

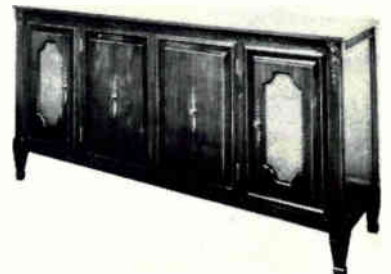

cial: any finish; 72" w. x 36" h. x 19 1/2" d. ....\$460.00

### "Solofra" Custom Cabinet

Custom cabinet for individualized requirements; includes lift-top Formica bar;



Italian Provincial; any finish; 84" w. x 33" h. x 18" d. ....\$648.00

Company can supply basic cabinetry in contemporary classic, modern Danish, Early American, Italian, Spanish, and French Provincial to specifications.

### "Launeston" Custom Cabinet

Breakfront cabinet for individualized requirements; Regency style, any finish; bot-



tom piece 84" x 33" x 20" d.; top piece with bar center 72" x 48" x 16" d.; crocheted wood inserts on doors. ....\$1480.00

### "Carina" Custom Cabinet

Cabinet for individualized requirements; Italian Provincial; any finish; 84" x 33" x 18" d. ....\$570.00

## HEATH

### Equipment Cabinet

Factory-assembled, ready-to-use equipment and matching speaker cabinets designed

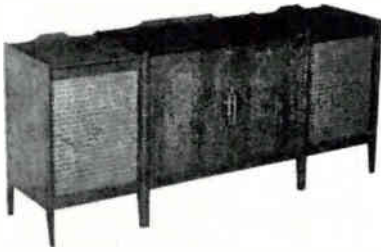

for mono or stereo systems; available in hand-rubbed walnut or unfinished; "gallery" rails; front doors with recessed planes and striated vertical scoring; curved brass door handles mounted on bas relief door edges; 3/4" stock used on all exterior panels and supports; solids for edgings; furniture-grade veneers for front and side panels and shelves; ventilated rear half-panel of Masonite; center cabinet will house complete stereo or mono hi-fi system except speakers; changer compartment will accept most record changers; storage compartment holds records and tapes; or accessory slide-out drawer may be used for tape recorder; two shelf compartments hold tuners and preamps or combination amps; separate power amp compartment takes most stereo power amps or mono amp; speaker-wing cabinets for 12" and 15" speakers; adapter rings for 8" or 12" speakers; special port for horn-type tweeter; instructions for modifying tube-vented design to match any speaker resonance.  
 Model AE-20U center cabinet (unfinished) .....\$79.95  
 Model AE-20W center cabinet (walnut) .....\$99.50  
 Model AE-40U 15" speaker cabinets (unfinished).....\$37.95  
 Model AE-40W 15" speaker cabinets (walnut)—photo.....\$44.95

## KARLSON

### SXC-2 Stereo Expander Console

Integrated design includes two speaker systems for stereo & an equipment cabinet:

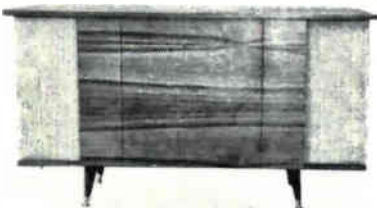

produces stereo image 12' x 7'; response 40-15,000 cps; dynamic range 100 db; 8 ohms; power capacity 15 w.; eff. 20%. Center panel opens with touch latch and slides out with drawer plate for record player with base. Equipment section 8" x 18" x 14"; record player compartment 9 3/4" x 18" x 14 1/2". Over-all size 48" x 16" x 28" high on 6" legs.....\$234.00

## KERSTING

### Model E-1 Record Cabinet

Constructed of walnut veneer in hand-rubbed oiled walnut and oiled ebony finishes; birch veneer in blonde or mahogany finishes; holds 185 LP records; 22 1/4" h. x 32" w. x 16" d.; contains one "Quick-See" retractable album file allowing front-view flip through selection of records; other compartment has conventional storage.....\$54.95



Early American Maple.....\$69.00  
 Early American Maple with Captain's rail .....\$76.00  
 Tambour door (legs).....\$91.90  
 Tambour door (base).....\$91.90  
 Retractable album files are available separately for custom installations. Designed for 12" LP's, 45 rpm's & tape. Nine different designs vary in price from .\$.795 to \$16.95

## KNIGHT

### KN-1520K Cabinet Kits

Early American design with 3/4" pre-finished maple. 28 1/4" x 36 1/2" x 16 1/4".  
 Kit .....\$84.95

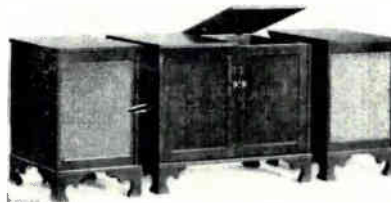

Pre-assembled .....\$99.95  
 Spkr. cabinet 28 1/4" x 18 1/4" x 16 1/4".  
 Kit .....\$39.95  
 Pre-assembled .....\$44.95

### KN-1530K Cabinet Kits

Provincial design with 3/4" maple pre-finished in fruitwood. 28 1/4" x 36 1/2" x 16 1/4".



Kit .....\$84.95  
 Pre-assembled .....\$99.95  
 Spkr. cabinet 28 1/4" x 18 1/4" x 16 1/4".  
 Kit .....\$39.95  
 Pre-assembled .....\$49.95

### KN-1510K Cabinet Kits

California Ranch design with 3/4" oiled walnut. 28 1/4" x 36 1/2" x 16 1/4".  
 Kit .....\$74.95



Pre-assembled .....\$89.95  
 Spkr. cabinet 28 1/4" x 18 1/4" x 16 1/4".  
 Kit .....\$34.95  
 Pre-assembled .....\$44.95

## LAFAYETTE

### "Criterion" Speaker Cabinet

Styling identical to equipment cabinet; will accommodate any 12" speaker; designed around elliptical port principle; 32 1/2" x 16" x 18"; available in walnut

## Quick-See Album File



### FRONT-VIEW, FLIP-THROUGH SELECTION

Stop stooping, squinting, straining, to find albums stacked on edge. Quick-See units glide in and out of cabinet or wall for fast, simple selection... you see the full face of your album without removing it. Ends jacket-bottom wear, too. Installs anywhere in five minutes. Sturdy welded steel and ball-bearing construction, brass finish. Nine models for LP's and tape, hold up to 125 albums... available separately or in special cabinet furniture.

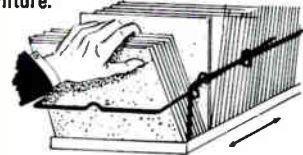

Dealer inquiries invited  
**KERSTING MFG. CO.**

504-R So. Date, Alhambra, California

CIRCLE NO. 33 ON READER SERVICE CARD



**BULLSEYE!**  
 You'll Score **BIGGER SAVINGS**  
 Everytime You Buy From  
**"DIXIE HI-FI"**

Largest discount High Fidelity component distributors in the South. Wholesale prices on package or individual components. Latest models in factory sealed cartons shipped immediately from our warehouse.

Special attention given to Audio Clubs, Churches and Schools.

For Special Price Quote—Write

**DIXIE**  
 HI FIDELITY WHOLESALE  
 703 HORTON DRIVE  
 SILVER SPRING, MD.

CIRCLE NO. 18 ON READER SERVICE CARD

# 6 Equipment Cabinets

or mahogany, (see photograph below)  
 CAB-160WX .....\$59.50

**"Criterion" Equipment Cabinet**  
 Over-all size 44" w. x 32½" h. x 18" d.; has four separate compartments; inside



dimensions of top two are 10" h. x 18¾" w. x 15¼" d.; bottom two are 12¼" h. x 18¾" w. x 15¼" d.; tambour doors; available in walnut or mahogany. CAB-157 WX.....\$89.50

## ROCKFORD

**Model 500 Equipment Cabinet**  
 Combination record and equipment cabinet; lower left can hold up to 150 LP



records; top left could house tape recorder, record changer, or turntable; top right 18¾" wide x 13¾" high; has adjustable shelf; over-all size 40" wide, 32½" high, 19½" deep; available in walnut, mahogany, blonde, and ebony finishes.  
 Model 500L with legs.....\$163.50  
 Model 500B with base.....\$174.00

**Model 501 Speaker Enclosure**  
 Matching unit for Model 500 equipment cabinet; houses up to 15" speaker and any



size tweeter; 20" wide, 32½" high, 19½" deep; available in walnut, mahogany, blonde, and ebony finishes.  
 Model 501L with legs.....\$79.50  
 Model 501B with base.....\$84.00

**Models 600 & 601 Enclosures**  
 Matching speaker cabinets and equipment enclosures in Italian Provincial design; speaker cabinets house up to 12" speakers; 17" wide x 27¼" high x 17" deep; equipment cabinet—top right compartment



with lift-top for record changer, turntable, or tape recorder; inside dimensions 14¾" x 17¼" x 6"; lower right space for 100 LP records; left side for amplifiers, tuner, etc.; over-all size, 38" wide, 27¼" high, 17" deep; available in fruitwood, walnut, mahogany, blonde, or ebony.  
 Model 600 Equipment cabinet.....\$136.50  
 Model 601 Speaker cabinet.....\$ 67.50

**Models 700 & 701 Enclosures**  
 Matching equipment and speaker cabinets in Danish modern design; equipment cab-



inet size 38¼" w. x 28¼" h. x 17¾" d.; speaker cabinet 17" x 28¼" x 17¾" d.; for 12" speaker; oiled-walnut finish.  
 Model 700 Equipment cabinet.....\$144.50  
 Model 701 Speaker cabinet.....\$ 74.50

**Model 720 Equipment Cabinet**  
 Contemporary design; center compartment inside dimensions 18¾" w. x 13½" x 17" d. for amplifier & tuner; tape deck compartment (upper left) 17½" w. x 16¼" d. with 4" above & 5½" below mounting board; phono compartment (upper right) 17½" w. x 16¼" d. with 6½" above & 3¾" below mounting board; storage for 100 records; speaker compartments for 12" designs; 57½" w. x 31¼" h. x 18½" d.; oiled walnut.....\$249.90

**Model 820 Equip./Speaker Cabinet**  
 Early American style with dual lift tops for record player & tape deck; over-all size



57¾" x 31¼" x 18¾" d.; component area 18¾" w. x 13½" h. x 17" d.; phono area 17½" w. x 6½" above mtg. board and 3¾" below x 16¼" d.; tape deck area 17½" w. x 4" above mtg. board and 5½" below x 16¼" d.; record storage space 18¾" w.; speaker enclosure designed for 12" speakers; available in maple or walnut ..... \$271.00

**Model 120/101 Equip./Speaker Cabinets**

Upper compartment has removable extra shelf; inside dimension 18¾" w. x 13¾"



h.; has drop front & blank face panel; lower pull-out drawer with blank mtg. board;

over-all cabinet size 20" w. x 32½" h. x 18" d.; matching speaker cabinets designed for up to 15" speakers & any size tweeter; 20" x 32½" x 18" d.; available with removable base or legs; walnut, mahogany, blonde, or ebony.  
 Model 120L with legs.....\$81.50  
 Model 120B with base.....\$86.00  
 Model 101L with legs.....\$73.50  
 Model 101B with base.....\$79.00

**Model 810/811 Equip./Speaker Cabinets**

Early American ensemble; upper right compartment has lift top; inside size 14¾" x



17¼" x 6" d.; lower right has space for 100 records; upper left compartment has removable shelf; inside dimension 17¾" w. x 14½" h.; has blank face panel; lower left is additional storage space; over-all size 38¾" x 27½" x 17¼" d.; matching speaker enclosures will house up to 12" speakers; 17½" x 27½" x 17¼"; available in maple finish.  
 Model 810 Equipment cabinet.....\$151.50  
 Model 811 Speaker cabinet.....\$ 77.00

**Model RC-510 Record Cabinet**

Holds up to 200 records; each side equipped with wire dividers; available for wall hang-



ing or with legs; 40¾" w. x 16½" d. x 16" h. (22" with legs); available in oiled walnut, mahogany, blonde, and ebony; with legs.....\$75.00  
 For wall mounting.....\$71.00

**Model RC-511 Speaker Cabinet**

Matching design for RC-510 record cabinet; either wall or floor mounting; 15¼" w. x 16½" d. x 16" h. (22" h. with legs); with legs.....\$39.95  
 For wall mounting.....\$36.00

**Model RC-520 Record Cabinet**

Upper compartment 20" w. x 18" d. with adjustable 6" to 13" height; lower com-



partment 20" w. x 13" h. x 18"; over-all size 22" w. x 32½" h. x 19½"; available in oiled walnut, mahogany, blonde, and ebony .....\$86.00

# 6 Miscellaneous

## ASTATIC

### 2501 Ceramic Headphones

Freq. range 30-10,000 cps; sensitivity 100 db (sound pressure level) for 6.5 v. input; impedance 20,000 ohms @ 1000 cps; capacity 3800  $\mu$ f.  $\pm$  600 (each phone); HD less than .5% @ 1 kc. & 20.4 v. input; 8.5 oz. ....\$27.75  
 Model 2503 with ceramic boom microphone .....\$37.75

### 2601 Crystal Headphone

Freq. range 30-8500 cps; sensitivity 100 db (sound pressure level) for 4.5 v. input; im-



pedance 100,000 ohms @ 1000 cps; capacity 750  $\mu$ f.  $\pm$  150 (each phone); HD less than .35% @ 1 kc. & 14.2 v. input; 8.5 oz. ....\$22.75  
 Model 2603 with ceramic boom microphone .....\$35.25

Ceramic boom microphone for models 2501 & 2601; frequency range 30-8500 cps; output 58 db below 1 v./dyne/cm.<sup>2</sup>; 200,000 ohm impedance @ 1000 cps; capacity 750  $\mu$ f.  $\pm$  150; recommended load 1 megohm min.; wt. 2 oz. less cable.....\$14.00  
 Headphones & microphone supplied with 6' cables and are available in stereo or mono and in green, grey, or beige.

## CLARK

### Model 100 Stereo Headset

Moving-coil (dynamic) design with plastic diaphragms; response 20-10,000 cps  $\pm$  3

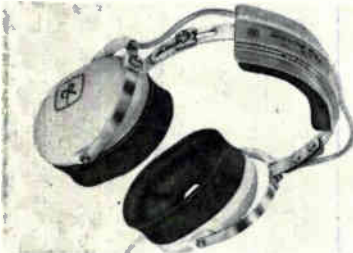

db; distortion less than .2% @ 100 phn level; sensitivity 1 mw. @ 1000 cps produces 100 db (reference .0002 microbar); max. input 1 w./phone; 8 ohms; has 20 db av. cushion attenuation to white noise; stereo or mono; supplied with 8' cable and 2-circuit plug.....\$39.50  
 Model 103 same except 300 ohms.....\$39.50  
 Model 112 same except 1200 ohms.....\$44.50

## COLORSOUND

### Model 3500 Color Organ

Three-channel amplifier designed to oper-

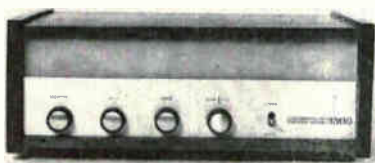

1965 EDITION

ate from any hi-fi system; three channels are so designed as to vary intensity of red, green, and blue lamps; has 2 inputs—low level .01 v. for max. output (100K impedance) high level .1 v. (500K impedance); outputs 110-120 v. standard incandescent lamps; max. load 500 w./ch.; has brightness, bass, treble, time, power controls; crossover (red-green) 300 cps & (green-blue) 1000 cps; has 26 solid-state devices; 13 1/8" x 8 3/8" d. x 5 1/2".....\$349.00

### Model 201 Color Organ

Versatile color control. Sound received by either built-in microphone or input jack is



separated into two channels with crossover at 280 cps. Each operates 400-watt power control for 120-volt incandescent lamps. Requires no lamp conversion, as a simple adapter socket for lamp allows the normal two-wire cord to operate two colors. 9 1/2" x 7 1/2" x 3".....\$147.00  
 Two-way lamp adapter with bulbs...\$ 5.50  
 Three-way adapter with bulbs.....\$ 8.50

## FISHER

### Model K-10 "Spacexpander"

Single-control reverberation design using interconnected coil springs; nominal delay 33 sec.; self-powered; three dual-purpose tubes, 7247 and 2-12AX7, decay time variable maximum 2 sec. @ 300 cps; minimum input .2 v.; max. input 5 v.; input imp. 250,000; out. imp. 2000 ohms; output voltage is .2-5 volts; the gain is one .....\$69.50

### Model PR-6 Preamp

Self-powered; sensitivity for 1 v. out;



10 mv. input phono; 1 mv. input mic; 5 mv. for tape; hum -60 db below 1 v. phono & tape; -70 db on mic; 30-20,000 cps  $\pm$  2 db; 6SC7 dual-triode amplifier tube; 3 1/4" w. x 3 3/8" d. x 3 3/8" h. weight 1 1/2 pounds. ....\$14.95

## FREEMAN

### "SEP-100" Stereo Earphones

Two-way, top of the head or under the chin type earphones; provided with individual level adjustments for each ear &

GET OUR QUOTE

# ROCK BOTTOM PRICES

STEREO • HIGH FIDELITY

**PLUS THESE RABSONS EXTRAS**

- Established 1905 58 Years of Reliability
- Franchised Protection Plus
- Rabsons Special Two Year Guarantee
- Easy Payment Plan Up to 24 Months to Pay
- Each Component Double Packed to Insure Safe Arrival . . . At no extra charge
- Rabsons Sells ONLY Factory Fresh Merchandise in Original Factory Sealed Cartons

**SO WRITE RABSONS**  
 Whatever your HI-FI requirements and receive

## FREE RABSONS

A \$1.00 genuine Miracle Record Cleaning Cloth with EVERY Quotation from Rabsons on a component or system of your choice.

**RABSONS -57 ST. INC.**  
 119 West 57th St., New York 19, N.Y.  
 Area Code 212 Circle 7-0070  
 Diagonally opposite Carnegie Hall

**CIRCLE NO. 47 ON READER SERVICE CARD**

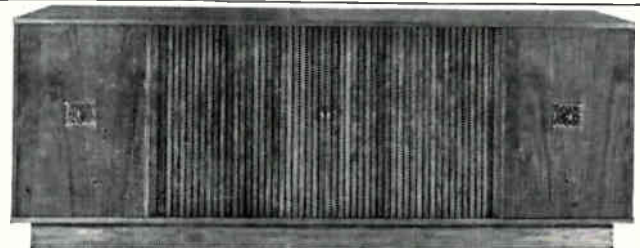

**\$379. CABINET**

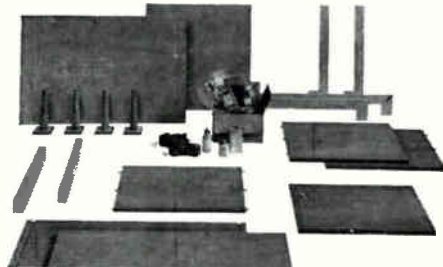

**...SAME CABINET \$151.**

All you need is a screwdriver to house your equipment in fine cabinetry at superb savings. Furn-a-Kit know-how gives you the custom built look in hi-fi cabinets, break-fronts, bedroom and dining room pieces, wall furniture, many others . . . even if you've never done anything more ambitious than hang a picture. Dozens of styles to choose from. Results are guaranteed or money back. For a complete catalog of Contemporary, Traditional and Period designs send 25c.

## FURN-a-KIT®

Dept. D-9, 151 East 53rd Street, N. Y. 10022  
 1308 Edward L. Grant Highway, Bronx, N. Y. 10452  
**CIRCLE NO. 25 ON READER SERVICE CARD**

# 6 Miscellaneous



stereo/mono sw. Response 25-18,000 cps .....\$26.95

## 1400 Transistorized Mixer

Self-powered; mixes & controls any combi-



nation of four mics., tuners, phonos, radios, etc.; gain 6 db; 6" x 2 1/4" x 3 1/2" d...\$24.95

## HI-FI HQ.

### Transistorized Stereo Mixer

Three input, two high-gain, and one low-gain channels per side; monitor & vu cir-

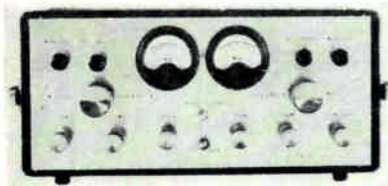

cuits switchable; 50-150 ohm input; 600 ohm output; with portable carrying case .....\$275.00

## JENSEN

### Model HS-1 Headset

Stereo or mono design; response 20-15,000 cps; 8 ohms; sensitivity 95 db sound pres-



sure level for 1 mv.; 1/10 watt input required for adequate listening; 3-way plug and 8-foot cord provided.....\$29.95

### CC-1 Headphone Control Center

For 8-ohm electrodynamic phones; operates with any 10-watt/channel amplifier; stereo design; new "Space-Perspective" design provides complete controls for personal listening; controls—speaker "on-off," left or right-channel only or stereo with channel reversal; mono or stereo with choice of "Space-Perspective" or regular; balance;



volume; 1/4" h. x 1 1/4" w. x 3" d.....\$49.60

### Model CFN-1 Cross-Feed Network

Provides full cross-feed characteristics to simulate speaker listening; can be con-



nected to any 10-watt/channel or larger amplifier; to be used with 8-ohm stereo headsets .....\$23.50

## KNIGHT

### KN-875 Stereo Headphones

Response 20-16,000 cps; 3 1/2" dynamic transducer; 4-16 ohms; 8' cord.....\$14.95

### KN-876 Stereo Headphones

Response 15-16,000 cps; dynamic transducer; 4-16 ohms; 8' cord plus individual vol-



ume control for each phone.....\$19.95

## KOSS

### SP-5NS Dual Mode "Stereophones"

Switched lavalier with two plugs provides a stereo plug for monitoring or two mon-



aural plugs for playback use with recorders having two external speaker jacks .....\$24.95

### Model A-1220 Amplifier

For use with Stereophones; can be directly connected to stereo ceramic cartridge or



outputs of stereo preamp or tuner; gain control for each channel; transformer powered; 3 tubes plus rectifier.....\$34.95

### Model SP-3X "Stereophones"

Extremely sensitive 3 1/2" sound reproducers mounted in each carpiece; response



10-15,000 cps; impedance 4-16 ohms; comes complete with adapter plate that connects to any system that will drive speakers .....\$24.95

Model SP-100 Same as Model SP-3 except for impedance of 100 ohms; for special and multiple installations.....\$24.95

### Model SP-5SM "Stereophones"



Stereo and monaural phones in one; switch in lavalier changes operation from stereo to monaural or vice versa.....\$24.95

### Model SP-5VW Dual-Input "Stereophones"

Designed with two monaural plugs for use with integrated tape recorder or phono

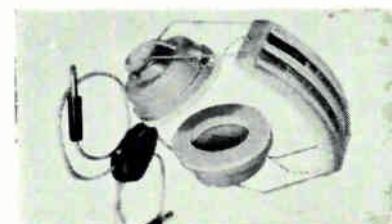

systems having two external speaker jacks .....\$24.50

### Model T-1 Junction Box

Contains matching transformers for monitoring; 600-10,000 ohm outputs; two output jacks for Stereophones .....\$7.95

### Model T-5 Remote-Control Listening Station

Junction box for connecting Stereophones to existing stereo or mono system; impedance 4-16 ohms; has jacks for two sets of Stereophones; one volume control for each ear;

**STEREO/HI-FI DIRECTORY**





on-off speaker switch for personalized listening .....\$8.95

**Model K-29 "Port-a-Pac"**

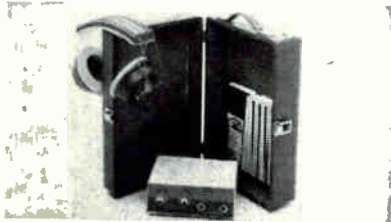

Stereophones and A-1220 stereo amplifier in compact carrying case.....\$66.50

**Model Pro-4 Headset**

Response 30-20,000 cps; max. input 10 watts/channel (60 w./channel music power); distortion less than 1% at maximum output; 4 ohms (600 ohms available); 8-foot cord; rugged, shock-proof and fluid-filled ear cushions.....\$45.00

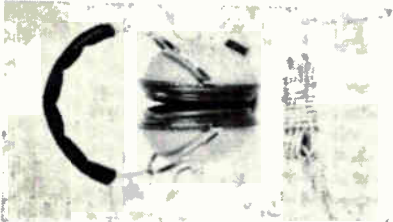

**LAFAYETTE**

**Model F-767 Headphones**

Stereo/mono design; response 30-15,000 cps; 8 ohms impedance each phone; complete with cables, wires, overload junction box .....\$11.88



99-0036 Junction Box

Permits stereo headphone operation without disconnecting speakers; separate jacks for stereo or mono; 4-16 ohms; has individual volume controls.....\$4.59

**99-0034 Stereo Headphones**

Dynamic design; response 25-15,000 cps; 8 ohms impedance per phone; max. power



500 mw.; has 6' cord; complete with junction box & switch box.....\$19.95  
99-0037 Speaker/headphone switch box .....\$ 4.95

**Headphones**



Stethoscope-type earphones; frequency response 40 to 16,000 cps; hinge permits any desired spacing.

99-2558 (binaural magnetic, impedance 6 ohms) .....\$2.35  
99-2559 (binaural magnetic, impedance 5000 ohms) .....\$2.35  
99-2546 (monaural magnetic, impedance 6 ohms) .....\$1.75  
99-2547 (monaural magnetic, impedance 5000 ohms) .....\$1.95  
99-2550 (monaural crystal, impedance 100,000 ohms) .....\$1.34

**MARCO**

**Model 700 Headphones**

Dynamic moving-coil type with self-supporting voice-coil protected against shock; response 30-16,000 cps; harmonic distortion less than 3% with 100 mw. applied; impedance 20 ohms/earphone or 10 ohms in parallel for monaural use; sensitivity 105 db @ 1000 cps in reference 0 db; .002 dynes/cm.<sup>2</sup> with input of 1 mw.; earphone elements mounted inside noise-attenuating earcups; weight 10 oz.....\$37.50

**MOOG**

**"Melodia" Theremin**

An electronic musical instrument played without being touched; distance between player's right hand and instrument's antenna rod determines pitch of the note; distance between player's left hand and instrument's volume antenna plate determines loudness of note; total pitch range is five octaves; tonal quality resembles that of musical saw or cello; completely transistorized and powered by single 6-volt battery; designed to operate into any hi-fi

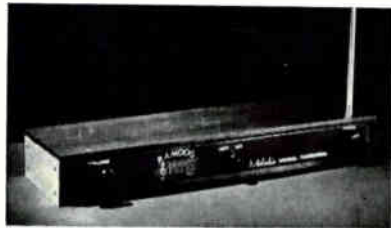

system; housed in solid hardwood cabinet 22" l. x 6" d. x 3 1/2" h.; available completely assembled or in kit form.

"Melodia" kit (FOB factory).....\$49.95  
"Melodia" assembled (FOB factory) .....\$75.00

**OLSON ELECTRONICS**

**Model PH-82 Stereo Headphones**



Features individual volume controls; response 30-15,000 cps; 8 ohms.....\$14.98

**PML**

**D-42 Headphones**

Dynamic design; for mono & stereo; impedance 400 ohms for mono & 200 ohms each for stereo; response 30-20,000 cps ±3 db; max. power handling (2% dist) 50 mw.; supplied complete with a six-foot cord .....\$24.50

**R-COLUMBIA**

**Model A Stereo Headphones**

Constructed of unbreakable "Royalite" with left and right drivers and headband plugging into one another; response 20-17,000 cps; 8 ohms per channel; sensitivity 97 db (re. .0002 microbar for 1 mw. input) .....\$19.95

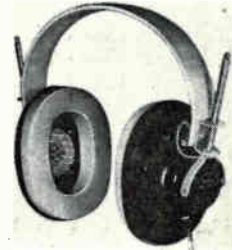

**ROYCE**

**Audio Robot**

Designed for use with extension speakers for turning off or on any hi-fi system; up to

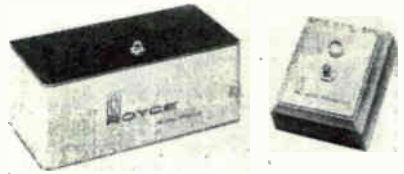

5 remote stations can be connected. It is a remote-control system using the 2-conductor speaker cable for connections; system is divided into two separate units "Remote Control" (3 1/2" x 3" x 1") and "Robot Control" (5 1/2" x 2 1/2" x 3 1/2"), latter is placed near hi-fi system.

"Robot" & "Remote" control.....\$32.95  
Additional "Remote" units.....\$ 5.49  
Panel mtg. switch for custom installations .....\$ 3.99  
"Robot" & "Remote" control with switch/light volume control.....\$36.50  
Switch/light volume control.....\$ 8.95

**SHARPE**

**Model LTC Control Box**

Has L-pad volume control for each channel; resistor network and fuses to protect earphones; accommodates two sets of earphones and is equipped with switch to cut out speakers; 6-foot leads with bare wire termination .....\$21.95

**Model HA-8 Stereo Phones**

20-15,000 cps, 2 watts, 8 ohms impedance per phone; ambient noise attenuation 20 db @ 1000 cps; all plated steel & plastic construction; 6' cord with 3-circuit phone plug .....\$24.50  
Model 8XXX High impedance, 150, 300, 600, 1200, 3000, 5000, 15,000 ohms for tuners & tape recorders.....\$29.50  
Model HA100 100 ohms impedance \$24.50  
Model HA100CT Same as HA100 but with center tap winding.....\$24.50  
Model HA8B Same as HA-8 but with built-in resistor network for high-power ampli-

# 6

## Miscellaneous

fiers .....\$24.50  
 Model HA8C Same as HA-8 except terminated with 2 monaural plugs instead of bare wire termination.....\$24.50

### Model HA-10 Earphones

Stereo design, with liquid-filled noise-attenuating ear seals. Response 30-15,000



cps  $\pm$  3 db; input power max 2 w. ca. phone; 8 ohms ca. phone; sensitivity 115 db reference .0002 dyne/cm.<sup>2</sup> at 1 volt input. ....\$43.50

### Model HA-10-B Earphones

Stereo design; 8 ohms impedance with 100 ohm resistor in series with each channel; 8-foot cord terminated with standard 3-circuit phone plug.....\$43.50

### Model HA-10-C Earphones

Stereo design; 8 ohms impedance; 8-foot cord terminated with two 2-circuit phone plugs; for stereo equipment having individual channel outputs.....\$43.50  
 All stereo headsets available in monaural on request. The following impedances are available at no additional cost on all units upon request: stereo—300, 600, 1200, or 3000 ohms; mono—16, 150, 300, 600, 120, 2400, or 6000 ohms.

### Model CB-1 Stereo Phones Control Center

Left & right volume controls; speaker "on-off"; 2 phone jacks; blend control for mix-



ing 2 input signals from full separation (off) to mono output.....\$10.50

### Model CM-4 Stereo Phones

Stereo design; 8 ohms; response 20-14,000 cps; distortion less than 2%; output 95 db for .034 r.m.s. input; weight 12 oz.; supplied with 6 ft. cord & molded 3-circuit phone plug. ....\$14.50

## SHERWOOD

### Model SL-1 "Stereo-Lite"



Will provide instant identification of FM station broadcasting stereo multiplex programs; can mount inside cabinet; 3/8" dia. hole is required; sensitivity adjustable; will operate with any FM tuner.....\$29.50

## SONY

### Model SHS-2 Binaural Headset

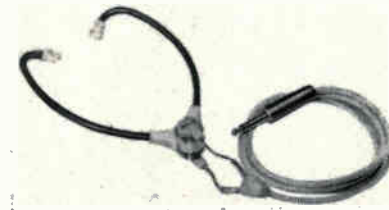

Low-impedance dynamic headset with acoustical pipe stethoscope principle; completely wired and phased.....\$7.95

### Stereo Headsets



Dynamic stereo design; available in low impedance (8 ohms).....\$ 17.50  
 High impedance (10,000 ohms)....\$ 22.50

## STEREOSONICS

### Phase & Balance Indicator

Indicates phase and extent of phase of stereo program material; can be used with



all grounded or ungrounded line systems and any high-fidelity component; can also be used as a balance meter.....\$19.50

### Model RM-2 Remote Control

Permits continuous control of volume, tuning, and "on-off"; for remote control



of any component or console system over distances of up to 800 feet.  
 RM-2 for two channels.....\$49.50  
 RM-3 for three channels.....\$62.50

## SUPEREX

### Model ST-S Stereo "Standard" Headset

Dynamic reproducer for 30-15,000 cps response; adjustable headband and plastic ear cups; has built-in surge protection

.....\$24.95  
 Model ST-SH Same as ST-S except high impedance, 600-2000-15,000 or 50,000 ohms .....\$29.95

### SX-700 Phones

Available in stereo or mono design. Response 30-15,000 cps; 4-16 ohms; 10 mw.



required for normal listening level....\$22.95  
 Also available with 600, 2000, 15,000, or 50,000 ohm impedances, with volume control, boom microphone attachment, retractable cord, and sanitary ear-cushion cover.

### Model ST-M Stereo "Masters" Headset

Low-impedance; 8-16 ohms; has two-way sound reproducers in each phone—dynamic low frequency and ceramic high fre-

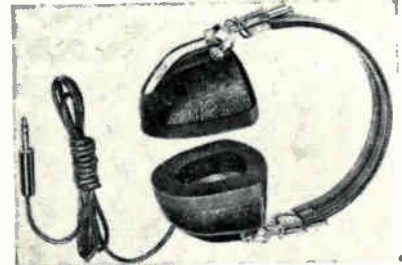

quency; response 20-20,000 cps; frequency response adjustable by control on ca. phone; complete with crossover network.....\$29.95

### Model ST-MH Stereo "Masters" Headset

Same as Model ST-M except high-impedance 600, 2000, 15,000, or 50,000 ohms .....\$40.00

### SX-800 Stereo Phones

Dynamic reproducer, lightweight (5 oz.) 30-15,000 cps; slim design. Has polyfoam



ear cushions & plastic ear cups; 4-16 ohms .....\$21.95

**SWITCHCRAFT**

**Model 670 Stereo Speaker Selector Switch**

For connecting two remote pairs of speakers to stereo amplifier; 3-pos. switch selects either or both pairs of stereo speakers..\$6.25

**Model 10FK25 Stereo Cable**

For use with 3-conductor dual-input tape recorders and for adapting single micro-

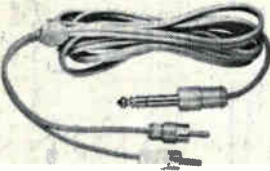

phone-input stereo recorders to stereo microphone mixers.....\$2.40

**Model 330H Flexible "Y" Adapter**

Adapts microphone input or speaker output of foreign-built tape recorders, such as Norelco, Grundig, Uher, and Korning, for use with standard Switchcraft phono plugs.....\$1.80

**Two-Input Audio Mixer**

Resistance type with approx. 3 db loss; inputs for 2 microphones with individual volume controls; various models available with different input jacks and output plug.....From \$7.95-\$9.95

**TELEX**

**Model ST-20 Headset**

Incorporates individual volume control for each stereo channel; remote control of stereo



balance and volume by means of self-contained miniaturized controls; response 16-15,000 cps; 4-16 ohms; 8-foot strain-resisting cord & plug.....\$29.15

**"Teleset" Headset**

Full-range response 50-10,000 cps; seven-way yoke for maximum comfort and best possible cup-to-ear position; 2000 ohms; 8 oz.; 6-foot cord.....\$13.20

**"Stereo-Twin" Headset**

Frequency response 16-15,000 cps; 3 to 16 ohms; power input required 5 mw.; max power input 2 w. continuous sine wave; dynamic driver element; weight 12 oz.; 8-foot cord. ST-10.....\$24.95

**"Dyna-Twin" Headset**

Response 30-20,000 cps; dynamic driver; washable foam rubber ear cups; adjustable yoke for individual fit; available with 3-circuit plug for stereo.....\$24.95

**Stereo Control Kit**

Remote control of stereo program; allows speakers to be switched on or off and sound level to be adjusted at each earpiece; comes complete with instructions for installation & 15-ft. cord.....\$10.50

1965 EDITION

Telex phones put individual Channel Control where it belongs...



**AT YOUR FINGERTIPS**

(and only TELEX has it)

Convenience... Precision channel control for perfect stereo balance... Freedom from the extra cost and encumbrance of a separate headphone control center.



That's what you get in the new Telex ST-20 stereo-phones. Smoothly styled control knobs on each earpiece provide separate sound level control for each channel. Exclusive with Telex, this superb fingertip convenience means you always listen at the ideal sound level... the ideal stereo balance.

Insist on seeing... and hearing... the amazing new Telex ST-20 with INTEGRAL

CHANNEL CONTROL. You'll thrill to the kind of pace setting performance you would expect from 26 years of Telex acoustic engineering leadership. Faithful, flawless sound provides breathtaking stereo realism for the most exacting. 16-15,000 cps. 4-16 ohms. Super soft cushions for the ultimate in noise abatement and comfort. \$29.15

A Product of Sound Research



**TELEX/Acoustic Products**

3054 Excelsior Blvd. • Minneapolis 16, Minn.

**TELEX**

CIRCLE NO. 71 ON READER SERVICE CARD



**ME? BUILD A WHAT?** An Artisan electronic organ, naturally. It's not necessary to be a genius either. We'll admit it's just difficult enough to be a challenge. There's transistorized circuitry in your favor with Artisan, plus simplified instructions. What do you have when you finish? An instrument we modestly call magnificent, with the nearest thing to the tonal qualities of a pipe organ. Right in your own home. What about price? You'll keep 50% of the cost of a ready-built organ. And you may buy a module at a time, literally "play as you pay". Get the complete Artisan story now. Write Dept. R



a division of Electronic Organ Arts, Inc.  
2476 North Lake Avenue/Altadena, California

CIRCLE NO. 6 ON READER SERVICE CARD



# DIRECTORY OF

# Hi-Fi Dealers

*Complete listing of all U.S. High-Fidelity Salons. Visitors are welcome, not only to view available audio products but, in most cases, to participate in actual sound demonstrations.*

## ALABAMA

**BIRMINGHAM**  
 Audio Hi-Fidelity Co., 1705 Oxmoor Road  
 Forbes Distr. Co., 2600 3rd Ave., S  
 Godwin Radio Co., 3131 4th Ave., S  
 Lawrence Hi Fi, 1927 11th Ave., S  
 Music Unlimited, 4116 Cliff Road

**FLORENCE**  
 Lari Distributing, 118 W Tombigee

**HUNTSVILLE**  
 Electronic Wholesalers, Inc., 2310 Bob Wallace, SW

**MOBILE**  
 Sound Shop of Mobile, 1651 Government St.

**MONTGOMERY**  
 Record Shop, 107 Normandale  
 Thornton, John A. Co., 3448 Atlanta Hgwy.

**SHEFFIELD**  
 Powell Electronics Supply Co., 3906 Jackson Hgwy.

**TUSCALOOSA**  
 Audio House, 505 15th St.

## ALASKA

**ANCHORAGE**  
 Anchorage Radio & TV, 716 5th Ave.  
 Arrow Electronics, Box 1664  
 Audiocam Corp., 328 4th Ave.  
 Commercial Electronics, 603 E. 5th Ave.  
 Shimeks Record Shop, 409 4th St.

**FAIRBANKS**  
 Co-Op Photo Shop, P.O. Box 1308  
 Music Shop, 525 Second Ave.

**JUNEAU**  
 Alaska Music Supply, 124 Stewart St.  
 Alaska Radio Supply, 307 Seward St.  
 Garrison Radio & TV Service, Box 986

**KETCHIKAN**  
 Music Shop, P.O. Box 1578

**MT. EDGECOMB**  
 Music Box, P.O. Box 455

## ARIZONA

**MESA**  
 Hi-Fi Sales Co., 735 W. Main St.

**PHOENIX**  
 Arizona Hi Fi House, 4807 N. Central  
 Arizona Music Center, 3819 N. 56th Ave.  
 Audio Specialists, 333 E. Camelback Rd.  
 Bruce's World of Sound, Inc., 2711 E. Indian School Rd.  
 Electronic Center, Inc., 3400 E. Thomas Rd.  
 Hessler's Stereo Center, 1915 E. Camelback Rd.  
 High Fidelity Sound Systems, 1809 E. McDowell Rd.  
 Sound Craft International, 4770 N. Central Ave.  
 Soundcraft Stereoland, 4750 N. Central Ave.  
 Southwest Wholesale Radio, 126 S. Second St.  
 Woody Feill Sound & Music, 5500 N. 19th Ave.

**TUCSON**  
 Hi Fi House, 2024 S. Craycraft  
 Niles Radio, 400 N. Fourth Ave.

Sound Shop, Inc., 4659 E. Broadway  
**YUMA**  
 Yuma Radio-Television Inc., 149 Main St.

## ARKANSAS

**FT. SMITH**  
 Wise Radio Supply, 1001 Towson Ave.

**HARRISON**  
 Custom Hi Fi, 604 N. Maple

**LITTLE ROCK**  
 Moses, 505 Main St.

## CALIFORNIA

**ALHAMBRA**  
 Harmony Hi Fi, 1020 E. Main St.

**ANAHEIM**  
 Allied World of Music, 912 Euclid  
 Audiophonics, 1083 N. Harbor Blvd.  
 Federated Purchaser, 266 N. Manchester  
 Gold Star Whise. Electric Supply, 505 S. Brookhurst  
 Henry Radio, 931 N. Euclid  
 Stereo Mark, 979 S. Los Angeles  
 White Front Store, 16040 Sherman Way

**APPLE VALLEY**  
 Richardson, J.R., Box 1145, Newton Bldg.

**ARCADIA**  
 Hornbrook Sound Systems, 71 E. Foothill Blvd.  
 Mitchell's El Rancho Hi Fi, 1127 W. Huntington Dr.  
 Scope Ent., Sound Div., 71 E. Foothill Blvd.

**AZUSA**  
 Rancho Hi Fi Sound, 18532 E. Alosta St.

**BAKERSFIELD**  
 Bakersfield Audio, 2534 "F" St.  
 Specialized Sound Service, 2304 Belle Terrace

**BALDWIN PARK**  
 Baldwin Park Electronic, 1842 N. Puente Ave.

**BARSTOW**  
 Galyean's Music & Camera Store, 215 E. Main

**BELLFLOWER**  
 Darnall Color Print Service, 17642 S. Clark Avenue  
 Giant Electronics, 8635 Artesia Blvd.

**BERKELEY**  
 Berkeley Custom Electronics, 2302 Roosevelt  
 Cal Hi Fi, 1085 University  
 McDaniel's Hi-Fi, 2984 College Ave.  
 Pacific Electronics, Inc., 2801 Shattuck Ave.  
 Robert W. Lee, 2533 Telegraph Ave.  
 Sounding Board, 2342 Shattuck  
 Thos. Tenney, 2984 College  
 Zackit Corp., 2140 University Ave.

**BEVERLY HILLS**  
 Red Man T.V., 253 So. Beverly Dr.

**BUENA PARK**  
 Ford Electronics, 8431 Commonwealth

**BURBANK**  
 Advance Hi Fi, 831 N. Hollywood Way  
 Audio Mart, 921 W. Magnolia Ave.  
 Burbank Wholesale Radio, 1303 W. Magnolia Ave.  
 Electronic City, 4001 Burbank Blvd.

**CANOGA PARK**  
 Sandy's Electronic Supply, 21305 Satcoy St.  
 West Valley Electronic Sales, 22033 Sherman Way

White Front Store, 21300 Roscoe Blvd.

**CARMEL**  
 Bayard Radio, 6th near Dolores St.  
 California Music House, Dolores bet. 5th & 6th

**CASTRO VALLEY**  
 Calbar Custom Electronics, 3223 Castro Valley Blvd.

**CHICO**  
 High Fidelity Mart, 120 Broadway  
 Stereo Center, 1474 Mountain View

**CHINA LAKE**  
 Desert Music Service, 207-A Byrnes

**CHULA VISTA**  
 Chula Vista Electronics, 453 Broadway

**CLAREMONT**  
 Jay Doty's Inc., 224 Yale Ave

**COMPTON**  
 Marten Sales Co., 1506 N. Long Beach Blvd.

**COSTA MESA**  
 Atlantic Music Co., 445 E. 17th St.  
 Harbor Hi Fi, 270 E. 17th St.  
 High Fidelity Assoc., 1922 Harbor Blvd.

**COVINA**  
 Acorn-Arrow Electric, 1065 W. Badillo St.  
 Hi Fi Covina, 127 E. Rowland  
 West Covina Whise. Electric 1107-21 Sylvan Ave.  
 White Front Store, 1151 N. Azusa Ave.

**CULVER CITY**  
 Bar-Shel's TV & Hi Fi, 5512 S. Sepulveda Blvd.  
 Elect. Trading Post, 4364 Sepulveda Ave.  
 Hi Fi Matic, 5554 Sepulveda Blvd.  
 Sid Moses T.V., 11218 W. Washington Blvd.

**DOWNEY**  
 Master Electric Supply, 8356 Firestone Blvd.  
 Net Electronics, 8315 Firestone Blvd.

**EL CAJON**  
 El Cajon Electronics, 182 E. Main St.

**EL CENTRO**  
 Music Box, 644 South 8th

**EL CERRITO**  
 Hi-Fi Center, 11224 San Pablo Ave.

**ENCINO**  
 I.F.A. Electronics, 17640 Burbank Blvd.  
 Western Sound, 17544 Ventura Blvd.

**ESCONDIDO**  
 Roy's Radio-Television, 344 E. Grand Ave.

**EUREKA**  
 Custom Audio Center, 1905 Fairfield St.  
 Photo Specialty Shop, 511 F. Street

**FONTANA**  
 Weaver Radio & TV, 12725 Foothill Blvd.

**FRESNO**  
 AFCO, 5374 N. Blackstone  
 Audio Sales Co., 1209 E. Belmont  
 Shafer (Schiefer) Sound, 2247 Blackstone  
 Stephenson-Bradford, 624 W. Olive  
 Tingey Company, 847 Divisadero

**FULLERTON**  
 Pacific Recorders, 1532 Commonwealth Ave.

**GARDENA**  
Stereo Hi Fi Center, 13996 S. Crenshaw Blvd.  
Video Suppliers, 14526 S. Crenshaw Blvd.

**GARDEN GROVE**  
Dusty's Hi Fi, 9909 Garden Grove Blvd.  
Knowlton, R.E. & Assoc., 13219 Harbor Blvd.  
State Electronics, Inc., 13225 S. Harbor Blvd.

**GLENDALE**  
Audio Systems Inc., 1600 Victory Blvd.  
Medico Electric Labs, 1111 E. Chevy Chase Dr.  
Radio Lab, 806 S. Central Ave.

**GOLETA**  
Electronics Components of Goleta, 5957 Hollister

**GRANADA HILLS**  
North Valley Electronic Sales, 10146 Balboa Blvd.

**HARBOR CITY**  
Beacon Electronics, 1517 W. Pacific Coast Hwy.

**HAYWARD**  
El's Discount Electronics, 31161 Mission Blvd.  
Styles & Engelman, Inc., 25343 Cypress St.

**HEALDSBURG**  
Merle Smith, 508 West St.

**HOLTVILLE**  
Carl's Radio Service, 134 E. 5th St.

**HOLLYWOOD**  
Audio Industries Corp., 1419 North LaBrea  
Hollywood Electronics, 7460 Melrose Ave.  
Hollywood Radio & Electronics, Inc., 5250 Hollywood Blvd.  
Sunset Electronics Corp., 6249 Santa Monica Blvd.

Van Leeuwen & Assoc., 7122 Melrose Av.  
Wallich's Music City, 1501 N. Vine St.

**INDIO**  
Custom Classics, 82-735 Miles Ave.

**INGLEWOOD**  
Acorn Radio & Electronics, 4736 W. Century Blvd.  
Del Re Electronics, 235 S. Glasgow  
Inglewood Electric Supply, 4701 W. Century Blvd.  
International TV Corp., 599 S. LaBrea Ave.  
Newark Electronics, 4747 W. Century Blvd.  
Olson Electric Of Inglewood, 4642 W. Century

**LA CANADA**  
Audio Corner, 655 Foothill Blvd.

**LAKEWOOD**  
Wallich's Music City, Inc., 5255 Lakewood Blvd.

**LANCASTER**  
Audiotech Assoc., 818 W. Lancaster Blvd.  
Loewen & Sons, 755 W. Lancaster Blvd.  
Manley's TV Supply, 45003 N. Yucca St.

**LA PUENTE**  
Audio Shoppe, 1629 1/2 N. Hacienda

**LODI**  
Guptill's, 22 S. School St.  
Poser & Coe, 208 S. School St.

**LOMA LINDA**  
University Supply, 11147 Anderson St.

**LONG BEACH**  
Acorn-Arrow Electric, 4686 Long Beach Blvd.  
Barkus TV, 5782 E. 2nd St.  
Crest Electronics, 501 Ximeno Ave.  
K-T Electronics, 1885 Atlantic Ave.  
Nantais Elec., 6574 Paramount Blvd.  
Scott Audio Corp., 266 Alamitos St.

**LOS ALTOS**  
Audio Center, 293 State Street  
Audio Interiors, 164 Main Street

**LOS ANGELES**  
Acorn-Arrow Electric, 1015 S. Figueroa St.  
Adray's Appl. & Photo Ctr., 7366 Beverly Blvd.  
American Music Co., 426 S. Broadway  
Arco Electronics, 111 S. Vermont Ave.  
Atlantic Music Co., 1414 S. Atlantic Blvd.  
Atlas Radio & TV, 1044 Venice Blvd.  
Audio Graphics, 8118 1/2 W. Third  
Beverly Electronics, 8413 Beverly Blvd.  
Bohmann's Hi Fi, 707 S. Hoover St.  
California Electric Supply, 11201 W. Pico Blvd.  
Chibaro T.V., 122 W. Ave. 33  
Crenshaw Hi Fi Center, 107 Santa Barbara Plaza  
Dave's TV Service, 8839 David Avenue  
Doug. Roesch Comm., 2727 San Fernando Rd.  
Electronic Components of Westwood, 2008 Westwood Blvd.  
Federated Purchaser, 11820 W. Olympic Blvd.  
Figart's Radio Supply, 6320 Commodore Sloat Dr.  
Franklin Electronics, 5945 Gregory Ave.  
Gmora Stereo Center, 12024 Wilshire Blvd.  
Gold Bros., 1137 S. La Cienega Blvd.  
Henry Radio, 11240 W. Olympic Blvd.  
Hi-Fi Corner, 7901 Melrose Ave.  
Hollywood Electronics, 7460 Melrose Ave.  
International TV Corp., 2772 W. Olympic Blvd.  
Loomis Audio, 12225 Wilshire Blvd.  
Magnetic Recorders, 7120 Melrose Ave.  
Midway Electronic Supply, 2817 Crenshaw Blvd.  
Pacific Radio Exchange, 1351 N. Cahuenga Blvd.

Papel Bros., 4652 E. Third St.  
Radio Product Sales, Inc., 1501 South Hill St.  
S & F Electronics, 7959 Melrose Ave.  
Shelley Berman Stereo Hi-Fi Center, 1581 Westwood Blvd.  
Sound Foyer, 1501 S. Hill St.  
Sound Foyer, 1421 S. Hill St.  
Southland Sound Corp., 5641 E. Washington  
Sunset Electronics, 6249 Santa Monica Blvd.  
Trico Music Co., 5517 Venice Blvd.  
Universal Radio Supply, 1729 S. Los Angeles St.  
Weingarten Electronics, 7556 Melrose Ave.  
Wholesale Radio & TV Supply, 4301 S. Figueroa St.

Yale Radio Electric, 6616 Sunset Blvd.  
Wallich's Music City, Inc., 1501 N. Vine St.  
Westchester Hi Fi, 9125 S. Sepulveda Blvd.

White Front Store, 5344 W. Jefferson Blvd.  
White Front Store, 7651 S. Central Ave.  
Woody Winkler, 6041 E. Olympic Blvd.

**MODESTO**  
Inland Electronic Suppliers, 1518 Ninth  
Radio Electronics, 1226 "H" St.

**MENLO PARK**  
McDaniel Hi Fi, 935 El Camino Real

**MERCED**  
Ken's Cameras, 17 & "K" Streets

**MILBRAE**  
La Cor Camera & Hi Fi, 401 Broadway

**MONTEREY**  
Zackit Elect. of Monterey, 350 Del Monte

**MONTEREY PARK**  
Audio Crest Co., 1110 S. Atlantic

**MOUNTAIN VIEW**  
McDaniel's Hi-Fi, 1355 El Camino Real  
Cal Hi Fi, 1347 El Camino Real

**NAPA**  
Boyd-Wonn Hi Fi Shop, 929 Main St.  
Napa Camera Stereo Shop, 935 Main St.

**NEWPORT BEACH**  
Custom Audio, 2630 Avon  
Electronic Enterprises Inc., 3112 Newport Boulevard  
Harbor Hi Fi, 3333 Newport Blvd.

**NORTH HOLLYWOOD**  
Arrow Sales, Inc., 7035 Laurel Canyon Blvd.  
Chesney Stereo Center, 11335 Camarillo St.  
Concert Master Sound, 11548 Addison St.  
Honig Distributor Co., 6452 Lankershim Blvd.  
Olson Electric Of No. Hollywood, 5356 Lankershim Blvd.

**NORTH SACRAMENTO**  
California TV Supply, 2537 Del Paso Blvd.

**OAKLAND**  
Fidelity Sound, 3311 Grand Ave.  
Fisher Electronics, 520 13th St.  
General Electronics, 4156-58 Piedmont Av.  
True Recording Co., 3883 Piedmont Ave.  
E.C. Wenger Elect. Co., 1450 Harrison St.  
White Front Stores, 633 Hegenberger Rd.

**ONTARIO**  
Rudi Pock Stereo, 604 N. Euclid Ave.

**ORANGE**  
Fidelity Sound, 138 S. Orange

**OXNARD**  
Electronics Components of Oxnard, 1505 S. Oxnard Blvd.

**PACOIMA**  
White Front Store, 9725 Laurel Canyon Blvd.

**PALM SPRINGS**  
Hallmark TV & Electronics, 192 S. Indian Ave.  
H & S Electronics Service Corp., 600 S. Williams Rd.  
Help Electronics, 137 Tamarsk Rd.  
Palm Springs Music Co., 360 N. Palm Canyon Dr.  
Pat Barbara Music, 121 S. Palm Canyon Dr.

**PALO ALTO**  
Town & Country Music, 127 Town & Country Shopping Ctr.  
Zack Electronics, 654 High St.

**PASADENA**  
Arrow Sales Inc., 2650 E. Colorado St.  
Dow Radio, Inc., 1759 E. Colorado Ave.  
Electronic Components, 1759 E. Colorado Blvd.  
Hams, Inc., 401 E. Green St.  
Henry Radio Co., 431 E. Green St.  
Hi Fidelity House, 563 S. Fair Oaks Ave.  
Stereo Mart, 3205 E. Foothill Blvd.

**PASO ROBLES**  
Roy's TV Den, 1311 Park St.

**POMONA**  
Remo Radio & TV, 1090 S. Garey St.

**PLEASANT HILL**  
Valco Electronics, 1482 Contra Costa Hwy.

**RED BLUFF**  
Hoyt's Music Service, 811 Jackson St.

**REDDING**  
The Music Box, 1350 Butte St.

**REDONDO BEACH**  
Bay Electronics, 2315 Artesia Blvd.  
Griffey Electric Sales, 235 N. Pacific Coast Hwy.

**REDWOOD**  
Valco Electronics, 713 Arguello St.

**RESEDA**  
Harwood Bros., 7D15 Reseda Blvd.  
Roth Electronics, 7225 Reseda Blvd.  
West Valley Electronic Sales, 7041 Reseda Boulevard

**RIDGECREST**  
Desert Music Services, 133 Garnet Street  
Le Roy's Furniture, 144 Balsam Ave.

**RIVERSIDE**  
Audio Designers, 4010 Merrill Ave.  
Custom Music, 3980 Main Street  
Hi-Fi Music Room, 6746 Brockton Ave.  
Hi-Fi Shop, 3643 Main St.  
Massey's Radio Supply, 2944 8th St.

**SACRAMENTO**  
Hi-Fidelity Shop, 1910 16th St.  
Industrial Sound & Telephone, 2001 El Camino  
Lombard's Electronics, 1830 Jay St.  
Mal Sykes TV & Hi Fi, 1720 Fulton Ave.  
Podium, The, 1005 12th St.  
Stereo Showcase, 335 Balmoral Dr.  
Zackit Corp., 1020 14th St.

**SALINAS**  
Gadsby's Music Co., 342 Main St.  
Sound and Service, 14 E. San Luis St.

**SAN BERNARDINO**  
Barnes, Geo. & Son, 3358 N. "E" St.  
Sound Lab, 1839 N. "E" St.  
White Front Store, 499 Orange Show Rd.

**SAN CARLOS**  
Fortune Electronics, 930 El Camino Real  
Guaranteed Electronics, 930 El Camino Real

Holmes Hi Fi, 1227 Laurel St.

**SAN DIEGO**  
Audio Enterprises, 4204 Voltaire St.  
Borgens Music, 700 Broadway  
Breier Sound Center, 3781 Fifth Ave.  
David Arden Enterprises, 4337 Fairmount Ave.  
Electronic Components, Inc., 2060 India St.  
Electronic Equipment Dist., 3686 El Cajon Blvd.  
High Fidelity House, 1635 University Ave.  
Lewtons Radio & TV Service, 4251 University Ave.  
McAdams Stereo Center, 3170 El Cajon Blvd.  
Pacific Beach Elect., 972 Garnet Ave.  
Recording Center, 3941 Fifth Ave.  
Silvergate Radio Supply, 1528 India St.  
Telrad Electronics, 3453 University Ave.  
Wright's House of Hi Fi, 5140 El Cajon Blvd.

**SAN FERNANDO**  
Cassell's, 1013 San Fernando Road

**SAN FRANCISCO**  
Associated Radio Distributors, 1929 Market St.  
Allegra Hi Fi, 367 Market St.  
Ayoub Bros. T.V. & Appliance, 2600 San Bruno Ave.  
Bay Listening Post, 2290 Fillmore St.  
Bronstein Music, 333 Grand Avenue  
Carousel Electronics Supply Co., 1480 Market St.  
Columbia Music & Electronics, Inc., 1080 Market St.  
Eber Electronics, 2355 Market St.  
Emporium, 345 Jessie St.  
Fortune Electronics, 2280 Palou Ave.  
Hal Cox, Inc., 3325 Fillmore St.  
House of Sound, 104 Ninth St.  
Lafayette Radio & Electronics, 1480 Market St.  
Lakeshore Hi Fi, 222 W. Portal  
Listening Post, 2290 Fillmore  
Market Radio Supply, 1276 Market St.  
San Francisco Radio Supply, 1284 Market St.  
Skinner Hirsch & Kay, 229 Kearney St.  
Thalia Hi Fi, 171 Maiden Lane  
West Coast Radio & Elec., 539 Market St.  
Walter Willey, 691 Market St.  
John Wolfe & Co., 345 Sutter St.  
Zack Electronics, 1444 Market St.

**SAN JOSE**  
Alco Paramount, 79 S. Third  
Audio Phils of Music City, 448 S. Winchester Blvd.  
House of Hi Fi, 399 1/2 San Carlos  
Jimmie's Stereo Village, 1439 W. San Carlos  
True Sound, 3400 Stevens Creek Road  
United Radio & TV Supply, 1425 W. San Carlos  
White Front Store, 1551 Moorpark Ave.

**SAN LEANDRO**  
Radio Shack Corp., Bay Fair Shopping Center  
Styles & Engleman, 2255 Bancroft  
Valco Electronics

**SAN LUIS OBISPO**  
Allen's Sound Center, 771 Figuera St.

**SAN MARINO**  
San Marino Hi Fi, 2986 Huntington Dr.

**SAN MATEO**  
Mateo Hi Fi, 2199 El Camino Real  
Teachout Associates, 2347 S. El Camino Real  
Quality Electronics, 1707 Gum St.

**SAN PEDRO**  
Bower's Music, 810 S. Gaffrey St.

**SAN RAFAEL**  
Camera Corral, 555 Francisco Blvd.  
Catinia Sound, 1541 Fourth  
Klein T.V., 3rd & Francisco

**SANTA ANA**  
Arrow Sales Inc., 2713 S. Main St.  
Campbell's Audio, 2122 N. Main St.  
Gracies Records, 228 N. Broadway  
Gracies Records, 304 W. Third St.  
Hi Fidelity Associates, 2220 N. Main St.  
Hi Fi Associates, 1812 N. Main St.  
Lowenstein's, 1508 S. Main St.  
United Hi Fi Inc., 304 W. Third St.

**SANTA BARBARA**  
Audio Center, 3321 State St.  
Audio Vision Co., 3951 State St.  
Chanel Radio Supply, 18 E. Ortega St.  
Electronic Kit & Parts Center, Inc., 513 State St.

**SANTA CLARA**  
Adamo Music Center, 3511 El Camino Real  
Audio Phil, 1805 Pruneridge

**SANTA CRUZ**  
Burdick TV & Appliance, 902 Soquel Ave.  
Dick Harton-Symphony In Sound, 1040 N. Branciforte  
Santa Cruz Electronics, 289 Water St.

**SANTA MARIA**  
Custom Sound, 114 W. Church St.  
Electronic Components of Santa Maria, 222 W. Main St.  
Lombard's Electronics, 311 N. McClelland

**SANTA MONICA**  
Clef Television, 1641 Ocean Park Blvd.  
Midway Electronic Supply Co., 732 Santa Monica Blvd.  
Tonecraft, 218 26th St.

**SANTA ROSA**  
Bruner, M.L. Company, 532 Medocino Ave.  
Golden Ear, The, 1612 Fourth St.

**SAUSALITO**  
Klein T.V., 14 Princess

**SIERRA MADRE**  
J.M. Clark Co., 501 W. Ramona Ave.

**SOUTH GATE**  
Mac's Radio Supply, 8320 Long Beach Blvd.

**SO. PASADENA**  
Executone S. Calif. Co., 1136 S. Fair Oaks

**STOCKTON**  
Jack Hanna Music, Inc., 6130 Pacific Ave.

**STUDIO CITY**  
Emmons Audio Equipment, 12600 Ventura Blvd.

Valley Sound Div., 12123 Ventura Blvd.  
Valley Tape Recorders, 12220 Ventura Blvd.  
**SUNNYVALE**  
Sunnyvale Electronics, 534 S. Murphy Ave.  
**SYLMAR**  
X-Perimental Eng. Co., 13811 Eldridge  
**TEMPLE CITY**  
Jim's Radio & TV, 9518 Las Tunas  
**TORRANCE**  
Torrance Electronics, 1545 W. Carson St.  
Wallich's Music City, Inc., 17540 Hawthorne Blvd.  
**THOUSAND OAKS**  
Valley Electronic Supply Co., 2884 Ventura Blvd.  
**TUJUNGA**  
Hi Fi Sound Mart, 7487 Foothill Blvd.  
Woodall's Camera Shops, P.O. Box 476  
**TUSTIN**  
Halin Electronics, 12991 Newport Ave.  
**VALLEJO**  
Boyd Wonn Hi Fi, 923 Tennessee St.  
Electronic Best Buys, 1219 Monterey  
Hi Fi Shop, 923 Tennessee St.  
Zackit Corp., 1815 Sonoma Blvd.  
**VAN NUYS**  
Audio Design, 6449 Blewett  
Dulco Sound Systems, 16927 Sherman Way  
Edison Electronics, 17635 Sherman Way  
Gates Electronics, 7118 1/2 Van Nuys Blvd.  
House of Sight & Sound, 14513 Victory Blvd.  
Thrifty Electric Supply, 13647 Burbank Blvd.  
Valley Electronic Supply Co., 17647 Sherman Way  
White Front Store, 16040 Sherman Way  
**VISALIA**  
Bill's House of Sight and Sound, 750 So. Mooney Blvd.  
**VISTA**  
TV Craftsmen, 516 E. Vista Way  
**WALNUT CREEK**  
Stevenson Electronics, 1531 Locust St.  
**WATSONVILLE**  
Jansen's Music, 435 Main St.  
**WHITTIER**  
Custom Audio & Elec., 14403 Cerecita  
Hi Fi Haven, 442 S. Greenleaf Ave.  
Lovells, 174 N. Greenleaf Ave.  
Oxbow Electronics, 15908 E. Whittier Blvd.  
**WOODLAND HILLS**  
Vega Associates, 20549 California St.  
Woodland Sound, Inc., 21620 Ventura Blvd.  
**YUBA CITY**  
Music World, 219 Clark St.

## COLORADO

**BOULDER**  
Lauer, John E., 1032 13th St.  
**COLORADO SPRINGS**  
Dick Jurgens Hi-Fi, 530 S. Tejon St.  
**DENVER**  
Allegru Music Shop, 262 Fillmore St.  
Burstein-Applebee Co. of Colo., 1237 16th St.  
Electric Accessories Co., 1620 Blake St.  
Electronic Parts Co., 1277 Broadway  
Empire Radio & Television Co., 1100 Broadway  
Fistell's Electronics Supply Co., 1001 Bannock  
Gramophone Shop, 2904 E. 3rd Ave.  
Heathkit Electronic Center, 2901 N. Sheridan Blvd.  
Howard Sound Corp., 843 Broadway  
Johnny Lakewood Sound, 8596 W. Colfax Ave.  
Lorton, Howard Galleries, 724 Speer Blvd.  
Lloyd's Hi Fi Shop, 410 S. Colorado Blvd.  
Radio Products Sales, 1237 16th St.  
Sound in the Round, Inc., 562 S. Broadway  
Voice and Vision, 5705 E. Colfax Ave.  
Walker, L.B. Radio Co., 300 Bryant St.  
Ward Terry & Co., P.O. Box 896  
Warren LeRoy Audio, 3460 S. Bellaire  
**GOLDEN**  
Golden Sound, Route #3  
**GREELEY**  
Ken's Camera & Hi Fi, 1513 8th Ave.  
**LITTLETON**  
Carlson's for Music, 5767 S. Gallop  
**PUEBLO**  
Pueblo Radio TV Supply Co., 119 W. 13th St.

## CONNECTICUT

**BRIDGEPORT**  
Congress Electrical Supply Co., 250 Maplewood Ave.  
Hi-Fi Center, 94 Congress St.  
Lafayette Radio, 2710 Fairfield  
Packer Electronics, 142 Shelton St.  
Tobias Electronics, 560 Noble St.  
**FAIRFIELD**  
Bader's Television Maint. Corp., 1527 Black Rock Tnpk.  
**DANIELSON**  
S & S Electronics, 10 Hawkins St.  
**GREENWICH**  
Greenwich Radio & TV Co., 56 W. Putnam Ave.  
**HAMDEN**  
Vinco-Electronic Corp., 12 Foch St.  
**HARTFORD**  
Belmont Record Shop, 165 Washington St.  
Dressler Electronics, 325 Trumbull St.  
Hatry of Hartford, 100 High Street  
Landers Electric Sales, 88 Flower St.  
Nathan Margolis Shop, 28 High St.  
Stereo Record Shop, 227 Asylum St.  
Sound Room, The, Washington & Park Sts.  
**KENSINGTON**  
Modern Electronics Supply Inc., 1224 Farmington Ave.  
**MIDDLETOWN**  
G.U. Reed Co., 154 Main St.  
**MILFORD**  
Miller Electronics, Inc., 458 Naugatuck Ave.

REM Sound Systems, 44 Cornflower Dr.  
**NEW CANAAN**  
Custom Design of Fairfield, Inc., 103 Main St.  
Tele Tech Service, 36 East Ave.  
**NEW HAVEN**  
Amrad Company, 222 Congress St.  
Audio Den, 69 Broadway  
Cutlers Record Shop, 333 Broadway  
David Dean Smith, 262 Elm St.  
H.B. Motion Picture Service, Audio Lane #21  
Radio Elec. Supply Corp., 57 Whalley Ave.  
Radio Shack Corp., Tower Shoppers Arcade  
Radio Shack Corp., 92 York St.  
Radio Shack Corp., 230-34 Crown St.

**NEW LONDON**  
Gray Electronic Supply, 1004 Bank St.  
**NORTH HAVEN**  
Jerry Chichester Stereo, 67 State St.  
**PAWCATUCK**  
The TV Shop, Hincley Hill  
**STAMFORD**  
Atlantic Electric Co., 441 Atlantic St.  
Phonograph Shop, 66 Broad St.  
Radio Shack Corp., 29 High Ridge Road  
**STONINGTON**  
Lovine Electric, Harvey Road  
**TRUMBULL**  
E.J. Korvette, Old Town Road & Main St.  
**WATERBURY**  
Bond Radio, 439 W. Main St.  
**WEST HARTFORD**  
Audio Workshop, Inc., 1 S. Main St.  
High Fidelity Salon, 298 Park Road  
Radio Shack Corp., 39 S. Main St.  
**WEST HAVEN**  
Dalby Elec. Supply, 47 Elm St.  
**WESTPORT**  
Beck & Quint, 238 State St.  
Music Systems of Westport, Inc., 1021 E. State St.

## DELAWARE

**CASTLE**  
Lafayette Assoc. Store, 1420 Dupont Blvd.  
**GEORGETOWN**  
Fred E. Lynch, 129 Anderson St.  
**NEWARK**  
Delaware Music House, 132 E. Main St.  
**WILMINGTON**  
Almo Radio Company, 1122 French St.  
D & M Radio & Elect. Co., 214 W. 4th St.  
Delaware Electronic Supply, 220 W. 4th St.  
Merritt K. Armor, 3401 Limestone Rd.  
Radio Electronic Service, S.E. Corner 3rd & Tatnall  
Sloa Camera Center Inc., 108 W. 9th St.  
Willard S. Wilson Inc., 405 Delaware Ave.  
Zomie Electronics, 5th & French Sts.

## DIST. OF COLUMBIA

Audio Specialists Inc., 1605 Conn. Ave., N.W.  
Commissioned Electronics, 1776 Columbia Rd., N.W.  
Custom Hi Fi Radio TV Co., 1811 Columbia Rd., N.W.  
Electronic Parts, Inc., 635 F. Street, N.W.  
Electronic Wholesalers Inc., 2345 Sherman Ave., N.W.  
Emco Wholesalers Inc., 509 11th St., N.W.  
Fidelity Sound, 1022 18th St., N.W.  
Kitt Music Company, 1330 "G" St., N.W.  
Penn Electronic Parts Co., 1501 Pennsylvania Ave.  
Rucker Electronic Parts Co., 1320 14th St., N.W.  
Shrader Sound Inc., 2803 M Street, N.W.  
Silberne Radio & Elec., 3400 Georgia Ave., N.W.  
Sun Parts Dist., 514 10th Street, N.W.

## FLORIDA

**BOCA RATON**  
Dix Electronic Inc., 3060 N. Federal Hgwy.  
**CLEARWATER**  
Towers TV, 2119 Gulf to Bay Blvd.  
**DAYTONA BEACH**  
Anthony, Inc., 858 N. Nova Road  
**FORT LAUDERDALE**  
High Fidelity Assoc., 1620 N. Federal Hgwy.  
Music Center, Inc., 1009 E. Sunrise Blvd.  
**GAINESVILLE**  
Black's Audio, 229 W. University Ave.  
**INDIALANTIC**  
McHose Music, Inc., 239 5th Ave.  
**JACKSONVILLE**  
Chaz Harris Music, 1409 University Ave.  
Hoyt Hi Fi, Lakewood Shopping Center  
Hoyt Hi Fidelity, 4477 Roosevelt Blvd.  
Moss Electronics, 2623 Atlantic Blvd.  
Southeast Audio Co., 1125 Rosselle St.  
**LAKELAND**  
Carl's Radio & TV, 105 W. Main  
**LARGO**  
West Coast Sound, 1756 N. Missouri Ave.  
**MELBOURNE**  
Electronic Wholesalers, 1301 Hibiscus Blvd.  
**MIAMI**  
Amerex Trading Co., 149 NE 1st St.  
East Coast Elec. Inc., 1900 Northwest Miami Ct.  
Electronic Equipment Co., Inc., 2701 N.W. 42nd Ave.  
Electronic Wholesalers Inc., 9390 N.W. 27th St.  
Flagler Radio Company, 1068 W. Flagler St.  
High Fidelity Assoc., 3180 Biscayne Blvd.  
High Fidelity Assoc., 3396 Coral Way  
Sound Box, 11530 S. Dixie Hgwy.  
Southeastern Wholesale Elec. Inc., 1365 N.W. 23rd.  
**MIAMI BEACH**  
Miami Beach Radio, 1229 Lincoln Road

## NAPLES

House of Hi Fi, 742 Fifth Ave., So.  
**ORLANDO**  
Olson Electronics, 600 N. Orange Ave.  
**PANAMA CITY**  
Central Electronic Supply, 316 Luverne Ave.  
**PENSACOLA**  
F.T.C. Brewer, 1714 N. Pace Blvd.  
Grice Elec. Inc., 300 E. Wright St.  
Tru Fidelity Systems, 908 N. Spring St.  
**SARASOTA**  
Buders Tele Radio Hi Fi, 2104 Bee Ridge Rd.  
Hess Sound & Elec., 1015 Gen. Spaatz Blvd.  
**ST. PETERSBURG**  
Cooper Radio Co., 165 13th St.  
Ewin Radio & TV, 720 2nd Ave., So.  
**TALLAHASSEE**  
North Florida Hi Fi, 418 E. Tennessee  
Tallahassee Sales, 505 W. Gaines St.  
**TAMPA**  
Burdette Sound & Recording, 3619 Henderson Blvd.  
Viviano Stereo & Hi Fi, 3200 W. Hillsborough Ave.  
Yale Hi Fi, 2732 Florida Ave.  
**TITUSVILLE**  
Stereo Store, Baldwin Shopping Center  
**WEST PALM BEACH**  
Goddard Dist. Inc., 1000 N. Federal Hgwy.  
Goddard Dist. Inc., 1309 N.W. 27th Ave.  
Henry Pearson, 509 S. Olive  
Knapp TV, 6415 S. Dixie Hgwy.  
Salon of Music, 915 So. Dixie Hgwy.  
**WINTER HAVEN**  
Carter's, 1393 Sixth St., N.W.  
**WINTER PARK**  
Audiotronics, Inc., 918 Orange Ave.  
Laird Electronics, 802 W. Fairbanks Ave.  
The Music Box, 333 Park Ave., So.

## GEORGIA

**ATLANTA**  
Audio Stereo, Inc., 2929 Peachtree Rd., N.E.  
Baker Audio, 1140 Peachtree St., N.E.  
High Fidelity SSS, 3319 Peachtree St., N.E.  
L & M Electronics, 3693 Roswell Road, N.E.  
Norman's Hi Fi, 4029 Peachtree Rd.  
Olson Radio of Atlanta, 485 Peachtree St.  
Stereo Center Inc., 666 Peachtree St., N.E.  
**AUGUSTA**  
Home Folks News & Record Shop, 8th & Ellis St.  
N & W Camera Exchange, 220 Eighth St.  
Prestwood Electronics, 1445 Greene St.  
**COLUMBUS**  
Dan's Tape & Hi Fi Center, 1208 First Ave.  
Dan's Tape Center, 2611 N. Lumpkin Road  
**Macon**  
Phillips Audio Ltd., 536 Broadway  
**SAVANNAH**  
Norwood Record Shop, 210 E. Broughton St.

## HAWAII

**HONOLULU**  
Audio Center, Ltd., 1633 Kapiolani Blvd.  
Music City, 1520 Kona St.

## IDAHO

**BOISE**  
Dave's, 610 S. Owyhee  
Record Rack, 612 N. Orchard  
Robbie Supply Co., 3715 State St.  
Visual Sound Inc., 22 N. Latah St.  
**BOZEMAN**  
AMC Sullivan Photo, 107 E. Main St.  
**BUTTE**  
Tretthewey's Music Box, 59 E. Park St.  
**COEUR D'ALENE**  
Camera Center, 118 N. 45th St.  
**HELENA**  
Valtron Recording, 305 Allen St.  
**IDAHO FALLS**  
Hart's Inc., 2630, N. Yellowstone  
Lafayette Radio Electronics, 1363 N. Highway  
Schwendiman's Wholesale Dist., 910 E. Lincoln  
**LEWISTON**  
Steiners Electronics  
**LIVINGSTON**  
Electronics Inc., 119 N. Main St.  
**MISSOULA**  
Dickinson Music, 1805 Brooks St.  
**MOSCOW**  
Moscow Music Center, 206 S. Main  
**NAMPA**  
High Fidelity, Route #5  
John Rawlings Hi Fi, Route #5  
Winther Music Co., 117 13th Ave. So.  
**TWIN FALLS**  
Factory Radio & TV Center, 420 Main St.

## ILLINOIS

**ALTON**  
Ebinger Radio Inc., 1022 E. Broadway  
**AURORA**  
Cook's Hi Fi, 47 Fox St.  
Hi Fi Record Shop, 47 Fox St.  
**BELLEVIEW**  
Plaza Music Center, 18 Bellevue Park Plaza  
**BERWYN**  
Jack's Photo Shop, 6509 Roosevelt Road  
**BLOOMINGTON**  
House of Dumont, 1104 E. Oakland  
**BROADVIEW**  
The Larkins Co., 1307 Roosevelt Rd.  
**CARTHAGE**  
Wade's Hi-Fi, 708 Buchanan  
**CHAMPAIGN**  
Radio Doctor's Hi-Fi, 811 W. Springfield  
**CHICAGO**  
Allied-Evergreen, 2025 W. 95th St.

Allied Hi-Fi Store, 921 N. Rush St.  
 Allied Radio Corp., 100 N. Western Ave.  
 Allied Radio Warehouse Outlet, 1201 W. Washington St.  
 AudioCraft, 11639 S. Ashland Ave.  
 Behrend Cine Corp., 161 E. Grand Ave.  
 Boom Electric Co., 5226 W. Grand Ave.  
 Broadway Radio & Tele., 5530 N. Broadway  
 Chicago Audio Associates, 2300 W. Garfield Blvd.  
 Devon Audio Center Inc., 2909 W. Devon Ave.  
 Electronic Distributors Inc., 4900 N. Elston  
 E-Z Teletronics, 2825 W. 59th St.  
 Ferrari Inc., 1217 N. LaSalle St.  
 Fried's Inc., 3801 W. 26th St.  
 Gill's Custom House, Inc., 8805 S. Euclid Ave.  
 Gill's Custom Sound, 1403 E. 95th Street  
 Heath Kit Electronic Center, 3462 W. Devon  
 Irving Joseph Radio Parts, Inc., 1733 N. Harlem  
 Lambert Electronics, 4029 W. Montrose  
 MusiCraft, 48 E. Oak St.  
 Neill, R.W. Company, Inc., 4320 Montrose  
 Newark Electronics, 223 W. Madison St.  
 Olson Electronics—Evergreen, 2641 W. 95th St.  
 Olson Electronics of Chicago, Inc., 4101 Milwaukee Ave.  
 Olson Electronics-Western Inc., 123 N. Western Ave.  
 Ralph's Hi Fi, 5310 W. North Ave.  
 Schwartz Bros. Hi Fi, 8637 S. Cottage Grove  
 Schwartz Bros. Hi-Fi, 1215 E. 63rd St.  
 Sherwood Electronic Laboratories, Inc., 4300 N. California Ave.  
 Sonotronics, 11758 S. Western Ave.  
 Tri-Par Radio & Appliance Co., 30 S. Wells St.  
 Winkler Sales Co., 5353 Milwaukee Ave.  
**DECATUR**  
 Electronic Distr., P.O. Box 576  
 Schuerman Radio Co., 128 S. Illinois  
**ELMHURST**  
 E.J. Korvette Inc., 575 W. St. Charles St.  
**EVANSTON**  
 Allied Hi-Fi Store, 602 Davis St.  
**EVERGREEN PARK**  
 Allied Radio, 2025 W. 95th St.  
 Radio Shack Corp., Evergreen Plaza  
**FRANKLIN PARK**  
 Rich Engineering, Inc., 3531 Martens St.  
**GALESBURG**  
 Knox Electronic Supply, Inc., 67 North Cherry Street  
 The Platter, 67 S. Prairie St.  
**HIGHLAND PARK**  
 Columbia Hi-Fi, 1805 St. Johns Ave.  
 Rozak Bros. Hi Fi, 1805 St. Johns Ave.  
**JACKSONVILLE**  
 Baptist Elec. Supply Co., 419 S. Mauvaisterre  
**LAKE FOREST**  
 Grant and Grant Inc., 658 Bank Lane  
**LIBERTYVILLE**  
 The Hi-Fi Center, 424 S. Milwaukee  
**MATTESON**  
 E.J. Korvette Inc., 4200 Lincoln Hgwy.  
**MCHEMERY**  
 McHenry Elect., 3102 W. Lincoln Rd.  
**MORTON GROVE**  
 E.J. Korvette Inc., Golf & Waukegan Rd.  
 Martin Elec., 5636 W. Dempster  
**MT. PROSPECT**  
 Hillside Music Center, Randhurst Shopping Center  
**NORTH CHICAGO**  
 Sound Unlimited, 817 10th St.  
**OAKLAWN**  
 Greater Chicago Service, 9266 S. Cicero Ave.  
 E.J. Korvette Inc., 8700 S. Cicero Ave.  
**OAK PARK**  
 Allied Radio-Oak Park, 7055 W. North Ave.  
 Tri-Par, 811 W. Madison St.  
**PARK RIDGE**  
 Northwest Music Center, 107 S. Northwest Highway  
**PEORIA**  
 Electronics Diversified, 3919 N. Sheridan  
 Hi Fi One Stop, 804 Main St.  
 Klaus Radio & Elec. Co., 403 E. Lake St.  
 James Mueller Co., 610 W. Main  
 Selectronics Supp., Inc., 803 S. Adams  
**RIVERDALE**  
 Audio Distr., 14218 S. Indiana Ave.  
**ROCKFORD**  
 Leonhardt Engineering Co., 5126 E. State St.  
 Schnulle's Hi-Fi Shop, 1413 N. Main St.  
**ROCK ISLAND**  
 Van Goor's One Stop, Inc., 1715 Second Ave.  
**SCHILLER PARK**  
 Pace Electronics, 3804 25th Ave.  
**SPRINGFIELD**  
 Miller's Hi Fi, 1101 E. Linn  
 The Music Shop, 220 S. Fifth St.  
 Town & Country Record Shop, 2325 S. McArthur Blvd.  
 United Radio & Electronics, 217 E. Washington St.  
**VILLA PARK**  
 P-G Electronics Inc., 631 W. North Ave.  
**ZION**  
 Wright Electronics, 3059 Sheridan Rd.

1965 EDITION

Lefferson Radio, 405 S. Walnut  
 Stansifer Radio Co., 105 S. Walnut  
**BREMEN**  
 Bremen Radio Clinic, West on U.S. 6  
**COLUMBUS**  
 Preston Sound Equipment, 1453 Washington St.  
 H.A. Williams Co., 1003 Washington St.  
**DUBLIN**  
 A.R. Bradford & Son  
**EAST CHICAGO**  
 Acro Distributing Co., 1101 W. Chicago Ave.  
**ELKHART**  
 John Likins Hi Fi, 1111 Kilbourn Ave.  
**EVANSVILLE**  
 Dave Risley Electronics, 2207 W. Franklin  
 George C. Mettle Co., 17 S.E. 1st St.  
 Kyler Sound Service, 9th and Vine St.  
 Ohio Valley Sound, 20 E. Sycamore  
 Sam Wherry Hi Fi House, 1702 Division St.  
**FORT WAYNE**  
 Lafayette Radio Associates, 3101 N. Clinton  
 Maxwell Radio, 804 E. Jefferson  
**GARY**  
 Cosmopolitan Radio, 523 Washington St.  
**HAMMOND**  
 Hall's Electronic Distributors, 7428 Calumet  
 Hall's Radio Service, 7428 Calumet  
 Tri City Electric Co., 6241 Calumet  
**HARTFORD CITY**  
 Heistrom Hi Fi, Park Avenue  
**INDIANAPOLIS**  
 Graham Electronics, 122 S. Senate Ave.  
 Lafayette Radio Electronics, Inc., 5603 E. Washington  
 Pearsens Platters, 6000 E. 46th St.  
 Raub Radio & TV, 5906 College Ave.  
 Radio Distributing Co., 814 N. Senate Ave.  
 Waltman Hi Fi, 4121 N. Keystone Ave.  
**LAFAYETTE**  
 Audio & Electronics, 664 E. Main St.  
 Lafayette Radio Supply Inc., 405 E. North St.  
 Sound Productions, 119 Northwestern Ave., W  
**MICHIGAN CITY**  
 Blieden's Camera Center, 510 Franklin St.  
**MUNCIE**  
 Muncie Electronics, 222 N. Madison St.  
 Saunderson Electronics, 512 S. Liberty  
**OWENSBORO**  
 Wilson Bros., 2630 New Hartford Rd.  
**PERU**  
 Clingeman Sound, 814 W. Main St.  
**PORTLAND**  
 Buck's Radio & Sport Shop, 305 N. Middle St.  
**RICHMOND**  
 Fox Electric Co., Inc., 711 S. 9th St.  
 House of Sound, 57th & G Street  
**ROLLING PRAIRIE**  
 Rolling Sound Service, State Road 2, 350 East  
**SHELBYVILLE**  
 Maley Camera Center, 214 S. Harrison  
**SOUTH BEND**  
 Colfax Company, 747 S. Michigan  
 Radio Distributing Co., 1212 High St.  
 Smith Record Bar, 128 W. Washington  
 Al Smith, 412 S. Michigan Ave.  
**ST. JOHN**  
 Knollwood Hi Fi, No. Joliet Rd.  
**TERRE HAUTE**  
 C.T. Evinger Co., 1216 Wabash St.  
 Midwest Electronics, 2015 Garfield Ave.  
**VALPARAISO**  
 Jess Bowman & Associates, 257 W. Lincoln Way  
**WABASH**  
 Merk's Camera & Hi Fi, 14 W. Canal

**IOWA**

**AMES**  
 Audio Lab, 120 Main St.  
 Rogers TV, West Lincoln Hgwy.  
**BETTENDORF**  
 Fairlane Electronics Co., 1212 Fairlane Dr.  
**BURLINGTON**  
 Union Supply, 231 S. Third  
**CEDAR RAPIDS**  
 Holland Standards Inc., 407 Second Ave. S.E.  
 Iowa Radio Supply Co., 719 Center Point Rd., N.E.  
 Sound Inc., 420 Guaranty Bldg.  
 Time Photo Co., 1413 1st Ave.  
**COUNCIL BLUFFS**  
 Broadway Stereo Center, 710 W. Broadway  
 World Radio Laboratories, 3415 W. Broadway  
**DAVENPORT**  
 TCR Distributors, 1205 E. River Dr.  
 Van Goor's Record Shop, River & Main Sts.  
**DES MOINES**  
 Iowa Sound, 1210 Grand  
 Mid-State Distributing Co., 1201 Grand  
 Radio Trade Supply Co., 1216-24 Grand  
 Sherwood Music Inc., 7552 Hickman Road  
**DUBUQUE**  
 Modern Music with High-Fid., 599 Main St.  
 Sound Unlimited, 485 Arlington St.  
**FORT DODGE**  
 Ken-Els Radio Supply, 429 Central Ave.  
**IOWA CITY**  
 Woodburn Sound Service, 218 E. College St.  
**KEOKUK**  
 Stereo Sound Center, 1128 Fulton St.  
**SIoux CITY**  
 Dukes Radio Company, 209 Sixth St.  
 Wolff's Hi Fidelity, 1915 Pierce St.  
**WATERLOO**  
 Farnsworth Radio & Television, 201-205 E. Mullan

**KANSAS**

**DODGE CITY**  
 Dodge Music & Jewelry, 720 Second Ave.

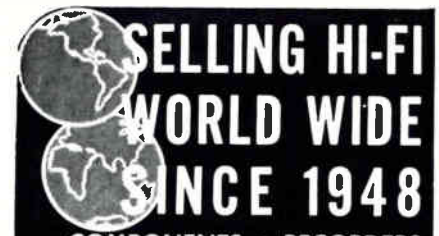

**COMPONENTS • RECORDERS  
 KITS • SPEAKER SYSTEMS • TAPE**

- LOWEST PRICES
- TIME PAYMENT PLAN
- ALL BRAND NEW FACTORY SEALED
- MFRS. GUARANTEES UP TO 5 YEARS
- FAST, INSURED SHIPMENTS
- GET 'QUOTES' on PACKAGE DEALS AND SAVE MORE
- SAME DAY REPLY TO YOUR HI-FI INQUIRY
- PARKING METERS AT PREMISES

• SPECIAL STEREO DYNE II DIAMOND STEREO CARTRIDGE — \$7.25 ppd.  
 Send for FREE "MONTHLY SPECIALS" on other Cartridges, Tapes, and Components.



**CIRCLE NO. 12 ON READER SERVICE CARD**

**SAVE MONEY on  
 NATIONALLY  
 ADVERTISED BRANDS  
 HI-FI  
 COMPONENTS  
 TAPE  
 RECORDERS**

\* \* \*

**TAPES,  
 ACCESSORIES  
 SLEEP LEARN KITS  
 MERITAPE  
 Top Quality Recording Tape**

- Franchised Distributors
- Factory Sealed Cartons
- Up to 2 yrs. Mfgr. Warranty

Write for our  
**VERY LOW QUOTATIONS**

**FREE CATALOG**

**DRESSNER**

1523 Jericho Tpke, New Hyde Park, N.Y.  
 Visit Our Show Room  
**CIRCLE NO. 19 ON READER SERVICE CARD**





**MISSISSIPPI**

**BILOXI**  
Egan's Music Store, Tontan at W. Howard

**COLUMBUS**  
Custom Sound, 208 Airline Rd.

**GULFPORT**  
E.A. Helwick, 2832 13th St.

**JACKSON**  
Armet Corp., 625 E. McDowell Rd.

**MERIDIAN**  
Buck's Record Shop, 2319 8th St.

**VICKSBURG**  
Michel's Recod Shop, 1410 Washington St.

**MISSOURI**

**BADEN**  
Almo Sound Service, 1134 Belgrove

**CALIFORNIA**  
George's Music House, P.O. Box 322

**CAPE GIRARDEAU**  
Suedekum Electronics, 2215 Broadway

**CLAYTON**  
Aeolian Co. of Mo., 7754 Forsyth  
Jones & Davis, 522 S. Hanley Rd.

**CRESTWOOD**  
Aeolian Co. of Mo., 39 Crestwood Plaza

**INDEPENDENCE**  
Don Cook's Hi Fi Music Center, 1020 W. Truman Rd.

**JEFFERSON CITY**  
St. Mary's Radio & TV, 120 E. McCarty  
Townner Radio and TV, 710 Jefferson

**JOPLIN**  
Four State Radio Supply Co., Inc., 402 Wall Street

**KANSAS CITY**  
Barnard's Hi-Fi, 4724 Broadway  
Beaty, David Hi-Fi, 1616 Westport Rd.  
Burststein-Applebee Hi-Fi, 301 E. 55th St.  
Burststein-Applebee Co., 1012 McGee St.  
Henshaw Radio Supply, 3430 Independence  
Henshaw Radio Supply, 3617 Troost St.  
Jenkins Music Co., 1217 Walnut  
Macys Sound Studio, 11th & Baltimore  
McGee Radio Co., 1901 McGee St.  
Superior Sound Co., 1016 Baltimore Bldg.

**KIRKWOOD**  
Kirkwood Camera, 122 W. Jefferson Ave.

**ROLLA**  
Show-Me Electronics, Highway 72

**ST. LOUIS**  
Aeolian Co. of Mo., 1004 Oliver  
Almo Sound Service, 1134 Helgrove Dr.  
Walker Ashe Radio Co., 1125 Pine St.  
Hi-Fi West, 8217 Delmar Blvd.  
High Fidelity Showroom, 6383 Clayton Road  
Hollander and Co., 3900 W. Pine Blvd.  
Motronics Inc., 64321 Hampton Ave.  
Radionics Elec. Inc., 4445 Gustine  
Tronic Service, 5450 Gravois  
Van Sickle Radio Co., 1113 Pine St.

**SPRINGFIELD**  
Reed Radio and Supply Co., 805 Boonville Ave.

**WEBSTER GROVE**  
Napper Radio, 7979 Big Bend Rd.

**MONTANA**

**BILLINGS**  
Electronic Supply Co., 250 11th St. W.  
Klier Sound, 15 N. 31st St.

**GREAT FALLS**  
Electric City Rd. Sply., 2315 10th Ave. S.  
Music Service Co., 320 6th St. S.

**MISSOULA**  
Dickinson Music, 1805 Brooks St.  
Electronic Parts, 2104 Brooks  
Northwest Dist., 509 S. Higgins

**NEBRASKA**

**FREMONT**  
Electronics Service Co., 610 N. Main St.

**LINCOLN**  
Electronics Unlimited, 414 S. 11th St.  
Leuck Radio Supply, 243 W. 11th St.  
Scott Electronic Supply Corp., 2201-07 "O" Street

**OMAHA**  
House of Hi Fi, 7001 Dodge St.  
J B Distributing Co., 1616 Cass Street  
J B Electronics, 1618 Cass St.  
Moss, Terry & Assoc., 1908 California St.  
National Sound Equip. Co., 1212 Farnam St.  
Omaha Electronic Co., 2222 Leavenworth St.

**NEVADA**

**LAS VEGAS**  
Audiophile Center, 911 E. Sahara Ave.  
Electronic Supply Co., 1112 S. 2nd St.  
Garehime Music Co., 115 N. Third St.  
Greg Gelhart Co., 704 Upland Place

**RENO**  
Electronic Dist. of Nevada, 720 Tahoe St.  
Rempel, Art Sound Supply Co., 460 S. Wells Ave.

**NEW HAMPSHIRE**

**CONCORD**  
A & J Sound Service, 15 Eastside Dr.  
Evans Radio, P.O. Box 3112

**EAST CONCORD**  
Concord Audio Service, 251 Eastman St.

**MANCHESTER**  
Lafayette Radio Electronics, 40 Bridge St.  
Manchester Music Co., 89 Manchester St.  
Radio Shack Corp., 1247 Elm St.

**PORTSMOUTH**  
D & D Distributors, 18 Pleasant St.

**NEW JERSEY**

**ASBURY PARK**  
Dart Electronics, 1109 Highway 35  
Lafayette Radio, 1027 Highway 35

**ATLANTIC CITY**  
Almo Radio Company, 4401 Ventnor Ave.  
Kearnes Inc., 300 N. Miss. Ave.  
Radio Elec. Serv. Co. of N.J., 452 N. Albany Ave.

**AUDUBON**  
E.J. Korvette, Black Horse Pike and Nicholson Road

**BERLIN**  
Midstate Radio Supply Co., 157 W. White Horse Pike

**CAMDEN**  
Almo Radio Company, 1133 Haddon Ave.  
General Radio Supply Co., Inc., 600 Penn Street  
Radio Elec. Service Co. of Camden, 513 Cooper St.

**COLLINGSWOOD**  
Don Christ Music Co., 267 Haddon Ave.

**CRANFORD**  
Stuarts Audio, 8 Alden St.

**DOVER**  
Kay Distr., 75 W. Blackwell

**EAST ORANGE**  
Custom Music, 4 Washington St.  
Gem Electronics, Central Ave.

**EATONTOWN**  
Bamberger Studio 293, Eatontown Shopping Center  
Bamberger's Custom Audio, Monmouth Shopping Center  
Hi Fi Sound Center, Route #35

**ENGLEWOOD**  
German Bros., 28 E. Palisade Ave.  
Music Manor, 32 E. Palisade Ave.

**FORT LEE**  
Deal Television, 169 Main St.

**FRANKLIN LAKES**  
Franklin Lakes Custom Stereo Center, 792 Franklin Ave.

**GARFIELD**  
Leeds-Fox, 200 Passaic St.

**JERSEY CITY**  
Levy Co., 149 Monticello  
Massa Sales & Service, 434 Central  
Massa Sales & Service, 75 Palisade

**LINDEN**  
The Lee Creighton Co., 740 Haven Pl.

**LYNDHURST**  
Custom Fidelity, 530 Riverside Dr.

**MARGATE CITY**  
F. John Pessolano, Jr., 505 N. Pembroke

**MENLO PARK**  
Bamberger's Custom Audio, Menlo Park Shopping Center

**MONMOUTH**  
Bamberger's, Monmouth Shopping Ctr.

**MONTCLAIR**  
Perdue Radio, 8-10 S. Park St.

**MORRISTOWN**  
Libro Audio Center, Inc., 117 Morris

**NEWARK**  
Bamberger's Custom Audio, 131 Market Street  
Lafayette Electronics, 24 Central Ave.  
Sound Reproductions, 34 New Street

**NEW BRUNSWICK**  
Gem Electronics, Route #18  
Hi Fi Haven, 28 Easton Ave.

**NO. WILDWOOD**  
Lectron Service Co., 19th & New Jersey Ave.

**PARAMUS**  
Bamberger's Custom Audio, Garden State Shopping Plaza  
E.J. Korvette, Rt. 4 & Spring Valley Rd.  
Gem Electronics, Route #17  
Lafayette Electronics, 182 Route #17  
Leonard Radio, Route #17  
Music Age, 171 Route #17

**PASSAIC**  
Sam Goody, Garden State Shopping Plaza

**PASSAIC**  
R.H. Sonnenberg Co., 65 Lexington

**PATERSON**  
Bremy Electronics, 394 E. 18th St.  
Community Sound, 705 Market St.  
Magnetic Recording, 344 Main St.

**PLAINFIELD**  
Lafayette Electronics, 139 W. 2nd St.

**PRINCETON**  
Princeton Music Center, 7 Palmer Square West

**ROSELLE**  
Sound Arts Co., 736 Sheridan Ave.

**SPRINGFIELD**  
Creative Audio Associates, 40 Briar Hills Circle  
Disco Elec. Inc., 469 Route 22  
Federated Purchaser, Route 22

**TEANECK**  
Linsey Electronics, 943 Teaneck Rd.

**TOTOWA**  
Gem Electronics, Route 46

**TRENTON**  
George's Stereo Center, 120 S. Broad St.  
Geosonic Corporation, 122 S. Broad St.  
House of Hi Fi, 965-61 Princeton Ave.  
E.J. Korvette, Olden & Princeton Aves.

**VINELAND**  
Almo Radio Company, 219 Landis Ave.

**WATCHUNG**  
E.J. Korvette, Blue Star Shopping Center

**WAYNE**  
Stereo Sound, 1581 Route 23

**WESTFIELD**  
Stuarts Audio, 17 Elm St.

**WEST NEW YORK**  
Levy's HiFi, 6118 Bergenline Ave.

**WYCOFF**  
Victor's House of Music, 633 Wycoff

**NEW MEXICO**

**ALBUQUERQUE**  
Audio Center, 2119 San Mateo Blvd, N.E.  
Audio Equipment Co., 2636 San Mateo Blvd, N.E.  
Electronic Parts Co., 222 Truman St., N.E.  
Photo Sound Corp., P.O. Box 11308 Station E  
Photo Sound Corp., 1510 Eubank Blvd., N.E.  
Sound Equipment Co., 3011 Monte Vista, N.E.  
Stereo Service, 812 San Mateo Blvd., S.E.

**FARMINGTON**  
Custom Hi Fi & Music, Mesa Shopping Center

**GALLUP**  
George Highth Studios, 212 South 2nd

**LAS CRUCES**  
Mannies TV, 802 South Soland  
Mannies TV & Radio Service, 230 S. Main  
Ed Noble Hi Fi Shop, 1952 Klein Ave.

**LOVINGTON**  
Acoustical Eng. Co., 1520 W. Tyler

**ROSWELL**  
Supreme Electronics, 129 W. 2nd St.

**SANTA FE**  
Sanders & Assoc., Inc., 70 W. Macey St.

**SILVER CITY**  
Smith Music & TV, 512 Bullard St.

**NEW YORK**

**ALBANY**  
Audio Video Co., 324 Central Ave.  
Fort Orange Radio, 904 Broadway  
Seiden Sound, 78 Central Ave.

**AMSTERDAM**  
Adirondack Radio Supply, 185 W. Main St.

**BAYSHORE**  
Macy's Bayshore, Sunrise Highway

**BETHPAGE**  
S & R Elec. Inc., 4020 Hempstead Tpk.

**BINGHAMTON**  
Audio Service Co., Inc., 168 Water St.  
Morris Distributing Co., Inc., 195 Water St.  
Stack Electronics Inc., 45 Washington St.

**BRONX**  
Concourse Rega TV, Inc., 2310 Grand Concourse  
Gem Electronics, 351 Grand Concourse  
Korvette, E.J., White Plains Rd. & Bruckner Blvd.  
Lafayette, 542 E. Fordham Rd.

**BROOKLYN**  
Abraham & Strauss, 420 Fulton St.  
Audio Exchange, 1065 Flatbush Ave.  
Bay Electronics, 3480 Nostrand Ave.  
Brooklyn Hi Fi Center, 1065 Flatbush Ave.  
Gem Electronics, 485 Coney Island Ave.  
Kitcraft, 738 Washington Ave.  
Korvette, E.J., 485 Fulton St.  
Laco Electronics, 4924 Fourth Ave.  
Phils TV, 19 Dalgren Pl.  
Sound Room, 1409 Bedford

**BUFFALO**  
Bergman, W. Electronics, Oak & Eagle Sts.  
Buffalo Audio Center, 47 Genesee St.  
Victor L. Cole Co., 1396 Main St.  
Denton Cottier & Daniels Inc., 32 Court St.  
F.M. Sound Equip. Corp., 1241 Main St.  
Olson Electronics of Buffalo Inc., 711 Main St.  
Purchase Radio Co., 747 Main St.

**CARLE PLACE**  
E.J. Korvette, Glen Cove Rd & Westbury Ave.

**CEDARHURST**  
Marrt Electronics, 690 Central Ave.

**CHITTENANGO**  
Farmers & Traders Exchange, Genesee St.

**EASTCHESTER**  
Boynton-Goodall, 737 White Plains Rd.

**ELMIRA**  
Chemung Electronics, 403 E. Third St.

**FARMINGDALE**  
Arrow Elect. Inc., 900 Broad Hollow Rd.

**FLUSHING**  
Allen Electronics, 41-42 Main St.  
Portonoy's, 147 W. 46th St.

**FOREST HILLS**  
Continental Sound, 107-27 Continental Ave.  
Gem Electronics, 101-10 Queens Blvd.  
Kitcraft, 70-50 Austin St.

**GARDEN CITY**  
Macy's Audio Dept., Roosevelt Field Shopping Center

**GENEVA**  
Frank Snow, Route 3, Lyons Road

**GLEN FALLS**  
Ray Supply, Upper Glen St.

**HEMPSTEAD**  
Abraham & Strauss, Hempstead Turnpike  
Newmark & Lewis, 43 Main St.

**HORNELL**  
Hornell Elec. & Motor Equip., 286 Main St.

**HUNTINGTON**  
Sam Goody, Inc., Walt Whitman Shopping Center  
E.J. Korvette, Walt Whitman Shopping Center  
Rite Electronics, 1946 New York Ave.

**ITHACA**  
Alcor Inc., Corner Green & Tioga  
Fred's Record Shop, 124 W. State  
Lent's, 210 N. Tioga St.

**JAMAICA**  
Audio Exchange, 153-21 Hillside Ave.  
Lafayette Electronics, 165-08 Liberty Ave.

**JAMESTOWN**  
Johnson Radio & Elect., 119 Hunt Road

**KENMORE**  
Sheridan High Fidelity Center, 2200 Sheridan Dr.

**KINGSTON**  
Greylock Elect. Distr., Albany Ave. Ext.

**LEVITOWN**  
Newmark & Lewis, 2557 Hempstead Turnpike

**LOCKPORT**  
Lockport Audio Center, 415 High St.

**LONG BEACH**  
Tilben Music, 60 W. Park Ave.

**LONG ISLAND CITY**  
Electronic Supply, 41-08 Greenpoint Ave.

**LYNBROOK**  
Dantomuro Furniture, 616 Merrick Rd.

**MAMARONECK**  
Custom Design of Westchester, 516 W. Post Road

**MANHASSET**  
Audio Exchange, 451 Plandome Rd.

**MERRICK**  
Electronics Unlimited, 1732 Sunrise Highway

**MIDDLETON**  
Certified Elec. Inc., Wicham Ave. Ext.

**MINEOLA**  
Arrow Electronics, 525 Jericho Turnpike  
Nassau Electronics, 471 Jericho Turnpike

**MT. VERNON**  
Gem Electronics, 70 E. Third St.

**NEWBURGH**  
Seaman's Photo & Hi Fi, 388 Broadway

**NEW HYDE PARK**  
Dressner Audio, 1523 Jericho Turnpike

**NEW YORK CITY**  
Airex Radio, 85 Cortlandt St.  
Alissa Audio, 1454 Lexington Ave.  
Almart, 11 E. 36th St.  
Arrow Electronics, 65 Cortlandt St.  
Asco Sound Corp., 115 W. 45th St.  
Audio Unlimited, 715 Second Ave.  
Bloomingdale's, Lexington at 59th  
Bryce Audio, 110 W. 40th St.  
Carston Studios, 125 E. 88th St.  
Central Stereo, 251 W. 42nd St.  
Dale Electronics, 244 W. 14th  
Efficient Dictating, 102 W. 44th  
Electronics World, 1799 First Ave.  
Electronic Workshop, 26 W. 8th St.  
Gem Electronics, 202 E. 44th St.  
Gem Electronics, 57 Willoughby St.  
Goody, Sam, Audio, 250 W. 49th  
Goody, Sam, East, 666 Third Ave.  
Grand Central Radio, 124 E. 44th St.  
Harmony House, 1083-85 Lexington Ave.  
Harrison Radio, 225 Greenwich  
Harvey Radio, 103 W. 43rd St.  
Heins & Bolte, 69 Cortlandt St.  
Hi-Fi Headquarters, 235 E. 60th St.  
Korvette, E.J., 47th at Fifth Ave.  
Lafayette Radio, 69 Cortlandt St.  
Long Electronics, 507 Fifth Ave.  
Leonard Radio, 1163 Sixth Ave.  
Liberty Music Shops, 450 Madison Ave.  
Lion Electronics, 215 Fulton Street  
Lyric Hi Fi, 1221 Lexington Ave.  
Macy's Audio Dept., Herald Square  
Marconi Brothers, 864 Lexington Ave.  
Masque Sound & Recording, 331 W. 51st  
Midway, 60 W. 45th St.  
Multiflex Corp., 220 E. 23rd.  
Music Masters, 25 W. 43rd  
North Radio, 62 Cortlandt St.  
Packard Electronics, 33 Union Square West  
Planet Audio & TV Center, 569 Third Ave.  
Rabsons, 119 W. 57th St.  
Schirmer, G., Inc., 4 East 49th St.  
Sonocraft, 115 W. 45th St.  
Sun Radio, 650 Sixth Ave.  
Terminal Hudson, 212 Fulton St.  
Terminal Hudson, 48 W. 48th St.  
Terminal Hudson, 3 W. 61st St.  
Terminal Hudson, 236 W. 17th St.  
Thalia Hi Fi, 762 Madison Ave.  
Trio Electronics, 159 Delancy St.  
Weikers, Julius, 4380 Broadway  
Wexler & Sporty, 125 Lafayette St.  
Willoughby Audio Exchange, 110 W. 32nd St.

**OLEAN**  
Blumenthal's Sport. Goods, Inc., 234 N. Union St.

**PATCHOGUE**  
Square Deal Radio, 39-41 W. Main St.

**PLAINVIEW**  
Gem Electronics, Old Country Road  
Lafayette, 111 Jericho Turnpike

**POUGHKEEPSIE**  
Dutchess TV, 5 Spackengill Rd.  
Higgins & Sheer Electronics, 105 Dutchess Turnpike  
LS Radio TV Sales & Service, 461 South Road

**ROCHESTER**  
Craig Audio Laboratory, 139 N. Union  
Eastman Appliance Co., 389 E. Main St.  
Fink, Jerry Co., 644 Clinton Ave., So.  
Hyatt, Robert M., 923 Harvard St.  
Rochester Radio, 140 W. Main St.

**ROME**  
B & W Television, 315 S. James St.

**ROSLYN**  
Audio by Zimet, 1038 Northern Blvd.

**SCARSDALE**  
Boynton Goodall, 737 White Plains Rd.  
Lafayette Electronics, 691 Central Park Ave.  
Westchester Audio, 8 Spencer St.

**SCHENECTADY**  
Reale's Distributors, 1957 Foster Ave.  
Seiden Sound, 141 Erie Blvd.

**SOUTH FARMINGDALE**  
Arrow Electronics, 900 Broad Hollow Rd.

**STATEN ISLAND**  
AAT Distributing Corp., 1854 Hylan Blvd.

**SYOSSET**  
Lafayette Electronics, 111 Jericho Turnpike

**SYRACUSE**  
Broome Distributors, 100 Tully St.  
Brown, W.G. Sound Center, 512 E. Washington St.

Cambridge Electronics, 468 Westcott  
Clark Music Company, Inc., 416 S. Salina St.  
Gordon Electronics, 935 W. Genesee St.  
Mace Electronics, 2740 Erie Blvd.  
Morris Electronics of Syracuse, Inc., 1153 W. Fayette  
Olmstead's Victrola Shop Inc., 752 S. Crouse Ave.  
Radio Shack Corp., 3057 Erie Blvd, E.  
Syracuse Radio Supply Co., 620 S. Salina St.

**TROY**  
Q & Q Electronic Supply, 666 River St.

**TUCKAHOE**  
Boynton Studio, 295 Main St.

**UTICA**  
Genesee Electronics Inc., 331 Broad St.  
Sound-O-Rama, 1411 Oriskany St.  
Vaith Elec. Co., 35 Genesee St.

**VALLEY STREAM**  
Gem Electronics, 218 Sunrise Highway  
Goody, Sam, Green Acres Shopping Center

**WAVERLY**  
Armstrong Music House, 30 Lincoln St.

**WEST HEMPSTEAD**  
Audiotronics, 96 Hempstead Turnpike

**WHITE PLAINS**  
Audio Exchange, 203 Mamaroneck Ave.  
Hub Electronics, 249 Tarrytown Rd.  
Macy's, 220 Main St.  
Westchester Elect., 602 Mamaroneck Ave.

**WOODSIDE**  
Boro Electronics, 69-18 Roosevelt Ave.  
Stevens, 5002 Queens Blvd.

**YONKERS**  
Goody, Sam Cross Country, Inc., 15 Xavier Dr.  
Westlab, 590 Tuckahoe Rd.

## NORTH CAROLINA

**ASHEBORO**  
Carolina Stereo & Hi Fi, 950 Trollinger Rd.

**ASHEVILLE**  
Bradley's High Fidelity Center, 826 Hendersonville Rd.  
High Fidelity Sales, Inc., 180 Biltmore Ave.

**BURLINGTON**  
Hunter Tr, 1353 S. Church St.

**CHAPEL HILL**  
Chez Kemp Ltd., 205-207 E. Franklin St.

**CHARLOTTE**  
Brodt Music Co., 1409 N. Independence Blvd.  
Dixie Radio Supply Co., 1431 Bryant St.  
Joe Little Record Shop, 126 W. 5th St.  
Holly Smith Cameras, 117 S. Tryon St.  
World Electronics, 1415 S. Tryon St.

**DURHAM**  
Troy's Hi Fi Stereo Center, 1106 Broad St.  
Troy's Hi Fi, 614 Trent St.

**FAYETTEVILLE**  
Eastern Radio Supp. Co., Inc., 835 Bragg Blvd.  
M.S.D. Stereo Center, 101 Hay St.  
Southeastern Radio Suppl., 404 N. Eugene St.

**GASTONIA**  
Stroup Hi Fi, 112 Green Drive

**GOLDSBORO**  
Melody Shop, Sunrise Shopping Center  
Womak Elect. Corp., 106 N. Caroline St.

**GREENSBORO**  
Harvey West Music Co., 224 W. Market St.

**HENDERSONVILLE**  
Joy Record & Hi Fi Center, Spartanburg Hwy.

**HICKORY**  
Southeastern Radio Supply, 325 Rowan St.

**JACKSONVILLE**  
Southeastern Radio Supply, 1009 LeJeune Blvd.

**KINSTON**  
Southeastern Radio Supply, 408 N. Heritage St.

**RALEIGH**  
Moff's Music Ltd., 2418 Hillsboro St.  
Southeastern Radio Supply, 414 Hillsboro St.  
Stephenson's Music, Camerson Village

**SALISBURY**  
Southeastern Radio Supply, 316 N. Depot St.

**WILMINGTON**  
Southeastern Radio Supply, 1815 Dawson St.

**WILSON**  
Southeastern Radio Supply, 321 Goldsboro St.

**WINSTON-SALEM**  
Electronic Wholesalers, 938 Burke St.  
Trayer-Yelverton Inc., 1018 Brookstown Ave.

## NORTH DAKOTA

**FARGO**  
Wolter Elect. Co., 402 N. Park Ave.

## OHIO

**AKRON**  
Electronic Engineering Co., 362 W. Bowery Street  
Olson Electronics, 260 S. Forge St.  
Olson Radio Corp., 68 W. State St.

**ASHTABULA**  
Morrison's Radio Supply, 331 Center St.

**CANTON**  
Canton Stereo Center, 3023 Cleveland Ave.  
Walker Radio, 3301 Harrison, N.W.  
Walkeradio Inc., 1546 Fulton  
Wille, Geo. C. & Co., 601 Cleveland Ave. N.

**CHAGRIN FALLS**  
Stereo Design Inc., 322 Overlook Dr.

**CHESTERLAND**  
Stereo Design Inc., 8515 Herrick Dr.

**CHILLICOTHE**  
Wholesale Electronics, 11-13 East Second

**CINCINNATI**  
Cincitronics, 606 Walnut St.  
Customcrafters Inc., 2259 Gilbert Ave.  
Economy Electronics Dist. Co., 619 Elm St.  
Hi Fi Audio Inc., 2000 Madison Rd.

Hi-Fi Music Company, 230 W. 4th St.  
Industrial Comm. & Sound, 3197 Linwood Ave.  
Steinberg's Inc., 633 Walnut St.

**CLEVELAND**  
Audio Craft Company, 2915 Prospect Ave.  
Briggs, Perry Co., 4135 W. 150th St.  
Bueschers Co., 1438 Euclid Ave.  
Custom High Fidelity, 13449 Euclid Ave.  
Electronic Products, 1231 Main Ave.  
F.T.Y. Electronics, 2001 Euclid Ave.  
Hillcrest Hi-Fi Center, 6717 E. Gate Dr.  
Hoffman's House of Stereo, 59321 Smith Road  
Johnson-Stipher, Inc., 1375 Euclid Ave.  
Music Unlimited, 13410 Detroit Ave.  
Olson Radio, 6813 Pearl Road  
Olson Radio Warehouse of Cleveland, 2020 Euclid Ave.  
Pioneer Electronic Supply Co., 5403 Prospect Ave.  
Radio & Electronic Parts Co., 3235 Prospect Ave.  
Seaway Elect. Supply, 2059 E. 105th  
Session Specialties Inc., 2118 E. 21st  
Shaker Music Shop, 16505 Kinsman Rd.  
Sound & Audio Elect. Labs, 1902 Euclid Ave.  
Stereo House of Music, 14807 Madison Ave.

**COLUMBUS**  
Anderson Hi Fi, 2244 Neil Ave.  
Decor Furniture, Inc., 155 Fairway Blvd.  
Electronic Supply Corp., 814 W. 3rd St.  
Gardner Inc., 1147 Cospeake  
Gee Electronics, 122 E. Long St.  
Magnetic Service Corp., 1670 W. 1st St.  
Olson Electronics, 142 N. High St.  
Palmer Eng., 1589 W. Fifth  
Rea's Variety Sales, 479 W. Rich St.  
Scott Stereo, 2388 W. Broad St.  
Whitehead Radio, 124 N. Grant St.

**DAYTON**  
Custom Electronics Inc., 1918 S. Brown St.  
Dayton Communications Corp., 760 S. Main St.  
Dayton Music Service Inc., 311 Salem Ave.  
Hauer Music Co., Inc., 3140 Far Hills Ave.  
Klopf Music Store, 323 Salem  
Srepcu Inc., 314 Leo Street  
Statfs-Friedman Co., 108 N. Jefferson

**ELYRIA**  
El-A-Co., 235 Lodi St.

**FINDLAY**  
Beagles, 113 W. Crawford

**FREMONT**  
Swartzlander Radio, 1524 Oak Harbor Rd.

**KETTERING**  
Hauer Music Company, 3140 Far Hills Ave.

**LANCASTER**  
Commercial Music Service, P.O. Box 20

**MASSILLON**  
M.H. Martin Co., 1118 Lincoln Way E.

**MENTOR**  
Mentor Tr, Inc., 7516 Mentor Ave.

**MIDDLETOWN**  
Hinkle's Electric, 5021 Grand Ave.

**NORWALK**  
Fisher Music & Electric House, 9 W. Main St.

**PAINESVILLE**  
Morrison's Radio Supply, 1430 Mentor Ave.

**PARMA**  
Winteradio Elec. Supply, 5367 Ridge Rd.

**SALEM**  
Jones Company, 1090 Jones Dr.

**SHAKER HEIGHTS**  
Adventures in Music, Inc., 20320 Farnsleigh Rd.  
Shaker Music Shop, 16505 Kinsman Rd.

**SPRINGFIELD**  
Hi-Fi Stereo Studios, 1230 Mitchell Blvd.

**STUEBENVILLE**  
Lafayette Radio Electronics, 411 Washington St.

**TIFFIN**  
Electro Alarms, 24 S. Washington St.

**TOLEDO**  
The Audio Center, 1546 Alexis Rd.  
The Jamieson Co., 3417 Dorr St.  
World of Sound, 3139 W. Central Ave.

**WARREN**  
Valley Electronics, 266 W. Market

**YOUNGSTOWN**  
Armies Electronics, 320 W. Federal St.  
Newport Music, 4224 Market St.  
Radio Parts Co., 1316 Market St.

## OKLAHOMA

**LAWTON**  
I.G.Cole's Town & Country Store, 1805 Cache

**MUSKOGEE**  
Sooner Radio & TV Supply, 110 Callahan

**NORMAN**  
Thomson Sound Systems, 315 W. Boyd

**OKLAHOMA CITY**  
Audio Specialties, 1010 N. Virginia  
General Electronics Inc., 1032 Classen Blvd.  
House of Sound, 4207 N. Western  
Larsen Music Co., 314 Park Ave.

Radio and Sound Clinic, 6433 Avondale  
Ultra Fidelity Sound, 4221 N.W. 56th Terrace

**STILLWATER**  
Audio Sound Systems, 507 S. Washington

**TULSA**  
Imperial Sound Inc., 3505 S. Peoria St.  
Radio, Inc., 1000 S. Main St.  
Sound Electronics Video Corp., 1520 S. Main  
Sound Unlimited, 3745 S. Peoria St.

**WOODWARD**  
Woodall Sound Services, 1822 13th St.

## OREGON

**BEAVERTON**  
Stereotronics, 11370 S.W. Canyon Rd.

**BEND**  
Owl Pharmacy, 358 Wall St.

**COOS BAY**  
Musicland, 135 S. 3rd St.  
**CORVALLIS**  
Chase Radio, 242 S. 2nd St.  
Day & Camp T.V., 916 Becca  
OSU Book Stores, Inc., M.U. Bldg.  
**EUGENE**  
Oregon Typewriter & Record, 1111 Willamette  
Thompson's, 62 W. Broadway  
**GRANTS PASS**  
Rolfings, 120 S.W. "B" St.  
**KLAMATH FALLS**  
Leo's Camera Shop, 836 Main St.  
**MEDFORD**  
Music Center, 126 E. Main  
Sound Shop, 1109 N. Riverside  
**PENDLETON**  
Pendleton Music House, P.O. Box 418  
The Town Shop, 142 S. Main  
**PORTLAND**  
Acme Sound, 2512 N.E. Broadway  
Astoria Business Equipment, 1124 Commercial  
Audio Craft, 11908 N.E. Halsey  
Cable Electronics, 5107 N.E. Sandy Blvd  
Columbia TV Mfg. Co., 4048 N.E. 42nd Ave.  
Hawthorne Electronics, 3580 S.E. Hawthorne  
Blvd.  
High Fidelity Unlimited, Inc., 2816 W. Sam  
Jackson Park Rd.  
J.K. Kida Company, 124 N.W. 3rd  
Oregon Hi Fi & Recorder Co., 500 S.W. Fifth  
Ott's Hi Fi & Radio, 3760 S.W. Hawthorne  
Blvd.  
Pooles Music Shop, 1373 Duane St.  
**ROSEBURG**  
Trowbridge Electric, 721 S.E. Oak Ave.  
**SALEM**  
Farnes Electronics, 442 N. Church

## PENNSYLVANIA

**ALLENTOWN**  
Daveland Co., The, 407 Linden St.  
Federated Purchaser, Inc., 1115 Hamilton St.  
Harte, E.J., 1339 1/2 Gordon St.  
Peters, A.A., 231 N. 7th St.  
Valley Supply Co., 101 N. 7th St.  
**AMBRIDGE**  
Central Radio & TV, 1194 Merchant St.  
**ARDMORE**  
Sounder Electronics Co., 45 W. Lancaster Rd.  
**BETHLEHEM**  
Buss Radio Elec. Supply, 421 W. Broad St.  
**BLAIRSVILLE**  
Holiday Electronics, 234 Market St.  
**CLIFTON HEIGHTS**  
Delaware Valley Electronics, 224 Baltimore Pike  
**EASTON**  
Maurice R. Everett, 1141 Jackson St.  
**ERIE**  
House of Records, 360 W. 8th St.  
**FAIRLESS HILLS**  
C.A. Rogers Audio Lab, 312 Oxford Valley Rd.  
**GETTYSBURG**  
Dave's Photo Supply, 244 Steinwehr Ave.  
**HARRISBURG**  
D.H. Distributors, 2535 N. 7th St.  
Music Box, 1325 Derry St.  
Radio Distributing Co., 915 S. 13th  
**IRWIN**  
C & S Sound Systems, 316 MacDonald Rd.  
**JOHNSTOWN**  
Hesselbein Sound Studio, Westmont Shopping  
Center  
**KING OF PRUSSIA**  
E.J. Korvette, Rt. 202 & Missile Rd.  
**KITTANNING**  
Richard L. Black, 336 Franklin Ave.  
**LANCASTER**  
Robert E. Gardner, 237 N. Mulberry St.  
Glick's Audio Sales, 2320 Hobson Rd.  
**McKEESPORT**  
Hi Fi Center, 321 6th St.  
**MEYERSDALE**  
Leo's Radio TV Sales & Service, 331 Myers  
Ave.  
**MIFFLINBURG**  
Wetzel's Jewelry & Gift Shop, 314 Chestnut  
**NEW CASTLE**  
Home Music Systems, 311 Neshannock Ave.  
**NEW KENSINGTON**  
RPC Electronics Co., 1102 Second Ave.  
**NORRISTOWN**  
Almo Radio Co., 550 Markley St.  
**PAOLI**  
Hi Fi Center, 1550 E. Lancaster  
**PHILADELPHIA**  
A.C. Radio Supply, 1539 W. Passyunk Ave.  
Air-Tone Sound & Record Co., 1710 Sansom St.  
Almo Radio Co., 913 Arch St.  
Arlen Supply Co., 6026 Market St.  
Barnett Bros. Radio Co., 622 Arch St.  
Danby Radio Corp., 19 S. 21st St.  
Dynaco Inc., 3912 Powelton Ave.  
Friend's, 614 Arch Street  
Goody, Sam of Philadelphia, 1125 Chestnut  
Street  
Jacob Bros. Music, 1718 Chestnut  
Levins Service Co. 3030 Kensington Ave.  
Radio Clinic, 154 S. 60th St.  
Radio Electric Service Co., 701 Arch St.  
Radio 437 Store, 437 Market St.  
Ree Bros. Elec., 7711 Ogontz Ave.  
Ten Cate Associates, 6128 Morton St.  
**PITTSBURGH**  
Cameradio Company, 1121 Pennsylvania Ave.  
Daktronics, 640 Grant St.  
House of Audio, 508 Stanwick St.  
Home, Joseph Co. Music Center, 217 Oliver St.  
Horne, Joseph & Co., Penn & Stanwick  
Metropolitan Elect. Dist., 113 S. Beatty St.

Modern Sound Co., Nobletown Road  
Olson Electronics, 3405 Saw Mill Run Blvd.  
Opus One, 225 Oliver Ave.  
Radio Parts Co., 6401 Pennsylvania Ave.  
Radio Parts Co., 929 Liberty Ave.  
Sampson Dist., 2406 W. Liberty Ave.  
Solar Electronics Inc., Northway Hall, Upper  
Level  
Tydings Company, 3337 Pennsylvania Ave.  
Walks Kamera Exchange, 308 Forbes St.  
**POTTSVILLE**  
Moyer Electronic Supply, 330 E. Norwegian St.  
**READING**  
Geo. D. Barbey, 219 Penn St.  
Maurice D. Buchert Enterprises, 155 W. Green-  
wich St.  
Electronic TV Dist. Inc., 201 S. 4th St.  
Rader & Fasig Inc., 938 N. 8th St.  
**ROSLYN**  
Grove Enterprises, 1373-83 Cedar Ave.  
**SCRANTON**  
General Radio & Refrigeration Co., 1129 Wyo-  
ming  
Scranton Sound Service, 1002 Cedar Ave.  
**STATE COLLEGE**  
Alvo Electronics Dist., 103 S. Pugh St.  
Shadie Associates, 151 S. Allen St.  
**ST. MARY'S**  
B & R Electric Co., 26 Railroad St.  
**SWARTHMORE**  
Hi Fi Studio, 8 Park Ave.  
Harry E. Oppenlander Hi-Fi, 8 Park Ave.  
**WASHINGTON**  
Electronic Sales & Service, 569 E. Maiden St.  
**WAYNE**  
High Fidelity House, 167 W. Lancaster Ave.  
**WILKES-BARRE**  
General Radio & Elec., 396 S. Main St.  
Modern Electronic Supply, 245 S. Main  
Shelborne Elec. Inc., 169 N. Penna. Ave.  
**WILLOW GROVE**  
Radio Electric Service Co., 2931 York Rd.  
Soundex Electronics, Easton & Old York Rd.  
**YORK**  
Sol Kessler's Hi Fi, 126 S. George  
Radio Elec. Service Co., of York, 650 Brill Rd.  
Rosen Electronics Co., 129 S. George St.  
Wholesale Radio Parts Co., 1650 Whiteford Rd.

## PUERTO RICO

**HATO REY**  
Audio Specialists of Puerto Rico

## RHODE ISLAND

**CRANSTON**  
Radio Shack Corp., 1301 Reservoir Ave.  
Sound-O-Rama, 758 Reservoir Ave.  
**PROVIDENCE**  
William Dandreta & Co., 28 Wolcott St.  
DeMambo Radio Supply, 1290 Westminister  
Electronic Distributors, 41 Broadway  
Hi-Fi Center, 41 Broadway  
Leo Miller's Audionics Co., 790 N. Main St.  
**WESTERLY**  
Barber & Howard, 120 East Ave.

## SOUTH CAROLINA

**AIKEN**  
TV Fixit Co., 100 Gyles Rd.  
**CHARLESTON**  
Fox's Music House, 535 King St.  
**COLUMBIA**  
Dixie Radio Supply Co., 1900 Barnwell St.  
Hi Fi Sound & Records, 621-23 Harden St.  
Horlacher Electronic Supply, P.O. Box 1325  
Music Inc., 1231 Main St.  
**FLORENCE**  
Dixie Radio Supply Co., 531 E. Palmetto St.  
**GREENVILLE**  
Dixie Radio Supply Co., 500 Pendleton St.  
Mary's Record Shop, 528 S. Main St.  
Arthur Rixon & Son, 209 W. Washington St.  
**SPARTANBURG**  
Hemcor Sight & Sound, 491 Union St.  
**SUMPTER**  
Dixie Radio Supply Co., 212 W. Liberty St.

## SOUTH DAKOTA

**HURON**  
A & M Radio & TV, 49 Ninth St.  
**SIOUX FALLS**  
Warren Radio Supply, 196 E. 6th St.

## TENNESSEE

**CHATTANOOGA**  
College Hi Fi, Brainard Village  
**JOHNSON CITY**  
Bauman Howard, Kingsport Bristol Blvd.  
**KINGSPORT**  
Joseph's Music Center, 115 Broad St.  
Resco Dist., 961 E. Sullivan St.  
Watkins Sound Hi Fi, 116 Virginia St.  
**KNOXVILLE**  
Bondurant Bros. Co., 906 Sevier Ave.  
Chemcity Radio & Elect., 2211 Dutch Valley Rd.  
Meridith Hall, 2704 Kingston Pike  
McClung Appliances, 310 Georgia St.  
**MEMPHIS**  
Glenn Allen, 1150 Union Ave.  
Bluff City, 234 East St.  
Hirsh Electronics, 1658 Union Ave.  
Modern Music of Memphis, 3145 Poplar Ave.  
W & W Distributing Co., 644 Madison Ave.  
**MURFREESBORO**  
Tom Tom's High Fidelity, 312 Maple St.  
**NASHVILLE**  
D & N Distributing Co., 113 19th Ave.

Electra Distr., 1914 West End  
Nicholson's High Fidelity 113-115 19th Ave.  
**OAK RIDGE**  
The Music Box, Broadway & Towne Rd.

## TEXAS

**ADDISON**  
Ted Cooper & Assoc., Addison Airport  
**AMARILLO**  
West Texas Electronics, 1601 W. Third St.  
**ARLINGTON**  
Arlington Hi Fi Center, 1952 Park Ave.  
**AUSTIN**  
Berkmans, 2234 Guadalupe St.  
Hargia-Austin, 410 Baylor  
High Fidelity Inc., 1610 Lacaca  
Speedway Radio & TV, 2010 Speedway  
**BAYTOWN**  
Gene's Hi-Fi Center, 122 E. Texas  
**BEAUMONT**  
Brock Audio Inc., 2293 Calder Ave.  
**BIG SPRING**  
Hi Fidelity House, 1307-B Gregg St.  
**CORPUS CHRISTI**  
Electr. Equip. & Eng., 805 S. Staples St.  
Greene's Music Shop, 3165 S. Alameda  
**DALLAS**  
Associated Radio Co., 7515 Lemmon Ave.  
B & L Installation Service, 11308 Lanewood  
Circle  
Crabtree's Wholesale Radio, 2608 Ross Ave.  
Hi-Fi, Inc., 4111 Abrams Rd.  
Hillcrest Records & Hi Fi, 6309 Hillcrest  
Home Music Associates Inc., 4518 N. Cent. Ex.  
James T. Hunt Radio Service, 602 N. St. Paul  
Radio Shack Corp., 1601 Main St.  
Ross Radio & Sound, 1608 N. Haskell  
Sanborn's Hi Fi, 5551 W. Lovers Lane  
Sound Systems of Texas, 3019 Monticello Ave.  
Southwest Cameras, 5626 Lemmon Ave.  
Wilkinson Bros. Co., 2406-8 Ross Ave.  
**EL PASO**  
The Howell Co., 2873 Pershing Dr.  
Midland Speciality Co., 4524 Bobolink Way  
Midland Specialty Co., 2235 Wyoming Ave.  
**FORT WORTH**  
Audio Associates, 4802 Camp Bowie Blvd.  
Larry's Speaker Service, 1121 S. Main St.  
Radio Shack Corp., 1515 S. University  
**GALVESTON**  
Ginsberg Music Co., 527 Moody  
**HOUSTON**  
Audio Center, Inc., 1424 Westheimer  
Busacker Electronics Equip., 1216 W. Clay  
Commercial Sight & Sound, 5406 Alameda  
Foley's Dept. Store, 2103 E. Wood  
Gulf Coast Electronics, 1110 Winbern St.  
Hi-Fi Kit Shop, 2326 Bissonnet  
Radio Shack Corp., 2315 Travis St.  
Radio Shack Corp., 322 Northline Mall  
Republic Electronics, Inc., 3905 Richmond Ave.  
Sound Equipment Co., Inc., 2506 Crawford  
Sterling Electronics, Inc., 2506 Crawford  
Sterling Electronics, 1616 McKinney  
**LAREDO**  
Cowl's Music Center, 1212 Hidalgo St.  
Guarantee Radio Supply Co., 1314 Iturbide St.  
**LUBBOCK**  
Hi-Fidelity of Lubbock, 2237 34th St.  
Lubbock Radio, 1722 Avenue H  
**MALLEN**  
Rio Radio Supply, 608-10 S. Broadway  
**McGREGOR**  
Bruce Hyatt Elec., Route #1  
**MIDLAND**  
Midland Camera Shop, 317 N. Colorado  
Sound Studio, 110 Petroleum Life Bldg.  
**PORT ARTHUR**  
Diehl Radio & TV Supply, 2120 7th St.  
**SAN ANGELO**  
Accurate Sound Co., 15 N. Taylor  
Electron Sales, Inc., 643 S. Chadbourne  
**SAN ANTONIO**  
Bill Case Sound, 3522 Broadway  
Radio Shack Corp., Wonderland Shopping  
Center  
Silvey Music Company, 1237 Austin Highway  
Southwest Radio & Sound Equip., 1518 N. St.  
Mary's St.  
Sterling Electronics Inc., 2903 San Pedro  
Vandergriff Audio, 6740 San Pedro  
**TEMPLE**  
Hoover Bros., Inc., 1305 N. 14th St.  
**TEXARKANA**  
McGuire's Television Center, 407 Texas Ave.  
**TYLER**  
R.W. Olsen Custom Music Systems, 1316 Barba-  
ra St.

## UTAH

**OGDEN**  
Hi Fi Shop, 2323 Washington Ave.  
**SALT LAKE CITY**  
Audio Specialists, 2909 E. 3300 So.  
Custom Sound by Poll Inc., 1651 S. 11th E.  
House of Kits, 2949 S. State St.  
House of Music, 115 S. Main St.  
Miller Electronics, 149 E. 9th St.  
Moore Radio Supply, 147 E. 6th St., S.  
O'Loughlin's Radio Supply, 113 E. 3rd St., S.  
Standard Supply Co., 225 E. 6th St., S.

## VERMONT

**BURLINGTON**  
Abraham's Inc., 111 Church St.  
Auchter's House of Music, 121 Pearl St.  
Concert Electronics, 40 Church St.  
**MORRISVILLE**  
Gillen's Dept. Store

ADVERTISERS INDEX

Reader Service No.	ADVERTISER	Page No.
2	Acoustech, Inc.	23
1	Acoustic Research, Inc.	117
3	Aerovox Corporation	105
4	Allied Radio	67, 68
5	Argos Products Company	123
6	Artisan Organs	175
7	Audio Dynamics Corp.	4
8	Audio Exchange	29
9	Audio Originals	167
10	Audio Unlimited, Inc.	107
11	Burstein-Applebee Co.	43
12	Carston Studios	179
13	Chancellor Electronics	97
14	Citadel Record Club	9
15	Command Records	7
42	Conar	65
16	Concertone	101
17	Crown International	81
18	Dixie Hi Fidelity Wholesalers	169
19	Dressner	179
20	EICO Electronic Instrument Co., Inc.	60, 61
21	Electro-Voice, Inc.	127
22	Empire Scientific	129
69	Ercona Corporation	139
23	Finney Company, The	71
24	Fisher Radio Corporation	SECOND COVER, 1
25	Furn-A-Kit	171
26	Garrard	32
27	Heath Company	16, 17, 18, 19
28	Hi-Fidelity Center	65
29	JFD Electronics Corporation	73
30	Jensen Manufacturing Company	125
31	KLH Research and Development Corporation	133
32	Kenwood Electronics, Inc.	63
33	Kersting Mfg. Co.	169
70	Klipsch and Associates	155
34	Koss	34
35	Lafayette Radio Electronics	25
36	Lansing Sound, Inc., James B.	143
38	McIntosh Laboratory Inc.	12
39	Magnecord Sales Department, Midwestern Instruments, Inc.	91
40	Microtran Company, Inc.	107
41	Minnesota Mining & Mfg. Co.	93
43	North American Philips Company, Inc.	FOURTH COVER
44	Nortronics	109
45	Olson Electronics Incorporated	43
46	Pickering & Co., Inc.	2
	RCA Electronic Components and Devices	161
	RCA Institutes, Inc.	85, 86, 87
68	RCA Parts and Accessories	74
47	Rabsons 57 St. Inc.	171
48	Rek-O-Kut	35
49	Rotron Mfg. Co., Inc.	27
50	Sarkes Tarzian Inc.	113
51	Saxitone	103
52	Schober Organ Corporation, The	55
53	Scott Inc., H.H.	31, 57
54	Sherwood Electronic Laboratories, Inc.	50
55	Shure Brothers, Inc.	121
56	Sound Reproduction Inc.	103
58	Superscope, Inc.	95
59	Tannoy (America) Ltd.	151
71	Telex Inc.	175
60	Turner Microphone Company, The	165
61	Universal Record Service	37
62	University Loudspeakers, Inc.	THIRD COVER
63	Utah	153
64	Viking of Minneapolis, Inc.	76
65	Weathers Industries, Inc.	39
66	Wharfedale, Div. of British Industries Corp.	114
67	Winegard Company	75

**RUTLAND**  
Wilson Music Co., 37 Center St.  
**SPRINGFIELD**  
Chas. V. Thayer, Breezy Hill Road  
**WHITE RIVER JUNCTION**  
Electronic Supply, Inc.  
**WOODSTOCK**  
John Lancaster & Son, 14 S. Wood St.

**VIRGINIA**

**ABINGDON**  
Moore Music Co., Main St.  
**ALEXANDRIA**  
Certified Electronics Inc., 1328-34 Powhattan  
**ARLINGTON**  
Audio Associates, 3123 N. Washington Blvd.  
Key Electronics, 126 S. Wayne  
Va. Communications & Sound, 3540 S. Glebe Rd.  
**BRISTOL**  
Bristol Radio Supply Corp., 1611 W. State St.  
**CHARLOTTESVILLE**  
Charlottesville Music Center, 105 E. Main  
Custom Stereo Shop, 107 2nd St. S.E.  
Electronics International, Box 3066, Univ. Station  
Music Center Hi Fi House, 2110 Barracks Rd.  
Virginia Radio Supply, 715 Henry Ave.  
**CHRISTIANSBURG**  
Music House, 51 W. Main St.  
**DANVILLE**  
Haynsworth Inc., 520 Main St.  
**FALLS CHURCH**  
E.J. Korvette, 1335 Leesburg Pike  
The TV Workshop, 116 W. Broad St.  
**LYNCHBURG**  
Electric Service Co., 1624 Park Ave.,  
Hi-Fi House, 1407 W. Broad St.  
**NEWPORT NEWS**  
General Supply Co., 10178 Warwick Blvd.  
Va. Craftsmen Inc., 3202 Washington Ave.  
**NORFOLK**  
Audio Center, 147 E. Little Creek Rd.  
Bradshaw's Radio TV Inc., 810 W. 25th St.  
Cain Electronics Co., 14th & Monticello Ave.  
Cain Electronics, 7819 Military Highway  
Electronic Engineering Co., 4201 Hampton Blvd.  
Priest Electronics, Inc., 6431 Tydewater Dr.  
Radio Equipment Co., 821 W. 21st St.  
Radio Parts Dist. Co., 128 W. Olney Rd.  
Radio Supply Co., 711 Granby St.

**PORTSMOUTH**

Distributors Inc., 710 County St.  
**RICHMOND**  
Audio Fidelity Corp., 6521 W. Broad St.  
Cottrell Electronics Corp., 408 E. Main St.  
Gary's Music Shop, 2928 W. Gary St.  
Music City, 4710 N. Southside Plaza  
Radio Supply Co., 3302 W. Broad St.  
W.A. Yoder Co., 714-16 N. Cleveland St.  
**ROANOKE**  
H.C. Baker Sales Co., 19 Franklin Rd., N.W.  
Lee Hartman & Sons, 3236 Cove Road  
Peoples Radio & TV Supply, 1015 Moorman Rd., N.W.  
Southeastern Radio, P.O. Box 5196  
**STAUNTON**  
Southern Electric Corp., 818 Greenville Ave.  
**WILLIAMSBURG**  
Jones Radio & TV Service, Capitol Landing Rd. & Parkway Dr.  
**WINCHESTER**  
Custom Audio Center, 12 E. Piccadilly St.  
G & M Music Co., 38 W. Boscaven St.  
Kann-Ellert of Va., 1650 Valley Ave.  
Shenval Music Co., 5 W. Bocaven St.

**WASHINGTON**

**BELLEVUE**  
Lafayette Electronics Assoc., 10845 N.E. 8th  
Overlake Television Serv., 370 Bellevue Sq.  
**BELLINGHAM**  
Advanced Electronics, 804 Dupont  
**CHEHALIS**  
Twin City Radio & TV, 97 National Ave.  
**CLARKSTON**  
Wasem's, 845 Main St.  
**EVERETT**  
Alley's Camera Shop, 2932 Colby St.  
Audio Sales, 2401 Broadway  
Pringle Electronic Supply, 2101 Colby Ave.  
**GIFFORD**  
The Music Box, Rt. 1, Box 1  
**KENNEWICK**  
Thrifty Rexall Drug, 101 Vista Way  
**KENT**  
Music Mart, 221 S. 1st St.  
**LONGVIEW**  
Korten's Inc., 1400 Commerce Ave.  
**LYNNWOOD**  
Wilson Thorn Inc., P.O. Box 8  
**LYNNWOOD SEATTLE**  
Cascade Electronics, P.O. Bldg.  
**MT. VERNON**  
Hi Fi Sound Systems, 1023 South 2nd  
**OLYMPIA**  
Century Custom Recording, 340 N. St.  
**PASCO**  
Adsound, 1315 W. Yakima  
**PULLMAN**  
Empire Music, P.O. Box 200  
Pullman Music Shop, 909 Grand  
**RICHLAND**  
20th Century Sales, 260 Williams  
**SEATTLE**  
American Mercantile, 1210 1st Ave.  
Audio Associates Inc., 418 N.E. 4th  
Audio-Visual Center, 1205 N. 45th St.  
Bill's Audio Exchange, 1039 Aurora Ave.  
Bill's Audio Exchange, 525 N.E. 195th

Broadway Radio & Hi Fi, 402 Broadway E.  
S.F. Burns & Co., Inc., 2319 Second Ave.  
Coleman's Kodak Supply, 1319 4th Ave.  
Doces Sixth Ave., 1521 6th  
Electricraft Inc., 1408 6th Ave.  
Electronic Specialties, 2221 2nd Ave.  
Electronic Supply Corp., 5601 California Ave.  
Hamin's Audio Workshop, 2128 3rd Ave.  
Hess Stereo Center, 650 S.W. 152nd  
Hi Fi Exchange, 525 N.E. 195th  
High Fidelity Headquarters, 604 Broadway N.  
Hi Fi Sales Co., 2008 Westlake Ave.  
C.W. Johnson Sales, 2711 Warren Ave. N.  
Pacific Elect. Sales, 1309 1st Ave.  
Pay & Save, 4535 University Way  
Radio Hi Fi Shop, 603 Broadway E.  
Seattle Radio Supply, 2117 Second Ave.  
Seattle Stereo Center, 2440 1st Ave. So.  
Standard Records & Hi Fi, 1028 N.E. 65th  
Talls Camera Supply, 1415 3rd Ave.  
University Radio, 4209 University Way

**SPOKANE**

Hals' Hi Fi, 2907 N.W. Boulevard  
H.C.J. Electronics, 6904 Sprague  
Howard Photo Center, 2 Howard St.  
Huppins, 419-421 W. Main  
Johnson Electronic Supply, W. 611 1st Ave.  
Modern Radio & TV, 2319 N. Division  
National Music Service, 200 Symons Bldg.  
Northwest Electronics Inc., 730 E. 1st Ave.  
Sound Recording Co., 503 W. Indiana  
20th Century Sales, W 1021 1st.

**TACOMA**

Engineered Electronics, 3016 6th Ave.  
Fulton Organ Studio, 10115 Plaza Place  
Lakewood Sound, 10557 Gravelly Lake Dr.  
Paulson's Inc., 6111 100th St. S.W.  
The Sound Center, 2502 Jefferson Ave.

**VANCOUVER**

Besserman-Vel, 1510 Washington St.

**WALLA WALLA**

Marsh Radio, 105 E. Alder  
Tallmans, 4 W. Main St.

**WENATCHEE**

Belmont Radio & Music, 31 N. Wenatchee Ave.  
Bob's Radio, 334 S. Wenatchee Ave.

**YAKIMA**

Andrews Camera Repair, P.O. Box 495  
Glencourt Electronics, 3508 S. Nob Hill Blvd.  
Sheppard's Camera Shop, 108 S. 4th St.  
Triangle Music Inc, 18 S. Second St.  
Wyatt Radio & TV, 5 N. 7th Ave.

**WEST VIRGINIA**

**BECKLEY**

A.H. Gunnoie, P.O. Box 686

**CHARLESTON**

Custom Electronics, 1002 Quarrier St.  
Electronic Specialty Co., Delaware Ave. at Randolph

**HUNTINGTON**

Electric Supply Co., 222 Seventh Ave.

**WHEELING**

James M. Black & Sons, 1206 Chapline St.  
Radio Service Labs, 1206 Chapline St.

**WISCONSIN**

**APPLETON**

Valley Radio Dist., 518 N. Appleton

**BELOIT**

Yaglia's, 430 E. Grand Ave.

**BLACK RIVER FALLS**

Jackson Electric Corp., 119 Harrison

**EAU CLAIRE**

Bushland Radio Spec., 1728 Loring St.

**GREEN BAY**

Transradio, 412 Dousman St.

**KENOSHA**

Chester Electronic Supply, 2012 52nd St.

**LAKE GENEVA**

Leonard's Radio, 507 Broad St.

**MADISON**

Evans Radio Service, 720 University Ave.  
Grand Elec. Inc., 4605 W. Belt Line  
Hi Fi Systems, Inc., 1900 South Park  
Hal Householder, 5609 Russett Rd.  
Satterfield Elect., 1900 S. Park  
Skip's Music City, Westgate Shopping Center  
Specialized Sound Systems, 621 Gammon Rd.  
Towne Electronics, 675 Gilbert Rd.

**MANITOWOC**

Rahr's Inc., Hancock at S. 10th

**MENASHA**

Tip Top Radio & TV, 216 Main St.

**MILWAUKEE**

Allied Radio of Wisconsin, 3555 S. 27th St.  
Allied Radio of Wisconsin, 5312 N. Port Washington Rd.  
Hi Fi Center, Inc., 4236 W. Capitol Dr.  
Hi Fi Fo-Fum Inc., 2532 W. Wisconsin  
Hi Fi Salon, 7204 W. Greenfield  
Olson Electronics of Milwaukee, 423 W. Michigan  
Pesick Radio Supply Co., 2415 W. Fond du Lac Ave.  
Photoart Visual Service, 840-44 N. Plankington  
Taylor Electric Co., 4080 N. Port Washington Rd.  
Wack Sales Company, 3131 W. North Ave.  
Westgate Cameras, 3716 N. 92nd

**RACINE**

Draeger Stereo, 1919 S. Taylor  
Edward's Sound Engineering, 856 Washington Ave.

**WEST ALLIS**

Hi Fi Salon, Inc., 7204 W. Greenfield

**WYOMING**

**CHEYENNE**  
Telesonic Sound, 1308 Hot Springs

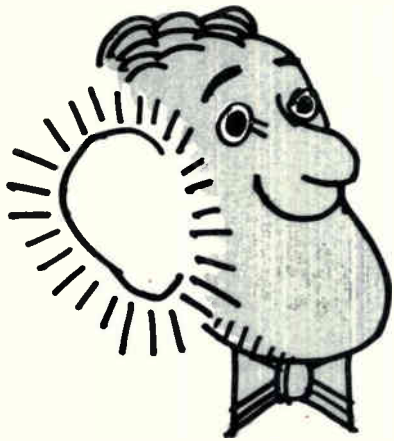

# GOLDENEARS

## AND THE THREE SPEAKER SYSTEMS

Once upon a time, Jason Goldenears was wandering through the city in search of a miracle. To be precise, he was looking for a moderately priced speaker system free of distortion, coloration, peaking and boom.

He was not having an easy time of it. If his super-sensitive appendages could not hear the bowing of

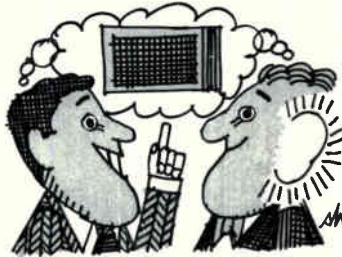

The dealer, apprised of his problem, said, "I have exactly what you're looking for. Listen!" And he began to demonstrate the new University Medallion Monitor.

"Yes," mumbled Mr. Goldenears as he listened to it. "No distortion, no coloration or peaking. Instruments clearly defined. And feel that bass."

"25 to 40,000 cps," said the dealer with a smug little smile. "It can fit on a shelf and," he paused dramatically, "it's only \$129!" *This one was just right!*

"I'll take two, if you please," said Mr. Goldenears, and it was done.

Almost, that is. On the way out, he heard the new University Mini-Flex II. Only 15" x 9" x 6", but it sounded so big! And no distortion. Perfect

for the bedroom! Certainly, it was superior to larger and costlier systems he had heard. But could he afford it?

As if he had read his mind, the dealer said: "It's only \$49.50. And it carries University's exclusive five-year warranty, just like the Classic and the Medallion Monitor."

And so Mr. Goldenears bought two Medallions, one Mini-Flex, and lived with them happily ever after.



the bull-fiddles, if brass did not bite, if drum-beats were heard as a blurred roll instead of well-separated beats, he sneered. He was an acoustic malcontent.

Because of his limited budget, he had been listening to dozens of "bargain-priced" off-brand systems. Now, sadder but wiser he vowed: "I will no longer shop for price. If necessary, I will sell the children into white slavery."

In the very last store he entered he was met with a sound to delight the ears. "You're listening to the University Classic Mark II," said the dealer. It was magnificent, thought Mr. Goldenears, and looked it, too, in its new Provincial cabinet. Though only \$325, it exceeded his modest budget. Nevertheless, had he felt that his small living-room could accommodate two Classics, our story would be over. "The devil take middle-income housing!" thought Mr. Goldenears.



For the complete story on all the "Goldenears-qualified" speaker systems, send for the new University catalog and the 1964 Component Stereo Guide. Write: Desk Z-65, LTV University, 9500 West Reno, Oklahoma City, Okla.



Renowned Classic Mark II, 15" three-way speaker system in its new Provincial cabinet. Fruitwood, \$325. Modern (oiled walnut), \$295.00.



New Mini-Flex II, ultra-compact three-way speaker system. Oiled walnut, \$49.50.

New Medallion Monitor, 12" three-way professional monitor bookshelf speaker system. Oiled walnut, \$129.00.



**LTV UNIVERSITY**  
A DIVISION OF LING-TEMCO-VOUGHT, INC.  
9500 West Reno, Oklahoma City, Okla.



◀ **Continental '101'** 100% transistorized cordless portable (only 7 lbs.) . . . big machine record/playback quality . . . self-contained loudspeaker . . . constant speed motor and capstan drive . . . dynamic microphone . . . records/plays back up to 2 hours on a single tape . . . 11" x 3 3/4" x 8".

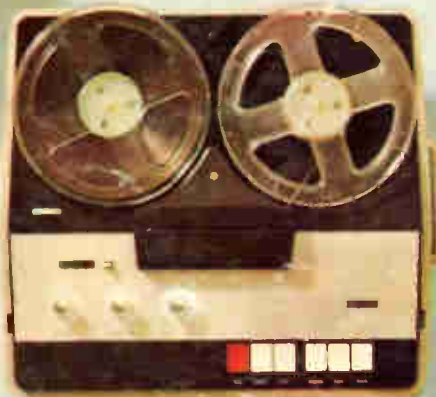

▲ **Continental '201'** 2-speed (7 1/2 and 3 3/4 ips) 4-track mono record/playback . . . dual hi-fi preamps for stereo playback thru any external amplifier and speaker . . . portable P.A. . . . 15 3/4" x 13 3/4" x 6 3/4"; weighs 18 lbs. (available, late '64)

▼ **Continental '301'** 100% transistorized 4-speed, 4-track mono record/playback . . . Plus stereo playback with any external amplifier and speaker . . . recording stand-by facility; mixing; monitoring; dynamic microphone . . . 16 1/2" x 15 1/2" x 8 3/4"; weighs 29 lbs.



▲ **Continental '401'** 100% transistorized professional quality 4-track stereo/mono record/playback . . . 4 speeds (7 1/2, 3 3/4, 1 7/8 and 1 1/2 ips) . . . completely self-contained . . . dual hi-fi preamps, power amps, speakers and dynamic stereo microphone . . . 18 3/4" x 15" x 10"; weighs 38 lbs.



**Carry-Corder '150'** Revolutionary new cartridge tape recorder provides ultimate in convenience, simplicity, reliability . . . Pocket-size (weighs only 3 lbs.) . . . Cordless . . . Gives full hour of high quality recording/playback per cartridge (cartridge change takes less than 3 seconds) . . . Capstan drive and constant speed motor . . . Comes complete with 4 cartridges; dynamic microphone; fitted carrying cases; patch cord . . . 7 3/4" x 4 1/2" x 2 1/4".

## Which of these new Norelco recorders was designed expressly for you?

Norelco offers a professional quality tape recorder for every purse and every purpose . . . from "tape-anywhere" portables, to a self-contained, two-speed, four track recorder, to 100% transistorized four-speed, four-track recorders. For a complete Norelco demonstration visit your favorite hi-fi or camera store. For free brochure write: North American Philips Company, Inc., High Fidelity Products Div., 100 East 42nd St., N. Y. 10017

*Norelco*