

HiFi/Stereo review

JUNE 1963 • 50 CENTS

GLENN GOULD: AN IMAGE FOR MUSIC • HOW TO START A RECORD COMPANY • A BASIC CHAMBER-MUSIC LIBRARY

**SPECIAL:
LABORATORY
TEST REPORTS
ON
STEREO CARTRIDGES**

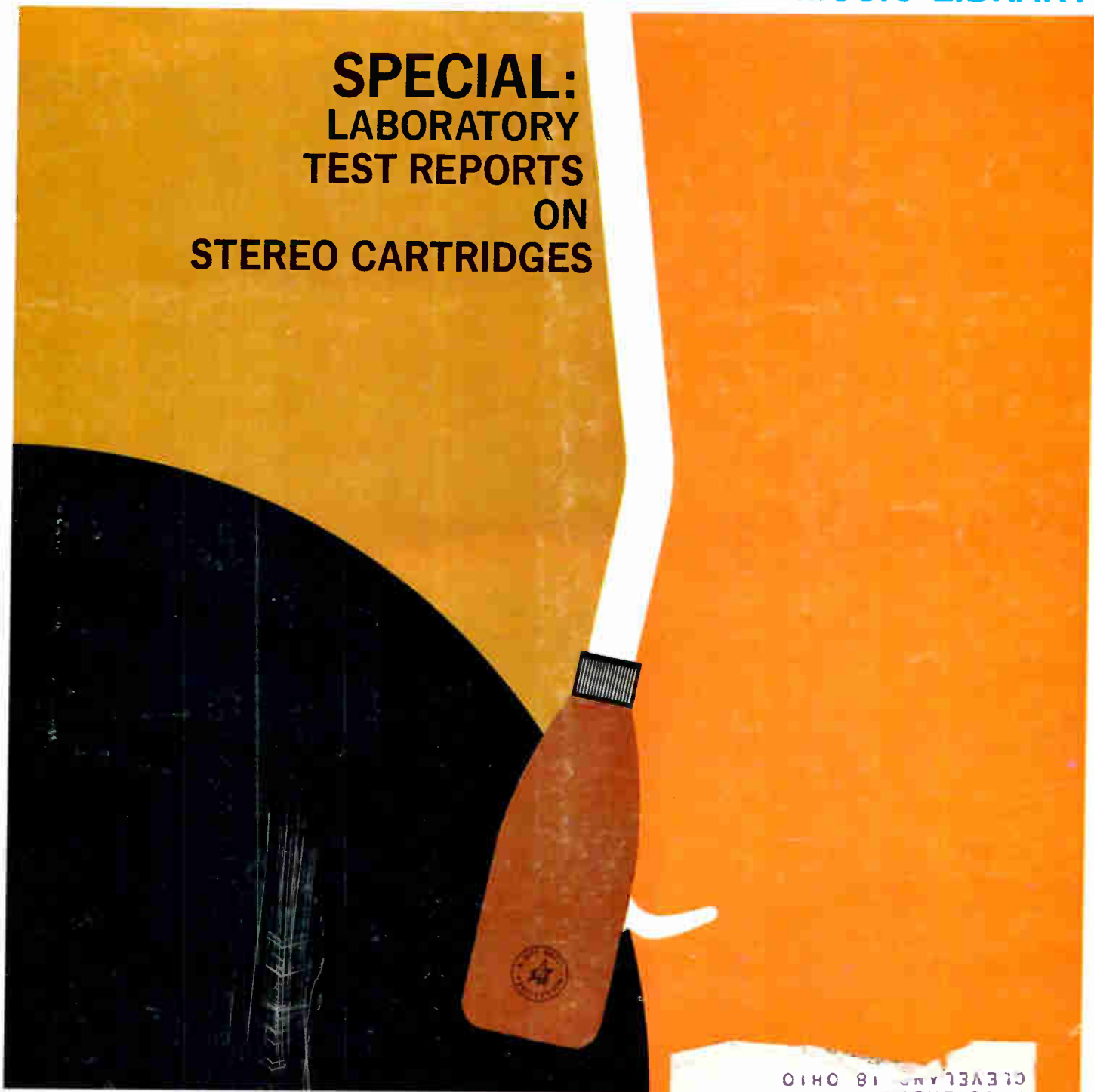

01HO 81 0N7E3D
3924 EASTWAY RD
J SAUL
C21R518916
CLEVELAND 18 OHIO



from Scott

NEW



WE'RE A YEAR AHEAD OF OURSELVES...

(and two years ahead of
everyone else!)

Tomorrow's components are here today! Scott proudly introduces two radically advanced FM stereo components . . . components that challenge traditional concepts of engineering design and circuitry . . . components that set new standards for our industry . . . components that bring you important new features and unsurpassed performance.

For a glimpse of tomorrow, turn this page . . . For detailed specifications on these new products, fill out coupon below . . .

(Cut out this coupon, fill in
your name and address, and mail)

Place
5c
Stamp
Here

Please send your new brochure on the 340B and 310E, as well as complete 1963 catalog.

Name _____
Address _____
City _____ Zone _____ State _____

SCOTT

111 Powdermill Road
Maynard, Massachusetts



Automatic Stereo Circuitry

An amazing new Scott solid-state circuit makes stereo completely automatic. This circuit actually senses whether a station is broadcasting in FM Stereo or regular monophonic FM. It swiftly and silently switches to the correct mode of operation... you never have to touch the tuner controls!

Silver-Plated RF "Front-End"

Only Scott heavily silver plates the critical RF section to faithfully preserve weak FM signals. This unique design feature assures very high sensitivity with virtual elimination of interference from strong nearby stations. It enables you to enjoy distant stations ordinary tuners would pass right by.



Time-Switching Multiplex Section

This development assures extremely high channel separation with lowest distortion... even when receiving weak FM stereo signals. This important engineering concept was pioneered in the components industry by Scott.

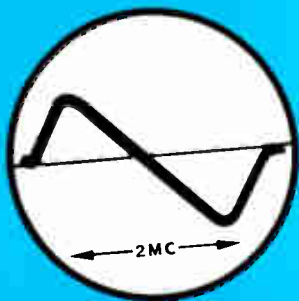

Wide-Band Design

This major Scott innovation assures distortionless reception of even the weakest signals. Wide-Band design is also essential for wide-range stereo programming, lowest capture ratio, and drift-free tuning without the need for AFC. All Scott tuners use a detector bandwidth of 2 megacycles.

New Exclusive Double Guarantee:

Now Scott owners are protected two ways. First, all component parts (except tubes) including transformers, condensers, resistors and critical RF circuitry are guaranteed for two full years against defect. Second, Scott guarantees that every component meets or exceeds all advertised specifications. If a Scott component fails to meet all published specifications, it will be replaced without charge.



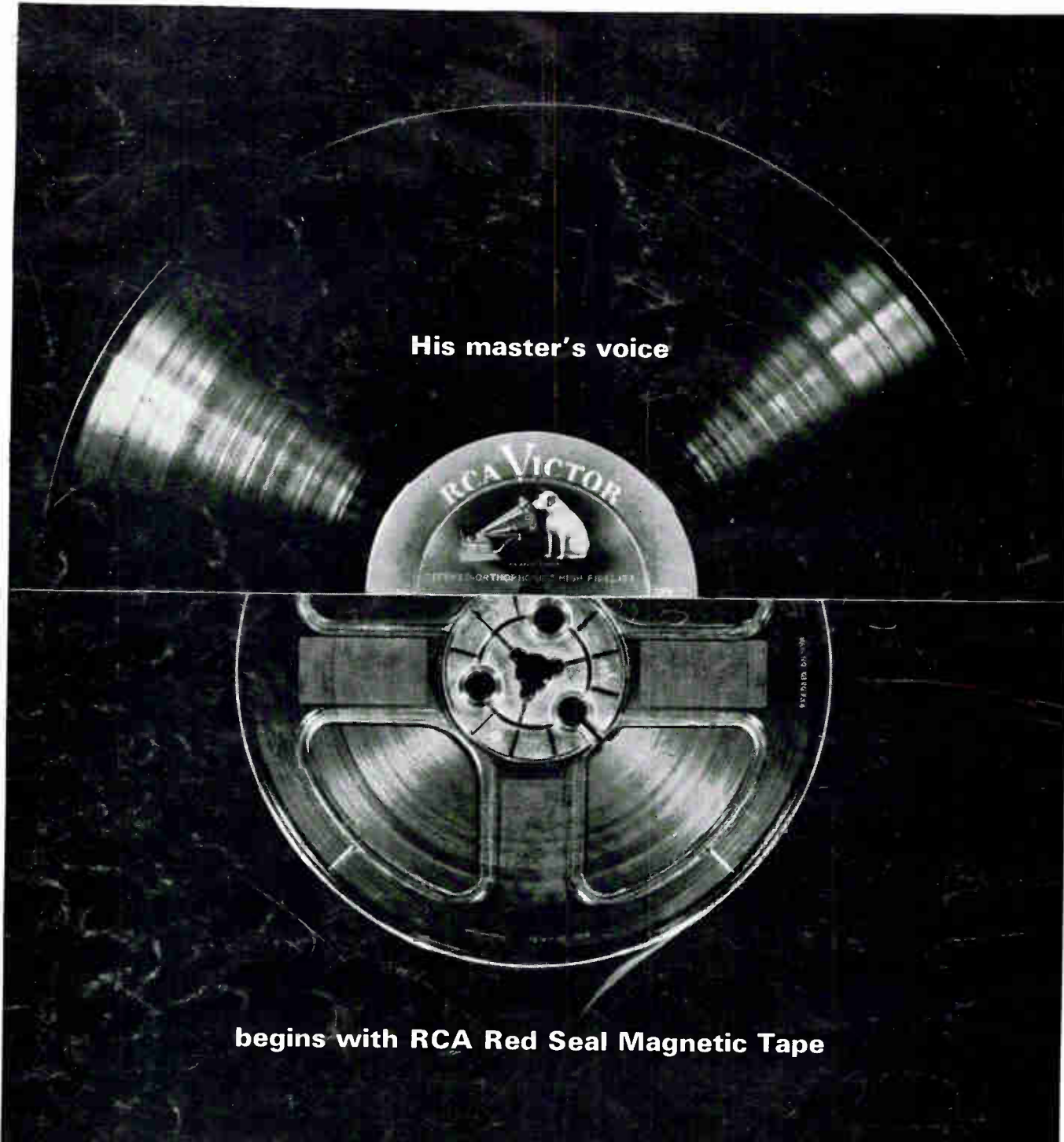

His master's voice

begins with RCA Red Seal Magnetic Tape

(the very same super-quality sound tape available to you!)

The world's greatest artists are recorded on RCA Victor Red Seal Records. And the first-generation source of this great sound is RCA Red Seal Magnetic Recording Tape—the same super-quality tape you can obtain (and should demand!) wherever you buy recording sup-



plies. No matter what the job, for the unqualified best in home recording always specify RCA RED SEAL MAGNETIC TAPE. Also ask your dealer about the economical "Vibrant Series" Sound Tape—the high quality, low-cost magnetic tape, in all standard reel sizes.



The Most Trusted Name in Sound

RADIO CORPORATION OF AMERICA

CIRCLE NO. 35 ON READER SERVICE CARD



THE ELOQUENCE AND SPLENDOR OF SONY SOUND



STERECORDER 777S-4: ALL-TRANSISTORIZED, WITH THE REVOLUTIONARY SONY ELECTRO BI-LATERAL HEAD*

The perfect integration of superior performance specifications and operational ease. For home or studio use, the new Sony Sterecorder 777S-4 is the finest 4 track professional tape recorder value on the market today. An outstanding array of features includes all-transistorized modular-type circuitry, three motors, the exclusive electro bi-lateral head, tape and source monitoring, sound on sound, illuminated 3" V.U. meters. Sony's solenoid controls (feather touch switching of tape motion in both the instrument and the remote control unit) provide an unsurpassed ease of operation.

Complete with portable case and remote control unit: \$595.

*A Sony exclusive, the patented Electro Bi-lateral Head enables 2 track stereo and monophonic playback as well as 4 track playback.

For literature or name of nearest dealer write Superscope, Inc., Dept. 8 Sun Valley, California.

SUPERSCOPE

The Tapeway to Stereo

All Sony Sterecorders are Multiplex Ready! In New York visit the Sony Fifth Avenue Salon, 585 Fifth Avenue

CIRCLE NO. 44 ON READER SERVICE CARD

HIFI/STEREO REVIEW ADVERTISERS' INDEX

| READER SERVICE NO. | ADVERTISER | PAGE NO. | READER SERVICE NO. | ADVERTISER | PAGE NO. |
|--------------------|-------------------------------------|----------|--------------------|--|--------------|
| 1 | Acoustech, Inc. | 69 | 28 | Grado Laboratories, Inc. | 65 |
| 2 | Acoustic Research, Inc. | 68 | 29 | Greentree Electronics | 73 |
| 3 | Airex Radio Corporation | 76 | 30 | Grommes, Division of Precision Electronics, Inc. | 8 |
| 4 | Allied Impex Corporation | 12 | | | |
| 5 | Altec Lansing Corporation | 15 | 54 | Harman-Kardon, Inc. | 29 |
| 6 | Angel Records | 63 | 31 | Heath Company | 61 |
| 50 | Angel Records | 71 | 32 | Honeywell Photographic Products | 16 |
| 7 | Argo Records | 74 | | | |
| 8 | Audio Devices, Inc. | 5 | 33 | KLH Research and Development Corporation | 22 |
| 9 | Audio Dynamics Corporation | 20 | | Kersting Mfg. Co. | 94 |
| 51 | Audio Dynamics Corporation | 21 | | Key Electronics Co. | 95 |
| 10 | Audio Fidelity, Inc. | 93 | | | |
| | Audion | 94 | 55 | Lafayette Radio Electronics | 87 |
| | Audio Unlimited | 95 | 56 | Lansing Sound, Inc., James B. | 57 |
| | | | 23 | Leak & Company, Ltd., H.J. | 95 |
| 11 | Bell Stereo | 6, 7 | 57 | Lesla of America Corp. | 92 |
| 12 | Benjamin Electronic Sound Corp. | 14 | | London Records | 87 |
| 52 | Benjamin Electronic Sound Corp. | 80 | | | |
| 13 | British Industries—Garrard | 2 | 32 | Minneapolis-Honeywell (See Honeywell) | 16 |
| 59 | British Industries—Wharfedale | 9 | 34 | Minnesota Mining & Manufacturing Co. | 79 |
| | Brown Sales Corp., L.M. | 94 | | | |
| | | | 35 | RCA Red Seal Magnetic Tape | 4th COVER |
| | Carston Studios | 94 | 36 | Rabsons—57th Street, Inc. | 81 |
| 14 | Citadel Record Club | 66 | 37 | Reeves Soundcraft Corp. | 85 |
| 15 | Columbia Records | 58 | 38 | Rek-O-Kut Company, Inc. | 78 |
| 53 | Command Records | 81 | 58 | Roberts Electronics, Inc. | 85 |
| | Commission Electronics, Inc. | 94 | 39 | Rockford Special Furniture Co. | 81 |
| 16 | Concord Electronics Corporation | 88 | | | |
| | | | 40 | Sarkes Tarzian, Inc. | 82 |
| 17 | Decca Records | 64 | | Saxitone Tape Sales | 94 |
| | Dixie Hi-Fi | 94 | 41 | Scott, Inc., H.H. | 2nd COVER, 1 |
| 18 | Douwe Egberts Royal Factories | 10 | 42 | Sherwood Electronic Laboratories, Inc. | 26 |
| | Dressner | 94 | 43 | Shure Brothers, Inc. | 19 |
| 19 | Dynaco, Inc. | 77 | | Sound Reproduction, Inc. | 94 |
| 60 | Dynaco, Inc. | 90 | | Stereo Component Supply Co. | 95 |
| | | | | Stereo-Parti | 94 |
| 20 | EICO Electronic Instr. Co., Inc. | 30 | | Stereo Warehouse | 94 |
| 21 | Electro-Voice, Inc. | 76 | 44 | Superscope, Inc. | 3rd COVER |
| 22 | EMI (Scope Electronics Corporation) | 62 | | | |
| 23 | Ercona Corporation | 95 | 45 | Tall Company, The | 66 |
| | | | | | |
| 24 | Finney Company, The | 67 | 46 | United Stereo Tapes | 86 |
| 25 | Fisher Radio Corporation | 11, 13 | | Universal Tape Club | 94 |
| 26 | Fuji Photo Optical Products, Inc. | 60 | 47 | University Loudspeakers | 25 |
| | | | | | |
| 27 | Gallo Electronics Corporation | 84 | 48 | Vanguard Records | 76 |
| | Goodwin (Sales) Ltd., C.C. | 94 | 49 | Viking of Minneapolis, Inc. | 72 |

HIFI/STEREO REVIEW PRODUCT INDEX

As an additional reader service, we list below, by classifications, the products advertised in this issue. If there is a specific product you are shopping for, look for its listing and turn to the pages indicated for the advertisements of manufacturers supplying that equipment.

| CLASSIFICATION | PAGE NUMBERS |
|------------------------|--|
| Accessories | 20, 66 |
| Amplification Systems | 57, 69, 77 |
| Antennas, FM | 67, 84 |
| Cabinets | 81 |
| Cameras | 16, 60 |
| Cartridges, Phonograph | 14, 19, 90 |
| Portable Radios | 61 |
| Records | 58, 63, 64, 66, 71, 74, 76, 81, 87, 93 |

| CLASSIFICATION | PAGE NUMBERS |
|------------------------------|---|
| Speakers and Speaker Systems | 9, 15, 21, 22, 25, 62, 68, 76, 78, 95 |
| Tapes, Prerecorded | 86 |
| Tape, Recording | 5, 73, 79, 82, 85, Cover 4 |
| Tape Recorders and Decks | 6, 7, 12, 72, 85, 87, 88, Cover 3 |
| Tobacco | 10 |
| Tone Arms | 65, 90 |
| Tuners and Tuner-Amplifiers | Cover 2, 1, 8, 11, 13, 26, 29, 30, 77, 81 |
| Turntables and Changers | 2, 80, 92 |

DRAFTING, Reading Blueprints, Schematics. Send \$2.00 first lesson, complete home course \$25.00. Prior Inc., 23-09 169 Street, Whitestone 57, New York.

BUSINESS OPPORTUNITIES

I MADE \$40,000.00 Year by Mailorder! Helped others make money! Start with \$10.00—Free Proof. Torrey, Box 3566-N, Oklahoma City 6, Oklahoma.

ASSEMBLE Artificial Lures at home for stores. Materials supplied Free. Profitable! Write: Lures, Fort Walton Beach 1, Florida.

\$100 weekly possible. Compile Mailing lists and address envelopes for advertisers. Home—spare time. Particulars free. National Service, 81 Knickerbocker Station, New York City.

MAKE \$25-\$50 week clipping newspaper items for publishers. Some clippings worth \$5.00 each. Particulars free. National, 81, Knickerbocker Station, New York City.

HUNDREDS of money-making ideas which proved successful \$3.00. Mr. Cacciatore, 1123 Shamwood St., West Covina, Calif.

MISCELLANEOUS

HYPNOTIZE Unnoticed, quickly, effortlessly or refund! Thousands satisfied! \$2. Timmer, Box 244, Cedarburg, Wisc.

SCIENTIFIC news censored by daily press! 25¢. Pedestrian League, Box 1308, Church Station, New York 8.

EMPLOYMENT Resumes. Earn more by presenting yourself to prospective employers effectively. Send only \$2.00 for Resume Writing Instructions. Or send complete job, educational and personal facts plus \$20.00 (cash or money order) for your own complete, personal resume, \$30.00 for 200 copies printed on white bond paper. J. Ross, 63-61 Yellowstone Blvd., Forest Hills 75, New York, Dept. 6J-HF

MOVING?

ATTACH LABEL HERE

If you've recently changed your address or plan to in the near future, be sure to notify us at once. Place magazine address label here and print your new address below.

NEW ADDRESS:

NAME _____ PLEASE PRINT

ADDRESS _____

CITY _____ ZONE _____ STATE _____

Please fill in moving date below:

If you have any other questions about your subscription be sure to include your magazine address label when writing us.

Mail to: HiFi/STEREO REVIEW, 434 So. Wabash Avenue, Chicago 5, Illinois

lucid she is very, very lucid—and for C. Day Lewis's controlled readings of his own well-crafted work. Volume Two introduces us to the poetry of two exceptional and relatively young contemporary Englishmen—Laurie Lee, who weds melody to power superbly, and the somewhat self-consciously ragged Christopher Logue. Both poets, interestingly, created verses with the phonograph as theme specifically for this recording, and neither skimmed the assignment—the results are worthy in both instances. But what on earth impelled Folkways to package this material with C. Northcote Parkinson? On side two the “discoverer of Parkinson's Law” (how organizations tend to proliferate personnel) expounds what is billed as “new findings” on “some negative aspects of the administrative.” They seem neither very novel nor terribly amusing to one who has heard him before. Can it be that there is a hidden law about the self-perpetuation of Parkinson? At any rate, he seems badly out of place here. P. K.

© ® SALVADOR DALI: *Dali in Venice*. Contents include A. Scarlatti: *The Spanish Lady and the Roman Cavalier*; Confalonieri: *Gala (Cosmic Divertissement)*; *Salvador Dali Paints a Picture and a Great Artist Speaks his Mind*. LONDON OSA 1105 \$5.98, A 4150* \$4.98.

Interest: Sweet music, garishly wrapped
Performance: Good opera, bad Dali
Recording: Stunning
Stereo Quality: Good

What you find when you open this package is so complex and wildly tinted you may overlook the fact that it includes a brilliantly performed and recorded Scarlatti opera. There is a frenetic text, a spate of lurid photographs of gigantic eyes and melting watches, an opera libretto, a recorded interview with the self-styled Master, the opera itself, the music of a ballet, and, in case you demand still more for your money, a sachet of Vol de Nuit “pour parfumer votre lingerie.” It all came out of a whirlwind descent upon the ordinarily impervious city of Venice by Dali and a group of talented musicians who were somehow able to perform despite all the fuss. Judging from the photographs, Dali restrained his usual exhibitionism in designing the set for Scarlatti's comic opera *The Spanish Lady and the Roman Cavalier*. It's an especially diverting period piece about a girl who presents an enormous watch to an officer who finds her “lost mistress” for her. The watch soon becomes a problem to him, and so does the girl, but their duets together and the arrangements of the musical interludes for orchestra and harpsichord by Giulio Confalonieri are as airy and sparkling as only the best of *opere buffe* can be.

Fiorenza Cossotto as the girl Perricca, and Lorenzo Alvary as Varrone, the cavalier, are perfect. The rest of this surreal package is something else. Confalonieri has cooked up as a tribute to Scarlatti a fallen soufflé of a ballet called *Gala* (after Dali's wife). And what scenic designer Dali and choreographer Maurice Bejart have done to decorate it shouldn't happen to a Fifth Avenue window. Luckily you cannot hear it, even in stereo, but there are pictures. Among the incredible features of this farrago is something called “liquid scenery” by Guerlain. Then comes Mr. Dali himself, recorded on the balcony of the Teatro La Fenice, painting the Lion of St. Mark and getting paint all over the photographers and the interviewer. If you haven't gently removed the record from the turntable by this time, you deserve what comes next: to inane questions, a response in “creative” (read: a mish-mash of French, Spanish, and British) English by the Master, on the subject of his “symbolism” and his “sanity.” The whole production, by the way, is rumored to be headed for America. Duck! P. K.

HUMOR

© ® CARL REINER AND MEL BROOKS: *At the Cannes Film Festival*. CAPITOL SW 1815 \$5.98, W 1815* \$4.98.

Interest: Satire
Performance: Free-wheeling
Recording: Excellent
Stereo Quality: Good

One of these days Mr. Reiner and Mr. Brooks are going to sit down and write a real script for one of their comedy records, and then they may really outdo themselves. Meanwhile, they are still improvising in front of audiences, and the results scamper up and down. On the first band, they score well as Reiner interviews Brooks at an imaginary Cannes Film Festival, with Brooks changing accents to represent, in turn, German, Italian, and British directors. The Italian bit is particularly funny—he calls himself Frederico Fettucini but he's really a Greek named Mercurio Mercurochrome, and all his pictures are really moral because “the raped people feel they've done something wrong.” As Dr. Felix Wheird, who writes books on food fads, Mr. Brooks marks time while his straight man sweats it out, and the ad-agency stint that ends the record suffers again from improvisation that seems to stall for time in the hope something will turn up. The 2000-Year-Old Man appears also, as he has for several records running, and although he's still very funny as a character, his recollections are far from being as rib-tickling as they were the first time around. P. K.

HiFi/STEREO SHOPPING CENTER

RATE: 40¢ per word. Minimum 10 words. August issue closes June 5th. Send order and remittance to: Martin Lincoln, HiFi/STEREO REVIEW, One Park Ave., N.Y.C. 16

EQUIPMENT AND ACCESSORIES

COMPONENTS at lowest prices anywhere. Write for catalog. The Macalester Corporation 355 Macalester Street, St. Paul 5, Minnesota.

BEST For Less! Hand wired kit components. Dynaco, Harmon-Kardon, Scott, Fisher, etc., at substantial savings. Factory standards and guarantees exceeded. Also all audio equipment. Kit experts! Dynaco specialists! Kitcraft, 738 Washington Avenue, Brooklyn 38, New York, MA 2-6946.

PRICES? The Best! Factory-sealed Hi-Fi Components? Yes! Send for free catalog. Audion, 25R Oxford Road, Massapequa, N.Y.

LOW, Low quotes: all components and recorders. HiFi, Roslyn 9, Penna.

WRITE for quotation on any Hi Fi components: Sound Reproduction Inc., 34 New St., Newark, N.J. Mitchell 2-6816.

DISGUSTED with "Hi" Hi-Fi Prices? Unusual Discounts On Your High Fidelity Requirements. Write: Key Electronics, 120 Liberty St., New York 6, N.Y. Dickens 6-4191.

FREE Catalog—name brand tubes 65% discount, phono needles 80% or more discount, phono cartridges, picture tubes 75¢ inch, parts, parts kits, silicon and selenium rectifiers, transmitting tubes, 7" T.V. test tube \$6.99, imported batteries, tube testers, etc. Want to swap or sell tube inventory? Send us your offering. Arcturus Electronics Corp. Dept. Z.D. 502-22nd St., Union City, N.J.

SALE items—tapes—recorders—component quotations. Bayla—Box 131R—Wantagh, N.Y.

MILITARY Discount—Name brands free recording tape and stereo handbook. Include rank and serial number. Electronics International, Box 3066, Charlottesville, Virginia.

BEFORE You Buy Receiving Tubes, Test Equipment, HiFi Components, Kits, Parts, etc. . . . send for your Giant Free Zalytron Current Catalog, featuring Standard Brand Tubes: RCA, GE, Etc.—all Brand New Premium Quality Individually Boxed, One Year Guarantee—all at Biggest Discounts in America! We serve professional servicemen, hobbyists, experimenters, engineers, technicians. Why Pay More? Zalytron Tube Corp., 461 Jericho Turnpike, Mineola, N.Y.

TRANSISTORIZED Products importers catalog, \$1.00 Intercontinental, CPO 1717, Tokyo, Japan.

CANADIANS—Giant Surplus Bargain Packed Catalogs. Electronics, HiFi, Shortwave, Amateur, Citizens Radio. Rush \$1.00 (refunded). ETCO, Dept. Z, Box 741, Montreal, CANADA.

SAVE dollars on radio, TV-tubes, parts at less than manufacturer's cost. 100% guaranteed. No rebrands, pulls. Request Bargain Bulletin. United Radio, 1000-H, Newark, N.J.

HARPSICHORDS—Clavichords fine European instruments at reasonable prices. Write 3101 Summit Road, San Bruno, California.

THE Price is Right! Hi-Fi Components. J. Wright Co., 65-B Jensen St., East Brunswick, N.J.

MAXIMUM Discounts—America's largest collection of famous brand names. Look Shop Compare and save. Arkay Sales, 46-30 White Street, Somerville 44, Mass.

Hi-Fi Components, Tape Recorders at guaranteed "We Will Not Be Undersold" prices. All brands in stock. 15-day money back guarantee. 2 year warranty. Write your requirements for quotation. No Catalog. Hi-Fidelity Center 1797-R, 1st Ave., New York 28, N.Y.

WE'VE flipped our tweeter—its almost too absurd to believe—we're ashamed to say it but it's true . . . low, low prices on all new top name component brands. Quantity discounts. Start your own business if you don't already have one. We don't care—We love to give away equipment. We're philanthropists. Don't believe us, Write—Hi Fi Mail Discount, 1452 Dartmouth Avenue, Baldwin, L. I. N.Y.

GM Amplifiers tuners—transceivers—radios speakers—Free catalog. GM Photoelectronics 623 Gay, Knoxville, Tenn.

IF you are selling good hi-fi and stereo components, then let the readers of HiFi/Stereo Review know about it by placing a classified ad in this space. It costs very little—only 40¢ a word. Write: Martin Lincoln, HiFi/Stereo Review, One Park Avenue, New York 16, New York.

TAPE AND TAPE RECORDERS

RENT Stereo Tapes—over 2,500 different—all major labels—free catalog. Stereo Partl, 811-G Centinela Ave., Inglewood 3, California.

SAVE 30% Stereo music on tape. Free bargain catalog/blank tape/recorders/norelco speakers. Saxitone, 1776 Columbia Road, Washington, D.C.

SELF-Hypnosis. New concept teaches you quickly by tape or LP-record. Free literature. McKinley Publishers, Dept. T4, Box 3038, San Bernardino, Calif.

4/TR Stereo Tapes—bought, sold, rented, traded! Bargain closeouts! Catalog/COLUMBIA, 9651 Foxbury, Rivera, California.

POPULAR Piano & Organ lessons on tape \$6.00 either tape. Write for particulars. Bob Miller Tapes, Box 132-H, Cranford, N.J.

TAPE recorders, Hi-Fi components, Sleep Learning Equipment, tapes. Unusual values. Free catalog. Dressner, 1523HF Jericho Turnpike, New Hyde Park 9, N.Y.

BEFORE renting Stereo Tapes try us. Postpaid both ways—no deposit—immediate delivery. Quality—dependability—service—satisfaction prevail here. If you've been dissatisfied in the past your initial order will prove that this is no idle boast. Free catalog. Gold Coast Tape Library, Box 2262, Palm Village Station, Hialeah, Florida.

WELCOME to Global Tape Recording Exchange Hobby Club 4518 N. 8th Place, Phoenix, Arizona. Members in 30 nations.

FACTORY-fresh 4-track Stereo Tapes at Cost. All labels. Discount Tapes, Box 1601, Des Moines 6, Iowa.

4-Track Stereo Tapes, 30% off. Complete Selection Stereo Tapes, Box 1611, Des Moines 6, Iowa.

QUALITY: Tape: 73% Discount: Pre-recorded: Catalog Free. Tape King, 3620 Beethoven St., Los Angeles 66, Calif.

MYLAR recording tape. Top quality by major U.S. manufacturer. 2400 feet, seven inch reel, individually boxed. Six for \$16.50 postpaid. Guar. Western Magnetics, Box 3722, Portland 8, Oregon. No C.O.D.s.

SELLING? Renting? Tapes and tape recorders? For fast results, place a low-cost classified ad in HiFi/Stereo Review. It's easy. Write: Martin Lincoln, HiFi/Stereo Review, One Park Avenue, New York 16, New York.

WANTED

QUICKSILVER, Platinum, Silver, Gold. Ores Analyzed. Free Circular. Mercury Terminal, Norwood, Mass.

WANTED: Esl C60 or P60 Cartridge new or excellent condition; Reasonable. Write W. E. Irvin, 3477 E. 65 Street, Cleveland 27, Ohio.

WANT to buy good equipment and accessories? Place a low-cost classified ad in this space. For information, write: Martin Lincoln, HiFi/Stereo Review, One Park Avenue, New York 16, New York.

REPAIRS AND SERVICING

All Makes of Hi-Fi Speakers Repaired. Amprite, 168 W. 23 St., N.Y.C. 7. CH 3-4812.

Hi-Fi Problems solved by "The Hi-Fi Doctor" on the spot. Audio, Acoustic, Radio Engineer, Professional visits, day, evening. New York area. William Bohn, Plaza 7-8569.

DIAGRAMS For Repairing Radios \$1.25. Television \$2.50. Give Make. Model. Diagram Service, Box 672E, Hartford 1, Conn.

TAPE Recorder and HiFi repairs. Amplifiers, tuners, turntables. All American and foreign makes serviced, personal supervision Willard Bloom, IRE. Estimates in 48 hrs. after receiving equipment from any part of U.S. Macken Electronics, 5 West Post Road, White Plains, N.Y., WH9-9777.

RECORDS

RARE 78's, State Category. Write Record-Lists, P.O. Box 2122, Riverside, California.

"HARD To Get" records—all speeds. Record Exchange, 812 Seventh Avenue, New York, N.Y.

CASH For Unwanted LPs. Reder. 81 Forshay Rd., Monsey, N.Y.

LP records like new 25¢ for lists. Refunded first order. Records Hillburn P.O., Hillburn, N.Y.

THE Record Collector Journal—comprehensive, valuable data, varied record mart. Introductory six issues—\$1.50. Record Research, 131 Hart, Brooklyn 6, N.Y.

BOOKS

AUTHORS! Learn how to have your book published, promoted, distributed. Free booklet "ZD," Vantage, 120 West 31 St., New York 1.

PUBLISH your book! Join our successful authors: publicity advertising promotion, beautiful books. All subjects invited. Send for free appraisal and detailed booklet. Carlton Press, Dept. ZDQ, 84 Fifth Avenue, N.Y.C. 11.

BUSINESS OPPORTUNITIES

EARN extra money. No investment required. Part-time selling. Brand name Hi-Fi Components at Discount Prices. Exclusive territories; to qualify you must be a hi-fi enthusiast or knowledgeable in field. Give full info. by letter including 3 business refs. & bank. Greatest opportunity—extra earnings ever offered. Write: I F A Electronics, P. O. Box 559, Encino, Calif.

MISCELLANEOUS

GOVERNMENT Surplus Receivers, Transmitters, Snooperscopes, Parabolic Reflectors, Picture Catalog 10¢. Meshna, Malden 48, Mass.

HARPSICHORD—Same as owned by Philadelphia Orchestra and RCA Victor. In kit form for home workshop assembly \$150. Clavichord kit \$100. Free brochure. Write: Zuckermann Harpsichords, Dept. H, 115 Chris-174—June hi fi stereo review—

SHOPPING GUIDE CLASSIFIED

A HANDY GUIDE TO PRODUCTS AND SERVICES, NOT NECESSARILY IN THE HIGH FIDELITY FIELD, BUT OF WIDE GENERAL INTEREST.

PHOTOGRAPHY — FILM, EQUIPMENT, SERVICES

SCIENCE Bargains—Request Free Giant Catalog "GJ"—144 pages—Astronomical Telescopes, Microscopes, Lenses, Binoculars, Kits, Parts. War surplus bargains. Edmund Scientific Co., Barrington, New Jersey.

FREE! Send now for photographic bargain book. Dept. 32-K-5, Central Camera Company, 230 So. Wabash Ave., Chicago 4, Illinois.

16 mm sound movies, color and b & w. Write today for free listing to Wendell Gilbow, 4509 14th Avenue, Sacramento 20, California Phone 445-4834.

GOVERNMENT SURPLUS

GOVERNMENT surplus direct from Government. Jeeps \$264.00, radios \$2.53, typical prices. Guns, typewriters, cameras, tools, thousands more. Amazing low prices. How, where to purchase, merchandise available, etc., only \$1.00 to: Surplus, P.O. Box 50512, Dept. R, New Orleans 50, Louisiana.

JEEPS \$111.68, boats \$6.20, airplanes, recorders, radios, electronics equipment, thousands of items typically at 90% savings or better. For complete information send \$1.00 to Surplus Service, Box 820, Holland 12, Michigan.

STAMPS AND COINS

SMASHING Collection Free—Includes Triangles, Early United States, Rockets, Sports, British Colonies, High Value Pictorials, etc. Complete collection plus big illustrated Magazine all free. Send 10¢ for postage. Gray Stamp Co., Dept. 22, Toronto, Canada.

EDUCATIONAL OPPORTUNITIES

LEARN While Asleep, hypnotize with your recorder, phonograph. Astonishing details, sensational catalog free! Sleep-Learning Association, Box 24-2D, Olympia, Washington.

LEARN While Asleep. Remarkable, Scientific, 92% Effective. Details Free. ASR Foundation, Box 7021, Dept. e.g., Lexington, Kentucky.

**HiFi/Stereo
Market Place (Cont.)**

**it's no
secret**



that KEY knocks the bottom out of HI-FI prices 'cause no one has been able to keep our amazing discount prices hush-hush. Rush us your list of components and see! Ps-st ... send for our audio discount catalog A17, it's like finding hidden treasure.

KEY ELECTRONICS, CO.
120 Liberty St., N.Y. 6, N.Y.

AUDIO unlimited, inc.

Specializes in
SAVING YOU MONEY
FACTORY FRESH COMPONENTS
LOWEST POSSIBLE QUOTATIONS
FAST DELIVERY

We are FRANCHISED by OVER 50
NATIONALLY FAMOUS MANUFACTURERS. WRITE FOR BARGAIN LIST.

Visit Our Warehouse
715-5 2nd Ave., (Nr. 38th)
New York 16, New York

**NATIONWIDE
DELIVERY...**



on all your Stereo needs.
**Recorders, Tuners, Amplifiers
Turntables, etc.**
LET US PROVE that we can supply your requirements PROMPTLY AT LOWEST COST. FREE CATALOG.

STEREO COMPONENT Supply Co., Dept. S
150 NINTH AVE., NEW YORK 11, N. Y.

**NEVER FAIL —
ZONE
YOUR MAIL**

The Post Office has divided 106 cities into postal delivery zones to speed mail delivery. Be sure to include zone number when writing to these cities; be sure to include your zone number in your return address—after the city, before the state.

autoharp, banjo, tambourine). *Denver; Liza Lee; The Dying Convict; The Invalids; Fire;* and ten others. COLUMBIA CS 8741 \$4.98, CL 1941 \$3.98.

Interest: Polished folk act
Performance: Ingratiating
Recording: Good
Stereo Quality: Natural

Under the direction of Randy Sparks, the New Christy Minstrels is a group of two girls and eight boys who sing folk songs in just about every permutation possible to them. They are a slickly polished act, a little too much so to create anything that sticks to the ribs. Appearances on the *Andy Williams Show* suggest that much of the group's appeal is purely visual.

On this disc, recorded in a night club, they sing some material that the original Christys of Edwin P. Christy's minstrel group—who introduced many Stephen Foster songs—might have sung. They are at their best on these. Other songs, such as the contemporary *You Know My Name*, are embarrassingly sententious.

Much of side two is given over to a humorous entr'acte called *Bits and Pieces*, designed to spotlight the members individually. One of these, lasting less than a minute, is a take-off on country-and-western singer Johnny Cash by a young man named Nick Woods, so accurate as an impression and so devastating as a satire that it is almost worth the price of the entire record. J. G.

SPOKEN WORD

Ⓢ CONTEMPORARY ENGLISH LITERATURE, Volume One: Poetry, read by Robert Graves, Elizabeth Jennings, Edith Sitwell, and C. Day Lewis. FOLKWAYS FL 9888 \$5.95. Volume Two: Poetry and prose, read by Laurie Lee, Christopher Logue, and Professor C. Northcote Parkinson. FL 9889 \$5.95.

Interest: Fine modern writing
Performance: Authentic
Recording: Undistinguished

Folkways has cornered some valuable properties from Jupiter Recordings in London, but created uneasy couplings here. To present the penetrating wit, scholarship, and irresistible readings of poems romantic and anti-romantic by the blindingly brilliant Robert Graves just before the modest contributions of Elizabeth Jennings—all sensibility, contemplation, and muted colors—is unfair to her and disrespectful to him. Volume One is worth having for Edith Sitwell's reading of her haunting *Lullaby* on Side Two as well as her unforgettable *Dirge for the New Sunrise* that mourns the cruelty of our age—when Miss Sitwell elects to be
(Continued on page 97)

**NOT
FOR SALE**

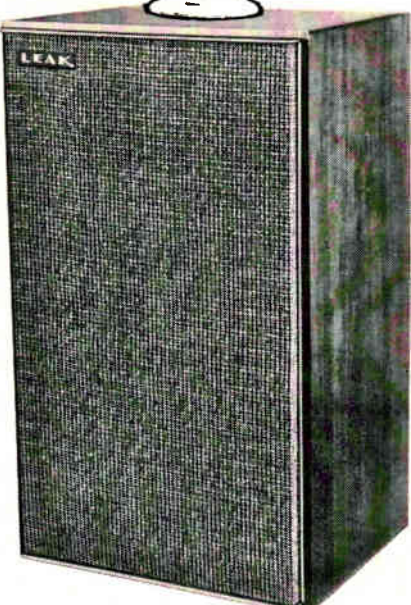

No matter what superlatives, testimonials and/or curves a manufacturer of loudspeaker systems employs in his ads — no one knows better than yourself what sound is best for YOU! That's why this ad doesn't try to SELL you on the dynamic new LEAK Piston-Action Sandwich Speaker System.

Certainly! we have dramatic evidence of its superiority... its absolute smoothness of transient response... its total absence of cone breakup... and other pertinent characteristics... BUT we only want to impart the idea that this New LEAK Speaker System is THE system you must listen to before you select any.

Whether you expect to invest in a system now or sometime soon, you owe it to yourself to visit your nearest Authorized Leak Franchised Specialist and HEAR why Leak has received such superb commendations for its revolutionary principles, smooth performance and "grand sound."... in the meantime, if you want to satisfy your "technical eye"... TEST REPORTS are available at all Leak Franchised Specialists, or write:



LEAK
ENGINEERING | RESEARCH | MANUFACTURING

Exclusive U.S. Representatives:
ERCONA CORPORATION
16 West 46th Street
New York 36, New York

HiFi / STEREO MARKET PLACE

FAST SHIPMENTS
COMPONENTS • KITS
RECORDERS • TAPES

- BEST-BY-COMPARISON PRICES
- FACTORY SEALED CARTONS
- SEND FOR "QUOTES" ON PACKAGE DEALS AND SAVE MORE

WRITE FOR MONTHLY SPECIALS
 VISIT OUR STORE
 **CARSTON Studios**
 125-H East 88 St., New York 28, N. Y.

Universal
STEREO TAPE CLUB
 The Only Club Offering
 Every Pre-Recorded Tape ...
 Every Label, Every Artist ...
ALL AT COST!

Send \$5.00 for one year membership in the Universal Tape Club. Save up to 50% and more off manufacturer's list prices on all pre-recorded stereo tape. Act now!

Free! Complete tape catalog if you enroll now!
 All tapes factory fresh and fully guaranteed!

Universal Tape Club Box 1111 T
 Mountainside, N. J.

Quick-See RETRACTIBLE
 GLIDES IN AND OUT OF CABINET OR WALL FOR FRONT-VIEW FLIP-THROUGH SELECTION **Album File**



Storage cabinets available or do-it-yourself
 Eliminates visibility problem of edge-stacked albums, stops jacket-bottom wear. Installs anywhere in five minutes with 4 screws. Sturdy welded steel construction, ball-bearing tracks, balanced suspension. 9 models for LP's & tape, hold up to 25 albums—brass finish, \$7.95 up. Write for brochure D. Dealer inquiries invited.

KERSTING MFG. CO., 504 S. OATE, ALHAMBRA, CALIF.

DIXIE
HIGH FIDELITY WHOLESALERS

Largest discount High Fidelity component distributors in the South. Wholesale prices on package or individual components. Latest models in factory sealed cartons. Special attention given to Audio Clubs, Churches and Schools.

Are prices too high?—Write
DIXIE HI-FI
 12402 Connecticut Ave., Silver Spring, Md.

LOW WAREHOUSE PRICES
WAREHOUSE DIRECT SHIPMENTS

SPECIAL WAREHOUSE PACKAGE DEALS
 ALL BRAND NEW COMPONENTS
 FRESH FROM WAREHOUSE

GET OUR
STEREO WAREHOUSE PRICE LIST



WAREHOUSE
 228-S Greenway Terrace, River Edge, N.J.

DOWN TO EARTH
 Everyone's going for Audion's
 "Down to Earth" Hi-Fi Values.

Check with **AUDION** before buying HI-FI components

Write for free catalog.



25 K OXFORD ROAD
 MASSAPEQUA, L.I., N.Y.

PROMPT DELIVERY
LOW PRICES

AMPLIFIERS — MULTIPLEX — TAPE RECORDERS, TUNERS, SPEAKER SYSTEMS, ETC.
 AIR MAIL QUOTES — COMPARE
 WRITE FOR CATALOG

AUDIO DIVISION
L. M. BROWN SALES CORP
 Dept. S—242 West 10th Street • New York 14, N. Y.

RENT 

STEREO TAPES

- Over 2500 different, 4-track & 2-track
- No deposit on tapes rented
- Postpaid 2 to 5 day delivery (48 States)

FREE BROCHURE **stereo-parti**
 811-B CENTINELA, INGLEWOOD, CALIF

BRITISH HI-FI COSTS LESS WHEN YOU BUY DIRECT FROM

C. C. GOODWIN (Sales) Ltd.
 The U.K. Hi-Fi Mail Order Specialists

All equipment carefully packed, insured and shipped promptly at minimum cost.

Send details of Hi-Fi Equipment required to:
 DEPT. HS, 7, BROADWAY, WOOD GREEN, LONDON, N. 22, ENGLAND

SAVE MONEY ON HI-FI COMPONENTS

**TAPE RECORDERS
 TAPES, ACCESSORIES
 SLEEP LEARN KITS**

MERITAPE
 Low cost, high quality recording tape, in boxes or cans.

FREE **1963 CATALOG**

DRESSNER 1523 JERICHO TPKE.
 NEW HYDE PARK 21, N.Y.

SAXITONE RECORDING TAPE

*Oxide guaranteed not to rub off or squeak—or money back. Compare ours with other "Bargain" tape. You'll find it's more than just "price" when you deal with us. We are original pioneers in the tape recorder business and our reputation means everything to us.

| | |
|-----------------------------------|------|
| 225' MYLAR, 3" (in mailable box) | .39 |
| 800' acetate (plastic), 5 inch | .75 |
| 600' MYLAR, 5 inch reel | .85 |
| 900' MYLAR (Polyester), 5 inch | .89 |
| 1200' MYLAR, 1/2 mil, 5 inch reel | 1.18 |
| 1200' MYLAR, tensilized, 5 inch | 1.59 |
| 1200' acetate (plastic), 7 inch | 1.15 |
| 1200' MYLAR, 1 1/2 mil, (strong) | 1.29 |
| 1800' acetate (plastic), 7 inch | 1.39 |
| 1800' MYLAR, 1 mil, thick, 7 inch | 1.89 |
| 2400' MYLAR, untensilized, 7 inch | 2.59 |
| 2400' MYLAR, tensilized, 7 inch | 2.89 |

(Large Users Even Lower)

SAVE 30% 4-track stereo music on tape PLUS POSTAGE

NORELCO SPEAKERS
 Famous A13800M, twin cone 8" (75-19,000 cycles) comparable net 9.99 now 4.95, 9 for 9.00 plus postage. OTHER Norelco models at BIG DISCOUNTS. Specifications on entire Norelco line sent on request.

SAXITONE TAPE SALES
 div. Commission Electronics, Inc.
 1776 Columbia Rd., Wash., D.C.



WRITE FOR QUOTATION
 ON ANY HI-FI COMPONENTS

SOUND REPRODUCTION, INC.

34 New Street, Newark 2, N. J.
Mitchell 2-6816

Ⓢ Ⓜ RIVERWIND (John Jennings). Original-cast album. Lawrence Brooks, Elizabeth Parrish, Helon Blount, Dawn Nickerson, Lovelady Powell, Brooks Morton, Martin Cassidy; orchestra, Abba Bogin cond. LONDON AMS 78001 \$5.98, AM 48001 \$4.98.

Interest: Attractive maiden effort
Performance: Generally very good
Recording: Splendid
Stereo Quality: Very high

Off-Broadway continues to set the pace for the discovery of new talent for the musical theater. John Jennings's maiden professional effort, *Riverwind*, reveals a writer with an assuredly great future. What becomes apparent immediately is that he is that rare article, a composer not afraid of melody. For the most part, his songs require well-trained, legitimate voices, and—for the most part—that is what he gets. Lawrence Brooks, Elizabeth Parrish, and Helon Blount are singers who sing, and, to repeat, Mr. Jennings has given them something to sing.

As a beginner, of course, Mr. Jennings may be excused a few numbers that do not quite come off. The title song is rather uninspired, and I felt that the comic pieces, *American Family Plan* and *Almost but not Quite*, are—well—almost but not quite. They are, however, performed with great relish by Lovelady Powell and Brooks Morton.

London gives the whole thing excellent sound, and enhances the theatrical illusion with scraps of dialogue and a few sound effects. S. G.

FOLK

RECORDING OF SPECIAL MERIT

Ⓢ Ⓜ MARIO ESCUDERO: *Fiesta Flamenca*. Mario Escudero (guitar), Anita Ramos (castanets and dancing). *Tientos del Amanecer; Recuerdos de Alhambra; Tobalo; Canastilla de Madronos*; and six others. ABC-PARAMOUNT ABCS 428 \$4.98, ABC 428* \$3.98.

Interest: Impassioned flamenco
Performance: Brilliant
Recording: Superb
Stereo Quality: Excellent

Born in Spain of a gypsy father and a Castilian mother, Mario Escudero has been living in America since 1955. Now acknowledged as one of the major interpreters of flamenco, Escudero has created here one of his most stunning albums. The playing is both impassioned and strongly disciplined.

The repertoire is fresh and varied, and includes—among other examples of the elasticity of flamenco subject matter—a gypsy wedding dance, an oriental fantasy, and a bristling combination of

$\frac{3}{4}$ and $\frac{6}{8}$ rhythms within a traditional form dating back to the eighteenth century. The explanatory notes are excellent and the quality of the sound is extraordinary. The natural presence of Escudero's guitar (played without the use of a capo, a movable bridge) is caught fully, the entire range of the instrument has been reproduced with no trace of distortion and with no control-room manipulation of dynamics. In sum, a distinguished flamenco album. N. H.

RECORDING OF SPECIAL MERIT

Ⓢ Ⓜ LESTER FLATT AND EARL SCRUGGS: *Hard Travelin'*. Lester Flatt (vocals and guitar), Earl Scruggs (banjo), Paul Warren (violin), Buck Graves (dobro guitar), E. P. Tullock, Jr. (bass). *The Wreck of the Old 97; Coal Miner's Blues; The Ballad of Jed Clampett; Bound to Ride*; and eight others. COLUMBIA CS 8751 \$4.98, CL 1951* \$3.98.

Interest: Diversified Bluegrass
Performance: Expert
Recording: Excellent
Stereo Quality: Very good

In response to the demands of their growing audience in colleges and in metropolitan areas, Lester Flatt and Earl Scruggs have been expanding their repertoire. In their previous Columbia set, "Folk Songs of Our Land," they included a Woody Guthrie tune. In this collection, there are two Guthrie numbers, *Hard Travelin'* and *Pastures of Plenty*. Guthrie's tunes fit easily into the Flatt and Scruggs Bluegrass idiom, and sound as if Guthrie had written them specifically for this combo. Among the rest are variants of traditional ballads, gospel-style songs, and the idiomatic theme of the television series, *The Beverly Hillbillies*.

Although the instrumental virtuosity of this group—particularly the wizardry of Scruggs's banjo—is persistently evident, the album focuses on Flatt's singing. Without overstating a lyric, Flatt sustains a narrative with an unerring sense of shading, combined with melodic grace and balance. He sings these songs with the prideful but casual air of a man who might have lived through the experiences they describe.

The set is an excellent introduction to the increasing variety of the Bluegrass repertoire. Adding to a fuller understanding of this tradition are Peter Wellding's comprehensive notes. N. H.

Ⓢ Ⓜ NEW CHRISTY MINSTRELS: *In Person*. Randy Sparks, Peggy Connelly, Jackie Miller, Art Podell, Larry Ramos, Clarence Treat, Barry McGuire, Barry Kane, Nick Woods, Dolan Ellis (vocals, guitar, mandolin, bass, requinto, (Continued on page 95)

Latest Releases!

ON DAUNTLESS

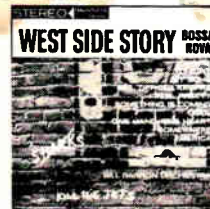
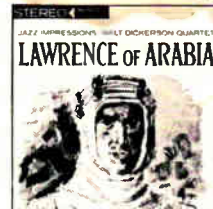

JAZZ IMPRESSIONS—LAWRENCE OF ARABIA, Walt Dickerson Quartet

Walt Dickerson is one of the best and most exciting of modern jazz vibist artists. He expresses some of the wild, desolate beauty of the desert in this fine adaptation from the film score. Includes: Lawrence Of Arabia Theme, Arrival At Auda's Camp, The Voice Of The Guns, others.

DM 4313/DS 6313

WEST SIDE STORY BOSSA NOVA

Features Bill Barron on saxophone; Willie Thomas on trumpet plus five more outstanding jazz men in an unique interpretive gem. Tunes with a bossa nova beat include: Tonight, Maria, Officer Krupkee, Something's Coming, Jet Song, America, others.

DM 4312/DS 6312

MONO (DM)—\$3.98 STEREO (DS)—\$4.98

ON AUDIO FIDELITY



THE BOSSA TRES

The unusually fiery style of this popular Brazilian trio displays their great improvisation ability in the American jazz idiom combined with their own traditional samba beat. Includes: Somebody Loves Me, Green Dolphin Street, Zalao, others.

AFLP 1988/AFSD 5988

RUSSIAN ROULETTE and other Bullet-Proof Gags, Bob Prescott

Side-splitting situation sound effects gags to enliven the hi-fi listening pleasure of one and all. Includes: The Elevator, The Submarine, Cape Canaveral, The Mosquito. 24 in all including hilarious title skit.

AFLP 2103/AFSD 6103

BIG TOP CIRCUS CALLIOPE, featuring Paul Eakins' Wurlitzer Calliola

From the world's greatest collection of mechanical and wind instruments at the Gay 90s Village... Recorded out of doors to capture the bigger-than-life sound of this fantastic instrument. Big top tunes include: Washington Post, The Thunderer, Over The Waves, others.

AFLP 1986/AFSD 5986

BIG TOP CAROUSEL BAND ORGAN, featuring Paul Eakins' Wurlitzer Band Organ

Another great musical device... recorded out of doors in unsurpassed high fidelity! Includes: My Wild Irish Rose, Sidewalks Of New York, School Days, On The Midway and 8 others.

AFLP 1987/AFSD 5987

Just released in stereo!

FIESTA EN MEXICO, Mariachis
AFLP 1816/AFSD 5816

MONO (AFLP)—\$4.98/STEREO (AFSD)—\$5.95

Please write for FREE complete catalogs

AVAILABLE AT YOUR RECORD STORE

OR WRITE: AUDIO FIDELITY INC.

770 Eleventh Ave., New York 19, N.Y.

CIRCLE NO. 10 ON READER SERVICE CARD

Send HiFi/Stereo Review Every Month



Check one: 3 years for \$12
 2 years for \$9 1 year for \$5
 in the U.S. and Possessions
 Payment Enclosed Bill Me
 Foreign rates: Canada and Pan American Union countries, add \$.50 per year; all other foreign countries add \$1.00 per year.

New Renewal

name _____
 address _____
 city _____ zone _____
 state _____

Mail to:

HIFI/STEREO REVIEW

434 S. Wabash Ave. Dept. 1-8061 Chicago 5, Ill.

DIRECT FROM ITALY... OVER 30 YEARS OF QUALITY

LESA



Lesamatic
record player

\$79.50

(with Jam-proof arm)

For more information about this and other exciting new products, please write for brochure to Lesa of America Corp., 32-17 61 Street, Woodside 77, New York, Dept. H-F

NOTE: LESA ANNOUNCES A ONE-YEAR GUARANTEE ON ALL PRODUCTS!



ENTERTAINMENT REVIEWS

IN BRIEF

| DATA | COMMENTARY |
|---|---|
| <p>© LENNY BRUCE: <i>Lenny Bruce—American</i>. FANTASY 7011 \$4.98.</p> | <p>Bruce is undeniably a skillful performer, but it is evident in this disappointing album that he is more concerned with shocking than with entertaining and enlightening his audience. S. G.</p> |
| <p>© DUNA ENSEMBLE OF BUDAPEST: <i>Folklore from Hungary</i>. Orchestra and chorus of Duna Ensemble. <i>Somogy; Kunság; Palóc</i>; and four others. WESTMINSTER WST 17008 \$5.98, XWN 19008* \$4.98.</p> | <p>Although this is no ethnic field recording, Béla Vavrincz and the trained singers and musicians of his Duna ensemble retain much of the spirit of the Hungarian folk songs on which their arrangements are based. The recorded sound is very good. N. H.</p> |
| <p>© BURL IVES: <i>Songs of the West</i>. Burl Ives (vocals); unidentified accompaniment. <i>Home on the Range; The Last Round-Up; Jingle Jangle Jingle</i>; and nine others. DECCA DL 74179* \$4.98, DL 4179 \$3.98.</p> | <p>The bloodless choral background and limp instrumental accompaniment lead Ives into innocuous, characterless interpretations of cowboy ballads that are too familiar to start with. The recorded sound is good. N. H.</p> |
| <p>© CHARLIE MANNA: <i>Manna-Live! Bon Voyage; Rocket to the Moon; Ides of March</i>; and others. DECCA DL 74213 \$4.98, DL 4213* \$3.98.</p> | <p>This Charlie Manna album reaffirms his position as one of the brightest young comics around. His skillful use of accents heightens the fun. The recording is fine. S. G.</p> |
| <p>© LIONEL NEWMAN: <i>Music by Erich Wolfgang Korngold</i>. Orchestra, Lionel Newman cond. Themes from <i>Kings Row; Anthony Adverse; The Sea Hawk</i>; and four others. WARNER BROS. WS 1438 \$4.98, W 1438* \$3.98.</p> | <p>The film scores of Erich Wolfgang Korngold, written in the 1930's and 1940's for Warner Brothers epics, sound a bit old-fashioned today. However, this group of selections from Korngold's best-known film scores serves to remind us of his place in the development of movie music. S. G.</p> |
| <p>© DICK SCHORY: <i>Stereo Action Goes Broadway</i>. Dick Schory's Percussion and Brass Ensemble. <i>Heat Wave; 76 Trombones; Keep-a-Hoppin'; Bali Ha'i; It's Legitimate; Slaughter on 10th Ave.; Hernandez's Hideaway; I Got Rhythm; Camelot; Show Me; Sound of Music; Sombrero</i>. RCA VICTOR LSA 2382 \$5.98.</p> | <p>Dick Schory has what many of his colleagues lack: a sense of humor, which serves to enliven what might otherwise have been merely another exercise in mobile percussion-pounding. <i>Camelot</i>, for example, features a trumpet fanfare, a drawbridge opening, and King Arthur trotting back and forth on his horse. The sound is excellent. S. G.</p> |
| <p>© THE YOUNG SAVAGES (David Amram). Sound-track recording. Orchestra, David Amram cond. <i>Harold's Way; Muchachas delicadas; True Blue; Last Taco</i>; and eight others. COLUMBIA CS 8472 \$4.98, MCL 1672* \$3.98.</p> | <p>David Amram's colorful, intense score for this nonmusical counterpart to <i>West Side Story</i> is divided in half—jazz on the first side of the record and orchestral themes on the other. The performance is frequently exciting, and the stereo is effective. S. G.</p> |



Why We Make the Model 211 Available Now

Although there are many stereo test records on the market today, most critical checks on existing test records have to be made with expensive test equipment.

Realizing this, HiFi/STEREO REVIEW decided to produce a record that allows you to check your stereo rig, accurately and completely, just by listening! A record that would be precise enough for technicians to use in the laboratory—and versatile enough for you to use in your home.

The result: the HiFi/STEREO REVIEW Model 211 Stereo Test Record!

Stereo Checks That Can Be Made With the Model 211

- ✓ Frequency response—a direct check of eighteen sections of the frequency spectrum, from 20 to 20,000 cps.
- ✓ Pickup tracking—the most sensitive tests ever available to the amateur for checking cartridge, stylus, and tone arm.
- ✓ Hum and rumble—foolproof tests that help you evaluate the actual audible levels of rumble and hum in your system.
- ✓ Flutter—a test to check whether your turntable's flutter is low, moderate, or high.
- ✓ Channel balance—two white-noise signals that allow you to match your system's stereo channels for level and tonal characteristics.
- ✓ Separation—an ingenious means of checking the stereo separation at seven different parts of the musical spectrum—from mid-bass to high treble.

ALSO:

- ✓ Stereo Spread
- ✓ Speaker Phasing
- ✓ Channel Identification

PLUS SUPER FIDELITY MUSIC!

The non-test side of this record consists of music recorded directly on the master disc, without going through the usual tape process. It's a superb demonstration of flawless recording technique. A demonstration that will amaze and entertain you and your friends.

JUNE 1963

TRY THIS **STEREO TEST RECORD!!**

Special to our readers
for only **...\$3.98**

Featuring Tests Never Before Available
Outside Of The Laboratory

UNIQUE FEATURES OF HiFi/STEREO REVIEW'S MODEL 211 STEREO TEST RECORD

- Warble tones to minimize the distorting effects of room acoustics when making frequency-response checks.
- White-noise signals to allow the stereo channels to be matched in level and in tonal characteristics.
- Four specially designed tests to check distortion in stereo cartridges.
- Open-air recording of moving snare drums to minimize reverberation when checking stereo spread.

All Tests Can Be Made By Ear

HiFi/STEREO REVIEW's Model 211 Stereo Test Record will give you immediate answers to all of the questions you have about your stereo system. It's the most complete test record of its kind—contains the widest range of check-points ever included on one test disc! And you need no expensive test equipment. All checks can be made by ear!

Note to professionals: The Model 211 can be used as a highly efficient design and measurement tool. Recorded levels, frequencies, etc. have been controlled to very close tolerances—affording accurate numerical evaluation when used with test instruments.

DON'T MISS OUT—ORDER NOW AND SAVE \$1

The Model 211 Stereo Test Record is a full 12" disc, made from the finest virgin vinyl. For a limited time only, it is being sold by HiFi/STEREO REVIEW for \$3.98. Starting July 1, 1963, we will sell this record for \$4.98. Order now and save \$1. Make sure you don't miss out on this special offer. Fill in and mail the coupon, together with your check (\$3.98 per record) today!

FILL IN AND MAIL TODAY!

Stereo Test Record
Hi-Fi/Stereo Review—Dept. SD
One Park Ave., New York 16, N.Y.

Please send me _____ test records at \$3.98 each. My check (or money order) for \$_____ is enclosed. I understand that you will pay the postage and that each record is fully guaranteed.

Name _____
(Please Print)

Address _____

City _____ Zone _____ State _____

SORRY—No charges or C.O.D. orders!
(Special price offer of \$3.98 expires on June 30, 1963) HF 663

records
sound
best
with

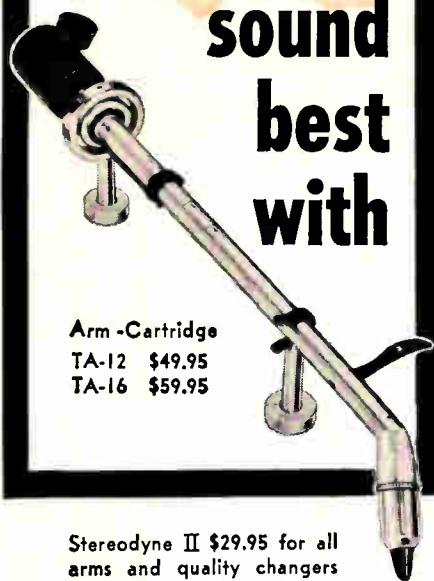

Arm-Cartridge
TA-12 \$49.95
TA-16 \$59.95

Stereodyne II \$29.95 for all
arms and quality changers



DYNACO D & B
STEREODYNES

The exclusive quadri-coil, triple-balanced push-pull magnetic cartridge gives you the smoothest sound you've ever heard from records with complete freedom from hum.

Feather-light tracking, high compliance low-mass armature, and dynamic equilibrium of the arm (a combination of low inertial mass, virtually frictionless gimbal mounting, and exclusive ISODYNE* inertial balance) dramatically increase record life and give natural balance to your recordings with lower distortion, proper phase relationships at all frequencies, uniform channel separation, and extraordinary resistance to turntable jarring.

*ISO=equal DYNE=measure of force

Write for complete specifications.

DYNACO

DYNACO, INC.
3912 Powelton Ave., Phila. 4, Pa.

CIRCLE NO. 60 ON READER SERVICE CARD

A Sleepin' Bee; and eight others. COLUMBIA CS 8807 \$4.98, CL 2007* \$3.98.

Interest: Considerable
Performance: Fascinating stylist
Recording: Very close, with reverb
Stereo Quality: Fine

The eagerly awaited Barbra Streisand album—called, with disarming simplicity, “The Barbra Streisand Album”—turns out to be a fascinating package. Miss Streisand is a compelling stylist, with a full, rich vocal quality that may give you goose bumps when you hear her more dramatic arias. She has a sure control and knows what she is doing at all times.

There are few (if any) better versions of *Cry Me a River* and *Soon It's Gonna Rain*. The up-tempo numbers, especially *My Honey's Lovin' Arms*, done with bouncy urgency, and an exuberant *Keepin' out of Mischief Now*, are equally appealing.

My only complaint is that the supposedly comic numbers—*Who's Afraid of the Big Bad Wolf* and *Come to the Supermarket*—are out of place in the program; they lose their point when heard away from the situations for which they were created. Peter Matz, who is one of the finest arranger-conductors around, is an invaluable help in making the program the almost complete delight that it is. S. G.

THEATER—FILMS

Ⓢ Ⓜ **THE DESERT SONG** (Sigmund Romberg-Otto Harbach-Oscar Hammerstein II). Gordon MacRae, Dorothy Kirsten, Gerald Shirkey, Lloyd Bunnell; members of the Roger Wagner Chorale, orchestra, Van Alexander cond. CAPITOL SW 1842 \$5.98, W 1842* \$4.98.

Ⓢ Ⓜ **THE STUDENT PRINCE** (Sigmund Romberg-Dorothy Donnelly). Gordon MacRae, Dorothy Kirsten, Earle Wilkie, William Felber, Richard Robinson; members of the Roger Wagner Chorale, orchestra, Van Alexander cond. CAPITOL SW 1841 \$5.98, W 1841* \$4.98.

Interest: Operetta warhorses
Performance: In the right spirit
Recording: Beautiful
Stereo Quality: High

In listening to these two releases, the listener realizes why the schmaltzy operettas of the past are still being performed throughout the United States. There is just no denying that while the stories may be infantile and the lyrics frequently embarrassing, Sigmund Romberg's music has a richness and emotional impact that are completely impervious to time. From first note to last, one throbbing, soaring melody follows another, making even the

corniest sentiment not only palatable but downright irresistible.

Capitol's singers are equal to the job. Gordon MacRae, who previously recorded excerpts from these operettas, and Dorothy Kirsten, who once did a memorable *Student Prince* for Columbia, have just the voices for this brand of musical lushness, and members of the Roger Wagner Chorale offer splendid support. I also have great admiration for the spirited conducting of Van Alexander.

Despite these pleasures, I must confess to a certain disappointment that neither recording includes anything but the best-known—and most frequently recorded—selections, and that both have been padded with lengthy overtures and reprises. For this reason, my preferred *Desert Song* is the more complete version on Angel S 35905, which offers a better Red Shadow, sung by Edmund Hockridge, and equally good sound. A choice among *Student Princes* is a bit more difficult: more music and a younger Dorothy Kirsten are on Columbia CL 826, but its sound is no match for the current release.

Both albums use stereo to good dramatic effect. The opening chorus of *Desert Song*, for example, is first heard deep in the left speaker and then comes forward. A similar illusion of movement is apparent at the beginning of the *Marching Song* in *The Student Prince*. S. G.

Ⓢ Ⓜ **JUMBO** (Richard Rodgers-Lorenz Hart). Sound-track recording. Doris Day, Martha Raye, Jimmy Durante, Stephen Boyd; orchestra and chorus, George Stoll cond. COLUMBIA OS 2260 \$5.98, OL 5860* \$4.98.

Interest: Delightful score
Performance: Good enough
Recording: Muddy at times
Stereo Quality: Adequate

Some twenty-seven years after its Broadway run, *Jumbo* has finally been made into a movie. The good news is that all but one of the published songs from Rodgers and Hart's original score have been retained, and two others, *Why Can't I?* and *This Can't Be Love*, added from other productions. The songs are as bright and endearing as they ever were, and most are sung with well-scrubbed affectation by Doris Day. Stephen Boyd does an acceptable, straightforward job on *The Most Beautiful Girl*, but Jimmy Durante scores even more impressively in a reprise. Musical historians may want to note that the song's original rhyme, “Isn't Garbo, isn't Dietrich/ But the sweet trick,” has been universalized to “Isn't Juno, isn't Venus/ But between us.” Incidentally, the lengthy finale, *Sawdust, Spangles and Dreams*, is the creation of assistant producer Roger Edens. S. G.

(Continued on page 93)

HiFi/Stereo

ENTERTAINMENT

P H F I L M S

Humor Theater Folk

Reviewed by JOE GOLDBERG • STANLEY GREEN • NAT HENTOFF • PAUL KRESH

Explanation of symbols:

Ⓜ=monophonic recording

Ⓢ=stereophonic recording

*=mono or stereo version not received for review

Ⓢ Ⓜ SAMMY DAVIS, JR.: *At the Coconut Grove*. Sammy Davis, Jr. (vocals); orchestra, George Rhodes cond. *In the Still of the Night; River Stay 'Way from My Door; Night and Day;* others. REPRISE 96062/3* two 12-inch discs \$9.96, 6062/3 \$7.96.

Interest: Lively club routine
Performance: Occasionally exciting
Recording: Good

One of the most winning things about this two-record set is that Sammy Davis, Jr. is so obviously delighted to be doing just what he is doing. Taped during a performance at the Coconut Grove in Los Angeles, it presents the engaging performer singing his songs, doing his impersonations, clowning with the audience, spotlighting various members of the orchestra, telling anecdotes about himself, soft-shoeing across the floor, and, in general, having himself a ball.

Although Davis is primarily a showman, he is also a song stylist of considerable ability. Accompanied only by Terry Rosen's guitar, he begins *What Kind of Fool Am I?* in an almost conversational manner; then, with full orchestral backing, he builds the second chorus to an emotion-charged ending. Equally effective is Davis's capsule run-through of *West Side Story* numbers, with Johnny Mendoza's rapid-fire bongo-beating as sole accompaniment.

I am still not won over by Mr. Davis's skill as an impersonator, although his take-offs on Nat King Cole, Frankie Laine, Louis Armstrong, and James Stewart are quite good. The Sinatra routine, however, is only fair. I wish too that he would cut down on his monologues. The bit about meeting Kennedy is hard to swallow, and the run-down of the story of *The Three Musketeers* is pointless. George Rhodes's orchestra performs well throughout, with special praise due Rosen, Mendoza, and the other soloists in the jam session. S. G.

Ⓢ Ⓜ CARMEN MCRAE: *Something Wonderful*. Carmen McRae (vocals); orchestra, Buddy Bregman cond. *Just in Time; A Wonderful Guy; Warm All Over;* and fifteen others. COLUMBIA CS 8743 \$4.98, CL 1943* \$3.98.

Interest: Broadway bounty
Performance: Stylish
Recording: Very good
Stereo Quality: Satisfactory

Eighteen numbers are included here in this grab-bag of musical-comedy tunes, and all are performed with razor-sharp finesse by the elegant Miss McRae. The format is a medley saluting some of the great musical-comedy stars of the past

Ⓢ Ⓜ EDDIE OSBORNE: *At the Baldwin Organ*. Eddie Osborne (organist). *Shine; Mr. Sandman; Moon River;* and nine others. AUDIO FIDELITY AFSD 5968 \$5.95, AFLP 1968* \$4.98.

Interest: Impressive instrument
Performance: Expert
Recording: Very good
Stereo Quality: High

The organ on display here is a relatively new home model (46 hp) by Baldwin, designed for the express purpose of recapturing the dramatic sounds of the movie-theater organ. This it does most impressively through its three-channel amplification and the wide range of its



COLUMBIA RECORDS

CARMEN MCRAE
Razor-sharp and stylish in a salute to Broadway

and present—but, to be hair-splitting about it, four of the numbers were not originally sung by the actresses they are attributed to. Miss McRae is not an impersonator. She is quite the contrary—one of our most stylish if stylized singers, with a delivery marked by extraordinarily artful phrasing and striking articulation. Her voice may not always be up to the demands of some of the selections, but she manages to find new subtleties and meanings in even the best-known pieces. Especially recommended are the songs from *Two on the Aisle* and *Bells Are Ringing*. S. G.

twenty-two pedal voices. Mr. Osborne's expertise in playing the instrument is most fortunate, since he is manager of Baldwin's Home Organ Division. The Audio Fidelity sound is lifelike, and widely separated stereo channels make the organ seem even larger than it is. S. G.

RECORDING OF SPECIAL MERIT

Ⓢ Ⓜ BARBRA STREISAND: *The Barbra Streisand Album*. Barbra Streisand (vocals); orchestra, Peter Matz cond. *A Taste of Honey; Much More;*

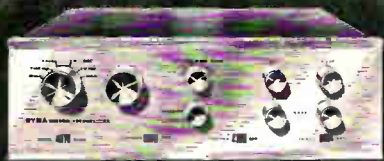

You push the button down, the music goes round and round



and it comes out great!

headset by KOSS / Tuner and preamp from DYNACO

CAPTURED BY CONCORD: SOUNDS FOR CONNOISSEURS

The magnificent Concord 880 (as do all professional tape recorders) has three separate heads—one record, one playback and one erase. To make professional quality stereo tape recordings from F.M. multiplex, stereo records, or live performances, your tape recorder must have three heads!

Operational conveniences include all push button controls, three speeds, two VU meters, and two professional full range dynamic microphones. The Concord 880 records 4-track mono or stereo, sound on sound, and sound with sound. *Priced less than \$400!*

Other outstanding features • Trans-A-Track for sing-a-long or music and language instruction • Exclusive computerized channel indicator • 10 watt dual amplifiers • Separated full range 7" speakers for perfect stereo • Dual cathode follower outputs • Flutter-free salient pole drive motor • Built-in monitoring and P.A. facilities.

CONCORD 880

CONCORD  ELECTRONICS CORPORATION

809 North Cahuenga Boulevard, Dept. F, Los Angeles 38, California / In Canada: Regal Industries Ltd., Montreal

CIRCLE NO. 16 ON READER SERVICE CARD

OTHER CONCORD MODELS

CONCORD 550—transistorized 4-track stereo record and playback: push button operation, three speeds, Trans-A-Track, sound-on-sound, dual amplifiers, two VU meters, separated 6" speakers for full stereo effect. *Priced less than \$320!*

CONCORD 550D—tape deck version of transistorized Stereo 550. *Priced less than \$230!*

CONCORD 220—Hi fidelity mono recorder, all push button, three speeds, varisync flutter-free drive motor, dynamic microphone, cue and edit button, magic eye record level indicator, plus Audio-Syncntrol accessory for home movie sound. *Priced less than \$150 plus Audio-Syncntrol attachment.*

Prices slightly higher in Canada.



themselves. Judy Garland has several agreeable songs to sing—among them the ballad *Little Drops of Rain*, *Paris Is a Lonely Town* (which sentiment Leonard Bernstein once felt about New York—but more pointedly), and a solid swinger titled *Roses Red, Violets Blue*. Robert Goulet sings a tribute to what *The Money Cat* can do. The tape transfer is without blemish. C. B.

RECORDING OF SPECIAL MERIT

© **CISCO HOUSTON: *Songs of Woody Guthrie***. Cisco Houston (vocals and guitar), Eric Weisberg (banjo, mandolin, fiddle). *Pastures of Plenty: Ship in the Sky; Deportees; Grand Coulee Dam*; and fourteen others. VANGUARD VTC 1656 \$7.95.

Interest: Authentic Americana
 Performance: Ingratiating
 Recording: Good
 Stereo Quality: Incidental

Ranging in subject matter from Colorado's Grand Coulee Dam to the tall tales of fish hauled from the land's waters, from the ladies' auxiliary to the auxiliary comfort a lady from "sunny Tennessee" can offer a lonely man, these songs by Woodie Guthrie constitute a panorama of America's bounty and variety. The late Cisco Houston, a close friend of Guthrie for over twenty years, sings them in a disarmingly straightforward manner, accompanying himself on the guitar, with an occasional assist from Eric Weisberg. A fine collection. C. B.

© **ROGER WAGNER CHORALE: *Victor Herbert on Stage. In Old New York; Ah! Sweet Mystery of Life; Every Day Is Ladies' Day with Me; A Kiss in the Dark***; and nine others. Roger Wagner Chorale, orchestra, Roger Wagner cond. CAPITOL ZW 1707 \$7.98.

Interest: Broadway classics
 Performance: Con amore
 Recording: Warm-toned
 Stereo Quality: Balanced

Roger Wagner's sophisticated, unmanipulated arrangements are a constant delight, and the program is an affectionate salute to one of America's great song writers, the composer of *The Fortune Teller* (1898), *Babes in Toyland* (1903), *Mademoiselle Modiste* (1905), *The Red Mill* (1906), and others represented here. The haunting *Indian Summer*, composed in 1919 as a piano piece, is the only number in the collection that does not come from the operetta stage Herbert enlivened for so many years. The chorus contributes smooth, integrated ensemble work, and the glowing, evenly distributed stereo sound gilds a thoroughly attractive four-track release. C. B.

THE ART OF THE PRIMA BALLERINA

At last an album of ballet music for people who LOVE ballet. Authentic dance tempi recorded with the approval of ALICIA MARKOVA

Minkus: La Bayadère; Drigo: Pas de trois; Rossini: William Tell—Ballet Music; Adam: Giselle—Excerpts; Lovenskjold: La Sylphide; Tchaikovsky: Swan Lake—The Black Swan; Donizetti: La Favorita—Ballet Music; Minkus: Don Quixote—Pas de deux; Bolero 1830; Pagni: Pas de quatre; Tchaikovsky: The Sleeping Beauty—Blue Bird Pas de deux; Tchaikovsky: The Nutcracker—Act 2—Pas de deux.

RICHARD BONYNGE
 conducting
THE LONDON SYMPHONY ORCHESTRA

Stereo CSA 2213
 Mono CMA 7213



Photo: Fred Fehl

New!

Complete with 2 Dynamic Mikes, Output Cable, Tape Reel and 1200 Feet of Tape



LAFAYETTE PROFESSIONAL QUALITY 4-TRACK STEREO TAPE RECORDER RECORDS SOUND-ON-SOUND

Here is professional quality at Lafayette's low price. Compare this dependable portable tape machine with others and you will agree, the RK-155 is tops.

- Playback 4 and 2-track stereo; 4-track monaural • Record 4-track stereo and monaural • Dual level meters • Built-in amplifiers and 2 full-tone stereo speakers for hi-fi sound
- Response: 40-18,000 cps at 7½ ips • 2 Speeds: 3¾ ips & 7½ ips • Plays reels up to 7 inches

RK-155WX With Carrying Case Net 169.95

A complete recording studio in one case

169⁹⁵
 NO MONEY DOWN

LAFAYETTE Radio ELECTRONICS
 Dept. HMF-3 P.O. Box 10,
 Syosset, L.I., N.Y.

Rush me FREE 388
 Giant Sized Pages
 1963 Catalog.

FREE!

RK-155WX \$ enclosed

NAME

ADDRESS

CITY ZONE STATE

LAFAYETTE Radio ELECTRONICS
 Syosset, L.I., N.Y.
 OTHER LOCATIONS
 Jamaica 33, N.Y. Scarsdale, N.Y.
 New York 13, N.Y. Paramus, N.J.
 Plainfield, N.J. Newark 2, N.J.
 Bronx 58, N.Y. Boston 10, Mass.
 Natick, Mass.

TWIN-PAKS: TWO FOR THE MONEY

Twin-Paks are 4-track stereo tapes, each containing the equivalent of two or more albums. That means up to 1 hour and 30 minutes of music on one reel of tape. And Twin-Paks are economical: double-album length Twin-Paks are priced from \$7.95 to \$12.95. Want some examples? Here are six best-selling stereo Twin-Pak tapes:



1. **BEETHOVEN PIANO CONCERTOS NO. 3 & 4.**
Wilhelm Backhaus, Vienna Philharmonic.
London K 80007—\$11.95
2. **THE ART OF THE PRIMA DONNA.**
Joan Sutherland. London H 90035—\$12.95
3. **HONEGGER: KING DAVID (Complete)
& MILHAUD: THE CREATION.**
Vanguard 1651—\$11.95
4. **MUSIC FROM CAMELOT & MUSIC FROM
CARNIVAL.** Orndel and The Starlight Symphony.
MGM 4500—\$11.95
5. **ELLA FITZGERALD SINGS THE HAROLD
ARLEN SONG BOOK.** Verve 254—\$11.95
6. **MOODS TWO.** 26 Selections, 15 artists.
UST 408—\$7.95

STEREO SOUNDS BEST ON TAPE

If you would like to receive regular new-release information write: United Stereo Tapes, 88 Llewellyn Avenue, Bloomfield, New Jersey

CIRCLE NO. 46 ON READER SERVICE CARD

Saëns, which might better have been left to a reel by itself. Ansermet's performance is expansive and emotional, particularly the first two movements, which are delivered with a solemnity verging on the religious. Here he surpasses any other recorded version. For sheer might in the finale, this recording also compares favorably with the excellent one by Munch (RCA Victor FTC 2029), which is, however, more vivid in sound. Where Ansermet excels is in the sure, over-all balance of strings against brasses, which are never too prominent or too bright. The organ, for all its left, does not puncture this sturdy tonal fabric, but robustly complements it.

Flawless string work and warm, almost lush sound distinguish Ansermet's readings of the suites occupying the second sequence. The love music Fauré composed to accompany Maeterlinck's *Pelléas et Mélisande* is simplicity itself, rendered here with tenderness and exquisite delicacy. The same holds for the livelier *Masques et Bergamasques*, a suite reminiscent of early French dance music, and the genial *Petite Suite* of Debussy. There is more music on this tape than many listeners will care to play out in a single sitting, but in combining two excellent discs and permitting an uninterrupted performance of the symphony, it has considerable virtues. *C. B.*

© **TCHAIKOVSKY: Symphony No. 6, in B Minor, Op. 74 ("Pathétique").** Philharmonia Orchestra, Otto Klemperer cond. ANGEL ZS 35787 \$7.98.

Interest: Klemperer's Tchaikovsky
Performance: Lucid
Recording: Excellent
Stereo Quality: Spacious

Otto Klemperer's first Tchaikovsky recording will not appeal to those who have fixed ideas about the composer's music, and even less to those who like their Tchaikovsky decked out with gushy sentimentality, weepy histrionics, and lofty breast-beating. For there are none of these things in this sober, straightforward account. Throughout, Klemperer takes pains to stress structural values and clarity of line—an approach that works particularly well in the outer movements. There is, in addition, a good deal of warmth and nobility in these pages, notably in the conductor's projection of the gathering momentum and pathos of the finale. The second and third movements, by contrast, seem a little too inflexible, and the march in the third more Teutonic in spirit than serves the music. All in all, the Ormandy recording (Columbia MQ 368) remains my favorite on tape, but Klemperer's runs a very close second. The recorded sound is a model of transparency, and the stereo engineering is absolutely first-rate. *C. B.*

ENTERTAINMENT

RECORDING OF SPECIAL MERIT

© **DUKE ELLINGTON: *Midnight in Paris.*** Duke Ellington (piano); his orchestra. *Under Paris Skies; I Wish You Love; Mademoiselle de Paris; Comme Çi. Comme Ça;* and nine others. COLUMBIA CQ 503 \$7.95.

Interest: Parfums de Paris
Performance: Robust
Recording: Fine
Stereo Quality: Ditto

The best thing about Duke Ellington's tribute to the City of Light, prompted by his visit during the filming of *Paris Blues*, is his musical suggestion that the town has some pretty dark corners as well. At least that is what he conveys in numbers such as *Under Paris Skies*, *Speak to Me of Love*, and *The River Seine* with their momentary flashes of wry polytonality, and in the rhythmically



JUDY GARLAND
A swinging sentimental set

out-of-sorts *Petite Waltz*. His moods elsewhere are varied, his arrangements invigorating and spicy, the performances by all hands incisive. Columbia's sound is excellent. *C. B.*

© **GAY PURR-EE (Harold Arlen-E. Y. Harburg.** Sound-track recording. Judy Garland, Robert Goulet, Paul Frees, Red Buttons; orchestra, Mort Lindsey cond. WARNER BROS. WSTC 1479 \$7.95.

Interest: Intriguing score
Performance: Slick
Recording: Good
Stereo Quality: Same

Gay Purr-ee? It's about this cat. Mew-sette is her name, but that is not important. Nor is it especially important that the tape derives from the sound-track of a UPA animated cartoon, for the musical contents are sufficient unto

RECORDING OF SPECIAL MERIT

© RIMSKY-KORSAKOV: *Scheherazade—Symphonic Suite, Op. 35*. Royal Philharmonic Orchestra, Sir Thomas Beecham cond. ANGEL ZS 35505 \$7.95.

Interest: Prime Russian fairy tale
 Performance: Imaginative and poetic
 Recording: Good to excellent
 Stereo Quality: OK

This, the eighth version of *Scheherazade* on tape, is actually the oldest, having been done by Beecham and the Royal Philharmonic back in 1957, when two-track stereo tapes were just beginning to appear and the stereo disc was still in the labs. Yet the sound is as good as any to come from its more recent competition, and the performance tops all others by virtue of the imaginative poetry that Beecham and the first-chair soloists coax from this abused work. As is so often the case with Beecham's approach to thrice-familiar scores, we experience the music as though we had never heard it before. Yet Rimsky-Korsakov's tempos and dynamics are treated with all due respect. Conceived by Beecham and Angel primarily as poetic fantasy and only then as a virtuoso vehicle for orchestra — or engineers — this *Scheherazade* is a fresh artistic experience for the listener, regardless of the number of times he may have heard it in the past.

Congratulations are also due Angel for its brilliantly successful tape transfer of this truly classic reading. *D. H.*

RECORDING OF SPECIAL MERIT

© SAINT-SAËNS: *Symphony No. 3, in C Minor, Op. 78 ("Organ")*. FAURÉ: *Pénélope: Prelude; Pelléas et Mélisande, Op. 80; Masques et Bergamasques, Op. 112*. DEBUSSY: *Petite Suite (orch. Büsser)*. Suisse Romande Orchestra, Ernest Ansermet cond. LONDON LCK \$11.95.

Interest: *Musique française*
 Performance: Persuasive
 Recording: Very good
 Stereo Quality: OK

The contents of this twin-pack reel span a little over thirty years of French music by three roughly contemporary composers. The earliest work is the Saint-Saëns symphony, first performed in 1886, and the latest is Fauré's *Masques et Bergamasques*, composed in 1919. None of them cut a very wide swath in the history of Western music, nor are any among the popular favorites of the concert hall. Yet each has its merit, even the rather dated fustian of the *Pénélope* Prelude.

Certainly the listener's interest will center on the Third Symphony of Saint-

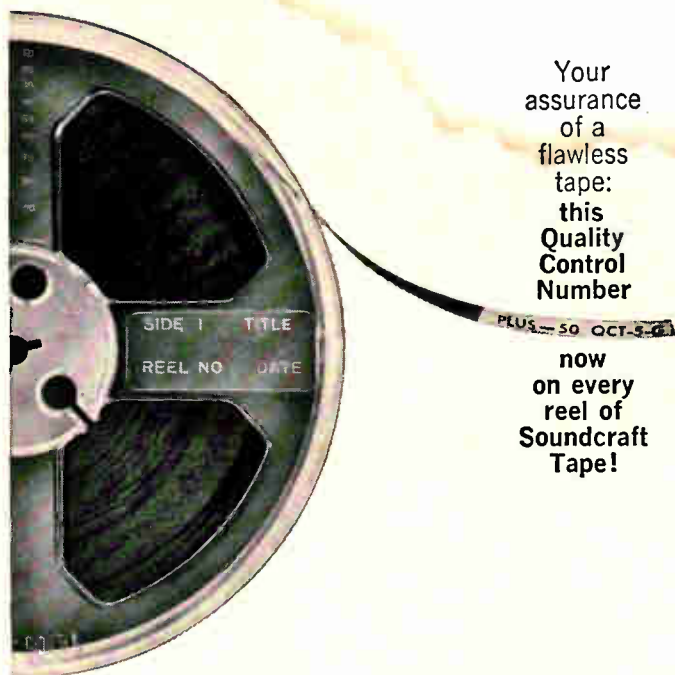

Your assurance of a flawless tape: this Quality Control Number

now on every reel of Soundcraft Tape!

Tape used with modern recorders must be flawless — from one end of the reel to the other. Even the subtlest defects (microscopic edge burrs, skew, cupping or curling) will prevent intimate contact between the tape's narrow tracks and the recording head. The result: unsatisfactory performance. Soundcraft Recording Tape is flawlessly made. Your guarantee that it has met the most painstaking magnetic and physical standards is the quality control number marked on every reel. It is your complete assurance of superior tape re-

cordings. Note to our engineering-minded friends: Mail us the tab showing the quality control number of your reel of Soundcraft Tape. We'll send you its rigid specifications. Write for free Soundcraft Literature.



REEVES SOUNDRAFT CORP.

Main Office: Great Pasture Road, Danbury, Connecticut • New York: 10 E. 52nd Street • Chicago: 28 E. Jackson Blvd. • Los Angeles: 342 N. LaBrea • Canadian Reps.: Toronto, Vancouver

CIRCLE NO. 37 ON READER SERVICE CARD

NEW!

BIG SOUND

in a compact
Tape Recorder

Stereophonic
'1055'

The *all new* Roberts '1055' is a self-contained 4-track stereophonic tape recorder... *the* tape recorder for everyone. Its pure, high fidelity recording qualities are applauded by the professional — and its simplicity of operation makes it the ideal instrument for the amateur. Never before has there been a tape recorder like the Roberts '1055'. It's compact, lightweight, portable, as easy to operate as turning on your radio! You can use it as a complete unit or as an integral part of your hi-fi system. As remarkable as the design and performance of the ROBERTS '1055' is the astonishingly low price — **\$269.95** — a value unmatched by any other tape recorder.

THE ROBERTS '1055' IS AS VERSATILE AS SOUND! ★ 4-track stereo and 4 individual quarter tracks ★ Famous Roberts transport ★ Perfect size for custom installation ★ Horizontal or vertical operation ★ 3¾, 7½ ips ★ FM Multiplex ready.

ROBERTS

ELECTRONICS, INC.

LOS ANGELES 16, CALIF.

CANADA: J. M. NELSON ELECTRONICS LTD.
 7725 ADERA ST., VANCOUVER 14, B.C.

Prices slightly higher in Canada

Roberts Electronics, Dept. HFSR-6
 5978 Bowcroft, Los Angeles 16, Calif.
 Please send me new booklet "40 And More Ways To Use A Roberts Tape Recorder."

Name _____
 Address _____
 City _____ Zone _____ State _____

CIRCLE NO. 58 ON READER SERVICE CARD

FM LISTENERS!

NOW—PERFECT RECEPTION FOR YOU

with a money-back guarantee

Only \$29.95!



The world's smallest complete indoor FM Antenna system

Your expensive FM installation is only as good as its weakest link—the antenna. Some set owners use a wire, or their TV antenna. Others use an ugly roof-top installation with unsightly lead wires. And still they get noise, interference, poor reception. But now every FM listener can enjoy guaranteed better listening—from a superb new system that's only 6" x 3" x 1" over-all and sits handsomely indoors, near your FM set. This is the completely new, patented Gallo FM Antenna System.

You Get All These Improvements

- Highest quality signal, thanks to its own built-in, AC powered transistorized pre-amplifier.
- Omni-directional. All stations received with equal fidelity.
- Smallest FM Antenna System in the world, and beautifully styled. Available in decorator colors—Faun marble, black with gold trim.
- Rejects noise and interference automatically. The Gallo FM Antenna System is a tuned device that automatically rejects interference.
- Low in Cost. The complete FM Antenna System with built-in transistorized pre-amplifier costs you less than a standard outdoor antenna without amplifier.

Unconditional Money-Back Guarantee

You don't risk one cent because Gallo unconditionally guarantees full satisfaction. If this device does not perform as stipulated, return with sales check for full refund.

If no dealer is available in your area order direct from Gallo.

GALLO ELECTRONICS CORPORATION

New Rochelle, New York • Westbury, Long Island

GALLO ELECTRONICS CORP.
12 Potter Ave., New Rochelle, N. Y.
Please send me postpaid complete Gallo FM Antenna Systems. I enclose \$29.95 for each antenna ordered. I understand the system carries an unconditional money-back guarantee.
Black Faun marble

Name _____
Address _____
City _____ Zone _____ State _____

HFS-93

the trio of one-act operas making up Puccini's *Il Trittico*, these three reels represent a major addition to the catalog, and one that is unlikely to be duplicated, in whole or in part, for a good time to come. It is rare that this triple-header is presented in its entirety in the opera house, for each of the operas requires some fifty minutes of playing time and collectively can make severe demands on a company's vocal resources. A recording company such as London, however, has resources in abundance, notably a roster of artists that permits the casting of a single leading lady and a bundle of operadom's top singers in other starring roles to add to the services of one conductor and one producing team. In the four-track medium, at least at this point in its history, it is unimportant that one or another of these operas is elsewhere better served, which is surely the case. The performances here are excellent, and the technical work is of an extremely high order throughout.

Actually, no one of the three recordings so outdistances the others vocally that it warrants special mention. The one unforgettable performance is Giulietta Simionato's aristocratic Zia Principessa in *Suor Angelica*. Renata Tebaldi is also at her best in this opera, bringing strong dramatic conviction to her scene with Miss Simionato and infusing the eloquently moving aria "*Senza mamma, o bimbo*" with luminous tone and heart-rending pathos. (The uncertain pitch of the horn signaling the nuns' chorus that follows the aria makes one suspect that Miss Tebaldi sings the latter transposed a half-tone down. But who cares?) It is evident at some points that Miss Tebaldi was having trouble with her high C's when this recording was made, yet nowhere is there the suggestion that she was anything but secure vocally. While her *Angelica* is radiant and utterly compelling in its directness, her *Giorgetta* in *Il Tabarro* is marked by vitality, and her brief appearances as *Lauretta* in *Gianni Schicchi* serve the piece well. Lucia Danieli is outstanding in supporting roles in all three operas.

The men involved are less consistently successful. Mario del Monaco's Luigi in *Il Tabarro* is almost hysterically passionate: his tenor rings with ardor but also tends to bray. Robert Merrill is superb as *Tabarro's* Michele, especially in the intense longing he imparts to the crucial "*Nulla! . . . Silenzio*" aria that motivates the grim murder he must perform at the end. Fernando Corena's *Gianni Schicchi* is all that it need be and nothing more, certainly not the sardonic portrayal that Gobbi made it, but an amiable, altogether convincing clown just the same.

Lamberto Gardelli's direction is at all

times spirited, and is marred only by occasional lapses in continuity that may in reality be the result of faulty editing. The recorded sound is dynamically vivid, and the stereo engineering, which attempts to create the illusion of an actual performance, stage noises and all, is without blemish. *Tabarro's* setting, the Seine by night, is beautifully conveyed (with no little help from Puccini), and the crossovers in *Suor Angelica*, when the agitated Angelica questions her aunt on the fate of her son, and in *Gianni Schicchi*, when the title character is mulling over the will of the deceased Donati, are instances of highly successful stereo theater. C. B.

RECORDING OF SPECIAL MERIT

© PURCELL: *Come Ye Sons of Art; Rejoice in the Lord Always* ("Bell Anthem"); *My Beloved Spake* (anthem). Alfred Deller, Mark Deller (countertenors), Deller Consort soloists; Oriana Concert Choir and Orchestra, Kalmar Orchestra of London, Alfred Deller cond. VANGUARD VTC 1657 \$7.95.

Interest: Prize Purcell package

Performance: Superlative

Recording: A-1

Stereo Quality: Fine

Henry Purcell's 1694 Birthday Ode for Queen Anne, *Come Ye Sons of Art*, has long been a best-seller (for this type of music) in the Oiseau-Lyre mono disc that featured countertenors Alfred Deller and John Whitworth in the famous *Sound the Trumpet* duet. As in the former recording, the singing of the duet here, by Deller and his equally gifted son Mark, is by itself worth the price of the whole package, wonderful as is everything else that comes with it. The effective and wholly tasteful way in which the stereo dialogue is handled makes for really spine-tingling listening. Owners of the earlier recording will note the far more elaborate and imaginative harpsichord continuo in this version, and will take pleasure in the splendid spaciousness of both the festive and reflective choral episodes.

The so-called "Bell Anthem" is one of Purcell's most celebrated ecclesiastical masterpieces, with an especially beautiful slow middle section. But for me, the Song of Solomon setting, *My Beloved Spake*, is more imaginative and appealing. Indeed, were it not for the Biblical source of the text, one might mistake the music for a bucolic episode from *King Arthur* or *The Fairy Queen*.

The musicianship of soloists, chorus, and orchestral ensembles is beyond criticism, impeccable in execution, and richly communicative in impact. Another must for tape classics fanciers.

D. H.

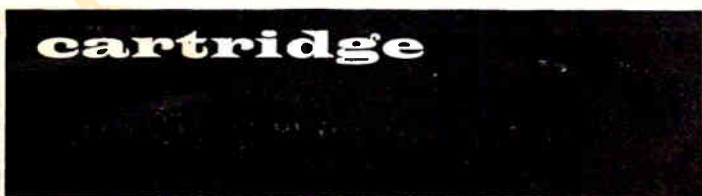
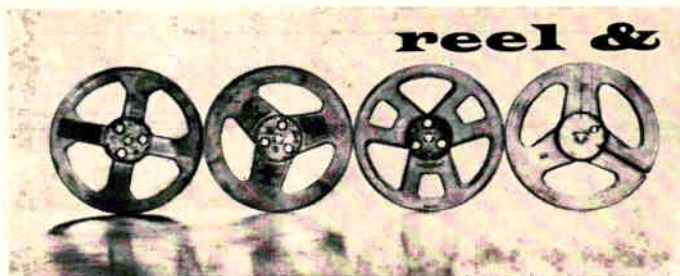

Reviewed by **CHRISTIE BARTER** • **DAVID HALL**

Explanation of symbols:

Ⓢ = monophonic recording

Ⓣ = stereophonic recording

RECORDING OF SPECIAL MERIT

Ⓣ **ADAM:** *Giselle*. Vienna Philharmonic, Herbert von Karajan cond. LONDON LCL 80107 \$7.95.

Interest: Ballet classic
Performance: Elegant
Recording: Satisfying
Stereo Quality: Good

Giselle here receives a gala premiere on tape. Karajan's performance is wholly evocative of the work's romantic charm and delicate pastel coloring—a performance geared to the supple rhythms of the dance. Since nearly an hour of it is offered on this reel, the price is quite reasonable. The sound is rich, though not overly bright, and the transfer to tape is exemplary. *C. B.*

RECORDING OF SPECIAL MERIT

Ⓣ **BEETHOVEN:** *Missa Solemnis, Op. 123*. Eileen Farrell (soprano), Carol Smith (contralto), Richard Lewis (tenor), Kim Borg (bass); Westminster Choir; New York Philharmonic, Leonard Bernstein cond. COLUMBIA M2Q 509 \$11.95.

Interest: Heaven-storming Beethoven
Performance: Bernstein's best
Recording: Tops
Stereo Quality: Stunning

Leonard Bernstein's white-hot reading of this masterpiece ranks as his finest recorded achievement to date. From beginning to end, chorus, soloists, and orchestra perform as if transported, with the result that the raw, elemental passion for God of the half-mad Beethoven who wrote this music is communicated with frightening immediacy. There is not a moment's letup in the blazing intensity of the Gloria. Yet the Benedictus, with its celebrated solo violin obbligato, is set forth with the utmost tenderness. Almost unbearable is the cry of anguish in the military episode of the Agnus Dei, in which Carol Smith and Richard Lewis do themselves particularly proud. In short, this is a recorded performance of

the Beethoven *Missa Solemnis* not likely to be surpassed for many years. On discs, the recorded sound was notable for its solidity of impact and sense of depth and spread, and on this twin-pack tape the sound comes through to even better effect, since there is no inner-groove tracking distortion to contend with. In addition, there is only one interruption for turnover, as against three on the four-sided disc set. Recommended without reservation. *D. H.*

Ⓣ **HANDEL:** *Messiah*. Eileen Farrell (soprano), Martha Lipton (contralto), Davis Cunningham (tenor), William Warfield (baritone); Mormon Taber-



LONDON RECORDS

HERBERT VON KARAJAN
Evokes Giselle's delicate charm

nacle Choir; Philadelphia Orchestra, Eugene Ormandy cond. COLUMBIA M2Q 510 \$11.95.

Interest: Oratorio favorite
Performance: Spirited
Recording: Needs top cut
Stereo Quality: Good

Tape collectors who are also connoisseurs of authentic Baroque styling will pass up this twin-pack in favor of the complete and authentic *Messiah* performances on London or Westminster tapes. But this spirited and rhythmically propulsive reading by Eugene Ormandy's Philadelphians and the Mormon Taber-

nacle Choir will appeal to those who want their *Messiah* done in the best oratorio-society tradition, and do not mind the conventional cuts.

The Mormon Tabernacle Choir does a superb job with the massed choruses in Parts Two and Three, bringing the music to a really thrilling close with the final "Worthy is the Lamb" and fugal "Amen" choruses. They display commendable agility in "All we like sheep" and "He is the King of glory." As for the soloists, William Warfield's handling of the famous "Why do the nations rage" is the most dramatically convincing I know, and Eileen Farrell is in resplendently pure and rich vocal estate in her singing of "I know that my Redeemer liveth."

Though the disc recording of this performance was clean and crisp, something seems to have gone awry with the tape transfer, for my review copy suffered from excessive high-frequency boost—to the point of serious distortion. Either my tape was defective, or Columbia should remaster this recording to the same playback characteristic as its magnificent *Missa Solemnis*, reviewed above. *D. H.*

Ⓣ **PUCCHINI:** *Il Tabarro*. Robert Merrill (baritone), Michele; Renata Tebaldi (soprano), Giorgetta; Mario del Monaco (tenor), Luigi; Lucia Danieli (mezzo-soprano), La Frugola. Chorus and Orchestra of the Maggio Musicale Fiorentino, Lamberto Gardelli cond. LONDON LOL 90052 \$7.95.

Ⓣ **PUCCHINI:** *Suor Angelica*. Renata Tebaldi (soprano), Suor Angelica; Giulietta Simionato (mezzo-soprano), Zia Principessa; Lucia Danieli (mezzo-soprano), Mother Superior. Chorus and Orchestra of the Maggio Musicale Fiorentino, Lamberto Gardelli cond. LONDON LOL 90053 \$7.95.

Ⓣ **PUCCHINI:** *Gianni Schicchi*. Fernando Corena (bass), Gianni Schicchi; Renata Tebaldi (soprano), Lauretta; Agostino Lazzari (tenor), Rinuccio; Lucia Danieli (mezzo-soprano), Zita. Chorus and Orchestra of the Maggio Musicale Fiorentino, Lamberto Gardelli cond. LONDON LOL 90054 \$7.95.

Interest: *Trittico* complete
Performance: Commendable
Recording: Superb
Stereo Quality: Suitable

This is quite a set. Introducing to tape

Here's what they're saying about Sarkes Tarzian's free new booklet, "Lower the Cost of Fun with Tape Recording..."

"The vigor of this presentation proves that Tarzian is interested in getting this country (and tape recording) moving again...everyone should walk to their nearest tape store and request a copy...or walk to Bloomington"
...*(name withheld on request)*

"The chapter dealing with recording of short wave broadcasts blatantly lays bare more capitalistic tricks for spying on peaceful communications of our people's democracies"
...*Havana Times*

"Contains a modest but penetrating analysis of why Tarzian Tape is perhaps the least-known superior product in the United States today"
...*Committee for Truth in Tape Promotion*

"A four-star ringer-dinger...understand three studios have been beating down the Tarzian doors seeking movie rights"
...*Hedda Winchell*

"The chapter entitled 'Use Tape in Your Business' is a bold statement of Tarzian confidence in traditional American enterprise"
...*Hall Street Journal*

"I agree"...*Harry Goldwater*

"'Invite Tape to Your Party' is the chapter that puts the bright light of public inspection on those 'friendly get-togethers' in suburbia"
...*Chipman Report*

"Timely"... "May open a new era in tape recording"... "A perfect mixture of good ideas, good taste, good humor"... these are just a few of the accolades we've made up to tempt you to get your free copy of our new 32-page booklet. As long as you know which side of a tape recorder holds the tape reel, you'll find something interesting, helpful, stimulating in "Lower the Cost of Fun with Tape Recording." **AND DON'T FORGET TO BUY A REEL OF TARZIAN TAPE.**



We don't know where you can find better... for consistent professional quality, at a price that is practical for every recording requirement. See your favorite tape, high fidelity, or photo equipment dealer—or write directly.



SARKES TARZIAN, Inc.

World's Leading Manufacturers of TV and FM Tuners • Closed Circuit TV Systems • Broadcast Equipment • Air Trimmers • FM Radios • Magnetic Recording Tape • Semiconductor Devices

MAGNETIC TAPE DIVISION • BLOOMINGTON, INDIANA

Export: Ad Auriema, Inc., N.Y. • Canada: E. J. Piggott Enterprises Ltd., Toronto, Ont.

See the **ROCKFORD**
Newest in **Acoustical Cabinetry**



Distinctive designer-styling

- Developed by acoustical engineers.
- Made by journeyman cabinetmakers.
- Each unit is free-standing.
- Acoustically engineered and furniture-crafted of selected woods.
- Speaker enclosures lined with 1" acoustical fiberglass. Internally baffled and ported. No cabinetry feedback or resonance.

FREE illustrated brochure describing equipment cabinets, speaker enclosures in a wide variety of styles and finishes. Write to



FURNITURE-CRAFTED BY

ROCKFORD
SPECIAL FURNITURE CO.

2024 TWENTY-THIRD AVE • ROCKFORD, ILL.

Dealer Inquiries Invited

CIRCLE NO. 39 ON READER SERVICE CARD

NO
STRINGS
NO
"GIMMICKS"



A \$329.00 **SHERWOOD**

(Fair Traded)

Free 8,000MHz FMX RECEIVER with case
... Nothing to buy

Just write to Rabsons for a quotation on any HI FI Component. This alone makes you eligible. Drawing will be made Sept. 30, 1963

YOU ALWAYS GET MORE FROM RABSONS

- Established 1905 - 58 Years of Reliability
- Franchised Protection - Plus
- Rabsons Special Six Month Guarantee
- Easy Payment Plan - Up to 24 Months to Pay
- Each Component Double Packed to Insure Safe Arrival ... At no extra charge
- Rabsons Sells ONLY Factory Fresh Merchandise in Original Factory Sealed Cartons

Free MIRACLE RECORD CLEANING CLOTH
with our quote. So whatever your
HI FI NEEDS Write Rabsons for our

"ROCK BOTTOM" PRICES

RABSONS -57 ST. INC.

119 West 57th St., New York 19, N.Y.

Area Code 212 Circle 7-0070

Diagonally opposite Carnegie Hall

This drawing is not open to residents in any locality whose laws prohibit such a drawing.

CIRCLE NO. 36 ON READER SERVICE CARD

JUNE 1963

Misbehavin'; I Gotta Right to Sing the Blues; and forty-two others. EPIC SN 6044 three 12-inch discs \$11.98.

Interest: Teagarden harvest
Performance: Teagarden towers
Recording: Adequate

Few jazzmen of any age or style have matched Jack Teagarden's record of consistency over a thirty-five-year recording career. As this collection of forty-eight recordings from 1928 to 1940 demonstrates, Teagarden's solos have nearly always been concisely organized and unmistakably personal. His style has not changed markedly through the decades. In the earliest of these performances, Teagarden's rhythmic ease and flowing phrasing stand out amid the collective stiffness of the combos with which he recorded. As the years went on, there was a gradual mellowing of his tone and his solos became more varied in their structure. But essentially, Teagarden was one of the few major jazzmen who was almost full-grown stylistically by the time he began to record.

Unfortunately, as in the case of Bix Beiderbecke, Teagarden seldom played with musicians of his caliber in recording studios. There were exceptions, more of them since 1940, and most notably during Teagarden's association with Louis Armstrong. Here and there, in the period covered in this set, there are soloists who come close to Teagarden's masterful melodic imagination, but most of the combos in which he functioned as a sideman now sound dated. His own bands, which are also represented here, were never outstanding—the ability to shape and discipline an orchestra has never been one of Teagarden's strong points.

But this collection has more than enough substance to warrant its inclusion in the valuable series of Columbia-Epic reissues. In addition to Teagarden's solos, there are his durably appealing vocals. Teagarden has long been one of the very best of jazz singers. His vocal phrasing is an extension of his instrumental approach and is just as warmly relaxed. His singing style transcends changing jazz fashions, particularly on the blues and ballads.

These recordings also re-emphasize the clarity and individuality of the almost forgotten trumpeter Sterling Bose, as well as the improvisatory strength of Teagarden's trumpet-playing brother Charlie. Among other assets are solos by the young Benny Goodman, then more earthy and tart, and two surprise appearances by Fats Waller.

The sound of these reissues is often disappointing, especially since the 78-rpm originals were, for the most part, well recorded, with more presence than the transfers. All things considered, however, this is one of the important jazz releases of the year.

N. H.

new...
from
COMMAND

MY MUSICAL COLORING BOOK

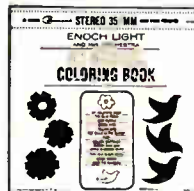

Enoch Light and His Orchestra — Cherry Pink and Apple Blossom White, My Coloring Book, Golden Earrings, The Blue Room, That Old Black Magic, Ruby, Green Eyes, Mood Indigo, Deep Purple, Yellow Bird, Over the Rainbow, Red Sails in the Sunset.
Album No. 848

LET'S DANCE THE BOSSA NOVA



Enoch Light and His Orchestra — Meditation (Meditacao), Big Band Bossa, Fly Me To The Moon, Tonight, Days of Wine and Roses, Noia, Mi Amor, I Could Have Danced All Night, What Kind of Fool Am I, O'Barquinho, Moon River, Blame It on The Bossa Nova.
Album No. 851

PARADISE ISLANDS

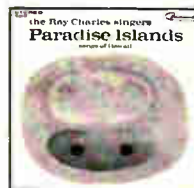

The Ray Charles Singers — Sweet Leilani, Blue Hawaii, Forevermore, Songs Of The Islands, My Little Grass Shack, Hawaiian War Chant, Lovely Hula Hands, Hawaiian Wedding Song, Aloha Oe, Get a Musical Log, Beyond the Reef, The Coconut Wireless.
Album No. 845

ROMANTIC GUITAR



Tony Mottola and His Orchestra — Tenderly, If Ever I Would Leave You, Mitzli, Always and Always, Alone Together, Speak Low, I Got It Bad, Fly Me to the Moon, Misty, Let's Fall in Love, You are Too Beautiful, It's a Lonely Some Old Town.
Album No. 847

BIG NOISE FROM WINNETKA



Bob Haggart and His Orchestra — What's New, Love For Sale, One for My Baby, Strike Up the Band, My Inspiration, When the Saints Come Marching In, Dixieland Shuffle, The Whistler and His Doghouse, I'm Praying Humble, Walking to Winnetka, South Rampart Street Parade, Big Noise From Winnetka.
Album No. 849

Write for our free full-color brochure of Command Releases

World Leader
in Recorded Sound
Command
Records

1501 Broadway, New York, New York

CIRCLE NO. 53 ON READER SERVICE CARD

you
can play
your records



manually



or automatically

and enjoy the same quality you associate with turntables that can only be played manually.

The Benjamin-Miracord is fundamentally a quality instrument—designed and constructed to highest quality standards. Its components are those characteristic of the finest record players: solid, die-cast, dynamically balanced, 12-inch turntable; precision-machined, mass-balanced transcription arm; and choice of either high-torque, 4-pole induction motor or the famous Papst hysteresis motor.

Yet, the Miracord can play single records automatically as well as manually, or you can play up to 10 records in automatic sequence. The automatic action of the arm is actually more precise and more gentle than by hand. See and hear the Benjamin-Miracord perform at your hi-fi dealer. Model 10 with 4-pole induction motor, \$89.50; Model 10H with Papst hysteresis motor, \$99.50 (complete with arm but less cartridge and base). For catalog, write to:

BENJAMIN ELECTRONIC SOUND CORP.
80 Swalm Street, Westbury, L.I., New York
Sole U.S. Distributor of Electroacoustic® Record Playing Components



**BENJAMIN
MIRACORD**

CIRCLE NO. 52 ON READER SERVICE CARD

foursquare, revealing everything at first hearing. The album contains much more Hirt trumpet playing than will interest most listeners, and all has been recorded as well as it could be. *J. G.*

⑤ ⑥ **LAMBERT, HENDRICKS, AND BAVAN:** *Recorded "Live" at Basin Street East.* Dave Lambert, Jon Hendricks, Yolande Bavan (vocals); Pony Poindexter (alto saxophone); The Gildo Mahones Trio. *Shiny Stockings; Cousin Mary; One Note Samba; Dis Hyunh;* and seven others. RCA VICTOR LSP 2635 \$4.98, LPM 2635* \$3.98.

Interest: Vocal ingenuity
Performance: Brisk and idiomatic
Recording: Very good
Stereo Quality: First-rate

This album, recorded at Basin Street East in New York, is the first by the Jon Hendricks-Dave Lambert team without Annie Ross. Miss Ross's replacement is Ceylonese actress Yolande Bavan. While Miss Bavan does not possess Annie Ross's range, drive, and beat, she blends into these tricky arrangements with considerable skill, demonstrating a spontaneous bent for the swift mockery that is a pervasive element in the trio's work.

As in previous recordings by Lambert and Hendricks, the majority of the material consists of vocalized settings of jazz instrumentals, with lyrics by Hendricks in jazz and Negro argot. Musically, the approach is essentially imitative rather than creatively original, but Lambert, Hendricks, and Bavan are nonetheless uniquely entertaining. *N. H.*

⑤ ⑥ **MIKE MAINIERI QUARTET:** *Blues on the Other Side.* Mike Mainieri (vibraphone), Bruce Martin (piano), Julie Ruggiero (bass), Joseph Porcaro Jr. (drums). *If I Were a Bell; B.R. Blues; Waltzin' In and Out;* and three others. Argo S 706* \$4.98, LP 706 \$4.98.

Interest: Signs of growth
Performance: Fluent
Recording: Adequate

Mike Mainieri, now twenty-four, first attracted attention a couple of years ago when he was with Buddy Rich. His technique was remarkably swift and sure, but his music was noteworthy for little except mechanical ingenuity. This, Mainieri's first album as a leader, indicates a marked evolution in emotional expressiveness. There is much less flashiness, and a greater attempt to communicate personal feelings in original pieces and in imaginative reshaping of standards, as in the refreshingly unexpected approach to *Tenderly*.

Mainieri's playing still lacks depth, and he occasionally has trouble deciding

how best to conclude a piece, but he does prove here that he is no longer just a sprinter. *N. H.*

⑤ ⑥ **JIMMY SMITH:** *Back at the Chicken Shack.* Jimmy Smith (organ), Stanley Turrentine (tenor saxophone), Kenny Burrell (guitar), Donald Bailey (drums). *Back at the Chicken Shack; When I Grow Too Old to Dream; Minor Chant; Messy Bessie.* BLUE NOTE ST 84117 \$5.98, 4117* \$4.98.

Interest: Tenor-organ group
Performance: Interminable
Recording: Good
Stereo Quality: OK

Organist Jimmy Smith is generally considered the finest jazz organist today—except for Basie and Ray Charles, who play the instrument only occasionally—and is certainly the most popular. He has nearly singlehandedly brought about the organ's present jazz pre-eminence. He works in the now widespread quartet format only occasionally, though, and this release may indicate why. His associates are all good men: Kenny Burrell is one of the better jazz guitarists, Stanley Turrentine is a fine and original tenor player, and Donald Bailey is an unobtrusively helpful drummer. But except for Turrentine's charming two-beat statement of the



JACK TEAGARDEN
Masterful melodic imagination

theme on the rarely played *When I Grow Too Old to Dream*, the album is a dreary wasteland of pointless, overextended solos. There are only four tracks, and the players exhaust what little they have to say musically long before their allotted time is up. The impression is of one forty-minute rhythm-and-blues solo, and the disc is recommended only to those who would find such a solo interesting. *J. G.*

RECORDING OF SPECIAL MERIT

⑥ **JACK TEAGARDEN:** *King of the Blues Trombone.* Jack Teagarden (trombone), various artists and orchestras. *When You're Smiling; Diga Diga Do; Chances Are; China Boy; Ain't*

Long play never had it so long!



New! Triple the length on a 7" reel!

Longest non-stop tape time ever! That's what you get with a 7" reel of new SCOTCH® BRAND Recording Tape No. 290—any way you play it! At 3¾ ips, for example, it provides 3 hours of uninterrupted stereo or monaural—6 hours of recording in both directions.

This exclusive triple length tape offers 3600' lengths on 7" reels. That's three times the footage possible with standard length tape on a 7" reel. And compared with regular double length tape, you get 50% more recording time, pay less per foot.

What's 290's secret? A superior new coating technique, developed by 3M, makes possible thinner high potency oxide coatings to reduce tape thickness, allow bonus tape footage per reel. Backing for No. 290 is the same extra-strong, half-mil tensilized polyester used on regular "SCOTCH" Double Length

Tape. No. 290 is made to demanding stereo quality standards to ensure brilliant sound characteristics. And exclusive Silicone lubrication, which lasts the life of the tape, protects against recorder head wear, actually extends tape life.

Full hour on a miniature reel! No. 290 is also offered in 600' lengths on 3¾" reels that fit most miniature recorders, play a full hour at 3¾ ips, 2 track. Ask your dealer about both sizes of new No. 290.

"SCOTCH" AND THE PLAID DESIGN ARE REGISTERED TRADEMARKS OF MINNESOTA MINING & MANUFACTURING CO., ST. PAUL 19, MINNESOTA. EXPORT: 99 PARK AVENUE, NEW YORK. CANADA: LONDON, ONTARIO. ©1963, 3M CO.

Magnetic Products Division **3M** COMPANY



This system has more guts than any other system its size.

An 8" high compliance woofer. A 6" mid-range "impact" speaker. A 3½" super cone tweeter. And a high pass network filter crossing over at 5000 cps.

It'll handle 20 watts of power. Or fill an average room with only 5 watts of power. And it's only 4½" deep by 14" high x 18" wide. Measure it. Against anything in its class. Sonorette by Rek-O-Kut. Only \$49.95—complete with volume control.

An 8 page speaker systems brochure is available for the asking. Write: Rek-O-Kut, 38-19 108 Street, Corona 68, N.Y. Dept. HS-6

sonorette 

CIRCLE NO. 38 ON READER SERVICE CARD

(bass), Royce Rowan (drums). *Junction City Blues; Lonely One; Between the Toes; I'll Be Tired of You*; and seven others. ARGO LPS 4019 \$4.98, LP 4019 \$3.98.

Interest: Like Jamal
Performance: Slick
Recording: Satisfactory
Stereo Quality: Good

The apologetic, give-him-a-break notes accompanying King Fleming's second Argo disc imply that any piano player should be given a chance to record if he is a serious musician. The album does little to prove this thesis.

Fleming, working with a drummer, a very good bassist named Malachi Favors, and—on one track—a vibraphonist, plays the kind of watered-down cocktail jazz that Ahmad Jamal and Ramsey Lewis have made typical of Chicago. By occasionally going one step too far, Fleming demonstrates the thin margin that separates this style from Jan August's. His *Time Out* suggests *Poor Butterfly*; his *Song of Paradise* suggests *Yellow Bird*; his *Stand By Part 2* suggests Art Blakey's Afro-chants; his *Between the Toes* suggests Pete Johnson and Albert Ammons. "The main objective in this album," the notes say, "was to have something for everyone." Not surprisingly, with such an objective, the result is nothing for most. *J. G.*

© ① **HANK GARLAND: *The Unforgettable Guitar of Hank Garland.***

Hank Garland (guitar), Gary Burton (vibraphone), Bill Pursell (piano), Bobby Moore and Joe Benjamin (bass), Murray Harman, Jr., Douglas Kirkham, Joe Morello (drums). *Not for Me; You're Here Again; Call D. Law; Unless You're in Love*; and eight others. COLUMBIA CS 8713 \$4.98, CL 1913* \$3.98.

Interest: Pop jazz
Performance: Competent
Recording: Good
Stereo Quality: Adequate

Hank Garland is a guitarist from Nashville whose main business is playing for that city's countless country-and-western record dates. In private, however, he plays jazz, and this is his second disc in the vein.

The guitar-vibraphone-piano voicing of most of these tracks inevitably recalls the early days of George Shearing, and so, too, does the music. Using unfamiliar tunes and a few originals, Garland has created pop jazz here: competent, workmanlike, unexciting. Garland, pianist Bill Pursell, and vibraphonist Gary Burton are all good instrumentalists, but they have aimed for light, palatable entertainment. As such, the album is successful, but not much more than diverting. *J. G.*

© ① **JOHNNY GRIFFIN: *Grab This!*** Johnny Griffin (tenor saxophone), Paul Bryant (organ), Joe Pass (guitar), Jimmy Bond (bass), Doug Sides (drums). *Grab This!; Sixty-third Street Theme; Don't Get Around Much Any More; Offering Time; These Foolish Things; Cherry Float.* RIVERSIDE RS 9437 \$5.98, 437* \$4.98.

Interest: Superior organ-tenor combo
Performance: Restrained
Recording: Good
Stereo Quality: OK

Johnny Griffin's newest release treads the narrow line between jazz and the brand of popular music turned out in lounges by organ-tenor combos. Most of the time the music succeeds in being jazz, and is a superior example of the organ-tenor genre. A high degree of musicianship is involved, and most of the credit goes to saxophonist Griffin. Although he might be expected, in this context, to indulge in some of the meaningless pyrotechnics he is partial to, he is surprisingly restrained, and contributes some of the most direct blues work of his career. Organist Paul Bryant is more inventive than most players of his instrument, and the rhythm section is unobtrusive. The main disappointment is guitarist Joe Pass. Contrary to my expectations, he is not very original here, perhaps because the material is not challenging. But, on its own terms, this is a successful album. *J. G.*

© ① **AL HIRT: *Trumpet and Strings.***

Al Hirt (trumpet), orchestra, Marty Paich cond. *Stranger in Paradise; Poor Butterfly; True Love; Easy to Love*; and eight others. RCA VICTOR LSP 2584 \$4.98, LPM 2584* \$3.98.

Interest: Hirt in Stringsville
Performance: Monochromatic
Recording: Lush
Stereo Quality: Good

Al Hirt plays the trumpet almost as well as his publicity says he does. He has a full, brassy tone, and is capable of dazzling bravura runs. Apparently, these comprise his full arsenal of effects. Subtlety and shading are foreign to him, as is the intuition that one song might require an approach different from another.

In this RCA album, he is cushioned by a great pillow of strings while he essays such fine standards as *Fools Rush In, How Deep is the Ocean, and As Time Goes By*. No attempt has been made to produce jazz. As *Sleepy Lagoon* pointedly reveals, each song is given some variant of the old Harry James circus-trumpet approach.

Marty Paich's arrangements are non-committal, Hirt's trumpet is blunt and *(Continued on page 80)*

Big Nick and Ellington *The Feeling of Jazz*, one of those tunes that no one but Strayhorn could possibly have written.

My Little Brown Book resurrects the early Coltrane ballad style, and the Ellington blues, *Stevie*, brings out the best in both men. In too much of the rest, though, the closest they come to unity is a (probably inevitable) title, *Take the Coltrane*. Coltrane turns that tune into one of his ferocious tenor-bass-drums excursions, while Ellington, seemingly intimidated, stays out for much of the piece. Ellington is one of the great jazz pianists, but here he has chosen to play it safe, giving only the barest hint of what he can do. The pieces with Ellington's rhythm men turn out better, but on these tracks, Coltrane is unnaturally subdued.

So we have two giants, meeting with respect, deference, and undoubted affection, but neither giving what was necessary for this album to be the achievement it might have been. J. G.

© ® **HERB ELLIS:** *The Midnight Roll*. Herb Ellis (guitar), Roy Eldridge and Frank Assunto (trumpets), Buddy Tate (tenor saxophone); Ray Bryant (piano), Israel Crosby and Jimmy Rowser (bass), Gus Johnson (drums). *Broadway; Gravy Waltz; Old Folks; Roy Showed; Symphony*; and five others. EPIC BA 17034 \$4.98, LA 16034 \$3.98.

Interest: Quiet jam session
Performance: Casual
Recording: Good
Stereo Quality: Good

Under the nominal leadership of guitarist Herb Ellis, the group here assembled is made up of musicians who play in various styles: oldsters Roy Eldridge and Buddy Tate, trumpeter Frank Assunto from the Dukes of Dixieland, Ahmad Jamal's late bassist Israel Crosby, studio drummer Gus Johnson, modern bassist Jimmy Rowser, and all-purpose pianist Ray Bryant. Apparently the aim was something for everyone: there are standards, an Ellington tune, a Basie tune, a funky gospel number, and two country tunes.

The result is like an after-hours session the listener overhears accidentally: no startling music, no competition, no proving of points. The musicians play just as their reputations would lead you to expect, the only surprise being that Assunto fits rather nicely into what is, for him, fast company. The album is not particularly memorable, but rather like a casual friend whose company you would not go out of the way to seek, but who is pleasant and relaxing when you see him once in a while. J. G.

© ® **KING FLEMING:** *Stand By*. King Fleming (piano), Malachi Favors

DYNACO

for superlative sound

Superlative sound means the very best sound available, sound so realistic that skilled listeners can not distinguish the difference between "live" and "recorded" music in a side by side comparison. This comparison has been performed dozens of times before thousands of people in programs sponsored by Dynaco, Inc. and AR, Inc. with "live" portions performed by the Fine Arts Quartet. In these comparisons, the superlative sound capabilities of the Dynakit's were amply demonstrated since the vast majority of the audiences readily admitted that they could not tell the difference between the electronic reproduction using the Dyna Mark III amplifiers and PAS-2 preamplifier and the instrumental rendition by the members of the Fine Arts Quartet.

Such perfection of reproduction means that listeners at home, using home type components, can truly have concert hall realism — a level of fidelity of reproduction which cannot be improved regardless of how much more money were to be spent on the components used. This is truly reproduction for the audio perfectionist, and all Dyna components are of a quality level which permits reproduction indistinguishable from the original. This is achieved through exclusively engineered designs coupled with prime quality components. Further, the unique designs and physical configuration of all Dynakit's make them accurately reproducible, so that everybody can hear the full quality of which the inherent design is capable. Dynakit's are the easiest of all kits to build—and yet they provide the ultimate in realistic quality sound.



FM-1—An outstanding FM tuner with provision for internal insertion of the FMX-3 Stereomatic multiplex integrator. The FM-1 is a super-sensitive (better than 4 μ V), drift-free tuner with less than .5% distortion at all usable signal levels. Better than 30 db separation on stereo usage using the FMX-3, and automatic transition to stereo with the visual Stereocator. FM-1 kit \$79.95, wired \$119.95; FMX-3 kit \$29.95; FM-3A (Wired tuner with multiplex), \$169.95.



***SCA-35**—Integrated stereo amplifier and pre-amplifier with low noise, low distortion, and moderate power output, 17.5 watts per channel continuous (45 watt total music power) with less than 1% distortion over the entire 20 cps to 20 kc range. Unique feedback circuitry throughout. Inputs for all hi fi sources including tape deck. SCA-35 kit \$89.95; wired \$129.95

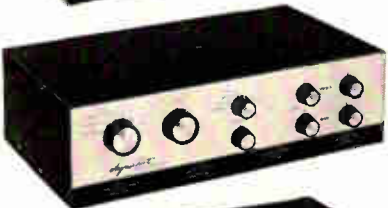

PAS-2—Fully flexible stereo preamplifier with less than .1% distortion at any frequency. Wide band, lowest noise with every necessary feature for superb reproduction. Acclaimed throughout the world as the finest unit available. PAS-2 kit \$59.95; wired \$99.95



***STEREO 35**—A basic power amplifier similar to that used in the SCA-35. Extremely low distortion over entire range at all power levels. Inaudible hum, superior transient response, and outstanding overload characteristic makes this unit outperform components of much higher nominal rating. Features new type Dynaco output transformer (patented design). Fits behind PAS-2 or FM-3A units. ST 35 kit \$59.95; wired \$79.95



STEREO 70—One of the most conservatively operated and rated units in the industry. The Stereo 70 delivers effortless 35 watts per channel continuous power. Its wide band Dyna circuit is unconditionally stable and handles transient wave forms with minimum distortion. Frequency response is extended below 10 cps and above 40 kc without loss of stability. This amplifier is admirably suited to the highest quality home listening requirements with all loudspeaker systems. ST 70 kit \$99.95; wired \$129.95

*** NEW!** LOWER PRICED COMPONENTS WITH FULL DYNA QUALITY

Write for descriptive literature

DYNACO INC. • 3912 POWELTON AVE. • PHILA. 4, PA.
Cable: DYNACO Philadelphia

Now is the time
to come to the aid
of your party!



Electro-Voice®

High-Fidelity Speaker System
...it's Weather-Proofed!

Now you can easily add the luxury of high-fidelity music to your outdoor fun!

Whether you're dancing under the stars, swimming in the pool or relaxing around the barbecue... the new Electro-Voice Musicaster provides high-fidelity music from your present hi-fi system, radio, phonograph or TV set.

Specially designed for indoor-outdoor use, the E-V Musicaster features a heavy-duty weather-proofed speaker mounted in a rugged aluminum die-cast enclosure. It's easy to connect for permanent use outside. And you simply move it into the recreation room for year-round pleasure.

Send now for full information... plus the name of your nearest E-V sound specialist!

The E-V Musicaster® is also a "sound" buy for church, school, or club!



ELECTRO-VOICE, INC., Buchanan, Mich.

ELECTRO-VOICE, INC., Dept. 534F
Buchanan, Michigan
Please send me your free booklet, "How to Enjoy High-Fidelity Outdoors" and E-V sound specialist list.

Name _____

Address _____

City _____ State _____

CIRCLE NO. 21 ON READER SERVICE CARD
76

© ® KENNY DORHAM: *Matador*.
Kenny Dorham (trumpet), Jackie McLean (alto saxophone), Bobby Timmons (piano), Teddy Smith (bass), J. C. Moses (drums). *El Matador; Melanie; Smile*; and three others. UNITED ARTISTS UAS 15007 \$5.98, UAJ 14007 \$4.98.

Interest: Post-bop stalwarts
Performance: Committed
Recording: Fair
Stereo Quality: OK

Of all the musicians involved in the music known as post-bop, perhaps none has the commitment and conviction of trumpeter Kenny Dorham and alto saxophonist Jackie McLean. Here, although hampered by an average rhythm section and only fair recording, they demonstrate the great impact made on the style by Miles Davis.

Three seldom-done standards—*Smile, Beautiful Love, and There Goes My Heart*—are excellently chosen, and strongly reflect Davis's approach to such material. McLean's long *Melanie* has a melodic figure that is played between successive solos by Dorham, the composer, and pianist Bobby Timmons—each in Davis's modal vein.

The high and low points of the set are both Dorham's. On his own 5/4-time *El Matador*, he has a splendid, beautifully organized solo that depends upon but eventually suffers from a repeated rhythm figure. At the other end of the scale, he plays a Villa-Lobos *Prelude* that does little more than make the point that he can play the piece on the trumpet.

Both he and McLean are in top form, the first lucid, the second passionate. Along with such musicians as Mal Waldron, they are the real craftsmen of their era.

J. G.

© ® DUKE ELLINGTON AND JOHN COLTRANE: *Duke Ellington & John Coltrane*. John Coltrane (soprano and tenor saxophones), Duke Ellington (piano), Aaron Bell and Jimmy Garrison (bass), Sam Woodyard and Elvin Jones (drums). *Angela; Stevie; In a Sentimental Mood; Big Nick*; and three others. IMPULSE AS 30* \$5.98, A 30 \$4.98.

Interest: Clash of Titans
Performance: Deferential
Recording: Good

It is disheartening to report that this recorded meeting between Duke Ellington and John Coltrane is not a classic—which is not to say that it is not a superior album. Each man came to the studio with his own bassist and drummer, and various combinations of the four rhythm men were used. Both featured players contribute excellent tunes to the session: Coltrane the engaging, atypical

First Recording — Sung in English

HANDEL: SAUL ORATORIO

Copenhagen Boys Choir
Vienna Symphony Orchestra
MOGENS WÖLDIKE

Conductor:
Anton Heiller, organ
Erna Heiller, harpsichord
Jennifer Vyryan, soprano
Helen Watts, alto
Herbert Handt, tenor
Thomas Hemsley, bass
Laurence Dutoit, soprano
Maryaveta Sjöstedt, mezzo soprano
Erling Thorborg, tenor
Peter Wimberger, bass



3—12" BG-642/4
A Bach Guild Anniversary Release —
3 discs for price of 2,
Full text and notes

mono & stereo

VANGUARD
RECORDS

CIRCLE NO. 48 ON READER SERVICE CARD

PURCHASING A HI-FI SYSTEM?

TRADE-INS O.K. TIME PAYMENTS

Up to 2 years to pay!

Send Us
Your List Of
Components
For A
Package
Quotation

AIREX
WON'T BE
UNDERSOLD

All merchandise is
brand new, factory
fresh & guaranteed.

When in New York City
Visit our showroom

**AIREX
RADIO**
CORPORATION

85-MR Cortlandt St., N.Y. 7, WO 4-1820

Jim Lansing*
Altec Lansing
Electrovoice
Jensen • Leak
Hartley*
University
Acoustic Research
Janszen
Wharfedale
USL Citizen Band
International Crystals
Gansel • Hallcraft
Texas Crystals
Concertone • Viking
Bell • G. E.
Weathers
Harman—Kardon
Eico • Pilot • TEC
Sherwood*
ESL • Frazier
Superscope
Dual Changer
Bogen • RCA
Dynakit • Fisher
H. H. Scott
KSC Speaker Systems
Finco • ECI
DeWald
Sony • Roberts
Challenger
Browning • National
Garrard • Norelco
Miracord
General Radio
Rek-O-Kut
Polytronics
Tandberg*
Fairchild
Pickering • Sonar
Audio Tape
Magnecord*
Rockford Cabinets
*Fair Traded

CIRCLE NO. 3 ON READER SERVICE CARD
HIFI/STEREO REVIEW

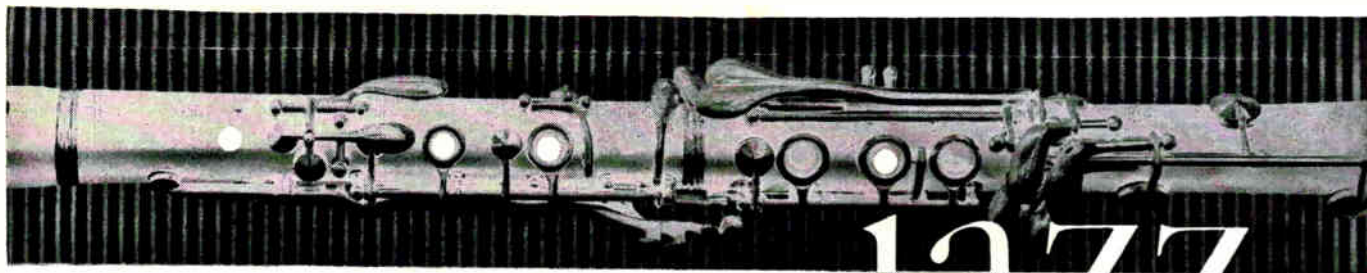

JAZZ

Reviewed by **JOE GOLDBERG** • **NAT HENTOFF**

Explanation of symbols:

- Ⓜ = monophonic recording
- Ⓢ = stereophonic recording
- * = mono or stereo version not received for review

Ⓢ **HENRY "RED" ALLEN: *Mr. Allen.*** Henry "Red" Allen (trumpet and vocals), Jerry Potter (bass), Frank Skeete (drums). *There's a House in Harlem; I Ain't Got Nobody; Biffly Blues; Sleepytime Gal;* and four others. PRESTIGE/SWINGVILLE 2034 \$4.98.

Interest: Major jazz soloist
 Performance: Generally good
 Recording: Competent

Fifty-five-year-old New Orleans-born Henry "Red" Allen has yet to achieve the widespread recognition his durably original style merits. For many years, he was overshadowed by another native of New Orleans, Louis Armstrong, and during the swing era, Roy Eldridge eclipsed him. For the past twenty years, Allen has managed to survive the ascendancy of modern jazz only by assuming the facade of a cheer-leading entertainer. Yet Allen remains one of the most inventive soloists of any jazz style or generation.

Allen has recorded infrequently in recent years and never in a musically optimal context. Although the rhythm section here is rather stolid, in this album Allen is at least unencumbered by inappropriate arrangements or the presence of horns. What counts is that the recording does provide a chance to hear a wide range of Allen's skills. There is, first of all, his melodic imagination, graceful and often daring. His trumpet tone is dark, full, and particularly expressive in the lower registers. He is exceptionally sensitive in his use of dynamics, and he varies his textures through use of growls, slurs, and other speech-like devices common to the New Orleans jazz patriarchs of his youth. Allen's beat is irresistible, and I would suggest close listening for anyone who would like a musical definition of the verb "to swing."

Allen is also a jazz singer of rare distinction, so it is regrettable that he has only two vocal tracks in this set. Few

singers can match his husky, urgent poignancy on ballads, and I hope some company will record a ballad album with a more fluid rhythm section than this, and with Ben Webster, perhaps, on tenor. While we wait, this collection is most enjoyable. *N. H.*

Ⓢ Ⓢ **CHARLIE BARNET: *Charlie Barnett!?!?*** Charlie Barnett (alto and soprano saxophones), orchestra. *Murder at Peyton Hall; Cherokee Raid; Time's A-Wastin'; Coachella Blue; East Side—West Side;* and five others. AVA AS 10 \$4.98, A 10* \$3.98.

Interest: Lounge music
 Performance: Spirited
 Recording: Good
 Stereo Quality: OK

For years, Charlie Barnett has followed as closely as possible in the footsteps of



DON SCHLITZ

HENRY "RED" ALLEN
A daring, durably original jazzman

Duke Ellington. Many Ellington songs are in his book, he plays alto and soprano in emulation of Ellington veteran Johnny Hodges, and his publishing company, in what appears to be a gesture of respect, is called Indigo Music. As is shown in this album by *Mood Indigo*, however, Barnett can only approximate the Ellington sound.

In recent years, Barnett has been play-

ing the Reno-Tahoe-Vegas lounge circuit, and the concessions those jobs require turn up here in such things as the use of organ. None of the other personnel are listed, but the music is a tasteful version of lounge music. Barnett still plays the Hodges style very well, but his accompaniment is innocuous. This album will never replace the recordings on which Barnett's reputation is based, as a listen to the newest version of *Skyliner* will indicate. *J. G.*

Ⓢ Ⓢ **DAVE BRUBECK QUARTET: *Bossa Nova U.S.A.*** Dave Brubeck (piano), Paul Desmond (alto saxophone), Joe Morello (drums), Gene Wright (bass). *Vento Fresco; Theme for June; Corocao Sensival; Cantiga Nova Swing;* and six others. COLUMBIA CS 8798 \$4.98, CL 1998* \$3.98.

Interest: Brubeck's bossa nova
 Performance: Best when reflective
 Recording: Very good
 Stereo Quality: First-rate

The majority of these pieces are Brubeck impressions of bossa nova. There is also one composition in that vein by Teo Macero, Brubeck's recording supervisor and an after-hours composer, as well as a thumpingly unsuccessful attempt to transmute *This Can't Be Love* into a bossa nova. Filling out the album are the perennial *Trolley Song*, a gentle theme from Howard Brubeck's *Dialogues for Jazz Combo and Orchestra*, and two notable Brubeck ballads, *There'll Be No Tomorrow* and *Lamento*, the latter lightly tinged with a Portuguese flavor.

Throughout the set, Brubeck is most appealing in the more lyrical, ruminative pieces in which his considerable romantic bent is allowed expression. The essence of bossa nova is bittersweet nostalgia, and he has assimilated the style with sensitivity—except on the up-tempo tracks. No matter what the idiom, Brubeck is almost always at his stiffest when the tempo increases. His sense of swing loses its fluidity and his ideas seem to be hewn out of concrete. Paul Desmond wanders in and out of the proceedings, adding his lucent, sinuously woven patterns of detached sensuality. *N. H.*

(Continued on page 76)

So what's new on ARGO?

LP & LPS 697



LP & LPS 708

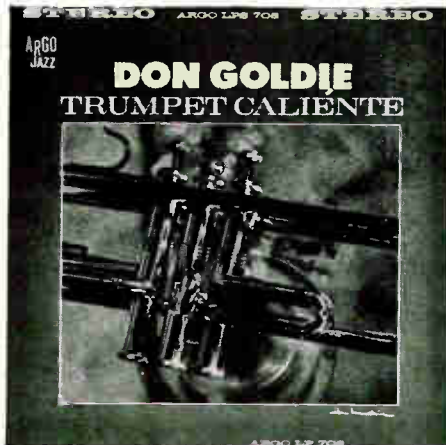

LP & LPS 710

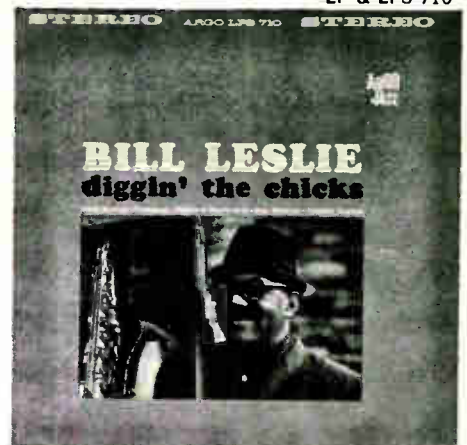

LP & LPS 711

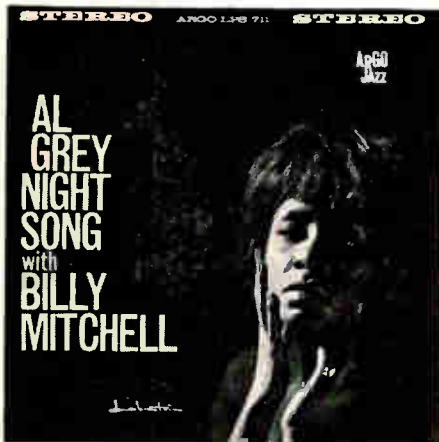

LP & LPS 712

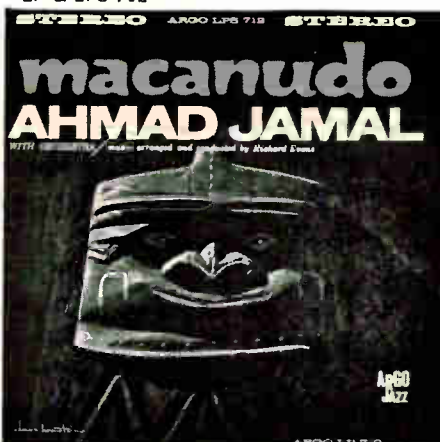

GENE AMMONS AND SONNY STITT IN ONE OF THEIR FINEST TENOR SAX BATTLES • DON GOLDIE AND PALS PLAYING SOME FINE BOSSA NOVA ARRANGEMENTS BY MANNY ALBAM • BILL LESLIE DIGGIN' "LONELY WOMAN", "IRENE", "MARGIE" AND OTHER SWINGING CHICKS • THE AL GREY/BILLY MITCHELL SEXTETTE COOKIN' ON TUNES ABOUT NIGHTTIME • AHMAD JAMAL BEAUTIFULLY BACKED BY A LARGE ORCHESTRA — ALL BRAND NEW, ALL ARE WORTHY OF YOUR TURNTABLE. ALL IN MONAURAL AND STEREO.

FINE ARTISTS • MEMORABLE PERFORMANCES

recent & choice

SEND FOR FREE CATALOG

REARIN' BACK
SONNY STITT
LP & LPS 709



BREAKTHROUGH
GENE SHAW QUINTET
LP & LPS 707

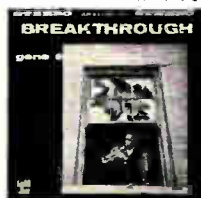

BLUES ON THE OTHER SIDE
MIKE MAINIERI QUARTET
LP & LPS 706



SOUL COOKIN'
THORNEL SCHWARTZ
LP & LPS 704



ARGO RECORDS

2120 SOUTH MICHIGAN AVENUE
CHICAGO 16, ILLINOIS

and not necessarily to admirers of Russia's greatest modern composer.

For Richter's way with Prokofiev, like his approach to most composers, is highly personal and special. If you fancy your Prokofiev hard-edged, motor-rhythmic, and forceful, you'll not find the composer you seek; if you like a lyrical Prokofiev—more sweet than bittersweet—the playing on these records should be to your taste.

There is no need to belabor the built-in shortcomings of this series. The sound varies, like most on-the-spot engineering, but it is nearly always acceptable. *W. F.*

RECORDING OF SPECIAL MERIT

© **RENATA TEBALDI:** Puccini: *La Bohème: Mi chiamano Mimì; Donde lieta uscì. Tosca: Vissi d'arte. La Fanciulla del West: Laggiù nel Soledad. Madama Butterfly: Un bel dì, vedremo; Con onor muore. Turandot: Signore ascolta; Tu che di gel sei cinta. Giordano: Andrea Chénier: La mamma morta. Cilèa: Adriana Lecouvreur: Io sono l'umile ancella; Poveri fiori. Boito: Mefistofele: L'altra notte in fondo al mare. Renata Tebaldi (soprano); Orchestra of the Accademia di Santa Cecilia Rome, Tullio Serafin, Francesco Molinari-Pradelli, Franco Capuana, Alberto Erede, and Gianandrea Gavazzeni cond. LONDON OS 25729 \$5.98, 5729* \$4.98.*

Interest: Tebaldi
Performance: Beguiling
Recording: Sumptuous
Stereo Quality: Good balance

Creating an aria recital from various complete operas is not an easy task, particularly with the works of Puccini, to whom musical continuity was more important than applause-accommodating lacunae. Puccini being predominant in Miss Tebaldi's program, listeners will have to accept a rather inconclusive snippet from *La Fanciulla del West* and a Death Scene of Liù that ends almost as brutally and suddenly as did the poor girl herself.

But what passionate and poetic character evocations are offered to offset these minor drawbacks! Whatever Tebaldi's limitations as an actress on stage, few voices can convey so much emotion, so much smoldering yet controlled fire and temperament. There is a richer tonal glow and more firmness in the excerpts recorded several years ago (*Turandot, Andrea Chénier*) than in the *Adriana Lecouvreur* arias that are more representative of the artist's current vocal estate. But the lapses from technical perfection are insignificant when weighed against the pleasure derived from the sustained sensuous beauty of her singing.

Even if you own the complete sets, this is a rewarding disc to have. *G. J.*

JUNE 1963

NOW

**50%
MORE
TAPE**
with New



“TRIPLE PLAY”

by

AMERICAN



3600 FEET ON A 7 INCH REEL

Introducing: American's New Professional Length "TRIPLE PLAY" Recording Tape . . . 3600 feet of Tensilized Mylar on the standard seven inch reel. Only "TRIPLE PLAY" offers 50% more tape, 50% more recording time . . . up to 12 full hours of recording pleasure on a single reel of tape.

GREENTREE



ELECTRONICS

291 S. LA CIENEGA BOULEVARD
BEVERLY HILLS, CALIFORNIA

See you in Chicago at the May Parts Show, Hilton Hotel, Room 658-A

CIRCLE NO. 29 ON READER SERVICE CARD

For the 'Professional' Audiophile Only

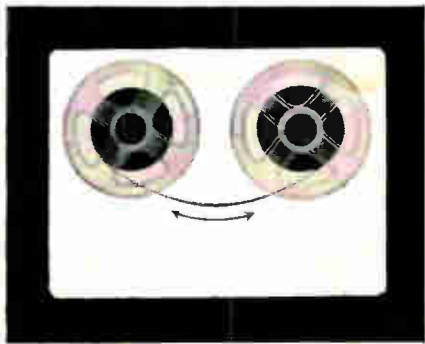

Viking Retromatic 220

■ Audio-sensed or manual reverse playback.
 ■ Integrated 12 watt amplifier (6 watt per channel). ■ Hysteresis synchronous capstan motor. ■ Two shaded-pole reel drive motors.
 ■ Two speed. ■ Quarter track stereo. ■ Silent, feather-touch push buttons. ■ All electric controls. ■ Monitor off tape. ■ Sound on sound recording. ■ Multiplex-record-ready. ■ Photo electric run out sensor. ■ Hyperbolic heads.
 ■ Stainless steel face plate. ■ Record indicator light for each channel. ■ Illuminated VU meters. ■ Front panel volume controls for each channel. ■ Remote control receptacle. ■ Mount vertically or horizontally.

HERE IS YOUR PREVIEW of the most advanced design in any stereo tape recorder of today. The all new Retromatic 220 incorporates every truly important feature you could ask for and delivers the quality professionals seek. See the Retromatic 220—a giant in performance—a compact in size.

SPECIFICATIONS:

FREQUENCY RESPONSE:

20-25,000 CPS Record/Playback at 7.5 IPS

20-15,000 CPS Record/Playback at 3.75 IPS

OUTPUT, MONITOR: 6 watts per channel to speaker or phones.

OUTPUT, MUSIC SYSTEM: 1 volt per channel low impedance.

INPUT SENSITIVITY, LOW LEVEL: 1 MV, 1 megohm impedance.

INPUT SENSITIVITY, HIGH LEVEL: 100 MV for Music System, Tuner, etc.

SIGNAL TO NOISE RATIO: 55 DB.

TAPE SPEEDS: 7½ IPS or 3¾ IPS, electrically selected.

CAPSTAN DRIVE: Flutter-filter multiple belt drive. Dynamically balanced flywheel. Oilite bearings.

CAPSTAN DRIVE MOTOR: Hysteresis Synchronous 2 speed precision motor.

FLUTTER AND WOW: Less than 0.2% RMS at 7.5 IPS.

BRAKES: Solenoid-controlled differential braking.

REEL SIZE: 7 inch maximum.

FAST FORWARD/REWIND TIME: 60 seconds for 1200 foot reel.

COUNTER: 3 digit decimal, resettable.

AC POWER REQUIREMENTS: 200 watt maximum, 110-120 VAC 60 cycles.

Ask your dealer for the Viking Retromatic 220 or write us for information.



CIRCLE NO. 49 ON READER SERVICE CARD
72

(Act II); *Wie sie selig; Mild und leise* (*Liebsteod, Act III*). Frida Leider (soprano); Lauritz Melchior (tenor); orchestras, Leo Blech, Albert Coates, Robert Heger, and Sir John Barbirolli cond. ANGEL COLH 132 \$5.98.

Interest: Great Wagnerians

Performance: Memorable

Recording: Dated but listenable

Unlike Kirsten Flagstad, whom she preceded as the Wagnerian soprano of her time, Frida Leider also excelled in a variety of non-Wagnerian roles, in the operas of Weber, Mozart, Verdi, and Strauss. She sang five seasons with the Chicago Opera (1928-1933) and two with the Metropolitan, but since few of her recordings received wide circulation in America, she never attained the general recognition here that was her due.

Leider's voice had an easy command of an extended scale, and it rang with a warm and appealing vibrancy in all registers. The compassionate, human quality that first-hand observers invariably detected in her singing is mirrored in these recordings. Though not of Flagstad's opulence, her voice was by no means limited in power—her excitingly rendered *Isolde's Curse* amply demonstrates this. She was also a careful musical artist, as witness the cleanly articulated passages in her Beethoven and Mozart; such qualities were exceptional in her day.

The *Tristan* love duet, a collector's must in the 78-rpm days, suffers from the severe cuts necessary to accommodate it on a double-face disc at the time of its first release. It sounds cramped now, doing less than full justice to the undeniably glorious singing. Melchior's "*O König*," on the other hand, is a really treasurable memento of the great tenor's tonal richness and declamatory pathos. Although these selections of 1928 to 1931 betray their age sonically, I hope that the connoisseurs for whom this release was intended will not pass it by.

G. J.

RECORDING OF SPECIAL MERIT

Ⓢ Ⓜ NEW YORK PRO MUSICA: *Renaissance Festival Music: Susato* (Collection): *Suite of Dances: Basse danse "La mourisque"; Branle and "Fagot"; Two Rondes; Basse danse and Reprise; Allemaingne and Recoupe; Pavane "Mille regretz"; Pavane "La bataille". Viadana: Canzon "La Padovana." A. Gabrieli: Ricercar del Duodecimo Tuono à 4. G. Gabrieli: Canzon terza à 4; Canzon quarta à 4; Canzon Septimi Toni à 8. Grillo: Canzon à 4. Maschera: Canzon "La Fontana" à 4. New York Pro Musica Instrumental Ensembles, Noah Greenberg (director). DECCA DL 79419 \$5.98, DL 9419 \$4.98.*

Interest: Renaissance instruments

Performance: A model

Recording: Excellent

Stereo Quality: Excellent

Noah Greenberg's second recording of all-instrumental music—the first on Decca DL 79415/DL 9415 was "Instrumental Music from the Courts of Queen Elizabeth and King James"—is another remarkable achievement. It is not only an educational experience but a thoroughly entertaining collection as well, with a well-planned variety of Flemish dances and Venetian antiphonal music played with amazing skill and precision on such exotic-sounding yet perfectly blended instruments as cornettos, sackbuts, shawms, recorders, krummhorns, schryari, viols, and a host of others. To hear one of the Gabrieli pieces played in a modern orchestral transcription and then here in Greenberg's lively authentic version is indeed an ear-opener. Along with Archive ARC 73154/3154, "Gabrieli and His Contemporaries," which duplicates only a few of these lively, sonorous works, this collection stands as one of the best of its kind. The seventeen-man ensemble has been recorded to perfection. I. K.



SVIATOSLAV RICHTER

Lyrical Prokofiev in Carnegie Hall

Ⓢ SVIATOSLAV RICHTER: *At Carnegie Hall. Prokofiev: Sonata No. 6; Sonata No. 8; Sonatine Pastorale; Paysage; Pensée III; Gavotte from Cinderella. Rachmaninoff: Prelude, Op. 23, No. 4, in D Major; Prelude, Op. 23, No. 5, in G Minor. COLUMBIA M2L 282 two 12-inch discs \$9.96.*

Interest: Historic recital

Performance: Individual

Recording: Serviceable

Here is yet another disc perpetuation of the sensational series of recitals that Russia's greatest pianist, Sviatoslav Richter, played in Carnegie Hall in 1960. But this recorded program, nearly all Prokofiev, can be recommended wholeheartedly only to students of Richter's pianism,

HIFI/STEREO REVIEW

JUST RELEASED

IN ANGEL'S "GREAT RECORDINGS
OF THE CENTURY" SERIES



ARTUR SCHNABEL'S BEETHOVEN PIANO CONCERTOS

At last — Schnabel's finest recordings of these mighty five, made between 1932 and 1947, with the London Symphony Orchestra and the Philharmonia Orchestra conducted by Sir Malcolm Sargent, Issay Dobrowen and Alceo Galliera. Five discs. GRE 4006 (mono only)

For a Limited Time Only:

"GREAT RECORDINGS OF THE CENTURY" AT A GREAT SAVING!

GET ONE DISC FREE with the purchase of every two—at participating dealers—of Angel's extensive catalog of the world's most honored recorded performances...



Instrumentalists: Casals, Cortot, Fischer, Horowitz, Kreisler, Landowska, Prokofiev, Schnabel, Serkin, Thibaud... Conductors: Barbirolli, Boulangier, Busch, Furtwängler, Walter... Singers: Battistini, Caruso, Chaliapin, Dal Monte, Gigli, Lehmann, Leider, List, McCormack, Melba, Melchior, Muzio, Schipa, Schorr, Schumann, Supervia, Teyte, Turner...

For instance, you might choose the new album of Schnabel's five Beethoven Concertos and his previously released pairing of Mozart Concertos (Nos. 21 and 27)—all for the regular price of 4 discs! Your dealer can furnish a complete list of these treasured Great Recordings of the Century; see him now!



MORE CLASSICAL REVIEWS

IN BRIEF

DATA

COMMENTARY

⑤ ⑥ **BEETHOVEN: Piano Concerto No. 5, in E-flat, Op. 73 ("Emperor"); Fantasia in G Minor, Op. 77.** Alfred Brendel (piano); Vienna Pro Musica Orchestra, Zubin Mehta cond. Vox 512050 \$4.98, 12050* \$4.98.

Brendel and twenty-six-year-old Bombay-born Zubin Mehta turn out a glittering, essentially objective "Emperor." Brendel's pianism and the close microphoning of the orchestra together create a literal, underlined effect at the expense of lyrical warmth and momentum. The piano tone is metallic in both the concerto and the fascinating G Minor Fantasia, which is played with great brilliance. D. H.

⑤ ⑥ **BEETHOVEN: Symphony No. 6, in F Major, Op. 68 ("Pastoral").** Cleveland Orchestra, George Szell cond. Epic BC 1249 \$5.98, LC 3849* \$4.98.

This "Pastoral" is a near miss. The opening movement is surprisingly heavy-footed and generally lacking in joy, and the brook doesn't flow with much ease. Splendid rhythmic tension and momentum are maintained throughout the *Thunderstorm*, which also benefits from unusually clean and full-bodied recorded sound. D. H.

⑤ ⑥ **HOLST: The Hymn of Jesus; The Perfect Fool; Egdon Heath.** BBC Symphony and the BBC Chorus, Sir Adrian Boult cond. LONDON CS 6324 \$5.98, CM 9324* \$4.98.

The compositions of the English composer Gustav Holst—a curious blend of Wagner, French Romanticism, and nationalism—reflect an England not yet jolted by World War I. For me, Holst conjures nostalgic images of an Edwardian London moodily photographed in black and white. The recorded sound and performance are exactly what they ought to be. W. F.

⑤ ⑥ **CARLOS MONTOYA: The Incredible Carlos Montoya.** Montoya: *Alegria-Rosa; Guajiras; Rondeña; Huelva; Zambra; Café de Chinitas; Zapateao; Alorno y Verdial.* Carlos Montoya (guitar). RCA Victor LSP 2566 \$4.98, LPM 2566* \$3.98.

Montoya's instrumental command is indeed incredible. This program, taped at the artist's recital in New York's Town Hall, evokes the flamenco spirit as enriched by inventive variations and subtle infusions of Andalusian, Moorish, and Caribbean elements. The recorded sound is astonishing in its richness of detail and lifelike clarity. G. J.

⑤ ⑥ **MOZART: Piano Concerto No. 21, in C Major (K. 167); Piano Concerto No. 23, in A Major (K. 488).** Artur Schnabel (piano); RCA Victor Symphony Orchestra, Alfred Wallenstein cond. RCA Victor LSC 2634 \$5.98, LM 2634 \$4.98.

The first movement of the festive C Major Concerto comes out altogether too taut and virtuosic here, and the performance is not redeemed by the tonal beauty of the slow movement or by Schnabel's nimble-fingered treatment of the finale. The A Major Concerto, a smaller-scale work, has fewer temptations to virtuosic display, and the pianist achieves fluent momentum, vivid phrasing, and beautifully calculated tonal weight. Wallenstein's orchestral support is good, and the recorded sound is quite satisfactory. D. H.

⑤ ⑥ **RUSSIAN ORCHESTRAL MASTERPIECES.** Rimsky-Korsakov: *Capriccio Espagnol, Op. 34.* Moussorgsky: *A Night on Bald Mountain.* Borodin: *Polovstian Dances from Prince Igor; In the Steppes of Central Asia.* Royal Philharmonic Orchestra, Georges Prêtre cond. ANGEL S 35951 \$5.98, 35951* \$4.98.

The recorded sound is some of the cleanest, the orchestral playing some of the most precise that I have ever heard on the Angel label, but Prêtre's readings lack that measure of expansiveness and rhythmic exuberance necessary to bring these favorites off. Gallic logic is here, but not Russian headiness. D. H.

⑤ ⑥ **SHOSTAKOVICH: Piano Concerto No. 1.** André Previn (piano); New York Philharmonic, Leonard Bernstein cond. **POULENC: Concerto for Two Pianos.** Gold and Fildale (duo pianos); New York Philharmonic, Leonard Bernstein cond. COLUMBIA MS 6392 \$5.98, ML 5792 \$4.98.

It is hard to imagine either of these neat and sassy works in a better performance. The strongly intuitive musicality of André Previn's playing suits the Shostakovich perfectly, while Gold and Fildale bring all-but-unearthly perfection to the Poulenc. The recording, too, is bright and flashy, but the bass in the Shostakovich is overly prominent. W. F.

⑤ ⑥ **SOLISTI DI ZAGREB: Notturmo.** Respighi: *Ancient Airs and Dances—Suite No. 3.* Mozart: *Serenade ("Eine Kleine Nachtmusik").* Vaughan Williams: *Fantasia on "Greensleeves."* Pergolesi (attr.): *Concertino, in G Major.* Sibelius: *Valse Triste, Op. 44.* Barber: *Adagio for Strings, Op. 11.* Solisti di Zagreb, Antonio Janigro cond. VANGUARD VSD 2126 \$5.95, VRS 1095 \$4.98.

The famous Zagreb group sounds wholly in character throughout the Respighi transcriptions, the Mozart serenade, and the concertino, and (augmented by flute and harp) beautifully carries off the Vaughan Williams *Fantasia*. However, it lacks the body and intensity for Sibelius and Barber. Vanguard's recording is up to the company's customary high standards of excellence. D. H.

L'Italiana in Algeri: Le femmine d'Italia. Mozart: Don Giovanni: Madamina; The Magic Flute: Qui sdegno non s'accende; Le Nozze di Figaro: Non più andrai; Concert Aria K. 513, Mentre ti lascio o figlia. Ezio Flagello (bass); Orchestra Sinfonica di Roma, Nicholas Flagello cond. SCOPE V0001 S \$4.98, V0001M \$3.98.

Interest: Considerable
Performance: Excellent
Recording: First-class
Stereo Quality: Pronounced

Ezio Flagello, one of the Met's most consistently impressive performers, brings to his first aria recital solid musicianship, exceptionally smooth technique, and a secure mastery of both the Mozart and Rossini styles. In the buffo arias he combines the requisite spirit and unctious with



SCOPE RECORDS

EZIO FLAGELLO

Stylistic mastery and lavish vocal gifts

the kind of warm and rich sonorities seldom found even in the genre's most accomplished interpreters. He can make expressive points without interpretive exaggerations—a rare and laudable restraint in buffo singing. Equally rewarding is the singer's way with music that calls for spinning a broad legato—"Qui sdegno"—and contrasting dramatic utterances—"Mentre ti lascio." In short, this young artist has lavish vocal gifts, taste, and musicality, and is on his way to achieving that mark of personal authority that spells greatness.

Nicholas Flagello's slow pacing for "La calunnia" claims the authority of Rossini's manuscript. I am not prepared to argue this, but I must confess a preference for the traditional quicker tempo. "Madamina" could also use a more vivacious clip, but otherwise the orchestral support is far above average in its atten-

tion to subtleties of texture. The stereo sound is widespread and exceptionally well defined. G. J.

© ® GABURO: *Line Studies*. ET-
LER: *Bassoon Sonata*. CASCARINO:
Bassoon Sonata. LIEBERSON: *String
Quartet*. Sol Schoenbach (bassoon),
Walter Trampler (viola), Julius Baker
(flute), David Glazer (clarinet), Erwin
L. Price (trombone), Romeo Cascarino
and Joseph Levine (piano); Galimir
Quartet. COLUMBIA MS 6421 \$5.98, ML
5821 \$4.98.

Interest: Contemporary Americans
Performance: Presumably authentic
Recording: Spare and appropriate
Stereo Quality: Helpful

It is odd the tricks that time and fashion, period and style can play on our ears—or, more precisely, on our aural absorption of modern musical techniques. The most fashionable of the works on this disc, Gaburo's *Line Studies*, is a solidly wrought and perfectly musical piece cast in the twelve-tone post-Webern mold that has been the stylistic model for most of our younger composers since the mid-Fifties. The Cascarino, Etler, and Lieber-son works, however, are composed in the more or less neoclassic tonal styles of the Forties, which the post-Webernite movement was to replace. Yet it is peculiar that one's ears have recently been so relentlessly exposed to the kind of piece Gaburo has written that, for all its skill and integrity, it sounds far less fresh than the more conservative works.

This aside, the recording is an attractive package. Cascarino's *Bassoon Sonata*, with its jazz-inflected diatonic dissonance, makes up in poise what it lacks in surprise. Etler's piece is workmanlike, smoothly functional, and pleasantly tuneful.

That Goddard Lieberson is the president of Columbia Records is a coincidence that becomes irrelevant when we hear his *String Quartet* of 1938. It well deserves its place on this record, both for the skill of its workmanship and for the appeal of its expressive content. The Adagio that brings the work to a close is lovely.

The recorded sound is fine, and the performances are likewise. W. F.

RECORDING OF SPECIAL MERIT

® FRIDA LEIDER/LAURITZ MEL-
CHIOR: *Operatic Scenes and Arias*.
Gluck: *Armide: Ah! si la liberté*. Mozart:
Don Giovanni: Or sai chi l'onore. Bee-
thoven: *Fidelio: Abscheulicher! wo eilst
du hin?* Wagner: *Parsifal: Ich sah das
Kind. Tristan und Isolde: Isolde's Nar-
ration and Curse (Act I); Love Duet:
O König . . . Wohin nun Tristan scheidet*
(Continued on page 72)

ACOUSTECH I

SOLID STATE POWER AMPLIFIER



"...better than the best..." states renowned audio expert Julian D. Hirsch in February, 1963 *Hi-Fi/Stereo Review*.

READ THESE EXCERPTS FROM HIS REPORT . . .

- "... the listening quality . . . had all the effortless, unstrained character of the finest and most powerful vacuum tube amplifiers, plus that undefinable 'transistor sound' . . . a dry, tightly controlled, and highly transparent quality . . ."
- "... the finest square wave response I have ever observed . . . absolutely no ringing or overshoot . . ."
- "... the Acoustech I met or exceeded all its specifications for which I was able to test . . ."
- "... in its design and construction . . . resembles industrial or military equipment . . ."
- "The unit sells for \$395 . . . For those who can afford it, however, I think it is worth every cent of its cost."



For a copy of the complete report plus an authoritative booklet on

WRITE TO:

ACOUSTECH, INC., DEPT. R6
139 Main St.
Cambridge 42, Mass.

Name _____

Address _____

City _____ State _____



ACOUSTECH, INC., CAMBRIDGE, MASSACHUSETTS

CIRCLE NO. 1 ON READER SERVICE CARD

**The San Diego
Symphony Orchestra
listens to itself**

AR-3 (one of a stereo pair)



During rehearsals members of the San Diego Symphony Orchestra pause now and then to listen to a taped recording of the passage they have just played.

AR-3 loudspeakers were chosen for the stereo playback system because of their lifelike reproduction of orchestral timbres. Any pseudo-hi-fi coloration here would defeat the purpose of monitoring.

AR-3's and other AR speaker models are often used professionally, but they are designed primarily for the home. Prices range from \$89 for an unfinished AR-2 to \$203-\$225 (depending on finish) for an AR-3.

A five-year guarantee on all models covers any repair costs, including freight.

A catalog and list of AR dealers in your area will be sent on request.

We will also send a brief description and order form for two books on high fidelity published by AR.

Considering that the originals were never considered superior acoustically, the technical reconstruction has been accomplished very well. Philip L. Miller's background annotations not only tell us much about the artists but re-create that bygone period most illuminatingly. A facsimile of Columbia's 1903 brochure is also supplied with the set. All told, this is a fascinating and, for the historically minded collector of vocal records, an indispensable collection. *G. J.*

© ® **FRANCO CORELLI: Operatic Arias. Puccini: Turandot: Nessun dorma. Manon Lescaut: Donna non vidi mai. Tosca: Recondita armonia; E lucevan le stelle. Donizetti: La Favorita: Spirito gentil. Meyerbeer: Les Huguenots: Bianca al par di neve alpina. Cilèa: Adriana Lecouvreur: L'anima ho stanca. Bellini: I Puritani: A te, o cara. Giordano: Andrea Chénier: Un dì all'azzurro spazio. Ponchielli: La Gioconda: Cielo e mar.** Franco Corelli (tenor); orchestra, Franco Ferraris cond. ANGEL S 35918 \$5.98, 35918* \$4.98.

Interest: Met star
Performance: Passionate
Recording: Good
Stereo Quality: Good

Listeners familiar with the powerful and often electrifying singing Franco Corelli has been exhibiting at the Metropolitan Opera during the past three seasons will find more of the same in this recital. It seems, though, that Corelli is one of those singers who give more enjoyment across the footlights than they do on records. His voice is sensuous, vibrant, and full-bodied, and does not require the microphone to enhance its natural endowments. There is also an attractive earthiness in Corelli's singing—quite appropriate in many places, but wanting elegance of phrasing in "Recondita armonia" and in the Bellini and Donizetti arias. Though records have a way of pointing up these stylistic lapses, it is good to hear "Spirito gentil" and "A te, o cara" with their recitatives in Corelli's fervent and sympathetic treatment—not too many tenors undertake this demanding music nowadays. Despite occasional crudities and what appears to be a growing tendency to scoop, this is an impressive display of the art of one of today's most accomplished Italian tenors. The accompaniments are no models of virtuosic execution, but the sound is rich and reasonably well balanced. Full texts and translations are supplied. *G. J.*

RECORDING OF SPECIAL MERIT

© ® **EZIO FLAGELLO: Sings Rossini and Mozart Arias.** Rossini: *La Cenerentola: I miei rampolli; Il Barbiere di Siviglia: A un dottor; La calunnia;*

available the thirty-three selections that made up that release. As a historical footnote, it may be added that Columbia's much-heralded pioneering venture was then so unsuccessful commercially that the firm was compelled to withdraw from the field, leaving Victor—whose Red Seal series burst upon the scene shortly thereafter—in a virtually unchallenged position. Within a few years after their release, Columbia's 1903 discs disappeared from the market, save for an occasional specimen that drew fancy prices from collectors. Fortunately, an entire set found its way into the archives of the New York Public Library, and it is through the Library's cooperation that this page of resurrected history could be brought before the public in accessible and attractive form.

The seven artists featured here were all eminent members of the Metropolitan. For some, this was the beginning of a long-lasting recording career during which they were able to rerecord the same selections—for Victor, of course. But the three Edouard de Reszke items ("In felice" from Verdi's *Ernani*, the Porter Song from Flotow's *Martha*, and Tchaikovsky's *Sérénade de Don Juan*) represent the complete recorded legacy of this legendary bass. Too imperfect technically to do justice to the artist's enormous reputation, the excerpts are nevertheless impressive evidence of De Reszke's formidable vocal art, even at the age of forty-nine.

For the rest, the redoubtable Antonio Scotti is heard in familiar excerpts from *Don Giovanni* and *Pagliacci* and in the Toreador Song, which he sings in both French and Italian. Scotti's older and lesser-known contemporary, Giuseppe Campanari (1861-1927), contributes a Toreador Song of his own, as well as some strikingly sung arias from *Faust*, *Barbiere di Siviglia*, and *L'Africaine*. There are no tenors in the set—the fourth male artist is the French baritone Charles Gilibert (1866-1910), who is represented by six elegantly sung selections from his concert repertoire.

The silvery voice and astonishingly facile technique of Marcella Sembrich is displayed in two Verdi arias ("Ernani, involami" and "Ah, fors'è lui") and Johann Strauss's *Voices of Spring*. A lesser but by no means unimportant soprano, Suzanne Adams (1872-1953), is featured in seven selections, including the Jewel Song from *Faust* and Juliet's Waltz Song. Finally, the incomparable Schumann-Heink is heard in her specialties: "Ah, mon fils" from *Le Prophète*, Schubert's *Tod und das Mädchen*, Arditi's *Leggiero invisibile*, "Mein Herz" from *Samson and Delilah*, and that incredible stunt piece of hers, the Drinking Song from Donizetti's *Lucrezia Borgia*. The piano accompanies all selections.

(Continued on page 68)

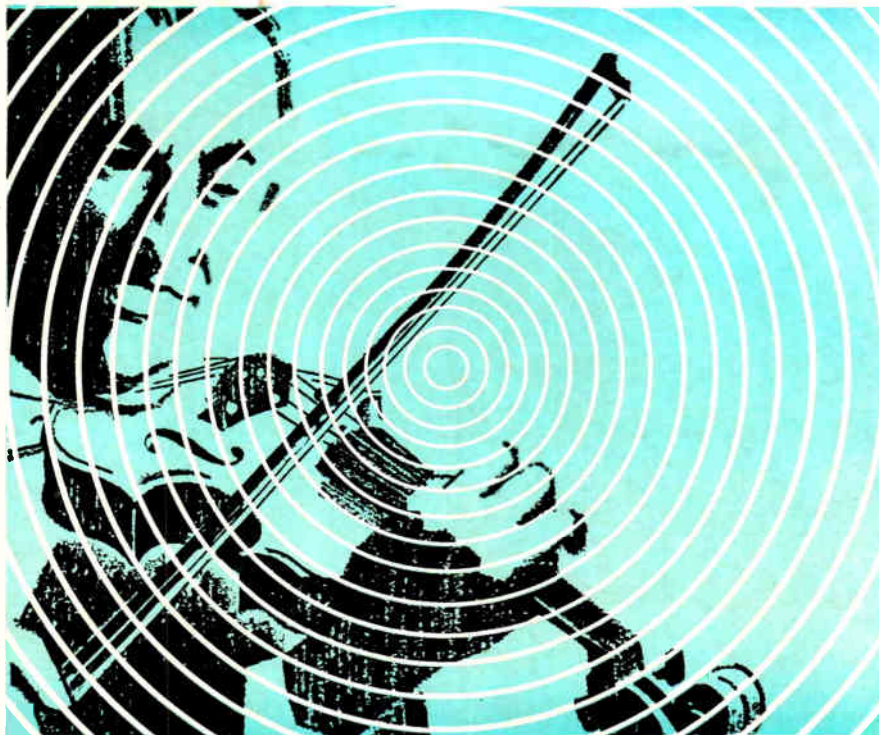

achieve THRILLING LIVING PRESENCE

WITH THE **FINCO**[®]
AWARD-WINNING FM ANTENNA

Broadcasting authorities agree that an outdoor antenna is absolutely essential for the reception of full quality monaural and multiplex FM sound.

A *FINCO* FM antenna will deliver a clean, undistorted signal and bring in more stations, regardless of location.

Guarantee yourself the best seat in the house for tonight's FM concert . . . install a fidelity-phased *FINCO* FM antenna.

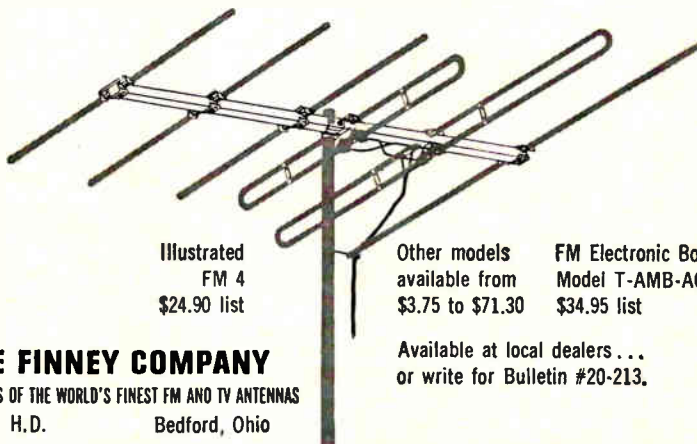

Illustrated
FM 4
\$24.90 list

Other models
available from
\$3.75 to \$71.30

FM Electronic Booster
Model T-AMB-AC
\$34.95 list

THE FINNEY COMPANY
PRODUCERS OF THE WORLD'S FINEST FM AND TV ANTENNAS
Dept. H. D. Bedford, Ohio

Available at local dealers . . .
or write for Bulletin #20-213.

EDITALL*

TAPE EDITING BLOCKS



The Simplest, Fastest
and Best way to join
Broken Tape, or to Edit.

— Used worldwide by many thousands
of professionals for over ten years.

NOW: For Tape Hobbyists,

The NEW Editall S-2, with adhesive mounting, only 4" long—\$6.50 ■ NEW KS-2, Complete Kit, \$7.45 ■ S-3 Professional, 5 3/4" long—\$8.00 ■ KS-3 Professional Kit—\$8.95

THE TALL COMPANY • 27 EAST 37TH ST. • NEW YORK 16
In Canada, Alex L. Clark Ltd., 3751 Bloor St. West, Islington, Ont.

(Dealer Inquiries Invited)

* TRADEMARK

CIRCLE NO. 45 ON READER SERVICE CARD

Records at COST!

NO "AGREE TO PURCHASE" OBLIGATION and CHOOSE THE RECORDS YOU WANT

Our special membership plan enables you to buy your records at cost price . . . Classical, popular, jazz, show hits, folk, etc. — Monaural and Stereo.

Citadel is a unique kind of record club that features:

- No "agree to purchase" obligations. Buy as few or as many records as you want, when you want them . . . the choice is yours.
- No "preselected" record list. You choose the records you want from catalog containing virtually all artists and all labels.
- No "list price" purchases. You never pay more than the club price.
- Periodic specials. Outstanding buys are made available periodically, and again, you are under no obligation to purchase any of these specials.
- Prompt service. Many orders are shipped the day received . . . rarely later than the next several days.

We invite you to join thousands of other Citadel members who are purchasing their records at cost price, are enjoying complete freedom of selection and have not obligated themselves in any way. For complete details write . . .

CITADEL RECORD CLUB

545 Fifth Ave. Dept. S. New York 17, N. Y.

CIRCLE NO. 14 ON READER SERVICE CARD

66

Recording: Fine
Stereo Quality: Helpful

Admirers of the Tourel-Bernstein *Schéherazade* made available by Columbia some twelve or thirteen years ago will rejoice in this flashy new stereo version. The performance, it must be admitted, is for special tastes: if you want a Ravel cool, understated, and dispassionate, the Danco-Ansermet version on London will supply it. But those who see in the Ravel song cycle a highly colored, fantastic evocation of exotic climes—a schoolboy's vivid imagining of far-away places—will never be persuaded that the Tourel-Bernstein version can be bettered. Some may take exception to Miss Tourel's tongue-in-cheek performance of *L'Indifférent*, but who, knowing Ravel, could prove her wrong or irreverent?

Both Tourel and Bernstein make a brilliant show of the Berlioz excerpt. And if the music is more than just occasionally clap-trap, it is good to make its acquaintance. The recording is everywhere handsome. *W. F.*

A. SCARLATTI: *The Spanish Lady and the Roman Cavalier* (see *SPOKEN WORD, DALI*).

© © SCHUBERT: *Piano Sonata, in A Major, Op. Post. (D. 959)*. MOZART: *Rondo, in A Minor (K. 511)*. Charles Rosen (piano). EPIC BC 1255 \$5.98, LC 3855* \$4.98.

Interest: Great late Schubert
Performance: Coolly classic
Recording: Clean and clear
Stereo Quality: Good enough

The last year of Schubert's life saw the creation of three piano sonatas cast in the same heroic mold as the "Great" C Major Symphony. They also exhibit the same overwhelming melodic prodigality. The second of the series—the A Major here recorded—is the finest of the lot, if only by virtue of its profoundly tragic and beautiful slow movement.

In recent years, we have had available on LP only the vital and idiomatic but rather metallic-sounding performance by Friedrich Wührer (Vox VBX 10). As yet, Angel's Great Recordings of the Century series has not issued the magnificent pre-war Schnabel version I have on RCA Victor 78's. Thus it was with keen anticipation that I listened to the new Epic disc by Charles Rosen, who in his middle thirties is truly one of the bright young men of music, both as performing artist and critic-in-depth.

Regrettably, as the slow movement came to an end in Rosen's performance I had the feeling that the critic in him had inhibited his very necessary involvement with the expressive aspects of the music. This seemed to be borne out in

his elegant playing in the scherzo and finale, which are more objectively classical than the earlier movements. What Rosen has given us here is a performance tailored to perfection for a work like Mozart's C Minor Piano Sonata, but rather prim and small-scale for late Schubert. So the plaintive and piercingly lovely Mozart Rondo comes off to perfection (I notice that his pacing is a shade faster than on his 1951 REB disc). Epic's recorded sound here is first-rate in every way. *D. H.*

SCHUMANN: *Dichterliebe* (see *BEE-THOVEN*).

© © TOCH: *Quintet for Piano and Strings, Op. 64*. André Previn (piano), American String Quartet. CONTEMPORARY RECORDS S 8011 \$5.98, M 6011 \$4.98.

Interest: Contemporary chamberpiece
Performance: Good
Recording: Excellent
Stereo Quality: Appropriate

Ernst Toch's Quintet for Piano and Strings was composed in the later 1930's, and is, no matter how you slice it, a Big Piece. Its style is middling-conservative; its expressive content is completely familiar; and whatever one may think of it on the level of higher criticism, its technique is that of a master composer. For myself, I am inclined to dislike its Central European ambiance even as I admire the skill with which the piece has been manufactured.

The performance sounds absolutely first-rate, and the recorded sound is full and lifelike. *W. F.*

VIVALDI: *Concerti Grossi Nos. 10 and 11* (see *BARTÓK*).

COLLECTIONS

RECORDING OF SPECIAL MERIT

© COLUMBIA'S 1903 GRAND OPERA SERIES. Suzanne Adams, Marcella Sembrich (sopranos), Ernestine Schumann-Heink (contralto), Giuseppe Campanari, Antonio Scotti, and Charles Gilbert (baritones), Edouard de Reszke (bass); piano accompaniments. Thirty-three songs and arias. COLUMBIA M2L 283 two 12-inch discs \$9.96.

Interest: Historical
Performance: Unusual
Recording: Antediluvian

The recording of celebrity-artists in America began in 1903 with the Grand Opera Series of what was then the Columbia Phonograph Company. To commemorate the sixtieth anniversary of that event, Columbia Records has again made

zartians, except those addicted to the still potent enticements of Angel 3522. *G. J.*

MOZART: *Rondo in A Minor* (see SCHUBERT).

Ⓢ Ⓜ **PERGOLESI: *Concerto in G Major for Flute, Strings, and Continuo; Concertinos (attributed to Pergolesi): No. 2, in G Major; No. 3, in A Major; No. 4, in F Minor.*** André Jaunet (flute); Zurich Chamber Orchestra, Edmond de Stoutz cond. VANGUARD BACH GUILD BGS 5050 \$5.95, BG 638 \$4.98.

Interest: Italian Baroque
Performance: Lively but slick
Recording: Good
Stereo Quality: Well-defined

This pleasant Pergolesi collection is the second recording made by the Zurich Chamber Orchestra, the first having been devoted to a Stravinsky-Bartók coupling. The music, especially the Concertino No. 2 in G, is high-caliber (the attribution of the Concertinos to Pergolesi is a matter of mere convenience, since no other composer's authorship has definitely been established for these anonymous works). The group's late-Baroque style, however, like that of many similar ensembles, is basically symphonic, with much attention given to technical perfection, tonal polish, long-lined phrasing, and constantly shifting dynamics. In other words, it is typically Romantic, though without the excesses that sometimes characterize such treatment. This is not to say that the high quality of the instrumental playing is not enjoyable. Tempos are full of zip, and the interpretations are always dynamic, if not particularly gracious. The recording is generally full-bodied and smooth. *I. K.*

Ⓢ Ⓜ **RAVEL: *Bolero; Pavane for a Dead Princess; La Valse.*** Boston Symphony Orchestra, Charles Munch cond. RCA VICTOR LSC 2664 \$5.98, LM 2664* \$4.98.

Interest: Ravel favorites
Performance: In the vein
Recording: Fine detail, brash climaxes
Stereo Quality: A mite shallow

Charles Munch's affinity for Ravel's music needs no extended commentary. These performances speak for themselves in terms of glitter, detail, and contrasts of dramatic climax and lyrical tenderness. It should be noted in particular that Munch takes the *Bolero* at the stately tempo specified by Ravel rather than at the somewhat faster pace that has become customary. Ravel once described his *Bolero* as "fifteen minutes of orchestration without music," but it must be said that the slower tempo does much for whatever music is here.

Another of RCA's Dynagroove releases, the recording is notable for its wealth of textural detail, especially throughout the first half of *Bolero*. Indeed, I do not remember ever having heard so much of its coloristic content before, either in live performance or on records. When the music gets really loud, however, as in the last one third of *Bolero* and the end of *La Valse*, things get a bit rough. Where the Boston Symphony in Leinsdorf's Mahler recording sounds too distant and lacking in presence at the big moments, here the same orchestra seems bent on perpetrating aural mayhem, so close-up does everything sound

—dimensionally flat, lacking in aural perspective. There is also the same lack, as in the Mahler, of a realistic-sounding bass line, a factor that undoubtedly tends to overemphasize the brashness of Ravel's climaxes. *D. H.*

Ⓢ Ⓜ **RAVEL: *Schééhérazade.*** BERLIOZ: *Cléopâtre (Scène Lyrique).* Jennie Tourel (mezzo-soprano); New York Philharmonic, Leonard Bernstein cond. COLUMBIA MS 6438 \$5.98, ML 5838* \$4.98.

Interest: Blazing *Schééhérazade*
Performance: Radiant

GRADO

"Truly the world's finest..."



In October, 1960, GRADO introduced a tone arm which was primarily designed for laboratory research. Nothing was spared in the design parameters of this tone arm since all future designs were to be based on this concept. It contained features and performance characteristics far in advance of any tone arm ever offered to the public. Consumer acceptance was immediate. Never before (or since) has a tone arm been so universally acclaimed as the BEST. It has since become the international standard of excellence.

Price \$39.50

For further details write: **GRADO LABORATORIES, INC.**
4614 Seventh Ave., Brooklyn 20, N. Y.—Export—Simonrice, 25 Warren St., N.Y.C.

For The Discerning Collector



PAUL KUENTZ
PARIS CHAMBER ORCHESTRA
VIVALDI: L'ESTRO ARMONICO,
Op. 3 (Complete in 3 Volumes)
Vol. 1 DL 10070 (M), DL 710070 (S)
Vol. 2 DL 10071 (M), DL 710071 (S)
Vol. 3 DL 10072 (M), DL 710072 (S)



ORCHESTRA SAN PIETRO;
RENATO RUOTOLO, Conductor
MOZART:
Symphony No. 29 in A Major, K. 201
A Musical Joke, K. 522
DL 10068 (M), DL 710068 (S)



BOCCHERINI: Sinfonia in D Minor
("La Casa del Diavolo") • SACCHINI:
Overture, "Edipo a Colono" • VIVALDI:
Concerto for Flute and Orchestra,
Op. 10, No. 1 ("La Tempesta di mare")
Concerto for Flute and Orchestra,
Op. 10, No. 2 ("La Notte")
Gian Claudio Masi, flute
DL 10062 (M), DL 710062 (S)

DECCA

GOLD LABEL RECORDS

(M) Monaural (S) Stereo

CIRCLE NO. 17 ON READER SERVICE CARD

Although each disc contains more than forty-five minutes of music, the performance is not entirely complete. Omission of the page Valletto, a foreshadowing of Cherubino, is rather regrettable. However, this is the first recording of the opera to come our way in many years, the only one in the current catalog, and Vox is entitled to much praise for the enterprise. The recorded sound is clean, with pronounced stereo separation; the voices are rather close but seldom distorted. Full text and translations. G. J.

RECORDING OF SPECIAL MERIT

© ® MOZART: *Così fan tutte*. Elisabeth Schwarzkopf (soprano), Fiordiligi; Christa Ludwig (mezzo-soprano), Dorabella; Alfredo Kraus (tenor), Ferrando; Giuseppe Taddei (baritone), Guglielmo; Hanny Steffek (soprano), Despina; Walter Berry (baritone), Don Alfonso. Philharmonia Orchestra and Chorus, Karl Böhm cond. ANGEL S 3631 four 12-inch discs \$23.92, 3631* \$19.92.

Interest: Mozart masterpiece
Performance: Highly polished
Recording: Some distortion
Stereo Quality: Very good

No Mozart opera surpasses *Così fan tutte* in perfection of design or felicity of invention. To be sure, *Così* is not the equal of *Figaro* or *Don Giovanni* in musical or dramatic appeal, but it was not meant to be. It offers neither the former's biting social comment nor the latter's pervading sensuality; studied artificiality takes the place of vibrant drama, and Commedia dell'Arte figures substitute for flesh and blood. There are no commanding personalities, either: the musical and dramatic essence of *Così* is the ensemble. As a whole, it demands little more than attention and understanding of its premise. It offers, in return, an unceasing flow of serene and exquisite music.

It is a pleasure to be able to report that Angel's new stereo version is a model of ensemble precision. Böhm's authority with the score reflects his association with countless productions in Vienna and Salzburg. His relaxed, fastidious reading permits the music to glow in warm, romantic colors. In general, I find Böhm's approach preferable to Herbert von Karajan's brisker treatment of the score in Angel album 3522, a fine performance against which the new set must be judged. Yet there is no denying the effectiveness of Karajan's bolder contrasts in tempo. In several instances, such as Despina's two arias, Karajan's swifter pacing is vitalizing and decidedly beneficial.

There is a delightful rapport here between the Fiordiligi and the Dorabella, again the consequence of a long-established association. Schwarzkopf reveals the same attributes of refinement and

subtle vocal coloration that distinguished her portrayal in the older set. Her handling of the fiendish "*Come scoglio*" is again impressive without being breathtakingly virtuosic; in her trills, however, there is less control. Christa Ludwig gives a strong portrayal, but Nan Merriman vocalizes the role more smoothly in the Karajan performance. Hanny Steffek's Despina is neatly done, lacking the strong sense of comedy exhibited by Lisa Otto, her predecessor, but with consistently attractive tone and with more satisfactory command of Italian.

The three men are very good, though not really superior to their counterparts in the earlier set. Kraus has more voice but less elegance than Simoneau, but the engineering does not capture his tone to best advantage. Both Taddei and Berry



KARL BÖHM

Relaxed refinement, ensemble precision

are expert Mozartians who endow their interpretations with vitality and gusto. Still, the pointed nuance and clear articulation displayed by the lighter-voiced pair of Pancrai and Bruscantini have much to commend them.

The new set, as one might expect, has more impressive sonics—not only a richer over-all sound, but also added depth and a wider dynamic range. Imaginative use of stereo creates a distinct awareness of action and stage movement. Although the engineering is generally excellent, imbalances do occur. In the second-act duet, for example, Kraus seems distinctly out of range in proportion to Miss Schwarzkopf. More disappointing are the recurring instances of distortion in the ensembles—resulting, one suspects, from overmodulation.

Despite certain traditional cuts, this is the most comprehensive *Così* on records. It should, despite its occasional sonic defects, satisfy the needs of Mo-

DEUTSCHER GRAMMOPHON



La commedia è finita!

"The comedy is over!" As his dagger drops to the stage, Canio's wife and her lover lie murdered at his feet. The mask of farce has been torn away . . . the villagers' laughter is stilled by horror at the real-life tragedy before them.

Franco Corelli, singing in Leoncavallo's *I PAGLIACCI*, is uniquely gifted with the commanding physical presence, the vocal art and the histrionic ability to illuminate this familiar role with a crescendo of emotion, from the tense opening scene and through the poignant "Vesti la giubba." His characterization reaches its climax in this final moment of violence.

Corelli's sensational recording of *I PAGLIACCI* is soon to be matched by its frequent double-bill companion *CAVALLERIA*

RUSTICANA. These join the growing list of Angel recordings by the brilliant young tenor: *NORMA* (complete and highlights, with Maria Callas), an operatic recital (including arias from his greatest Metropolitan successes, *ADRIANA LECOUVREUR*, *ANDREA CHÉNIER*, *TOSCA* and *TURANDOT*) and a sunny collection of Neapolitan songs.

Angel is proud to include Franco Corelli in its roster of great recording artists of this and the preceding generations.





Only the Klemperer reading (complete with the first-movement repeat not taken here) of the symphony, in one of Angel's very best recordings, can compare with this disc. *D. H.*

CONFALONIERI: *Gala* (see *SPOKEN WORD*, DALI).

⑤ ⑥ **MAHLER: *Symphony No. 1, in D Major*. Boston Symphony Orchestra, Erich Leinsdorf cond. RCA VICTOR LSC 2642 \$5.98, LM 2642* \$4.98.**

Interest: Young Mahler
Performance: Refined
Recording: Transparent
Stereo Quality: OK

about minimal inner-groove distortion on behalf of its Dynagroove process are fully substantiated in the blazing final pages of the symphony—this despite the fact that the side is just short of thirty minutes in length, which incidentally permits an uninterrupted slow movement as against the turnover at mid-point on the Columbia disc.

As of this moment, I intend to keep the Walter disc, if only as a unique interpretive souvenir of a master conductor who was also the composer's friend and disciple. If RCA could recut a new master of the Leinsdorf taping with a more solid bass and greater dynamic range, then I would say that this version, too, would be a necessity for Mahler fanciers and BSO enthusiasts eager to hear the orchestra in top form. *D. H.*

⑤ ⑥ **MONTEVERDI: *L'incoronazione di Poppea*. Hans-Ulrich Mielsch (tenor), Nerone; Eugenia Zareska (mezzo-soprano), Ottavia; Ursula Buckel (soprano), Poppea; Grayston Burgess (counter-tenor), Ottone; Eduard Wollitz (bass), Seneca; Genia Wilhelmi (soprano), Drusilla; Sonia Karamanian (contralto), Amalta. Santini Chamber Orchestra, Muenster, Rudolf Ewerhart cond. Vox SPOBX 5113 three 12-inch discs \$9.95, OPBX* \$9.95.**

Interest: Monteverdi's last opera
Performance: Earnest
Recording: Good
Stereo Quality: Well-defined

No student of opera can listen to *L'incoronazione di Poppea* without astonishment. Francesco Busenello's book creates vivid human images as it unfolds the tale of the triumph, over all obstacles of Nero's and Poppea's adulterous love. But it is Monteverdi's bold and visionary music—reaching memorable peaks in the ardent love duets, in the lament of the wronged queen Octavia, in the plaintive arioso, "*Oblivion soave*," in Seneca's solemn utterances—that makes this opera of 1642 a cohesive and compelling masterpiece.

The performance starts somewhat discouragingly because the longish lament of Ottone, Poppea's cuckolded husband, is declaimed by countertenor Burgess in a mannered style and with a rather unpleasant tone. Fortunately, the central roles of Nero and Poppea are taken by very capable interpreters. Less satisfactory is Eugenia Zareska, a highly polished artist in former years, whose voice has developed a disturbing wobble. But if the Seneca of Eduard Wollitz can sound anything like this in the opera house, without the benefit of the microphone, we may be in the presence of the most spectacular Sarastro voice since Alexander Kipnis.

(Continued on page 64)

Who's afraid of the dangerous loudspeaker?

If you think that's a rhetorical question, you're merely confirming our suspicions. We are beginning to suspect that people don't take our advertising literally.

For two and a half years now, our ads have been warning high fidelity enthusiasts against the perils of owning an audio transducer as uncompromisingly truthful as the dangerous loudspeaker.

But no one seems to believe that we really mean what we say. Thousands and thousands of our readers have thrown caution to the wind and bought the EMI Model DLS-529.

Well, let's get it straight. We mean *exactly* what we say. Here, for example, are those who really are afraid of the dangerous loudspeaker.

Owners of much larger and more expensive loudspeaker systems, who now realize that the EMI speaker sounds considerably more natural and musical than theirs.

Possessors of less-than-perfect amplifiers, pickups or other components, who fear that the uncanny transient response and extreme transparency of the EMI speaker might reveal the slightest flaw in their equipment.

Careless record collectors, who fear the merciless clarity with which the EMI speaker reproduces scratches, gouges, pops, clicks and hiss.

Manufacturers of other loudspeaker systems. And so on.

The fearsome object itself, the dangerous loudspeaker, is deceptively simple.

There is the enclosure. 24 by 13 by 12¼ inches, of the finest available walnut. Finished on all sides, including the back. Thick walls, heavily reinforced. No ports, slots, ducts or other dubious acoustic gimmicks. Just an airtight seal and lots of damping material.

There is EMI's famous elliptical woofer, 13½ by 8½ inches, with aluminum cone and special plastic suspension. Hand-made.

Then there are the two specially designed 3½ inch tweeters and the high-precision 4,500-cps crossover network. The three drivers are strung out in a single line. The right way.

The price? That's one thing about the EMI speaker that nobody is afraid of. It's \$159.00.

Higher in the South and West. For further information, write to Scope Electronics Corporation, a subsidiary of Symphonic Electronic Corp., 10 Columbus Circle, New York 19. Exclusive distributor of EMI loudspeaker systems and integrated pickups and tone arms.

EMI

(Electric and Musical Industries, Ltd.), England
CIRCLE NO. 22 ON READER SERVICE CARD
62

That Erich Leinsdorf's way with the youthful tempers and exuberances of the Mahler First differs considerably from Bruno Walter's comes as no great surprise. On this Dynagroove disc, however, I find Leinsdorf's approach almost too refined, notably in the finale, where raw vehemence is called for. In this movement and in the scherzo, his pacing is brisk and generally good; his eschewal of Walter's rubato treatment of the finale puts him on the small end of a time differential of two minutes and fifteen seconds! Leinsdorf, who expands the contours of the first movement by taking the repeat, is here again noticeably brisker than the more romantically effusive Walter. In the slow movement, both conductors adopt what appear to be nearly identical tempos, although Leinsdorf clocks at a full minute faster.

There are two definite points in Leinsdorf's favor: musically, the consistent momentum that he brings to the finale; and sonically, the impressive clarity and brightness of the recording given him by RCA—the Columbia disc sounds distinctly muffled in comparison. Are these elements enough to warrant an unequivocal choice of Leinsdorf over Walter? I say not quite, for Walter's version offers more expressive intensity, even though it is a bit overripe at times, and Columbia's recorded sound has the edge over RCA's in its spaciousness of stereo effect, above all in a solid bass line. Part of the lack of deep bass in the RCA disc is due, I suspect, to a somewhat too distant microphone placement. But I must add that I have found this lack of a solid bass line—as compared, say, to the best discs of Command, DGG, or London—to be consistent throughout RCA's initial Dynagroove releases. There is also something curiously compressed-sounding in the huge climaxes of the finale in the Leinsdorf Mahler. It is hard to tell from the disc alone whether this is also a result of distant microphone placement, or whether there is frequency-filtering somewhere along the line. Let it be said, however, that RCA's claims

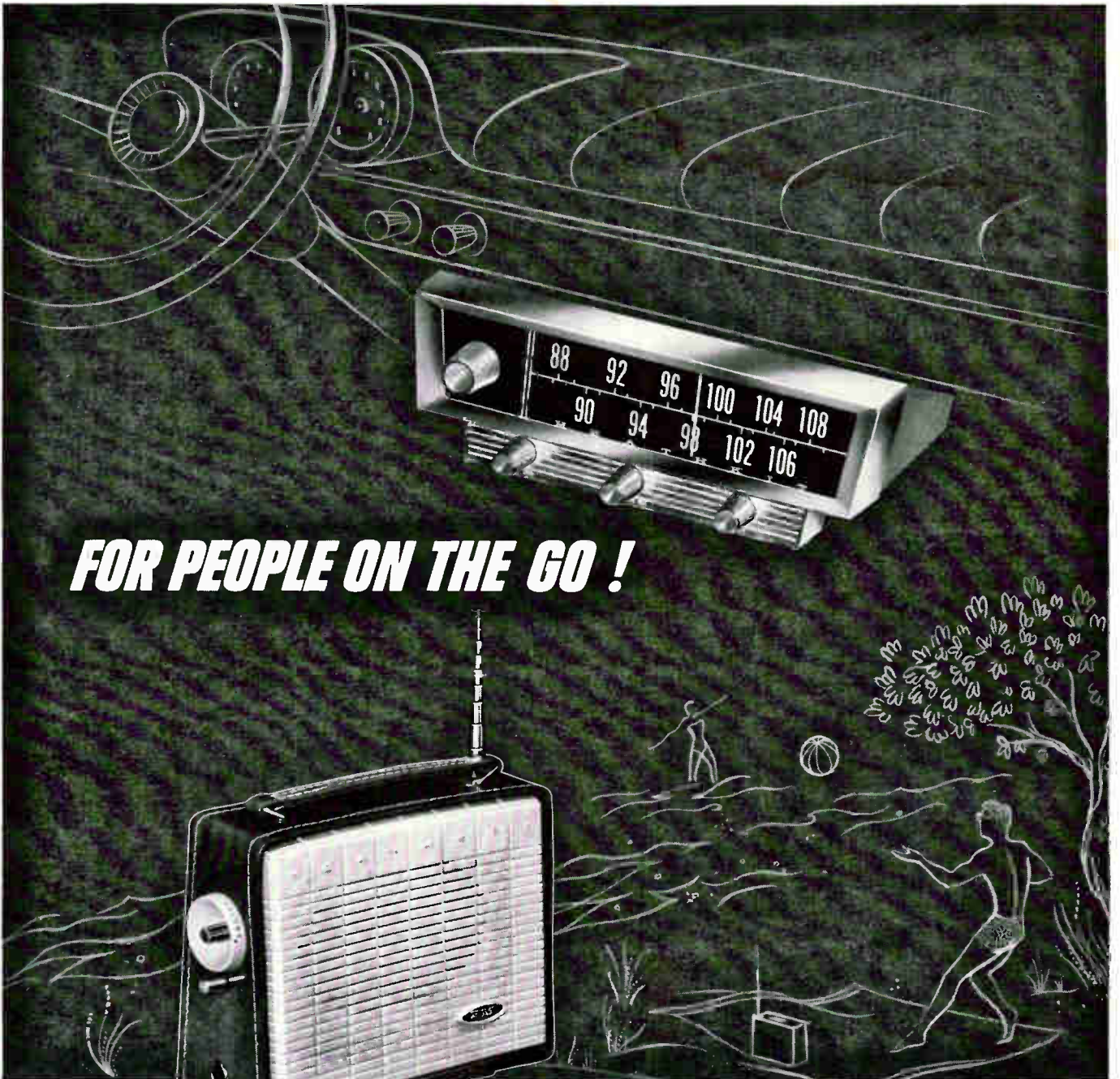

FOR PEOPLE ON THE GO !

**Heathkit FM radio -
the perfect companion**

Wherever you go . . . this summer or any season . . . take the finest in listening enjoyment with you. While driving, thrill to the static-free, full fidelity of the new Heathkit FM Car Radio. 10-transistor circuit: under-dash tuner with separate power amplifier delivers 10 watts at less than 1% distortion. (Kit GR-41, 7 lbs., for 12v. neg. gnd., \$7 mo., \$64.95) At the beach, in the cottage, or at home, the new Heathkit FM Portable Radio offers you sensitive, clear, quiet FM reception wherever you are. 10-transistor, 4-diode, battery-powered circuit: listen to its built-in speaker, use headphones, or connect it to your hi-fi system. (Kit GR-61, 6 lbs., less battery, \$5 mo., \$47.95)

HEATHKIT



a subsidiary of Daystrom

HEATH COMPANY,
Benton Harbor 40, Michigan

Please Send My FREE 1963 Heathkit Catalog

Name

Street

City Zone State

Prices & specifications subject to change without notice.
Dealer and export prices slightly higher.

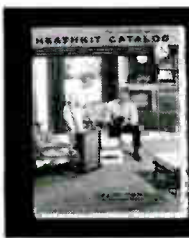

**FREE 1963 HEATHKIT
CATALOG**

Over 250 exciting do-it-yourself kits for Stereo/Hi-Fi, TV, Electronic Organs, Marine, Educational, Amateur Radio, Test & Lab, Home & Hobby. Easy to build, save up to 50%! Send for your free copy today.



You simply aim and shoot. If the light's too dim to give you a perfect picture... the camera locks... won't fire... but the lens is so powerful, you can now take most indoor pictures without flash. Patented, computer electric eye automatically makes *all* settings for you... lens openings *and* shutter speeds. No signals to watch... no settings to adjust. Nothing to remember... nothing to forget... and you can see *before* you shoot what your finished picture will look like. You get what you see every time. Living color in all its natural beauty... clear, sharp, perfectly exposed color slides. No blurs, no blanks, no wasted shots.

Professional effects are also automatic! Close-up, studio quality portraits. Breathtaking scenics. Catch split-second action. You can even control backgrounds, sharp or soft. A simple dial turn does it... and you can't make an exposure mistake even if you try. If the light's extreme, too dim or too bright, the built-in computer shifts the speed setting. Instantly! Automatically! Like to see how easy it is to use this new FUJICA? Just step into your camera store and ask. The price is surprisingly low. Less than \$100... and you get a full year guarantee.

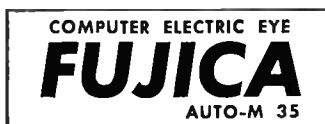

FREE FACT BOOK ON
 "How to take better pictures
 with still or movie cameras."
 Write for your copy today.

FUJI PHOTO OPTICAL PRODUCTS INC.
 111 Fifth Ave., Dept. A-71, New York 3, N. Y.

A subsidiary of Ehrenreich Photo-Optical Industries Inc.
CIRCLE NO. 26 ON READER SERVICE CARD
 60

Erik Werba (piano). DEUTSCHE GRAMMOPHON 138843 \$6.98, 18843* \$5.98.

Interest: Major song cycles
 Performance: Excellent
 Recording: Good
 Stereo Quality: Appropriate

These two romantic cycles go well together and in Haefliger both find an uncommonly sympathetic interpreter. The *Dichterliebe* is persuasively lyrical and refreshingly unmannered. Haefliger's ringing, open tones and strong contrasts in tempos succeed in highlighting the dramatic elements in some of the longer narrative songs, as compared with the more intimately scaled interpretation of Gérard Souzay (Epic BC 1110). It is also notable that Haefliger sings every song of *Dichterliebe* except *Allnächtlich im Träume* in the original key. I happen to prefer a baritone voice for the bitter emotional outpourings of *Ich grolle nicht* and *Die alten bösen Lieder*. While I hold the same preference for *Im Rhein, im heiligen Strome*, I have nothing but admiration for the way Haefliger builds the song from solemnity to radiance by gradual changes in vocal coloration.

In the somewhat less demanding Beethoven cycle, the tenor's warm, virile tone provides a welcome counterbalance to the sentimentality of the texts, and his interpretation is a model of communication. It has no real competition in the domestic catalogs. *G. J.*

RECORDING OF SPECIAL MERIT

© ® BEETHOVEN: *String Quartets Nos. 1-6, Opus 18*. Amadeus Quartet. DEUTSCHE GRAMMOPHON DGG 138 531/2/3 three 12-inch discs \$17.94, 18 531/2/3* \$14.94.

Interest: Classic masterworks
 Performance: Devoted
 Recording: Appropriate
 Stereo Quality: Refined

Collectors of the recorded string quartets of Beethoven can rejoice at the news of this superb realization of the six quartets of Opus 18. For the Amadeus Quartet and DGG's engineers have clearly left behind the available competition—the Budapest included.

These readings are, unsurprisingly, beautifully finished, elegantly detailed, and superbly controlled. But beyond that, the Amadeus musicians have sought and found a romantic warmth and expressivity that one does not always encounter in performances of these relatively early masterpieces. But this expressivity never seems arbitrarily superimposed, for the larger structural considerations emerge perfectly clear.

The recording is cleanly detailed at all times. *W. F.*

BERLIOZ: *Cléopâtre* (see RAVEL).

© ® BRAHMS: *Piano Concerto No. 1, in D Minor, Op. 15*. Clifford Curzon (piano); London Symphony Orchestra, George Szell cond. LONDON CS 6329 \$5.98, CM 9329* \$4.98.

Interest: *Sturm und Drang*
 Performance: Craggy
 Recording: Massive
 Stereo Quality: Good

This recording is Szell's third disc appearance as conductor-collaborator in this mighty work of the youthful Brahms: the first was on 78's with the great Artur Schnabel, the second some five years ago with the then fast-rising and now solidly established Leon Fleisher.

Curzon and Szell, both formidable interpreters of the Brahms idiom, choose in this new recording to stress the dark and craggy qualities of the music, as did Schnabel and Szell. But the musical substance is sufficiently fierce and murky that it needs no further underlining by the interpreters. Thus a rhythmically dynamic reading with emphasis on the flow of melodic line, such as that by Fleisher and Szell, gives the music greater impact. The Epic Fleisher-Szell disc holds its own very nicely, even against London's imposing technical achievement. So the choice of this newest recorded performance, as against Fleisher-Szell or Rubinstein-Reiner on RCA Victor, is a matter of preference in interpretation. *D. H.*

RECORDING OF SPECIAL MERIT

© ® BRAHMS: *Symphony No. 3, in F Major, Op. 90; Tragic Overture, Op. 81*. Pittsburgh Symphony Orchestra, William Steinberg cond. COMMAND CC 11015 SD \$5.98, CC 11015* \$4.98.

Interest: Solid Brahms package
 Performance: First-rate
 Recording: Likewise
 Stereo Quality: A-1

William Steinberg's traversal of the Brahms orchestral repertoire for Command has resulted here in readings of the Third Symphony and the *Tragic Overture* that go to the top of the list, both musically and sonically.

Both the symphony and the overture are endowed with ample weight and momentum throughout their *allegro* episodes, and the lyrical moments are handled with finesse of line and intensity of expression. Special praise must go to Steinberg for the splendidly weighty brass and bass line he brings to bear in the great antiphonal passage that paves the way for the fourth-movement climax. And Command's recording likewise does the music superb justice.

(Continued on page 62)



classics

Reviewed by WILLIAM FLANAGAN • DAVID HALL

GEORGE JELLINEK • IGOR KIPNIS

Explanation of symbols:

- Ⓜ = monophonic recording
- Ⓢ = stereophonic recording
- * = mono or stereo version not received for review

Ⓢ Ⓜ **BACH: *Mass in B Minor***. Eleanor Steber (soprano), Rosalind Elias (contralto), Richard Verreau (tenor), Richard Cross (bass-baritone); Temple University Choirs, Robert E. Page, director. Philadelphia Orchestra, Eugene Ormandy cond. COLUMBIA M3S 680 three 12-inch discs \$17.94, M3L 280 \$14.94.

Interest: Bach pinnacle
 Performance: Large-scale
 Recording: Commendable
 Stereo Quality: Effective

Ormandy's conception of the Mass in B Minor is in the American choral tradition, with typically large-scale forces. Yet, in spite of long-line phrases and the excessive sonic weight of the many participants, this brightly paced interpretation is far less romantic than other nineteenth-century-style performances. It is quite obvious that the conductor has thought very carefully about the score: for example, he adopts a faster, gigue-like tempo for *Et in Spiritum Sanctum*, which helps to point up the symbolic significance of the important triplets. There are no excesses in this reading—Ormandy avoids extreme cadential retards, for instance—and the work of the solo instrumentalists and the chorus is outstanding. None of the vocal soloists is particularly distinctive. Collectively they display a combination of faults—scooping, less-than-accurate intonation, lack of color, and some unfortunate effects of limited vocal range (mezzo-soprano Rosalind Elias, for instance, struggling with the contralto tessitura). The recording is commendable, particularly in the stereo version, which helps greatly to clarify the massed sonorities in the somewhat distant sonic perspective. Good use, too, is made here of the separation of the two choirs for the Sanctus and Hosanna. DGG's recording, with the Munich Bach Choir and Orchestra under Karl Richter (ARC 73177/8/9 stereo, 3177/8/9 mono), is still the most splendid performance in

the proper Baroque style, but if you prefer an American traditional version, the present recording can be considered one of the best. Texts and a musical analysis by Sir Donald Tovey are included. *I. K.*

RECORDING OF SPECIAL MERIT

Ⓢ Ⓜ **BACH: *Organ Music: Passacaglia in C Minor* (S. 582); *Toccata and Fugue in F Major* (S. 540)**. Heinz Wunderlich (Arp Schnitger organ of St. Jacobi Church, Hamburg). CANTATE 640 206 \$5.95.

Ⓢ Ⓜ **BACH: *Organ Music: Partita "Sei gegrüßet, Jesu gütig"* (S. 768); *Prelude and Fugue in E Minor ("Wedge")* (S. 548); *Toccata and Fugue in D Minor***



COLUMBIA RECORDS

EUGENE ORMANDY
American-style Bach without excess

(S. 565). Heinz Wunderlich (Arp Schnitger organ of St. Jacobi Church, Hamburg). CANTATE 640 207 \$5.95.

Interest: Organ staples
 Performance: Extremely solid
 Recording: Extraordinarily vivid

Good as is the New York instrument on which Carl Weinrich plays a similar program, that excellent example of today's trend in building organs along Baroque principles must defer to the real thing. The large organ of the St. Jacobi Church

in Hamburg was constructed in the late seventeenth century by the renowned Arp Schnitger (one of the stops, in fact, can be traced to the early sixteenth century), and in spite of periodic repairs and wartime damage, the instrument, properly restored in 1959, sounds much the way it must have in Bach's time. Although Heinz Wunderlich does not have the dramatic imagination and rhetorical brilliance of Helmut Walcha, whose Archive recordings are still the readings I prefer, he is certainly a convincing performer, with fine articulation, a first-rate technique, and a splendid sense of registration. Both the Passacaglia and the early Chorale Partita are particularly impressive, but the real joy of these two discs is the vivid, clean reproduction of the splendid instrument, most notably on the first record. *I. K.*

Ⓢ Ⓜ **BARTÓK: *Divertimento***. VIVALDI: *Concerti Grossi Nos. 10 and 11*. Moscow Chamber Orchestra, Rudolf Barshai cond. LONDON CS 6332 \$5.98, CM 6332* \$4.98.

Interest: Mellow music-making
 Performance: Fine
 Recording: Splendid
 Stereo Quality: Excellent

This peculiarly Russian approach to the work of Béla Bartók is quite different from the one we in the West are most familiar with. The men from Moscow press the lyrical and expressive aspects of the music while minimizing its harmonic astringency and rhythmical asymmetry. I am not certain that this approach is quite truthful to the music, but it is pleasant to hear it sounding so natural and easy.

The Vivaldi performances are full of warmth and mild romanticism. The playing on the entire record is, as a matter of fact, quite remarkable for its poise and easy grace. And it is good for a change to hear a Russian instrumental group in terms of the advanced recording techniques that London provides. *W. F.*

RECORDING OF SPECIAL MERIT

Ⓢ Ⓜ **BEETHOVEN: *An die ferne Geliebte, Op. 98***. SCHUMANN: *Dichterliebe, Op. 48*. Ernst Haefliger (tenor);

COLUMBIA RECORDS

The Sound of Genius

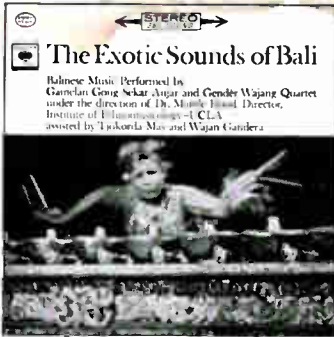

The traditional music of a fabled island offers a wealth of exciting and unusual new sounds.



Mezzo-soprano Jennie Tourel joins Leonard Bernstein and the New York Philharmonic in definitive performances of Berlioz' rarely heard Cléopâtre and Ravel's unique song cycle, Shéhérazade.

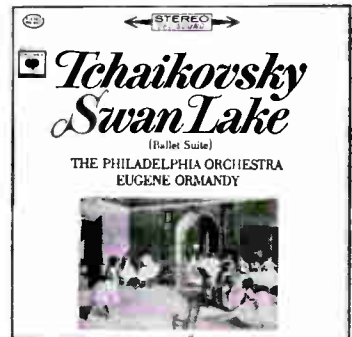

Eugene Ormandy and The Philadelphia Orchestra offer an exhilarating interpretation of one of the masterpieces of the ballet repertoire.



Leonard Bernstein introduces the world of classical music to young people - Strauss: Till Eulenspiegel's Merry Pranks/ Debussy: Afternoon of a Faun/ Copland: El Salón México/ Tchaikovsky: Six Dances from The Nutcracker Suite.



Virtuoso Gary Graffman lends a dazzlingly fresh sound to the brilliant, thundering piano works of Prokofiev and Rachmaninoff.



Shostakovich's brilliant, controversial Symphony No. 4 in its American recording premiere—performed with color and excitement by Eugene Ormandy and The Philadelphia Orchestra.



© COLUMBIA MARCAS REG. PRINTED IN U.S.A.

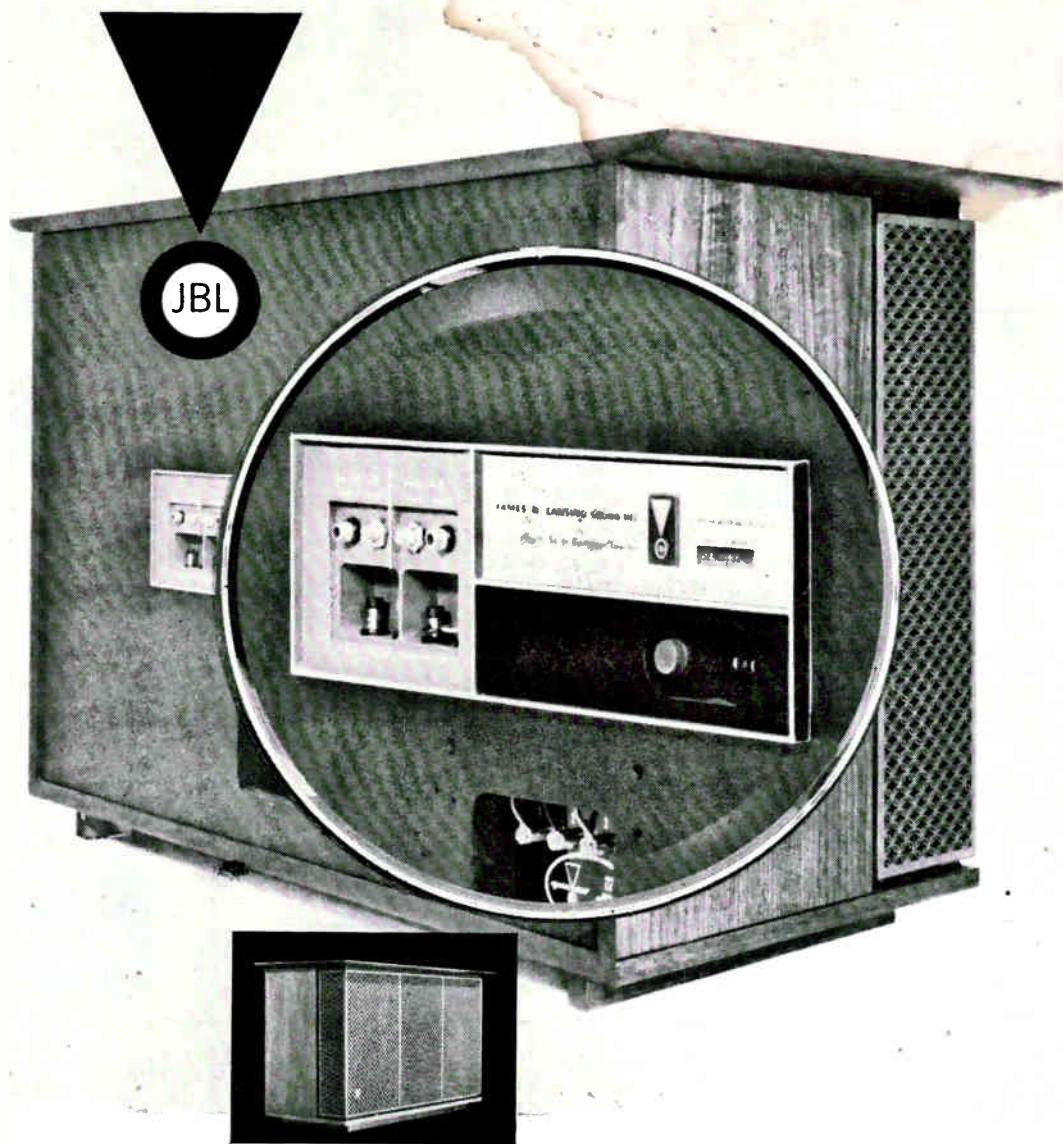

*JBL PRESENTS THE SOLID STATE **ENERGIZER/TRANSDUCER***

With the Energizer/Transducer, JBL brings you another giant stride closer to perfect audio realism. Now you can have a JBL precision transducer with its own built-in power mate. By engineering the transducers, power source, and enclosure as an indivisible entity, the designers have complete control over every facet of the reproduction system. They have discretion over any band of frequencies, can govern the size and shape of a single cycle if they so will. Consequently, in the JBL Energizer/Transducer the amplified signal is precisely tailored to the requirements of the entire system. The music you hear is the most exact replica of the original performance yet achieved. Built entirely of solid state devices, the energizer is devoid of microphonics, produces negligible heat, and therefore can be mounted within the acoustical enclosure. Due to their tight electrical and mechanical coupling, JBL transducers reproduce the steepest musical wave fronts with an accuracy, alacrity, and facility that is unique among loudspeakers. The energizer has the ability to amplify square waves perfectly. The combination of these two features results in system transient response that has never been equalled. Hum is extinguished. Distortion in any form approaches the vanishing point. Frequency response is flat. Sound pressure reserves are available that you will never use even in your most avid listening sessions. Initially, JBL self-powered loudspeakers are offered in E/T Olympus, E/T Apollo, and E/T Lancer 66 models. Telephone the JBL Franchised Audio Specialist in your community; arrange for a protracted audition; be sure to compare what you hear with conventional loudspeaker and amplifier systems. Write for complete information.

JAMES B. LANSING SOUND, INC., LOS ANGELES 39, CALIFORNIA

CIRCLE NO. 56 ON READER SERVICE CARD

Island Line and the swelling mood of expectancy in *On a Christmas Day*. Yet, on other subjects, he was much more sophisticated than any of his city admirers.

Leadbelly's voice was hard and cutting, but it was also hot in texture—in like manner, one speaks of the heat of jazz trumpeter Roy Eldridge's whiplash sound. His voice, in fact, often resembled an instrument, and this can be heard here in the staccato, percussive vehemence of *The Eagle Rocks*. Above all, an irrepressible vitality and hunger for experience pervaded Leadbelly's music. He was a man who was totally alive, and in these recordings, his enormous capacity for living at full emotional speed is vividly and persistently evident.

Nat Hentoff

© HUDDIE LEDBETTER: *Leadbelly*. Huddie Ledbetter (vocals, guitar, piano). *Grasshoppers in My Pillow; Ella Speed; Tell Me, Baby; Western Plain; Good Night, Irene; Backwater Blues*; and six others. CAPITOL T 1821 \$3.98.

ECHT BRECHT

A congeries of works by a tough-minded, warm-hearted genius

IN ORDER TO CAPTURE the ambiance of the off-Broadway production of *Brecht on Brecht*, Columbia placed all the resources of the recording art at the disposal of the original cast, and the result is an exemplary re-creation of the stage work. At the Theatre de Lys in New York, the actors operated from barstools, offering a parti-colored collage of Bertolt Brecht's songs, verses, bright sayings, and scenes from plays, while the creator himself stared down out of a gigantic photograph, smiling like the Mona Lisa and looking vaguely like Gertrude Stein with a cigar. This setup is reproduced on the album cover, and on the two records are almost all the original numbers (additions and deletions were made during the work's long run) with a few disappointing exceptions. If you're waiting eagerly, for example, to hear Lotte Lenya sing *The Black Freighter* from *The Three-penny Opera* (this invariably brought down the house), I am sorry to report that she doesn't. Also missing are the scenes from the plays *Galileo* and *The Good Woman of Setzuan*. There are, however, more than forty other items, all of them fasci-

nating and well done. The program opens and closes with an old sound track of Brecht himself singing his *Moritat (Mack the Knife)* in a voice like a weather-beaten reed organ. There are devastating excerpts from Senate committee hearings in which you can hear Brecht, who would never be pinned down politically ("I am a writer, not an underwriter"), gently putting some bullying investigator in his place. There is even an incredible passage in which a Senator draws one of the writer's own verses back at him, trying to read into it some revolutionary plot. There are eleven numbers performed by Miss Lenya, every one of them a high point, the highest being the *Song of a German Mother* from *Mother Courage*.

The longest number is *The Jewish Wife*, in which Viveca Lindfors and George Voskovec wring your heart out in the poignant playlet about a woman preparing to leave Germany in the early days of the Hitler regime. Astute and witty excerpts from the author's letters and essays fill in the portrait of this blindingly brilliant, tough-minded but warm-hearted genius whose life stands as disproof of the cynicism that often overcame him—though bitterness never did—at a time when mankind in Europe was furiously busy perfecting its inhumanity. The sentimentality of such set propaganda pieces as *Concerning the Infanticide of Marie Farrar*, for example, with its masochistic emphasis on pain, points up his susceptibility to the sick colors of German Expressionism, despite the restraint and care of Anne Jackson's delivery. But this quality is offset by the lusty humor, simplicity, and sharp insight displayed over and over again in the verses, vignettes, and ironic ballads by an author who summed up his own ambitions simply: "To write, to plant, to travel, to sing, to be friendly."

Technically, the recording is spacious and alive. Stereo offers a real sense of stage movement and contrast, and the full flavor of first-rate performances by six superlative players. The album is a landmark in capturing the quality of an evening in the theater, and it should pave the way for a greater appreciation of Brecht as a poet, a playwright, and a man.

Paul Kresh

© BRECHT ON BRECHT. Dane Clark, Anne Jackson, Lotte Lenya, Viveca Lindfors, George Voskovec, Michael Wager (players). George Tabori, arranger and translator. Gene Frankel, director. COLUMBIA O2S 203 two 12-inch discs \$11.94, O2L 278* \$9.94.

only as they yearn upward into the encompassing dark. Another tired cliché dissipated in this recording is the one about Schubert's unconscionable length. Paderewski used to make us forget it by the sheer drama of his personal involvement. In the G-flat *Impromptu*, Mr. Horowitz makes us forget it by playing this noble melody with the unembarrassed total commitment of a first love letter.

Mr. Horowitz's Scarlatti (do I remember somebody calling it stylistically unorthodox?) has always been a sensuous delight. But now, strange as this may sound, it has become a sort of moral epigram as well, pregnant with unsuspected meanings. It exists in the unapproachableness of a final, flawless perfection; when Mr. Horowitz concludes the Sonata in G Major, most of us can only be grateful that we are not public performers. There would seem very little left to do but jump.

Although I cannot imagine any musical community where this would still be news, there is simply nobody else around who produces his kind of tone from a piano. The piano, you'll recall—the physicists keep reminding us of it—is only a machine: it makes exactly the same kind of noise if you hit a key with an umbrella tip as it does when you use your finger. I recommend that all such theorizers hear this recording. The burden of proof is now theirs.

Robert Offergeld

© THE SOUND OF HOROWITZ: Schumann: *Scenes of Childhood, Op. 15; Toccata, Op. 7. Scarlatti: Sonata in E Major (L. 430); Sonata in A Major (L. 483); Sonata in G Major (L. 209).* Schubert: *Impromptu in G-flat Major, Op. 90, No. 3.* Scriabin: *Poem, Op. 32, No. 1; Etude in C-sharp Minor, Op. 2, No. 1; Etude in D-sharp Minor, Op. 8, No. 12.* COLUMBIA MS 6411 \$5.98, ML 5811 \$4.98.

* ENTERTAINMENT *

FULL-STRENGTH LEADBELLY

*An authentic folk instrument.
hot, hard, and cutting*

HUDDIE LEDBETTER was the most forceful of all the phenomena of American folk music in the 1930's and 1940's. After working years in the cotton fields, strutting through the Dallas underworld, and serving time in prison for murder, Leadbelly was introduced to urban audiences by the late John Lomax and his son Alan.

Before his death in 1949, Leadbelly had acquired a formidable reputation as a searing singer and a virtuoso of the twelve-string guitar. Some of his most memorable recordings, made for Capitol in 1944, have not been available for some time. Now, in "Leadbelly," a dozen full-strength tracks of his music have been reissued, and they constitute an indispensable album for a folk collection.

The recordings are a cross-section of Leadbelly's richly diversified repertoire. All come so deeply from his own experience and observation that they illuminate by contrast the artificiality of some of our latter-day John Henrys in silk sport shirts. *Take This Hammer*, for example, echoes the sound and ache of real work. The ragtime piano in *The Eagle Rocks* and *Eagle Rock Rag*, in contrast, conjures up the drive for quick pleasure in ghetto saloons. There are also mordant blues, and blues that are more wistful than bitter, such as *Sweet Mary Blues*. At times, Leadbelly communicates a childlike clarity and vividness of imagination, as in the conversation between the train and the depot agent in *Rock*



COLUMBIA RECORDS

VLADIMIR HOROWITZ
Who would compete with perfection?

absorbing study of the many and varied elements that make up the figure of Boris: nobility, tenderness, cruelty, vision, and obsessive fear. In startling contrast are his sparsely drawn but no less brilliant portrayals of the gentle Pimen and the boisterous Varlaam. The result is an astounding tour de force.

Thoughtful casting has paired each colorful character in Moussorgsky's sonic panorama with appropriately skillful interpreters. Mela Bugarinovitch (the Nurse), Kiril Dulguerov (the Simpleton), and John Lanigan (Shuisky) are particularly outstanding, and so is Evelyn Lear as Marina, despite the fact that her voice lacks the dark coloration and amplitude generally associated with the part. I care less for the Dimitri of Dimitr Ouzounov, whose singing is powerful but rather crude.

Stereo's resources have been put to the best musical ends without overindulgence in gimmickry. There is effective separation of choral voices and clarity of orchestral detail, and the stereo channels are imaginatively employed, particularly in the Inn Scene and in the Kromy Forest episode. That episode, incidentally, is placed *before* the death of Boris, as it was in the Capitol mono recording. The new version is more complete: Pimen's first-act monologue has been expanded, and the scene of the confrontation of Dimitri by Rangoni, missing in the Dobrowen set, has been restored.

George Jellinek

© MOUSSORGSKY: *Boris Godounov*. Boris Christoff (bass), Boris Godounov, Pimen, and Varlaam; Ana Alexieva (mezzo-soprano), Feodor; Ekaterina Gueorguieva (soprano), Xenia; Mela Bugarinovitch (mezzo-soprano), Nurse; John Lanigan (tenor), Prince Shuisky; Dimitr Ouzounov (tenor), Grigory and Dimitri; Evelyn Lear (soprano), Marina; Anton Diakov (bass), Rangoni; Milen Paounov (tenor), Missail; Mira Kalin (mezzo-soprano), Hostess; Kiril Dulguerov (tenor), Simpleton. Chorus of the Sofia National Opera, Luben Kondov director; Paris Conservatory Orchestra, André Cluytens cond. ANGEL S 3633 four 12-inch discs \$23.92, 3633* \$19.92.

HOROWITZ AS A MATCHLESS LYRIC POET

A noble pianistic testament from Romanticism's heir and oracle

AFTER AN absence of four years from recording, Vladimir Horowitz returned last fall with his first release

on the Columbia label. I felt at the time, as did some others, that if recordings ever received the attention given Carnegie Hall concerts, the public rejoicing might well have equalled the *éclat* of Mr. Horowitz's unforgotten debut in 1928. All the much-discussed demonic energies noted at that earlier event are still at his command, but the musical will directing them has arrived at a perfect self-mastery. The result is a kind of serenely glowing eloquence unmatched in modern pianism.

A second Columbia recording has now appeared, "The Sound of Horowitz," containing works by Scarlatti, Schubert, Schumann, and Scriabin. Responsible parties in and about the industry—not Columbians, as it happens—are already claiming that this second album is "better than" the first. I wouldn't begin to know how they can tell. It is bad enough to make great pianists weigh in like rival prizefighters, but it is sheer lunacy to make a Horowitz compete with a Horowitz. In the first recording he was obviously an emperor restored to his throne *en grande fête*. In the second, he is not *a* poet, but *the* poet, uniquely personified, of mid-nineteenth-century Romanticism. Times change; nobody susceptible to the emotionally charged lyricism of this playing can be unaffected by the thought that if Mr. Horowitz is the greatest of Romantic pianists, he may very well also be the last. Others will unquestionably play this music and play it well, but that is a different thing from being its dynastic heir and oracle.

Meanwhile, Mr. Horowitz reminds us that Romanticism has its virility as well as its tears. He turns from the dream-haunted garden of Schumann's *Kinderszenen* to the same composer's *Toccata* with a crash of exultant sound that is like the very war-whoop of a bygone youthful idealism. Obviously he is mowing down Philistines in windrows, and the celebrated technical difficulties of this piece expire in a blaze of crackling sound, a kind of victory bonfire surrounded by prancing heroes.

The confessional aspects of late Romanticism probably reached their greatest intensity in the music of Scriabin, represented here by a *Poem* and two *Etudes*. Like some of Rachmaninoff's, Scriabin's more impassioned night thoughts have often been accused of lacking architecture, but Mr. Horowitz has other ideas about this. As in a night scene lit by torches, we become aware that Scriabin, too, raised great arches of beautifully ordered sound, their dim forms dissolving

BEST OF THE MONTH



CLASSICAL

CLUYTENS FORGES A SWEEPING AND GRANDIOSE *BORIS*

Perceptive characterizations by Boris Christoff in a triple-role tour de force

EVEN UNDER ideal conditions, the recording of a topflight *Boris Godounov* is a monumental task. Now consider the project undertaken by Angel: involving a French conductor and orchestra, an international cast of singers, and the chorus of the Sofia National Opera, it was nothing less than a hazardous test of East-West co-existence.

COLUMBIA RECORDS



BORIS CHRISTOFF

Brilliantly penetrating portrayals

And so it is especially gratifying to report that the result is a brilliant performance. Although some will regret that Moussorgsky's original orchestration—or a version reasonably close to that original—continues to be missing from records, Angel here makes a strong case for the Rimsky-Korsakov edition by revealing its sonorities in their fullest splendor.

This is as authentic-sounding a performance of *Boris* as one could ever hope to hear outside Russia, and it has the kind of singing even the Bolshoi's audience can hear only on exceptional occasions. The Bulgarian choristers display superb depth and discipline, and with them and the excellent orchestra as his foundation, André Cluytens forges a sweeping and grandiose tonal structure. Only the Polish episode, Act Three, Scene One, is not all it could be: the late Issay Dobrowen imparted a greater sense of urgency to this music, and elicited a more exciting performance from his singers in the fine Capitol set (GDR 7164).

Again, as in Capitol's recording, Boris Christoff dominates the performance with his triple-role virtuosity. His voice has become somewhat tubbier in the intervening years, and he no longer manages his high notes with the baritone-like ease of old. But what a penetrating and perceptive portrayal this is, what an

(continued overleaf)



S&Q

SOUND AND THE QUERY

PRACTICAL POINTERS ON THE INSTALLATION AND MAINTENANCE OF HOME MUSIC SYSTEMS

BY LARRY KLEIN

I Hear Music . . .

Q. Lately I've noticed that when I lift my tone arm to put it on the record I hear music. This music is heard only with headphones; it is very faint and does not interfere with the playing of the record. The tuner is not on at the time, nor is any other radio playing in the house. What causes this?

JEAN SOOS
South Bend, Ind.

A. The music you hear results from detection and amplification of a radio signal (AM, FM, or even TV sound) by your amplifier. This phenomenon is akin to the principle of the old-time crystal set, which depended on the same type of detector. An oxidized contact somewhere in the area of the cartridge-input circuit may be acting as a crystal rectifier for radio signals. Another possibility is that one of the preamp tubes in your amplifier is operating as a detector because of a slight shift in its operating bias. In any case, the rest of your amplifier serves to boost the signal to a level just high enough to be audible in the phones.

Changes and Modifications

Q. I have an imported tape recorder that sells for about \$75. I would like to add a VU meter to it and improve its frequency response, speed regulation, and wow and flutter figures. Do you have any suggestions as to the best way to go about it?

JOHN THOMPSON
Boston, Mass.

Q. I have a \$300 radio console that does not give me hi-fi results. What components must I change to get good sound?

BETTY WILDER
Skokie, Ill.

A. I have grouped these two questions because they are typical of a large number of those addressed to this column. First of all, let me say that it is possible for certain changes and modifications to be made. However, unless the parties have the time, money, and test equipment necessary, it is just not a feasible proposition. In

addition, a major redesign or modification of audio equipment requires a know-how approaching that possessed by a design engineer. The tape-recorder modification, for example, would require a complete redesign of the electronics, transport mechanism, and probably a new motor.

The console radio is probably a lost cause in that each component in the set was designed to a minimum. Upgrading any one aspect of the console would probably do nothing more than expose the inadequacies of the other sections.

Woofer and Tweeter Controls

Q. I want to be able to balance the speakers of my three-way system. There seem to be conflicting opinions as to the best type of controls to use. Would a T-pad, an L-pad, or a simple potentiometer be best?

CHARLES PREVINE
Los Angeles, Calif.

A. To control the volume of one speaker, if it is the only one connected to your amplifier, the three-section T-pad is theoretically preferred. The T-pad, throughout its control

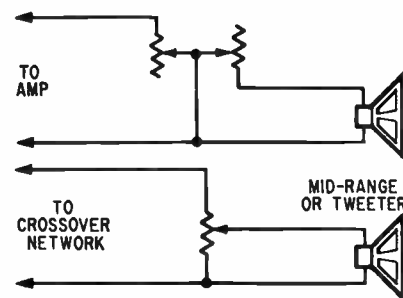

range, permits both speaker and amplifier to "see" their approximate rated impedance. The two-section L-pad is designed to maintain the match at the amplifier only. However, since both the T-pad and the L-pad will affect your amplifier's damping factor, their use should be avoided with high-quality, full-range speakers and with woofers.

As far as two- or three-way speaker systems are concerned, since the amplifier's damping factor has already been lowered by the crossover network, you have a choice between the L-pad and the less expensive potentiometer for

controlling the level of the mid-range and tweeter. The pad should have an impedance matching that of the speaker; the potentiometer should be about 50 ohms for a 16-ohm speaker and 25 ohms for an 8- or 4-ohm speaker. The pad or the potentiometer—whichever is used—should be connected between the crossover and the speaker.

50-Cycle Operation

Q. I'm contemplating a move to the Netherlands, where the standard current is 220 volts, 50 cycles. I have checked on the speed conversion for my turntable and tape deck, but I want to know whether the rest of the components will be affected, provided I buy an a.c. stepdown transformer of sufficient wattage to take care of the total power requirements of the system.

LT. REINIER E. VOUTE
San Antonio, Texas

A. If the power-supply filtering is marginal in your tuner, preamp, or amplifier, there may be a slight increase in hum. In that case, have a serviceman install additional filter capacity. At 50 cps, the power transformers in your equipment may run somewhat warmer, so be sure there is adequate ventilation.

Turntable-Motor Hum

Q. Recently I installed a new stereo cartridge, and now I notice that my new setup is picking up hum from the turntable motor. Should I replace the motor?

HOWARD H. VOLAN, M.D.
Syracuse, N.Y.

A. There are four basic factors that determine whether a turntable will induce hum in a cartridge:

1. The type of motor and the degree to which it generates a 60-cycle hum field around it.
2. The shielding of the motor.
3. The location of the motor in regard to the arc travelled by the cartridge when tracking the record.
4. The cartridge's hum-susceptibility.

It is not likely that a new motor installed in your turntable would improve the hum situation. And if you are contemplating installing a motor other than that provided by the manufacturer, you may run into problems of motor speed, mounting, etc. If relocating the tone arm so that the cartridge does not travel over the turntable motor doesn't help, write to the manufacturers for their suggestions for a solution to your problem.



INSTALLATION OF THE MONTH

END-TABLE STEREO

puts the controls in the listening area

WILLIAM COLBERT, a long-time audiophile and the president of the Audio Exchange, Inc., in Jamaica, N. Y., spent something like two years experimenting with various hi-fi setups before he achieved his present installation. The problem, as Mr. Colbert saw it, was to maximize operating convenience. It was mandatory, he felt, that all controls (including the antenna rotator's) should be within arm's reach of his listening position. This arrangement avoids a common situation in which the operator must adjust the controls in one part of the room and then go to another part for listening.

Eschewing the conventional console or bookshelf installation, Mr. Colbert installed his components in an end table. The McIntosh MX-110 proved ideal for serving as the heart of the setup, since it combines

the functions of a stereo tuner and a preamplifier-control center, permitting a consolidation of two separate components. The stereo power amplifier (a Marantz 8B) is not only out of sight—it reposes in the garage adjacent to the house. The record player, located immediately behind the MX-110 tuner-preamp, is a Thorens TD-124 with a Grado arm and new Mk I cartridge. A Tandberg Model 64 stereo tape recorder alternates as a program source.

In the picture above, the living-room couch, which is normally fronted by the cocktail table, has been removed to show the equipment. At the far end of the room, facing the sofa, is the KLH Model 9 electrostatic speaker system. Although Mr. Colbert is the proprietor of the Audio Exchange, he does not contemplate trading in any of his equipment at this time.

RECORD COMPANY



Luckily, the works of Joseph Haydn are in the public domain, so you don't have to pay a composer's royalty. So your total production costs for one thousand records (subtracting the advance to the conductor, since you're taking into account his royalty) is \$10,068—or \$10.07 per record. Your records will sell to the consumer for \$4.98 mono and \$5.98 stereo, thus leaving you not much chance of making a profit on the first thousand. You will sell to the distributor at \$2.18 mono, \$2.62 stereo—roughly a \$7.60 loss on every record sold. Eventually, this may turn into a profit—if you sell eight thousand records, maybe.

Let's leave the records on the shelf for the moment, and think about telling your potential market of your existence. Basically, there are four methods: direct-mail, press releases, reviews, and advertising. Since you plan to sell through stores, the first of these is out, financially infeasible even for the largest companies. Your press releases have presumably been sent out already. They may or may not get printed, but at any rate they will be noted more by dealers than by consumers. Review copies, of course, go out as soon as the records are produced, but reviews will not appear for at least a month, and frequently not for six or seven months. Many are cast on barren soil and net you nothing but another loss—review records cost money, too.

It is when he reads the reviews of his own product that a record producer first becomes aware of the multiple dangers to which a record's reputation is subject. Most people seem to be completely unaware—to use a handy cliché—of what you were trying to do. Perhaps most frustrating is the critic who comments favorably on all specific aspects of the record, but concludes that, on the whole, and for some unknown reason, he feels it could have been done better, or he simply doesn't like the music.

Your advertising, at this point, is two months behind. No campaign has been planned because up to now you could never see the necessary two months ahead just when the records might be in the stores, nor which stores they might be in. Let's reverse our previous method of cost determination, and start out with a fixed sum allocated for advertising, say \$10,000. What can you buy for it? Not much—maybe three pages in record-review magazines, one in a metropol-

itan newspaper, and half a page in one of the smaller mass-circulation magazines. You'll have to weigh the advantages of single-insertion large ads against multiple-insertion small ones. Either way, it adds up to a less than major assault on the public consciousness. If you've been thinking of the big, mass-circulation (six million or so) magazines, forget it: one page would cost three times your entire advertising budget.

Now, product in hand, advertising campaign vaguely in mind, you can approach your first distributor. Comes the inevitable question: "Why should I carry your line?" You'd better have the answer in your hip pocket. This is not a time for mistakes or uncertainty. What is it about your record that makes it different, better, and more saleable than the other seven thousand classical discs in the catalog? Have you improved recording techniques? Are you prepared to spend a king's ransom in advertising? Do you have a great performance? Is your packaging notably superior? One can improve records at any and every stage of production, but those who have done so find themselves sobered by the task. Quality is improved in steps, in an arithmetical progression—2, 3, 4, 5, and so on—but the cost of improvement goes up in a geometrical progression—2, 4, 8, 16, and so on.

But whatever you did, and however you did it, you will have a market. It won't, however, be a private little market of ten thousand, tucked away out of reach of everyone else. You will be competing with every other record company in quality, salesmanship, price, advertising, reviews, packaging, distribution, gimmickry, names, and repertoire.

BY THE way, how are your second, third, and fourth records coming along? You haven't started them yet? You're waiting for the money from the first to be able to do them? I hope not. The production costs for twelve records are twelve times the production costs for one record. The overhead costs—rent, telephone, secretary, lawyer, equipment, stationery, accountant, office supplies, corporation taxes, etc.—for one record are the same as for twelve. Of such minor mathematics are major disasters made.

A record company, then, cannot be started. It must spring into being full-grown, like Minerva from the head of Jupiter, exerting force in all directions at the instant of its creation. If you want to play Jupiter, go ahead. I hope you make it. I hope I do.

James Goodfriend, a former free-lance writer and magazine editor, is a co-owner of Connoisseur Records, a new record company that in the past few months has issued a series of 12-inch 45-rpm stereo records that have received wide critical approval.

started work on the package. The simplest possible record jacket uses a picture and title on the front, and liner notes on the back. It will cost about 6¢ for construction in large runs. Production requires the services of a writer, an artist or photographer, an art director and designer, a typographer, one or more printers, perhaps an engraver, a paper-supply house, a secretary, and you and your partner—to do the menial tasks, keep an eye on the operation, and try to cram the job into three or four months' time.

At some point, the record presser will be calling for labels, and you will have to have them ready. Again, a panel of craftsmen is needed, including a man whose function it is to make straight letters curve—record labels are round, and typesetters work in straight lines. Another bill—\$50, maybe.

THE record producer must know his materials, but more important, he must know his suppliers—their overstatements, understatement, carelessness, timing inaccuracies, pressures, and what-have-you. Since you are a producer of classical records in necessarily small quantities, you are in a bad position to bargain. You must therefore master the techniques of flattery, cajolery, patience, hysteria, and threat of nonpayment—all of which will come in handy later in dealing with distributors and dealers. High prices, slow delivery, and less-than-acceptable workmanship are common. The producer may have to put up with the vagaries of four or five suppliers of an item before finding one who

can give him what he wants, when he wants it, at a price he is willing to pay. He may never find one.

But let's assume that five or six months have passed and you have now produced your record. Sporting new jackets, one thousand bright copies, five hundred each, stereo and mono, are sitting on your shelf. Here's what they have cost you, excluding the price of your recording equipment.

| | |
|--|-------------------|
| RECORD PRODUCTION | |
| Mastering and plating (stereo and mono) .. | \$ 240.00 |
| 1,000 pressings (including labels) | 420.00 |
| ALBUM PRODUCTION | |
| Original cover art or photograph | 100.00 |
| Typography (cover, liner, and label) | 130.00 |
| Layout and design | 150.00 |
| Four-color cover plates and separations .. | 500.00 |
| Extras (curvature, label plates, etc.) | 100.00 |
| Liner notes | 50.00 |
| 1,000 printed covers | 50.00 |
| 1,000 albums, including liners | 65.00 |
| TOTAL | <u>\$1,805.00</u> |

You will have taxes and royalties to pay on every record sold, and so you should include them as part of your cost:

| | |
|--|-----------------|
| 7½ per cent conductor's royalty on 1,000 records (calculated on 90 per cent of the list price) | \$369.90 |
| Excise tax (calculated on the wholesale price) | 240.00 |
| AFM pension fund (calculated on list price) .. | 158.92 |
| TOTAL | <u>\$768.82</u> |

(Continued overleaf)

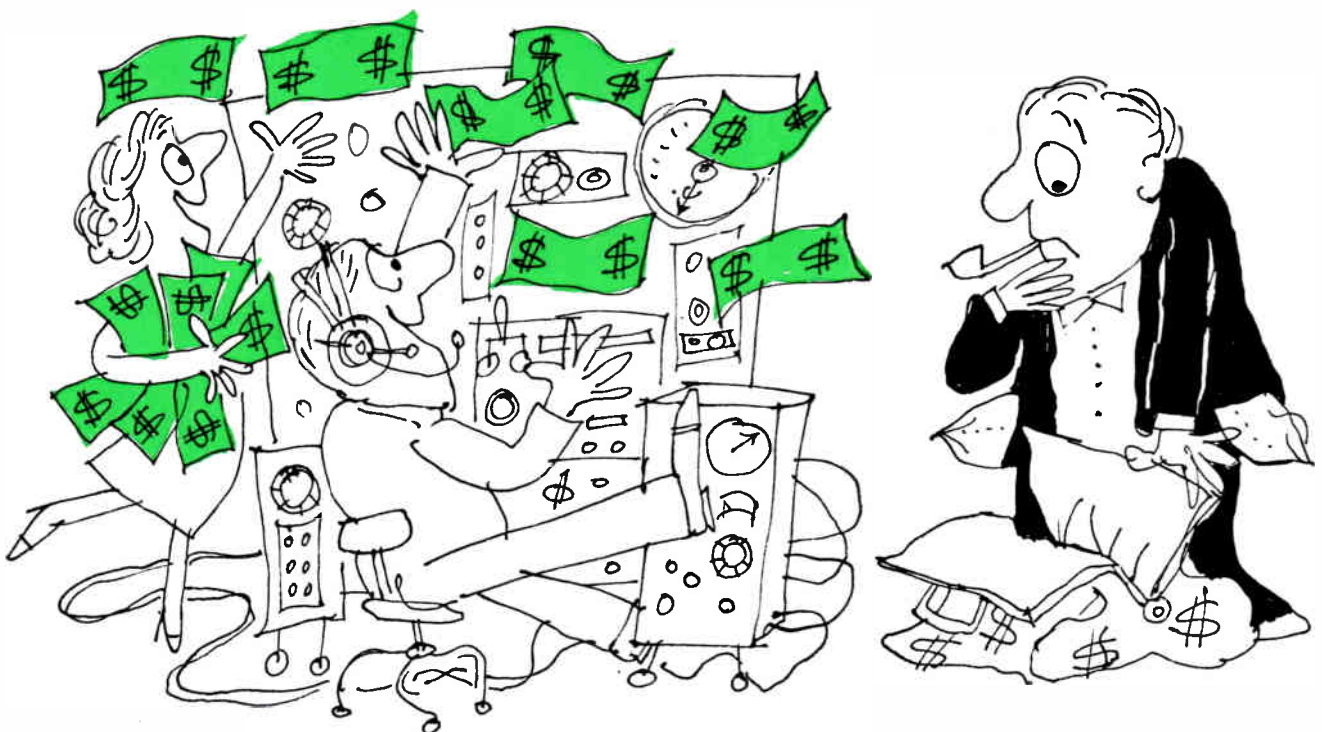

RECORD COMPANY

\$5,000. You would also have taken your second step toward reducing sales. Of course, the whole thing can be done in Vienna at a fraction of the cost. But whom do you know in Vienna? How do you get musicians? Do you speak German? What is the cost of transportation? How do you get the tapes back into the United States? There are answers to these questions, but you are not in a position to know all of them. So you've spent \$7,500 on a recording session. If you haven't done so already, you may now take a Compazine.

Anyone's first recording session is a harrowing experience. It can take hours to achieve correct microphone placement and balance. Once into the recording proper, every passage, every note must be tagged—by you, and in writing—as usable or unusable. Records are not concert performances; wrong notes and bad ensemble playing are not allowed. Your degree of concentration must be intense if you are not to panic later in the editing room. You emerge from a recording session with a collection of bits and pieces that, if done well, can be edited into a master tape for about \$300.

Since you are a critical music listener, something new occurs to you when you first hear the completed master tape. Recording with a pickup group has its

advantages: some of the finest musicians in the world may be playing for you. Nevertheless, particularly in the string section, you have a collection of individuals, not an integrated orchestra. What Szell has accomplished over a period of years you could hardly expect from your group and its single-time conductor. Next time you will choose wind ensembles because they are easier to put together—and you will then also take a third step toward lowering your sales potential.

With the completion of a master tape, you reach what might be called the sweating-out phase of production. The last process over which you exercise any direct control is the transfer from tape to disc, and your control is limited to deciding what equalization, compression, and artificial reverberation, if any, is to be used, and to approving or disapproving a test. Past this point, everything is in the hands of the plater and the presser. It is not necessary that you understand precisely how they do what they do, but only that you realize (1) it costs money, and (2) all sorts of things can go wrong. Among the catastrophes that haunt the transfer from tape to vinyl disc are distortion, crackle, pre-echo, hum, rumble, wow, swish, bubbles, nonfill, clunks, loss of highs, loss of lows, warpage, scratches, and chemical changes in the plastic. Expect at least two or three of these in every production run, and start establishing your minimum standards of acceptability. Perfect records are as rare as four-leaf clovers.

At some point long before now you should have

ILLUSTRATIONS BY MARVIN GLASS



Your own equipment, with facilities for editing and dubbing (but not location recording) will cost you about \$10,000. Unless you are a rare bird indeed, your first scheduled release will not be *Scheherazade* with Leopold Stokowski conducting a major American symphony orchestra. It will be something smaller and perhaps more artistically satisfying: a pair of Haydn symphonies, for example, two of the seventy or so not available in the current catalog. But in so choosing you will have taken your first step in the direction of reduced potential sales. You will take many more such steps in the future.

In the performance of the Haydn you might want to use an orchestra of about thirty instruments, fewer than the New York Philharmonic would use, but more than Haydn had at Esterházy. The Musicians' Union—by now you have made its acquaintance—is rather fussy about adherence to its rules. One man in the orchestra gets paid double. He is the contractor and has assembled the orchestra for you. You are allowed to record for three hours, double pay for overtime, and to retain on the finished disc no more than fifteen minutes of this session. The musicians will learn how to play their musical parts and how to play them together during that time. The current union scale is \$56 per man, per session.

Your two Haydn symphonies total forty minutes, so three three-hour sessions will constitute your minimum

recording time. It may sound like a lot, but it isn't. Also in the studio with you is a conductor. Let's suppose you have found one big enough to command a royalty, but not yet of the stature to insist on a large advance against it. He will conduct for double-scale pay—against a royalty, that is. The engineer comes, with studio and equipment, at about \$75 per hour. You have, in addition, tape at \$10 a reel; rented music stands; the music on them—some rented, some bought; perhaps a rented harpsichord; and your partner. The two of you, as owners and operators, will have set up the stands, chairs, and music yourselves, and may possibly have swept the floor.

We'll assume the recording session goes off without a hitch. Lucky you—no overtime for mechanical or musical failure. Now let's sit down for an accounting. How much have you paid?

| | |
|---|------------|
| 30 musicians @ \$168 plus contracting fee.. | \$5,208.00 |
| 1 conductor | 336.00 |
| 1 studio and engineer, 9 hours @ \$75 ... | 675.00 |
| AFM, social security, and taxes | 870.00 |
| 18 reels of tape @ \$10 | 180.00 |
| 1 harpsichord, 3 days @ \$35, plus moving | 140.00 |
| 31 music stands, rent | 46.50 |
| Music scores and parts | 75.00 |
| TOTAL | \$7,530.50 |

If you had decided to substitute Haydn quartets for the symphonies, you might have saved yourself almost

A COMPLETE GUIDE FOR BEGINNERS

(and including Trials and Tribulations)

By James Goodfriend



PEOPLE generally go into the record business out of a sense of dissatisfaction—a profound discontent with the condition of the current catalog, or perhaps with the technical quality of available recordings. Because music and sound must necessarily be judged subjectively, there is always plenty of room for disagreement. A new record producer, often as not, is a collector turned sour.

Theoretically, only two things are necessary for you to own and operate a record company: money, and a name for your label. Everything else, including ideas, can be bought. A few companies have been organized on this basis. They have failed. But let us assume that you are not one of this group, that you bring to the venture not only the gold of a Rothschild, but a deep critical knowledge and appreciation of music, a basic familiarity with the way a tape recorder works, a number of years of business experience, and that you experience a profound disquiet when contemplating the contents of the Schwann catalog. Where do you start?

This is the point at which you might make your first mistake. You cannot start at any one place, nor with any one thing. You must go in all directions at once. You need a lawyer, an accountant, a license from the American Federation of Musicians, a secretary, the use of professional tape and disc playback equipment, an engineer, a place to call home, Compazine (10-mg.

spansules should do it), a checking account, and at least one partner to share with you the work that is so menial you wouldn't dare ask anyone else to do it. You need these as of right now.

And you must immediately decide the following: will you record your own tapes, buy them ready-made from Europe, or commission them to be made for you in Japan? If the former, will you record in the States, or venture, sans contracts, to Europe; will you record big works or small ones, warhorses or esoterica; will you try to blanket the field or to specialize; aim at high prices or low; package plain or fancy; hit the market with many issues or few? You might, in addition, have in readiness an explanation as to why a dealer or distributor should handle your records for that moment when he asks, "Why should I handle your records?"

Everything you've done so far has cost money, and so will everything yet to come. A lawyer works on a retainer, or at rates of \$25 to \$50 an hour. It is convenient to know whether you will be billed for his time alone at that price, or whether his secretarial help goes at the same rate. In general, it is a good idea to know everything in advance, but more often than not this is impossible.

Let's get you out of the office into the recording studio, where the artistic and critical work, amounting to about one per cent of the total work, takes place.

HOW TO START A RECORD COMPANY:



of 30×10^{-6} cm/dyne at 0.25-gram force, and 15×10^{-6} cm/dyne at 1.2 grams. Recommended force is 1 gram. Matching networks are supplied for connection to low-level magnetic-preamplifier inputs. The cartridge is very small, and clips onto a special bracket for mounting in conventional arms. A miniature printed-circuit board is used for making connections to the arm wiring, after which it plugs into the back of the cartridge. The stylus is not replaceable by the user, but must be returned to the manufacturer.

The Cook 60 record required a 3-gram tracking force, which was used for most of our tests. There was visible waveform distortion at this force when playing high-level records, so we used 4 grams for the IM distortion test.

The LDM's frequency response was the flattest and smoothest of this group of cartridges. It was within ± 1.5 db to 20,000 cps, without any peaks or valleys. The channel separation averaged almost 30 db up to 5,000 cps, 21.5 db at 10,000 cps, and 10 db at 20,000 cps. The IM distortion at 4 grams was about average,

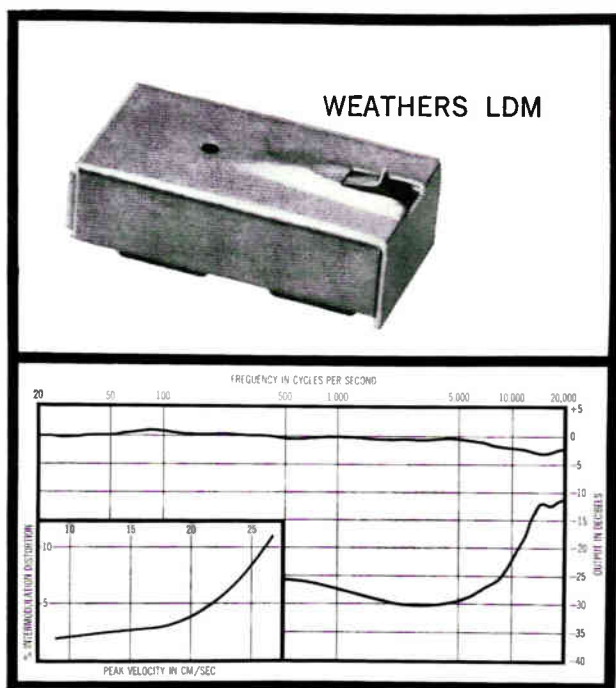

but instead of rising sharply at some critical peak velocity, it rose gradually over the range of recorded velocities on the RCA 12-5-39 record.

The output of the Weathers LDM was lower than average, about 4.8 millivolts. However, being nonmagnetic, the LDM was completely immune to induced hum. The sound of the LDM was exceptionally sweet, clean, and transparent. It was very similar to the sound of the original Weathers FM monophonic pickup, which in its day earned an enviable reputation.

KNIGHT KN-505X

- The Knight KN-505X is a moving-magnet cartridge, with a replaceable 0.6-mil diamond stylus. Rated compliance is 10×10^{-6} cm/dyne, and a tracking force of from 1 to 8 grams is recommended. The

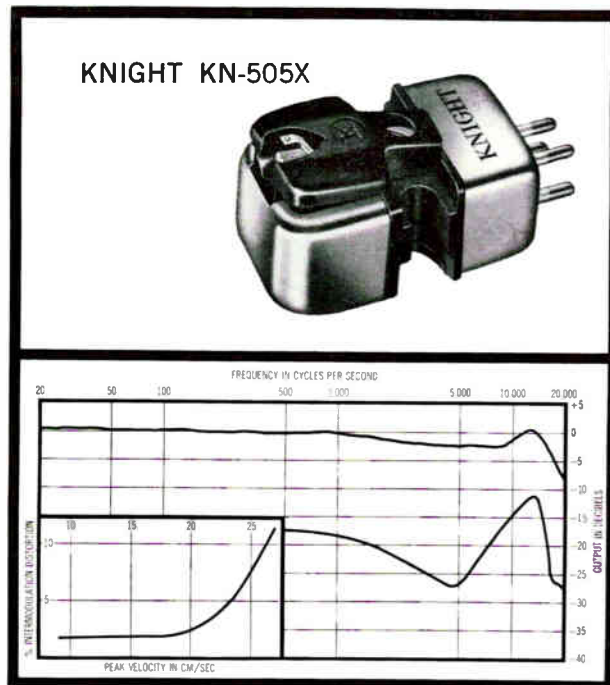

list price of the KN-505X is \$39.95 (\$19.97 with the trade-in of another cartridge), and it is available only from Allied Radio Corporation.

The Knight KN-505X required 5 grams to track the Cook 60 record. A 3-gram force was used for our other tests. The frequency response was within ± 1.5 db to 16,000 cps, with a slight peak at 13,000 cps. The channel separation was about 18 db at 1,000 cps, not quite 25 db around 4,500 cps, and 10 db or better to 20,000 cps. The IM distortion at 3 grams tracking force was about average for this first group of cartridges tested.

Although it has a mumetal shield, the Knight KN-505X was quite sensitive to hum pickup. Installation in record changers with two-pole motors, for example, would not be advisable. Cartridge output at 3.54 cm/sec velocity was 6 millivolts.

The listening quality of the KN-505X was good. Aside from a slight crispness, there was no particular emphasis on any portion of the spectrum.

CARTRIDGES TO BE REPORTED ON NEXT MONTH

Pickering 400AA • ADC-1 MK II • Elac STS 322
Ortophon SPU/T • Pickering 481AA • Fairchild F-7

CARTRIDGES

the Cook 60 record. A 3-gram force was used for all other tests. The cartridge had an output of 7.3 millivolts, with hum shielding being exceptionally good, and IM distortion about average.

The frequency response was ± 2.5 db to beyond 16,000 cps. There was a broad rise in the region of 5,000 to 12,000 cps, and a slightly higher output below 500 cps than we observed on other cartridges. Channel separation was about 22 db in the 3,000-cps region, and better than 15 db to 15,000 cps.

The Dynaco Stereodyne II was one of the few cartridges that sounded distinctly different from the others. It had an exceptionally full-bodied, warm, and musical character, and gave the sound a definite and pleasing projection without any objectionable presence peak in the mid-range frequencies.

ADC-3

● The ADC-3 is physically and electrically similar to the more expensive ADC-1 and ADC-2. All three are of the moving-magnet type, with a replaceable stylus assembly. The very high stylus compliance of both earlier ADC cartridges made them unsuitable for use in most record changers. The ADC-3, priced at \$37.50, has been designed for use in essentially any record changer, while retaining the character of the other ADC cartridges.

The ADC-3 stylus has a minimum compliance of 15×10^{-9} cm/dyne, and is designed to track at 2 to 6 grams. The 0.7-mil diamond stylus has an effective tip mass of 0.8 milligram.

The high compliance of the ADC-3 stylus was evident in our low-frequency tracking test, when only 1.5 grams were required to play the Cook 60 record. We used the minimum rated tracking force of 2 grams for our frequency-response and separation measurements. Frequency response was smooth up to about 10,000 cps and had a 2.5-db peak at 12,500 cps. Over-all, the

COMPARATIVE CARTRIDGE DATA

| Cartridge | Output, mv | Relative hum, db | L-F tracking force, gm | Weight, gm | Price |
|----------------------|------------|------------------|------------------------|------------|---------|
| Sonotone 9TAF-SDV | 7.8 | * | 3 | 3.2 | \$19.25 |
| Shure M77 | 15.3 | -35 | † | n/a | 26.95 |
| Dynaco Stereodyne II | 7.3 | -35 | 4 | 10 | 29.95 |
| ADC-3 | 6.2 | -9 | 1.5 | 6.8 | 37.50 |
| Weathers LDM | 4.8 | * | 3.5 | 3.8 | 39.50 |
| Knight KN-505X | 6.0 | +17 | 5 | 9 | 39.95 |

*No induced hum.

†Would not track at 5 grams.

response was ± 2.5 db to 16,000 cps. Channel separation was about 30 db from 500 to 1,000 cps, gradually reducing to about 17 db at 12,000 cps. Crosstalk curves

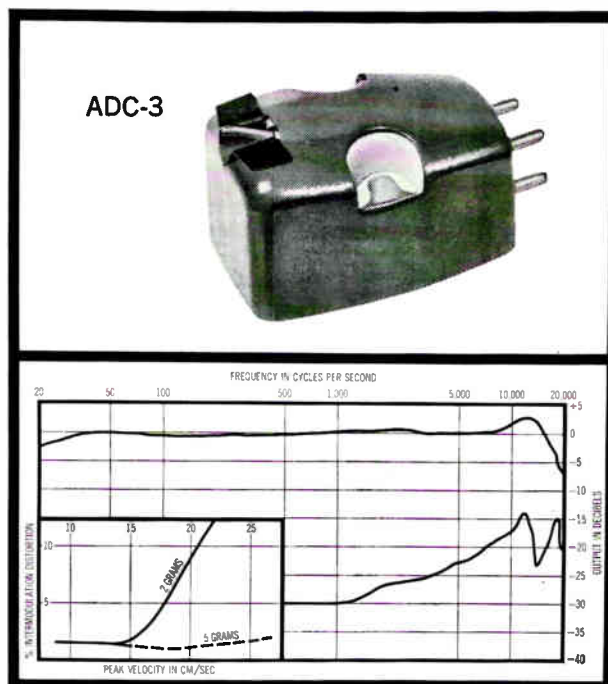

indicated slight resonances at 12,000 and 18,000 cps, but channel separation exceeded 10 db all the way to 20,000 cps.

Hum shielding of the ADC-3 was adequate though not exceptional. The IM distortion test showed an abrupt rise in distortion at peak velocities greater than 15 cm/sec when the 2-gram force was used. On the other hand, at 5 grams the distortion was extremely low (essentially the residual distortion in the record) up to the maximum recorded velocity of 27.9 cm/sec. We would recommend operation of the ADC-3 at about 4 grams, since the 5-gram force caused the bottom of the cartridge almost to touch the record surface.

The listening quality of the ADC-3 was very similar to that of other ADC cartridges—that is to say, bright and transparent with a trace of shimmer on the extreme highs.

WEATHERS LDM

● The Weathers LDM cartridge, priced at \$39.50, is a totally new design. The ceramic elements of the LDM are very tiny, and are driven directly by the stylus-bar mounting block. This arrangement applies a minute stress to the ceramic elements. Other ceramic cartridges, by contrast, use a yoke arrangement to couple the stylus bar to the ceramic elements.

The Weathers LDM has a rated stylus compliance

tridge tracked the Cook 60 record at 3 grams, so this tracking force was used for subsequent tests. The very low weight of the Sonotone cartridge (3.2 grams) may require additional weight in some tone-arm heads to obtain proper tracking force.

Measured frequency response was ± 3 db to 20,000 cps with proper low-end equalization. Channel separation was better than 25 db up to 3,500 cps, reducing at 10,000 cps to slightly better than 5 db, which was maintained to 20,000 cps. In this respect the Velocitone Mark III was superior to the older 9T cartridges, which had no separation above 12,000 cps. Because it is a ceramic cartridge, it was completely immune to magnetically induced hum. The IM distortion was extremely low, up to the maximum recorded velocities on the test record, at 4 grams tracking force.

The listening quality of the Velocitone Mark III, like that of its predecessor, was practically indistinguishable from that of magnetic cartridges costing twice as much. Its sound was clean and smooth, but did not have the slight shimmer of the widest-range cartridges. By any standards, however, it produced excellent, musical sound.

SHURE M77

- The Shure M77 is a moving-magnet cartridge designed specifically for record-changer use, and is priced at \$26.95. A relatively massive, sturdy stylus structure is employed, which can be replaced very easily.

Exceptionally high output (15.3 millivolts) of the M77 and its unusually effective hum shielding make

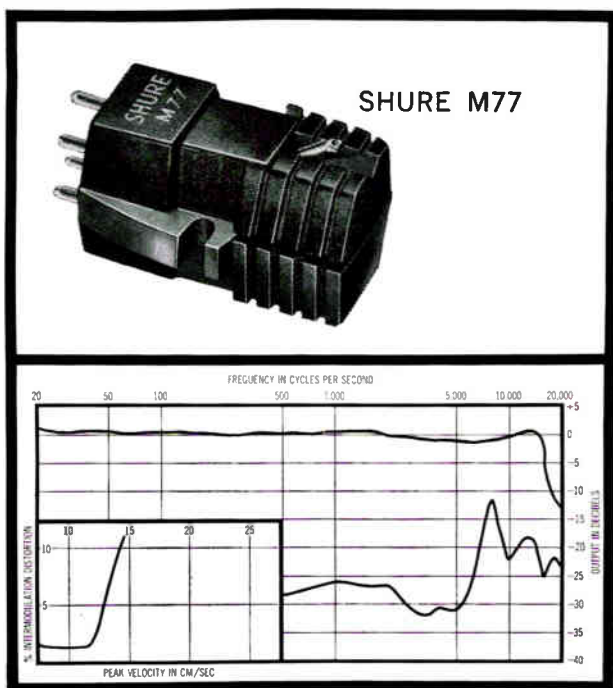

the cartridge a logical choice for use in inexpensive changers. Although our test cartridge had difficulty tracking the Cook 60 record, even with 5 grams force, we used that value in our tests.

The M77 had a smooth, extended frequency response, ± 1.5 db to 15,000 cps. Channel separation was about 27 db or better up to 6,000 cps. Separation averaged better than 15 db all the way to 15,000 cps, except for an apparent mechanical resonance at 8,000 cps, which did not affect the frequency response but reduced separation to about 12 db.

The Shure M77 had a fairly bright, lively sound, which we suspect would show up to best advantage on a speaker that lacks an extended high-frequency response. The IM distortion was somewhat high for critical listening to discs with very high modulation levels, but in our listening tests with a variety of stereo records, we were never unpleasantly aware of it. In sum, while the M77 is not the equal of the Shure M33 cartridges, it is still a sturdy performer.

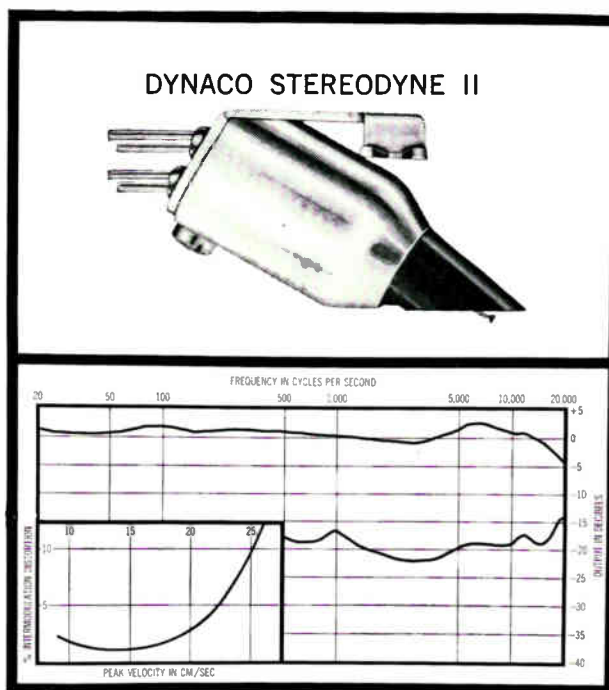

DYNACO STEREODYNE II

- Dynaco's Stereodyne II, priced at \$29.95, is the current version of the B&O cartridge imported from Denmark by Dynaco. It is of the variable-reluctance type, with a unique symmetrical design. Because of this, the stylus compliance (5×10^{-6} cm/dyne) is inherently equal in all directions. The replaceable stylus assembly has a 0.7-mil diamond.

The recommended range of tracking forces is from 2 to 4 grams, and a 4-gram force was needed to play

● CARTRIDGES

frequency end, since all units checked out reasonably flat after proper compensation.

The output voltage from each channel was measured at 1,000 cps, using the 3.54-cm/sec bands of the CBS STR-100 record. This is equivalent to a lateral velocity of 5 cm/sec.

To test hum sensitivity, the cartridge was placed in a strong 60-cps magnetic field and its output voltage was measured. This voltage, expressed in decibels relative to the 3.54-cm/sec output voltage, gives an indication of the hum shielding of the cartridge. The greater the negative value of the hum figure, the better the shielding.

Finally, intermodulation distortion was measured, as a function of peak recorded velocity, using the RCA 12-5-39 (78-rpm) test record. A Heath AA-1 Audio Analyzer was used to measure the IM distortion of the cartridge when playing the 400-cps and 4,000-cps tones on the record. In a few cases in which the distortion seemed too high at the low tracking forces used in the other tests, measurements were also made at higher tracking forces.

Our listening tests showed remarkably small differences in sound quality between these cartridges. Controlled A-B listening tests revealed some subtle distinctions, but the average listener would have been hard put to identify the cartridge he was listening to. In general, the more expensive cartridges had higher compliance, permitting tracking at lower forces, which contributes to improved record and stylus wear. The better cartridges also tended to have a somewhat smoother, more extended high-frequency response, which adds clarity and transparency to the sound.

We can offer only general verbal descriptions of the sound qualities of these cartridges, except in the rare instances where a cartridge sounded distinctly different from the others. The prospective purchaser, therefore, is strongly advised to listen critically to any cartridge with the same type of speaker system (and, if possible, amplifier) he plans to use it with. In the last analysis, this is the only reliable way to select any high-fidelity component.

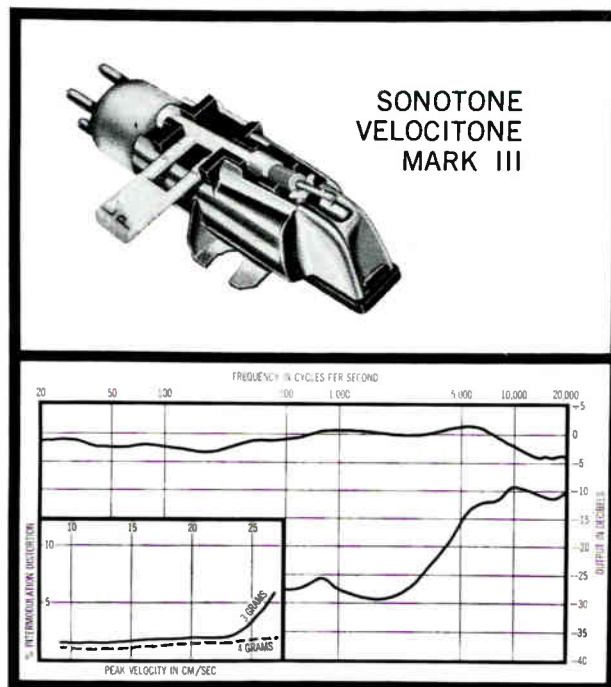

SONOTONE VELOCITONE
MARK III

● Sonotone's Velocitone Mark III ceramic cartridge (Model 9TAF-SDV) is a much-improved version of the 9T series reviewed in our last series of reports. The cartridge has an almost damage-proof turn-over stylus assembly, available with combinations of 0.7-mil and 3-mil styli, in diamond and/or sapphire. The unit tested, equipped with a 0.7-mil diamond and a 3-mil sapphire, has a list price of \$19.25.

The stylus shank of the new cartridge is attached to a rubber-like block that permits it to be completely bent back on itself without damage. Connections to the cartridge are made through a removable plug, fitted for standard sleeve connectors. This is a very convenient system, but the length of the cartridge may make it difficult to mount in some arms. Included with the cartridge are plug-in equalizers that match its output to standard magnetic-phono inputs.

The Velocitone Mark III stylus has a rated compliance of at least 6×10^{-6} cm/dyne, and operates at tracking forces from 2 to 5 grams. In our tests, the car-

HOW TO INTERPRET THE CURVES

The upper curve represents the averaged *frequency response* of the right and left channels. Deviations from flat response, unless they exceed 3 db, are not usually detectable when music material is being played.

The lower curve, which starts at 500 cps, represents the averaged *separation between channels*. The amount of separa-

tion at any frequency is indicated by the vertical distance between the upper and lower curves and is expressed in decibels.

The graph inset at lower left shows the increase in distortion at a specified tracking force as the stylus velocity increases. The flatter the curve, the better the cartridge's ability to track loud, heavily recorded passages.

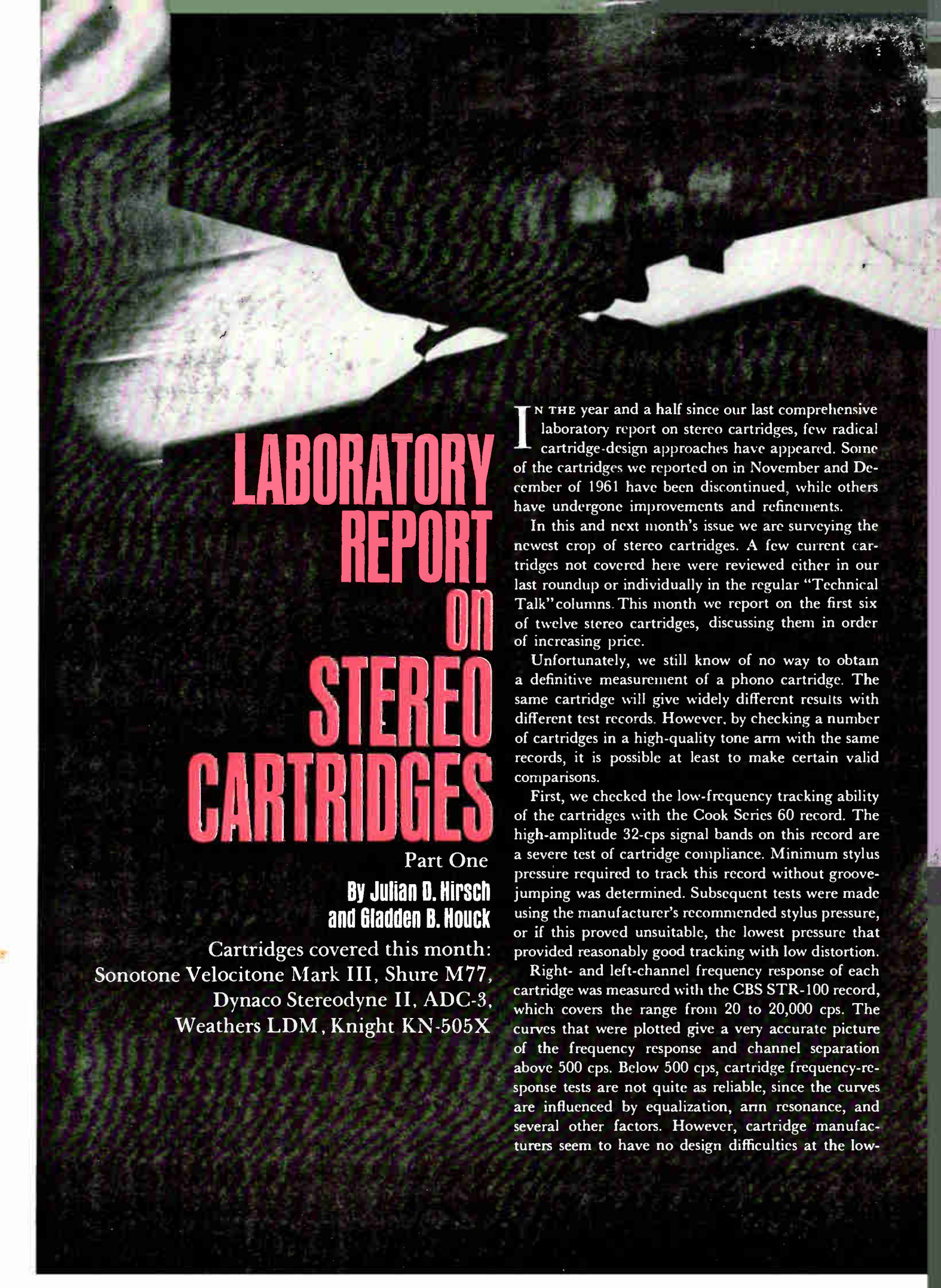

LABORATORY REPORT ON STEREO CARTRIDGES

Part One

By Julian D. Hirsch
and Gladden B. Houck

Cartridges covered this month:
Sonotone Velocitone Mark III, Shure M77,
Dynaco Stereodyne II, ADC-3,
Weathers LDM, Knight KN-505X

IN THE year and a half since our last comprehensive laboratory report on stereo cartridges, few radical cartridge-design approaches have appeared. Some of the cartridges we reported on in November and December of 1961 have been discontinued, while others have undergone improvements and refinements.

In this and next month's issue we are surveying the newest crop of stereo cartridges. A few current cartridges not covered here were reviewed either in our last roundup or individually in the regular "Technical Talk" columns. This month we report on the first six of twelve stereo cartridges, discussing them in order of increasing price.

Unfortunately, we still know of no way to obtain a definitive measurement of a phono cartridge. The same cartridge will give widely different results with different test records. However, by checking a number of cartridges in a high-quality tone arm with the same records, it is possible at least to make certain valid comparisons.

First, we checked the low-frequency tracking ability of the cartridges with the Cook Series 60 record. The high-amplitude 32-cps signal bands on this record are a severe test of cartridge compliance. Minimum stylus pressure required to track this record without groove-jumping was determined. Subsequent tests were made using the manufacturer's recommended stylus pressure, or if this proved unsuitable, the lowest pressure that provided reasonably good tracking with low distortion.

Right- and left-channel frequency response of each cartridge was measured with the CBS STR-100 record, which covers the range from 20 to 20,000 cps. The curves that were plotted give a very accurate picture of the frequency response and channel separation above 500 cps. Below 500 cps, cartridge frequency-response tests are not quite as reliable, since the curves are influenced by equalization, arm resonance, and several other factors. However, cartridge manufacturers seem to have no design difficulties at the low-

Chamber Music

Mozart do we hear a melancholy so intense and unre-
lieved. The additional viola, which contributes to this
expressive effect by darkening the instrumental color of
the writing, also contributes to the somber strangeness
of the Minuet and first part of the Trio in the Quintet
K. 515, the extraordinary violent intensities of the middle
part of the Trio, the poignancy of the Andante. Addi-
tional impressive examples of Mozart's writing for this
combination are the Quintet K. 593, with its affecting
slow movement and bustling comedy finale; the Quintet
K. 614, with its delightfully high-spirited opening move-
ment and finale; and the Quintet K. 406 (an arrangement
of the earlier Serenade K. 388 for winds).

Mozart's quartets delight one with delicate textures
that are to be heard in no other quartet writing. And
they move one with an expressive content of unending
variety, in one after another of the famous six quartets
dedicated to Haydn—K. 387, 421, 428, 458, 464, and
465—and in the equally fine K. 458 ("Hunt") and
K. 499.

**MOZART: Quintet K. 581, in A Major, for Clarinet and
Strings. Members of the Vienna Octet. LONDON CM 9121 \$4.98.
Budapest Quartet and Oppenheim. COLUMBIA MS 6127 \$5.98,
ML 5455 \$4.98.**

Mozart, who had great fondness for the clarinet, adds
it to the string quartet in the Quintet K. 581, and gives
it some of the most exquisite and affecting passages in
the flow of lyrical writing in the opening movement and
Larghetto. The members of the Vienna Octet play with
more animation than the Budapest Quartet and Oppen-
heim; their clarinetist plays with more beautiful tone and
phrasing; their first violin is more agreeable to the ear.

**HAYDN: Quartets Op. 20, No. 4, in D Major; Op. 76, No. 2,
in D Minor. Fine Arts Quartet. CONCERT-DISC 1228 and 228
\$5.98 each.**

**HAYDN: Quartets Op. 54, No. 1, in G Major; No. 2, in C
Major. Amadeus Quartet. ANGEL 45024 \$3.98.**

**HAYDN: Quartets Op. 74, No. 1, in C Major; Op. 77, No. 1,
in G Major. Juilliard Quartet. RCA VICTOR LM 2168 \$4.98.**

Mozart's dedication of his quartets to Haydn expressed
his high regard for this composer's music; and what he
admired has never been described more perceptively than
by Tovey's statements that "the essential character of
Haydn's form is dramatic surprise at the moment" and
that "nothing in Haydn is difficult to follow, but every-
thing is unexpected."

Though the Schneider Quartet's performances on
Haydn Society records are no longer in the catalog, they
are to be picked up here and there, and are the ones to
hunt for and acquire. For their detailed, energetic, sharply
rhythmed and therefore enlivening inflections point up
the unpredictable and fascinating course of Haydn's lively

and inventive mind as no other performances have done
—as the Budapest Quartet's refined and smooth perform-
ances of Op. 76, for example, do not.

**BOCCHERINI: Quartet Op. 33, No. 6, in A Major. New Music
Quartet. BARTOK 911 \$5.00.**

Boccherini is not of the stature of the composers who
have been discussed up to this point, but his writing is
engagingly and often excitingly fresh and individual in
invention and procedures. The catalog still lists the Quar-
tet Op. 33, No. 6, played by the regrettably short-lived
New Music Quartet, whose performances exhibited a
technical, tonal, musical, and ensemble incandescence be-
yond anything I can recall hearing. Another record to
hunt for, therefore, is Columbia ML 5047, with this
group's dazzling performances of four additional quartets
of Boccherini. And still others are the Angel records
with a number of his quintets, played well by the quin-
tetto Boccherini.

**DVORÁK: Quartets Op. 51, in E-flat Major; Op. 96, in F
Major ("American"). Budapest Quartet. COLUMBIA ML 5143
\$4.98.**

**DVORÁK: Quintet Op. 81, in A Major, for Piano and Strings.
Budapest Quartet and Curzon. COLUMBIA ML 4825 \$4.98.**

Finally, another composer of lesser stature, Dvorák, whose
rich flow of attractive melody is heard not only in his
Slavonic Dances and "New World" Symphony but in the
Quartets Opp. 51 and 96 and the Piano Quintet Op. 81.

• • •

As for Brahms, whom the reader may have been wait-
ing for impatiently, his omission from this report is a
result not of absentmindedness, but of a critical estimate
of his chamber music—that it represents not real creative
activity but the pretense of such activity in synthetically
contrived thematic substance which is manipulated by
formula to fill out a prescribed pattern.

Having presented a considerable number of
works, which will take the reader some time to
acquaint himself with, I suggest a few to begin
with, in the following order:

Beethoven: Trio Op. 97 ("Archduke")

Beethoven: Quartet Op. 132

Haydn: Quartet Op. 76, No. 2

Mozart: Quartet K. 458 ("Hunt")

Mozart: Quintet in G Minor (K. 516)

Schubert: Quartet Op. 29

Schubert: Quintet Op. 163

*B. H. Haggin has been writing about music for thirty years,
including a stint of twenty-one years as the music critic of
The Nation, from which he resigned in 1957. Among his books are
Music on Records and Music for the Man Who Enjoys Hamlet.*

whose other movements have an energy, a dramatic power, a largeness of expressive implication and structural scale that also are comparable with Beethoven's. The Quintet is, then, in every sense—expressive content, style, structure—a *great* work, and belies the still current idea of Schubert as a lyricist whose large works are mere garrulous successions of pretty melodies. And it achieves its effect in part through textures that are made denser and more robust by the addition of the second cello to the string quartet.

Stern's strangely inexpressive treatment of the first violin part at the beginning of the slow movement, marked *espressivo* in the score, must be noted in the otherwise superb 1952 Prades Festival performance.

SCHUBERT: Quartets Op. 29, in A Minor; Op. posth., in D Minor ("Death and the Maiden"); Op. 161, in G Major. Budapest Quartet. COLUMBIA ML 4831, 4832, 4833 \$4.98 each; SL 194 (complete set) \$14.94.

The *great* Schubert is heard again in the powerful and dramatic opening movement of the String Quartet "Death and the Maiden" and its extraordinary *perpetuum mobile* finale, which has an energy and momentum like that of the whirling finale of Schubert's Symphony No. 9. Another such finale ends the Quartet Op. 161, whose opening movement has passages of this supreme melodist's writing which are characteristic in their poignant loveliness, and out of which erupt, characteristically, passages of tremendous dramatic force. The Budapest Quartet's changes of tempo at the beginning of "Death and the Maiden," and its retardations in the opening statements of the Andante of Op. 161, seem to me flaws in the otherwise superb performances.

SCHUBERT: Trio Op. 99, in B-flat Major. Cortot, Thibaud, and Casals. ANGEL COLH 12 \$5.98. Istomin, Schneider, and Casals. COLUMBIA 4715 \$4.98.

SCHUBERT: Trio Op. 100, in E-flat Major. Busch-Serkin Trio. ANGEL COLH 43 \$5.98. Horszowski, Schneider, and Casals. COLUMBIA ML 4716 \$4.98.

It is again the great Schubert that speaks in the imposing opening movement of the Trio Op. 99, the supreme melodist who gives us the marvelous writing of the Andante which follows. And the less imposing Trio Op. 100 is made treasurable by a comparable Andante, a captivating Scherzo, and beautiful writing in the other movements. The 1926 performance of Op. 99 by Cortot, Thibaud, and Casals again has lightness, grace, and intimate warmth, as against the breadth, the powerful inflection, and the expressive force of the 1952 Prades Festival performance of Istomin, Schneider, and Casals. And as against the similar Prades Festival performance of Op. 100 by Horszowski, Schneider, and Casals, the pre-war Busch-Serkin Trio performance offers the sensitively phrased and executed playing of Serkin in his early years, but with less attractive playing of the strings.

MOZART: Quintets K. 406, in C Minor; 515, in C Major; 516, in G Minor; 593, in D Major; 614, in E-flat Major. Budapest Quartet and Trampler. COLUMBIA ML 5191, 5192, 5193 \$4.98 each; M3L 239 (complete set) \$14.94.

MOZART: Quartets K. 387, in G Major; 421, in D Minor; 428, in E-flat Major; 458 ("Hunt"), in B-flat Major; 464, in A Major; 465, in C Major. Budapest Quartet. COLUMBIA ML 4726, 4727, 4728 \$4.98 each; SL 187 (complete set) \$14.94.

MOZART: Quartet K. 499, in D Major. Budapest Quartet. COLUMBIA ML 5007 \$4.98.

From the immensities of Beethoven and Schubert we turn to the music whose "effect on the mind," as W. J. Turner says of Mozart's Overture to *The Marriage of Figaro*. "is out of all proportion to its impingement on the senses." The delicate textures of sound in Mozart's music that ravish the ear with their beauty—the textures of the five voices in the first-act quintet in *Così fan tutte*, the textures of winds and strings in the quiet passage just before the concluding flourishes of the G Minor Symphony—pierce the heart with their expressive content. And nowhere is this expressive content as overwhelming as in the writing for two violins, two violas, and cello in the G Minor Quintet (K. 516): in no other work of



Chamber Music

BEETHOVEN: *Trio Op. 97, in B-flat Major ("Archduke").* Cortot, Thibaud, and Casals. ANGEL COLH 29 \$5.98. Istomin, Schneider, and Casals. COLUMBIA ML 4574 \$4.98.

In addition to the operation of the composer, a piece of music offers the operation of its performers—in the Beethoven symphony, the precise and beautiful-sounding working together of a hundred musicians under a conductor. In the trio, the integrated working together of the three solo instruments is more clearly heard in a greater profusion of subtler detail, in which there are an immediacy and intimacy of relation in the playing, a sensitiveness of response, and at times an incandescence, that are like what one hears in the playing of a small group of hot jazz musicians. Such is the historic 1928 performance of the "Archduke" Trio by Cortot, Thibaud, and Casals, in which the three strikingly dissimilar individuals—Cortot with his intimate warmth, Thibaud with his grace and elegance, Casals with his dominating power of tone and phrasing—work marvelously together as a result of the playing they had done for their own pleasure for twenty years. And in the 1951 Perpignan Festival performance too—in which the even greater power of Casals's tone and phrasing again dominates over playing by Istomin and Schneider that has less grace but more force than Cortot and Thibaud—one hears a performance in which the first movement is more majestic, the slow movement more profoundly reflective, the finale more brilliantly energetic than in the Cortot-Thibaud-Casals performance.

BEETHOVEN: *Quartets Op. 127, in E-flat Major; 130, in B-flat Major; 131, in C-sharp Minor; 132, in A Minor; 135, in F Major.* Budapest Quartet. COLUMBIA ML 4583, 4584, 4586, 4587 \$4.98 each; SL 174 (complete set) \$24.90.

In his book *Beethoven: His Spiritual Development*, J. W.

N. Sullivan observes that "perhaps even Shakespeare never reached that final stage of illumination that is expressed in some of Beethoven's late music." That inner illumination is communicated not only by the slow movement of the Ninth Symphony and the concluding movements of the Piano Sonatas Opp. 109 and 111, but by the slow movements of the last string quartets: above all, the expansively elaborate variation movement of the Quartet Op. 132, which carries the illumination to a climax of sheer ecstasy, and also in the variation movement of Op. 127 and opening fugue of Op. 135, whose moving eloquence is achieved with the concentrated brevity of some of Beethoven's late writing. In these works the musical thought proceeds in textures combining the strands of string sound from two violins, a viola and a cello; and what the Budapest Quartet produced in its early years—the integrated progression of the strands of flawless sound that were inflected with unerring musical intelligence and taste—was the finest quartet-playing we had ever heard, and made their performances of the Beethoven works incomparably effective and satisfying. The musical intelligence and the feeling for ensemble operation have continued undiminished, but tone and intonation have deteriorated; and in the newest performances of the last quartets on Columbia M5L 277 and M5S 677, the deterioration is such as to make it advisable to acquire the earlier performances on the five records of ML 4583/7, in which the first violin's tone is still agreeable and the cellist's tone still has its extraordinary dark beauty, fullness, and projective force.

SCHUBERT: *Quintet Op. 163, in C Major.* Stern, Schneider, Katims, Casals, Tortelier. COLUMBIA ML 4714 \$4.98.

From some of Schubert's last writing, as from Beethoven's, we get a communication of life-long experience mastered, profound lessons learned, and final illumination achieved. The communication is most overwhelming in the slow movement of the String Quintet Op. 163,

Four pencil studies by
Toulouse-Lautrec
illustrating the neck
and scroll of the
larger stringed instru-
ments and their
relation to
the performer's hand.

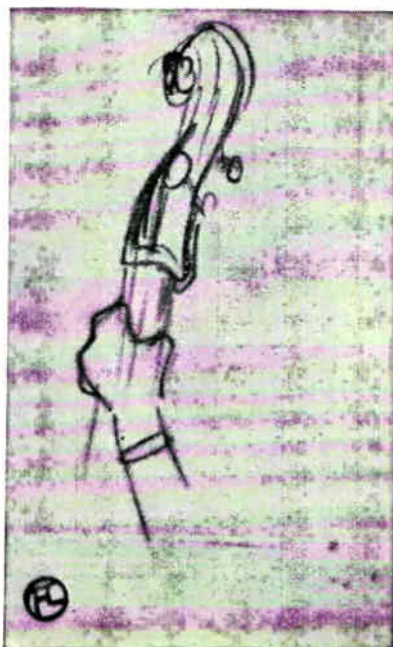

MUSEE TOULOUSE-LAUTREC, ALBI, FRANCE



Title page of the six "Haydn" Quartets published in Vienna, September 1785, dedicated to Haydn by Mozart as a gesture of friendship and respect.

Essentials of a Chamber Music Library

by B. H. Huggin

A prominent critic points out that chamber music can be approached with the same critical and aesthetic equipment that is brought to the appreciation of orchestral or instrumental music, and then presents a series of recommended recordings

THE SAME mind of Beethoven that operated in the creation of the sonorous and multicolored textures of a symphony for large orchestra operated also in the creation of the fine linear textures of a chamber work for a few instruments; and the person who is affected by the progression of Beethoven's musical thought in the symphony will be affected also by the progression in the trio or quartet. Specifically, the mind that is heard operating in the piano's opening statement in the first movement of Beethoven's Concerto No. 4, in the orchestra's reply, and in the continuing dialogue of piano and

orchestra—that mind is heard also in the piano's opening statement in the third movement of the "Archduke" Trio, Op. 97, in the repetition of this statement by the violin and cello, and in the continuing conversation of the three instruments. And the person who is affected by the progression in the concerto will be affected also by the progression in the trio: the expressively elevated theme, its developments in the variations that follow, the return to the theme, and its expansion into a wide-ranging coda with implications of summation that reach sublime conclusions. *(Continued overleaf)*

GOULD quences with a kind of relentless processional rigor: the effect at first is obtrusively formal, even a little self-consciously archaic and stiff, and one perceives the justice and meaning of this odd treatment only as the related fugue unfolds itself. The bone-dry, almost uninflected statement of the Prelude has prepared the ear for a consequent grace of relief, of true flight, in the fugue, which now evolves with an absolutely stunning effect of effortless majesty. Until one has heard both, one really has no complete perspective on either. As played by Mr. Gould, their relationship is obviously a conceptual one.

IT REMAINS for me to particularize what this conceptual approach is *not*. To begin with, every pianist, simply as a matter of practicality, has "a concept" of the piece he means to play, as has every painter of the picture he proposes to paint. But this kind of concept is largely a provisional (and highly useful) apparatus for meeting various *crises d'occasion* (it enables dozens of people, for example, to "just sit down and play something"), and it may or may not express a more general conceptual intelligence behind it. Of course, it need not do so, and if it doesn't, it simply remains occasional and ever-ready, like the kind of roadmap used by tourists.

But the conceptually engaged mind is something quite different: for one thing, it never rests. It is seldom found on Wednesday precisely where we left it last Monday. Roadmaps are useless to it because it has to invent the places it wants to go. It often produces variorum readings of any given piece as it changes its own strategic position (as Bruegel produced different versions of the subjects—for example, an astonishing *Adoration of the Kings* seen through a heavy fall of snow—that most interested him). This disconcerting habit is usually tolerated in composers playing their own works (*vide* the curiously contradictory judgments from professionals who heard Chopin—or even, for that matter, J. S. Bach), but critics incline to hate it in mere pianists.

To date, this consideration has not much affected Mr. Gould, who like Bruegel generally places his conceptual idea in the very foreground of his performance, articulates it in the strongest terms, and lets the conventionally "expressive" chips fall pretty much where they may. This procedure of course has its dangers, sometimes producing an effect of forbidding severity (Bruegel's harshness has offended certain Botticelli-oriented minds for four centuries). In Mr. Gould's *Well-Tempered Clavier*, the great E-flat Minor Prelude and Fugue (not to mention the Protean seventh Prelude, a wildly problematical piece in anybody's

book) are cases in point. Many may find that these formidably crystalline structures require more than one visit before extending their full hospitality. However, strongly conceptualized playing not only stands up well under repeated attack—it indeed demands repeated attack before it yields its secrets. And when the conceptual performer brings off his enterprise successfully, the rewards are breathtakingly vivid. In addition, he deserves our respectful attention for his comparative rarity. Others may have other and perhaps more ingratiating virtues—but they do not have his. One cannot imagine Lipatti, for example, playing anything un-beautifully; but neither can one imagine him being particularly interesting in the strangely cryptic fifth Contrapunctus of *The Art of Fugue*, or even in the big and sombre five-part fugue (number four) of *The Well-Tempered Clavier*. But it is just here that Mr. Gould shines with incomparable brightness. Where others find chilly enigmas, he produces hushed and mysterious moments of an ineffable poignancy—lonely intellectual abstractions too architectural, too purely musical, for anybody's verbalization.

Or rather, *almost* that. "Anybody's" is a bit too strong. In a work published in 1797, Sir Joshua Reynolds writes that Bruegel's art contains "a great quantity of thinking . . . enough for twenty. . . . In this respect he is like Donne. . . ." And with this name, Sir Joshua gave us Bruegel's metaphoric number. For if half a dozen Renaissance poets will do for Botticelli (Edmund Spenser, for example, tells us "how finely the Graces can it foote/ To the instrument," and describes, blossom by blossom, our young girl's "angelick face" in its coronal of flowers), they will not do for the immensities of *The Art of Fugue*, the fantastic visions of Bruegel, or the conceptual intoxications of Mr. Gould. For these we need the apocalyptic utterance of a poet who has talked metaphysics with angels and survived the fearsome abysses of their syntax:

At the round earths imagin'd corners, blow
Your trumpets, Angells, and arise, arise
From death, you numberless infinities
Of souls, and to your scatted bodies goe,
All whom the flood did, and fire shall o'erthrow,
All whom warre, dearth, age, agues, tyrannies,
Despaire, law, chance, hath slaine, and you whose eyes
Shall behold God, and never tast Death's woe.

John Donne, *Holy Sonnets*

Here, in more ways than one, is the end of all pretty pictures: who but a Bruegel would conceivably undertake to image forth on canvas this vast mobilization for eternity? And should these thunderous images become music, as in the mind of a Bach they might, who but Mr. Gould would dream of articulating their conceptual geometry on a piano—and that without even touching the pedal?

Flemish parable, *does* represent it—sometimes in appalling depth. I find myself recalling, not the outlines, which are frequently ugly, but the peculiar *identity* of each of his forms—as in Mr. Gould's fugues I recall not particular melodic lines, but the peculiar and quasi-moral mood (January—spectral, February—bleak, August—opulent) of each of them.

One also gains an impression from many Botticelli paintings that his figures, flowers, and draperies have been multiplied almost *ad libitum* to fill the available space. They do so charmingly, but one feels that the addition or subtraction of a foot or so of canvas wouldn't have changed the composition much. And unlike Bruegel's, his details, taken singly, are invariably lovely (see the lower picture on page 34). But they would be just as lovely, and just as much at home, in half a dozen other Botticelli paintings.

In Bruegel, nothing can be added, nothing taken away. The real space (panel) and the imagined space, or perspective, is organized to accommodate precisely what is in it, and each figure, even the tiniest, has a lively and nonaccidental relation to its immediate environment and to the picture as a whole. A necessary loss in spontaneity is compensated by a gain in that thrillingly convincing sense of inevitability (of historicity, really) that bars all accidents; here we are in a world that (unlike Botticelli's) excludes all possibilities except the one in process of realization.

It is precisely this kind of inevitability, of historicity realized as pure form and immune to chance, that Mr. Gould discovers and proposes to us in *The Art of Fugue*. His affinity for this work is unmistakable; he plays it with passion, and it is a kind of compendium of his stylistic tastes. In it we discover that, even at the organ, he prefers not to obtain syntactical intelligibility as most instrumentalists do—that is, by means of the kind of linear tonal continuity called *legato*—but by an unrelaxing supervision of detached (*nonlegato*) sounds, which are often presented as nakedly as disjunct mathematical points. Where almost any other pianist would emphasize a tone by inflecting it dynamically or coloring it with the pedal, Mr. Gould

secures an astonishing amount of attention for it simply by exposing it *au naturel* in a relentlessly policed environment. All his details consequently have a Bruegelian conspicuousness, and he must, also like Bruegel, organize his total space in advance—not only in the foreground, around the central action, but also in the

illusory distances. As one result, his contrapuntal playing has a definition and transparency that are, at least in my listening experience, unique.

Meanwhile, a glance at the Bruegel detail seen below reveals that the most distant houses are houses, not daubs of paint; and the remotest figures (Mr. Gould's "disjunct mathematical points") are all organized micropersonalities engaged in some process of action or repose, each of them realized as the undirected eye in practice never does realize them. Botticelli's pictures are never continuous with any world outside themselves, phenomenal or conceptual, that we can know. But as our attention swings back, full of real news, from Bruegel's detail to his total picture (*January*, page 33), we suddenly sense that it is a window on a world that continues, infinitely, beyond the limits of the picture frame. It is perhaps not too fanciful to suggest that Mr. Gould's performances are also windows on a musical intelligence (in this case, Bach's) whose total creation is implicit in the view offered. Both Bruegel's picture and Mr. Gould's performance are selections from a continuum, and the conceptual vision of this continuum, rather than the immediate title of the selection, is what validates the tone of both.

TO TURN now from the general to the particular, I find that an important stylistic movement in sixteenth-century painting has considerable bearing on my estimate of Mr. Gould's performance style. I refer to that system of deliberately manipulated contrast and exaggeration generally called Mannerist. Bruegel never employed it in its extreme forms, but he did employ it: we note it in the powerfully elongated figures in his foregrounds (see page 34). In the picture from which this detail is taken (*The Adoration of the Kings*), the figure of the Virgin is seated. If she arose, she would be a giantess—taller than the already tall Kings. Yet, as composed in her seated posture, her relation to the rest of the space is incontestably right. And it is in fact this rightness of their relation to the total work that validates the exaggerated details of Mannerism. When the compelling force of this right relation is absent, the work is not Mannerist but mannered—a form of self-indulgence that often deserves the reproach of affectation it usually inspires.

Now, certain critics have observed that Mr. Gould's emphatically *nonlegato* style is "perhaps somewhat mannered." I submit that it is, on the contrary, Mannerist. Its effect is certainly arresting, which is precisely what it is meant to be. We hear it at the outset as Mr. Gould firmly tackles the first Prelude in C of *The Well-Tempered Clavier* (the familiar arpeggiated piece heard so often and so unhappily as an emotional subscript to Gounod's *Ave Maria*). Mr. Gould detaches and marshals these now rather shopworn se-

Bruegel: Detail.

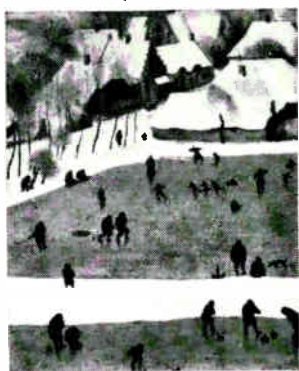

GOULD been very happy, for example, with Goethe's pat definition of architecture as "frozen music." We have only to invert the metaphor, defining music as "melted architecture," to arrive in a demonstrable mess.

These dangers in mind, the following remarks are directed toward the *visualization* of certain musical temperaments—and that whether by fair means or foul. In this pursuit, let me add, I am far from recommending any Rimbaudian "systematic derangement of the senses." Record companies obviously cannot be expected to issue mescaline for use with liner notes. But certainly a little casual practice in hearing colors and seeing sounds will help.

Let us suppose, all period considerations aside, that we are required to supply some music for the dancing of the Three Graces in Botticelli's *Primavera*, shown on page 32. Unless I am much mistaken, it already exists in Lipatti's serenely paced recording of the *Siciliana* from Bach's Sonata for Unaccompanied Flute. Lipatti's spacious inflection of the long strophic line matches the nobly archaic rhythm of the three figures; his turning movement from light to shadow is as sweetly melancholy; his tone is all darkened gold against the sensed sombreness of the mythical glade; the gravity of his grace echoes the classical posture of the assembled immortals.

To my knowledge, no music recorded by Mr. Gould has remotely suggested this peculiarly lovely antique mood, at once legendary, nostalgic, and decorative. And I think if we compare his recording of the Partita in B-flat with Lipatti's, we can sense why this is so. Here too we have ancient dances given the miraculous Bachian immediacy and formal perfection, and the two performances



Botticelli: Detail.

of them are equally masterly. From Lipatti's I retain a lasting impression of a lovely tonal shimmer—a sunny, sensuous, an unmistakably *al fresco* Mediterranean grace. In Mr. Gould's, something else has intervened: the chiaroscuro has deepened, and beyond the strength and lucidity of the playing, or parallel with it, I note a certain gritty angularity of formal thought. I am aware of a mind engaged in persistent conceptual exploration—aware of its readiness, indeed its eagerness, to subordinate a number of seductive but purely aural considerations to a ruling



Bruegel: Detail.

and quintessential *idea*. And finally I tend to be less aware of this particular partita than of the universal and prototypical notion from which all partitas originally sprang—what a medieval musicologist (or even old Boethius) might in fact have called their *Partitaness*. It is worth noting, about here, that the characteristic response to a Lipatti performance is, "I never heard anything so lovely in my life." But the characteristic reaction to one of Mr. Gould's is, "He finds things in it I never dreamed were there."

Lipatti, of course, and for all his sensibility, was not a particularly introspective pianist. Mr. Gould, and for all his widely noted public intransigences, most certainly is. And if Lipatti was Mediterranean and a ravishing colorist, Mr. Gould more resembles the austerer sculptural painters of the Gothic North. In any case I find him no alien amidst the fantastic activity, the multiplicity of particularized detail, the immeasurable distances, and the all-enveloping solitudes of a Flemish landscape—in particular, that masterpiece of Bruegel's known popularly as *The Hunters* but actually named *January* (see page 33). If ever a painting laid bare a "ruling and quintessential idea," this one does. It is a veritable Summa of all northern Januaryness. There is perhaps no more brilliantly realized picture-as-picture in existence. But what I remember when away from it is the blazing conceptual reality, as mysterious as the Universals of the medieval scholastics, to which the picture seems simply to be a key.

It has been said of Botticelli that he merely presents his figures, he does not represent them. As the *Primavera* indicates, he tends toward two-dimensionality—not because he doesn't understand perspective, but because he has no particular use for it. I find myself recalling the graceful and elegant *outlines* of his forms as I remember the exquisitely inflected melodic outlines of Lipatti. But Bruegel, whether his subject be a dancing peasant, a medieval sin, or an obscure



of news, and this is doubtless one of Professor Neuhaus's reasons for writing (in Moscow) that "the pianist Gould is not simply a pianist; he is a phenomenon," adding that he plays Bach "as if he were one of the pupils of the Thomaskirche cantor."

Mr. Gould's Bach, finally, is remarkable for its stylistic range. His 1955 recording debut gave us the massive *Goldberg Variations* in a grandly scaled piano performance that continues to be discussed among professionals as a recording classic. He next addressed himself to the more popular partitas and concertos, investing these with all the palpable physical charm—the silvery tonal surfaces and exhilarating Baroque liveliness—one could possibly ask. Yet in the past year, and with apparently equal relish, the same pianist (becoming for this occasion an organist) plunged also into the icily inscrutable abstractions of *The Art of Fugue*, a dehumanized work as mysterious in its genesis—and as lacking in sensuous appeal—as some vast galactic cloud gleaming dimly in outer space. And the truly imposing dimensions of Mr. Gould's long-range Bach program have only lately become visible with his release of the first eight Preludes and Fugues of *The Well-Tempered Clavier*, a work that in its mountainous entirety will fill twelve full record sides.

Now it happens that Mr. Gould is no professed partisan of Bach and the Baroque. To the contrary, he is apt to be publicly identified (when he isn't playing Beethoven or Mozart) with the exposition of Arnold Schoenberg, Ernst Krenek, Alban Berg, and Richard Strauss. So, *pro tempore*, we will assume that Mr. Gould is not only ambitious, industrious, and somewhat didactically inclined (he is an author, uni-

versity lecturer, and documentary film producer, as well as the writer of some of the most formidable liner notes in print), but that he is almost recklessly versatile to boot—epithets which, as it happens, apply equally to Bruegel. But there is yet another word, much abused, that I have saved for last: the one certain critics have been uneasily avoiding. Without more ado, let me say that I find Mr. Gould the most *original* pianist of his generation—not because he is "trying to be different," as the offended coterie sniff goes, but because he cannot be otherwise, his mind apparently being possessed (as was Bruegel's) by an implacable spirit of inquiry.

Having said as much, I now have the problem of somehow conveying, first, an impression of the character of Mr. Gould's piano playing, and second, my notion, as derived from that character, of the singular nature of the musical intelligence responsible for it. In any such enterprise, the critic of poetry or painting can always quote, and the samples given convey the style and texture of the works discussed. But the music critic can only quote scores, not performances. Consequently he must fall back on analytical ideas: as when Nietzsche says of Wagner that "he does not sing, he speaks," and that his music is "unnatural—a sort of *acquired* language." Such conclusions do not much suggest music, but they at least offer material for debate.

NEXT the music critic calls to his aid various syn-
 thetical images—visual, tactile, or otherwise: as when Virgil Thomson says of the sound of a harpsichord that it tingled like the golden shower of Zeus on the skin of Danaë. Such images are much more vivid, but they are not debatable at all. We either find their application evident or we don't.

Now certain effects in the playing of Mr. Gould remind me of related ones in the paintings of Pieter Bruegel the Elder; elements in the playing of the late Dinu Lipatti, on the other hand, remind me of certain stylistic traits found in the pictures of Sandro Botticelli. But if Mr. Gould happens to remind you of Grandma Moses, and Dinu Lipatti of Alma-Tadema, there isn't a great deal I can do about it, since my analogies are essentially unprovable.

Moreover, the metaphoric process contains hidden conceptual pitfalls for even the wariest. I have never

GOULD

Right: Primavera, by Sandro Botticelli.

Opposite page: January, by Pieter Bruegel the Elder.



very sociable parties in the picture frames are both Renaissance painters—the airborne one being an uncannily “modern” Fleming (*fl.* 1565) and the one on the floor a self-portrayed Florentine a century older. What common cause brings them together here?

Given the pianist, Johann Sebastian Bach's presence is no riddle. Like the composer's bust, Glenn Gould's Bach recordings belong in the foreground of his career—placed there, in a sense, by Mr. Gould himself. He is perhaps the chief exemplar of a new breed of pianist with a special long-range relation to audiences. He has declared himself more concerned with recording than with concertizing. Performance as a triumphant public rite means less to him than performance recorded as a permanent document—a document prepared in private (and with inordinate care) for the inspection of history. In this sense, he works more like a studio painter than a platform virtuoso.

But Mr. Gould's Bach recordings are also uncommonly interesting for stylistic reasons. In an era of flavorless conformism, they exhibit the strong-minded individuality that has made his larger career consistently newsworthy. Their vitality defies the lethal coterie labels and the querulous latest-fashions-in-Bach approach. Mr. Gould, of course, belongs to a generation brought musicologically up-to-date in its cradle: I doubt that he loses much sleep over the dogmas of double-dotting, the province-by-province mutation of ornaments, or the official latitudes permitted this month by the Urtext alla breve time signatures. Like any self-respecting Baroque-era performer, he applies these resurrected conventions when they advance his conception, and he reshapes them, often radically, when they don't.

To mention just one example: Mr. Gould has little use for the extreme dynamic and coloristic contrasts made possible by the twentieth-century piano (some critics have noted that he seldom uses a real fortissimo). But this neglect is not, so to say, legislative. He simply has his own devices for the hyperarticulation of a given passage through, first, staccato-legato contrasts (further discussed below), and second, a sensitive compression or attenuation of time values in the vicinity of his principal structural crises—modulations, cadences, repetitions, etc. This is not to be confused with rubato, and it cannot even be called “distortion” if by that term we mean something unrelated to formal organization. It was common enough in Baroque architecture, and we may compare it roughly to the optical projection known as anamorphosis, illustrated below. If the “distorted” lower head is viewed at eye level along the dotted line, it will be found identical with the conventionally presented upper one. All its elements are organically intact, but their spatial relation is changed by the pressures of a systematically altered perspective. In painting, this process gives us the superbly elongated figure of the Negro Magus in Bruegel's *Adoration of the Kings*, shown on page 34. In Mr. Gould's Bach, it similarly throws into a striking dramatic relief any number of details ordinarily unobserved. His recordings of even the most familiar scores consequently give an impression of fresh observation. They are, as many listeners have remarked, full

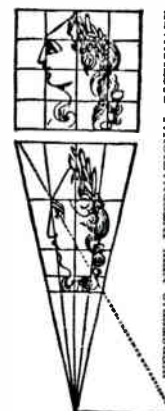



Glenn Gould: as among Bach, Botticelli, and Bruegel

By Robert Offergeld

ANY WAY YOU look at it, the four names above (and their respective faces) are an odd confraternity. The deep-eyed young man on the kitchen stool is a Canadian pianist. Beside him is the beetle-browed bust of a Thuringian composer who died in 1750. The two not

Can you find
another kit that
offers so much
for \$99⁹⁵?

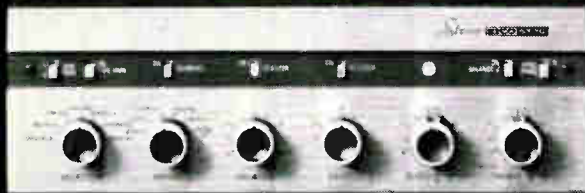

EICO ST70, 70-WATT STEREO AMPLIFIER

Beyond the performance level of these two units, possible improvement is merely marginal and very expensive. That's why with EICO's ST97 and ST70 you strike the optimum balance of cost and performance—each costs less than \$100 as a kit. You can also get the ST70 and ST97 factory-wired for \$149.95 each—and you couldn't find comparable wired units at the price.

If high power isn't your primary need, you can get superb sound for even less with EICO's ST40, the 40-watt counterpart of EICO's outstanding ST70. The ST40, essentially equal to the ST70 in all but power, costs \$79.95 as a kit, \$129.95 factory-wired.

ST70 DATA: As the center of your stereo system, the ST70 accommodates all program sources. It even has separate inputs for both turntable and record changer, preamplified tape signals and tape head with correct equalization for both fast and slow tape speeds. A center channel output feeds directly on a center channel speaker or, where desired, extension speakers throughout your house without any additional amplifier. Critical parts—filter capacitors, rectifiers, output tubes—all operate well below their ratings to assure long, trouble-free life. Oversize output transformers deliver full rated power all the way down to 30 cps. . . . And as a kit builder, you'll like the spacious layout. We got rid of all those tight places. Kit \$99.95. Wired \$149.95 (includes metal cover).

SPECIFICATIONS ST70 Output Power: 70 watts (continuous sine wave 35-watts per channel) *IM Distortion:* 1% at 70 watts. *Harmonic Distortion:* less than 1%. *Frequency Response:* $\pm 1/2$ db 10-50,000 cps. *Inverse Feedback:* 17 db. *Stability Margin:* 10 db. *Hum and Noise Level:* ⁹ mag. phono—63 db; tape head—54 db; tuners, auxiliaries—78 db. (all measurements according to IHFM standards.)

Can you find
another kit that
offers so much
for \$99⁹⁵?



EICO ST97 FM STEREO TUNER

ST97 DATA: Building the ST97 FM stereo tuner requires no instruments, no critical adjustments. The front end and IF stages are fully pre-wired and pre-aligned. The tunable coils of the stereo demodulator are factory-adjusted. With four IF stages plus a stable, sensitive front end, the ST97 pulls in clear stereo even under fringe conditions, and EICO's filterless zero-phase shift stereo detector (patents pending) maintains reliable channel separation. EICO's unique traveling tuning eye makes tuning simple and precise. Stereo stations are automatically identified by a pilot light. Semi-kit \$99.95. Wired \$149.95. (Includes metal cover and FET.)

SPECIFICATIONS ST97. *Sensitivity:* 3 μ v (30 db quieting). *Sensitivity for phase-locking (synchronization) in stereo:* 2.5 μ v. *Full limiting sensitivity:* 10 μ v. *Detector Bandwidth:* 1 megacycle. *Signal-to-Noise Ratio:* -55 db. *Harmonic Distortion:* 0.6%. *Stereo Harmonic Distortion:* less than 1.5%. *IM Distortion:* 0.1%. *Frequency Response:* ± 1 db 20 cps-15 kc. *Capture Ratio:* 3 db. *Channel Separation:* 30 db. *Controls:* Power, Separation, FM Tuning, Stereo-Mono, AFC-Defeat (all measurements to IHFM standards).

⁹Actual distortion meter reading of derived left or right channel output with a stereo FM signal fed to the antenna input terminals.

See these superb components at high fidelity dealers everywhere. For FREE 32-page catalog, 36-page Stereo Hi-Fi Guide (enclose 25c for handling) and dealers name, write: EICO ELECTRONIC INSTRUMENT CO. INC., 3300 Northern Boulevard, Long Island City, New York. Dept. HR-6



Add 5% in West.



HFE-90 FM TUNER
kit \$39.95 wired \$65.95

RP 100 STEREO TAPE DECK
semi-kit \$299.95 wired \$399.95

HFS-6 3-WAY
3-SPEAKER SYSTEM
kit \$52.50 wired \$62.50

How you can own a superb 30 watt FM Stereo Receiver for only \$169.95

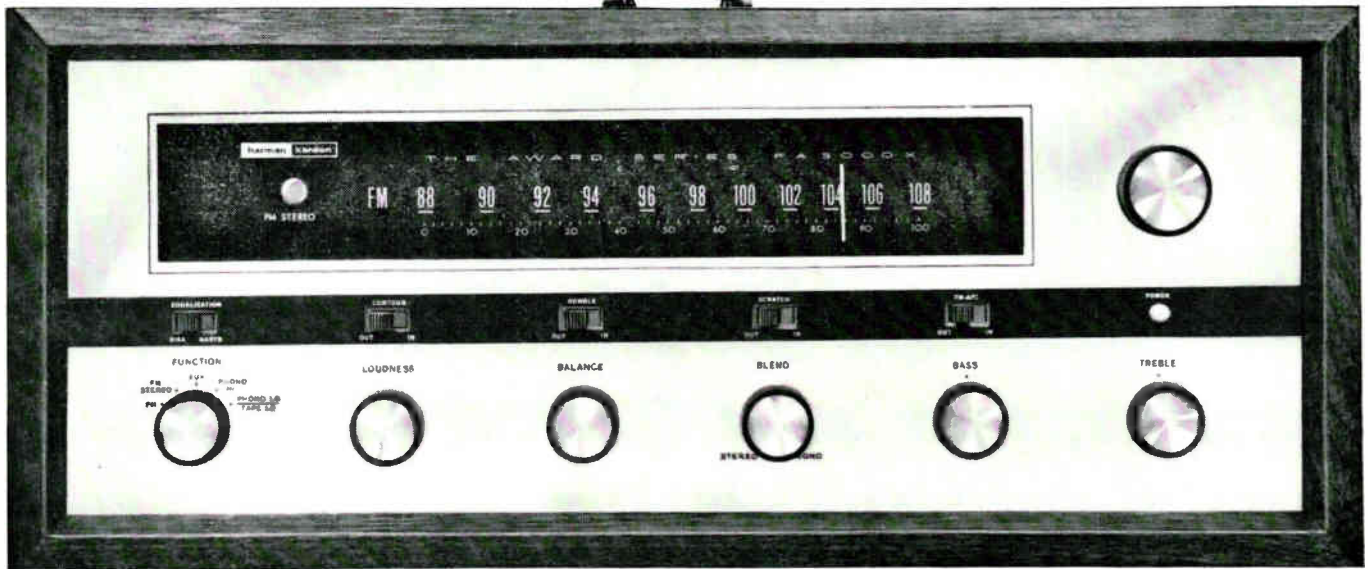

Build it!

The new Award FA30XK—world's first FM Stereo Receiver Kit. One handsome, compact chassis has it all: a sensitive FM stereo tuner, a versatile stereo control center and a clean 30 watt stereo amplifier. Here's the heart of a fine home music center—with every useful operating feature you'll ever need.

It's yours for the remarkably low price of \$169.95 because you build it.

This is an Award kit. The most functional kit ever designed. Open it. It looks like—and literally is—a complete, miniature home workshop.

It's designed to make work quick, easy and enjoyable. Note how each component is readily accessible on shelves or pull-out trays; how everything is clearly marked and arranged in proper building sequence. You have at hand what you need as you need it.

Wires are pre-cut; tube sockets and terminal strips riveted to the chassis. Critical elements, such as the RF and oscillator stages are pre-assembled and factory aligned.

The eased, spiral-bound, fully-illustrated instruction book is a model of clarity and organization. No matter how inexperienced you are you'll find it difficult to make a mistake. The book won't let you.

And there's also the satisfaction of knowing just *what* you're doing and *why* every step of the way. The book contains simple explanations of the operating theory of each section you build.

You can also obtain the factory wired version of the kit for only \$219.95—the remarkable FA3000X FM Stereo Receiver. Ask your Harman-Kardon dealer for a demonstration. You'll see and hear why this fine

instrument is *the* "best buy" in high fidelity today. (All prices slightly higher in the West.)

For full information write to Dept. R-6, Harman-Kardon, Inc., Plainview, N. Y.



harman kardon

housing is an infinite baffle, like other large Bozak systems. The eight tweeters are arranged vertically along one side of the cabinet front, following the theory discussed in the recent article "Directions in Loudspeaker Design" (HiFi/STEREO REVIEW, April, 1963). The idea seems to work well, since there was relatively little beaming of high frequencies.

My machine-run indoor frequency-response curves, averaged for six microphone positions, correlated well with the verdict of my ears. The mid-range response, from 100 to 1,300 cps, was exceptionally smooth and flat, within ± 2 db. This vital range spans most musical frequencies, and is handled almost entirely by the 8-inch mid-range speaker. At the upper crossover frequency there was a peak of about 5 db, with a smooth response above that point (± 2.5 db from 2,300 to 13,000 cps). Low-frequency response rolled off at a 12 db/octave rate below 80 cps; however, a substantial amount of clean bass could be developed down to about 40 cps. Below that frequency, the response fell off sharply.

Listening tests generally confirmed the response measurements. The sound was large and enveloping, ideally suited to sizable listening rooms, yet well-integrated only a few feet from the speaker. The bass was adequate, but not as full or as well-defined as that of some other high-quality (but smaller) systems I have tested. The highs were typically Bozak, which is to say musical, tinkly, and bright. Record hiss was accentuated by a peak in the response curve at about 8,000 cps.

I suspect that a large, well-upholstered listening room would be most suitable for appreciating the musical qualities of this speaker. It has the essential characteristics of the largest Bozak systems, which have won many adherents over the years, at an appreciable saving in size and cost.

Available in walnut, mahogany, or ebony finishes, the B-4000 is priced at \$495.



**SCOTT MODEL 340
STEREO
TUNER-AMPLIFIER**

● BECAUSE OF its compactness and reduced cost, the integrated tuner-amplifier has captured a large part of the component market. Obviously, the cost and installation advantages of having the stereo tuner, preamp, and amplifier all on one chassis would be negated if quality or flexibility were lost. Fortunately, the better tuner-amplifiers, such as the Scott Model 340, which includes two 30-watt (music-power rating) amplifiers and a stereo FM tuner, suffer not at all in comparison with separate-component installations.

The Model 340 offers all the flexibility one could

desire. In addition to all the standard controls and functions, there are tape-head inputs, tape monitoring, scratch filters, switchable loudness compensation, etc. The FM tuner section has the Scott "Sonic Monitor" to signal the presence of a stereo broadcast, a subchannel filter to reduce noise on weak stereo signals, and a tuning meter.

Lab measurements indicate that the published specifications of the 340 are generally quite conservative. For example, I measured 66 watts combined output (both channels driven) at 2 per cent intermodulation distortion and 57 watts at 2 per cent harmonic distortion (1,000 cps). Combined power output at 2 per cent distortion exceeded 50 watts between 25 cps and 15,000 cps. At usual listening levels, the distortion was less than 0.3 per cent. The frequency response and phono equalization were excellent, within ± 0.5 db between 30 and 15,000 cps. The NAB 7½-ips tape-playback equalization was within -3 db down to 30 cps. Hum under my standard test conditions was -69 db on PHONO, -56 db on TAPE, and -72 db on EXTRA, all referenced to 10 watts. The scratch filter was rather gradual in its action (6 db/octave), but did an acceptable job.

The Model 340's FM tuner had 2.5 microvolts sensitivity (IHF), noncritical tuning, and very low drift. Its frequency response (in stereo mode) measured ± 1.5 db from 50 to 15,000 cps, which matches the FCC broadcast standards. Stereo channel separation was excellent, averaging 35 db between 20 and 10,000 cps, and 22 db at 15,000 cps. Distortion in the FM tuner (mono) was about 1.2 per cent at 100 per cent modulation. The capture ratio was 4.9 db, and hum was 54 db below 100 per cent modulation.

To sum up, the Scott 340 tuner-amplifier does what one would expect of a high-quality stereo FM tuner and amplifier, and does it very well indeed. The amplifiers are husky enough to drive the most inefficient speakers, and the tuner is more than adequate for any but the most remote fringe areas. When connected to a pair of good speakers, the Scott 340 delivers a caliber of sound which should satisfy the most critical listener. It sells for \$379.95, less cabinet.

Editor's Note: At press time we were informed that Scott would shortly have available a new model, the 340B. Scott states that several convenience features have been added, such as a slide-rule-type dial, a front panel earphone jack, a rumble filter, and automatic stereo FM operation. In addition, an improved power supply makes possible a 35-watt per channel music-power rating. However, according to Scott, the new model's circuitry is essentially identical to the older 340, and hence the above review is also applicable to the new unit.

For additional product information, use the reader service card. Circle number 188 for the Bozak Model B-4000 "Symphony No. 1" speaker system, and number 189 for the Scott Model 340 stereo tuner-amplifier.



TECHNICAL TALK

by JULIAN D. HIRSCH



● **MEASUREMENTS:** A reader writes to ask why my measurements of two essentially identical tuners made by the same manufacturer show a wide discrepancy in sensitivity, distortion, and hum. In a letter to *HIFI/STEREO REVIEW*, a tuner manufacturer raises the same question in regard to my testing of his products. Some clarification of this matter is certainly in order.

First of all, it may not be appreciated by the layman that there is no such thing as an absolutely accurate measurement. No matter how good the equipment or how careful the user of it, any electrical measurement is subject to certain errors. A voltmeter, for example, is calibrated by comparing it with a more accurate instrument, called a secondary standard. This secondary standard, in turn, may be calibrated against a primary standard, such as those at the National Bureau of Standards. At each stage of the calibration procedure it is possible to establish reliable accuracy figures. A typical laboratory voltmeter may have 2 per cent accuracy when calibrated against a secondary standard of 0.25 per cent accuracy or better.

Unfortunately, at frequencies above 30 megacycles, it is simply not possible to guarantee the same sort of accuracy as at lower frequencies. Most high-quality laboratory signal generators have a guaranteed amplitude accuracy of ± 10 per cent at high output levels, with some additional error likely at very low signal levels owing to leakage through the attenuator. Further errors may be introduced by slight mismatch of cable impedances between generator and tuner.

It is easy to see why FM tuner measurements made in one laboratory may differ appreciably from those made in a different laboratory, or with different test equipment. A 2.5-microvolt tuner could appear to have a sensitivity ranging from 2.25 to 2.75 microvolts, owing entirely to normal and unavoidable instrument errors. But this does not explain how two supposedly identical tuners can differ by a factor of two or three times in measured sensitivity. I think that there are two major causes of this problem. First, there may be some variation in the performances of individual mass-produced units as delivered to the customer. Gain of a tube type may vary greatly from sample to sample, and high hum levels, frequently due to tube deficiencies, may appear after a certain period of operation. Since

I usually run a tuner for at least several days before testing it, such deterioration would be reflected in my test results.

The second cause has its roots in the definition of "usable sensitivity" by the Institute of High Fidelity (IHF): it is the minimum input to the tuner, in microvolts, of a 100 per cent modulated FM signal that results in a combined distortion, hum, and noise level of 3 per cent in the tuner's audio output. If the tuner is slightly out of alignment, it will have increased distortion, and more input signal will therefore be needed to achieve the 3-per-cent level. The result is apparently a degraded sensitivity, but is really increased distortion. Unfortunately, many tuners are shipped with less than perfect alignment or may end up in that condition because of rough handling in transit. These problems are more likely to occur with inexpensive units, but even the best tuners are not free of them.

BOZAK B-4000 SPEAKER SYSTEM

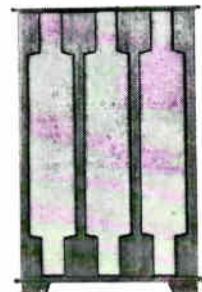

● Bozak has long been a proponent of large speaker systems, and the B-4000 is in that tradition. For those music listeners who have the space and funds, and the conviction that big sound cannot be expected to emerge from a bookshelf speaker, there are several Bozak speaker systems to choose from. About in the middle of the Bozak line, in size and price, is the Model B-4000 "Symphony No. 1." This imposing unit stands 44 inches high, 37 $\frac{3}{4}$ inches wide, and 16 inches deep. In it are two 12-inch B-199A woofers, an 8-inch mid-range speaker, and eight B-200 tweeters. These last are the small cone-type units long familiar to Bozak fans. The built-in crossover network operates at 200 and 1,500 cps, and the system impedance is 8 ohms.

Although I did not open the cabinet, the B-4000

Why Sherwood "zeroed-in" on the problem of tuning accuracy

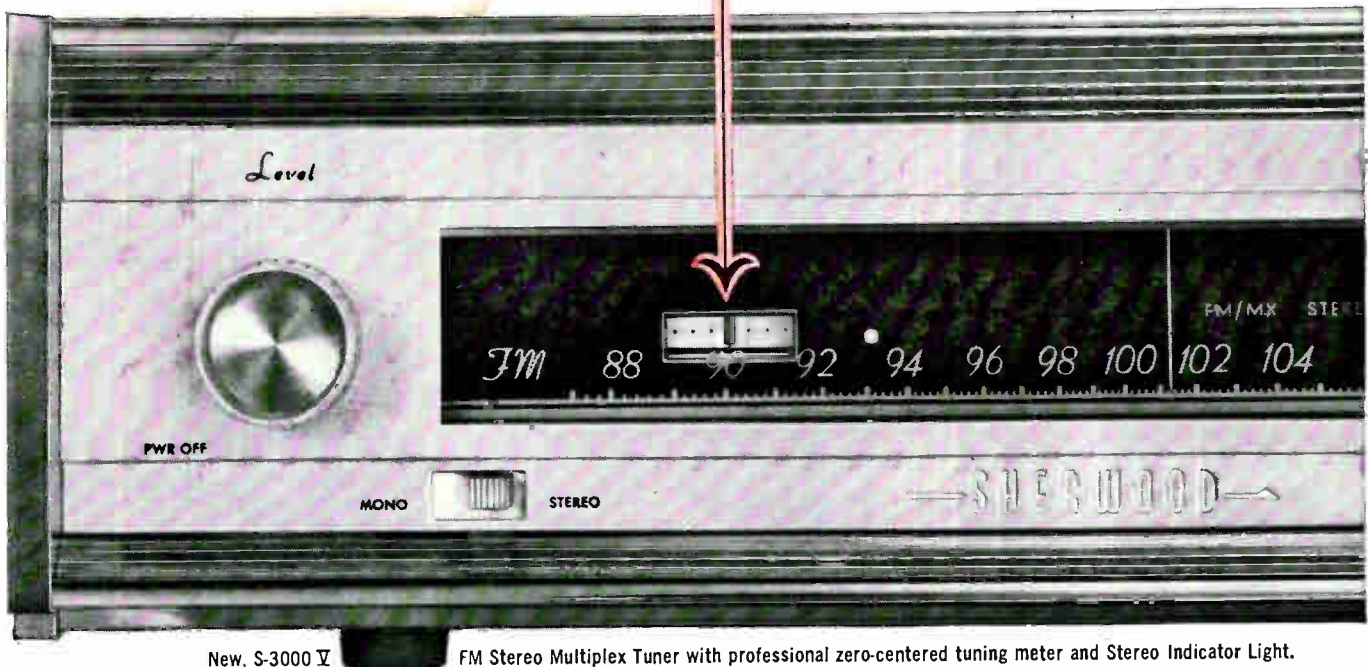

New, S-3000 V FM Stereo Multiplex Tuner with professional zero-centered tuning meter and Stereo Indicator Light.

The wider band requirements for the stereo information now being multiplexed on FM channels has made precision tuning a factor more-important-than-ever in FM reception.

Tuning eyes are good. Peak meters have value. But, these are yesterday's achievements applied to today's and tomorrow's needs.

This is why Sherwood engineers have incorporated a professional, zero-centered meter in the new S-3000 V Tuner. It tells when you are exactly on frequency. No guesswork. No maybe's. Only assuredness!

What difference does Sherwood professional zero-centered meter tuning make?

Quite a lot. It makes possible accurate, first-attempt tuning. You will find it isn't necessary to tune and then step back to listen and verify whether you tuned in correctly.

Secondly, "zeroed-in" tuning is particularly beneficial to obtaining minimum distortion and maximum stereo separation due to the added information multiplexed on FM stereo channels.

Third, you will just plain appreciate the added professional touch Sherwood has added to an already professional-quality FM tuner.

A bonus in tuning ease

Added to the professional accuracy of zero-centered meter tuning, Sherwood gives you a "can't-be-fooled" Stereo Indicator Light. Stereo broadcast identification is instant and positive.

This restless attention to all the details which can improve performance is why Sherwood components have been . . . and will continue to be . . . outstanding values.

Other value features of the S-3000 V

- Superb sensitivity: 1.8 μ v (IFM) for -30 db. noise and distortion.
- Wide-band 3-mc. Gated-Beam Limiter and 1-mc. Balanced Ratio Detector: combine to suppress background noise introduced by stereo FM and create the pace setting capture effect of 2.4 db.
- FM Interchannel Hush: eliminates the "rushing" noise between stations.
- Flywheel tuning: made with turntable accuracy for smoothest, fastest tuning.
- Dial spread: communications-type 20% longer scales provide professional accuracy.
- Price: \$165.00 (less case).



If you want a component that combines tuner and 80-watt stereo amplifier in one compact chassis . . . see the new S-8000 III FM Stereo MX Receiver. Has zero-centered professional tuning meter and Stereo Indicator Light.
Price: \$319.50 (less case).

Sherwood

H I G H F I D E L I T Y

For complete information write Dept. R-6
Sherwood Electronic Laboratories, Inc.
4300 North California Avenue, Chicago 18, Illinois

Stereo Receivers • Tuners • Amplifiers • Stereo Indicator Lights • Speaker Systems • Contemporary Cabinetry



Listen. That's the only way to choose a speaker system! On this subject, you become the expert, for *your ear* is the only valid judge of the sound you want to live with over the years.



Suppose, for example, you are interested in any one of four fine bookshelf speakers—the AR-2A, the KLH-10, the Jensen TF-3 or the University Senior II. Ask your dealer to demonstrate the systems.



You will soon discern differences between the Senior II's 12" woofer and the AR-2A's 10" unit, as well as the woofers in the other systems. One is bound to sound richer, fuller, truer.



As you listen, remember, the sound you choose must be right for *you*...not the dealer (he has his own personal preference)...not your friends...not the hi-fi editors you read...only you.



Ask to hear records featuring solo performances to help you determine the quality of each system's mid-range capability. One will have more "on-stage" feeling than the others.



Listen to the "highs"—these delicate shadings and nuances are exciting when reproduced without distortion. The Senior employs the same Sphericon super tweeter used in our \$300 Classic system!



Now you are ready to judge the overall character of these systems. You are less likely to be deceived by exaggeration or coloration...better prepared to determine which system has the more natural, balanced sound.



Once you have auditioned the Senior in comparison with other bookshelf systems, we know you will prefer its sound. Most people do. In 7 out of 10 listening demonstrations, the "easy-to-live-with" sound of the Senior prevailed.

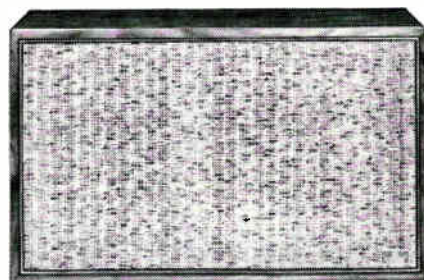

Specifications: *Response:* 30-20,000 cps. *Three-speaker system includes:* Ultra-Linear response 12" woofer (instead of the conventional 10" unit); special 3½" mid-range speaker plus top-rated Sphericon Super Tweeter. *Crossover:* 3000 cps. Adjustable brilliance control. Exclusive RRL tuned enclosure for maximum sound output, minimum (virtually immeasurable) distortion. Oiled walnut finish, \$99.50. Other University bookshelf speakers from \$44.95. For 20-page "Guide to Stereo Hi-Fi", write Desk D-6.

UNIVERSITY LOUDSPEAKERS Division of Ling-Temco-Vought, Oklahoma City, Oklahoma

Send all equipment for service to our newly located Service Department, 9500 West Reno, Oklahoma City, Okla.

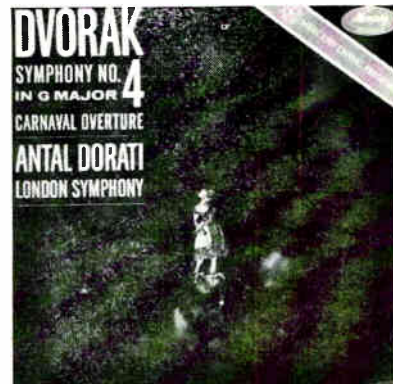
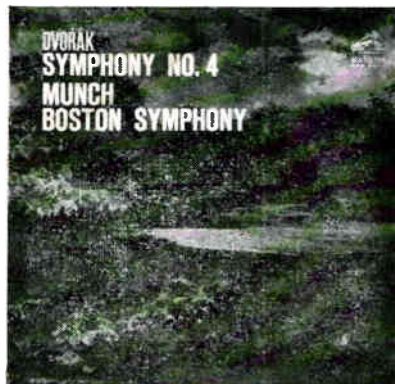
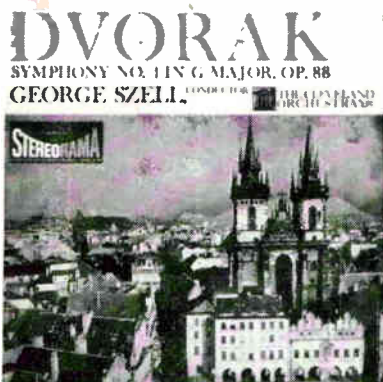

Warm and exuberant, the Szell-Cleveland stereo recording of Dvořák's Fourth Symphony is particularly remarkable for the beautifully shaped performance of the third movement. More virtuosity and less introspection may be found in the readings delivered by Munch and the Boston Symphony or Dorati and the London Symphony—the former robust and athletic, the latter hard-driven and exhilarating.

commentators. After the London premiere, a critic remarked upon the symphony's "pastoral character. . . . All is fresh and charming." Dvořák composed the G Major Symphony in 1889 as a token of appreciation for his election to the Prague Academy. In the manuscript the score is dedicated "To the Bohemian Academy of Emperor Franz Josef for the Encouragement of Art and Literature, in thanks for my election." Its first performance was given in Prague in February, 1890. Two months later Dvořák conducted it in London with the London Philharmonic Orchestra, and the score was eventually published by the English firm Novello—circumstances that led to the work's being known at one time as the composer's "English Symphony." This now-discarded title was actually no more irrelevant to the G Major Symphony than the nickname "New World Symphony" is to the E Minor. Both symphonies—indeed, almost everything Dvořák wrote—have in abundance the folk spirit and atmosphere of Bohemia. If the G Major Symphony is to be called by any title, that title most assuredly should be "Bohemian Symphony."

In the years before the long-playing record, the Václav Tálích-Czech Philharmonic recordings of Dvořák's First, Second, Fourth, and Fifth Symphonies were the classic performances of these scores. That they were the only recordings of all but the "New World" really had no bearing on the matter, for Tálích revealed all there was in the music. This goes for the Fourth as much as for any other. Tálích and Dvořák are as indivisible in the minds of long-time record collectors as Beecham and Delius, or Koussevitzky and Tchaikovsky. During the 1940's Columbia released a recording of the Dvořák G Major Symphony by Bruno Walter and the New York Philharmonic—a performance subsequently transferred to LP and still listed in the Columbia catalog as ML 4119—but for me this performance never had the grace or poetry of Tálích's.

A few years ago the now-defunct Artia label issued an LP performance of the G Major Symphony by Tálích and the Czech Philharmonic that I have always suspected was a transfer of the performance we grew up with in the Thirties and Forties on Victor—the sound of those 78's was always amazingly good. Those

fortunate enough to own Artia ALP 178 own the most idiomatic performance of this symphony ever recorded. Incidentally, it is still listed in the Schwann catalog.

During the past few years there has been a generous outpouring of recordings of the score in stereo. The symphony has been extremely well served. One of the first stereo issues was the performance by George Szell and the Cleveland Orchestra (Epic BC 1015, LC 3532). By and large this is still the stereo version I prefer. Szell brings lyric warmth and exuberance to his performance, the playing of the orchestra is superb, and the recording—the first in Cleveland's Severance Hall after its acoustical renovation in 1958—is still quite good. Where Szell is especially triumphant over all his current competition, Tálích excepted, is in his disarmingly gentle and exquisitely shaped performance of the third movement, one of the most treasurable of all Dvořák's creations.

A performance in a style similar to Szell's is the one Bruno Walter recorded for Columbia on the West Coast with his hand-picked group of instrumentalists (Columbia MS 6361, ML 5761). This is a far more sensitive and atmospheric performance than his earlier one, but in the final analysis it falls a bit short of the persuasiveness and penetration of the Szell recording.

The symphony also lends itself to rather high-powered virtuoso treatment, and two such performances are to be found in the current catalog, by Dorati and the London Symphony Orchestra (Mercury SR 90236, MG 50236), and Munch and the Boston Symphony Orchestra (RCA Victor LSC/LM 2629). The Dorati is rather too hard-driven for my taste, especially in the outer movements, but it is an exhilarating experience nonetheless. The Munch performance is a satisfying one. It lacks the special personal involvement that Szell brings to his reading, and Walter's is undeniably a more mellow performance. But Munch conveys a robust, athletic vigor, and the recorded sound here is the most vivid of the lot. The version by Giulini and the Philharmonia Orchestra (Angel S 35847) is neat and refined, but has little individual personality.

In sum, then, the Szell recording is the one I recommend, with Munch a suggested alternative for those who prefer a more extrovert account of the score.

*Dvořák's G
Major
Symphony*

*Antonin Dvořák conducting an orchestra
at the World's Columbian Exposition in Chicago,
August 12, 1893. (Drawing by E. V. Nádherný)*



QUIETLY BUT STEADILY in the past few years, the music of Antonin Dvořák has been enjoying a renaissance in our musical culture. A project whose aim is to record all the Dvořák string quartets is well under way, superior performances of the composer's Requiem and Stabat Mater are now on discs, and many conductors in different parts of the world are suddenly discovering that the Bohemian master composed symphonies other than the ubiquitous E Minor, the "New World Symphony." This is as it should be, in my opinion, for Dvořák may well be the

most underrated composer of the nineteenth century. As a symphonist, certainly, his stature was not fully appreciated until very recently. Dvořák's symphonic output spans a period of nearly three decades, and together, the nine symphonies (five commonly known by their numbers and four early ones known by their key signatures) represent the peak of his creative impulse.

The G Major Symphony, the Fourth (actually the eighth Dvořák wrote), is one of the loveliest, most spontaneous works in the repertoire. Its bucolic nature inevitably suggested the Bohemian countryside to

Now you know why you waited

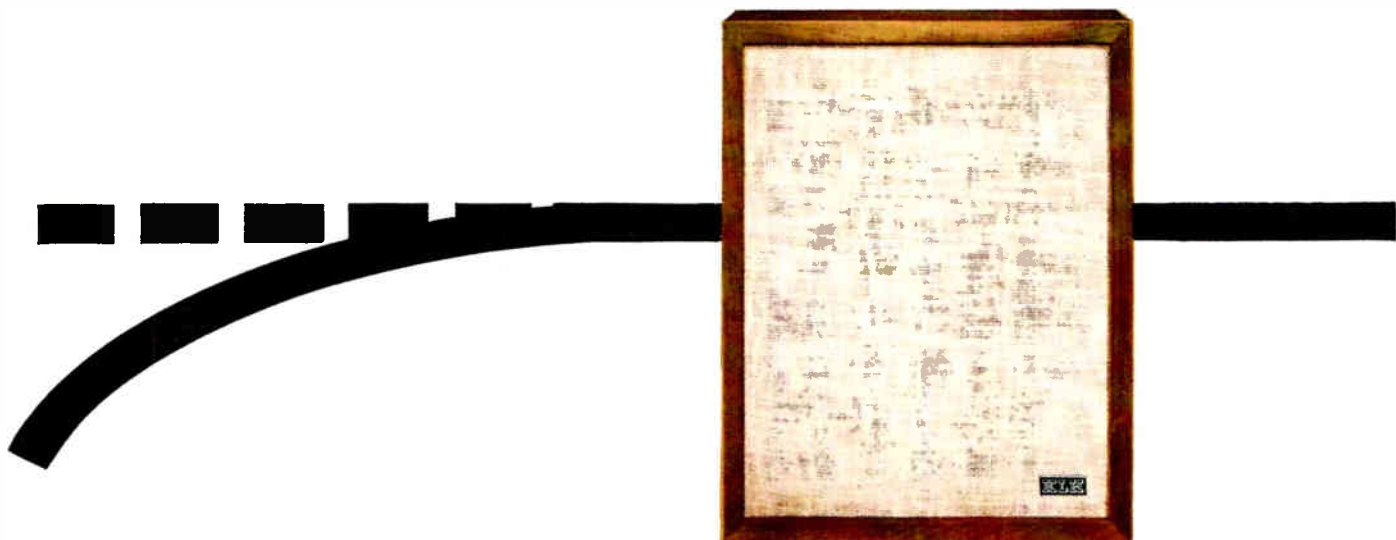

KLH has just introduced a new speaker system — the Model Fourteen — designed to accomplish two objectives: — to reproduce music (1) with less distortion and (2) with more bass than has heretofore been possible for a small speaker system. Inside the compact enclosure of this new speaker are a number of vital departures from any speaker system ever produced before.

The Model Fourteen employs two extremely compliant *full-range* speakers. The diameter of their cones is only 3". Their maximum excursion is $\frac{3}{8}$ ". This excursion is controlled by the highest ratio of magnet power to cone lightness ever engineered into a loudspeaker.

There are a series of problems involved in achieving good bass response in a small speaker system. First, all speakers roll off in the bass region. Small speakers have higher resonant frequencies and roll off at higher frequencies than large speakers. But a large speaker is not effective in a compact enclosure. The conventional small speaker is no better, since it cannot move enough air to produce respectable bass.

In the Model Fourteen, part of the answer is a small speaker with a very powerful magnet and long excursion. This provides two great advantages — the ability to move large volumes of air, and the precise control over cone movement necessary for freedom from distortion. It also provides a problem, however, since the damping effect of the heavy magnet increases at the lower frequencies. This reduces the bass output of the speaker.

The rest of the answer is the first use, in a small

multi-speaker system, of a revolutionary technique which we call *frequency contouring*. This technique was pioneered by KLH in the now famous Model Eight FM Receiving System and Model Eleven Portable Stereophonic Phonograph — each generally conceded to be the finest example of its class yet produced. Incorporated in the Model Fourteen is a passive electronic network which reshapes the power output of any conventional amplifier to match exactly the low frequency power requirements of the speakers, so that their response curve remains flat far below its normal roll-off point.

This technique can only be applied successfully with speakers whose low frequency response is held precisely to a profile of certain specific characteristics. Only because the speakers used in the Model Fourteen — including their impregnated paper cones — are designed and manufactured in our own plant can they be held to the rigid uniformity required for the use of frequency contouring. No commercially supplied cones have the necessary uniformity. No other manufacturer of small full-range speakers produces its own cones.

The result is a range and quality of reproduction you have never heard before in a compact speaker. The Model Fourteen, at any given level of overall loudness, will deliver more bass power, at lower frequencies, with less distortion than any other speaker system in the same range of cost or size.

The Model Fourteen's dimensions are 18" x 14" x 3 $\frac{3}{4}$ ". The price is about \$50. Wait no longer.



KLH RESEARCH AND DEVELOPMENT CORPORATION

30 CROSS STREET, CAMBRIDGE 39, MASSACHUSETTS

CIRCLE NO. 33 ON READER SERVICE CARD

**FROM THE EQUIPMENT REPORT SECTION
OF THE APRIL, 1963 ISSUE OF
HIGH FIDELITY MAGAZINE*
COMES THIS GLOWING STATEMENT:**

“The ADC-18’s reproduction of program material was eminently satisfying. The initial impression of listening to music through the ADC-18 was one of immediate acceptance, and this impression has been strengthened after weeks of listening. The speaker does not favor one type of music, or one family of instruments, over another. It is an impartial, honest, transparent reproducer...”

PREDICTION: The ADC-18 speaker system is destined to become the new standard by which all others will be judged.

ENGINEERING SPECIFICATIONS

Frequency Response ADC-18..20-20,000 cps
Power Requirements....10 to 65 watts R.M.S.
Bass Unit Magnetic Structure
Flux Density 12,700 Oersteds
Total Flux165,000 Maxwells

Treble Unit Magnetic Structure
Flux Density15,000 Oersteds
Total Flux53,500 Maxwells
Impedance8 to 16 Ohms
Net Consumer Price\$250

West Coast slightly higher



AUDIO DYNAMICS CORPORATION

Pickett District Road, New Milford, Connecticut

* The full report is available from us upon request

Write for complete information on the other models in our speaker line

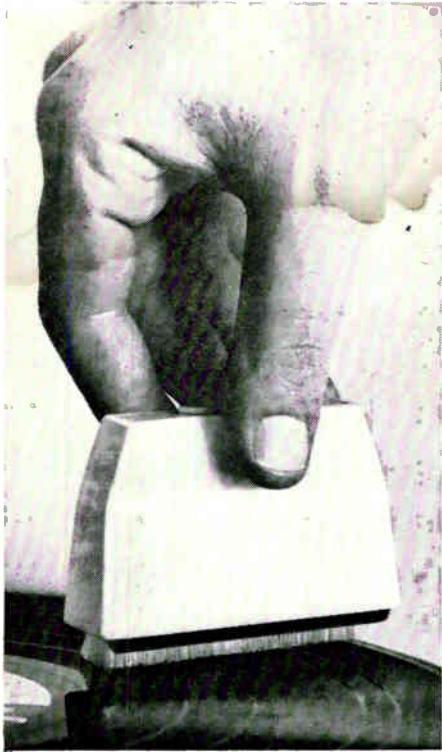

**the only ALL-IN-ONE
record cleaner...the
ADC HUSH-BRUSH**

- 1800 precision-ground nylon bristles
- 24 tufts — covering entire record groove width
- self-contained cleaner fluid supply
- completely eliminates record static
- completely removes all residue from record surfaces
- can never damage your records

The ADC HUSH BRUSH is unmistakably the most advanced record cleaning instrument available today. Each of its 1800 nylon bristles is precision ground to an ultra-fine .003 point. These bristles are spring loaded to exert the correct pressure required to efficiently clean today's finer cut record grooves. The felt pad releases just the correct amount of its self-contained de-staticizing detergent cleaner fluid to gently loosen imbedded dirt and eliminate record static. Clustered in 24 tufts, they cover the entire groove width in one record cleaning movement while a highly absorbent felt pad neatly removes all residue from record surfaces. Nothing remains to clog your stylus assembly or interfere with sound reproduction. The ADC HUSH BRUSH will never damage your records. It will always protect them from the harmful grinding effects of dirt. The ADC HUSH BRUSH will clean your records more thoroughly and conveniently than was ever before possible. It costs \$11.95. For the life of your records, buy one today.



**AUDID DYNAMICS
CORPORATION**

Pickett District Road, New Milford, Connecticut

CIRCLE NO. 9 ON READER SERVICE CARD



TONE-ARM DESIGN—PART ONE

GUIDING a phono cartridge across a record seems, at first glance, so simple a task that one may wonder what all the fuss—and expense—is about. But unexpected electromechanical complexities, particularly in this day of light-tracking, high-compliance cartridges, make tone-arm design difficult and complex. An inadequate tone arm will degrade the performance of any cartridge, and the better the cartridge, the more stringent are the demands made on the arm.

The main function of a tone arm is to keep the cartridge properly lined up with the record groove. Ideally, the cartridge should be tangent to the groove throughout its travel across the disc. Elementary geometry tells us that the best way to achieve this would be to move the cartridge from the rim toward the center of the record in a straight radial line. But in actuality, because the tone arm turns on a pivot, the cartridge traces an arc. This discrepancy between the ideal and the actual path of the cartridge is called tracking error. It is stated in degrees of angle of deviation from true tangency.

The effect of excessive tracking error can be easily visualized if you imagine the cartridge riding askew in the groove. The walls of the groove no longer exert equal force on opposite sides of the stylus tip. At best, the imbalance results only in an unequal signal voltage delivered to the two stereo channels. At worst, the excessive pressure on one groove wall will force the stylus so far to one side that the signal is distorted.

One way of reducing tracking error is to lengthen the arm. Mathematically, if the arm were infinitely long, the tracking error would be zero. However, tone-arm designers, who are forced to work with arm lengths somewhat less than infinite, have found ways to keep tracking error below two degrees even when the pivotal length of the arm is less than nine inches.

One might expect that true tangency could occur at only one place on the record. But by angling the head of the tone arm toward the center of the record and by mounting the arm so the cartridge travels toward a point slightly beyond the record center, it is possible to achieve not one, but two true-tangent points along the arc of tone-arm travel. Having two points of zero tracking error brings down the average error throughout the play. Some designers feel that it is more important to design tone arms for minimum over-all playback distortion than for minimum over-all tracking error. This is to say that they are willing to tolerate a slightly higher tracking error in the outer grooves, where tracking distortion is less audible, if, by so doing, they can reduce the tracking error at the inner diameters, where tracking distortion is more noticeable.

Aside from guiding the cartridge, the tone arm must also isolate it from all forces that would prevent it from responding completely to the record-groove undulations. The various adjustments for stylus pressure, balance stability, low frictional drag, etc., plus resonance control and low mass, are the design factors intended to accomplish this. They will be discussed in next month's column, along with some practical hints on tone-arm installation.

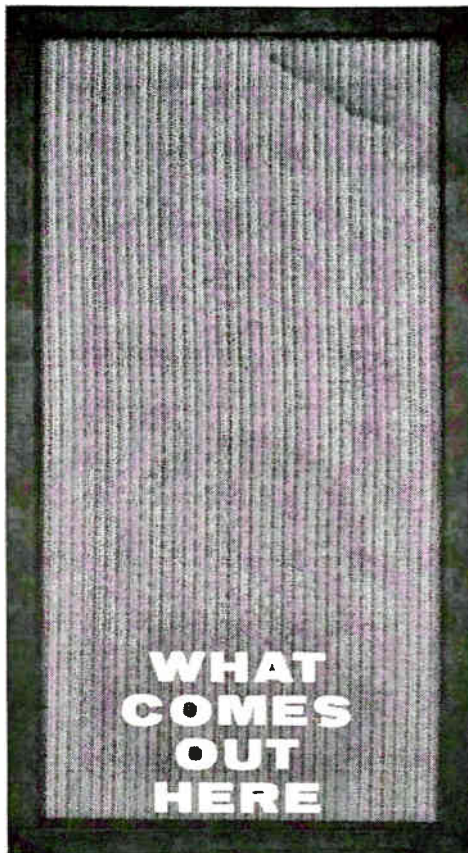

**WHAT
COMES
OUT
HERE**

**DEPENDS
ON
WHAT
GOES
THROUGH
HERE**

**"SKIMPING" ON THE CARTRIDGE
JEOPARDIZES THE SOUND
(AND SATISFACTION) OF THE
WHOLE SYSTEM**

The hundreds, even thousands of dollars you put into speakers, pre-amps, amplifiers, turntables and recordings can be virtually nullified by an off-hand selection of the phono cartridge. For even though it is the lowest-cost single component in the typical system, it is charged with the frighteningly complex task of getting the music out of the grooves and translating it into precise electrical impulses . . . without addition, subtraction, or distortion. And without damaging the record grooves. Leading critics and noted audiophiles recognize this and (with due care and study) select a Shure Stereo



Dynetic cartridge for their personal systems. It was, from its inception, and is today the finest stereo cartridge your money can buy. And not much money, at that. The \$36.50 spent on a Shure M33-5 (if you have a fine tone arm that tracks between $\frac{3}{4}$ and 1.5 grams) or Shure M33-7 (for tracking pressures from 1.5 to 3 grams) will audibly improve even fine quality stereo systems. Compliance is an astounding 22×10^{-6} for the M33-5 (20×10^{-6} for the M33-7). Response is transparent and smooth not only at the top and bottom but in the critical middle range (where most music happens—and where most other cartridges garble the sound). No "peaks," no "shattering." Et cetera, et cetera. Better listen to it, and judge for yourself.

**IF YOU INSIST ON A SHURE DYNETIC CARTRIDGE,
YOU CAN EXPECT MORE FROM YOUR SYSTEM**

SHURE

Stereo Dynetic

M33 SERIES HIGH FIDELITY PHONO CARTRIDGES
SHURE BROTHERS, INC. • 222 HARTREY AVE., EVANSTON, ILLINOIS

Patented and other patents pending.

(Continued from page 14)

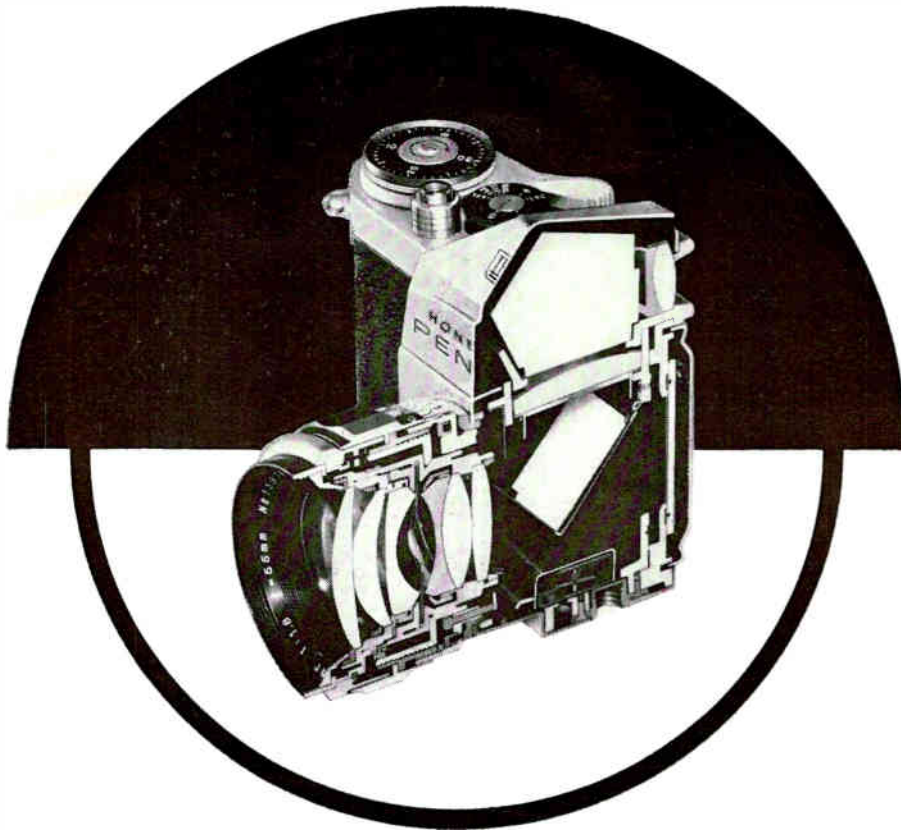

blink!

The human eye blinks several times a minute with no conscious interruption of continuous viewing. The instant-return mirror in the Honeywell Pentax camera works the same way. In its "down" position, it lets you look right through the lens. You know exactly what picture you'll get, because you see what the film will see. When you press the shutter release, the mirror blinks—it moves up as the film is exposed, then down again instantly to give you uninterrupted viewing for following action, changing focus, rearranging composition.

The reason the single-lens reflex camera is the most popular type in the world today is due, more than anything else, to the Pentax-invented instant-return mirror. Naturally, everyone has copied it. But so far no other cameras approach the Honeywell Pentax H-1 and H-3 in the combination of clean design, quality features, and reasonable price that make them the outstanding values in the field. See them at your Authorized Honeywell Pentax Dealer's soon.



For a full-color folder describing the H-1 and H-3, write: John Thornton, Mail Station 209, Honeywell, Heiland Division, Denver 10, Colorado

Honeywell
PHOTOGRAPHIC PRODUCTS

CIRCLE NO. 32 ON READER SERVICE CARD

pletely self-contained, the instrument has 10 watts of audio power available for each channel to drive external speakers or its built-in monitoring speakers. Among other features are: three motors; three separate tape heads; all-electronic piano-key controls; dual recording and playback amplifiers; dual VU meters; automatic rewind, replay, and shut-off. Three individual inputs per channel provide mixing, sound-on-sound, and echo effects. Monitoring can be done from either the recorded tape or from



the preamplifier input. The 47/26 can be operated vertically, horizontally, or (with an optional base) mounted at an angle. Frequency response is 30 to 20,000 cps ± 3 db at $7\frac{1}{2}$ ips and to 15,000 cps at $3\frac{3}{4}$ ips. Signal-to-noise ratio is -50 db at both speeds. Flutter and wow are less than 0.15 per cent at $7\frac{1}{2}$ ips and 0.25 per cent at $3\frac{3}{4}$ ips. Total harmonic distortion is 1 per cent. Accessories include a plug-in remote control, which permits the recorder to be operated from twenty feet away. Price: \$600.

circle 186 on reader service card

● **Winegard** introduces a transistorized FM-TV antenna amplifier designed for mounting directly on the antenna. Transistor failures caused by lightning flashes and power-line surges are eliminated. The Model RD-300, dubbed the



Red Head, has a high-pass interference filter, a built-in two-set coupler, and is a.c.-operated. It is recommended by the manufacturer for areas where signals are under $20,000 \mu\text{v}$. Price: \$29.95.

circle 187 on reader service card

THIS IS NO COMPACT!

54 inches high
9 feet around the middle

That's a lot of speaker system. Enough for what pleases you. It can whisper or it can bellow. It does both superbly, and anything in between. So much so that Hollywood's famous United Recording Corp. (sound studio for record, tape, film, and tv industries) employs 15 of them. As does Ray Heindorf, musical director of Warner Bros' production "The Music Man" and holder of 2 Oscars, who has four right in his living room.

No, this is definitely not a compact. It's a giant, this A-7 "Voice of the Theatre" by Altec. A full-size speaker system with quality to match. That's why it belongs in your home. Unless you are willing to settle for a compact "book shelf" speaker... and compact sound. Of course if you are a critical listener, you'll want your sound brought to life by Altec; sound so realistically reproduced, you'll find its equal only in the concert hall.

That much the A-7 will give you, and more. Almost in direct proportion to your own desire for perfection. If you insist on hearing the "full sound," the most subtle contribution of each instrument, the effortless reproduction of massive orchestrations at concert-hall listening levels, then the A-7 is for you.

Now here is a hint: you can't make it any smaller, but you can make it a lot prettier. All it takes is a bit of effort, some grille cloth, some veneer or paint and you can transform the A-7 into a custom furniture piece. For built-in installation, there's nothing so perfect. At only \$279.00 each, it's a wonderful do-it-yourself project... for the critical listener.

However, if you prefer your A-7 sound coming from a more civilized version, we have several solutions, in walnut or mahogany. There's the 831A "Capistrano," a full-size beauty that offers speaker components identical to the A-7 in a classically styled cabinet. It stands 30" high, 47" wide, and is priced at \$399.00.

The modern 838A "Carmel" is also a full-size, floor-standing system. It features two 12" low frequency speakers (instead of the one 15-incher in the A-7) and the same high frequency section. It's priced at \$324.00 with decorator base (shown) extra; standard model comes with round legs. The "Carmel" is also available with one low frequency speaker in a model called the 837A "Avalon," priced at \$261.00.

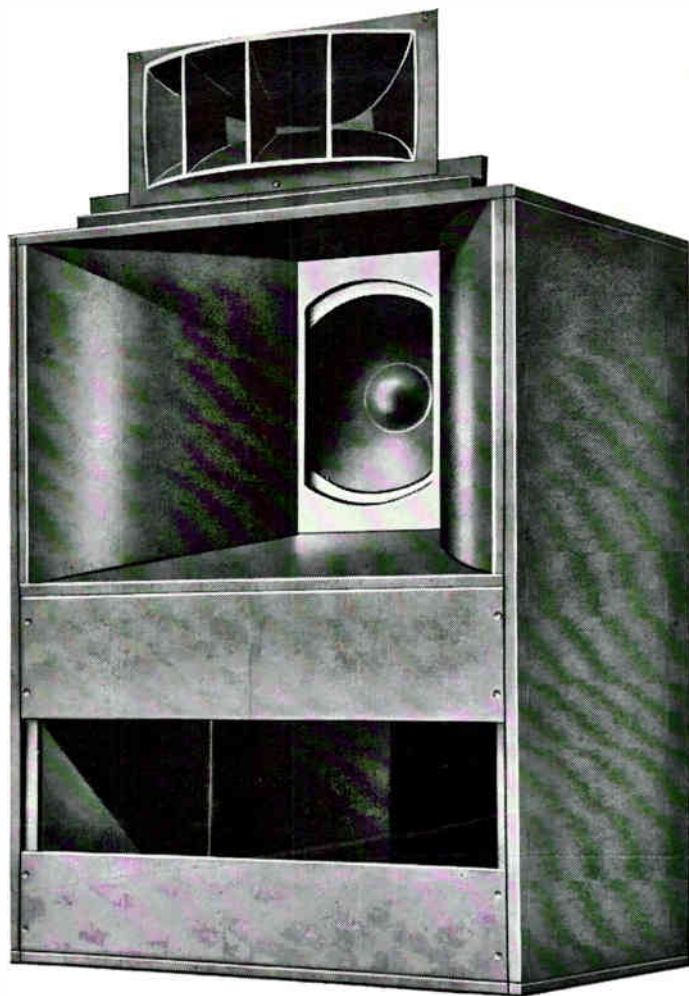

ALTEC 838A "CARMEL"



ALTEC 831A "CAPISTRANO"



NEW! ALTEC 841A "CORONADO" SPEAKER SYSTEM

Apartment-size version of the full-size Altec speaker systems, the "Coronado" is styled to match a pair of "Carmels" when used as the center speaker in an Altec 3-channel stereo system. Recommended for small apartments where space will not tolerate larger speakers. The "Coronado" is 30" H, 18" W, 14" D and is priced at \$199.50.

Go ahead, convince yourself! The A-7 (and its prettier mates) are ready to tantalize you now, at your Altec Distributor's. Or, for latest stereo catalog, write Dept. SR-6.



ALTEC LANSING CORPORATION

LTV A Subsidiary of
Ling-Temco-Vought, Inc.

1515 South Manchester Ave., Anaheim, Calif.

©1962 ALTEC LANSING CORPORATION

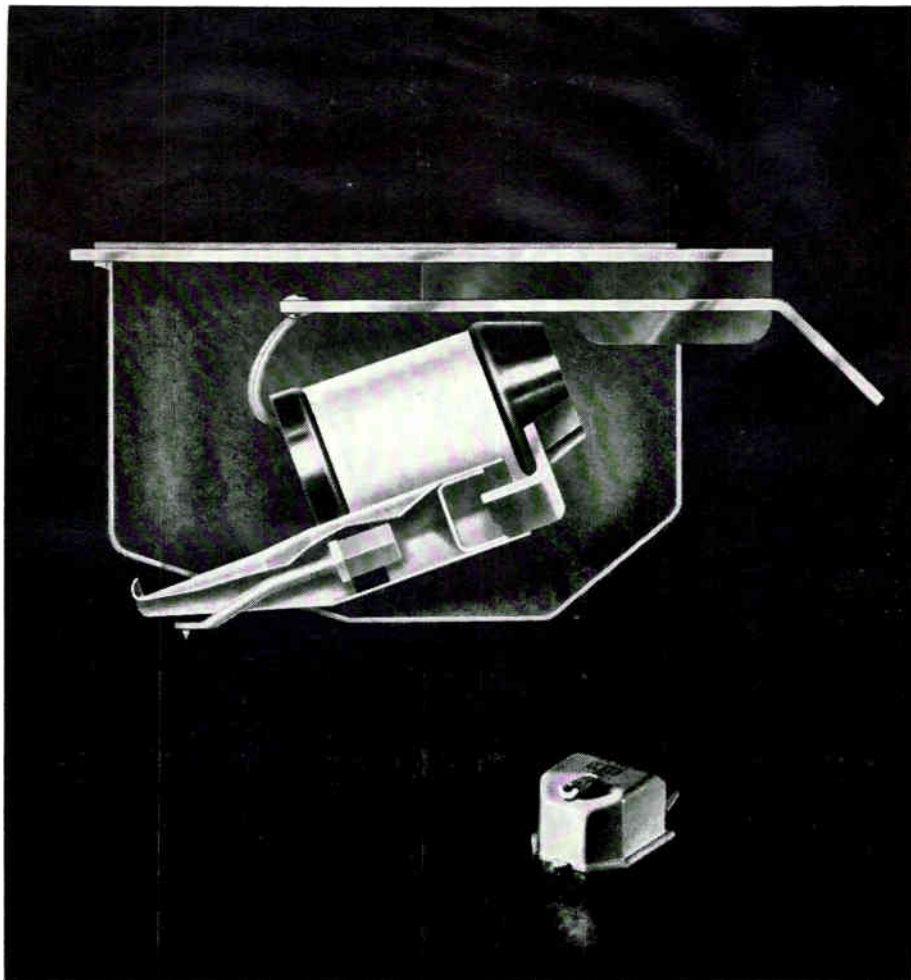

less than 2% i/m distortion but...

this alone is not enough. For optimum stereo performance, a cartridge must have **stereo integrity** as well as fidelity—spatial quality as well as sound quality.

The new Elac 322, with less than 2% intermodulation distortion, and less than 1% harmonic distortion, is capable of producing an almost perfect waveform replica of the sound groove—from 20 to 20,000 cycles, ± 2 db. Moreover, it provides effective crosstalk damping over the most directional frequencies of the spectrum—way out to 20,000 cycles. Channel separation is practically complete: better than 25 db at 1000 cycles, 20 db at 10,000, and an astonishing 12 db at 20,000 cycles.

The 322 tracks at from 1.5 to 3 grams with most arms (1 gram with some). Price with .52 mil diamond stylus and universal mounting bracket is \$49.50.

Also hear the new, compatible mono/stereo Elac 222, \$39.50 with .7 mil diamond.

At your hi-fi dealer now. For complete details, write to: BENJAMIN ELECTRONIC SOUND CORP. 80 Swalm Street, Westbury, N.Y./U.S. distributor for Miracord and other Electroacoustic (Elac)® Record Playing Components.



NEW ELAC 322 STEREO CARTRIDGE

CIRCLE NO. 12 ON READER SERVICE CARD

(Continued from page 12)

and holders, and a booklet of tips on splicing and editing techniques. Catalog No. TK-8DLX. List price: \$15.

circle 183 on reader service card

● **Scott** announces an inexpensive stereo FM tuner kit, the Model LT-111. The kit uses the Scott time-switching stereo circuit, a precision tuning indicator, and separate level controls for channel-balancing. A full-color instruction book is included, and the copper-plated front end is pre-wired and aligned at the factory. Wires are pre-cut and stripped, and Scott's alignment method



enables the builder to align the tuner without special instruments. Sensitivity of the LT-111 is 4 microvolts (IHF); the signal-to-noise ratio is 55 db; harmonic distortion is 0.8 per cent; capture ratio is 6 db; and separation is over 30 db. Dimensions (including accessory case) are 15½ inches wide, 5¼ inches high, 13¼ inches deep. Price: \$109.95.

circle 184 on reader service card

● **Shure's** record-player Gadget Gauges will test six functions of a record changer or manual player. Printed on a perforated card, with full instructions for assembly and use, the gadgets can be

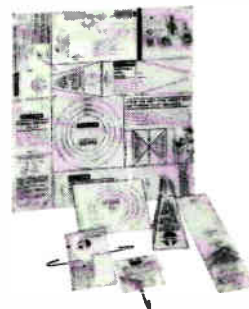

put to work to check tracking force, bearing friction, turntable eccentricity, changer-arm set-down, record-stack clearance, and turntable speed. Available from Shure Brothers, Inc., 222 Hartrey Avenue, Evanston, Ill., 20¢ for postage and handling, or through local high-fidelity dealers.

circle 185 on reader service card

● **Vernon Audio**, a new name in the high-fidelity field, has recently introduced its Model 47/26 stereo tape recorder. The model name is derived from the recorder's complement of forty-seven transistors and twenty-six diodes. Com-

(Continued on page 16)

“One of the most sensitive FM tuners on the market.”

—POPULAR ELECTRONICS

“We found that with only about three inches of wire connected to the antenna terminals we could get every one of the important stations in the New York area.”

—AUDIO

“In addition to fine electrical performance, it has the smooth flywheel tuning and general ‘feel’ of factory-wired Fisher tuners.”

—ELECTRONICS WORLD



And you can build it yourself for \$169.50*—with the Fisher KM-60 StrataKit!

The KM-60 is by far the easiest FM Stereo Multiplex tuner to build—because it is a StrataKit. It is by far the finest performer—because it is a Fisher.

The StrataKit method of kit construction is a unique Fisher development. Assembly takes place by simple, error-proof stages (Strata). Each stage corresponds to a *separate* fold-out page in the instruction manual. Each stage is built from a *separate* transparent packet of parts (StrataPack). Major components come already mounted on the extra-heavy-gauge steel chassis. Wires are *pre-cut* for every stage—all work can be checked stage-by-stage and page-by-page, before proceeding to the next stage.

Front-end and Multiplex stages come fully assembled and pre-aligned. The other

stages are also aligned and require only a ‘touch-up’ adjustment by means of the tuner’s laboratory-type d’Arsonval signal-strength meter.

The ultra-sophisticated wide-band Fisher circuitry of the KM-60 puts it in a spectacular class by itself. Its IHFM Standard sensitivity of 1.8 microvolts makes it the world’s most sensitive FM tuner kit. Capture ratio is 2.5 db; signal-to-noise ratio 70 db. Enough said.

Another outstanding feature of the Multiplex section is the exclusive STEREO BEAM,** the Fisher invention that shows instantly whether or not an FM station is broadcasting in stereo. It is in operation at all times and is completely independent of the tuning meter.

The Fisher KM-60 StrataKit is very close to the finest FM Stereo Multiplex tuner that money can buy and by far the finest that you can build.

FREE! \$1.00 VALUE! Write for The Kit Builder’s Manual, a new, illustrated guide to high fidelity kit construction.

Fisher Radio Corporation
21-37 44th Drive
Long Island City 1, N.Y.

Please send me without charge The Kit Builder’s Manual, complete with detailed specifications on all Fisher StrataKits.

Name _____
Address _____
City _____ Zone _____ State _____ 02813



The Fisher

* FACTORY-WIRED (KM-61), \$219.50. WALNUT OR MAHOGANY CABINET, \$24.95. METAL CABINET, \$15.95. PRICES SLIGHTLY HIGHER IN THE FAR WEST. EXPORT: FISHER RADIO INTERNATIONAL, INC., LONG ISLAND CITY 1, N. Y. CANADA: TRI-TEL ASSOCIATES, LTD., WILLOWDALE, ONT. ** PAT. PENDING

INDOORability

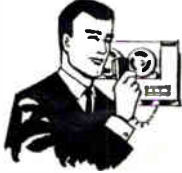

Mirandette's AC power conserves its batteries when you record party fun, tape language studies, dictate letters and reports, or synchronize sound for home movies. Can be used as a public address system.

OUTDOORability



Whether thou goest, Mirandette goes too . . . up mountains, down caves, on sail boat or sale call. All on four standard batteries. Interference free . . . use in car, train, etc.

PORTability

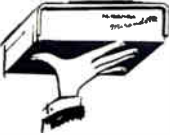

Mirandette plays all the angles. On shoulder or desk, speed remains constant. Measures a mere 9 1/2" x 8 1/2" x 3". All-transistorized circuitry keeps weight under 7 lbs.

ENJOYability



Push button ease, fast forward and rewind, recording level indicator, 3 1/4 and 1 1/2 ips, capstan drive for playing prerecorded tapes, 2 1/4" x 4" speaker, external speaker jack.



At CAMERA, Dept. stores & Audio Dealers. Under \$165.00,* including dynamic microphone with remote controls, 3" extra-play tape, takeup reel, AC cord, carrying strap. 1YEAR GUARANTEE! Other accessories available.

Oh that
Miranda®

MIRANDETTE

ALLIED IMPEX CORPORATION
300 PARK AVENUE SOUTH, NEW YORK 10, N. Y.
CHICAGO 45, ILL. • DALLAS 7, TEX. • LOS ANGELES 16, CALIF.
*See Your Dealer For Exact Price © Reg. By Allied Implex Corp., Excl. U. S. Importer
CIRCLE NO. 4 ON READER SERVICE CARD

JUST LOOKING ...at the best in new hi-fi components



● **Argus** has entered the tape-recorder field with the Model 800 stereo recorder. The machine records four-track stereo and mono and plays two- and four-track stereo and mono at speeds of 7 1/2, 3 3/4, and 1 7/8 ips. The Simul Sound feature permits the operator to listen to previously recorded material and to synchronize the recording of additional material simultaneously.

The recorder weighs 28 pounds and can be operated vertically or horizontally.



A total of 12 watts output (both channels) is available. Signal-to-noise ratio is greater than 48 db. Frequency response is 40 to 15,000 cps at 7 1/2 ips. Two 6 x 4-inch speakers are built into the case. Price: \$269.95.

circle 179 on reader service card

● **Audio Originals'** new Model 101 equipment housing is designed for wall mounting. The equipment enclosure will



accommodate a tuner and integrated amplifier inside and a record player on top. A record shelf is part of the ensemble. Oil-finished walnut is used for both pieces. The equipment enclosure is 37 1/4 x 15 3/4 x 8 inches, and the record shelf is 37 1/4 x 12 1/4 inches. Wall brackets are included. Price: \$69.50.

circle 180 on reader service card

● **Bell Sound's** Model 2445-S2 combines two 22-watt (music-power) amplifiers, an AM tuner, and a stereo FM

tuner on a single chassis. The tuner has a stereo-indicator light, 1.8-microvolt sensitivity, 20-to-20,000-cps frequency response (± 1 db), and less than 1 per cent distortion. The Model 2445-S2 has

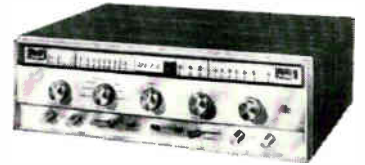

a full complement of stereo-control functions, including high- and low-frequency filters, loudness control, and tape-head inputs. Size is 5 1/2 x 17 1/4 x 13 3/4 inches. Price: \$319.95.

circle 181 on reader service card

● **Fisher's** new stereo power amplifier, the SA-1000, is rated at 150 watts music power (IHF) and 130 watts rms at 0.25 per cent harmonic distortion. Intermodulation distortion at rated power is 0.4 per cent. Frequency response



is 8 cps to 48,000 cps ± 1 db. A hinged panel conceals the controls that are used less frequently; other controls and the bias and balance adjustment meter are always in full view. Price: \$329.50.

circle 182 on reader service card

● **Robins's** de luxe accessory kit for tape-recording buffs includes the Gibson Girl stereo-tape splicer, splicing tape,

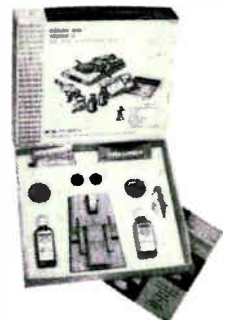

tape threader, tape clips, head cleaner, lubricant, tape-cleaning cloth, reel labels
(Continued on page 14)



The Fisher KM-60 StrataKit, \$169.50*



The Fisher FM-50-B, \$199.50*



The Fisher FM-100-B, \$249.50*



The Fisher FM-200-B, \$299.50*



The Fisher R-200, \$299.50*



The Fisher MF-300, \$359.50*

World's finest tuners at their price.



The Fisher FM-1000, \$429.50*

World's finest tuner.

Fisher currently manufactures six FM-Stereo-Multiplex tuners and one AM-FM-Stereo-Multiplex tuner (the R-200). The lowest-priced model among these is unquestionably one of the finest tuners available anywhere under any name. The highest-priced is just as unquestionably the finest tuner ever made. The remaining five Fisher tuners represent the various degrees of excellence possible between these not very far-apart limits.

Exceptional sensitivity is the outstanding characteristic of all Fisher tuners. Their IHFM Standard sensitivity ratings range from 2.2 microvolts (for the FM-50-B) to an incredible 1.5 microvolts (for the FM-1000). This kind of sensitivity can laugh at weak-signal areas and compensates for the important difference between

mono and stereo FM sensitivity requirements with margin to spare.

The Fisher FM-50-B and KM-60 feature the exclusive STEREO BEAM**, a Fisher invention that automatically indicates whether or not an FM station is broadcasting in stereo. The five more costly Fisher tuners incorporate the unique STEREO BEACON**, an exclusive Fisher development that automatically indicates the presence of FM Stereo programs by means of a signal light and at the same time automatically switches the tuner between the mono and stereo modes of operation, as required.

Which Fisher tuner should you buy? Your Fisher dealer will be pleased to help you coordinate your requirements as to performance and price. But be prepared to find less remark-

able differences between a Fisher and a Fisher than between a Fisher and any other make.

FREE! \$1.00 VALUE! The new 1963 edition of The Fisher Handbook, a 40-page reference guide to custom stereo. Includes full details on all Fisher stereo tuners.



FISHER RADIO CORP.
21-37 44th Drive, Long Island City 1, N. Y.

Please rush free Fisher Handbook.

NAME _____

ADDRESS _____

CITY _____ ZONE _____ STATE _____ 02802

LESS CABINET. ALL PRICES SLIGHTLY HIGHER IN THE FAR WEST. EXPORT: FISHER RADIO INTERNATIONAL, INC., LONG ISLAND CITY 1, N. Y. CANADA: TRI-TEL ASSOCIATES, LTD., WILLOWDALE, ONT. ©PAT. PENDING



It must be Amphora

AMPHORA, the cool, calm tobacco from Holland that soothes the spirit and relaxes the mind. AMPHORA, fragrant and rich, slow-burning to the bottom of the bowl — mild, full-bodied Cavendish at its best. AMPHORA, the *right* tobacco for the young man who takes up a pipe, and for the veteran who seldom sets one down. This pipeful and the next, it *must* be AMPHORA, America's biggest-selling Dutch tobacco...still only 40¢.



A product of

DOUWE EGBERTS ROYAL FACTORIES
Utrecht, Holland

CIRCLE NO. 18 ON READER SERVICE CARD
10

(Continued from page 8)

if you think Sembrich had it rough, consider the career of Mme. de Maupin, a celebrated Paris diva in the rowdy days of Lully.

In the course of achieving her own peculiar brand of vocal royalty, Mme. de Maupin was constrained (1) to learn fencing—not operatically, but for real; (2) to adopt the dress and habits of a *man* of fashion; (3) to sing for her supper in the waterfront cabarets of Marseilles; and (4) to fight several duels, in one of which she killed her titled male opponent. Meanwhile, trilling like a canary, she also managed to (5) set fire to a nunnery, a prank for which she was (6) duly sentenced to be burnt. But she (7) neatly extricated herself from the clutches of the King's justice just in time to (8) wow Paris in Lully's opera *Cadmus et Hermione* (April 27, 1673), in which, moreover, she sang the role, not of Hermione, but of Cadmus, an assignment she clinched by (9) successfully impersonating her own husband on the Opéra roster. If you ask me, la (or perhaps le) Maupin rates a movie; the casting possibilities are fascinating, not to mention the sex appeal of take-your-pick-who in seventeenth-century tights.

ROBERT CLIFFORD HARRISON
New York, N.Y.

Hentoff's Bitter Draught

● After reading Nat Hentoff's review of Pete Seeger's "The Bitter and the Sweet" (March), I want to ask who ever told Mr. Hentoff that he could hear what Seeger is about or what his singing is made of? A more "colorful" voice is the last thing that would benefit Seeger's delivery, a compelling nonpareil communication with his audiences that is totally independent of artfulness. Seeger's rendition of Negro material may not "convince" Mr. Hentoff, but perhaps the latter is trying too hard to hear either the original or some imitation he can evaluate by jazz standards, when in fact Seeger's presentation is his own and not intended to be a pallid copy. If Seeger is weak in some areas, what folk artist is not? Moreover, who else is as versatile on the birch whistle, steel drums, axe, twelve-string, etc., as well as the standard folk instruments? I am no restless youth, but for me Seeger's record hits the mark while Mr. Hentoff's review is far wide.

PETER LIEBERMAN
Brooklyn, N.Y.

Haydn and the Esterhazys

● You will undoubtedly hear from a covey of staunch Haydn-lovers about Igor Kipnis's cropper in his review of the Vox recording of the "Lark" Quartet and the F Major Quartet, Opus 77, No. 2 (March). The latter was not Haydn's last work; the unfinished Opus 103 was.

In between came a great many other works, the best known of which are the last two Masses and the marvelous oratorio, *The Seasons*. Opus 77 marked the end of the glorious group of quartets, but not of Haydn's creativity.

Furthermore, Haydn was actually on the payroll of the Esterházy family from 1761 until he died in 1809. His connection did not end with Nicholas the Magnificent's death in 1790, but continued uninterrupted through Prince Anton's short reign and that of his successor, Nicholas II. Haydn's duties were greatly reduced during the last nineteen years, but he was still *Kapellmeister*.

ROBERT A. CREED
New York, N.Y.

On both points Mr. Creed's information is basically correct, but we acknowledge that Mr. Kipnis erred only on the first, concerning which he should have said that, with the exception of the unfinished Quartet, Opus 103, the F Major was Haydn's last work in this form. In the review Mr. Kipnis wrote that the "Lark" was composed in Haydn's "final year of service to the Esterházy's." At Nicholas's death, Prince Anton in effect abolished Haydn's function by dismissing the whole musical establishment of his predecessor, retaining only enough members to hold church services. Haydn continued to draw pay, but had little or

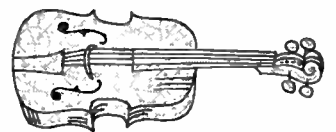

nothing to do, and he lived in Vienna for the greater part of his remaining years. The connection was real enough for Haydn to spend several summers and autumns at Esterházy, and to participate in especially festive occasions. But with his two triumphant visits to London at the behest of the astute Salomon, his Vienna lessons and concerts, and his work on various commissions, including the countless Scottish, Welsh, and Irish national airs for George Thomson of Edinburgh, and The Creation and The Seasons for friends of Baron van Swieten, his service to the Esterházy's was a formality, and minimal among the activities of those last years.

Basic Rep: Fifty More!

● Please have Martin Bookspan continue his "Basic Repertoire" series through another fifty, at least. For me, this is the most interesting feature of your magazine—I buy with great confidence the records he recommends.

W. P. HICKERSON
Manchester, Tenn.

See page 23 for the fifty-first.

Wharfedale

Superb...because Wharfedale Achromatic Speaker Systems are crafted to reproduce music—as music really is. No spurious resonances, no artificial colorations mar the fidelity of reproduction. Listen to your favorite musical work on a Wharfedale—hear, perhaps for the first time, the clear transparent highs, the rich mid-tones, the fullness of a superb low-range.

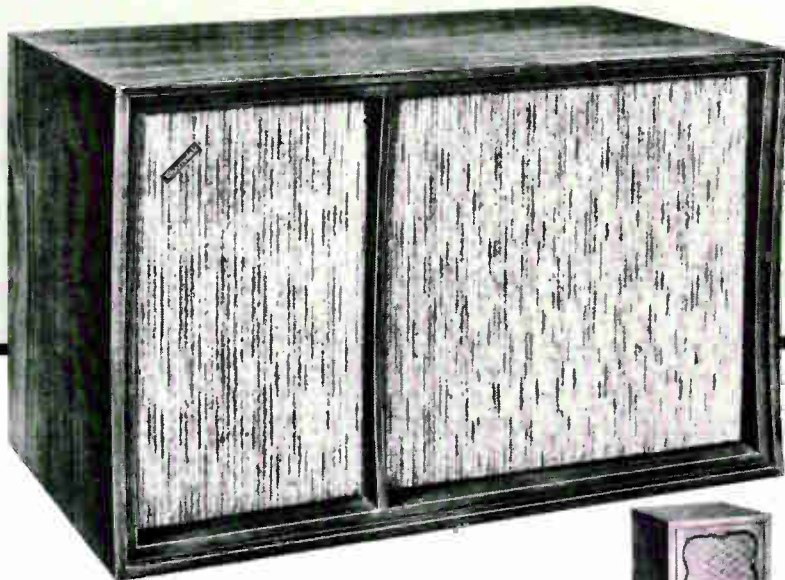

W60 In the streamlined look of fine modern furniture or handsomely crafted provincial, this full-range two speaker system continues to provide superlative performance—making it the automatic choice when the finest reproduction is desired. True Wood \$116.50. Unfinished, in sanded birch hardwood, without curved molding or dividers \$101.50.



W60 PR Provincial in genuine Fruitwood \$134.50

Sand Filled Baffle

Chief characteristic of the Achromatic construction is the sand-filled technique, which consists of packing white sand densely between layers of hardwood. The resulting inert mass is incapable of resonating, no matter how deep or strong the bass backwave projected against it. This exclusive Wharfedale technique yields a full range of sound, a perfectly pure "Achromatic" musical image, without acoustical coloration.

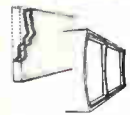

W90

A magnificent new 6 speaker dual 3-way system, destined to restore the legendary sound of the great Wharfedale systems used by G. A. Briggs in his famed Carnegie Hall Concert demonstrations. The meticulously crafted cabinet is proportioned specifically to accommodate the speakers and construction required to accomplish this ambitious purpose; yet the size (32 1/4" x 27 3/4" x 13 1/8") is sufficiently compact to fit into the modern living room. Oiled or Polished Walnut \$259.50. Utility model in sanded birch hardwood without curved molding or dividers \$244.50.

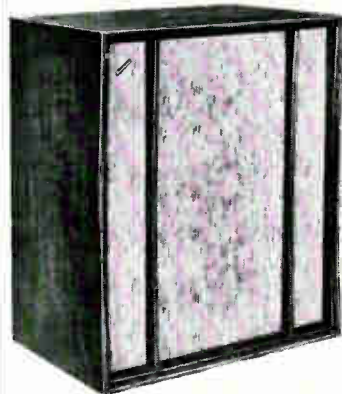

W70

A three-speaker system—handsome by itself, yet still sufficiently compact for shelf or wall integration. The beauty and excellence of performance of this remarkable system makes it unusually attractive to experts and laymen alike. True Wood \$164.50. Unfinished in sanded birch hardwood, without curved molding or dividers \$146.50.



W70 PR

Provincial in genuine Fruitwood \$189.50

W40

Ultra-compact (24" x 12" x 10") full-range system at a most attractive price. Two superior speakers: A newly developed 8 1/2 inch low frequency driver with an extremely high flux density magnet—and Wharfedale's outstanding 5 inch tweeter—the same used in the larger W60 system. True Wood \$79.50. Unfinished in sanded birch hardwood, without curved molding \$69.50.

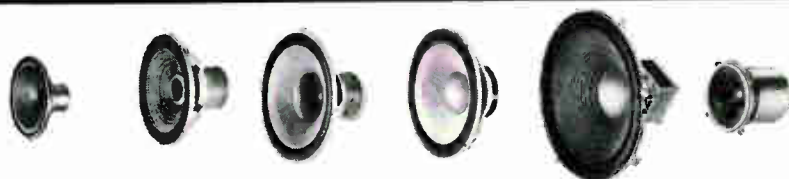

Full Range 8" Super 8 FS/AL \$26.50

Full Range 10" Super 10 RS/DD \$47.50

Full Range 12" Super 12 RS/DD \$69.50

Woofer W 12/RS \$52.50

Woofer W 15/RS \$89.50

Tweeter Super 3 \$26.50



B67

Universal Mounting base for W60, W70 and W90 systems in matching woods. Easily installed to enhance the beauty of the enclosures. True Woods \$9.95. Utility model in sanded birch hardwood \$8.95.



For illustrated literature write: Dept. WF-123 Wharfedale, a Division of British Industries Corp., Port Washington, N.Y.

POPULARITY BRINGS THE PRICE DOWN...

- 30 watts stereo output, 15 watts per channel ■
- sensitive smooth-tuning FM-AM section ■ Stereo
- Sentry Multiplex—tuning bar signals the stereo
- broadcasts ■ full-fidelity stereo preamplifiers for
- magnetic or crystal phono, tape deck and auxiliary
- accessories ■ decorator-inspired brushed-gold
- panel compactness—13¼" w x 4½½" h x 13¼" d.

Write **GROMMES**
 Division of Precision Electronics, Inc.,
 9101 King St., Franklin Park, Ill.

Loved by
 Audiophiles at

~~\$289.95~~

NOW
\$199.95

Less Cabinet

Grommes
 sets the
 scene...



LETTERS TO THE EDITOR

Snap, Crackle, Pop

● I have been buying records in large quantities for eight to ten years. All my purchases are well-known labels, bought at standard discounted prices. I had seldom encountered a defective or low-quality record before the stereo era. But recently I have been subjected to a series of discs with intolerable hiss, breakup on high notes, warped surfaces that produce more rumble than a thunderstorm, and miscellaneous noises that would put Rice Krispies to shame.

Perhaps this can be attributed to the increased sensitivity of my new stereo equipment. Yet I have run across a reasonable number of new records with fine sound and quiet surfaces. What is even more disconcerting is that some of my oldest records, having survived six or seven years of my 1949-model changer, are quieter on the new equipment than many records I play for the first time.

Though I sometimes pay less than half of the list price for new stereo records, I am beginning to wonder whether the saving is worth the emotional anguish of the first listening. Or have I just been having a run of bad luck?

JOEL WEST
 Baldwin, N. Y.

To the best of our knowledge, records sold in discount stores are of the same quality as records sold elsewhere.

Tape Clubbable

● I have recently taken up tape recording as a hobby, and I'm interested in joining a tape club. How can I make contact with one?

MIKE SZEMETY
 Charleston, S. C.

The magazine Tape Recording, 101 Baltimore-Annapolis Blvd., Severna Park, Maryland, regularly publishes a list of tape clubs of varying kinds: clubs for tape exchanging, for international or American tape "pen-pals," and for specialists such as organ-music lovers.

A Reader's Basic Rep

● *In re* Martin Bookspan's discussion (January) of the Mozart Clarinet Quintet, the deleted London recording by Antoine de Bavier and the New Italian String Quartet, which he called "superb," can be had from England on English Decca ACL-47.

I have listened to all of Mr. Bookspan's recommendations for a performance of Beethoven's Fourth Piano Con-

certo, and turned back to the old mono version by Clifford Curzon and Hans Knappertsbusch as definitive. It is no longer available here, either, but it is on English Decca LXT-2948.

G. E. BURKS
 Denver, Colo.

Golden Voices

● I was quite fascinated by Ray Ellsworth's article on rare recordings in April. At one point he mentions the possible treasures "skulking about disguised as bargain-basement specials." This reminded me of the time I went into a department store in Garden City, New York, that was having a clearance sale on LP's—79¢ apiece. Among my finds was the original-cast album of *Hazel Flagg*, which Mr. Ellsworth listed as having a current retail value between fifteen and twenty dollars.

JOHN MARZULLI
 Glen Cove, N.Y.

● I have read with great interest the article "Golden Voices in Your Attic." I fancy myself a record collector of varied tastes and am the proud possessor of many 78's, ranging from Caruso and McCormack to the Original Dixieland Jazz Band, Vernon Dalhart, and Jimmy Rodgers.

I am anxious to obtain recordings, particularly any LP transfers, of two American artists, John Charles Thomas and James Melton. I know that RCA Victor released and then withdrew a couple of Camden albums of the former's singing, but I have seen no reissues of the latter—or any other available LP's. Can you help me?

TOMMY WHEELER
 Matador, Texas

The Camden reissues may be available through rare-record specialists, such as those mentioned by Mr. Ellsworth: American Record Collectors' Exchange, 825 Seventh Avenue; Merit Music Shop, 48 West 46th Street; and The Cut-Rate Record Outlet, 1131 Sixth Avenue, all in New York City.

Cliffhanger

● In your April issue, Robert Offergeld remarks in relation to Columbia's release of "The 1903 Grand Opera Series," "It has never been particularly easy to be an honest-to-God Queen of Song." His quote from W. J. Henderson in support of this statement is amusing enough, but

(Continued on page 10)

One-year subscriptions to **HIFI/STEREO REVIEW** may be purchased in Australian pounds (2/15/12); Belgian francs (310); Danish kroner (43); English pounds (2/4/6); French francs (31); Dutch guilders (22); Indian rupees (31); Italian lire (3,000); Japanese yen (2,100); Norwegian kroner (45); Philippine pesos (25); South African rands (4.50); Swedish kronor (33); Swiss francs (27); or West German marks (25). Ziff-Davis Publishing Company also publishes *Popular Photography*, *Popular Electronics*, *Electronica*, *World*, *Popular Boating*, *Car and Driver*, *Flying*, *Modern Bride*, *Amazing*, and *Fantastic*.

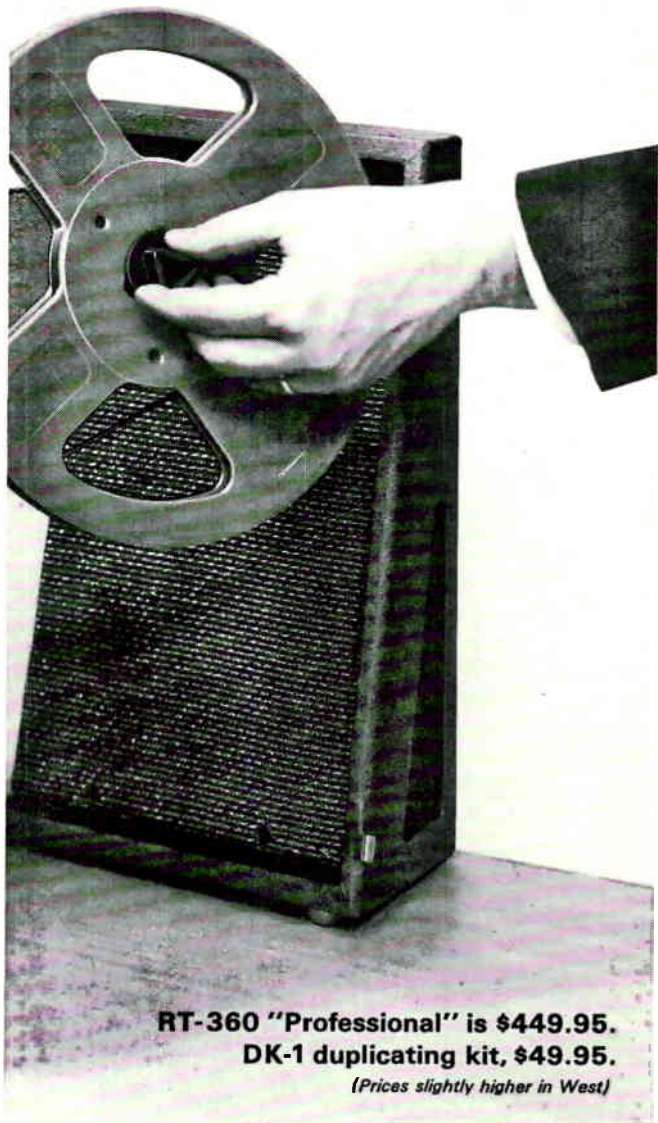

**RT-360 "Professional" is \$449.95.
DK-1 duplicating kit, \$49.95.**
(Prices slightly higher in West)

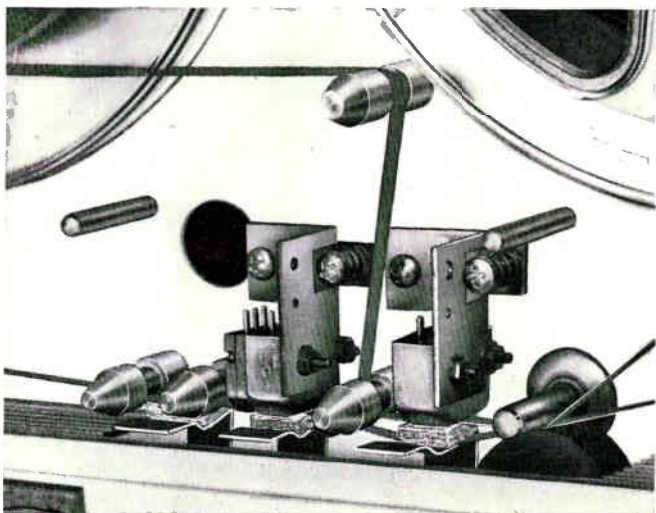

Unique threading and head arrangement for tape duplicating (shown with head leads removed). Prerecorded tape threads over auxiliary tape guide, over playback head, past drive capstan. Blank tape threads through head slot, across record head, and is shielded from playback head. Head cover is slipped off to permit double threading.

**Now—the ultimate
in tape recorders...**

NEW BELL RT-360 "PROFESSIONAL"

*Only recorder in the world
that can play a tape and
copy it simultaneously*

Here's the advanced, complete instrument you've always wanted! So flexible, so versatile that whatever you want your recorder to do, the BELL RT-360 "Professional" can do it...and more.

- Use it as a *complete home stereo system*. A tuner and/or record changer can be added for even greater flexibility.
- Use it as a *tape-duplicating unit*. Duplicate stereo tapes into mono or stereo with no loss of quality.
- Use it as a *public-address system*. Ideal as a speaker's aid...records the speech simultaneously!
- Use it as a *musical-instrument amplifier*. Permits simultaneous recording of the performance.



BELL STEREO

Thompson Ramo Wooldridge Inc.

6325 HUNTLEY ROAD • COLUMBUS 24, OHIO

MAIL THIS COUPON TODAY for complete information about the new BELL RT-360 "Professional"

BELL STEREO

Thompson Ramo Wooldridge Inc.

6325 Huntley Road, Columbus 24, Ohio

Name _____

Address _____

City _____ Zone _____ State _____

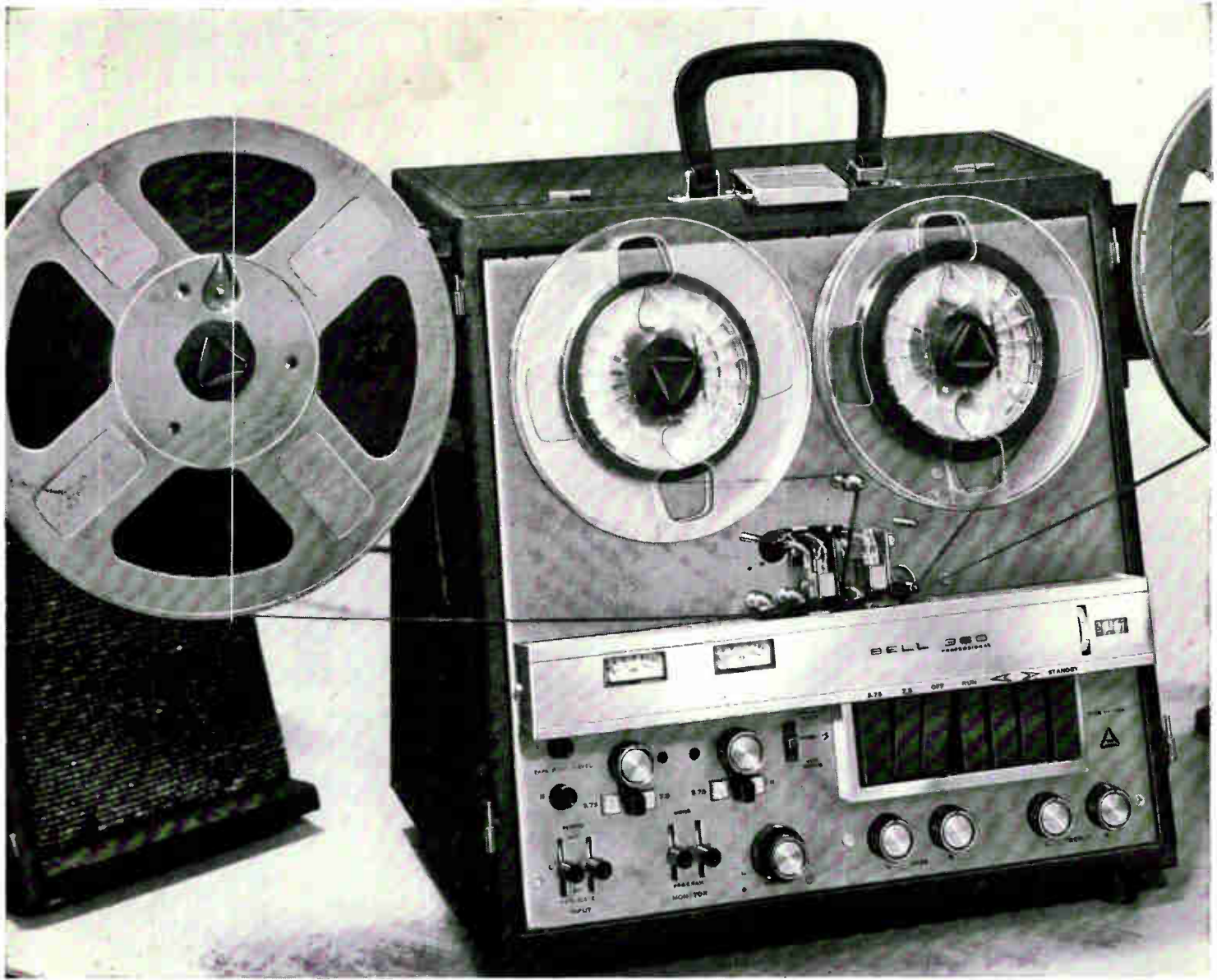

Three-motor drive—electrodynamic positive braking. No belts, pulleys, clutches. Negligible wow and flutter.

Twin lighted meters for constant monitoring.

Three-position "special-effects" switch.

Record equalization—positive record interlocks.

Dual 3-position input mode switches.

Removable head cover for tape duplicating.

Tape lifters—automatic stop switch. Easy straight-line threading.

Index counter for relocating selections.

Dual concentric volume controls.

Individual tone controls for each channel.

THE BELL RT-360 "PROFESSIONAL" GIVES YOU MORE FINE FEATURES FOR ENJOYMENT

16-watt stereo amplifier for room-size listening ■ Twin 6" x 9" speakers in removable baffles ■ Accessory motorized adapters permit use of any size reel up to 10½" ■ Built-in variable echo ■ Off-the-tape monitoring ■ Records sound on sound—mono or stereo ■ Fully portable in attractive carrying case.

audiotape
"it speaks for itself" TRADE MARK



Play Fiddle, Play (Audiotape is listening)

Audiotape can be your best friend. Talk to it by the hour and it will never protest. Speak gently and Audiotape returns the compliment. Play your violin and Audiotape will respond graciously, and never comment on your talent. Let a thousand violins fill the air and Audiotape remembers every note . . . and reminds you whenever you ask. It never volunteers an opinion, speaks only when spoken to. And when heard, its voice is unmistakable . . . clear, far ranging, free from distortion. They say friendship can't be bought. This one can. Buy a reel, and a friend, soon.

AUDIO DEVICES, INC., 444 Madison Avenue, New York 22, N. Y. • Offices in Los Angeles • Chicago • Washington, D. C.

CIRCLE NO. 8 ON READER SERVICE CARD

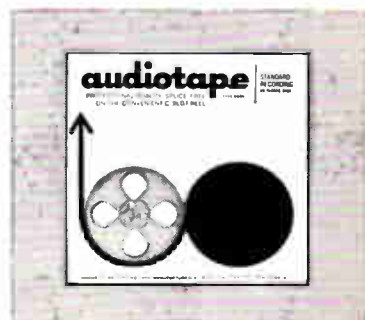

HiFi/Stereo review

PUBLISHER

PHILLIP T. HEFFERNAN

EDITOR

FURMAN HEBB

MANAGING EDITOR

WILLIAM ANDERSON

MUSIC EDITOR

ROBERT OFFERGELD

TECHNICAL EDITOR

LARRY KLEIN

ART EDITOR

BORYS PATCHOWSKY

ASSOCIATE EDITOR

ROBERT S. CLARK

PRODUCTION EDITOR

MEL SCHINASI

ASSISTANT EDITOR

MARCIE LAITMAN

CONTRIBUTING EDITORS

CHRISTIE BARTER

MARTIN BOOKSPAN

HANS H. FANTEL

WILLIAM FLANAGAN

STANLEY GREEN

JOE GOLDBERG

DAVID HALL

NAT HENTOFF

JULIAN D. HIRSCH

GEORGE JELLINEK

IGOR KIPNIS

PAUL KRESH

**ADVERTISING
SALES MANAGER**

LAWRENCE SPORN

**ADVERTISING
SERVICE MANAGER**

ARDYS C. MORAN

ZIFF-DAVIS PUBLISHING COMPANY

Editorial and Executive Offices (ORegon 9-7200)
One Park Avenue, New York 16, New York
William B. Ziff, Chairman of the Board (1946-1953)
William Ziff, President
W. Bradford Briggs, Executive Vice President
Hershel B. Sarbin, Vice President and General Manager
M. T. Birmingham, Jr., Vice President and Treasurer
Robert P. Breeding, Circulation Director
Charles Housman, Financial Vice President
Stanley R. Greenfield, Vice President
Phillip T. Heffernan, Vice President
Midwestern and Circulation Office (WAbash 2-4911)
434 South Wabash Avenue, Chicago 5, Illinois
Advertising: Jerry Sweeney
Western Office (CRestview 4-0265)
9025 Wilshire Boulevard, Beverly Hills, California
Western Advertising Manager: Bud Dean

Foreign Advertising Representative
D. A. Goodall Ltd., London, England
SUBSCRIPTION SERVICE: All subscription correspondence should be addressed to HiFi/Stereo Review, Circulation Department, 434 South Wabash Avenue, Chicago 5, Illinois. Please allow at least six weeks for change of address. Include your old address, as well as new—enclosing if possible an address label from a recent issue.
EDITORIAL CONTRIBUTIONS must be accompanied by return postage and will be handled with reasonable care; however, publisher assumes no responsibility for return or safety of art work, photographs, or manuscripts.

Member Audit Bureau of Circulations



EDITORIALLY SPEAKING

by FURMAN HEBB

I RECENTLY came across a study concerning the life-expectancy of records. The results of the investigation, which was performed under the direction of the Library of Congress, were published in 1959 under the title *Preservation and Storage of Sound Recordings*. Because the publication has received limited circulation, and because it contains much useful information about the proper storage of records, I think it may be worthwhile to summarize some of its findings.

Studied were acetate, shellac, and vinyl discs, plus acetate- and Mylar-base magnetic tape. In general, the deterioration of these products was found to be of two types. One was a chemical breakdown of the various plastics used, and the other was physical damage caused by improper storage techniques. Controlled conditions of temperature and humidity, it was found, extend the keeping qualities of the plastics used in all types of recordings. The ideal storage temperature was calculated to be between about 45 and 50 degrees, while temperatures between 60 and 70 degrees were suggested as being a good compromise between ideal and comfortable temperatures. The optimum relative humidity was determined to be between 45 and 65 per cent.

According to the study, the potential life of an acetate disc is somewhat less than fifty years. The life of a long-playing disc, on the other hand, is estimated to be well in excess of a century, and most shellac (78-rpm) discs seem to have comparably long lives, although a few, because of unstable formulations, deteriorate in less than a decade. Magnetic tapes apparently have excellent keeping qualities, provided they are properly recorded, wound, and stored. The study recommends that all recorded material in libraries be checked regularly to ascertain whether rerecording is advisable.

More important than chemical deterioration, according to the researchers, is the problem of physical deformation, which is particularly severe with long-playing discs. The studies indicated that practically all physical damage is caused by storing records horizontally rather than vertically, and that long-playing discs can be safely stored for many decades if they are stood up vertically.

The report, which contains other interesting information, is available for 45 cents from the Superintendent of Documents, U.S. Government Printing Office, Washington 25, D.C.

Coming Next Month in HiFi/STEREO REVIEW

WHAT HAS GONE WRONG WITH OUR CONCERT HALLS?

by Fritz A. Kuttner

STEREO CARTRIDGE REPORT: PART TWO
by Julian D. Hirsch and Gladden B. Houck

BILL EVANS AND THE NEW JAZZ PIANO
by Gene Lees

HiFi / Stereo review

THE MUSIC

- 23** THE BASIC REPERTOIRE
Dvořák's Symphony in G Major.....MARTIN BOOKSPAN
- 31** GLENN GOULD: AS AMONG BACH,
BOTTICELLI, AND BRUEGEL
An essay in visualizing musical temperaments....ROBERT OFFERGELD
- 37** ESSENTIALS OF A CHAMBER MUSIC LIBRARY
Best recordings selected by a prominent critic.....B. H. HAGGIN
- 46** HOW TO START A RECORD COMPANY
Trials and triumphs outlined for beginners.....JAMES GOODFRIEND
- 53** BEST OF THE MONTH
Reviews of outstanding new releases

THE EQUIPMENT

- 20** BEGINNERS ONLY
Tone-Arm Design—Part One.....HANS H. FANTEL
- 27** TECHNICAL TALK
*Lab reports on the Bozak B-4000 speaker system
and the Scott Model 340 stereo tuner-amplifier*....JULIAN D. HIRSCH
- 41** LABORATORY REPORTS ON STEREO
CARTRIDGES, PART ONE
*Tests of the Sonotone Velocitone Mark III, Shure M77,
Dynaco Stereodyne II, ADC-3, Weathers LDM, and
Knight KN-505X*.....JULIAN D. HIRSCH AND GLADDEN B. HOUCK
- 51** INSTALLATION OF THE MONTH
End-table stereo
- 52** SOUND AND THE QUERY
Answers to your hi-fi technical questions.....LARRY KLEIN

THE REVIEWS

- 59** HIFI/STEREO CLASSICS
- 75** HIFI/STEREO JAZZ
- 83** HIFI/STEREO REEL AND CARTRIDGE
- 89** HIFI/STEREO ENTERTAINMENT

THE REGULARS

- 4** EDITORIALY SPEAKING
- 8** LETTERS
- 12** JUST LOOKING
- 98** ADVERTISERS' INDEX; PRODUCT INDEX

COVER DESIGN: RICHARD SMITH ASSOCIATES

Copyright © 1963 by Ziff-Davis Publishing Company. All rights reserved. HIFI/STEREO REVIEW June 1963, Volume 10, Number 6. Published monthly by Ziff-Davis Publishing Company at 434 South Wabash Ave., Chicago 5, Illinois. Subscription rates: one year United States and possessions: \$5.00; Canada and Pan-American Union countries \$5.50; other foreign countries \$6.00. Second-class postage paid at Chicago, Illinois and at additional mailing offices. Authorized as second class mail by the Post Office Department, Ottawa, Canada, and for payment of postage in cash.

Take another look at the AUTOSLIM/P Mark II



Autoslim/P is the most compact of multi-speed record changers. Only 6½" in height overall, it will fit where other automatic units may not. Sparkling in grey, charcoal and brushed aluminum, the Autoslim/P will grace any music system. It is the ideal replacement changer.



The graceful tone arm is cast aluminum, for non-resonance and rigidity. A bayonet fitting holds the plug-in shell, which accommodates the widest personal choice of cartridges. An extra-sensitive stylus pressure control insures correct tracking force, according to the cartridge manufacturers' specifications.



The unified control panel has separated positions for playing records automatically or individually. Operation is exceptionally quiet. The Garrard 4-pole shaded "Induction Surge" motor, with dynamically balanced rotor, is shielded from hum. Constant speed is assured, free from vibration.



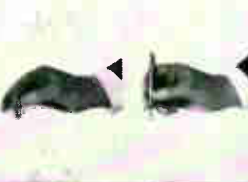

In automatic position, the Autoslim/P intermixes records of any size or sequence. Two spindles are provided. A convenient short single play spindle is interchangeable with the center drop automatic spindle which pulls out for safety in handling records.



Installation is simple. Autoslim/P is fully wired for stereo, with a 4-pin/5-wire system utilizing separate connection for ground, to eliminate hum. Leads connect to the changer with a built-in Amplok plug (for AC) and a female twin phono socket mounted on the unit plate (for audio). Simply plug-in at the player!

Price
\$39.50
less
cartridge

The new Autoslim is a pure-bred Garrard. Built in the same tradition as Garrard's automatic turntables, the immensely successful Type A  and AT6  it reflects the same dedicated engineering and quality control techniques. Whether you prefer the Autoslim, AT6 or Type A, your pride of ownership resides in the name ...

Garrard
world's finest

There is a Garrard for every high fidelity system. Type A \$79.50, AT6 \$54.50, Autoslim \$39.50. For Comparator Guide, write Dept. GF-123, Garrard Sales Corporation, Port Washington, N. Y.

Canadian inquiries to Chas. W. Pointon Ltd., 66 Racine Road, Rexdale, Ontario.

Territories other than U. S. A. and Canada to Garrard Engineering and Mfg. Co., Ltd., Swindon, Wilts., England

New 70 Watt FM Stereo Tuner/Amplifier

Newest Model of the Tuner-Amp Hirsch-Houck labs called "one of the finest... we've ever tested."

The radically new 340B FM Stereo Tuner-Amplifier combines all the features of the finest Scott SEPARATE components into a single compact unit. Amazing Auto-Sensor circuitry provides for the ultimate in operating convenience. The handsome new styling, and advanced electronic features of the new 340B will set industry standards for years to come. If you require highly sensitive FM performance and enough power reserve for practically any loud-

speaker installation, the new Scott 340B is your logical choice.

Model 340B Technical Specifications

IHF M Sensitivity 2.2 microvolts; IHFM Power Rating 70 watts; IHFM Power Band 20 to 20,000 cps; Hum Level -80db; Distortion 0.8% Detector Bandwidth 2 mc; Controls: Bass and Treble on each channel, Volume, Loudness-Volume Compensation, Tape Monitor, Balance, Stereo Selector, Main Tuning, Scratch Filter, Rumble Filter, Speaker-Earphone selector, Power Mode Selector. Size in handsome accessory case: 17½W x 6¼H x 16¾D. Price: \$399.95.*

Look at these important features:

1. Easy-to-use, easy-to-read precision slide-rule tuning mechanism, with convenient logging scale.
2. Unique indicator lights prevent inadvertent use of Tape Monitor control.
3. Auto-Sensor circuitry instantly and automatically chooses correct mode of operation.
4. Precision illuminated d'Arsonval meter for pinpoint tuning of all signals.
5. Convenient front-panel earphone receptacle for private listening.
6. Powered third channel for direct connection of remote speakers or for a three-channel system.
7. Complete tape monitoring facilities. All controls operate on playback.
8. Silver-plated RF circuitry, the same used in the tuner selected by Bell Laboratories for one of their pioneering Telstar experiments.
9. Massive power and output transformers that assure the superb performance ordinarily found only with separate components.

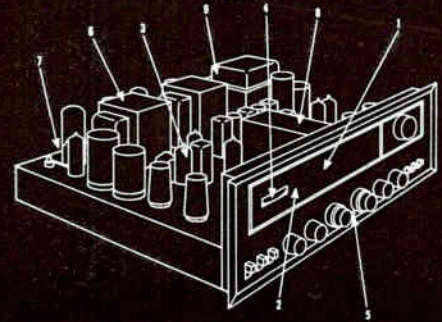

components with amazing Auto-Sensor

310E FM Stereo Tuner Outstanding Features:

1. Sensitive illuminated tuning meter for optimum orientation and station selection.
2. Convenient front-panel recorder output jack.
3. Laboratory-type precision vernier tuning control.
4. Auto-Sensor circuitry for fully automatic operation.
5. Mode Control with these positions (FM Monophonic, FM Stereo, FM Stereo Automatic).
6. Interstation noise suppressor.
7. Silver plated RF Cascade front end.
8. Scott's unique "Time Switching" multiplex circuitry.
9. 2 megacycle wide-band detector.
10. Three limiting stages, assuring fully quieted performance on even the weakest signals.
11. Power/Filter (with these positions: Off, On, Sub-channel Filter, Stereo Filter).
12. Stereo Threshold.

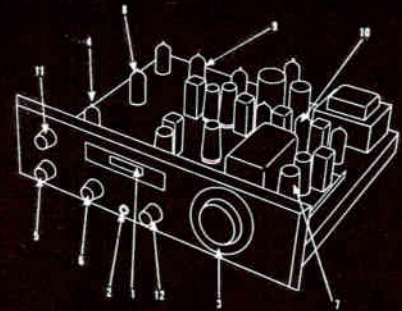

New Super-Sensitive FM Stereo Tuner

Multiplex Version of the Famous 310 Tuner Selected for "Telstar" Experiment

Now the world famous 310 tuner is fully equipped for Stereo Reception. The 310 is considered the most outstanding FM tuner available. It is used for commercial applications and critical broadcast relay work throughout the world. Its extreme sensitivity, selectivity and low distortion make it the logical choice for the most critical installations. The new 310E is equipped with the famous Time-Switching multiplex circuitry, pioneered by Scott, and universally accepted as the best way for achieving optimum stereo separation. It is recommended for the audio enthusiast who requires the very finest tuner.

310E Technical Specifications

IHF M Sensitivity 1.9 microvolts; Drift .02%; Capture Ratio 2db; Selectivity (adjacent channel) 50 db; FM Detector Bandwidth 2 mc; FM Limiting Stages, 3; FM IF Stages, 4; Frequency Response (± 1 db) 30 to 15,000 cps (IHF M limits); Harmonic Distortion less than 0.5%; Spurious Response Rejection 85db; Separation 35 db. Controls: Main Tuning, Interstation Noise Suppressor, Level, Sub-Channel Filter. Size in accessory case: 15½W x 5¼H x 13¼D. Price: \$279.95.*



H. H. SCOTT INC., 111 Powdermill Rd., Maynard, Mass.
Export: Morhan Exporting Corp., 458 Broadway, N.Y.C.
Canada: Atlas Radio Corp., 50 Wingold Ave., Toronto

* Slightly higher west of the Rockies. Subject to change without notice. Accessory cases extra.

CIRCLE NO. 41 ON READER SERVICE CARD