

**THIRD  
EDITION**

# **LOUDSPEAKERS**

**THE WHY  
& HOW OF  
GOOD  
REPRODUCTION**

*by*  
**G. A. BRIGGS**



**“SOUND” INFORMATION FOR THE  
LAYMAN AND THE ENTHUSIAST**

# LOUDSPEAKERS

## The Why & How of Good Reproduction

*by*

G. A. BRIGGS

*Author of*

“ SOUND REPRODUCTION ”

“ PIANOS, PIANISTS AND SONICS ”

*and*

with H. H. GARNER

“ AMPLIFIERS ”

The Why and How of Good Amplification

*Published by*

WHARFEDALE WIRELESS WORKS

BRADFORD ROAD - IDLE - BRADFORD - YORKSHIRE

### AGENTS

U.S.A. — British Industries Corporation, 164, Duane Street, New York, 13, N.Y.

CANADA — Charles W. Pointon, 1926, Gerrard Street East, Toronto, Ontario.

AUSTRALIA — McGill's Authorised Newsagency, 183-185 Elizabeth Street,  
Melbourne C.I, Victoria.

NEW ZEALAND — H. Barnes & Company, 1, Mount Street, The Terrace,  
Wellington.

SOUTH AFRICA — S.A. Radio Publications, P.O. Box No. 2232,  
Johannesburg, Transvaal.

HONG KONG — Universal Trading Company, Ltd., G.P.O. Box No. 1231.

*First Edition*  
May 1948.

*Second Edition*  
December 1948.

*Third Edition*  
March 1949.

*Reprinted September, 1949.*

..	November,	..
..	February,	1950.
..	June	..
..	May	1951.
..	February	1952.
..	October	..
..	May	1953.

Copyright  
Registered at  
Stationers' Hall

## CONTENTS

<i>Chapter</i>	<i>Page</i>
Introduction .. .. .	5
Foreword to Third Edition .. .. .	7
i Quality of Reproduction and Distortion .. .. .	9
ii Development of Loudspeakers .. .. .	11
iii Magnets .. .. .	14
iv Chassis or Cone Housing .. .. .	16
v Cones .. .. .	17
vi Centring Devices .. .. .	20
vii Impedance .. .. .	21
viii Phons and Decibels .. .. .	24
ix Frequency Response .. .. .	29
x Response Curves .. .. .	34
xi Volume and Watts .. .. .	36
xii Resonance and Vibration .. .. .	39
xiii Cabinets and Baffles .. .. .	42
xiv Extension Speakers and Volume Controls .. .. .	52
xv Cinema Speakers .. .. .	55
xvi Room Acoustics .. .. .	57
xvii Transients .. .. .	61
xviii Crossover Networks .. .. .	64
xix Negative Feedback .. .. .	66
xx Transformers and Matching .. .. .	67
xxi Comparing Performance .. .. .	70
xxii Loudspeaker Life .. .. .	72
xxiii Doppler Effect .. .. .	74
xxiv Phase Effects .. .. .	75
xxv Loudspeaker Efficiency .. .. .	79
Conclusion .. .. .	80
Commercial Supplement .. .. .	81

## ILLUSTRATIONS

Fig.		Page
1	Loudspeaker Driving Systems .. .. .	11
2	Magnets 1932-1944 .. .. .	14
3	Cone Assembly and Curved Cone .. .. .	17
4	Response Curve, LF dip and HF peak .. .. .	18
5	Low frequency efficiency and Cone size .. .. .	19
6	Impedance curves, various driving systems .. .. .	21
7	Impedance curves, baffle and reflex .. .. .	22
8	Impedance curve, cloth suspension .. .. .	23
9	Loudness and intensity curves .. .. .	26
9a	Phons and D.B. curves .. .. .	28
10	Frequency range of music and speech .. .. .	29
11	Harmonic analysis of Violin tone .. .. .	31
12	Piano chart, Wavelengths, Baffle areas .. .. .	33
13	Response curve of 3½" unit .. .. .	34
14	Response curve of 10" unit .. .. .	34
15	Response curve of 10" curved cone .. .. .	35
16	Speech coils .. .. .	38
17	Vibrations of string .. .. .	40
18	Distortion in cabinet .. .. .	42
19	Resonance curves .. .. .	43
20	Reflex Cabinets .. .. .	45
21	Bass response—Cabinets .. .. .	46
22/1	Impedance—two speakers .. .. .	47
22/2	Impedance—parallel and with separator .. .. .	48
23	Acoustic labyrinth .. .. .	50
24	Compound Horn Cabinet .. .. .	51
25	Volume Control .. .. .	53
26	Cinema Speakers .. .. .	55
27	R.C.A. large Cinema Unit .. .. .	56
28	Reflecting Planes .. .. .	57
29	Wall mounting .. .. .	58
30	Absorption Co-efficients .. .. .	59
31	Transient (Impedance) response .. .. .	51
32	Transient (Resonance) response .. .. .	62
32/1	Pulse Effects .. .. .	63
33	Crossover networks .. .. .	64
34	Crossover/Impedance Curves .. .. .	65
35	Transformer Ratios chart .. .. .	68
36	Waves and Phasing .. .. .	75

## ACKNOWLEDGMENTS

Thanks are due to the authors and publishers named below for permission to reproduce the illustrations mentioned.

Figures 1, 17, 24, 26, 31 and 32 from Olson's "Elements of Acoustical Engineering". *D. Van Nostrand Co. Inc.*

Figures 5, 9, 18, 21, 23 and 28 from Henney's "Radio Engineering Handbook" *McGraw Hill Book Co. Inc.*

Figure 30 from Wood's "Physics of Music". *Methuen & Co. Ltd.*

Figures 10 and 11 from Seashore's "Psychology of Music". *McGraw Hill Book Co. Inc.*

Figure 9A from Olson & Massa's "Applied Acoustics". *The Blakiston Co.*

Figure 36 from Wood's "Sound Waves and their Uses". *Blackie & Son, Ltd*

Figure 27 by permission of R.C.A. Photophone Ltd.

## INTRODUCTION

Since the end of the war, there has been a marked increase in the interest shown in better quality of reproduction of radio and records.

This is probably due to three main causes—

1. During the war (and the black-out) many people turned their attention to good music and began to enjoy it for the first time.
2. Thousands of men in the forces had advanced radio experience.
3. Troops in Italy and other countries listened to operas and orchestras and many have returned home with a new interest in life—serious music.

On the lighter side, people who appreciate and enjoy a first-class dance band are beginning to listen for the true note of the double bass and the sizzling of the snare drums.

This little book is therefore intended for those who, for reasons similar to those mentioned above, are interested in the Loudspeaker and how it works and how results may be improved. The present scarcity and high cost of timber and plywood also account for a good deal of interest in home construction.

My qualifications for writing this booklet are not very extensive, as I am neither a scientist nor a mathematician, but I have been making loudspeakers for fifteen years, and all my life I have been fascinated by sound. In my search for the perfect piano, more than three dozen uprights and grands have darkened my door during the last 30 years. My hobby is music and I make a practice of attending concerts and playing the piano regularly in order to keep my hearing fresh, as I think that the tonal quality of music is quite as important as its melodic and harmonic structure. My approach to the subject is, therefore, as much from the musical angle as from the technical.

The book is written in non-technical terms throughout, and many readers may find some chapters extremely elementary. Nevertheless I hope they will be patient for the sake of those who have no knowledge or experience of the subjects concerned, for whom the book is primarily intended.

## INTRODUCTION.

I am indebted to the following people for kind and generous help—

Mr. F. Keir Dawson for drawing and preparing many blocks

Mr. F. Beaumont, chief engineer of Ambassador Radio, for reading proofs and correcting and supplying technical details.

My wife for patiently reading manuscript and eliminating a good deal of padding.

Members of my staff who have cheerfully made weird and wonderful models for purposes of test.

My thanks are also due to the Publishers who have so readily consented to the use of Diagrams and Tables from other books, to which I have liberally and unblushingly helped myself. I should like to place on record the friendly and generous attitude of the three American Publishers listed, which is a small but significant example of the goodwill which exists in the U.S.A. towards this country. The following books are strongly recommended to those who wish to go further into the subjects—

1. The Physics of Music, by A Wood (Methuen).
2. Psychology of Music, by Seashore (McGraw-Hill).
3. Elements of Acoustical Engineering, Olson (Chapman and Hall).
4. Radio Engineering Handbook, Henney (McGraw-Hill).

I am most anxious that anything I say in this booklet should not be taken as a reflection on set makers, as I fully appreciate that they are compelled by circumstances to provide selectivity, convenient size and attractive appearance, in addition to lively performance, and these attributes are not always compatible with best local station quality.

G. A. BRIGGS

May 1948.

## FOREWORD TO THIRD EDITION

*(9th Impression)*

The response to this "pithy pamphlet", as one American reviewer described it, has been so good that the First Edition of 5,000 copies was sold out in less than five months and the Second Edition of 3,000 copies was cleared in about two months.

The Third Edition, of which this is the eighth reprint, now runs to 27,000 copies, making a grand total of 35,000. More than 12,000 of these have been sold in the U.S.A.

It has not been found necessary to make any serious alteration to the text in the reprints, as the book deals mainly with the fundamentals of loudspeaker design and use, but comments on cabinet loading, crossover networks and phase effects in Chapters 13, 18 and 24 have been brought into line with modern precepts.

I think it is opportune here (having started blowing the trumpet) to refer to the later book, **SOUND REPRODUCTION**, which was first published in July 1949, followed by a Second Edition, revised and enlarged to 248 pages, published in May 1950. The two editions totalled 22,000 copies and were sold out by the middle of 1951. In view of the changes and progress made in the art of sound recording and reproduction during the last two years, the book has been completely revised and enlarged to 368 pages with no less than 175 new illustrations. This 3rd Edition was published in March, 1953.

May, 1953.

G. A. B.

"Loudspeakers" has been translated into French and Dutch and is published by P. A. Brans Ltd., Antwerp, Belgium.



*How sour sweet music is,  
When time is broke and no proportion kept !  
So is it with the music of men's lives.*

KING RICHARD II.

## CHAPTER I

# QUALITY of REPRODUCTION and DISTORTION

During the recent B.B.C. Jubilee programmes, when listeners were taken behind the scenes at Broadcasting House, it was frankly admitted that everything in Radio is a compromise. It will help in the study of loudspeakers if the reader will bear in mind that compromise enters into every aspect of the problem. There is no perfect loudspeaker, but we will assume that the objective is to get as near to the original as possible. We will ignore impracticable suggestions such as listening in sound-proof "dead" rooms with no ventilation, or sitting in the mouth of a huge exponential horn some fifteen or twenty feet square.

There is, however, another side to the question of quality which is so ably described by SEASHORE in "PSYCHOLOGY OF MUSIC" that we cannot do better than quote as follows —

"The engineering development in the control of the dynamics of tone in recording, reproducing and broadcasting is one of the most important contributions that has ever been made to the popularizing of music.

"In recording, for example, not only can the man at the instrument change instantly the loudness of the tone as a whole, but he can deal with any particular element of the tone selectively in such a way as to improve upon the performance of the instrument or the voice. This is called building up the tone."

No doubt many readers can recall instances where they have been disappointed on hearing a singer in person after hearing the same artist by radio or records. Nevertheless, in spite of this building up of tone, we still have to strive for natural results in reproduction, and it is possible to obtain better tonal quality but with an absence of naturalness, which seems to depend on the very high frequencies.

It is claimed by some experts that for really life-like results, frequencies up to 30,000 are necessary, because, although the average human ear cuts off at about 16,000 cycles, the difference-tones are heard. This means that if two tones of 20,000 and 30,000 cycles are produced, the difference-tone of 10,000 cycles may be heard, and its absence takes something away from the quality. All this is probably true, but these high frequencies are not available today.

It is probable that Frequency Modulation will produce a wider range than the present limit of 10,000 cycles in broadcasting, and improvements will no doubt be made in recording so that high frequencies are not completely swamped by surface noise. The power used at H.F. levels is very small, and a high tone is partly masked by a low one. This explains why needle scratch is inaudible during low note passages of music, and increasing the low frequency output of a speaker appears to cut the top.

For the purposes of this book we will try to deal with the situation as it is and not as it ought to be. Let us look on the Loudspeaker as a musical instrument as well as a piece of wireless equipment, and if the very high frequencies have greater annoyance value than musical merit, discard them.

The average commercial receiver still cuts off at about 5,000 cycles.

### DISTORTION

There are numerous causes of distortion in loud speakers, which are referred to in the chapters on Cones, Centring devices, Volume and Watts, Cabinets, Transients, Crossover networks, Feedback, Transformers and Phase effects.

Two special forms of distortion are dealt with in the following paragraphs—

The Transient or Delayed Action characteristic is a source of distortion which has been investigated by the Research Department of the B.B.C., and may be described as the unequal duration of vibrations at different frequencies. Tests are made by interrupting the A.F. signal at regular intervals of time and taking a sort of delayed-action response curve. Presumably, the non-uniform rate of decay at different frequencies is due to resonances in the vibrating system, which intensify the reverberation period.

There is one aspect of harmonic distortion which should be borne in mind. It is found that high frequency harmonic distortion is much more noticeable than harmonic distortion at medium and low frequencies. According to Olson, in "Elements of Acoustical Engineering," 5% second harmonic and 3% third harmonic are noticeable on equipment with uniform response from 45 to 8,500 cycles, but in the case of the higher harmonics introduced by Class B or pentode output a fraction of one per cent. is noticeable. It follows, therefore, that a loudspeaker with extended H.F. response will expose harmonic distortion in the frequency range where it is most objectionable to the ear, and such speakers should only be used on equipment which is above suspicion.

## CHAPTER II

# DEVELOPMENT OF LOUDSPEAKERS

Although the moving-coil or electro-dynamic type is now almost exclusively used, it is no doubt worth while to look at the five main electro-acoustic driving systems which have been used.

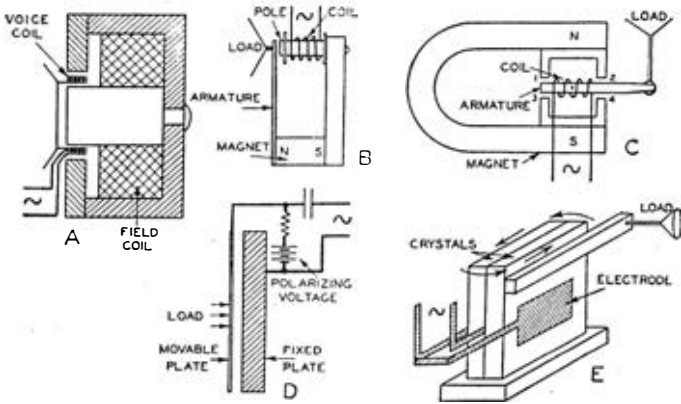

FIG. 1—DRIVING SYSTEMS.

- A electro dynamic—moving coil.
- B electro magnetic—moving iron.
- C electro-magnetic—balanced armature.
- D condenser.
- E crystal.

*From Olson, Elements of Acoustical Engineering*

**A.**—The response range and comparatively level impedance of the moving-coil system, coupled with low production costs, have established its superiority over all its rivals. (See Fig. 6, Page 21.)

**B.**—Moving-iron type. This consists of a permanent magnet operating directly upon a ferrous armature. Most of the earliest loudspeakers were based on this system. Reproduction was marred by reed resonance, distortion and absence of bass.

**C.**—Balanced armature. A definite improvement on the previous type, the balanced armature was extensively used about 18/20 years ago. It was not found possible to reduce the stiffness of the armature sufficiently to give bass response below 120 cycles.

**D.**—Condenser. This type has been used as a loudspeaker, with the plate radiating directly into the air. Its poor impedance

## DEVELOPMENT OF LOUDSPEAKERS

characteristic and the necessity for high polarizing voltage proved serious drawbacks and its popularity was short-lived.

**E.—Piezoelectric Driving System.** The bending and twisting properties of certain crystals with applied E.M.F's are well known, and are in regular use in microphones and pick-ups. The system has been applied to loudspeakers for high note reproduction, where the impedance characteristic appears to be favourable and awakening interest in extreme H.F. response may direct attention once more in this direction. The crystal is not easily adapted for bass reproduction on account of the large movements which are necessary in a loudspeaker at low frequencies.

### MOVING COIL SYSTEM

It is clear that the moving-coil system has no serious rival. Early types were fitted with high resistance voice coils, leather suspension and mains-energised magnets, mostly replaced today by low resistance coils with matching transformer, corrugated cones and permanent magnets. High resistance coils were wound with the finest enamelled wire, (46 or even 47 S.W.G.) for use in the plate circuit of the output valve. The casualty rate was very high, both during production and use, and no tears were shed at the total demise of this type, some 12/14 years ago. Today, voice coils of 2/3 ohms for domestic use and 15 ohms for public address are almost universally used.

The change from leather or other flexible surround to moulded corrugations was a very important factor in reducing the cost of production and certainly brought about large-scale adoption of the moving-coil unit, thus striking the death knell of previous electromagnetic systems. The effect on quality of reproduction was more questionable, as it is now realised that the apparent increase in efficiency (volume) was due to increased resonance, and much of the true bass was lost by stiffness in the suspension. Improvements have, however, been made in both these directions, and great skill is now used in producing cones having predetermined resonance points.

As regards the third change from mains-energised to permanent magnets, no one can doubt the efficiency of the modern P.M., and its convenience in use is self-evident.

The two extreme ends of the audio-frequency band are always the most difficult to transmit, to record and to reproduce with the

same efficiency as the middle register. It is fairly easy to make a moving-coil loudspeaker to cover 80 to 8,000 cycles without serious loss, but to extend the range to 30 cycles in the bass and 15,000 in the extreme top presents quite a few problems. Inefficiency in the bass is due mainly to low radiation resistance, while the mass of the vibrating system reduces efficiency in the extreme top. A large cone increases the radiation resistance and improves bass response, but the resulting increase in weight leads to poorer H.F. response. Various ways of meeting and overcoming these difficulties are dealt with in other chapters, but for domestic use the most successful combination of bass and treble in a single unit appears to be attained in a speaker of about 10 inches diameter.

### BINAURAL EFFECTS

There can be little doubt that the efforts of high fidelity enthusiasts to achieve natural reproduction are frustrated by single channel transmission and recording. We are accustomed to listening with two ears, which produce differences in phase and intensity at different frequencies. Two or three channel transmission and reproduction would retain the stereophonic effect, and we should be able to ease off in our struggle for realism, which so far has involved more and more "top", and the use of every variety of tone control which usually does no more than alter the type of unreality to which we listen.

## CHAPTER III

### MAGNETS

In the early models of moving-coil speakers the magnetic force was obtained by electric current in a large field coil, as much as 40 watts being dissipated in the biggest units. These electrodynamic speakers are often referred to briefly as mains-energised, or merely energised. It was impossible in those days to attain by permanent magnets the high flux densities developed in large energised magnets, and even medium efficiency required large and costly permanent magnets.

#### PERMANENT MAGNETS

These have been improved so enormously during the last 15 years that they are today always used, unless the conditions are such that it is more economical to use a field coil—for the double purpose of energising and smoothing.

We can, therefore, confine our remarks to permanent magnets. Research has been concentrated on reduction in weight, size and cost, with longer life, or in one word—efficiency. How successful this has been will be seen from the following drawings, illustrating the size and weight of magnet required for a flux density of 7,000 lines in a gap .040" wide on a centre pole 1" in diameter.

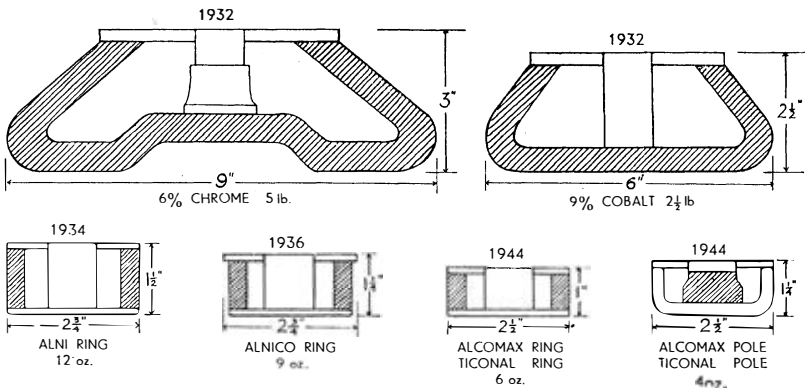

FIG. 2—APPROXIMATE SIZE AND WEIGHT OF MAGNET FOR EQUAL PERFORMANCE  
ALNI=Aluminium and Nickel.  
ALNICO=Aluminium, Nickel and Cobalt.  
ALCOMAX=Treated in Magnetic Field.  
British Alcomax III is equivalent to American Alnico 5.

The life of a modern magnet is so long that the title Permanent is hardly a misnomer, and the magnet can at any time be re-magnetised equal to new.

## FLUX DENSITY

It is possible to attain maximum flux densities without much difficulty, and limitations are now set by saturation of the mild steel parts. With a one inch centre pole, saturation occurs at 14,000 lines, and it is not economically possible to exceed this figure without reducing the size of the gap. With a  $\frac{3}{4}$ " centre pole and normal gap dimensions, saturation starts at 9,000 lines.<sup>1</sup>

It is not possible to assess the value of a magnet merely by reference to the flux density per sq. centimetre. Attention should also be paid to the total flux, as it is obviously feasible to increase the flux density per sq. centimetre by using thinner steel plates or reducing the gap area. Such a change might not be an improvement ; it would depend on the design and purpose of the speaker.

Using the same thickness of plate, a magnet giving 8,000 lines on a 1" centre pole would be superior to a magnet giving 9,000 lines on a  $\frac{3}{4}$ " pole.

The centre block type of magnet is being developed, especially for television sets, as it has no external field. It is the most economical design yet devised so far as weight of magnet is concerned, for small and medium types.

The cost of magnets increases rapidly when higher flux densities are involved. The flux density does not go up in proportion to the increase in weight, and after a certain performance is attained, each increment of 1,000 lines becomes more and more difficult to achieve. This accounts for the comparatively high prices charged for loudspeakers with high flux density. The approximate weight of magnet casting required for various flux readings on one inch pole are given for comparison—

8,000 lines,	8	ozs of Alcomax,	
10,000	„	12	ozs. „ „
12,000	„	20	ozs. „ „
14,000	„	56	ozs. „ „

Apart from improving sensitivity, high flux density increases the damping on the voice coil and gives life and attack to the reproduction with wider response range, and improved power handling capacity at low frequencies.

---

(1) Saturation of the pole is the main obstacle to high efficiency in small speakers with  $\frac{1}{2}$ " or  $\frac{3}{4}$ " voice-coil. A larger unit with 1" centre pole is easily designed to give much higher flux density and obviously greater total flux, with far superior performance at high frequencies.



## CHAPTER IV

### CHASSIS OR CONE HOUSING

In order to maintain the position of the cone, to hold the speech coil centrally in the magnet gap, and also to anchor the centring spider, it is necessary to have some sort of rigid frame-work.

As the clearance between the coil and magnet is usually not more than .010" and may be as low as .005", it will be realised that any bending or "give" in the chassis, however slight, may throw the coil out of centre and cause a rattle.

Chassis are generally made in pressed steel or die-cast aluminium alloys. The pressed steel variety is almost invariably used for mass production on account of low cost, and is quite reliable so long as the quality and gauge of metal are adequate. It is, however, worth noting that with the average steel chassis it is possible to distort the shape by using too much pressure when bolting to baffle or cabinet, and to throw the speech coil out of alignment. Fixing nuts should therefore only be reasonably tight.

Die-cast chassis are more costly than pressed steel, and are liable to fracture, but have the advantages of greater rigidity, less resonance, accurate dimensions, and open construction.

When a loudspeaker is mounted in a small cabinet, or in a wireless set surrounded by valves and components, the partial enclosure of the cone by the usual pressed steel chassis is of little or no consequence, but where acoustic loading on the back of the cone is involved, an open design of chassis is necessary.

The effect of chassis resonance was pointed out by the *Wireless World* in a series of loudspeaker tests made as far back as 1935.

## CHAPTER V.

### CONES

The design and construction of the cone play a most important part in the performance of a loudspeaker, affecting volume, range, clarity and power-handling capacity. The majority are now made in seamless moulded paper from special dies to very accurate dimensions.

The performance of a cone is affected by its size, shape, weight, texture and corrugations. Generally speaking, the cone which produces the greatest volume gives the worst quality. As the objective is lightness with rigidity, the straight-sided cone is generally adopted, but curved or exponential cones are sometimes used. This shape improves high note response, but in some cases reduces power-handling capacity.

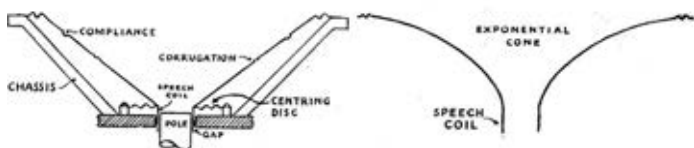

FIG. 3

SECTIONAL VIEW OF CONE ASSEMBLY.

CURVED CONE.

Elliptical cones are sometimes used, both with straight and curved sides, and have certain acoustic properties which differ from the usual circular shape, but low-note efficiency is inferior. An elliptical speaker should be mounted with its major axis vertical in order to get the widest horizontal distribution of high notes, in the same way that a small speaker radiates over a wider angle than a big one at H.F.

### CORRUGATIONS

The corrugations around the periphery control the fundamental resonance, and the frequency can be lowered by making the corrugations thinner—a point of considerable importance.

A common fault in loudspeaker cones is the development of sub-harmonics. When a pure tone in the upper register is introduced with sufficient power, an extra note is produced by the cone at a lower frequency. Some people hold that this is of no consequence, as this steady tone condition is never arrived at in normal use.

## CONES

This may be true, but the fact remains that a cone which breaks up badly into sub-harmonics belongs to the "loud" variety, and gives poor definition in orchestral effects. In any case there is little need today to select a cone or speaker for domestic use on account of its loudness, as most wireless sets provide ample volume.

Mid-cone corrugations are often employed. A corrugation may be inserted to add rigidity to the cone in a radial direction and subdue the sub-harmonics mentioned above. Other corrugations may act as compliances to subdue or arrest the top note vibrations.

### CONE ACTION

A cone moves as a piston at frequencies below the lowest mode of the cone itself, unless the surround or suspension is so stiff as to cause the cone to flex even at low frequencies. Such flexing distorts the low notes and increases loudness at harmonic frequencies, and intermodulation between treble and bass occurs, with inevitable rough and unpleasant top note response.

The frequency at which a cone ceases to act as a piston is about 1,000 cycles in an 8" cone, and at this frequency all parts of the cone move in phase. The displacement is greatest at the apex and least at the periphery, where the transmission line terminates. The impedance of this termination is very important.

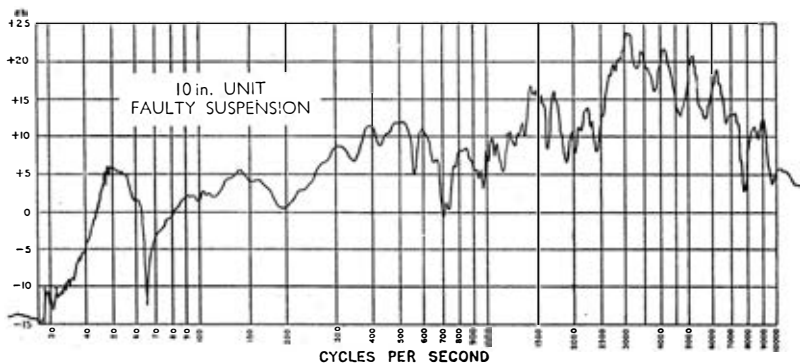

FIG. 4—Response Curve of 10" Speaker with uneven suspension affecting bass, and bakelized apex affecting H.F. output.

Fig. 4 shows the drop in bass response resulting from uneven pressure around the periphery of a cone caused by upward pressure from the centring device. The dip in the bass was removed by levelling the surround and elevation.

At frequencies higher than the above mode, the cone vibrates in sections, and the region of the apex plays a more and more important part as the frequency rises. The apex is often specially treated, and Fig 4 also shows the effect of actually bakelizing this portion of a ten-inch paper cone.

### DIAMETER

The size of a cone is also a question of some importance. The low note efficiency increases with size at the rate of about an octave per four inches diameter for the same movement, Fig. 5. It is also much easier to keep the fundamental resonance at a low frequency with a bigger and heavier cone, but the extreme top becomes more difficult.

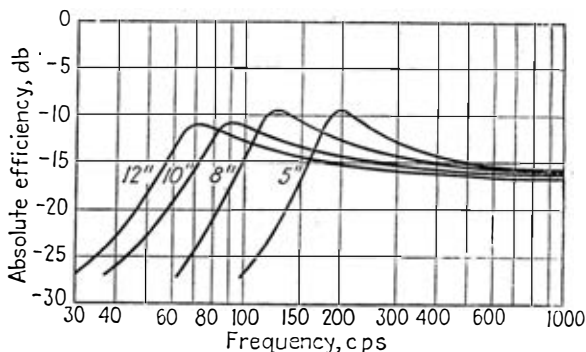

FIG. 5—Efficiency of Four Speakers of different size with same magnet.

*From Henneys Radio Engineering Handbook*

All cones are directional at high frequencies, but in this respect a small cone is better than a large one, as its high note radiation covers a wider angle. The small cone is also more efficient at high frequencies, with the same flux density, but it should be remembered that small speakers are usually fitted with small magnets resulting in lower acoustic output.

### FREQUENCY DOUBLING

This is the most common fault in a loudspeaker, and usually occurs at all frequencies below the main cone resonance, although it can be caused at higher frequencies by incorrect loading, such as an unsuitable horn. Where the fault occurs, the speaker produces a note an octave or more higher than the input, which often sounds more like a rattle than a musical tone. True bass reproduction in the region of frequency doubling is quite impossible.

## CHAPTER VI

### CENTRING DEVICES

In view of the small gap in which a speech coil is expected to vibrate without fouling the magnet, some form of centring device is essential.

A perfect device would prevent all lateral movement of the coil, would help to retain its correct elevation when at rest in the gap, but would not impose increasing restraint as the piston movement of the coil develops, and would not have any self-resonance.

The first two of these qualities are fairly practicable, but the second two are not so easy, and we must still look on the centring device as a necessary evil.

In the early days of moving-coil speakers front spiders were generally used, but have been almost entirely superseded by rear suspension devices. The back spider—as it is called—is superior for three main reasons—(a) it is located nearer the actual coil ; (b) it does not directly affect the high note response of the cone ; and (c) it can be designed with longer limbs to reduce restraint at maximum deflection. Many kinds of tough paper and fibre have been used for spiders, but bakelised fabric is now widely used on account of its non-hygroscopic and resilient qualities.

Moulded paper corrugated discs have also been extensively used, and are attractive for closing the magnetic gap against dust and filings. Similar discs in a fabric material are now being produced and have distinct advantages, such as greater flexibility and resilience with less resonance.<sup>1</sup> The equal radial pressure of the corrugations is also a safeguard against non-linearity at cone resonance.

Distortion will be caused at low frequencies by the centring device if it is mounted in such a way that unequal radial or piston pressure is exerted on the cone and coil assembly, or if the amplitude of piston movement is excessive. Such distortion is mostly third harmonic.

---

(1) **Centring Devices.** The type of device used has a marked effect on the L.F. output of the speaker. Corrugated discs tend to reduce the resonance peak and widen its frequency range. In some cases the bass is increased by a sort of drum effect, giving woolly reproduction. The bakelised spider gives a sharply defined bass resonance to the cone, resulting in a crispness in the tone which is favoured by many designers.

## CHAPTER VII

# IMPEDANCE

The speech coil of a moving-coil speaker has inductance as well as resistance, which means, in plain language, that its resistance to alternating current varies according to the frequency of the current, and therefore, for a given applied E.M.F., the current flowing in the coil will vary with frequency. This form of A.C. resistance is known as Impedance. The impedance characteristic of the M. C. speaker is far superior to other types of reproducer, as a glance at Fig. 6 will show.

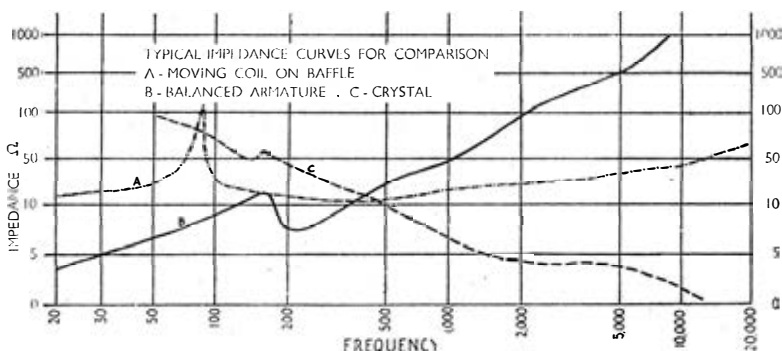

FIG. 6—IMPEDANCE CURVES.

The impedance of a loudspeaker is usually measured by comparing the voltage developed across the speech coil at different frequencies with the voltage across a known resistance, by means of a valve voltmeter.

Broadly speaking, the impedance curve can be taken as a measure of the superiority of the moving-coil speaker over all its rivals, and its importance in considering the performance of any model cannot be over-emphasised.

The impedance of the speaker is also affected by mechanical considerations, such as the cone resonance, the air loading imposed by the method of mounting, and vibrations of cabinet.

Whereas response curves vary enormously according to the method of taking them, and may even require a pinch of salt to aid digestion, an impedance curve at a given volume level can be accepted as a statement of fact. It may also be said that any alteration to design, or the method of mounting, which improves the impedance curve of a loudspeaker generally improves its performance (artificial loading excluded).

## IMPEDANCE

It is, of course, necessary to know the impedance of a speaker in order to match the load, but this is dealt with under the heading of Transformers. As the impedance varies with frequency, it is impossible to have so-called accurate matching, and it is usual to accept the impedance at a frequency between 400 and 1,000 cycles as a representative value. Where the speaker impedance is not known, it may be taken as 30/50% higher than the D.C. resistance of the voice coil.

The two main defects of the moving-coil speaker are the rising impedance in the treble and the hump in the bass at the fundamental resonance. These are clearly shown in Fig 7/A. The first of these is countered by various cone arrangements and modifications, or by employing two cones, two coils, or two speakers. The effect of using two speakers with a crossover at about 1,000 cycles is shown in Fig. 34, page 65, where the curve remains fairly level between 1,000 and 5,000 cycles instead of rising sharply.

Now whereas the rising impedance in the treble leads to loss of output unless counteracted, the rise in the bass signifies increased acoustic output as it arises from mechanical resonance, and one way to deal with it is to make a virtue of necessity and use it for reinforcing bass response, provided it occurs at a sufficiently low frequency. The resonance can quite easily be eliminated by electrical or mechanical damping, but audible results do not seem to justify such drastic treatment. It is often an advantage to cut out part of the bass resonance by negative feed-back, and make use of the remainder. The effect of Reflex loading is shown in Fig. 7, where the hump in the bass is reduced by 50%, the fundamental resonance is lowered by 20 cycles, and the wave form between 30 and 75 is audibly improved.

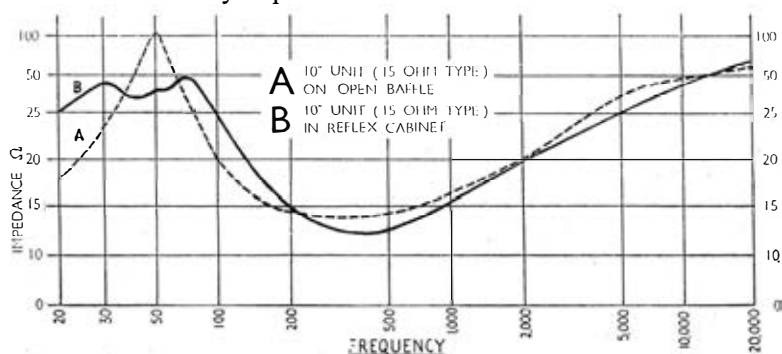

FIG. 7—Impedance Curves to Show improvements due to Reflex Loading Cabinet used 30" × 15" × 12".

It will be appreciated that the cone movement at low frequencies in curve 7/B is much less than in curve A, and there is no pronounced peak. This reduces distortion, eliminates one note bass effects, and increases power-handling capacity.

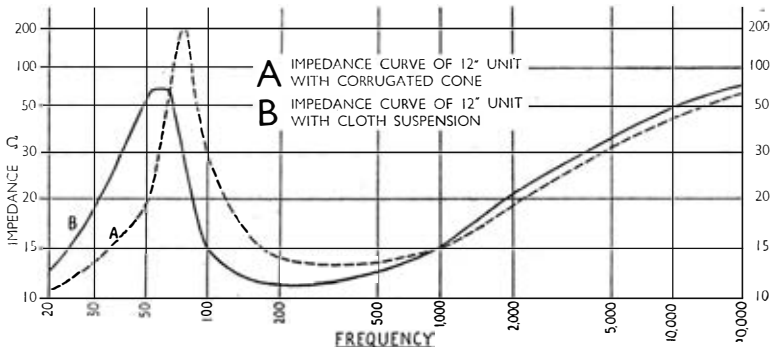

FIG. 8—Impedance Curves to show effect of soft suspension.

An impedance test also shows the effect on bass resonance resulting from fitting a soft surround to a cone in place of the usual corrugations, see Fig. 8. Here again the peak voltage is reduced and the hump in the curve has a wider base and occurs at a lower frequency. (See Transient Response, Chapter xvii.).



## CHAPTER VIII

### PHONS AND DECIBELS

The Phon is a unit of measurement of loudness which allows for the difference in sensitivity of the ear at different frequencies. One phon is about the smallest increase of loudness which can be noticed under ordinary conditions. Every time the intensity of sound waves is doubled, the loudness increases by about 3 phons. For example, if a wireless set is working and giving out 60 phons, and another set is turned on at the same volume level, the combined loudness will be 63 phons. Similarly, if you connect an extension speaker to a set you approximately halve the volume in the main speaker, or in other words reduce the loudness by 3 phons. Unfortunately, even the phon does not agree with the ear's idea of loudness, and there is no recognised scale based on this. When you reduce volume level by half, the impression in the ear is that it has only been reduced by about one-fifth, and this peculiarity of hearing has certainly helped in the widespread use of extension speakers.

According to Alexander Wood, in "The Physics of Music", the range of power from a full orchestra playing *ff* to the solo violin playing *pp* is in the ratio of about twenty million to one.

This does not mean twenty million times as loud, because the intensity of the sensation of hearing is proportional not to the stimulus but to the logarithm of the stimulus. Thus equal increments of loudness are obtained, not by adding, but by multiplying by the same factor—so that 10 to 100, 100 to 1,000, and 1,000 to 10,000 are equal increments. The same law applies to frequencies, where each octave is double the one below.

Hence the necessity for a logarithmic basis for the decibel and the phon.

In the book mentioned above, Mr. Wood also says: There seems little reason to doubt that in future the phon scale for loudness will replace the indefinite *p* and *f* marking on the music score. Already Stokowski uses a phon meter, and interprets his score as

<i>ppp</i>	20 phons	<i>f</i>	75 phons
<i>pp</i>	40 "	<i>ff</i>	85 "
<i>p</i>	55 "	<i>fff</i>	95 "
<i>mf</i>	65 "		

One can see the usefulness of this marking for recording and broadcasting purposes, as the conductor could be responsible for controlling maximum and minimum volume levels without interference by an engineer, and no doubt this would give a more artistic result to the listener.

A further list from "Physics of Music" gives the power actually radiated as sound by various musical instruments—

<i>Source</i>	<i>Loudness</i>	<i>Power in Watts</i>
Orchestra of 75	.. maximum	70
Bass Drum	.. .. "	25
Pipe Organ	.. .. "	13
Snare Drum	.. .. "	12
Cymbals	.. .. "	10
Trombone	.. .. "	6
Piano ..	.. .. "	0.4
Saxophone	.. .. "	0.3
Bass Tuba	.. .. "	0.2
Double Bass	.. .. "	0.16
Piccolo	.. .. "	0.08
Flute ..	.. .. "	0.06
Clarinet	.. .. "	0.05
French Horn ..	.. .. "	0.05
Triangle	.. .. "	0.05
Bass Voice	.. .. "	0.03
Alto Voice	.. .. <i>pp</i>	0.001
Speech ..	.. .. Average	0.000024
Violin ..	.. .. Softest	0.0000038

The difficulty of recording and broadcasting both extremes of loudness will be appreciated. The following readings with a Phonometer are included for purposes of comparison—

	<i>Meter Reading</i>
Orchestral record, about 10 Watts to speaker	.. 98 db.
Soprano record, full domestic volume	.. .. 80 "
Needle scratch, same output as above	.. .. 47 "
" " " " centre groove	.. .. 54 "
" " " " acetate disc	.. .. 40 "
Piano, 7' 6" grand, full volume	.. .. 90 "
" " " bottom C loud	.. .. 87 "
" " " middle C "	.. .. 83 "
" " " top C "	.. .. 67 "
Typewriting machine	.. .. 60 "
Normal speech	.. .. 60 "
Quiet speech.	.. .. 50 "
Inside car, motor idling	.. .. 58 "
" " travelling uphill at 30 m.p.h.	.. .. 78 "
Very quiet room	.. .. 30 "

## PHONS AND DECIBELS

The needle scratch could be heard with the soprano, but not with the orchestra. The acetate scratch level of 40 db. is inaudible on all but the quietest passages. The motor car noise of 78 db. is too high for comfortable listening, but 58 db. is about equal to needle scratch.

A very loud sound seems almost equally loud from 30 to 6,000 cycles, as shown in Fig 9, but as the intensity is reduced the loudness falls off rapidly below 400 cycles and soon becomes inaudible below 60 cycles.

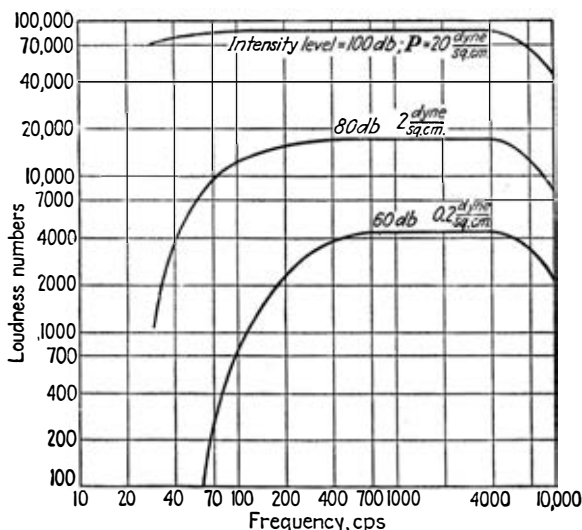

FIG. 9—Loudness Variation with frequency for three pure tones of the indicated intensity.

*From Henney's Radio Engineering Handbook*

The ear is most sensitive to frequencies between 2,000 and 5,000 cycles, and gradually less sensitive towards extreme bass and extreme top. It follows, therefore, that the same frequency response in amplifiers and loudspeakers will not suit all volume levels.

Considerable improvement to low-level reproduction of music can be achieved by using a three-channel amplifier where the extreme bass and top can be increased independently of the middle register.

Alternatively, a "straight" set or amplifier with a tone control to suppress the middle would answer the same purpose.

On the other hand, the reproduction of speech is often enhanced by reducing bass response, and where articulation is more important than naturalness the response range can be limited to 600/4,000 cycles.

## DECIBELS

In acoustics the ranges of intensities are so large that it is convenient to use a scale of smaller numbers termed decibels (abbreviation db.), based upon a logarithmic basis.

The decibel is not a measure for defining any voltage or power ; it is an expression for comparing them. It is generally used for response curves, as it gives a comparison of the outputs at different frequencies regardless of the actual power level at which the tests are made.

The only difference between the decibel and the phon is that the latter is regulated to correspond to the sensitivity of hearing at different frequencies.

<i>Frequency</i>	<i>D.B.</i>		<i>Phons</i>		<i>D.B.</i>		<i>Phons</i>
	<i>above threshold</i>						
1,000	20	=	20		40	=	40
500	20	=	22		40	=	46
200	20	=	25		40	=	56
100	20	=	30		40	=	72
50	20	=	40		40	=	90
30	20	=	60		40	=	105

The above table shows that a note starting at 1,000 cycles at 20 db. above threshold of hearing, and dropping to 30 cycles, would have to be increased in power by 40db. to avoid sounding less loud at 30 cycles.

The above relationship is shown in the form of graphs in Fig 9a. When a 100 cycle note is increased in intensity from 20 to 40 db., the loudness goes up from 30 to 70 phons. This explains why increase of loudspeaker volume increases the bass out of proportion to middle and upper registers, and often results in boom if carried to excess.

## PHONS AND DECIBELS

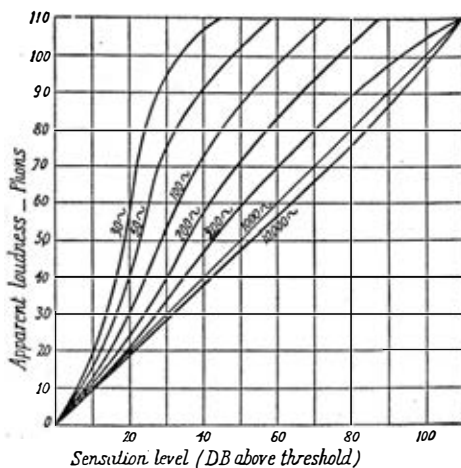

FIG. 9A—Curves to show apparent loudness compared with intensity for various frequencies.

*From Olson and Massa's Applied Acoustics*

### DECIBEL TABLE

The relation between Decibels and Power and Current or Voltage ratios.

Power Ratio	Decibels	Current or Voltage Ratio	Decibels
1	0	1	0
2	3.0	2	6.0
3	4.8	3	9.5
4	6.0	4	12.0
5	7.0	5	14.0
6	7.8	6	15.6
7	8.5	7	16.9
8	9.0	8	18.1
9	9.5	9	19.1
10	10	10	20
100	20	100	40
1,000	30	1,000	60
10,000	40	10,000	80
100,000	50	100,000	100
1,000,000	60	1,000,000	120

## CHAPTER IX

### FREQUENCY RESPONSE

Music consists of four elements—

- a. Pitch or Frequency.
- b. Intensity or Loudness.
- c. Time or Rhythm.
- d. Tone quality or Timbre.

It will be clear that a loudspeaker only seriously affects the last of these. It cannot change the pitch of music (apart from introducing one note bass, which only occurs today in poor equipment). Mutilation of the intensity may occur during transmission or recording, when loud passages are subdued to avoid overload and soft passages are strengthened to maintain audibility; the loudspeaker is blameless in this respect. It certainly does not alter the time or

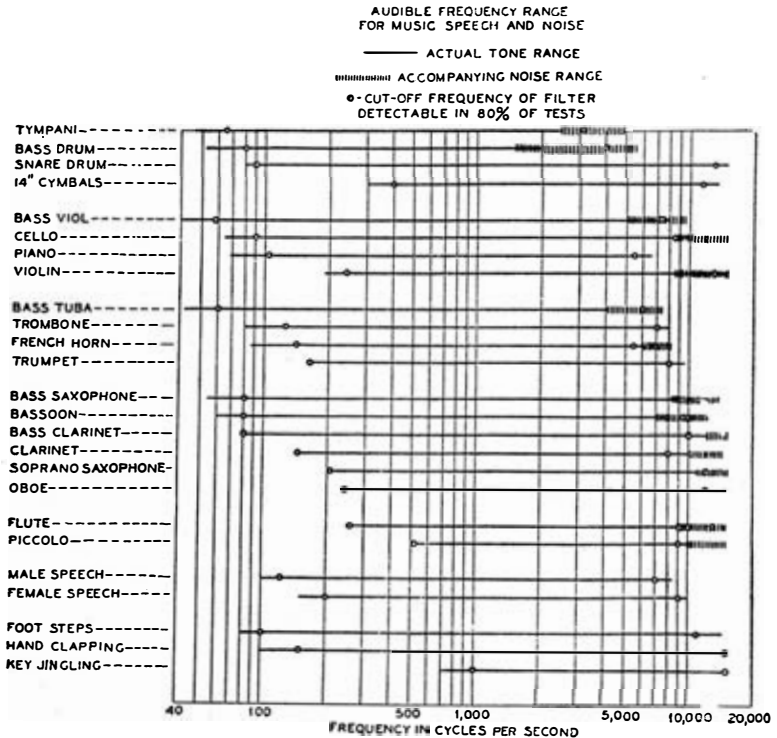

FIG. 10.

*From Seashore's Psychology of Music  
(McGraw-Hill)*

## FREQUENCY RESPONSE

rhythm of music, so we are left with tone quality or timbre, and this is most certainly seriously affected by the frequency response of the loudspeaker.

The maximum frequency range of the human ear is stated by some authorities to be 20 to 20,000 cycles, although in the tests I have made on young people I have found a cut off at 16,000 cycles. Ability to hear high frequencies recedes with advancing years, and most people over 60 do not hear much above 10,000 cycles, in spite of the fact that they may show no trace of ordinary deafness.

When we consider the frequency range necessary for the reproduction of music, we cannot confine ourselves simply to the frequency of the note being played ; the overtones, the noises associated with the instruments and the relative unimportance of many fundamental frequencies must be taken into account.

Interesting tests were made in America by Snow in 1931, and the results are shown in Fig. 10. It will be noticed that the double bass requires the lowest fundamental of 40 cycles for perfect fidelity and the piano was found to be the only instrument which did not require fundamentals below 100 cycles for true reproduction.

At the upper end of the scale, a cut off at 6,000 cycles did not impair the quality of piano tone, but snare drums, cymbals and the oboe require response well over 10,000 cycles. Hand clapping and key jingling also call for the highest frequencies. Normal listening tests seem to confirm these findings.

It is clear that for laboratory and monitoring work a range of 30 to 16,000 cycles is necessary, but for home listening under present conditions, a more limited frequency range often proves adequate. We still have to contend with needle scratch, whistles and valve hiss, and a reproducer which is too good in the extreme top can, at times, be rather a nuisance. One hesitates to be too dogmatic on this subject, but there is not much doubt that a loudspeaker free from peaks in the 3,000 to 5,000 region and with a falling characteristic from 8,000 to 16,000 cycles, is to be preferred to one with fuller output above 8,000 achieved by prominence in the upper middle register.

## HARMONIC ANALYSIS

At this point it may be of interest to see what actually constitutes a musical tone as heard by the ear. This is found out by harmonic

---

AUTHOR'S NOTE - August 1949.—The above tests by Snow are now rather out-dated. Today, true reproduction of the piano would require a wider range than 100—6000 cycles. Laboratory work would certainly call for L. F. response down to 30 c. p.s. without frequency doubling.

TABLE I. COMPARISON OF PERCENTAGE OF ENERGY AND DECIBEL VALUE IN ONE WAVE OF A VIOLIN TONE, 196~, FURNISHING DATA FOR FIGS. 1, 2a, AND 2b.\*

Frequency	Number of partials	Percentage of energy	Decibel value
196	1	0.1	
392	2	26.0	24.2
588	3	45.2	26.6
784	4	8.8	19.5
980	5	8.5	19.3
1176	6	4.5	16.5
1372	7	0.1	1.3
1568	8	4.8	16.8
1764	9	0.1	0.6
1960	10	0.0	*
2156	11	0.1	1.3
2352	12	0.0	*
2548	13	0.2	2.4
2744	14	0.0	*
2940	15	0.1	*
3136	16	0.0	*
3332	17	1.1	10.4
3528	18	0.1	*
3724	19	0.2	2.6
3920	20	0.0	
			99.9

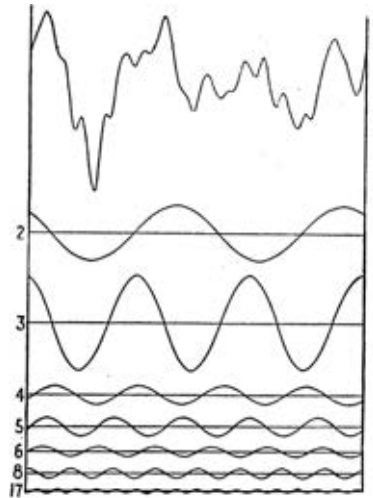

FIG. 1.—Dominant partials in a violin tone (see Table I).

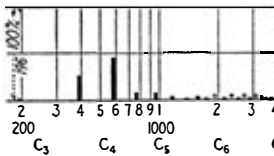

FIG. 2a.—Tone spectrum in terms of percentage of energy.

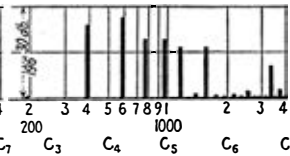

FIG. 2b.—Tone spectrum in terms of decibel values.

FIG. 11.—Harmonic Analysis.

*From Seashore's Psychology of Music (McGraw-Hill)*

analysis, and an example from Seashore's *Psychology of Music*, Fig. 11, gives the tone spectrum of the open G string of a violin played with medium intensity. It will be noticed that there is only 0.1% of energy in the fundamental frequency of G 196, and this shows why the fundamental can be omitted from reproduction without destroying the pitch of the note. This fundamental is



## FREQUENCY RESPONSE

established by the difference-tone of 196 which occurs between the overtones.

The top wave of Fig 1 is an oscillogram of the full tone, which was analysed up to 20 partials, covering a total frequency range of about four octaves. When one reflects that a single note has such a complicated structure, it is difficult to imagine the thousands of wave formations produced by a full orchestra, and it is astonishing that a loudspeaker cone sorts them out so well as it does. The percentage of energy shows how important are the overtones for true tone colour, and it explains why the violin begins to sound like a flute when severe top cut occurs. The flute is an instrument with most of the energy in the fundamental, especially at low volume.

## TONAL BALANCE

The question of balance is always most important, and affects the listener even more than range. If one end of the scale is cut, it is necessary to cut the other end to balance. A small unit with full input in the top and no bass sounds strident, and is improved by cutting the top to make up for the absence of masking effect from the bass. On the other hand, good bass reproduction without adequate top sounds boomy; this can be observed in many radio-grams fitted with superhets originally designed as table sets. In such cases results are improved by reducing the bass. The fact is that the human ear can tolerate frequency loss at both ends of the audio range, but is distressed by undue prominence in any section.

It is a good plan to take 800 cycles as a centre point and balance the frequency range above and below it. Thus a commercial set which cuts off seriously at 5,000 cycles should start to fall off at 100 cycles downwards.

This chapter is concluded by a chart showing the piano keyboard with the frequency of each white note based on concert pitch which is today A440 in Europe, and America. The wavelength of various notes is given, and any others are easily found by dividing the frequency into 1,120, which is the speed of sound in air in feet per second. Minimum baffle sizes for full bass radiation and 6db. loss are also given.

---

A loudspeaker falls off in bass response at the rate of 6 db per octave below minimum baffle or cabinet area, and at 12 db per octave below frequency of cone resonance.

## FREQUENCY RESPONSE

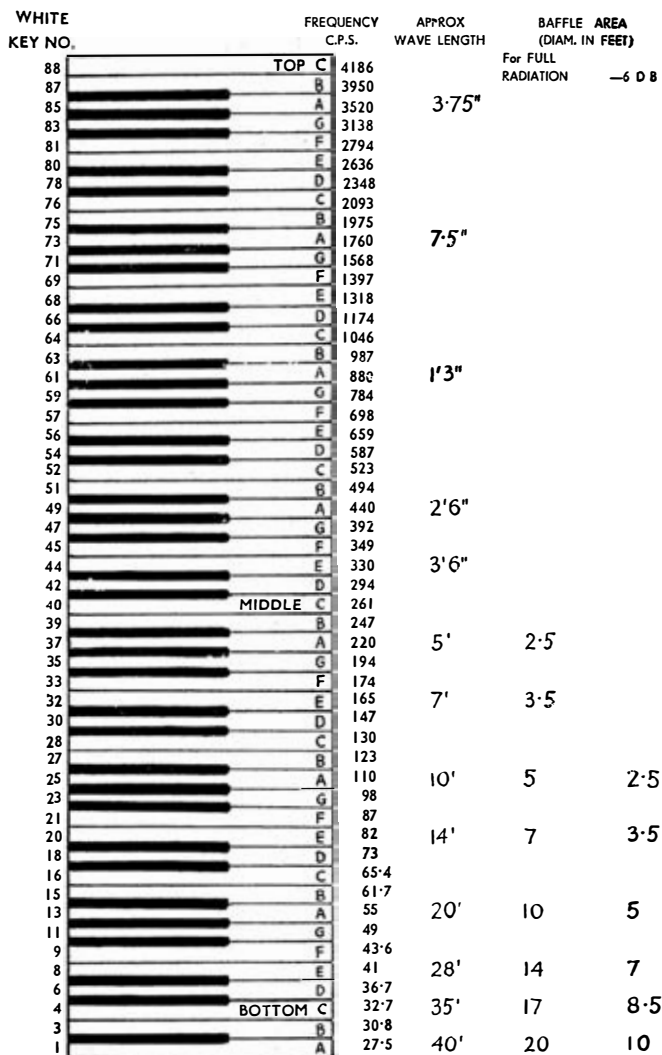

FIG. 12.—Piano Chart.

Approximate length of Open Organ Pipes.

Frequency	16	32	64	128	256	c/s.
Open Pipe	32ft.	16ft.	8ft.	4ft.	2ft.	long.

The length of a pipe closed at one end is half the above.

## CHAPTER X

### RESPONSE CURVES

Although Response Curves vary enormously according to the conditions under which they are taken, they are invaluable for purposes of comparison and research. It is not possible to take these curves in an ordinary room because of reflected waves. It is necessary to go outside away from noise and clear of buildings—preferably in the middle of a field—or construct a sound-proof room acoustically dead. A dead room is one in which all sound waves are absorbed by the walls, floor and ceiling so that no reflection occurs at any frequency. Such a room is costly to construct and difficult to achieve on account of standing waves.

The speaker under test is fed from a low impedance source with the output from an audio frequency oscillator, and its output is picked up by a microphone, then amplified and recorded.

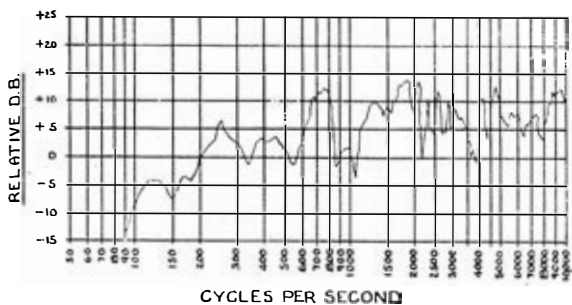

3 1/2 P.M. UNIT. MIKE 18 INS AWAY ON AXIS.

FIG. 13.

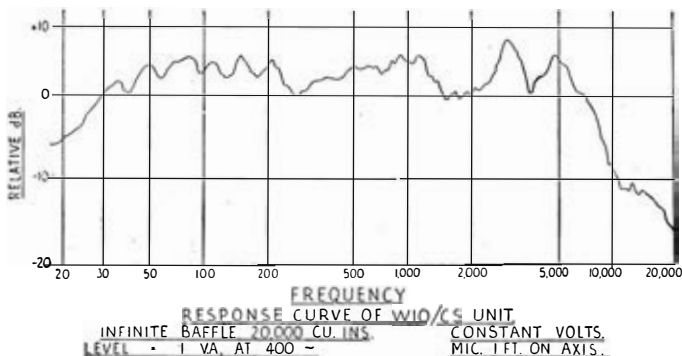

RESPONSE CURVE OF 10 INCH UNIT  
 INFINITE Baffle 20,000 CU. INS. CONSTANT VOLTS.  
 LEVEL - 1 VA. AT 400 - MIC. 1 FT. ON AXIS.

FIG. 14—10" Unit with cloth suspension.

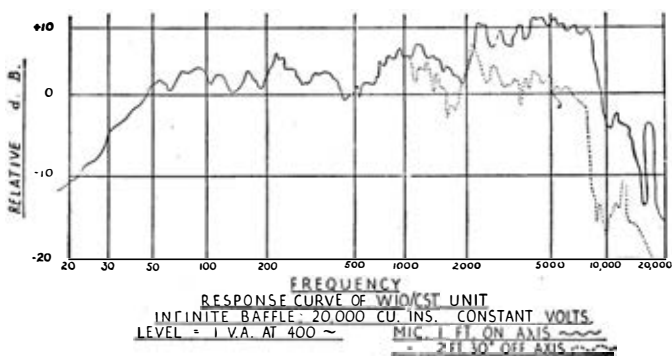

FIG. 15.—10" Unit—Curved cone with cloth suspension.

Three examples of response curves are given in Figs. 13, 14 and 15. The severe drop in the bass with the 3½" unit is shown, with a peak at 250 cycles where the fundamental cone resonance occurs.

The two following curves show the increase in high frequency output resulting from the use of a curved cone, compared with a straight-sided cone, with the addition of an extra characteristic to show the drop in output which takes place 30° off axis.

It is usual to assume that a level response under test conditions is the ideal to be aimed at, but in view of the varying effect of room reverberation at different frequencies, this assumption is open to question. In the 1937/38 infinite baffle speaker designed by two members of the Post Office staff, rising characteristic in the treble was specified to balance room absorption of carpets, curtains, cushions, etc., but low notes are also absorbed and are affected by radiation impedance due to size and shape of room. The final test is still a listening test under actual conditions.

A serious fault in the normal pressure response curve is the inclusion of the harmonics from frequency doubling or trebling in the range below the main cone resonance. This is rather like paying for a sack of coal which contains 50 per cent slate. Oscillograms in the Third Edition of *Sound Reproduction* expose these faults in their true light.

The main weakness of a response curve is that it does not expose the transient response of the speaker. When a sharp pulse or square wave impulse is fed into a loudspeaker, the transient position is quickly exposed, and any speaker with a mechanical compliance, such as rubber, in the speech coil system, or a joint in the body of the cone, fails to respond sharply to such impulses. The integral cone and coil assembly, with very soft suspension at the periphery of the cone, gives the best results.

## CHAPTER XI

### VOLUME AND WATTS

Many people are puzzled by the rating of loudspeakers in watts. This rating generally refers to the peak input, as the volume — or wattage—is constantly changing. It does not mean that a unit rated at 15 watts is not suitable for 5 watts, although it would be uneconomical to buy a speaker rated far above its probable maximum load, and better results may be possible with a smaller unit.

One watt is the power required to raise a weight of 1 lb. steadily by about  $8\frac{1}{2}$  inches per second. Some interesting comparisons are given in "Physics of Music" by A. Wood. For instance, a man doing manual labour develops a power of about 100 watts, or enough power to keep alight a 100 watt electric lamp.

We refer, of course, to the power going into the loudspeaker, which is vastly different from the power produced as sound. If the efficiency is 5%, an input of 5 watts will radiate 0.25 watt as actual sound, but heavy losses are common to all musical instruments. To quote again from "Physics of Music", a large organ may require an engine developing 10 kilowatts (10,000 watts) to blow it, yet all that appears as sound may be 12-14 watts. A pianist may use energy at the rate of 200 watts to produce 0.4 watt as sound. The human voice is a most efficient musical transformer, yet only 1% of the energy used by a vocalist goes to charm the audience, (all from "Physics of Music").

It is customary to complain about the inefficiency of the loudspeaker in transforming energy into sound, but in comparison with other musical transformers it comes out very well, and the usual minimum 2% calculation appears to be satisfactory, while a figure of 30% efficiency for exponential horns at certain frequencies is remarkably good. The average power radiated by a violin would be about .002 watt. With a speaker efficiency of 2% this requires only one-tenth of a watt input. As the frequency range of a violin is 200 to 9,000 cycles (including overtones) very good reproduction is possible with a small set and a small speaker.

Now the piano radiates about 0.4 watt, with a frequency range of 70 to 7,000 cycles for good reproduction, so the small speaker with its assumed efficiency of 2% would require 20 watts for full reproduction, which is obviously impracticable. In any case, most of the power is used in the bass, so we must turn to a larger unit, adequately baffled, for full scale results. Take a 10" speaker with

about 10,000 lines flux density. Here the efficiency may be about 5%, requiring 8 watts input at full volume, which sounds a more reasonable proposition. If we now improve efficiency still more by using a bass reflex cabinet, and an extra speaker for treble, reflect the top, and use better magnets, we may get an efficiency of 10/15% and reduce the required input to 4 watts or less. The nett result is that we reduce the dangers of overloading both the set and the speaker, and we completely alter the balance of power between treble and bass. In the case of the small unit any attempt to approach full volume would result in distortion and distressing overload. In the second case, a 10 watt amplifier would provide the required input for the 10" unit, but bass resonance would probably be excessive. In the third case, full piano range and volume are available from 5 watt equipment, the treble is not stressed, and results are "easy on the ears". No doubt such a set-up would cure the habit of the average listener of turning the tone control to "mellow", which is partly due to unbalanced power in the frequency range of the reproduction.

We have taken the piano to illustrate the question of watts and loudspeaker balance, because we all realise easily what is meant by full piano volume. The same arguments apply to the orchestra, with much greater force.

For domestic use, an output of 5 watts with not more than 0.1% distortion should satisfy the most critical listener. For those who like to blow the roof off occasionally when the rest of the family is out of ear-shot, a 10 watt job is ideal. It should be understood that 10 watts undistorted output is more tolerable than 5 watts with 2% distortion.

### PEAK INPUT

It is advisable to observe the input limits stipulated by speaker makers. Occasional overload does not matter, but continuous overload leads to trouble.

The main causes of overload in a speaker are the following—

1. Excessive heat generated in the speech coil.
2. Excessive movement of the speech coil in and out of the magnetic gap.
3. Actual distortion of the cone shape or walls.
4. Distortion due to suspension.

Let us examine these effects in turn—

1. Excessive heat is the most serious danger because it can occur without audible warning, and eventually leads to breakdown of insulation or adhesives, or to distortion in the shape of the coil.

## VOLUME AND WATTS

Movement of the coil on low notes helps to reduce temperature, so it follows that a speaker used only for treble reproduction is more prone to over-heating than when used also for bass. A large diameter coil will naturally carry more current than a smaller one, as thicker wire can be used for the required resistance.

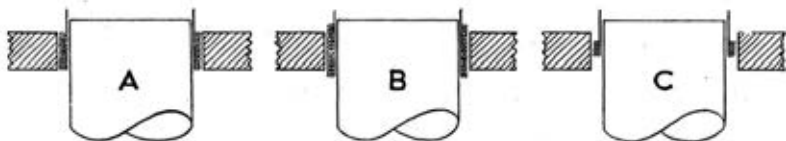

FIG. 16—Variations of speech coil length, to counter large L.F. movements.

2. Excessive movement of the coil in and out of the gap causes harmonic distortion, due to variation in the flux cut by the coil. Non-linear distortion of this type can be reduced by making the coil shorter than the gap so that it remains in a uniform field, or by lengthening the coil so that one side moves in to a stronger field as the other side moves into a weaker one. Either of these arrangements leads to loss of efficiency if carried to excess. A speaker with the desirable attribute of free suspension is more prone to distortion of this sort than one with stiff suspension, and is therefore usually rated lower in watts. Distortion resulting from this form of overloading should be eliminated by reducing the volume, or by using two speakers and separator.

3. Actual overloading of the cone is not very common in these days and it is surprising how much punishment a well-made cone will absorb without complaint. The straight-sided cone is better than a curved or so-called exponential cone in this respect. Much of the distortion commonly attributed to the speaker is due to amplifier overload.

4. Suspension. In practically all loudspeakers, the stiffness of the suspension increases with amplitude, and distortion (mostly third harmonic) occurs in the bass, particularly below the resonance point, if the movement and volume are excessive. There is not much the user can do about this, apart from improving the loading by acoustic chambers, or using two speakers (see Chapters on Impedance and Cabinets)

## CHAPTER XII

# RESONANCE AND VIBRATION

Sound consists of two sorts of vibration—forced and free. The definitions by A. Wood in “Physics of Music” are as follows—

**Free Vibration.** Any source of sound if set in vibration and left to itself vibrates in its own natural frequency, producing a note which gradually dies away as the vibrations decrease, but remains constant in pitch. This type of vibration is called free vibration.

**Forced Vibration.** If a force which varies periodically is applied to a vibrating system, the system vibrates in the period of the force with an amplitude which is generally small. This is forced vibration.

The response of a vibrating system when subjected to a force timed to its own period is called **RESONANCE**. This resonance is the particular case of forced vibrations when the force and the system are in unison.

Musical instruments are examples of forced and free vibrations. In the piano, the string provides the forced vibrations to which the sound-board responds. In a loudspeaker, the cone assembly responds to forced vibrations, but free vibration occurs at the natural frequency of the cone (and to a smaller degree of the centring device). These are **RESONANCES**. Acoustic and Reflex Cabinets also act as vibrating systems, with free vibration or resonance at a natural frequency depending on the volume and length of air column.

In the case of the piano, the vibrating string must impose its frequency on the sound-board without the frequency of the string being in any way modified by the sound-board (A. Wood). In the same way, the forced vibrations of the loudspeaker must not be unduly affected by the free vibrations or resonance. It is equally important to subdue or control all vibrations, whether forced or free, arising in the cabinet system, which is in fact a continuation of the loudspeaker system used for coupling the sound waves to the room.

In a freely vibrating string, other modes of vibration occur in addition to the fundamental, the frequencies being 2, 3, 4 or more times the fundamental. These are known as second, third, etc. harmonics and are shown in Fig. 17.

The relative strength of the overtones decides the tone quality of the note, and maximum resonance is looked for in a musical instrument, which the loudspeaker is expected to reproduce as forced vibrations.



## RESONANCE AND VIBRATION

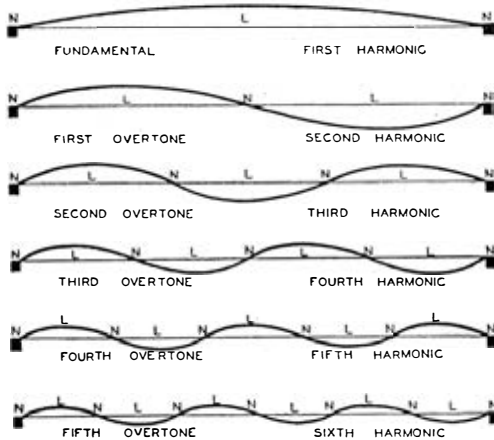

FIG. 17—Modes of vibration of a stretched string.

N.—The points of rest are termed nodes.

L.—The points of maximum amplitude are termed antinodes or loops.

*From Olson's Elements of Acoustical Engineering*

### BASS RESONANCE

Now the free vibration or bass resonance of a loudspeaker depends on the weight and suspension stiffness of the cone and centring device. Anything above 80 cycles is too high for reasonably good quality, and open baffle resonance below 30 cycles gives rather thin bass when accompanied by wide response in the treble, at domestic volume levels. On the other hand, when a 15-inch speaker with open baffle resonance about 25/30 c/s is given reflex loading of adequate cubic capacity and rigidity, the lower resonance appears at 25 to 18 cycles and the all-important upper resonance can be held down to below 55 c/s. This results in reproduction of speech free from colouration (assuming, of course, suitable high-frequency speaker with crossover network) and bass response in musical items which is deep and crisp.

### CABINET RESONANCE

We now come to the kind of resonance with which we are all familiar—generally described as cabinet resonance. The following remarks apply mainly to ordinary cabinets, as it is assumed that Reflex and Labyrinth types will have received special consideration.

There are three main types of Cabinet resonance—

- a. Vibration of the cabinet itself.
- b. Vibration of the air inside the cabinet.
- c. Vibration of the cabinet back.

Of these, the *b* type is the worst and is the most difficult to control.

**(a) VIBRATION OF CABINET**

Actual cabinet resonance may not be very prevalent at low volume, but is intensified as the volume level is increased. Bakelite of thin cross-section may give offence to the ear but is satisfactory if its cross-section is adequate for the size of the cabinet. Acoustically, there is a wide choice of material, provided it is thick enough. Wood, bakelite, steel, asbestos, clay, fibre, plaster, cement, bricks and mortar, even cardboard could be successfully employed. Naturally, the necessary thickness varies, and  $\frac{1}{8}$ " steel would be far better than  $\frac{1}{2}$ " cardboard. (See absorption coefficients of materials, Fig 30, in Chapter XVI.).

(I recently heard a large corner cabinet moulded in clay and fired. Fitted with two speakers and cross-over unit, the whole outfit weighed nearly 200 lbs., but results were very good). As a matter of fact, weight gives a good indication of the merit of cabinet material—the heavier the better.

**(b) AIR RESONANCE**

As this depends on the size and shape of the cabinet, it is not always easy to control without a major operation. The worst effects are generally due to the cabinet sides being too wide for the frontal area. Improvement may be effected by mounting the speaker further back in the cabinet, or by spacing the unit  $\frac{1}{2}$ " or more away from its baffle, thus relieving the air pressure around the edge of the cone. Lining a cabinet with felt absorbs middle and upper frequencies more than bass.

Placing thick wooden reflectors along two or three sides of the speaker, 6" or 8" in depth, may lower the cone resonance and subdue pressure points in the cabinet.

Wrapping the speaker unit in a cotton bag reduces the amplitude of the fundamental resonance. Probably the best cure for boomy reproduction is to connect another speaker in parallel. This cuts down the voltage at resonance, (see Fig. 22.) and if the extra speaker has good H.F. response and is correctly phased and placed immediately above the existing cabinet *in the same plane*, the improvement is phenomenal. An efficient 5/6" unit in small open back cabinet does well here.

**(c) CABINET BACKS**

If the cabinet or baffle is fitted with a cardboard back which vibrates, it is intensifying certain frequencies and causing distortion. It should be removed.

## CHAPTER XIII

# CABINETS AND BAFFLES

The cabinet or baffle should be looked upon as a means of coupling the vibrations of the cone to the air, rather than as a piece of furniture for housing or mounting the loudspeaker. Actually, the loudspeaker is a transducer which takes over energy from the set or amplifier in the form of A.C. current and terminates in the form of sound waves absorbed by the boundaries of the room. Unfortunately most of this energy is wasted in the form of heat, and the object of this chapter is to consider methods of avoiding this loss as much as possible ; in other words, to consider efficiency of coupling between loudspeaker and room.

Small baffles and cabinets are convenient in use, but are inefficient and introduce distortion. The following diagram from "Radio Engineering Handbook" gives an estimate of distortion at low frequencies from the ordinary open back console cabinet.

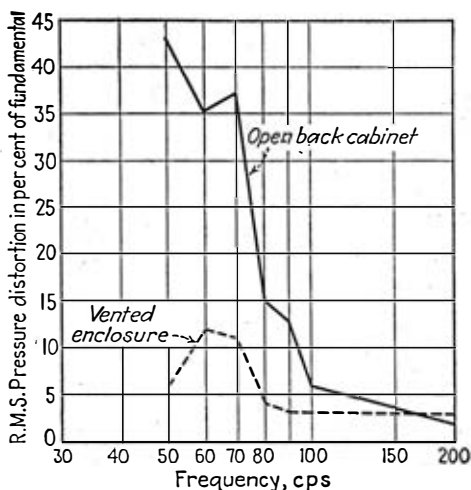

It should be understood that all references to open back Cabinets include such Cabinets fitted with perforated cardboard or plywood backs. Cabinet distortion is usually intensified by this type of back.

FIG.18. - Comparison between open back cabinet and vented enclosure of same size. (Henney)

Distortion occurs at and below cone resonance.

There is uneven response from the open back cabinet due to increased output in the region 100 to 500 cycles from pressure points, and severe loss of bass, according to size of cabinet, plus frequency doubling. Similar results occur with small baffles, especially when fitted with cardboard backs.

There are many ways of mounting a loudspeaker apart from the ordinary cabinet. The main systems are—

- a. Infinite baffle.
- b. Large open baffle.
- c. Large open back cabinet.
- d. Reflex cabinet.
- e. Acoustic labyrinth.
- f. Exponential horn.

Let us consider the merits and drawbacks of each system in turn.

### (a) INFINITE BAFFLE

Acoustically this appears to offer the nearest approach to perfection. A true infinite baffle is achieved by mounting the unit in the wall of the room, so that loading is approximately equal on each side of the cone. There is full bass radiation down to resonance of cone, there is an entire absence of cabinet and air column resonance and the radiation impedance seen by the cone is very good. Various methods of mounting are shown in Room Acoustics. (Chapter XVI, Fig. 29).

The efficiency in one room is not so good as a Reflex Cabinet and there may be inconvenience in the radiation which occurs from the back of the speaker. So-called infinite baffles consisting of a totally enclosed box should not be mistaken for a true infinite baffle. Such a box, unless of adequate size, imposes undue pressure on the cone which actually raises the resonant frequency and mars the reproduction of music. (An open free-edge cone would be an exception.)

The absence of resonance above the fundamental is shown in the following curve, Fig. 19/B, which represents two speakers

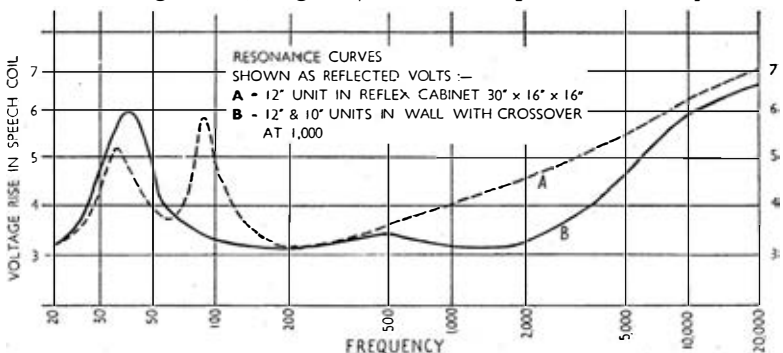

FIG. 19—Resonance Curves shown as reflected volts.

A. 12" Unit in Reflex Cabinet, 30" × 16" × 16".

B. 12" and 10" Units in Wall with Crossover at 1,000 cycles

mounted in the wall of a room with a cross-over at 1,000 cycles, compared with one 12" speaker in Reflex cabinet 30" × 16" × 16". Incidentally, reflected volts give quite a good picture of the degree of resonance including spurious vibration such as loose mesh, thin panels, etc.

Curve A shows the main resonances at 35 and 90 c/s, with minimum cone movement at the vent resonance at 60 cycles.

### (b) LARGE OPEN BAFFLE

If we accept the premise that the true infinite baffle is the best system, then it follows that the nearer we approach the arrangement the better the results will be. An open baffle therefore should be as big as possible, and the wavelength chart in Chapter IX, Fig 12 gives various sizes for various rates of cut-off. The diameter of a baffle should be at least half the wavelength of the lowest frequency required at full power. Below this size, efficiency falls off at the rate of 6 db. per octave. Thus a 5-ft baffle starts to cut off at 110 cycles and a 7½-ft. baffle at 75 cycles. All baffle resonance should be eliminated by using substantial material. Solid wood one inch thick, ¾" plywood, ⅜" asbestos, or any similar materials, are satisfactory. A corner position improves radiation resistance and angle seen by the cone. A large baffle gives very good results.

### (c) LARGE OPEN BACK CABINET

The conditions here are similar to a large baffle and should be as good, provided the sides are not deep in relation to frontal area, and the interior of the cabinet is not filled with equipment. Baffle area is increased by width of sides.

### (d) PHASE INVERSION OR REFLEX CABINET

This arrangement seems to offer the easiest solution to the problem of obtaining large scale results with reasonable dimensions. The loudspeaker is mounted in a cabinet having a volume of several cubic feet, which is provided with a vent or port in a convenient position which is not critical. At some low frequency, designed to be near the resonant frequency of the loudspeaker, the volume of air inside the cabinet resonates with the mass of air in the vent aperture, and when driven by the loudspeaker the system radiates considerable low frequency energy from the vent. Mounted in this way, the loudspeaker exhibits two resonances, one above and the other below the vent resonant frequency. In other words, the cabinet functions like a Helmholtz resonator which can be tuned, within limits, by varying the size of the vent. The frequency is lowered as the size of the opening is reduced. These conditions give rise to the characteristic double-humped impedance curve as shown in Fig. 19.

Reflex speaker systems tend to ring at these three resonant frequencies, and in order to avoid colouration some precautions are necessary in practice. The vent resonance, which is not subject to electrical damping by the driving amplifier, should be below 60 c/s to avoid the effects of ringing on programme. Large cabinets also help this problem, since they lead to lower Q factors at resonance, the peak being less sharp. The upper cone resonance which is subject to electrical damping should preferably be dealt with by using a driving amplifier having low output impedance. Failing this, its frequency should be kept as low as possible.

Wide variations in design are possible, but for a given type of loudspeaker there is a minimum size of cabinet and a best port area which will give level response down to the region of vent resonance. Results are affected by the operating position in the room, and the dimensions given in Fig. 20 are intended to show the order of things for some typical loudspeakers.

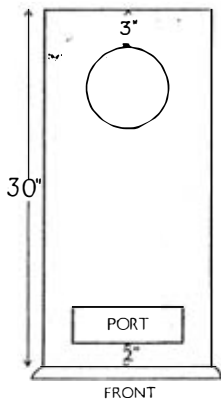

FIG. 20. — Reflex Cabinet

*Minimum dimensions for optimum results  
with units of stated cone resonance*

Unit	Cone Resonance c/s	Vent Resonance c/s	Cabinet Volume cu ft	Vent Area Sq ins	Suggested Vent dimensions
8"	60	60	3	38	8" x 5"
10"	50	50	4	33	8" x 4"
12"	40	40	5½	30	8" x 4"
15"	35	40	8	54	10" x 5"

Improved results are usually obtained by mounting a speaker in an enclosure which is larger than the specified minimum. For instance, an 8" unit gives excellent results in a brick-built corner structure of 9 cubic feet in volume. It is not satisfactory to load

## CABINETS AND BAFFLES

a speaker with a cabinet volume less than specified. A 12" unit in an enclosure of 3 cu. ft. could not be recommended.

As the cabinet is enlarged, the rigidity of the panels must be increased. It is a good plan to use two sheets of plywood spaced  $\frac{1}{2}$ " apart and filled with sand. Very good results are obtained by using loudspeakers with cloth suspension to the cone, as this improves the transient response.

The main characteristics of reflex cabinets may be summarised as follows:—

1. The extreme bass is augmented by the vent radiation which does not suffer from non-linear effects (see Fig. 21).

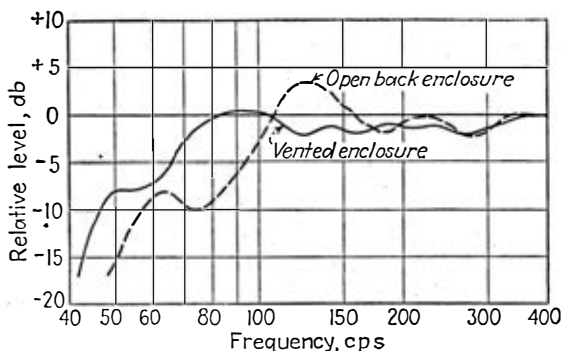

FIG. 21.—Total sound power radiated by cabinet for which distortion is shown in Fig. 18.

*From Henney's Radio Engineering Handbook*

2. The cone motion in this region is very much reduced, decreasing distortion and increasing power handling capacity.
3. The upper cone resonance should be well damped by the output stage, or kept low so as to avoid colouration.
4. The vent resonance is located at or near to the loudspeaker resonance so as to minimise cone excursions in this critical region.
5. The cabinet and vent sizes are chosen to hold the response level down to frequency of cut off.
6. The response falls sharply below the vent resonance.
7. The position of the vent relative to the loudspeaker is unimportant.

8. The cabinet may be tuned either by altering the vent area, or by varying the length of a short pipe leading into the cabinet.
9. The cabinet should be well lagged with felt or other damping material to reduce the effects of standing waves and absorb the energy from the rear of the cone at frequencies where cancellation effects would occur, provided the treble response is strong enough to stand up to this treatment. A layer of felt (D.E.L. Shorter, B.B.C.) removes some standing wave effects without undue damping the H.F. performance.
10. A unit having a good top response is necessary to balance the improved bass. Alternatively, a treble unit may be used with a crossover network, or simply in parallel.

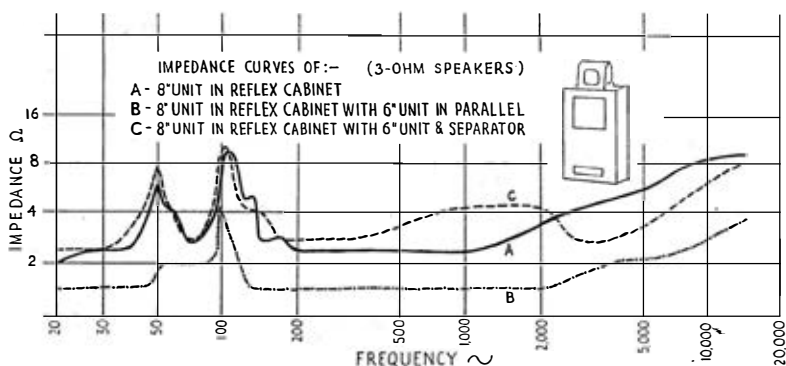

FIG. 22/1.

11. The vent resonance should be below 60 c/s to avoid colouration due to ringing.
12. Panel resonance can seriously mar the results, therefore cabinets must be rigidly constructed and airtight. Lining with a damping material such as Celotex is very helpful in this respect; sand-filled panels are still better.
13. A loudspeaker with open baffle resonance above 75 c/s is not considered suitable for reflex loading.
14. Equalising resonance is often very difficult under domestic conditions. The safest plan is to make the cabinet larger than the specified minimum.
15. The output at the bass end of the range is dependent upon position in the room and the impedance of the



## CABINETS AND BAFFLES

driving amplifier. A corner position gives the best low note radiation.

16. The importance of flux density in damping cone resonance should not be overlooked. Boomy effects from a reflex cabinet can often be subdued by fitting a loudspeaker with higher flux density. A magnet of 13,000 lines per sq. cm. on 1" centre pole completely damps the cone resonance in an 8" unit, with a given cone and coil assembly.
17. If reproduction is too deep or resonant, one of the following arrangements may be tried—
  - (a) Space the loudspeaker  $\frac{1}{8}$ " or  $\frac{1}{4}$ " away from cabinet front. Air resonance can be completely relieved. (See Fig. 22/2.)
  - (b) Connect an extra speaker, of different size and resonance, in parallel. This flattens the impedance curve and gives reproduction almost entirely free from resonance. (See Figs. 22/1 and 22/2.)
  - (c) Use extra speaker with separator. This preserves full bass response, with improved "top", free from intermodulation and cabinet distortion. (See Fig. 22/1)

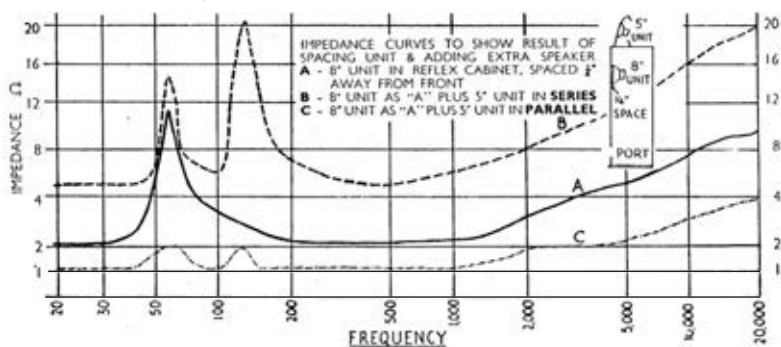

FIG. 22/2.

Note how series connection intensifies resonant peaks compared with parallel connection.

Inspection of the reflex resonance curve A in Fig. 19 shows that the voltage of the upper resonance at about 90 c/s is slightly higher than the resonance at 35 c/s. These two voltages could be equalised by more careful tuning of the vent. The best condition is usually considered to be the one where the two resonances are equal.

## SPECIAL NOTE—

Fifteen-inch speakers with  $8/9$  cubic feet of air loading and a port  $9'' \times 6''$ , can be designed to give resonances at 20 and 50 cycles. An extra speaker for top-note reproduction, with separator, is essential, but the combination gives very good results. Bass is strong and crisp, and speech is clear and free from resonance.

## (e) ACOUSTIC LABYRINTH

In the acoustic labyrinth the transmission line is a pipe, folded to conserve space, fed with energy at one end by the back of the loudspeaker cone, and open at the other. The pipe is arranged to be a quarter wavelength at some low frequency near to the resonant frequency of the loudspeaker in use. When operated around this frequency, the transmission delay along the pipe brings the energy radiated from the open end approximately in phase with the front radiation of the unit. The low frequency range of the system is therefore re-inforced, and since the loudspeaker is looking into a high impedance when the pipe is a quarter wavelength, cone excursions are much reduced, resulting in less non linear distortion, as in the reflex cabinet.

A loudspeaker with a resonance at 80 c/s would require a transmission line  $3\frac{1}{2}$  feet long. At 60 c/s the length would be  $4\frac{1}{2}$  ft. At frequencies below the quarter wavelength mode, the port and diaphragm radiation are out of phase and the response falls off steeply. The same effect would take place at higher frequencies, and so it is necessary to line the pipe with absorbent material to destroy the back radiation of these frequencies. Unfortunately, this is difficult to do because the sound waves only skim the damping lining, instead of impinging directly on it. Consequently the labyrinth system tends to show irregular response characteristics at middle frequencies. This feature, combined with the difficulty and high cost of construction has been largely responsible for its lack of popularity.

The above is what might be termed the classical explanation of the acoustic labyrinth. Unfortunately, it is based on the assumption that the resonance of a given loudspeaker occurs always at a certain frequency, which is not the case. It is possible to alter the frequency

## CABINETS AND BAFFLES

of cone resonance from 85 c/s to 70 c/s simply by increasing the amount of feedback in an amplifier and thus lowering the output impedance. When a loudspeaker is mounted in an acoustic labyrinth and the cone looks into a high impedance through the pipe, it upsets all our calculations by altering its resonant frequency. Matching the resonance to the pipe length is therefore like chasing a will o' the wisp.

In a normal listening test, the very heavy damping which is necessary—usually thick felt—results in a comparative lack of brilliance in the reproduction, or what could be described as a 'heavy tone', but this can be counter-balanced to good effect by adding a treble speaker with a dividing network.

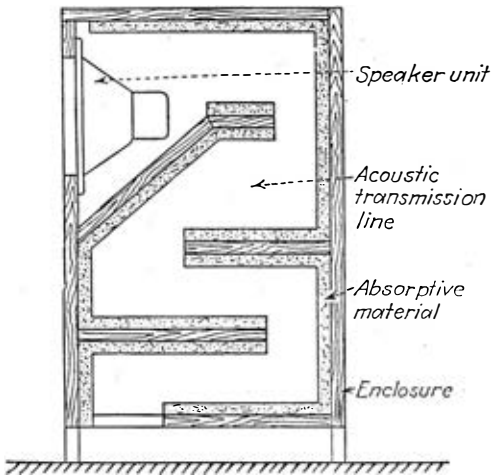

FIG. 23.—Labyrinth type of transmission-line speaker.

*From Henney's Radio Engineering Handbook*

## CONE RESONANCE

Before leaving the question of cabinet loading it is worth while to point out that the frequency of cone resonance is lowered by certain forms of loading and raised by others. Quite a similar effect may be produced in a resonant panel in a reflex cabinet, where the addition of a cross bar may lower the frequency of the resonance without actually reducing its intensity. It follows, therefore, that it is hardly possible to remove cone resonance by matching to a high acoustic impedance in reflex or labyrinth designs; you can only push it around. Fortunately, high damping factors from amplifier output and powerful magnets **are** effective in reducing fundamental speaker resonances.

(f) EXPONENTIAL HORNS

The calculations involved in correct horn loading are far beyond the scope of this little book, and very bad results may be had by hit and miss methods. The subject is exhaustively examined in Olson's *Elements of Acoustical Engineering* (Chapman & Hall), from which the following interesting double-horn arrangement is taken

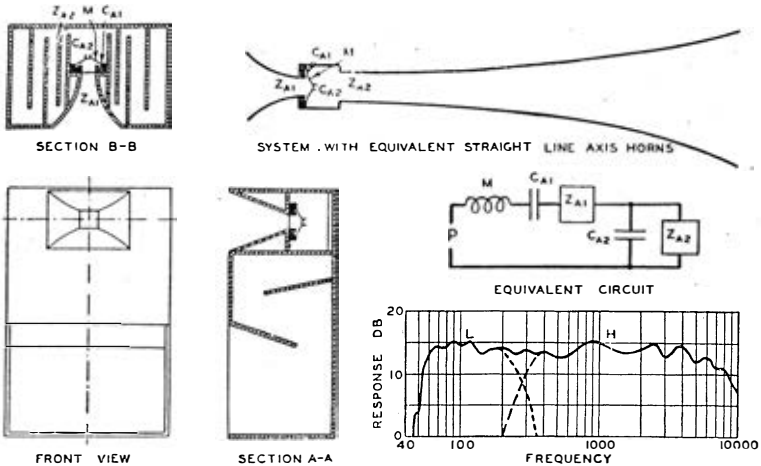

FIG. 24.—Compound Horn Loudspeaker.

From Olson's *Elements of Acoustical Engineering*

An arrangement on the above lines offers interesting possibilities. A combination of small horn for treble and acoustic labyrinth for bass would also be promising, and would be a much simpler proposition.

The efficiency of a horn is limited to a certain frequency range, depending on its shape, length and diameter. A large exponential horn is necessary for low notes, and a short flare for high notes. Each type can be designed to cover 3 to 4 octaves reasonably well, and it is usual to arrange a cross-over at 300 or 400 cycles in order to cope with 8 octaves from 40 to 10,000 cycles.

A flare, 12" long with a mouth 12" in diameter will have directional properties as good as a 3" speaker at high frequencies, but multicellular horns (Fig. 26 and 27) are often used to cover a very wide angle.

For outdoor work and large buildings, where big volume is required, the efficiency of exponential horns results in important economies in amplifier requirements.

## CHAPTER XIV

### EXTENSION SPEAKERS AND VOLUME CONTROLS

These are in such common use that there is no necessity to explain in detail how they work. The simplest way to run an extension speaker is at low impedance, i.e. from secondary of existing output transformer, and practically all new sets are now fitted with speaker points within the  $1\frac{1}{2}$  to 5 ohm range. It was always impossible to understand why some set makers provided high impedance extension points, thus forcing the user of an extension speaker to waste money on another transformer, to lose some of his precious top response in the flex and additional transformer, and to receive an electric shock if he touched the extension leads, especially during a loud passage of music. The voltage across the primary of the output transformer of an average domestic radio set may be 300 volts D.C. plus speech voltage of 250 A.C. Although not generally lethal, such voltages need not be brought out of a set and circulated around the house to a loudspeaker with bare terminals.

The only possible objection to low impedance runs is loss of power, and this hardly arises under domestic conditions. The average distance between set and extension speaker will be about 30 ft. Using ordinary 14/36 flex, the total resistance for 60 ft. is 0.75 ohm approximately. With a 3 ohm speaker this means that one-third of the power is wasted. Such a drop in volume is barely audible. For longer runs it is advisable to use heavier wire, such as—

23/36	=	23/.0076	Resistance	0.80	ohms	per	100	ft.
20s	=	1/.036	"	0.75	"	"	"	"
18s	=	1/.048	"	0.45	"	"	"	"

A distance of 50 ft. means the resistance of 100 ft. (there and back).

In spite of the rude things which are often said about small sets and speakers, there are plenty of occasions when they are preferable to large ones, such as for kitchen or bedside use. If a kitchen loudspeaker is exposed to steam or vapour it will deteriorate, and it is advisable to wrap the entire cabinet in cellophane. This will keep out the steam without spoiling the appearance of the cabinet, and without undue loss of volume.

The main objection to bedroom extension speakers is the problem of switching the set on and off. A simple remote control which is not often used, is to have fitted the type of two-way switch commonly used for controlling hall and landing lights. Any electrician could

run some neat P.V.C. coloured flex to the bedroom switch, and the set could be switched on or off either upstairs or downstairs, without recourse to expensive relay installations.

Many sets are capable of giving better reproduction than is obtained from the speaker mounted in the cabinet, surrounded by wireless components. Special baffles or acoustic cabinets may well be justified. But it is very important to remember that high-fidelity speakers ruthlessly expose any distortion or hum, and may give worse audible results instead of better. If the set speaker has been selected to silence valve hiss, to peak at 4,000 cycles, and to be deaf to mains hum at 50/100 cycles, woe betide your hi-fi efforts!

### VOLUME CONTROLS

There are four main systems of loudspeaker volume control—

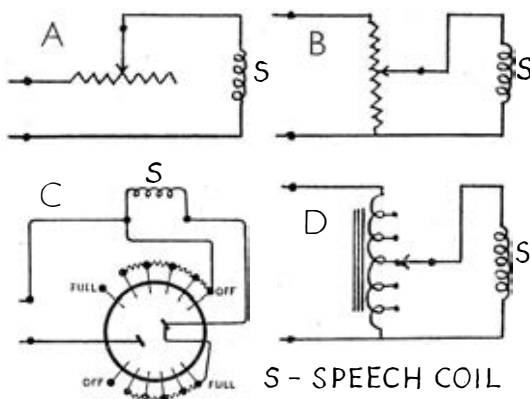

FIG. 25.—Loudspeaker Volume Controls.

- |                         |                   |
|-------------------------|-------------------|
| A. Variable Resistance. | B. Potentiometer. |
| C. Constant Impedance.  | D. Tapped Choke   |

As the impedance of the loudspeaker varies with frequency (see Chapter VII, Fig. 6) its performance may be seriously affected by the volume control; in some cases the quality is ruined, but in others it may even be improved. Results will be disastrous if the volume control is expected to do an unreasonable amount of work, as it is always advisable to control volume as near the source as possible. It is impossible to reduce 5 watts to one-tenth of a watt in a loudspeaker circuit without distortion.

## EXTENSION SPEAKERS AND VOLUME CONTROLS

The variable resistance method A is not used today as it tends to emphasise the bass resonance, and reduce the middle frequencies more than the top. It is also necessary to have a high value of resistance to give effective control. As the resistance is in series with the speech coil, it has a greater effect on the level parts of the impedance curve than it has on the peaks, hence the deterioration in quality.

**Method B.**—The potentiometer is a distinct improvement on Method A, provided the resistance value is kept low. As the potentiometer is permanently connected across the line, the resistance must nevertheless be made high enough to avoid undue loss of power. A value of about 3 times the average impedance of the speaker offers a reasonable compromise, and furnishes a continuously variable control which is quite satisfactory on the average extension speaker.

**Method C.**—Constant Impedance Control. This constitutes a further advance on Method B. The resistances are arranged in series and in parallel with the speech coil so that the total load across the line is the same at any setting of the control, and at full volume no resistance is in circuit at all. The control has the effect of leveling the impedance curve and is well worth consideration for reducing bass resonance, particularly on speech in Reflex Cabinets. This type of control is worked in steps and has not the advantage of being continuously variable.

**Method D.**—Tapped choke or auto transformer. Unlike the three previous types, this control has practically no effect on the frequency response, and may be used with loudspeaker cross-over networks without upsetting the performance. It is obviously much more expensive and bulky. The impedance rises as the volume is reduced, and it should not be used with a high impedance source such as a pentode without negative feed back.

## CHAPTER XV

### CINEMA SPEAKERS

The quality of reproduction in cinemas is now so good that it is sometimes possible to see and hear a film without being aware of the fact that loudspeakers are in use. Examples of current cinema practice may, therefore, be of interest.

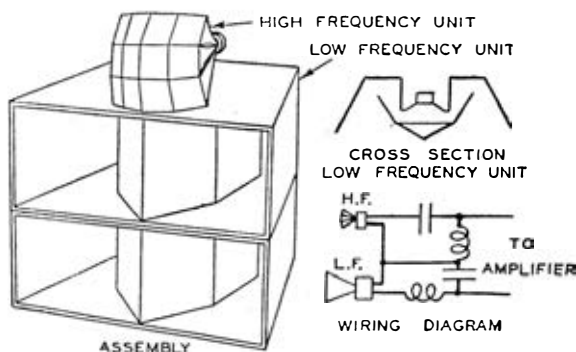

FIG. 26.—A two-channel theatre loudspeaker system consisting of a folded low frequency horn unit and a multicellular horn high frequency unit.

*From Olson's Elements of Acoustical Engineering—*

“This loudspeaker consists of a low frequency folded horn unit for reproduction from 40 to 300 cycles and a multicellular horn unit for reproduction from 300 to 8,000 cycles. In order to minimize time delay and phase distortion due to a large path length difference between the low and high frequency horns, the effective length of the horns must be practically the same. The difference in path length is made relatively small by employing a short folded horn for bass, coupled to a large diameter speaker unit.

The high frequency horn consists of a cluster of relatively small horns coupled to a common throat. The throat is coupled to one or more speaker units depending upon the power requirements. The dividing network introduces phase shift as well as a loss in power of 2 or more db.”



## CINEMA SPEAKERS

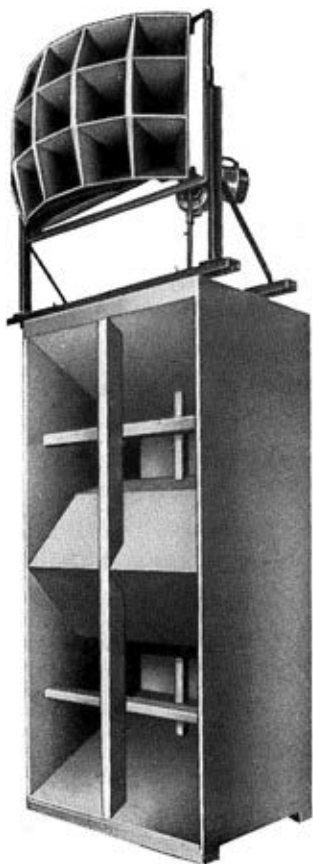

FIG. 27.—R.C.A. Cinema Unit  
for theatres seating 1,500 upwards.  
Total height 10 feet.  
Total weight  $\frac{1}{4}$  ton.

*Photo by courtesy of  
R.C.A. Photophone, Ltd.*

The low frequency unit consists of a folded horn to which two 15-inch speakers are coupled. The high frequency unit is a multi-cellular horn coupled to two high frequency loudspeaker units, mounted in such a way that it can be "angled" properly. A dividing network with a cross-over frequency of about 400 cycles is usually adopted.

For smaller theatres, a similar system, using one speaker for low and one for high frequencies is used, with a power handling capacity of 20 or more watts.

It will be noted that in all these cinema systems the high frequency source is placed immediately above the low frequency unit, and the latter covers a large area. The best position behind the screen is always chosen for the installation.

## CHAPTER XVI

### ROOM ACOUSTICS

Most people realise that the listening room has a good deal of effect on the reproduction of speech and music. The size and shape and furnishings all play their part. Carpets and curtains absorb the higher frequencies. A set or speaker which sounds bright and clear in the shop may sound muffled and resonant at home, and it is advisable to select a bright tone when choosing in a showroom with little or no soft furnishings about, where the reverberation period may well be twice as long as in a furnished room.

Placing a loudspeaker in the corner of a room improves the radiation impedance seen by the cone, and also increases the low note radiation by use of the walls and floor as reflecting planes. In fact, a corner is so obviously the best position that it is surprising it is so rarely utilised. Fig. 28 shows the various equivalent reflecting planes and their effect. One speaker at B radiates as much low frequency energy as two at location A, and one at E equals two at D, or four at C.

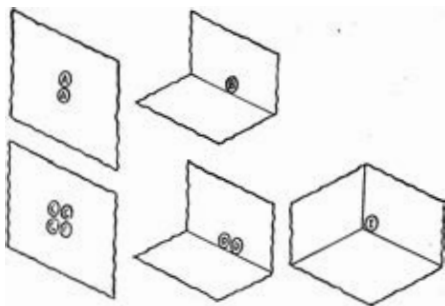

FIG. 28.

*From Henney's Radio Engineering Handbook*

It will be understood that merely placing a speaker in a corner will not have the full effect of actually mounting the speaker in a wall, as shown at positions B, D and E.

This question of radiation impedance accounts for the fact that even a little speaker sounds better in a large room than in a small one. It also explains why a larger room does not require an increase of power in proportion to the increase of size. The loudspeaker supplies maximum energy to the room when the room impedance is high, or when the speaker is near a pressure maximum<sup>(1)</sup>. No resonance pressure maximum occurs at the speaker below the lowest resonant frequency of the room, and good low note response is therefore hard to obtain in small rooms.

(1) *Radio Engineering Handbook*, p. 921.

## ROOM ACOUSTICS

The reproduction of a pure tone requires a room at least half as long as the wavelength of the note. Thus bottom C at 32 cycles (wavelength 35 ft.) would require  $17\frac{1}{2}$  ft. minimum. It is also noticed that the fundamental speaker resonance is less marked when highly damped by looking into a high acoustical impedance; in other words, bass resonance is more pronounced in a small room than a large one, or when the speaker is wrongly placed in any medium-sized room. Corner positions also permit improved high note response because of the smaller solid angle the radiation has to cover, say 90 degrees instead of 180 degrees. It is also obvious that when a corner or end position is used, everybody in the room is normally in front of the speaker.

Acoustically the best position for a loudspeaker is mounted in a wall, looking into the longest length of the room, preferably from one corner. Although structural and domestic considerations generally rule it out, the arrangement is worth consideration, and various methods of mounting are illustrated in Fig. 29, with details of results actually experienced. (It is much easier to read about these tests than to make them!)

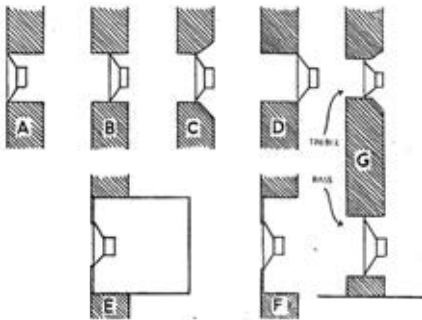

FIG. 29.—Various ways of mounting loud speakers in a party wall, with lounge in front and dining-room behind.

Results of actual tests made with a view to reproduction in two rooms (E excepted). In every case, high note radiation in front of the loudspeaker is better than behind, where the magnet acts as an obstruction to HF

- a. Unsatisfactory because air pocket is formed at the back of the speaker. This method could be used with a wall not more than about 3" thick.
- b. Good results in front, poor HF at back.
- c. Satisfactory both sides.
- d. Unsatisfactory because air pocket is formed in front of the speaker.

- e. Unit placed in box—not recommended—wall baffle largely wasted.
- f. Sub-baffle should be very small and heavy, otherwise benefits of wall are dissipated.
- g. Two speakers with cross-over. Bass unit near floor for improved LF radiation. HF unit about 3 ft. higher (say 4 ft. from floor) for natural effect in speech and solos.

It is difficult to arrange a speaker for best results on speech and music, as the former requires a single source effect, but music

*Absorption Coefficients of Various Materials*

Material.	Frequencies in cycles/sec.		
	250.	500.	1,000-2,000.
Ordinary wall and ceiling surfaces:			
Lime plaster . . . . .	0.02-0.03	0.03-0.04	0.03
Hard plaster . . . . .	0.01-0.02	0.01-0.02	0.02-0.03
Unpainted brick . . . . .	0.03	0.03	0.05
Wood-panelling, 3-ply . . . . .	0.01-0.02	0.01-0.02	0.01-0.02
Curtains:			
Cretonne . . . . .	—	0.15	—
Medium weight . . . . .	—	0.2-0.4	—
Heavy, in folds . . . . .	—	0.5-1.0	—
Floor coverings:			
Wood block in mastic . . . . .	0.03	0.06	0.10
Cork carpet, $\frac{1}{4}$ in. thick . . . . .	0.03	0.07	0.20
Porous rubber sheet, $\frac{1}{2}$ in. thick . . . . .	0.05	0.05	0.20
Axminster carpet, $\frac{1}{4}$ in. thick . . . . .	0.05	0.10	0.35
"    "    on $\frac{1}{4}$ -in. felt underlay. . . . .	0.05	0.40	0.65
"    "    on $\frac{1}{4}$ -in. rubber " . . . . .	0.05	0.20	0.45
Turkey carpet, $\frac{1}{2}$ in. thick . . . . .	0.10	0.25	0.30
"    "    on $\frac{1}{2}$ -in. felt underlay . . . . .	0.30	0.50	0.65
Special absorbers:			
Acoustic plasters ( $\frac{1}{2}$ to 1 in. thick) on stone . . . . .	0.15	0.25	0.30
Fibre boards, plain, $\frac{1}{2}$ in. thick, on battens . . . . .	0.30-0.40	0.30-0.35	0.25-0.35
Medium efficiency tiles, on battens . . . . .	0.40	0.40	0.50
High-efficiency tiles, with perforated surfaces, on battens . . . . .	0.50	0.80	0.85
Acoustic felts, 1 in. thick, perforated covers on hard surface . . . . .	0.30	0.70	0.80
Acoustic felts, $\frac{1}{2}$ in. thick, on battens . . . . .	0.25	0.45	0.70
Wood wool-cement board, 1 in. thick, on battens . . . . .	0.30	0.60	0.70
Sprayed asbestos, 1 in. thick . . . . .	0.50-0.60	0.65-0.75	0.60-0.75
Slag wool or glass silk about 2 in. thick, on battens . . . . .	0.70	0.85	0.90
Cabot quilt, 3-ply, two layers . . . . .	0.40	0.70	0.70
Individual objects in open-window units (ft.):			
Audience per person . . . . .	4.3	4.7	5.0
Chairs, bent ash . . . . .	0.16	0.17	0.21
Cushions, hair, 2 $\frac{3}{4}$ sq. ft. under canvas and plush . . . . .	1.1	1.8	1.5

FIG. 30.

*From Wood's Physics of Music*

## ROOM ACOUSTICS

should come from a wider source, especially in the bass. Practically all instruments with good low note output have a wide diffusion—the organ, piano, double bass, drums, etc.—and however good the loudspeaker it is never quite natural to hear a 75 piece orchestra bursting out of a 10" or 12" circle.

It is therefore suggested that the best compromise is to have two units, preferably in a corner position, with the bass well diffused near the floor, and the treble speaker immediately above. If only one speaker is used, some form of reflex or acoustic loading (see Chapter XIII) is a distinct help in diffusion effects.

The reverberation period of a room depends upon its size and the absorption coefficients of its walls and contents. The Fig. 30 list may be of interest for comparing different materials and rooms, and will be useful to those considering the construction of special cabinets.

A large room or hall may often require stronger "top" response than a small room for natural results. If you find that some forms of reproduction are too bright or shrill in a small room it is worth while to try the effect of an acoustic filter, by draping a piece of cloth across the front of the offending speaker. If material with an open weave be used, the HF attenuation will be small, but it can be intensified by using two or more layers. This form of high frequency control is often more subtle than the usual tone control.

## CHAPTER XVII

### TRANSIENTS

There is a good deal of difference in loudspeakers in what is generally known as transient response. I want to use the term in its widest sense, to embrace attack as well as decay of sound. High flux density and stiff connection between speech coil and cone give good top note response and improved transients. Solid cabinets or baffles are also essential. Hard materials such as fired clay, and heavy steel or asbestos sheets which have a naturally high pitch or period are very good, and often improve transient response in comparison with wood.

The output impedance of the amplifier also affects the transient response of a loudspeaker. Fig. 31 shows at A the effect of a very high impedance such as Pentode or class "B" operation, at B a generator corresponding to class "A" operation, and at C very low impedance corresponding to negative feed back.

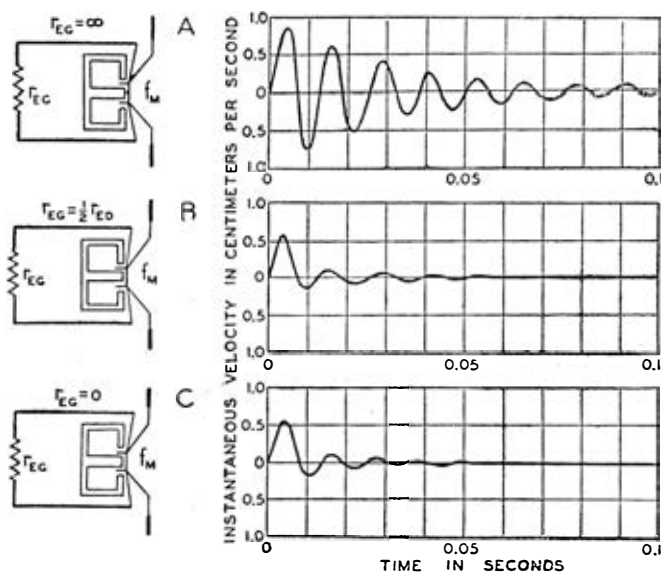

FIG. 31.—The transient response of a 12-inch loudspeaker to a unit force.  
A. Generator of very high resistance.  
B. Generator having a resistance of half the loudspeaker impedance.  
C. Generator of zero impedance.

*From Olson's Elements of Acoustical Engineering*

TRANSIENTS

The cone material and surround affect the transient response probably more than any other item. Hard, loud cones with apparent high note efficiency due to resonances, have very bad transient response. On the other hand, felted or linen cones with smoother response curve and lower acoustic output have much superior transient characteristics. In the same way, soft surrounds improve the transient response by adding dissipation to the edge of the cone with reduced reflection of the flexural wave. It is, of course, fairly obvious that as the cone is expected to respond to the vibrations which are forced upon it, any inherent resonances in the cone are undesirable and are bound to upset the transient position by reverberation. This phenomenon has been thoroughly investigated by the Research Dept. of the B.B.C. and a short description of the method is given under Distortion in Chapter I. It is confirmed that a speaker with peaky decay characteristics is untidy in a normal listening test.

If you take three identical driving systems of any size and fit (A) loud cone with corrugated surround ; (B) quiet non-resonant cone with corrugated surround ; (C) quiet cone with soft surround, you will find that switching from A to B and from B to C progressively reduces volume and improves quality. This happens every time with any size of speaker from 3½" up to 15" and simply confirms

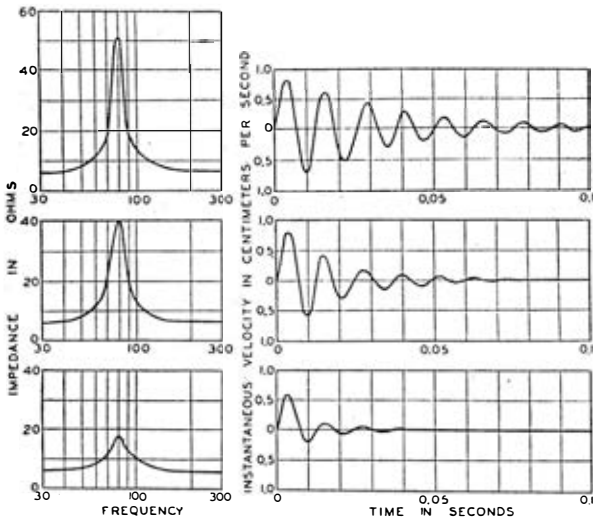

FIG. 32.—The unit force response of a loudspeaker coupled to a generator of very high resistance for different values of internal mechanical resistance—indicated by impedance curve.

*From Olson's Elements of Acoustical Engineering*

expectations. If you now take three of the small units and use them as microphones you will find similar improvements in quality but even more pronounced. Incidentally, the best speaker tests for these transient qualities are speech and full orchestra.

The effect of the bass resonance on transient response is clearly shown in Fig. 32.

It will be seen that a reduction of bass resonance or increase of mechanical resistance, as exemplified in a flatter impedance curve, improves the transient or decay element. It follows that improvements such as lowering the resonance frequency, or improving the air-loading by reflex or other methods, also help the transient position. With small cabinets or baffles the response to transients is usually very poor because the internal mechanical resistance is not sufficiently large.

The following diagram shows the transient effect of a narrow pulse (1 milli-second) at 50 pulses per second, in various loudspeakers. It will be seen that the pulse suffered slight distortion in passing through the amplifier. It is interesting to note that the following factors help to improve the transient response:—

1. High flux density.
2. Cloth surround to the cone, which reduces reflected resonance.
3. Absence of mechanical compliance in cone and coil assembly.
4. Heavy cone, which always reduces distortion when compared with a light cone.

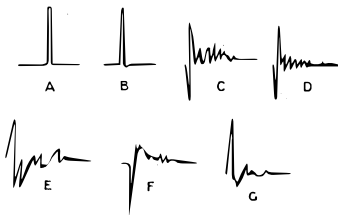

Fig. 32/1.

Pulse effect to show transient response of various loudspeakers

- a. Input pulse to amplifier.
- b. Output pulse from amplifier.
- c. Output from 8" speaker 8,000 lines, corrugated cone.
- d. Output from 8" speaker 13,000 lines, cloth surround.
- e. Output from 10" speaker 11,000 lines, with jointed cone.
- f. Output from 10" speaker 14,000 lines, heavy cone with cloth surround.
- g. Output from 15" speaker, 13,500 lines, heavy cone with cloth surround.



## CHAPTER XVIII

### CROSSOVER NETWORKS

In order to widen the frequency range, and reduce intermodulation distortion between bass and treble, two loudspeakers may be used with a dividing network. The arrangement also facilitates the correct location of the speakers in the room, with the desirable combination of direction and diffusion. The obvious and simple plan of placing the treble unit immediately above the low note radiator as done in cinema installations is hard to beat. It is also possible to enjoy the full and distortionless bass of an acoustic chamber by adding an extra speaker in open back cabinet for high note radiation. Although the extra speaker may improve results if simply connected in parallel, the use of a separator or dividing network gives two important advantages : (a) full bass output is retained and (b) by keeping the low notes out of the top speaker, distortion due to the size of cabinet, cone resonance and inter-modulation is eliminated.

For domestic use, a crossover at 1,000 cycles is satisfactory. It is difficult to improve on the following two circuits for efficiency and economy. FIG. 33A shows a half section parallel constant resistance filter giving attenuation at 12db. per octave with an insertion loss of about 2 db. FIG. 33B shows a quarter section series network, giving 6 to 8 db. attenuation per octave with an insertion loss of about 1 db. So far as quality of reproduction is concerned, there is little to choose between them. Component values for speakers of 3,  $7\frac{1}{2}$  and 15 ohms impedance are given.

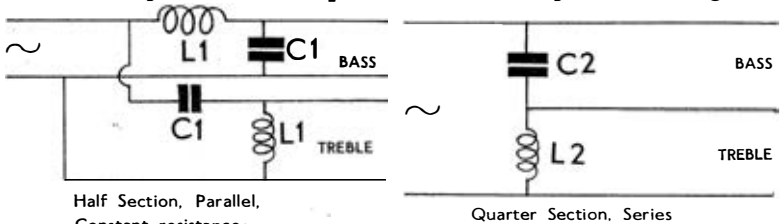

Half Section, Parallel,  
Constant resistance.

Quarter Section, Series

A				FIG. 33	B			
1,000 c/s.					1,000 c/s.			
	3	$7\frac{1}{2}$	15 ohms		3	$7\frac{1}{2}$	15 ohms	
C1	35	14	7 Mfd.	C2	60	24	12 Mfd.	
L1	0.68	1.70	3.38 m.H.	L2	0.5	1.25	2.5 m.H.	

Considerable latitude in circuit values is permissible, as a perfect crossover at a fixed frequency is not required. There is a phase shift of  $90^\circ$  in a quarter section filter and  $180^\circ$  in a half section network. In order to maintain full output at the crossover frequency, the treble speaker should be placed a quarter wave length behind the

bass speaker when a quarter section crossover is used. This means pushing the treble speaker about  $4\frac{1}{2}$  inches back with crossover at 1,000 c/s. With a half section system the treble speaker should be in phase with the bass speaker to avoid a severe dip at the crossover frequency. This is easily achieved by reversing the leads to one speaker and listening to the effect.

When circuit values are reasonably accurate, the impedance of two speakers remains about the same as a single speaker, as shown in the following diagram.

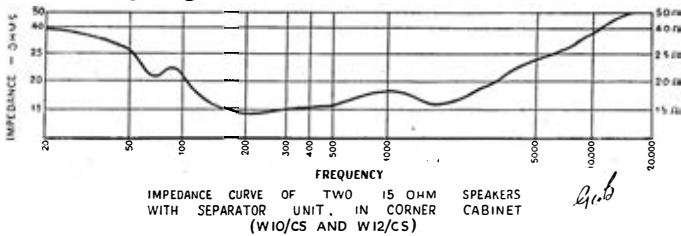

FIG. 34.—The improvement in performance resulting from this type of network is partly due to the improved level of impedance.

It is usual to use two speakers of similar impedance, but H.F. performance may be improved by adopting a lower impedance in the treble unit, thus overcoming the steep rise of impedance with frequency which has afflicted the moving coil speaker since birth.

It is important that the two loudspeakers should be of equal sensitivity. A real difference in flux density results in a loss of naturalness and balance due mainly to difference in attack and transient response.

A large bass unit is always an advantage. The treble speaker could be 10", 8" or 5"; or a three-speaker system could comprise 15", 10" and 5" units.

Resistance type volume controls tend to upset the response if placed between the amplifier and the crossover network; tapped chokes are better here, provided the amplifier has a low output impedance. Variable resistance controls, say 25 or 50 ohms potentiometers, make satisfactory level controls when used across individual speakers.

Air cored coils are generally advocated, but iron cores provide low resistance windings which may be worth while in cases where insertion loss must be kept as low as possible. Electrolytic condensers should not be used.

As regards crossover frequency, the component values are in inverse proportion to the frequency. Therefore, to cross over at 500 cycles instead of 1000 multiply all C & L values by 2. To cross over at 2,000 cycles instead of 1,000, divide all C & L values by 2.

## CHAPTER XIX

### NEGATIVE FEEDBACK

Most high quality amplifiers are now fitted with a certain amount of negative feedback in order to even out the response and reduce harmonic distortion. The system is most necessary where high impedance output valves such as pentodes and tetrodes are employed, as it reduces the output impedance and simplifies the problem of matching, as well as improving the transient response of the loudspeaker (see Chapter XVII). There is also a reduction in loudspeaker resonance, as shown in chapter XVII, Fig. 31/2.

There is always a danger of instability in an amplifier with negative feedback if the leakage inductance of the output transformer is not very low. The use of two speakers with a crossover network could expose such instability but would not cause it. If the amplifier is correctly designed and assembled, with a suitable output transformer, there is no danger of instability with a two- or three-speaker system and crossover network. In some cases, reversing the leads to the bass loudspeaker will avoid an outburst of motor-boating; or the insertion of a small resistor of a few ohms value in series with the voice coil could be tried as a palliative. Oscillation in an amplifier at very high frequencies would not be affected by these arrangements.

In view of the increasing use of negative feedback in high quality amplifiers, it is worth noting that the constant resistance type of crossover network is less prone than the filter type to start fun and games in the amplifier from instability. The half section constant resistance circuit with two elements in the bass and two elements in the treble portions, is also safer than the quarter section type.

For this reason amplifier makers often advise the use of the constant resistance half-section network; but a really stable amplifier is not upset by variations in the loudspeaker circuit. The obvious cure for instability from NFB in an amplifier is to reduce the amount of feedback.

A striking example of the benefit of negative feedback in overcoming problems of load matching is to be seen in the high quality school equipment specially designed for Essex Education Committee. The 15 watt amplifier is coupled to a line transformer of low leakage inductance, which feeds the speaker lines at 300 ohms. Each of the 8 loudspeakers is fitted with a transformer so that the line load is matched when five speakers are in use. No provision is made for adjusting the transformer ratios when the number of speakers in use is varied. When only one speaker is in use the load is 1,500 ohms instead of 300 ohms, but the provision of negative feedback obliterates any trace of distortion from mis-matching.

## CHAPTER XX

# TRANSFORMERS AND MATCHING

The purpose of the Output Transformer is to match the low impedance of the loudspeaker to the high impedance of the output valve(s). An extra winding is often included for negative feedback, so that voltage is deliberately returned to the input stage out of phase with the incoming signals and so cancels out much of the distortion introduced in the equipment.

A glance at any typical impedance curve will show that the impedance of the loudspeaker varies at different frequencies, so that perfect matching is not possible. It is usual to work on the middle frequency range and accept the impedance at 400, 600, 800 or 1,000 cycles, according to taste. The impedance is always higher than the D.C. resistance of the speech coil, and it is satisfactory to assume a difference of 30% or 50%.

The higher the output impedance, the more important the matching becomes. Thus pentodes and tetrodes are more critical than triodes. Even so, quite wide variations may occur. When an extension speaker is connected to a set, this is what happens, according to Mr. Beaumont (our technical sub-editor) "The valve load may be almost halved, and the resulting mis-match may give an increase in power output (within limits) at the expense of harmonic distortion in the case of tetrode or pentode valves without feedback."

With the usual small extension speaker, results are satisfactory, but if a wide-range speaker is used any distortion is noticeable. If the output valve load is 7,000 ohms and the speakers are 3 ohms each, halving the load is equivalent to altering the transformer ratio from 48/1 to about 35/1.

Negative feedback reduces the output impedance and is doubly useful where an extension speaker is used, since it reduces the resulting rise in distortion. In fact, with really low impedance sources the question of matching becomes of secondary importance, and one  $7\frac{1}{2}$  ohm secondary can be used for 3 ohm or 15 ohm speakers. In fact, if the transformer winding is tapped for 3 ohm load, the quality of reproduction may be improved by using a 3 ohm speaker on the full  $7\frac{1}{2}$  ohm winding where the leakage inductance would be lower. The foregoing should not be construed to mean that load matching does not matter. Obviously, the most suitable transformer ratio will be adopted, with flexibility according to circumstances.

# TRANSFORMERS AND MATCHING

## RATIO-IMPEDANCE TABLE

Transformer Ratio	Ratio Squared	SPEECH-COIL IMPEDANCE — OHMS									Transformer Ratio
		2	3	4	6	8	10	12	15		
10/1	100	200	300	400	600	800	1,000	1,200	1,500	10/1	
15/1	225	450	675	900	1,350	1,800	2,250	2,700	3,400	15/1	
18/1	324	650	975	1,300	1,950	2,600	3,250	3,900	4,900	18/1	
20/1	400	800	1,200	1,600	2,400	3,200	4,000	4,800	6,000	20/1	
22/1	484	970	1,450	1,950	2,900	3,900	4,800	5,800	7,250	22/1	
25/1	625	1,250	1,875	2,500	3,750	5,000	6,250	7,500	9,400	25/1	
28/1	784	1,570	2,350	3,140	4,710	6,280	7,850	9,400	11,800	28/1	
30/1	900	1,800	2,700	3,600	5,400	7,200	9,000	10,800	13,500	30/1	
32/1	1,024	2,050	3,070	4,100	6,150	8,200	10,250	12,300	15,400	32/1	
35/1	1,225	2,450	3,675	4,900	7,350	9,800	12,250	14,700	18,400	35/1	
38/1	1,444	2,900	4,350	5,800	8,675	11,600	14,450	17,350	21,600	38/1	
40/1	1,600	3,200	4,800	6,400	9,600	12,800	16,000	19,200	24,000	40/1	
42/1	1,764	3,530	5,300	7,000	10,500	14,000	17,500	21,000	26,500	42/1	
45/1	2,025	4,050	6,100	8,100	12,100	16,200	20,250	24,400	30,400	45/1	
48/1	2,304	4,600	6,900	9,200	13,800	18,400	23,000	27,600	★	48/1	
50/1	2,500	5,000	7,500	10,000	15,000	20,000	25,000	30,000	★	50/1	
52/1	2,704	5,400	8,100	10,800	16,200	21,600	27,000	32,400	★	52/1	
55/1	3,025	6,050	9,075	12,000	18,150	24,000	30,000	★	★	55/1	
58/1	3,364	6,730	10,000	13,500	20,000	27,000	33,600	★	★	58/1	
60/1	3,600	7,200	10,800	14,400	21,600	28,800	★	★	★	60/1	
62/1	3,844	7,700	11,500	15,400	23,000	30,800	★	★	★	62/1	
65/1	4,225	8,450	12,700	17,000	25,400	34,000	★	★	★	65/1	
68/1	4,624	9,250	13,900	18,500	27,800	★	★	★	★	68/1	
70/1	4,900	9,800	14,700	19,600	29,400	★	★	★	★	70/1	
75/1	5,625	11,250	16,900	22,500	33,750	★					
80/1	6,400	12,800	19,200	25,600	★	★					
85/1	7,225	14,500	21,700	29,000	★	★					
90/1	8,100	16,200	24,300	32,400	★	★					
95/1	9,025	18,000	27,000	★	★	★					
100/1	10,000	20,000	30,000	★	★	★					

N.B. Half any Ratio = Quarter Impedance      Double Ratio = 4 times Impedance  
 Speech-coil Impedance at 800 cycles is generally about 30% higher than its D.C. Resistance

FIG. 35.

The frequency response of transformers is usually so much better than loudspeakers that response curves are rarely considered necessary. The L.F. response depends on the inductance being high enough to suit the valve and the H.F. response depends on low leakage inductance, apart from turns ratio. The power and current capacity depends on the size of the core and thickness of wire.

When a transformer is centre-tapped there is a difference in the resistance of the two halves of the winding due to increasing size as the coil is wound, unless the windings are placed side by side, or are wound in four or more sections and balanced out. These differences in D.C. resistance are of no account for ordinary requirements.

Where the highest possible quality is required, with level response up to 15,000 cycles or more, it is customary to wind the primary and secondary in 8 or more alternating sections, thus achieving the tightest possible coupling and reducing leakage inductance to a minimum. The primary sections are then connected in such a way that equal resistance is obtained in each half. Such transformers take a long time to make and are naturally expensive.

The inductance of a transformer primary is largely controlled by the number of turns and the quality of the laminations.

The following are suggested as a rough indication of requirements for good quality—

Minimum Inductance—Power Triode —20 Henrys

„ „ —Pentode —50 „

Maximum Leakage Inductance — 0.1 Henry

Minimum Core Size for 5 Watts—approx.  $\frac{3}{4}$ "  $\times$  2"

„ „ „ „ 10 „ „ 1"  $\times$  3"

„ „ „ „ 15 „ „  $1\frac{1}{4}$ "  $\times$  4"

## CHAPTER XXI

# COMPARING PERFORMANCE

This is by no means so simple as it sounds. Anybody can hear the difference between a very poor speaker and a very good one, but when we have to compare two better-quality speakers there are many pitfalls.

It is necessary to bear in mind that the reproduction depends on the quality of the input, and if this quality is bad or distorted a better speaker will expose the distortion and sound worse than an inferior one. The B.B.C. are by no means blameless in this respect.

B.B.C. quality when it is good, is very, very good, but some transmissions are very bad and any attempt to judge speaker performance on a bad transmission will give misleading results. The same reservations apply to pick-ups, records and amplifiers. Many amplifiers suffer from H.F. distortion or oscillation which only shows up on a speaker with appreciable response above 10,000 cycles. Most pick-ups require bass lift and some require top cut on commercial recordings.

Take another case. Assume that your equipment cuts off a 5,000 cycles and you have one speaker with a smooth response up to 10,000 and another with peaks at 4,000/5,000 and nothing above 7,000 cycles. The latter would sound better. Still another case: Assume your equipment falls off badly in the bass below 100 cycles, and you have one speaker with bass resonance at 70/80 cycles and another with resonance at 30/40 cycles. The former would appear to have the better bass response.

However, let us assume that the available quality is good, and the loudspeakers are equally matched to the output impedance. If you mean business you will arrange a switch so that immediate comparisons can be made in the same passage of music. It is no use waiting until somebody changes the wires, as the ear forgets tonal quality or timbre very quickly. The quickest test is on full orchestral or dance music. Listen carefully to the bass and try to differentiate between a true note and resonance. The triangle, cymbals and snare drums are good for extreme top. Do not mistake cone resonance around 3,000/5000 cycles for top response. Drums and hand-clapping are excellent for comparing frequency response because difference-tones and harmonics do not arise to deceive the ear.

Needle scratch is also a useful source of sound, which covers a much wider frequency range than any musical instrument. Notice the general drop in pitch of about an octave when the needle is on the centre groove compared with the outside groove of a record.

The oboe has the highest overtones, and the organ goes down the lowest. The piano is not a searching test as it comes out well even with considerable top and bass cut. (See Fig. 10, Chapter IX). The violin is a good test for smoothness in the upper middle register, where peaks give a tinny effect to the tone.

Listen for clarity and transient response on full orchestral passages. A speaker which sorts out the instruments will not have any difficulty in dealing with solos. Try to distinguish true sensitivity from mere loudness. Flux density is expensive. It improves attack and adds life to the reproduction, whereas resonances increase the volume only at certain frequencies and blur the results. Allow for difference in position. If one unit is mounted near the floor, remember that high notes are directional and will only reach your ears by reflection.

Speech is an essential test, and most people judge its reproduction accurately. The first test imposed on a loudspeaker by the Research Department of the B.B.C. is to listen to the reproduction of speech in the middle of a field, away from reflecting surfaces, and compare it with the original voice. A good loudspeaker should give good reproduction of speech, but it does not of necessity follow that it will be equally good on music, which requires a much wider frequency range.

As regards ability to judge quality of reproduction, this depends on the gift of tonal discrimination, which is not the same as musical talent. A musician must be gifted in the sense of musical pitch, intensity and rhythm, but he may be no better than the average in appreciation of actual tone quality.

Although this capacity for tone judgment is more likely to be found in musical people than in others, it is possible for an unmusical person to be strongly gifted in this direction—with an ear for tone and no ear for tune.



## CHAPTER XXII.

### LOUDSPEAKER LIFE

The question "How long will it last?" is often asked about a loudspeaker, but so much depends upon the conditions of use that it is impossible to give a plain answer. A loudspeaker in a steam laundry may wilt in a few weeks, whereas the same type may last 10 or 15 years in a dry atmosphere. Tropical finishes will help a loudspeaker to resist extremes of climatic conditions, but reasonable protection from exposure is obviously necessary. Damp, dirt and metal filings are the loudspeaker's greatest enemies.

Given reasonable conditions, the best way to estimate length of service is by actual experience. I know of two or three extension speakers which have been in regular use for more than 14 years. The cabinets have been well cared for and are almost as new, and the performance is still satisfactory.

I have come to the conclusion that cones improve with age, especially under dry conditions. It is also clear that the continual movement of the cone assembly during use tends to free the suspension and lower the bass resonance. These factors often result in an improvement in quality as time goes on. I will cite two personal experiences in support of this rather interesting point. My friend, Mr. Beaumont, of Ambassador Radio, recently devoted many hours to the calculation of the correct exponential reflex corner loading for a 12 inch speaker for which we supplied a specially made unit with soft suspension. I was surprised to be told by Mr. Beaumont that the new speaker was not so good as an old one which had been used for the development tests. An examination with oscillator revealed the fact that the old speaker, which had a bass resonance at 65 cycles some five years ago, was now down to 35 cycles on open baffle, having absorbed a good deal of punishment during the period. As the resonance of the new unit was about 45 cycles, and as these technical men are hard to please, we had perforce to build another speaker with more compliance in the centring device.

My second illustration comes from Holland—a small country of which I am rather fond, as it was the only one in the world to import our speakers before the war. When I re-visited the country early in 1947, I was shown two loudspeakers which were nearly ten years old and which had been carefully preserved during the German occupation. Originally 10,000 lines, I estimated that the flux density had dropped to 9,000. In the post-war model the flux

density had been stepped up to over 12,000 lines, and my agents promised to make a comparison immediately new supplies were received. I was again surprised to be informed in due course that the quality of reproduction of the old speakers was preferred, in spite of the difference in sensitivity. It was found that the bass resonance had dropped from 70 cycles to nearly 50, and the maturity of the cones was having its usual effect. Such a test is only possible in the rather unusual case where a certain type of unit has been continued for a number of years.

I hope the reader will forgive the personal tone of this chapter, but it seems to be the easiest way to answer the original question. It means that, with careful use, the performance of a good loudspeaker can reasonably be expected to improve, just as the tone of a good piano settles down after the first year or two. One gathers from remarks made by Mr. Shorter of the B.B.C. Research Station during a recent lecture that they have loudspeakers of pre-war vintage, (I believe about 1934/5) of which they still think very highly.

## CORROSION

A peculiar (and fortunately uncommon) cause of Loudspeaker breakdown is corrosion of the voice coil wire. This may take the form of green-spot on the coil itself, or in severe cases the whole length of the copper wire from the coil to the eyelet in the cone may be covered by verdigris which eats into the copper and eventually causes an open circuit.

It is fairly certain that these effects are due to abnormal atmospheric conditions. Salt-laden air and proximity to chemical works appear to be prime causes. Coating the voice coil winding and leads with suitable varnish will usually protect the copper from this form of corrosion.

Where conditions conducive to corrosion are known to exist, it is advisable to protect the speaker unit by wrapping in cellophane or P.V.C. sheeting—even at the cost of some acoustic efficiency. In one installation in a chemical factory it was found necessary to run the extension wiring in lead-covered cable to overcome frequent breakdown.

## CHAPTER XXIII

### DOPPLER EFFECT

At least one writer has suggested that the treble note in a loud-speaker becomes frequency modulated by the bass note through the Doppler effect, but this hardly seems to matter at the velocity attained by the speech coil. Doppler's principle explains why the pitch of a locomotive whistle appears to drop sharply as the engine passes the observer. The speed of the engine is added to the velocity of the sound as it approaches and is deducted as it recedes. Thus, if the frequency of the whistle is 550, the wavelength is 2 ft. If the engine approaches at 60 m.p.h. or 88 ft./sec. the wavelength

$$\text{becomes } \frac{1,100 - 88}{550} = 1.84 \text{ ft, which is 598 cycles.}$$

When the engine recedes the wavelength is

$$\frac{1,100 + 88}{550} = 2.16 \text{ ft} = 509 \text{ cycles.}$$

The difference is equal to a drop of two notes on the piano, D to B.

In the same way, the forward and backward movement of the moving-coil must have some effect on the frequency of other notes. Assume an exceptional movement of  $\frac{1}{4}$ " each way at 50 cycles, and the speed is only about 2 ft. per second, which would cause a 550 cycle note to vary between 552 and 548. Such changes would rarely occur in actual use, and would not be noticeable at the rate of 50 per second. They should not be confused with vibrato, which involves a change of pitch of about half a tone at the rate of about 6 per second.

---

#### DOPPLER EFFECT

Further investigation reveals that the maximum velocity of the speech coil under the above conditions is 7 ft/sec. This is equivalent to variations of  $\pm 3.2$  cycles at 500 or  $\pm 32$  at 5,000 c/s. This is about one-tenth of a semitone and as piano tuning or the warming-up of an orchestra may vary one-tenth of a semi-tone, the change can be ignored in a loudspeaker.

## CHAPTER XXIV

### PHASE EFFECTS

The increasing use of negative feedback, acoustic loading and cross-over networks involves more serious consideration of phase effects.

As everybody knows, waves which are out of phase cancel out, and the need for baffles and cabinets arises to prevent the sound waves from the back of the speaker reaching the frontal waves out of phase. This only occurs where the wavelength is long enough.

The following diagram will make this clear. The curves A to E represent two full waves travelling in opposite directions, and the second line shows the position after they have travelled one quarter wavelength. They are completely cancelled out.

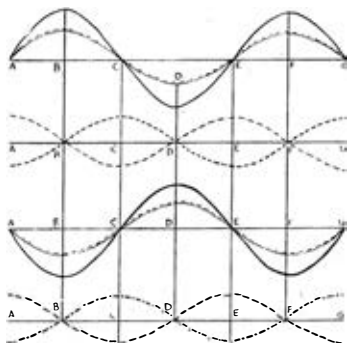

*From Wood's "Sound Waves and their Uses."  
(Blackie)*

FIG. 36.—Stationary waves due to two equal sets of waves travelling in opposite directions. The broken line with dots represents waves travelling to the left. The broken line without dots represents waves travelling to the right. Four successive instants are shown.

On the top line the two sets of waves are in phase, with the result shown by the continuous line. The second line shows the position after the direct and reflected waves have travelled one quarter of a wavelength. The two waves are now in exactly opposite phase. In the third line we see the position after the waves have moved through a further quarter of a wavelength, and the fourth line shows the waves again in opposition.

It will be seen from the foregoing that at a quarter wavelength the vibrations from each side of a loudspeaker will cancel out if they are allowed to meet. A 5 ft baffle with 2' 6" radius would

## PHASE EFFECTS

therefore start to cut off at 110 cycles, because the wavelength of this note is 10 ft. (see Piano Chart, Chapter IX) and the quarter wavelength is 2' 6". With a square baffle, the distance increases at the corners, so that cut off is not sharply defined. A circular baffle with the speaker mounted in the middle would be a very poor system.

## TWO SPEAKERS

If two cabinet speakers are placed one on top of the other and connected in parallel and in phase, moving one of them back 12 inches will throw them out of phase at 256 cycles (Middle C) and the output at this frequency drops 9 db. (this is quarter wavelength). Similarly, if they are connected out of phase, the movement increases the output. On musical reproduction the difference is quite audible, and the middle register may be seriously affected by wrong placing of twin speakers, as even a few inches may be of importance.

It will be noted that a quarter wavelength is always the first antinode at position B in the curve.

## REFLECTION

When a sound wave strikes a flat surface it is reflected out of phase, and the curves shown in Fig. 36 are arrived at by reflecting a pure sound wave and finding the stationary points by exploring with a flame which is moved by the vibrations. The positions where the waves are cancelled are known as standing waves. When a loudspeaker is placed across the smallest diameter of a room, with a wall in front and behind, the standing waves are obviously increased by reflection from the two walls. The speaker should be placed facing the longest length, or better still, in one corner of the room, so that standing wave effect is reduced as much as possible, just as in a concert hall of oblong shape, the platform is always placed at one end.

## PHASE INVERSION

In the reflex cabinet the sound output from the vent diminishes at frequencies above the vent resonance, whilst that from the cone increases. As the emission from cone and vent are partially in phase the output is well sustained. At frequencies below the vent resonance the output from the vent again diminishes, whilst that from the cone increases, but they are partially in anti-phase and the output falls rapidly. At the frequency of the vent resonance there is maximum output from the vent and very little from the cone. The phase effect is therefore of very small consequence at this point.

## PARALLEL

It is well known that two or more speakers in parallel, mounted in the same frontal plane, must be connected in phase to avoid severe loss by cancellation at low frequencies. It is possible to lose most of the bass by wrong connection. To check the phasing of two loudspeakers, connect a torch battery to the speech coil, and the cone will jump in or out of the gap; mark "positive" and "negative" accordingly. The phase is due to the direction of the speech coil winding and the polarity of the magnet. Above about 2 kc/s no noticeable effects occur.

The same remarks would apply to loudspeakers connected in series and placed close together in the same plane.

## DIVIDING NETWORKS

Where a crossover unit is used, there can only be phase effects at those frequencies which are being produced by both loudspeakers, with a maximum effect at the frequency of crossover. Also with a half section network the affected frequency band is much narrower than with a quarter section. When such speakers are out of phase there is a dip in the combined response around the crossover frequency, but it is not as a rule objectionable provided the crossover frequency is fairly high.

Normally, best results are obtained with the speakers in phase; a listening test is easily made. It is always worth while to move the treble speaker back with a quarter section network, and place it in the best position acoustically, and to reverse the leads with a half section and select the preferred arrangement. Some listeners notice a "feathery" effect when the speakers are out of phase. As the frequency rises, the importance of phasing gradually recedes owing to the shorter wavelength. With a crossover at 4,000 c/s, where the wavelength is only about 3", the question can be ignored. Similarly, the importance of phasing grows as the frequency is lowered, and it would be most important to ensure correct working with a crossover in the region of 500 c/s.

With a full section network - one with 3 elements in each limb to give attenuation at 18 db per octave - the phase shift is about 270°. It is therefore necessary to combine the procedures already outlined, by connecting the speakers in phase and moving the treble unit back a quarter wavelength at crossover frequency.

## ACOUSTIC LABYRINTH

The question of phase change in an acoustic labyrinth is rather more complicated than in a reflex enclosure. Owing to the length of the transmission line, there is a certain amount of phase shift, so that it is hardly possible to arrange for the same phase inversion. It is more satisfactory to look on the acoustic labyrinth as presenting a high impedance to the cone at resonance.

## CHAPTER XXV

### LOUDSPEAKER EFFICIENCY

There appears to be a good deal of doubt about the actual loss of power in the loudspeaker, in terms of watts output compared with watts input.

In one instance, it is stated that a 600 watt amplifier would be required to give symphony orchestra power of 30 watts from speakers on large baffles. This estimate is obviously based on 5% efficiency, but in view of the enormous volume available from even a 20 watt amplifier, the estimate appears to be wide of the mark. Many cinemas are run with 20 watt equipment and speaker systems similar to the R.C.A. illustration in Chapter XV are actually rated at 50% efficiency.

The latest calculations for the power radiated by a full orchestra give 70 watts at full volume, with 0.4 watts for the piano (see Chapter VIII). Taking the piano at 0.4 watts as a basis for comparison, the following tests were made for L.F. efficiency on four types of speaker, in a room of average size, care being taken to avoid resonance points where output is much greater.

<i>Type of Speaker</i>	<i>Mounting</i>	<i>Flux Density</i>	<i>Input 50/200 cycles</i>	<i>Average Output</i>	<i>Average Efficiency</i>
12" Cloth Surround	Infinite Baffle	13,000	1.1 watt	0.12 watt	11%
12" Corrugated	Reflex Cabinet	13,000	1.1 "	0.24 "	22%
8" Corrugated	Small open- back Cabinet	10,000	1.1 "	0.06 "	5½%
8" Corrugated	Reflex Cabinet	10,000	1.1 "	0.15 "	16½%

These figures are only intended as a rough guide.

The extra power at low frequency from Reflex loading is very noticeable.

---

These efficiency tests were only made at low frequencies because the readings at higher frequencies are seriously affected by standing waves and pressure points in ordinary rooms. As the room and walls are considered as part of the loudspeaker system the total efficiency is the interesting point. Estimates of dead room efficiency are of no interest to the average listener.



## CONCLUSION

There is a small supplement to this book giving commercial examples of some of the acoustic arrangements which have been considered. The selection has been quite haphazard and is not intended to be either representative or complete.

As regards the general question of reproduction, although there is a scientific explanation for all that happens, it is largely a question of opinion and taste. Many of the statements made are simply the writer's opinion. The human ear is very accommodating, but it still remains one of the most delicate and elaborate of instruments known to man, and it must be the final judge of all loudspeaker results. If this book has thrown some light on the subject, and if it has given some interesting details of the problems of loudspeaker design and performance, it has achieved its object.

G.A.B.

*My pulse, as yours, doth temperately keep time,*

*And makes as healthful music : it is not madness*

*That I have utter'd : bring me to the test.*

HAMLET.

## SUPPLEMENT

### AMBASSADOR

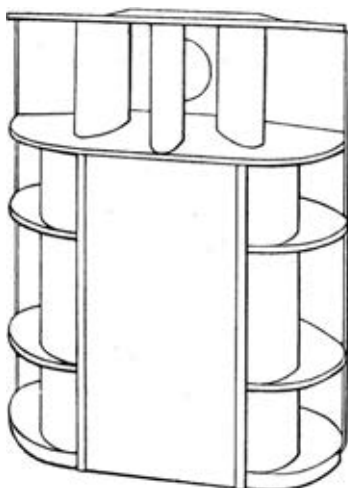
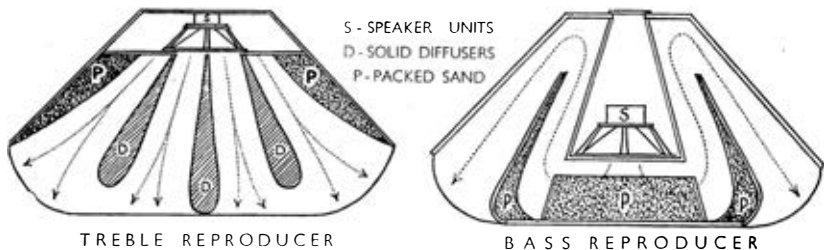

An interesting example of a folded exponential horn for bass, with four short virtual horns for treble.

The bass flare has a nominal cut-off at 65 cycles, but this is extended downwards by the walls of the room to an extent determined by the physical characteristics of the room itself. The pressure at the back of the cone is relieved by a small aperture at the apex of the inner chamber.

The cross-over network is carried out at high impedance and occurs at 375 c/s.

The complete unit handles an average input of 15 watts without break-up as a result of structural rigidity, all non-conductive cavities being packed with sand. A 12-inch unit for bass, and 8-inch with large magnet for treble, are fitted, both with cloth suspension. This speaker is installed and may be heard at the Weydale Hotel, North Bay, Scarborough.

SUPPLEMENT,

## VOIGT

As an example of the study of room acoustics, the Voigt Corner Horn was well ahead of its time. The efficiency range of the exponential horn was extended by reflectors for treble and a resonance chamber for bass, while full advantage was taken of the corner position. The natural effect of solo pieces leaving the loudspeaker at 3 to 5 ft. above floor level, with wide diffusion of low notes, was also achieved.

Very high flux density was a further feature of the system.

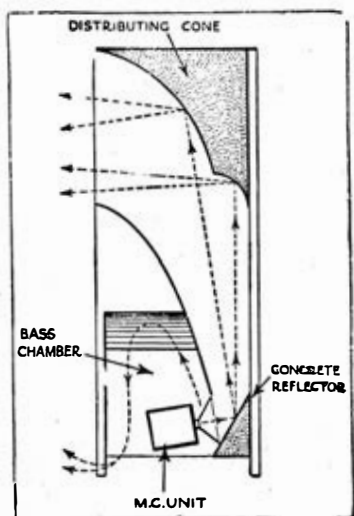

## BARKER

The Barker speaker is an interesting example of a dual drive system. An aluminium tube replaces the usual non-metallic coil former, with a thin layer of rubber, over which is wound a suitable coil. At low frequencies the coil provides the drive, but at high frequencies the coil inertia reduces movement and the aluminium former eventually takes charge and itself drives the cone. This change occurs progressively above 5,000 c/s.

The cone is formed from closely woven material impregnated with a synthetic resin and moulded under gentle heat.

The diameter of the speaker is  $12\frac{1}{4}$ " , and the peak input is 15 watts. Weight 13 lbs.

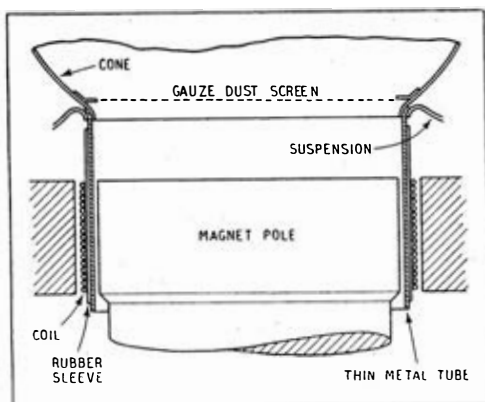

Construction of Barker Patent Dual Drive

## WHARFEDALE SAND-FILLED PANEL

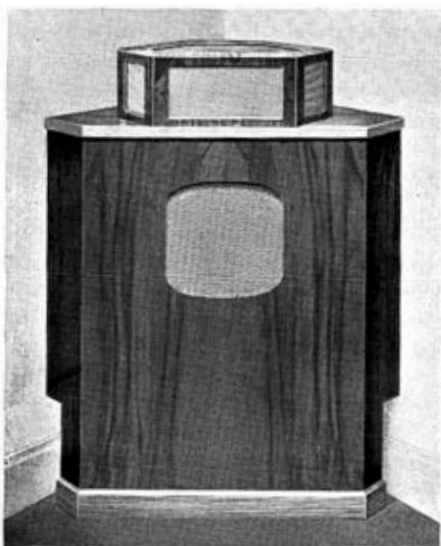

This arrangement gives results similar to the brick structure described overleaf, with the advantages of easy installation and portability. Two plywood panels are spaced one inch apart, the space is filled with dry sand, and the complete assembly weighs about one hundredweight. A 15 inch cloth suspension unit is used for bass, producing a fundamental resonance below 30 c/s.

The treble speaker(s) has open baffle mounting facing upwards to avoid HF beam effects and to improve dispersion. An 8" or 10" unit with Crossover at 1,000 c/s may be used for two speaker working, to which a third unit can be added for a three speaker system with 2 or 4 mfd condenser in series. A 5" high flux unit with aluminium voice coil is suitable here.

The height of the main structure is 40", capacity 9 cu. ft. Peak input 15 watts. Standing wave effects inside the cavity may be reduced by placing a layer of thick felt horizontally across the enclosure at a height of about 20" (B.B.C. patent) or by hanging lengths of soft material from the top to the bottom of the cavity spaced about 6" apart.

## WHARFEDALE BRICK CORNER-REFLEX

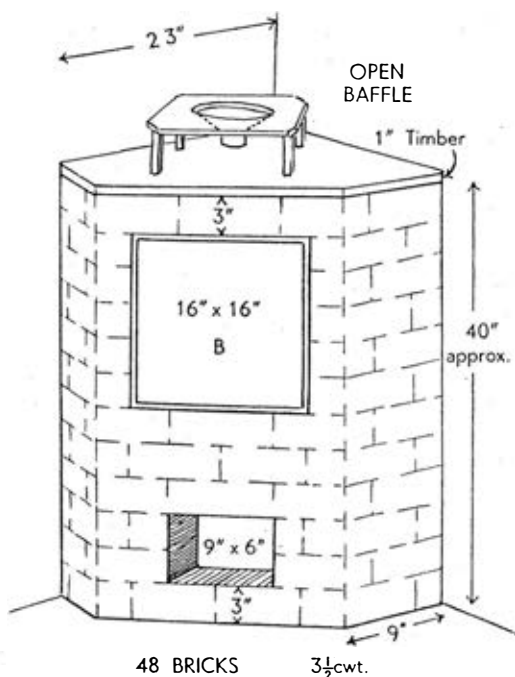

In this double-speaker system, a non-resonant corner cavity has been achieved at low cost by a panel of bricks and cement, completed by a heavy wooden top or lid. The bass speaker is a 15-inch unit with cloth suspension. The cone resonance is down to 18 cycles at which frequency the port emission blows out a lighted match with only 2 watts input to speaker. The cavity of 9 cubic feet has a very broad resonance which does not require tuning. An 8' or 10" Cloth Surround unit on baffle facing upwards is used for treble. The usual cross-over at 1,000 cycles is adopted. The reproduction of speech and music is far superior to anything possible with smaller or less rigid structures.

The 23" dimension on the diagram indicates the internal measurement.

The remarks about 5" unit and draping which are made on the previous page would apply with equal force to the above installation.

## KLIPSCH-HORN

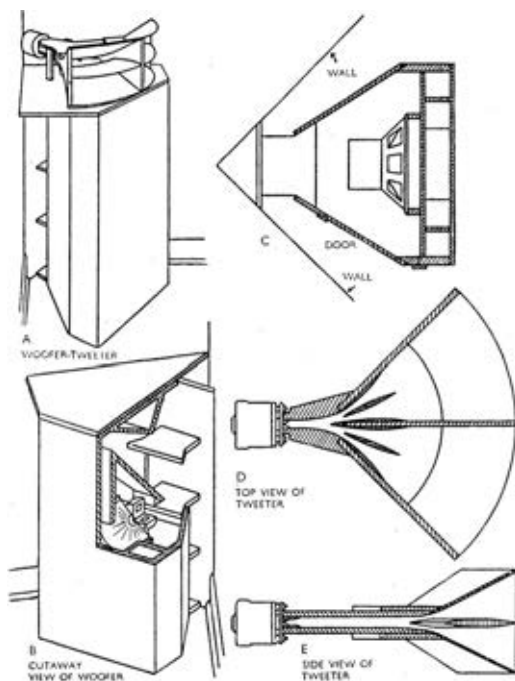

*Reproduced from Journal of the Acoustical Society of America, by courtesy of Vitavox Ltd.*

The Klipsch design is an interesting adaptation of exponential horn loading to dimensions suitable for domestic use. The corner of the room acts as an extension of the low frequency flare, and efficiency down to 30 cycles is claimed with a suitable 15-inch driving unit. A cross over at 400/500 cycles is used. The H.F. horn consists of a multi-cell arrangement for a short distance, followed by single horn expansion in a different plane.

## GOODMAN'S AXIOM 80

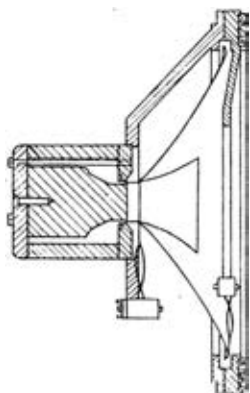

The diagram illustrates an interesting twin-cone free-edge speaker, having the remarkably low resonance of 25 cycles on large baffle. When used in totally enclosed cabinet the resonance rises to 40 c/s with  $4\frac{1}{2}$  cu. ft. or 50 c/s with  $3\frac{1}{2}$  cu. ft. enclosure. Special gap design gives 17,000 lines flux density, the suspension is on the Duplex Cantilever principle, and response is maintained up to 20 k.c. The free-edge avoids "surround" resonances and greatly reduces cabinet resonance. Chassis diameter  $9\frac{1}{2}$ ", peak input 10 watts, total flux 62,600 lines, weight 9 lbs.

## TANNOY DUAL CONCENTRIC

Usually known as a coaxial speaker, this design consists of a 15 inch low frequency unit and a horn loaded high frequency unit, with crossover at 1,000 c/s. The low frequency cone forms the final section of the high frequency horn, the latter being fitted with a duralumin diaphragm, two inches in diameter. Frequency response 30 to 20,000 c/s. Flux density, LF 12,000 Gauss, HF 18,000 Gauss. Peak input 20 watts. Weight including crossover, 30 lbs. Bass Resonance 35 cycles.

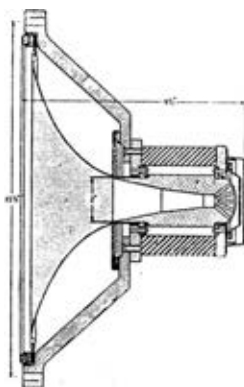

# INDEX

	<i>Page(s)</i>		<i>Page(s)</i>
Absorption Coefficients ..	59		
Acoustic Labyrinth ..	49	78	
Acoustics — Room ..	57		
Alcomax .. ..	14	15	
Alnico .. ..	14		
Amplitude .. ..	38		
Analysis of Tone .. ..	31		
Area of port .. ..	45		
Area of baffles .. 33	75	76	
Back Spiders .. ..	20		
Baffles .. ..	44	63	
Baffle area .. ..	33	75	76
Bakelised cone .. ..	18		
Balanced Armature .. ..	11		
Balance of Tone .. ..	32		
B.B.C. Tests .. ..	10	62	71
Binaural Effects .. ..	13		
Boom .. ..	48		
Brick Reflex .. ..	45		
Cabinets .. ..	42		
Cabinet Backs .. ..	41		
Celotex .. ..	47		
Centre Blocks .. ..	15		
Centring Devices .. ..	20		
Chassis .. ..	16		
Chokes — Tapped .. ..	54		
Cinema Speakers .. ..	55		
Coils — Air Cored .. ..	65		
Comparing Performance .. ..	70		
Compromise .. ..	9		
Condenser .. ..	11		
Cones .. ..	17		
Corner Position .. ..	57		
Corrosion .. ..	75		
Corrugations .. ..	17		
Cost of Magnets .. ..	15		
Crossover Frequency .. ..	65		
Cross-over Networks .. 64	77		
Crystal .. ..	12		
Curved Cones .. ..	17	35	
Cut-off Frequency .. ..	44		
Decibel .. ..	24	27	
Development of Speakers .. ..	11		
Diameter of Cones .. ..	19		
Die-cast Chassis .. ..	16		
Difference Tones .. ..	9	32	
Dimensions, Port .. ..	45		
Dimensions, Reflex .. ..	45		
Discs — Corrugated .. ..	20		
Distortion .. 10 20	42	66	
Doppler Effect .. ..	74		
Ear .. ..	26	30	
Efficiency .. ..	36	79	
Electro-Dynamic .. ..	14		
Elliptical Cones .. ..	17		
Energy — Watts .. ..	36		
Exponential Horns .. ..	51		
Extension Speakers .. ..	52		
Extra Speaker .. 41	47	48	
Feedback .. ..	61	66	67
Flux Density .. ..	15		
Frequencies .. ..	9	29	33
Frequency Doubling .. ..	19	35	
Frequency Modulation .. ..	10		
Frequency Response .. ..	29		
Front Spider .. ..	20		
Harmonic Analysis .. ..	30		
Harmonic Distortion .. ..	10		
Harmonics .. ..	31	40	
Hearing, Threshold .. ..	27		
Heat — Speech Coil .. ..	37		
Helmoltz .. ..	44		
Henney .. ..	57		
High Frequencies .. ..	9		
Horns — Folded .. ..	55		
Horns — Multi-cellular .. ..	55		
Impedance 21 47 48 65 67	68		
Impedance — Constant .. ..	54		
Impedance Reflex Load .. ..	22		
Impedance Soft Surround .. ..	23		
Inductance .. ..	69		
Infinite Baffle .. ..	43	58	
Intensity .. ..	29		
Intermodulation .. ..	18	64	
Instability .. ..	66		
Instruments — Response .. ..	29		
Labyrinth .. ..	49	78	
Leakage Inductance .. ..	69		
Life of Magnets .. ..	14		
Life of Loudspeakers .. ..	72		
Lining .. ..	47	49	
Loudness .. ..	24	28	
Loudspeaker Systems .. ..	11		
Magnets .. ..	14		
Masking .. ..	10	32	
Matching .. ..	67		
Maximum Watts .. ..	37		
Measuring Impedance .. ..	21		
Mechanical Impedance .. ..	22		
Moving Iron .. ..	11		



# INDEX

	<i>Page(s)</i>		<i>Page(s)</i>
Needle Scratch .. ..	25	Saturation .. ..	15
Networks .. ..	64 77	Seashore .. ..	9 31
N. F. B. .. ..	66	Separators .. ..	64
Noise Levels .. ..	25	Series Mounting .. ..	48
Olson, H.F. ... ..	10 61 62	Size of Room .. ..	57 58
Open Baffle .. ..	44	Sound Waves .. ..	31 75
Orchestral Power .. ..	25	Speech .. ..	27
Output Impedance ..	52 61 67	Speech-coil .. ..	12 38
Overload .. ..	38	Speed of Sound .. ..	32
Overtones .. ..	31 39 40	Steel Chassis .. ..	16
Parallel .. 41 47	76 77	String .. ..	40
Peak Input .. ..	37	Sub-harmonics .. ..	17
Phase .. .. 55 75	76 77	Suspension 12 18 23	35 38
Phase Distortion .. ..	55	Tests Reflex .. ..	46
Phase Inversion .. ..	44 76	Timbre .. ..	29
Phasing .. ..	76	Tone, build-up .. ..	9
Phase Shift .. ..	77	Tone, analysis .. ..	31
Phons .. ..	24 77	Transformers .. ..	67
Piano .. ..	33 39	Transformer Chart .. ..	68
Piston Movement .. ..	18	Transients .. .. 35	61 63
Pitch .. ..	29 74	Variable Resistance .. ..	54
Planes — Reflecting .. ..	57	Vent Output .. ..	46 47
Port .. ..	45	Vent Resonance .. ..	45 47
Potentiometer .. ..	54	Vibrations .. ..	39 41
Quality — Reproduction .. ..	9	Violin .. ..	31
Quarter Wavelength .. ..	49 65	Voltage — Output .. ..	52
Radiation Impedance .. ..	57	Volume Controls .. 52	53 65
R.C.A. .. ..	56	Volume and Watts .. ..	36
Reflecting Planes .. ..	57 76	Wall Mounting .. ..	58
Reflex Cabinets .. ..	44 76	Watts — Instruments .. ..	25
Remote Control .. ..	52	Watts — Output .. ..	36 79
Response .. .. 13 18	29	Wavelengths .. ..	32 33
Response Curves .. ..	34	Waves .. ..	75
Resonance .. ..	39	Waves — Reflection .. ..	76
Resonance — Cabinet .. ..	40 46	Weight of Magnets .. ..	15
Resonance — Cone 39 40 45	50	Wood, Alex .. 24 36	39 59
Resonance — Curve .. ..	43		
Reverberation .. 56 60	62 63		
Rhythm .. ..	29		

# a new—

## SPEAKER ENCLOSURE

A VALUABLE AID IN THE SEARCH FOR HIGH FIDELITY

By Arthur Adams

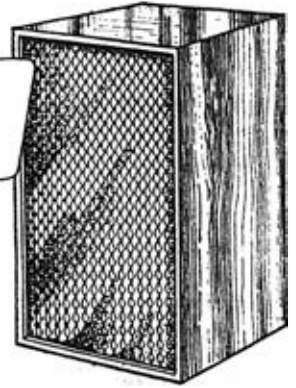

THE introduction of the long-playing record, with its extended frequency range, gave a much-needed fillip in the search for high fidelity reproduction. A further spur in this respect is the vastly superior quality of reproduction which is obtainable from the new frequency modulation transmissions of the BBC.

After a quarter of a century in the field of acoustics and a continuous striving for improvements in reproduction, the writer feels that his experiences (and mistakes) may be of assistance to others.

Although the loudspeaker is perhaps the weakest link in the chain, modern magnets with improved flux density and more precise tooling have given us excellent range and linearity; but where the manufacturers have failed, however, is that their backroom boys have not provided or designed suitable cabinets or enclosures to house these splendid units.

Hitherto, in order to encompass the lower frequencies, we have had to resort to reflexing with

its resonances, or the cumbersome corner enclosure with its booming and muddled bass. The large exponential horn is far too out of place for domestic purposes. It seems crazy to the writer that after producing *ultra linear amplifiers* we pass the resultant output through loudspeaker enclosures that boom and resonate in order to provide a spurious bass.

The position and size of the vent in the reflex cabinet determine its resonant frequency and if the music modulates its harmony to a point with its fundamental just off this frequency a discord will be produced. This is why the real student of harmony just laughs at our "canned music." It sounds to him like a bass player striking a wrong note.

The big enclosures and the craze for increased "cubic capacity" also ruin the crispness of the bass response of the best loudspeakers. The bass notes re-echo and resonate around the walls of these large enclosures so that the transients in the bass are entirely lost in a muddled boom.

### A Reversal

In this new design we adopt a complete reversal of this policy of large cubic capacity and place the loudspeaker in a compartment only just large enough to contain it. The necessary baffling being effected by an extended air column at the back of the diaphragm. This air column is expanded exponentially in order to avoid any resonances. In this way the diaphragm is made to behave in exactly the same manner as when exponentially horn-loaded at the front.

It will be at once appreciated that the exponential expansion of this air column really necessitates a curved structure, but straight material is used in this new design and the exponential factors are closely adhered to. The small plus and minus tolerances are carefully balanced out and have no effect on the resultant reproduction. If the measurements in the design are precisely adhered to, none of the cells will set up a resonant frequency or peak.

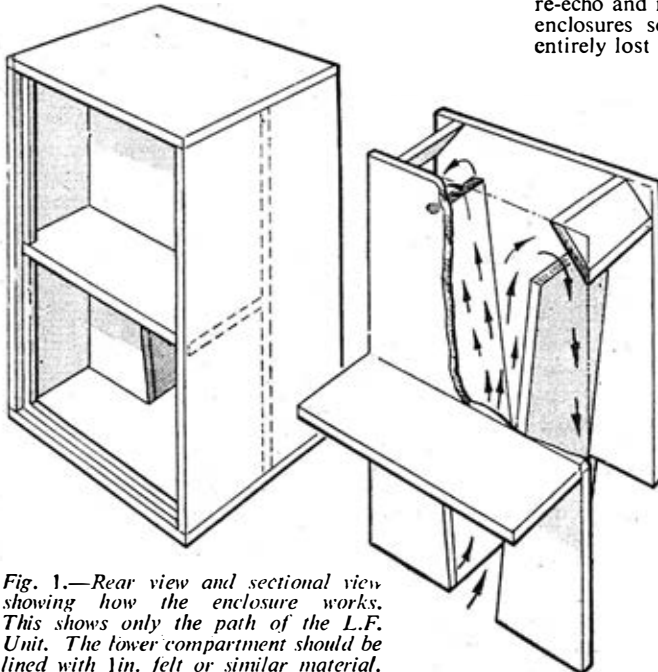

Fig. 1.—Rear view and sectional view showing how the enclosure works. This shows only the path of the L.F. Unit. The lower compartment should be lined with *Yin*, felt or similar material.

(Continued on page 529)

**Construction**

The enclosure is made throughout in  $\frac{3}{4}$ in. compo-board (Weyroc) and all joints must be firmly fixed and glued. This is particularly needed where the inner back meets the side panels. If this joint is not firmly made the side panels will "boom."

It will be observed that the front half of the enclosure is divided by a shelf, forming two compartments; the lower one accommodates the bass speaker and utilises the cellular-back baffle. This compartment must be lined with felt or soft material  $\frac{1}{2}$ in. thick in order to avoid any initial resonances being set up. It is not necessary to line the front panel which carries the loudspeakers. The front

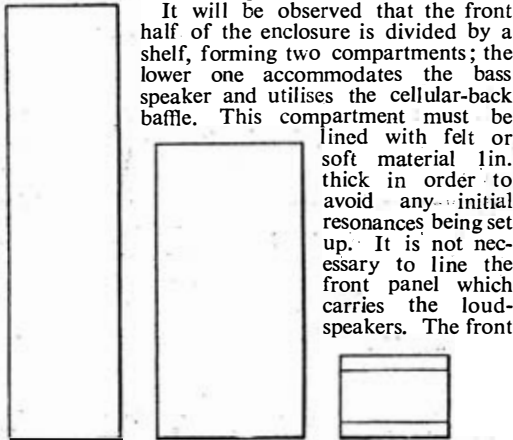

Fig. 2.—On the left the partition, in the centre the shelf, and on the right the gussets.

edge of the shelf must fit closely to the front panel when assembled and a small channel cut or filed in its front edge for the speaker leads. The leads can be located on the panel with sticky tape so that they fit into this channel on assembly.

The treble speaker (6in. elliptical) and crossover unit are fitted in the upper compartment. It should

be noted here that an elliptical speaker gives a better horizontal diffusion when mounted vertically.

The main speaker lead from the amplifier enters the enclosure through a  $\frac{1}{2}$ in. hole, which should be drilled in the back panel 10in. from the base. The lead should be provided with a collar or knot on the inside to prevent its being pulled away from the connections.

The back vents should be covered with muslin or light material in order to prevent the ingress of the domestic cat, toys, etc. The front panel is entirely covered with decorative material to taste.

The construction should be quite clear from the drawings and although rather complicated will be found well worth while; the crisp reproduction of the lower frequencies is a revelation, whilst the extended upper range assists in the reproduction of real high fidelity.

It should be understood that this design forms the basis of a patent application and cannot be manufactured for sale without arrangement with the designer.

**Assembly Order**

The peculiar construction of this new form of cabinet at first presented a problem, as the speakers had to be fitted from the front instead of being inserted from the back. In this case the speakers and crossover unit are all attached to the front panel, which is fastened in from the front; the panel screws being hidden by a  $\frac{3}{4}$ in. quarter-round moulding which is mitred to a "push-in" fit. (It may, of course, be pinned or glued.)

The best method of assembly is found to be as follows:

After all the necessary sections have been prepared, the precise positions of the gussets and partitions should be marked on both backs so that nails or screws may be driven through when being glued and

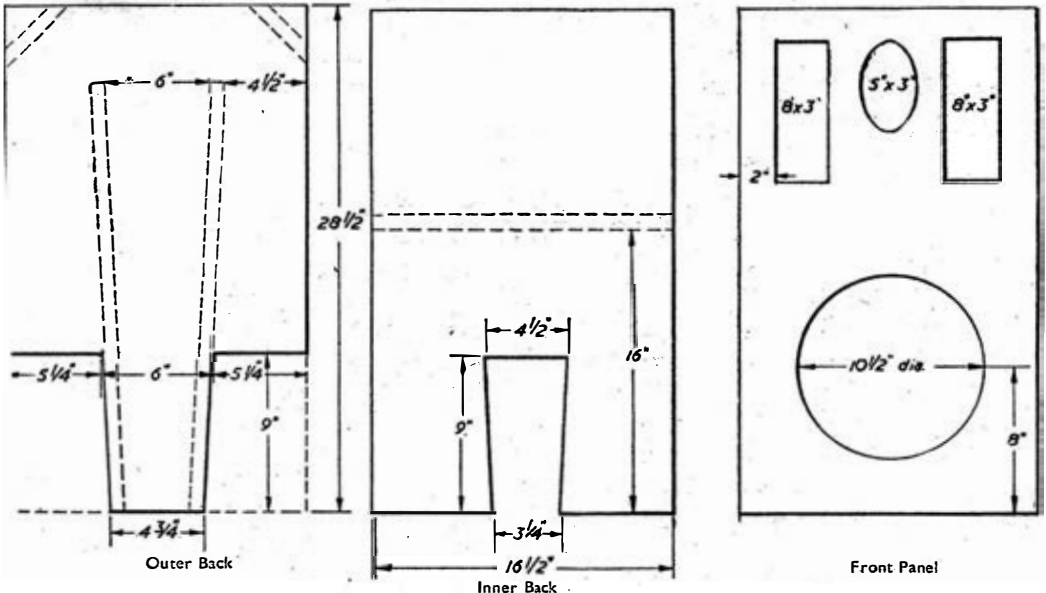

Fig. 3.—The front and back indicating the position of the partitions, gussets and shelf.

assembled. (This marking is necessary because the inner pieces are out of sight.)

First lay the outer back flat and apply the sides, top and the bottom, the back being inside and flush with the back edge of the panels. Glue and screw (or nail) all the joints.

The gussets and partitions are now fitted and glued. It will help in securing the correct location if small holes for the nails are drilled through the inner and outer backs. The inner back may now be laid in and firmly glued and pinned to the inner pieces and to the side panels. Securing the inner back all round is the most important, as if this is not done the sides will resonate.

The shelf is now fitted 16in. from the bottom and securely fixed to the side panels and inner back by nails driven obliquely or by small **battens** fixed to the sides and back. A  $\frac{3}{4}$ in. fillet is now fixed all round the

inside of the outer panels,  $1\frac{1}{2}$ in. from the front edge and in line with the front edge of the shelf. This is for fixing the front panel. File or cut a  $\frac{1}{4}$ in. vertical groove in the precise centre of the front edge of the shelf for the speaker leads, as previously mentioned. The compartment with the back

aperture is now lined with 1in. felt or similar soft material. All screws or nails should be driven below the surface and a good filler used to level up. The cabinet may then be painted or veneered and polished.

#### CUTTING SIZES

(All of  $\frac{3}{4}$ in. Weyroc)

Front, inner and outer back—all  $28\frac{1}{2}$ in. by  $16\frac{1}{2}$ in.

Partitions (2 off)  $24\frac{1}{2}$ in. by 6in.

Gussets (2 off) cut to fill corners as shown in Fig. 3, long sides being bevelled to 45 degrees.

Shelf  $16\frac{1}{2}$ in. by 8in.

Top and bottom, 18in. by 17in.

Side panels (2 off)  $28\frac{1}{2}$ in. by 17in.