

NEW HI-FI SOUND GUIDES 20p

# *Using your Hi-Fi*

4

Stereo checks · adjustments · installation



by Clement Brown editor HI-FI SOUND magazine



OUR AK 124  
12 INCH LOUDSPEAKER  
IS EXPENSIVE . . . .

BUT WITH A SPECIFICATION  
LIKE THIS

Bass Resonance—40Hz  
Impedance (at 400Hz)—15 ohms  
Nominal Response—30-13,000Hz  
Construction—Dust excluding  
Magnet Assembly—Feroba II 4kg (9lb.)  
Total Effective Flux—180,000 Maxwells  
Flux Density—16,000 gauss.  
Cone Diameter—305mm (12in.)  
Piston Diameter—241mm (9½in.)  
Resistance of Voice Coil—12/13 ohms  
Finish—Silver Grey Hammer Stove Enamel  
Easily replaceable Cone  
(You really can do it yourself)  
Total weight—6.75Kg (15lb.)

YOU'D EXPECT IT TO BE

---

*For further product details contact:—*

**VITAVOX LTD.**

**Westmoreland Road, London, NW9. 9RJ**

**Telephone: 01-204 4234**

# ***Using your Hi-Fi***

WHAT IS HI-FI and why is its appeal so strong? How does one set about choosing equipment and ensure it is kept at peak performance? How does stereo work and what are its advantages? Will new developments affect the choice of system? Answers to such questions form the basis of these booklets. Written by Clement Brown, editor of *Hi-Fi Sound*, and closely linked with the policy of the magazine, these concise guides are of special value to the beginner but also meet the need of the more advanced amateur enthusiast for a survey of his chosen subject.

To follow in this series is Practical Hi-Fi Guide. Already published are Introduction to Hi-Fi, All about Stereo, Planning and Buying Hi-Fi.

© 1972 Haymarket Publishing Ltd  
Haymarket Publishing Ltd, Gillow House  
5 Winsley Street, London W1



RH892

**Let us worry  
about the wow  
and the flutter.**

The RH892 is a design for the man who doesn't want to build it himself. A sound system that gives you the sounds—beautifully—without the worry.

The deck has a low mass, low resonance tubular pick-up arm with viscous damped lifting mechanism and is fitted with a stereo ceramic pick-up head.

The amplifier delivers 2 x 12 Watts music power and is equipped with stereo balance control, switchable rumble and scratch filters and continuous treble and bass controls.

And the tuner receives LW, MW and FM. It has an FM stereo decoder, AFC for optimum reception on FM and a sensitive ferroceptor for MW and LW.

This combination unit is one of a whole spectrum of separates, planned systems, and combination units ranging up to the highest specifications to suit all tastes and pockets.

**PHILIPS**



**AMPLIFIER**

Power output (sine wave):  
2 x 8 watts into 8 ohms  
Music power:  
2 x 12 watts into 8 ohms  
Harmonic Distortion:  
2% at 2 x 6 watts  
Frequency range:  
60-20,000 Hz  $\pm$  3dB  
Tone Controls:  
Bass: +14 to -18dB at 50Hz  
Treble: +12 to -13 at 10KHz  
Scratch filter:  
-6dB/octave  
Rumble filter:  
-6dB/octave  
Signal to noise ratio:  
> 55dB  
Channel separation:  
> 30dB at 1KHz  
Input sensitivity—Tape:  
230mV into 500K ohm for  
8 watts output

**TUNER**

Wavebands:  
LW 150-260KHz (2000-1154m)

MW 525-1605KHz  
(511-187m)  
FM 87.5-108MHz

Aerials:  
Ferroceptor for MW and LW  
(socket for external AM  
aerial and earth)  
IEC socket for FM dipole  
aerial  
Sensitivity:  
AM 25 $\mu$ V for 26dB signal to  
noise ratio  
FM 8 $\mu$ V at 15KHz deviation  
1.5V at 40KHz deviation  
for 26dB signal to noise ratio  
across 300 ohms  
Selectivity:  
AM 20 x for 9KHz off  
resonance  
FM 30 x for 300KHz off  
resonance  
Distortion:  
<4% at 75KHz deviation  
Pilot frequency  
suppression:  
-24dB at 19 and 38KHz

Audio response:  
(with 50 $\mu$  sec  
40-12,500Hz  $\pm$  3dB)  
de-emphasis

**RECORD PLAYER**

Chassis:  
GC008  
Turntable:  
10" diameter  
Speeds:  
33 $\frac{1}{3}$  and 45 r.p.m.  
Wow and Flutter:  
> 0.2%  
Rumble:  
-38dB(DinA)  
-58dB(DinB)  
Pick up:  
GP213  $\frac{1}{2}$ " ceramic cartridge  
Stylus pressure:  
2-4g (calibrated adjustment)  
Dimensions:  
(w x h x d overall)  
21 $\frac{1}{2}$ " x 6 $\frac{1}{2}$ " x 11 $\frac{1}{2}$ "  
Weight:  
21 $\frac{1}{2}$  lbs (9.7Kg)

## **CONTENTS**

<b>1</b>	<b>HI-FI AT HOME</b>	<b>11</b>
<b>2</b>	<b>INSTALLING HI-FI—I</b>	<b>13</b>
<b>3</b>	<b>INSTALLING HI-FI—II</b>	<b>25</b>
<b>4</b>	<b>USING AND STORING RECORDS</b>	<b>37</b>
<b>5</b>	<b>UPGRADING YOUR HI-FI</b>	<b>43</b>
<b>6</b>	<b>HI-FI MAINTENANCE AND FAULTS</b>	<b>46</b>
<b>7</b>	<b>PRACTICAL HINTS</b>	<b>50</b>
<b>8</b>	<b>READING ABOUT HI-FI</b>	<b>60</b>

**Get on the right Track . . .  
. . . for Hi-Fi at**

# **James Kerr**

**and Company Ltd.**

**98-110 Woodlands Rd.  
Glasgow C3**

***RECORDS — TURNTABLES — AMPLIFIERS  
TUNERS — SPEAKERS — TAPE RECORDERS***

**Sound Quality !—Sound Value !**

James Kerr & Co Ltd stock only the best in Hi-fi and Stereo equipment and invite you to visit our spacious new showrooms to see and listen to our Selective Range of Amplifiers, Turntables, Tuners, Tape Recorders and Speakers by leading manufacturers.

Quad, Armstrong, Goldring, Sansui, Ferrograph, Lowther, Dual, Mordaunt-Short, Garrard, Trio, Leak, SME, Thorens, Bowers and Wilkins, Wharfedale etc.



Public Address  
& Background Music  
Installation  
Specialists



**98-110 Woodlands Road, Glasgow C3  
Tel: 041-332 0988**

All told, the TLS went through it's lab tests  
with the ease and authority of a champion.

HIGH FIDELITY

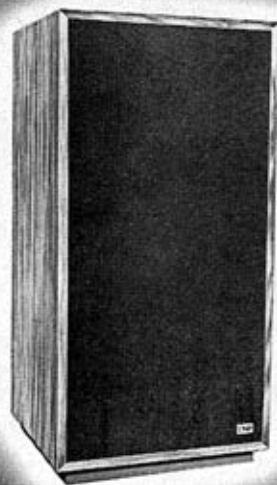

IMF transmission line speakers

62 68 Silver Street, Reading, Berkshire, England. Telephone READING 861471

# Celestion



Loudspeakers for the Perfectionist

*Proudly present the Fabulous*

Celestion 

# DITTON 44

MONITOR

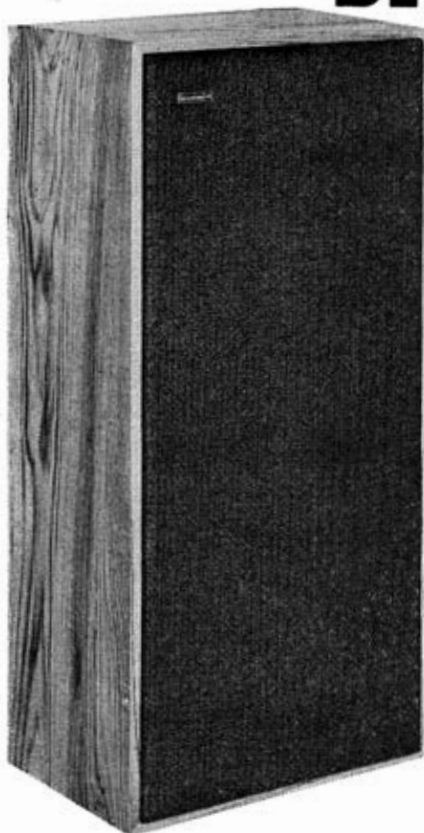

Dimensions:	30" × 14½" × 10"
Max Input:	44 Watts (D45.500)
Response:	30 Hz to 30 KHz
Impedance:	4 to 8 ohms
Crossover:	500 & 5,000 Hz
Treble:	HF2,000 (pressure)
Mid:	MF Super 5"
Bass:	LF Long drive 12"
Finish:	Natural Teak
R.R.P.	£54.00 each

*Plus full supporting cast!*

*Left to Right:* Ditton 10 Mark II, Ditton 120, Ditton 15, Ditton 44, Ditton 25.



**ROLA CELESTION LTD, DITTON WORKS, FOXHALL RD, IPSWICH, SUFFOLK, ENGLAND**



When the most subtle tonal  
qualities in the world need amplifying  
and the amplification equipment  
just must not obtrude  
the obvious answer is

**QUAD\***



**QUAD**

for the closest approach  
to the original sound

QUAD 33/303 Amplifiers  
QUAD FM3 Stereo & AM3 Tuners  
QUAD Electrostatic Loudspeakers

Send postcard for illustrated leaflet to Dept. HFSG  
Acoustical Manufacturing Co. Ltd., Huntingdon. Tel. (0480) 2561  
\*QUAD is a registered trade mark.



A three waveband stereo tuner/amplifier giving 2 x 15 watts RMS, with slide-rule tuning and electronic tuning meter.

A four track, two speed stereo tape recorder with mixer-panel sliders and an irreproachable specification.

A two speed, semi-automatic turntable unit with its own arm and cartridge, bias compensation, tracking weight adjustment and strobe ring.

A pair of pressure chamber speakers, each with handling capacity of 20 watts RMS, roll-surround bass unit, robust DOME tweeter and frequency response of 45-20000Hz.

The Bang & Olufsen 1200 series. Four individualists, one family group - all bearing a unique and valuable guarantee of quality.

For further information or literature write to:

**Bang & Olufsen U.K. Limited**  
Consumer Advisory Service  
Mercia Road Gloucester  
0452 31491  
London Office and Showroom  
70/71 Welbeck Street London W1  
01-486 2144



*Recommended retail prices. Teak or White finish, Beovox 2700 £63-90 (per pair),  
Beocord 1200 £99-50, Beogram 1200 £56-90, Beomaster 1200 £99-50.  
Rosewood finish a little extra.*

# 1 HI-FI AT HOME

---

BEFORE YOU can settle down to enjoy some music you will have to install your system, paying special attention to a number of important points that directly affect the quality of the results. 'Settle down' rather than sit on the edge of your seat wondering whether something is about to go wrong! A system that is carefully installed and precisely adjusted should inspire confidence—you should soon come to take it for granted. The pickup, however light it tracks, should seem secure. The signal-to-noise performance should be as expected at the highest volume levels you customarily use. The overall tonal balance should be as you anticipated and the general quality should be properly in tune with the expense you incurred.

If you want nothing to do with installation and initial adjustment you can avoid these chores—as many do—by asking your suppliers (who may have assisted in the planning) to bring everything along, wire it all up, and leave it in normal, well-adjusted working order. Obviously, if the system fails or disappoints in some way—though it is generally to the standard expected for the price—the suppliers can be called back to investigate. But it is no use complaining about the service if after an evening's trial you become aware that your real requirements actually demand a much greater expenditure than you allowed yourself.

In this booklet we are mainly concerned with the interests of the enthusiast who buys either a number of audio units, intending to bring them together in a domestic system, or a complete system that is ready to work, poses no great installation problem, but does require adjustment—and, of course, the general care and maintenance involved in using any high quality equipment. Those who buy specialised units, choosing each piece on its merits and after studying specifications and test reports, will finish up with the maximum number of jobs to do; but the assembly of these units into a working system demands no deep technical knowledge, and it is rather a matter of attention to detail and a general handiness with simple tools.

We shall look at a number of essentially practical points, and the following are particularly important. In a system for records, the pickup and the records themselves are the most vulnerable items and together provide the key to quality. The pickup must be precisely installed and adjusted and a check made of its tracking performance. Turntable mounting details may influence signal-to-noise ratio and should therefore receive attention, as should the position of the player in relation to the rest of the equipment. Ideally, in a typical set-up, the pickup will be near the amplifier (so as to keep the signal connections short) but at a considerable distance from the loudspeakers. Obviously room layout and any special problems, such as transmission of vibrations via floorboards, will affect ideas about installation. There is most likely something wrong with your planning if the system cannot be accommodated conveniently, without large-scale reorganisation of the room's contents.

Modern equipment is often of appealing design and may be exposed on wall furniture or shelves. Separate unit form is the common approach: it is traditional and has long been influenced by a purchase tax system that has claimed increasing revenue from the purchaser without losing many anomalies, as well as by obvious economic factors leading to gradual assembly of the equipment.

Today, by far the largest number of systems in use are disposed on shelving and simple furniture, and the design of products intended for such display has improved enormously as hi-fi has become more international. A 'technical' look is most readily bestowed on control panels that cater for a wide array of operations and very many equipments, especially the more advanced examples, are of this kind. Simple, uncluttered design, though desirable, is less easily found, but the choice is so wide that most people should be able to see their tastes reflected in the industry's products. The loudspeaker presents the biggest problem—literally, for in general the best speakers are bulky.

A console installation may be preferred, or all items except the speakers may be camouflaged in existing furniture or cupboards provided ventilation requirements are satisfied. Whatever the arrangement, do not make any assumptions about the best place for loudspeakers; their positions are found by experiment and there are no rules leading to successful stereo presentation.

Other requirements include care over wiring-up the signal connections so as to minimise the hum and noise level and, where FM radio is included, the provision of an aerial appropriate to local reception conditions. Then there are such matters as simple maintenance routines and the correct storage of records.

## 2 INSTALLING HI-FI—I

---

INSTALLATION OF record playing equipment may be very simple indeed or rather tricky, depending on the design of the components, but usually nothing is involved that the painstaking amateur cannot tackle with complete success provided he follows instructions and gives himself enough time. Integrated players—turntable and arm, 'transcription' or otherwise, sharing a flat metal baseplate—are very popular, largely because in this type the arm is virtually ready for use—apart from tracking weight adjustments and the like, to be explained later.

However, some of the finest arms are separate components, and the demanding user may specify one of these, to be mounted with a high-grade turntable. He may feel he can assemble these items—it is an interesting and satisfying job—and may therefore welcome a reminder of some important points.

No apology will be offered for the emphasis placed on quite small details, for work with pickups is mostly a matter of details all of which contribute to good results. Further, there will be little 'listen-and-find-out' advice. Indeed, the average user should ignore advice to the effect that his ears can be the judge. This may seem odd when we all agree that your ears have finally to tell you whether you like the quality of a system. But we are concerned here with adjustments that are individually small but collectively important. It is essential to follow scientifically worked-out instructions and to seek precision. Few ears are experienced enough to check on the effects of small adjustments. To insist otherwise is to court confusion (and there is plenty of that without making more).

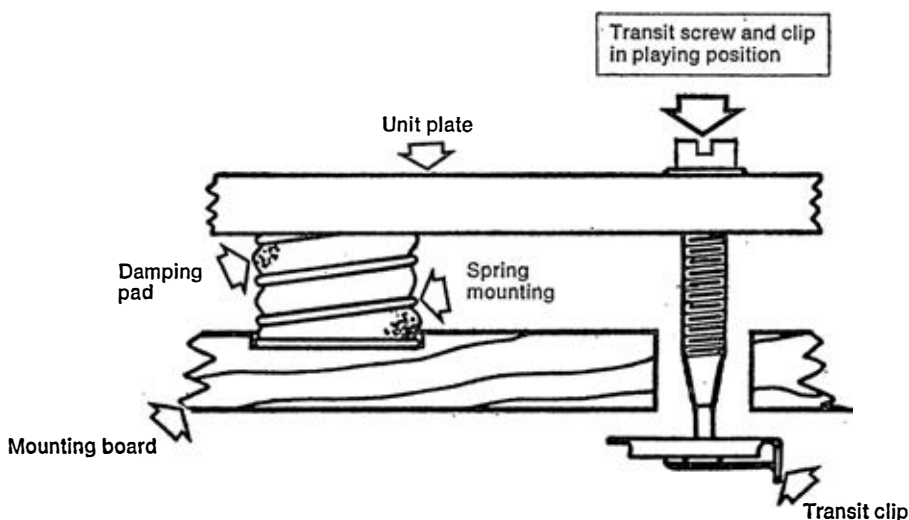

*Typical spring mounting with transit locking screws (Garrard Zero 100).*

First a note on the integrated player: then a longer account of the installation and adjustment of components, including the checks that are appropriate to players of all kinds.

### Installing a player

For many people, installation consists of placing the housed turntable/arm unit on a shelf or some item of furniture. The main requirement is a secure resting-place at a height convenient for operation of the controls and in a position where vibration from the speakers cannot cause interference (acoustic feedback, leading to a growling or howling noise and a restriction on volume setting). The player should also be isolated from disturbance due to footsteps and the mounting should of course be level.

The simplest mounting arrangement consists of a shelf or just a pair of brackets, firmly plugged to a wall—a cheap solution that will appeal to the user who finds that floorboard movements or other interferences too easily influence the pickup. Obviously the wall mounting gives good isolation and can avoid the need to move round the room on tiptoe on hi-fi evenings! However, many people have solid floors and existing furniture may be preferred for the hi-fi, or a movable housing may be convenient. A cheap and handy trolley for the unhandy amateur is in the form of two shelves and two uprights (use four pieces of Handiboard or similar veneered particle board) the structure being fitted with castors so that it can be moved alongside an easy chair. The amplifier can be placed on the lower shelf and the player, in a plinth, on the top.

The player may be purchased in chassis form and installed in a plinth or larger cabinet. Integrated players are easily dealt with, installation being reduced to the provision of a cut-out in the mounting board. Spring mounting will most likely be provided and recommended by the manufacturers, who will provide a paper pattern or template to guide the cutting-out and the location of mounting points for the springs. If the plinth is home-made, cut the board from chipboard approximately  $\frac{3}{4}$  in. thick, or an equivalent material, especially if a heavy transcription unit is to be installed. Do not use either a material that is likely to warp or one that is light and springy.

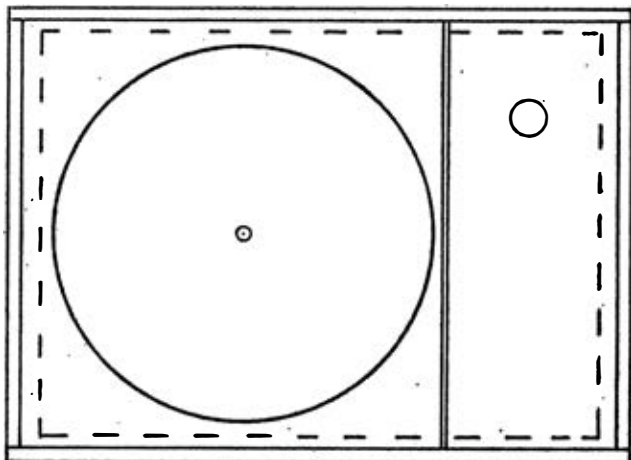

*Separate turntable and pickup boards may be used provided there is no relative movement.*

It does not often come to light that some difference in rumble level can arise according to solidity of mounting. In particular there may be some difference between spring mounting and an arrangement in which the unit is firmly clamped down on its board, and there is something to be said for an experiment to determine whether results are better with solid mounting. The latter is permissible if there is obviously no need for any mechanical isolation. Another practical point: when making a plinth, ensure that there is space at the back for the arm counterweight to swing as the disc is tracked.

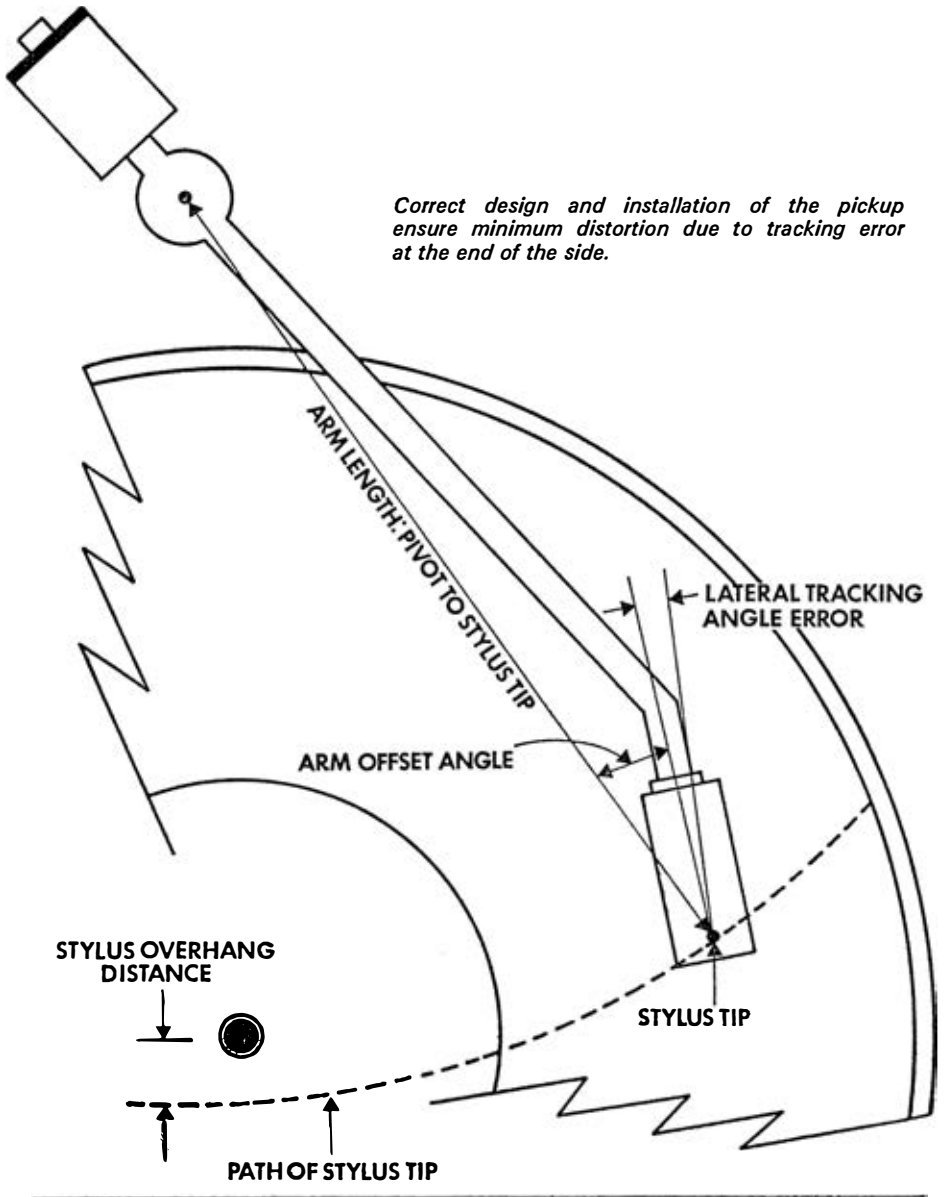

## Turntables and pickups

Installation of a separate arm and turntable is subject to basic requirements that apply to a player in chassis form, especially where solidity and space for convenient operation are concerned. Additionally the pickup arm must be positioned precisely in relation to the record it is to play—as specified by the manufacturer of the arm. This component will normally be to the right of the turntable so that the cartridge is outside the influence of any stray magnetic field due to the motor. The attention to detail required here extends to other jobs, not least the mounting of the cartridge and the final setting-up for optimum tracking.

The cut-out for the turntable is prepared exactly as for a complete player unit, using the paper pattern or other instructions supplied, but the position chosen within the area of the cabinet must be such that there is enough room for the pickup at the right-hand side. In a typical case the turntable is well to the left, with its front edge quite near the front of the cabinet or plinth,

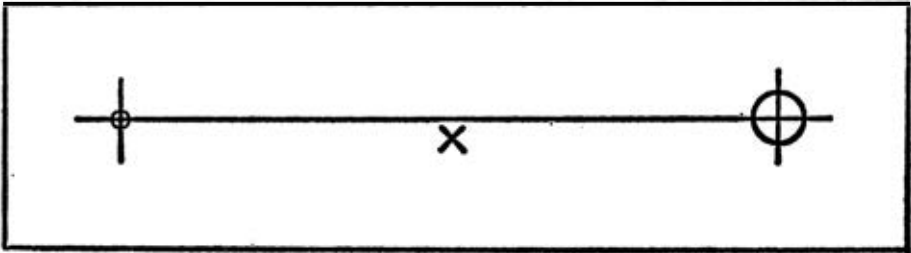

*Pickup mounting template.*

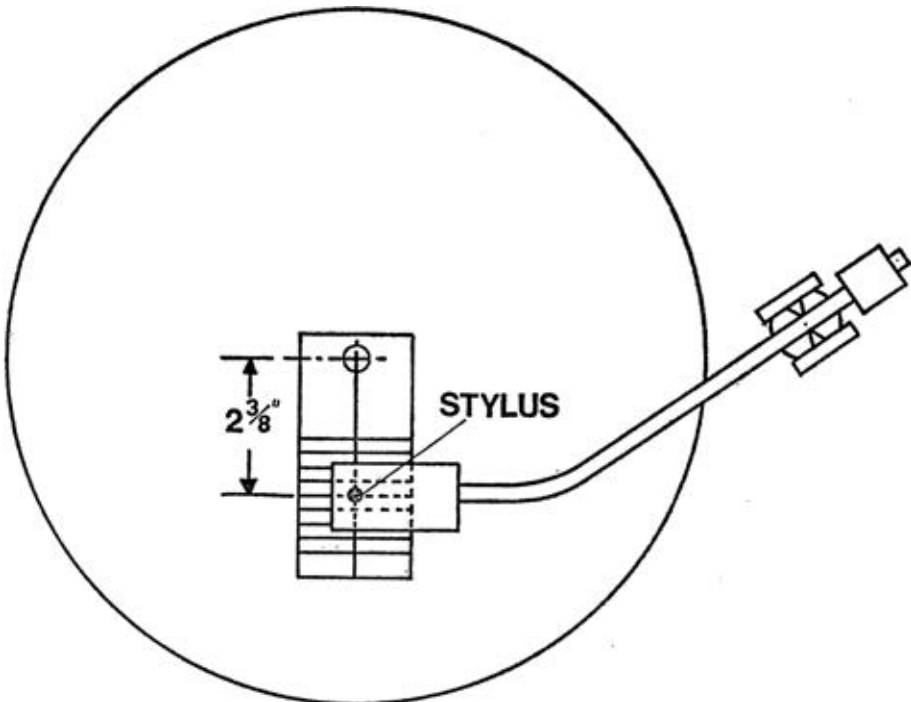

*Use of alignment protractor. Stylus is placed  $2\frac{3}{8}$  in. from the record centre.*



depending on details of cabinet construction. Although an unnecessarily big plinth may be a nuisance, it is convenient to have a little spare space at the back or side in which to store such items as cleaning aids and a spare cartridge or stylus assembly.

A separate turntable is assembled on a rigid baseplate, usually rectangular and little wider than the turntable platter. This baseplate should be screwed firmly to the mounting board and *not* provided with any springy supports. The wooden board provides the common support for turntable and pickup. Two separate boards, fixed to front, rear and side wood rails, could be used if necessary, but this does not alter the principle of solid support and prevention of relative movement of arm and turntable.

If some decoupling is thought desirable in the plinth construction (as a precaution against the effects of mechanical shock) it can be arranged by providing a resilient mounting for the entire board within the plinth. Some users experiment with foam rubber in the form of pads or strips, and spring mounting also is possible, but very floppy mountings have a certain nuisance value and in practice are rarely necessary.

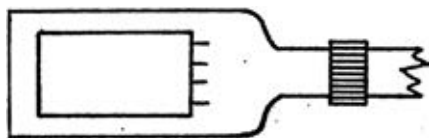
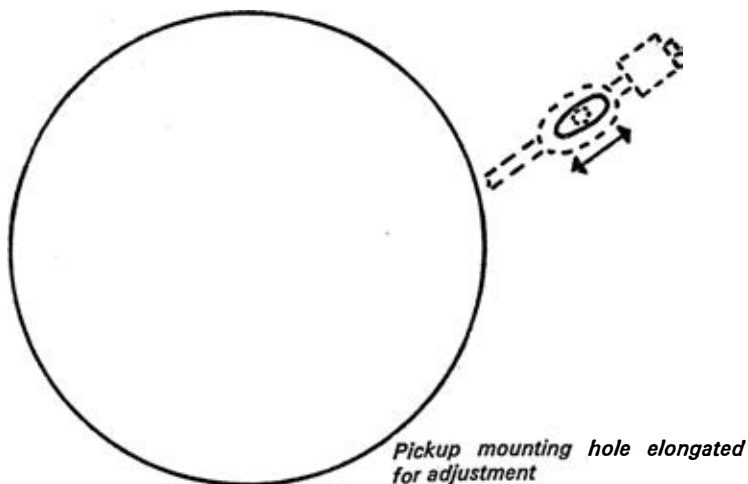

*Mount the cartridge squarely as seen from top, side and front.*

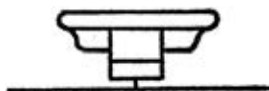

The heavy turntable platter should be removed while you are doing the installation work. Before fitting it, check that the motor is suspended freely and correctly on its rubber or spring mounts—an arrangement commonly used in units of the sort that incorporate idler-wheel drive. You will have to loosen or remove the transit screws that secure the motor (keep them in case it ever becomes necessary to dismantle the hi-fi and move the turntable). Some turntables, particularly certain models with belt drive, have solidly mounted motors, and installation involves fitting the belt and checking any springy mounting system supplied for the complete turntable assembly. When the turntable is in position, connect up and check that it works before you start to worry about the pickup! Consult the manufacturer's instructions for information on lubrication and any special adjustments.

The curious geometry of the pivoted arm was explained earlier in this series, when it was emphasised that the idea is to design, manufacture and adjust to ensure minimum distortion due to lateral tracking error. The error involved is really rather small and innocuous—or at least, it will be seen as such if we contrast it with other hazards arising in sound reproduction. That there is constant preoccupation with lateral tracking error—and apparent acceptance of far worse sources of distortion—is as curious as the geometry of the pickup!

Arm shape is best appreciated by studying the drawing, which first appeared in *Introduction to Hi-Fi* and which is important enough for a second showing. The nominal length of the arm is the stylus-to-pivot distance and is usually in the region of 8-9in. The rear overhang, due to the counterweight, is likely to be a couple of inches or more—for which you must make allowance when specifying or constructing the plinth.

However, the distance from the pivot point to the turntable spindle is the one that matters most of all when you come to install the component. Very few complete pickups (i.e. fixed head/arm combination) have ever been marketed but if you use one of these (the Decca ffss is particularly well known) the pivot-to-spindle distance is specified and you should make the mounting hole for the pickup in accordance with the manufacturer's instructions.

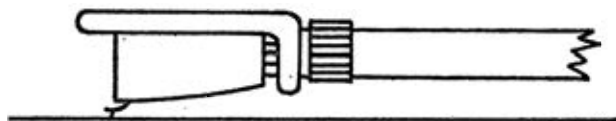

*Arm tube of a hi-fi pickup should be parallel to the record surface.*

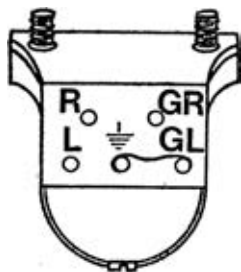
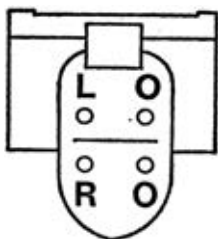
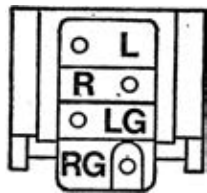

*Typical cartridge terminations: Shure, Elac and Bang & Olufsen.*

In doing so you obtain the optimum position. The simple template supplied to aid this work usually takes the form of a card marked with a hole, just over  $\frac{1}{2}$ in. diameter, to locate on the turntable spindle and, at the other end, a mark to indicate the position for the pickup mounting hole. Place the card in position on the turntable and swing it round until you find a suitable point for the arm, checking that there will be space at the rear and sides for the counterweight.

### **Universal arms**

The requirements are a little different with the 'universal' type of arm purchased by most people. This type accepts various makes of cartridge and there are small but important differences in dimensions to be taken into account in the setting-up. Final adjustment should be made with an alignment protractor—a kind of template for checking tracking error at the inner grooves of the disc (at a distance of  $2\frac{3}{8}$ in. from the turntable centre)—and for this to be done the cartridge must be in position in the headshell. Carelessness over setting-up can easily leave you with an extra degree of tracking error—even more—but it is not difficult to get it right.

It is a criticism of some otherwise good pickup arms that they lack facilities for simple adjustment; and one can also criticise some manufacturers because they give such scanty setting-up instructions and make no reference to the use of an alignment protractor—an essential tool when you fit a universal arm. You can buy or make such a device (see illustration). Of course, the headshell may have slots for the cartridge screws, permitting fore-and-aft cartridge adjustment, ostensibly for setting the stylus overhang with respect to the turntable spindle, but that is not the same thing as an adjustment at the pivot point. An ideal arrangement is seen in the SME arm: the pedestal can be moved, in relation to the record, upon its previously installed mounting plate.

However, most pickup arms have a simple pedestal barrel containing the pivot or bearing and one is advised to make a hole in the board at some distance indicated by a template. Use the template, by all means, but then form an elongated hole that will permit adjustment towards and away from the turntable centre. Make some comparable provision if mounting demands several small holes instead of one large hole.

Before the setting-up jobs can be done, the cartridge must be mounted in the headshell, with due attention to any special instructions. For the initial jobs you will be wise to take the precaution of removing the stylus assembly—or protecting it with a cover if it is not of the push-in type. In general, a magnetic cartridge should have its upper surface parallel to the inside of the headshell and it should be squarely fitted so that it lines up with the fore-and-aft axis through the shell. Look at it from the front also, and check that the cartridge and stylus are vertical. Precision in these respects is as important as it is in final arm adjustment. Ensure that the fixing screws do not show beyond the bottom of the cartridge, lest they touch the record. You should again check the cartridge as seen from the front when the entire pickup has been set up. It may be possible to rotate the head on the arm if there is some discrepancy, or to insert some very small piece of packing above the cartridge if no other way can be found to correct an error.

Examples of electrical connections are illustrated, and the most usual arrangement is a four-wire termination using this colour-code: red for right-channel live; green for right ground or 'earth'; white for left live; blue for left ground. Cartridge pins are often marked in an obvious way, such as L, R, LG, RG, or they may have appropriately coloured markers. Make the connections, ensuring the terminals are an adequately tight fit on the cartridge

pins, though only very moderate force should be used in handling such delicate parts. If necessary use small pliers or tweezers to ease or tighten the terminals after trying them for fit. On no account use a soldering iron on the terminals while they are fitted to the pins. Other electrical matters are dealt with later.

### **Final adjustments**

With the stylus refitted and the headshell in place on the arm, set the tracking weight to the expected figure—an operation that usually involves balancing out the pickup (arm horizontal) by adjusting the counterweight, followed by application of the downward pressure using whatever device is fitted. Then adjust the pickup height until the arm tube is parallel to the record surface. This of course is checked with the stylus resting on the record ; hence the precaution of setting the pressure to a figure that is about right.

Once this has been done it is possible to make that important final adjustment of lateral error. This is done with a record in place. With the alignment protractor in position, move the pickup and protractor as necessary to make the stylus tip reach the cross or point marked at  $2\frac{3}{8}$ in. from the turntable spindle. When this is done the axis through the headshell/cartridge should be exactly parallel to the lines on the protractor. If this is not the case, lift the pickup and move the arm pivot point (the pedestal or base) a little within the oversize hole, the mounting having been left loose to permit some to and fro jiggling. Once accuracy has been achieved with the aid of the protractor tighten up the pickup mounting. You should check all this again if ever the cartridge has to be moved or when you fit a new one.

The importance of precision in these final adjustments was pointed up by a number of tests and measurements carried out by *Hi-Fi Sound* on various commercially available arms. In certain instances, strict adherence to manufacturers' setting-up instructions without further checks would have led to small but unnecessary errors, and the users would have remained unaware of these if proper checks—notably that with the alignment protractor—had not been made.

With height checked and the pickup in its optimum position, it remains to set the tracking weight to optimum, taking into account the bias (natural side-thrust under working conditions) which, as mentioned earlier in this series, should be neutralised if a modern, light-tracking pickup is to give of its best. Practically all the expensive hi-fi arms, and most of the cheaper models, have bias correction devices of some kind (and a costly arm is not really acceptable these days unless it is so equipped). Devices using suspended weights, lever-actuated weights or magnets are in common use and generally found satisfactory; the magnetic type is particularly satisfactory because it introduces no friction of its own. A bias corrector has to be adjustable if it is to be of any use for precise setting at low tracking weights. (A non-adjustable device may be found on a cheap player and may be accepted at that price level, bearing in mind that some attempt to correct bias is likely to be better than none.)

The amount of bias correction needed (i.e. outward pull on the arm, away from the disc centre) depends on stylus tip size, and an elliptical tip, with typical minor-axis radius 0.0003in., requires more correction than does a half-thou. spherical tip. Again, the correction to be applied is substantially the same across the disc—fortunately for simple design. It should be clear that if the bias remains uncorrected, some extra downward pressure will be needed to overcome the sidethrust—so a very careful look at this matter is worth while for every user of hi-fi pickups. However, if the arm has pivot friction competing with the bias force, attempts to correct the bias will be

confusing and pointless; and if the bias corrector introduces friction, it will be difficult to make sense of adjustments.

### **Tracking weight**

What about the universal arm that has no bias corrector but is otherwise of good quality? The user should study the specification accompanying the cartridge and note the recommended range of tracking weight. If this range were, say, 1½-3gm, the user could start at about 2gm and, if necessary for secure tracking, adjust by very small increments but without exceeding the specified maximum. It is unlikely that any improvement in tracking ability would follow from further increase of tracking weight and in any case it would probably cause non-linear operation. An apparent need for unexpectedly high tracking weight most likely points to the unsuitability of an arm or reveals a cartridge fault.

We can proceed on the understanding that the enthusiast has a pickup with adjustable bias correction and that the arm is well suited to the cartridge. This is the right moment to raise an objection to the expression 'anti-skating' which is thought by many people—including some manufacturers who should know better—to be synonymous with bias correction.

If there is serious *skating* of a stylus across a record—it sounds a very damaging as well as spectacular process!—there is something wrong with the equipment. It has nothing to do with bias, and a bias corrector cannot overcome such a fault. If the pickup hops run-in grooves this may be due to a fault; and again, the bias corrector cannot cure it.

Perhaps the 'skating' idea is due to the use of blank discs for tests, but a blank surface, while providing a safe skating-rink for the stylus, is of little value in setting-up operations. The stylus should be in a groove if anything is to be learned about pickup behaviour, but few people can confidently say they have minimised mistracking effects if they depend on making adjustments while they listen to musical sounds.

For optimum setting of tracking weight and bias correction—the one with the other—a dynamic test *is* needed, however, and the appropriate test tones are provided among the test bands on Hi-Fi Sound test disc HFS69\*. With careful adjustment of pressure and bias correction by very small steps, the user, inexperienced or professional, can find the optimum setting. Increasing the tracking weight beyond this figure is not likely to provide any improvement in tracking ability. Any subsequent slight mistracking symptoms on music (momentary splutter or blurring), though often hard to detect and in any case occurring only infrequently, may well be showing up basic limitations of the pickup or the sheer awkwardness of some records. Such effects do not necessarily reflect on the user's ability to make tests and measurements.

There is a world of difference between the performance of a precisely adjusted pickup and that of a component set-up by hit and miss methods. Moreover, experience with the dynamic test mentioned here has shown that the instructions supplied with some pickup arms are unlikely to lead to optimum performance with popular high-grade cartridges. It may be found that the bias correction has to be greater than that suggested in the instructions.

---

\* HFS69 is distributed to the record and hi-fi trade by Howland-West Ltd. It can be obtained by post, when stocks permit, from: Distribution Dept, Haymarket Publishing Ltd, 34 Fouberts Place, London, W1. Price £1.63 including postage and packing.

Unfortunately some users have concluded that there is something wrong with the test if the pickup instructions can no longer be followed to the letter! The right approach is to find the optimum conditions by a realistic, dynamic method, and to ignore the setting-up instructions if they conflict. The aim is to use the test disc to test the pickup, not to find out whether the test disc is playable under some vague set of conditions. Of course, if an obviously absurd state of affairs emerges after precise use of the test, then you may well have the test method to thank for pointing out to you a cartridge or arm fault of which you were not aware.

When checking over a pickup, either during installation or later, inspect the arrangement of the thin lead-out wires where they pass round or near the arm pivots. In some components the wires may have a small influence on bias. If the wires run clear of the pivots in a small loop, ensure that they are correctly twisted and unable to foul any part of the arm. If they run within the pivot housing you may be able to gain enough access to them to see that they are not so strained or disposed they could effectively introduce friction.

### Connections

Electrical connections between pickup and amplifier should offer no serious hazards. A complete player may have screened leads already fitted, or its pickup leads may be terminated under the baseplate. In the latter case check the colour-coding and continue the connections in the form of two screened leads (of low-capacitance coaxial type) to the amplifier, where the L and R inputs will probably require phono plugs (or a DIN plug in some instances). Some made-up signal cables with phono plugs fitted are commercially available and will save the bother of at least part of the soldering routine. For example, one long cable with a plug at each end can be cut in the middle to make the leads for the two channels, but they will be without L-R identification unless you mark one lead or plug.

Several of the best separate pickup arms have all leads provided, most likely with a plug-in connector at the base of the arm pedestal, but if a length of lead is hanging from the pickup pivot housing shorten this until it is just long enough to reach—via a loose loop—a tag-strip which you can fit under the mounting board close to the arm fitting. Then carry on with screened leads to the amplifier.

With all work on pickup connections remember that the high-frequency performance of magnetic cartridges is affected by lead capacitance. Therefore keep the leads as short as possible. The player will normally be close to the

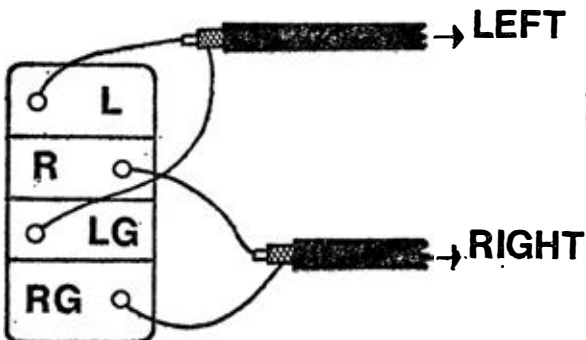

*Screened lead connections are carried through to the amplifier.*

amplifier and this should enable you to keep the lead length down to about 3ft. Even at this length the capacitance introduced may be in the region of 150pF-200pF per channel, and that caused by much longer cables is likely to prove disadvantageous, possibly creating high-frequency resonance effects. A couple of commercial arms with over-generous made-up cables introduced capacitance of around 500pF, an excessive amount and evidence that leads should be shortened to the minimum practical length.

The remainder of the 'load' applied to the pickup is that imposed by the amplifier input. Readers who have studied the matter even superficially will have gained the impression that the usual load is 47kohms on each channel (see the amplifier specification), and indeed that is the figure recommended by most manufacturers of moving-magnet, induced-magnet and variable reluctance cartridges. It is difficult to see why a few amplifier designers insist on higher figures (e.g. 56k, 68k, or even 100k).

In this context it is worth noting that response measurements show differences in high-frequency response when the load impedance is varied. Then the cartridge inductance comes into the equation: it tells us about the cartridge's susceptibility to variation in response with change of load. This is a difficult area for most users, but it is a reminder that there may be every good reason to use a 47k input and to query the effect of using a higher-value input. It is for the amplifier manufacturer to explain why a high-value load is chosen in the face of clear recommendations by the cartridge designers.

It will be appreciated that the essential connections between pickup and amplifier consist of live and ground for the left channel and the same for the right channel. Physically these will comprise two screened leads, the live conductors being the inner wires. However, a separate ground connection is normally required from player to amplifier, and on the latter unit there may be a special 'earth' screw to take the extra wire. If not, the connection can be made to a screw in the metalwork of the case. The amplifier itself may or may not be intended for earthing to the mains, via the third pin of the supply. The test is of course the elimination of hum.

At the player end of the chain the usual arrangement is to connect the

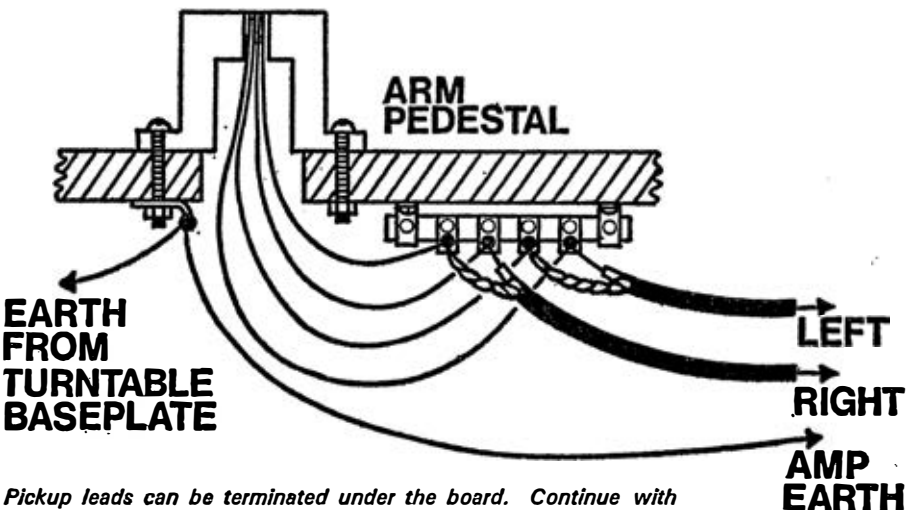

*Pickup leads can be terminated under the board. Continue with coaxial cable and make an appropriate earth connection.*

earth wire from the turntable metalwork to the base of the pickup arm (under a screw) where these two items are separate, and then on to the amplifier. The extra wire is not needed when the outer signal-lead screens have made efficient contact with player metalwork.

What is to many users a baffling cause of hum is the 'hum-loop' set up by incorrect 'earthing' in the pickup circuit. The cartridge will have a metal screen that probably makes direct contact with the headshell, and if the latter is metal there is a ground connection through the arm. The hum-loop may be set up when the cartridge screen is linked to an 'earth' pin but can be interrupted by breaking the connection to the screen. But first remove the earth wire to the amplifier—before becoming involved in greater complication. The main thing to remember is that we require only one earth route in a pickup circuit.

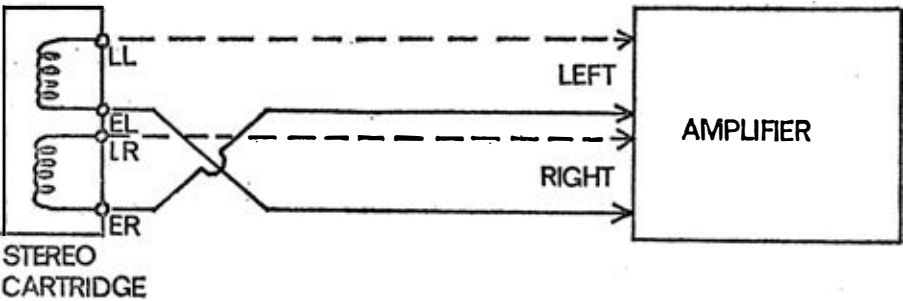
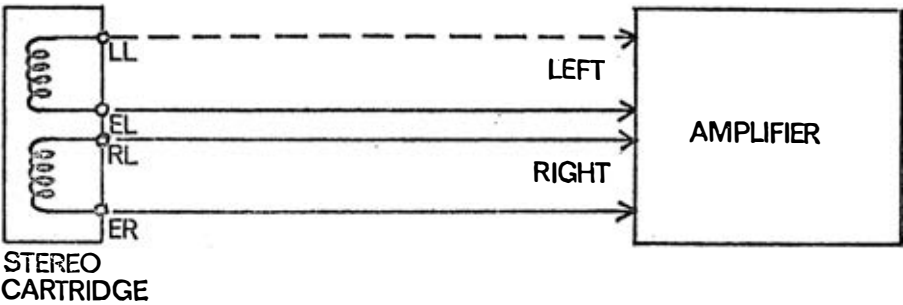

*One possible cause of noise—crossed terminations.*

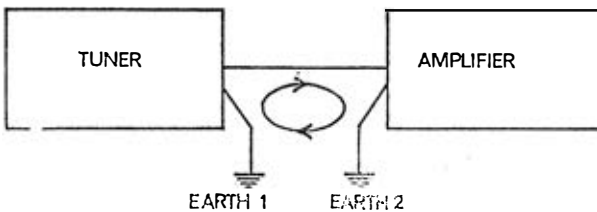

*Hum loop. Remove one earth path to break the loop.*



# 3

## INSTALLING HI-FI—II

FOR MANY users the installation of a new amplifier or receiver is simplicity itself, especially if prepared leads have been supplied and no soldering is needed. There are no tricky installation points or adjustments comparable with those arising when fitting separate turntables and pickups, which have been covered in some detail and with emphasis on the need for precision.

Study the instruction manual before anything else. If the amplifier has a mains voltage adjustment in its power supply section ensure that it is set to the appropriate voltage. Check that suitable mains fuses are fitted in their holders (probably at the back of the unit or inside) and carefully fit the mains plug to the mains lead, connecting the third (earth) wire if a three-wire cable is supplied. Earth connections from the player, etc. should not be made directly to the mains earth but will be routed via the equipment interconnections, the object being to avoid a situation leading to hum, as noted earlier. If your house has the ring-main system with fused plugs, fit an appropriate fuse of lower rating (say 5-amp) than the 13A that will probably already be in the plug. The amplifier may have outlets from which other equipment (turntable, tuner) can be powered. If not, make a distribution point at a convenient place (inside a cabinet, for instance) so that only the one cable goes to the supply point on the wall.

The installation of electronic units is largely a matter of making efficient connections and minimising noise by using the correct plugs and wiring and paying special attention to the screening of signal cables. Keep mains leads away from pickup leads. Connections for inputs and some outputs are usually via either phono plugs or DIN connectors, the latter being particularly fiddly where several soldered connections have to be made within one plug. Jack plugs may be used for headphones and, occasionally, for other items. Loudspeaker outputs may be via screw terminals, spring-loaded terminals or DIN connectors, the latter being non-reversible and thus aiding your check on phasing while making it difficult to hook up extra speakers for experiments, etc.

Thus there is no standard interconnection scheme for audio equipment—and plenty of scope for authorities who advocate standardisation. Some

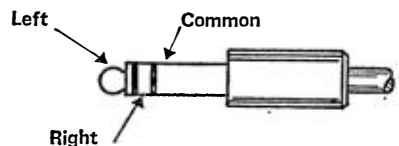
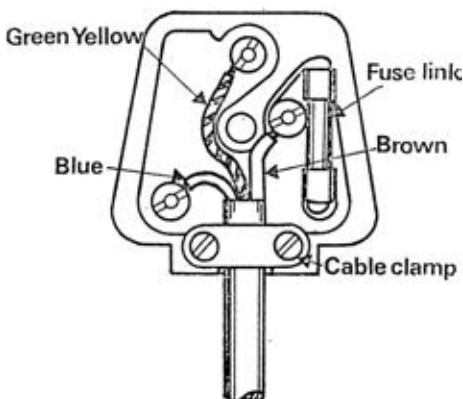

*Left: correct wiring in a British Standard 13A plug. Above: jack plug.*

standard DIN configurations and other common connections are illustrated. Be warned that equipment manufacturers may have their own ideas about connections in DIN plugs and sockets, but such deviations from standard practice will be set out in their instruction manuals. (DIN stands for Deutscher Industrie Normenausschus, the German standards organisation.)

Apart from loudspeaker leads, all signal cables to and from the amplifier, receiver, tape unit, etc (pickup input, tuner input, recording output) must be of the screened type, and the screen (outer conductor formed from braided copper wire in the coaxial construction) must be correctly bonded to the plugs. This usually involves a simple job of soldering for those who make up their own leads. In general, signal leads should be kept as short as possible.

However, a variety of made-up leads, fitted with plugs of common types, can be obtained from hi-fi specialists and components shops. Nowadays there are ranges of packeted interconnecting leads—phono and DIN terminations predominating—and some accessory suppliers devise 'conversion' leads enabling the user to take a signal from, say, a DIN outlet to a phono input. When choosing made-up leads there is no point in selecting an over-long example, neatly fitted with plugs, only to be faced with the task of shortening it. However, when seeking a pickup lead it is a good plan to buy a single long (about 5ft) signal lead with a phono plug at each end, since it can be cut in the middle to make a connector for each channel.

Speaker leads should be lighting flex. The ordinary twisted plastics-covered 5A variety is suitable for the moderate runs, typically 10-20ft, involved in domestic rooms. Even better is the equivalent flat or round twin flex with differently coloured insulations and an outer covering, since this kind reminds you 'which way round' and thus enables you to keep the speakers correctly phased. However, there is no real problem with the single-colour flex because, once you *have* phased the speakers (a point yet to be covered), you can mark the ends of the flex so that the connection can always be the same even if you disturb the wiring and have to reconnect it.

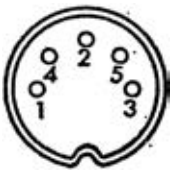

5 Pin Type A



5 Pin Type B

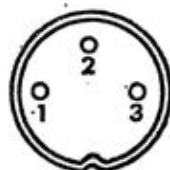

3 Pin



Loudspeaker Plug

*Types of DIN connector.*

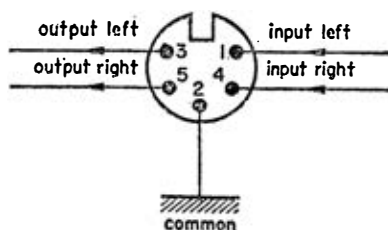
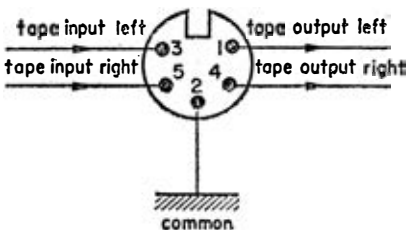

*Examples of connections to DIN socket, view towards socket holes.*

Avoid extremely thin flexes as the resistance will be too high and you will lose some output power. Lighting flex can usually be concealed for much of its run—under carpet edges or even under the floor if construction permits. If your hi-fi planning coincides with major domestic renovations or (ideally) the building of a new house, consider the advantages of concealed wiring with outlet points for speakers. The sockets should of course be different from those used for mains electricity! A small, robust two-pin fitting is the obvious answer. In these circumstances the cable from the FM aerial also might be built in.

Unusually long runs of speaker lead, as might be required to reach another room, should be of heavier cable if the total on each channel exceeds about 30-40ft. The idea is of course to keep the resistance of wires to as small a fraction of the speaker impedance as possible. Non-professional enthusiasts sometimes use equipment in halls or very large rooms, and here again special care is necessary since the conditions are likely to be such that every watt of power is needed. The equipment is often transportable, with the cables set out for temporary use, and it is wise to use heavy power cable which will resist damage and at the same time cause the least loss.

### Loudspeaker matching

Speaker impedance was introduced in *Introduction to Hi-Fi* and a further explanation was offered in *Hi-Fi Planning and Buying*. It was explained that a typical speaker impedance characteristic has several ups and downs, affecting the ability of the amplifier to deliver its power at certain points in the frequency range, and that the nominal impedance (that applying at a particular frequency) is quoted to enable the user to match the equipment.

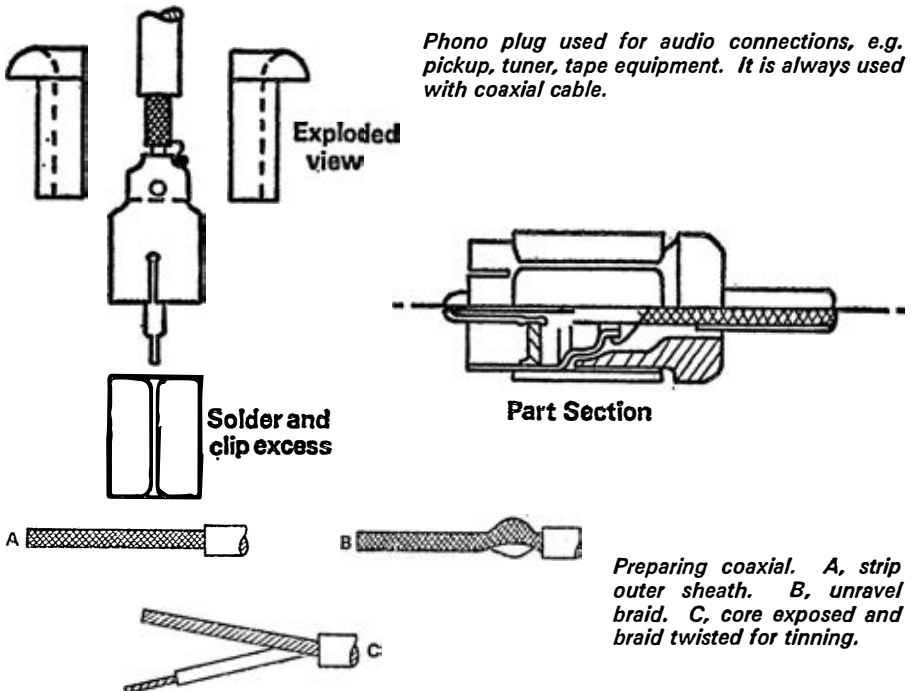

A gross mismatch causes a loss of available power, but really there is no excuse for creating such a situation.

Very many transistor amplifiers are designed to deliver the rated power into 8-ohm speakers—one on each channel. This simple matching requirement will be apparent from study of the specification data or the instruction manual. At this stage of the installation, if your planning and buying were without fault, you will find yourself with a pair of 8-ohm (nominal) speakers and an amplifier of the kind mentioned. You connect speakers to amplifier and that is that.

If some other matching impedance is specified, you should work to that figure. Some equipments, possibly applying DIN standards, employ 4-ohm matching; so you have to use speakers of that nominal impedance since that is their figure for optimum power transfer. Do not connect 4-ohm speakers to an amplifier or tuner-amplifier that has a spec centred on 8 ohms unless the instructions give the go-ahead. If in doubt, ask the amplifier manufacturer for specific assurances. Some amplifiers do not work happily into unusually low impedances. The position is usually different with valved amplifiers, for these incorporate output transformers and have adjustable tapings to suit various impedances, e.g. 15,  $7\frac{1}{2}$ , 4 ohms.

Do not experiment with speakers, their wiring or the connections while the amplifier is switched on. Do not switch on with speakers disconnected, and be careful not to short-circuit the outputs (unkempt wire ends touching across terminals constitute a short). The penalty for mistakes is usually a tripped circuit protection device or a blown output fuse, but there might instead be damage.

Some users like to be able to switch to additional speakers, possibly arranging to enjoy sound in two rooms. Many amplifiers provide the facilities—typically switching between two pairs with another position for simultaneous use. Simply follow instructions.

Of course, a look at the text-book will suggest that we can have an amusing time connecting up speakers in series and parallel or a mixture of the two, finishing up with a number of speakers and a total impedance to suit the amplifier. If you connect loads in series, the total impedance is equal to the separate impedances added together. Two 4-ohm loads in series make 8 ohms, and so on. Connecting two similar speakers in parallel produces half the impedance—e.g. two 8-ohm speakers then present a total of 4 ohms.

Unfortunately this is an area in which exploitation of simple theory can produce results that are highly objectionable or even damaging. Series connection is in any case out of the question, for it tends to turn hi-fi into lo-fi. The advisability of putting them in parallel depends on the total impedance produced—and on the behaviour of the amplifier. Do not experiment on the basis of inadequate knowledge, and *do* consult the amplifier manufacturer before doing anything that is not in accord with the instruction manual. You have been warned!

To use one pair of speakers *or* another pair with an amplifier that has no built-in switching you could connect via a double-pole changeover switch (a components supplier will advise if you tell him what you plan to do);

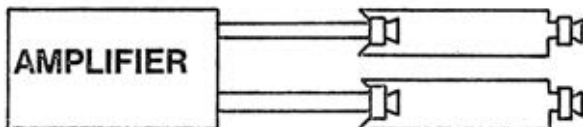

*Speakers in parallel. Two similar speakers produce half the impedance.*

or you could use a switch/control box of the kind made for those who favour different outputs such as alternative speakers and headphones.

If the amplifier has a 'centre-channel' output for a third speaker, use it strictly in accord with the manufacturer's instructions. If surround-sound experiments involving one or two extra speakers are to be undertaken, consider first the possible effects on the amplifier. Finally, many amplifiers will not work satisfactorily with electrostatic speakers—but that of course is a matter to be studied at the planning stage.

### **Loudspeaker phasing**

The terms 'phasing' and 'phase' are applied in several ways in audio and elsewhere in electronics. Phase relationships are important to the designer of multi-unit loudspeakers, but that aspect is of little concern to the ordinary enthusiast unless he is constructing his own speakers—and in that event he should follow the maker's instructions in respect of positioning and connection of drive units used in the system.

In the present context we are concerned with the phasing of two (or more) complete speakers used for stereo or mono. Accurate stereo reproduction requires that the speakers should be in phase (in step, so that the diaphragms move in and out together on receipt of a similar signal). If they are out of phase there will be some lack of definition of the stereo image and some effect on the tonal balance, probably showing up as unsatisfactory bass—faults that will be either very marked or rather subtle, depending on the type of speakers and the qualities of the records played. Complaints about stereo sometimes arise simply because phasing has not been established.

The procedure for correcting the phasing could hardly be simpler. If it seems wrong, switch off the amplifier, reverse the wires on the terminals of one speaker only (leaving the other speaker as it is), and try again! However, some people like to introduce science into the routine, and there are test-bands on certain stereo test and demonstration discs. The disc may also be more generally useful with the inclusion of setting-up tests such as *ch* identification and pickup tracking.

If you do not use a test disc, play an ordinary record—preferably instrumental music or speech—and switch the amplifier *to mono*. There should be a well-defined image between the speakers if the phasing is correct; but if the image is broader and the definition is even worse if you move your head about, the phasing is incorrect. For this test place yourself on the centre-line between the speakers and at a normal distance from them.

Phasing checks are not so easily or quickly made with some omni-directional speakers, especially since the stereo they provide is not very well defined even when the phasing is correct. However, it is best to go through the motions, listening to the bass for signs of thin response versus the expected fullness.

It may occur to the reader that this little job of checking the phasing would not be necessary if all equipment could be supplied wired according to appropriate conventions. Indeed, the phase relationship will have been attended to in a complete 'packaged' system. Even a number of separate units from different sources may be marked in some way, possibly with + and — against amplifier terminals and colours on speaker terminals. The indication of 'polarity' means nothing since the signals are alternating, but the marks are your guide to the correct relationships. Then it is still advisable to check phasing with a listening test when installation is complete. When wiring up, the use of coloured wires in the speaker flex will be helpful, but without this it is of course a simple matter to mark the wires and terminals when phasing has been made correct. You can then return to the correct

condition without further tests if you disturb the wiring.

Incidentally, left/right channel identification is another test that will be made to check the installation, and a test disc may be used particularly to confirm that the pickup wiring is correct (the point where an error is most likely to be made). However, few listeners would be in doubt about left and right after trying a few records, bearing in mind the layout of instruments in orchestras.

### **Positioning your speakers**

Although some guidelines can be suggested, the enthusiast installing his equipment should experiment with loudspeaker positions until he is satisfied he has achieved the most likeable results possible, bearing in mind the size and shape of room and the arrangement of furniture. There are probably few people who are prepared to reorganise the contents of rooms for the sake of stereo, and usually a number of matters affecting domestic convenience must be reconciled with the demands of sound reproduction. For most people there will be only a few possibilities, but even small adjustments can make an audible difference and it is best to experiment during a week or more following initial installation. Defer the tidying-up of flexes and other details until enough has been learned.

Twin aims are accurate stereo and optimum tonal quality. Enthusiasts will expect the positions of the speakers to influence the stereo presentation, and they will not be surprised to find that one arrangement provides a realistic sound-stage, well filled with detail, while another seems less convincing. It is often less well understood that bass/treble balance also is influenced by speaker placing and that one's impression of speaker quality—at the

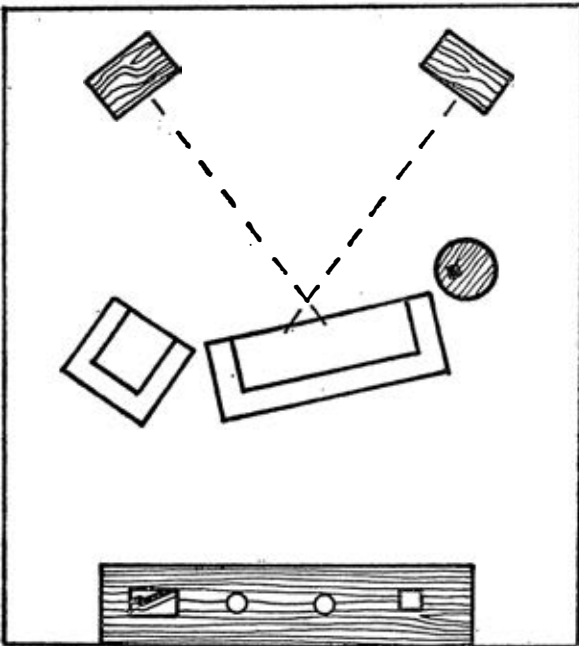

*Basis for experimenting with speaker and seating positions.*

bass end, especially—may be revised considerably after some experiment. What we hear is not just speaker sound but the speaker output influenced by the room and its contents. (The way to avoid room effects and gain yet another impression of sound quality is of course to use headphones!)

In typical rooms the speakers may be about 7-12ft apart, depending on size of room and proposed listening area, and they will be angled inwards to some extent. If bookshelf or other 'compacts' are used they must be mounted at a sensible height. Obviously they cannot be on the floor: not only will they look ridiculous but much of their high-frequency output will be lost in soft furnishings. They can be on shelves, bookcases or various items of furniture—one on a sideboard, say, and the other on a window ledge.

Avoid any arrangement that will place one speaker appreciably higher than the other, and do not place the pair much higher than your head will be when you are seated for listening. All this is still subject to some adjustment, and it may be that compact speakers could be supported on small stands or tables at a somewhat lower height than is conventional, provided there is an uninterrupted view of them from the listening area. It may be rewarding to try tilting speakers slightly, depending on details of mounting, adjacent furnishings, etc.

Wall furniture has become popular and a well thought-out assembly can accommodate all manner of possessions including books, records, television and, of course, hi-fi. The advertisements often show neat, space-saving layouts which display everything to best effect—and with scant regard for basic requirements. What about hum pick-up when the amplifier is so close to the player? Can one loudspeaker *really* be three inches from the pickup without provoking a howl of protest (in the form of acoustic feedback)?

The point that concerns us at the moment, however, is the possibility of placing the speakers the right distance apart and angling them in towards the listeners. Clearly, if they are as deep as the shelves they will look awkward when turned at an angle, and they may even be unsafe. There is a story about the daily help who arrived in the mornings to find the speakers pulled out, corners overhanging shelves and flex showing. Each evening when the owner returned he found them dusted and neatly squared up, with a decorative ashtray on the right-hand channel. This little fight between stereo and a sense of what is right and proper continues to this day—in silence, for neither side has seen fit to mention the matter.

Obviously, very compact arrangements are chosen because there is a space problem, and it may be that ideal speaker positions cannot be found. In that case it is better to have good sound, with something less than ideal attention to detail, than no sound beyond that provided by an all-in-one record player. However, for a small room it is possible to find pleasing small speakers—smaller than one cubic foot—that can be adjusted and angled as required. In the extreme case speakers can be mounted on the wall, though this will prevent adjustment unless some kind of swivelling bracket is devised.

For a medium-sized to large room you will probably have chosen free-standing loudspeakers, and like most people you will find that the number of possible locations is strictly limited. In a rectangular room a couple of corners may seem tempting, and you may visualise the speakers in this unobtrusive arrangement looking down the length of the room. This would have the advantage that no difficulty would be encountered in placing the listening area well down the room—farther than the distance between the speakers.

Unfortunately we have room acoustics to contend with—and a naturally plummy bass sound from the speakers too, in some instances! Room corners give bass response a lift and, although some users of small speakers

have reported their liking for this reinforcement (the only thing we get free in this hi-fi business), there must be many more who have had to reject corner positions on account of over-emphasis of bass—an effect amounting subjectively to unrealistic muddle when strong resonances (eigentones) grouped at the bottom of the audio range are excited. Recent experience with popular speakers of the total-enclosure type has shown how serious this colouration can be. Moving the speakers out of the corners a short distance (a foot or more) makes a considerable difference.

Placing the speakers against a long wall, away from corners and looking across the shorter dimension of the room, may be the solution for many people, but care must be taken to ensure a convenient area for listening can be obtained at adequate distance from the speakers. Here, as always, it is necessary to experiment with inward angling and the spacing between the speakers. It has already been suggested that spacings of 7-12ft are typical. Too close a spacing will not give satisfactory stereo for listeners seated at a sensible distance (and very close listening to hi-fi is not recommended); too great a spacing is likely to cause a recessed stereo image, lacking central information. Real stereo has a lot more to offer than pronounced left/right information, and there is something sadly wrong with any set-up that reduces everything to obvious twin-channel effects.

The 'hole-in-the-middle' effect, of a serious kind caused by recording defects rather than speaker spacings, led some manufacturers to advocate the use of a third, central speaker to augment the stereo activity by radiating L plus R information at a low volume level. All this amounts to is acceptance of bad recordings or bad speakers—or both. Properly engineered stereo reproduced by good equipment has no hole in the middle.

Misunderstanding about basic requirements seems also to enter into the advocacy of omni-directional and semi-omni speakers. Incidentally, true omni speakers do not have to be specially angled in the way described here, but in some there are special features of design that lead to specific positioning requirements that will be made clear by the manufacturers concerned.

Good stereo may be obtained with the speaker axes crossing on the listening area or in front of it. Much depends on the quality of the speakers—above all their distribution pattern. With some speakers of very high quality there is surprisingly little difference between angled and squared-up arrangements. Do not take it for granted that front-facing but inward-angled speakers will be unlikeable just because they point straight at you. Some *will* be, but that is a criticism of their quality and you will not make them better speakers by avoiding their hf output.

Do not adopt just one arrangement because you have had it recommended to you. Instead, experiment by playing a record—a suitable test disc if you have one—and studying the stereo image; adjust the inward angling with a view to establishing a uniform, stable image and some freedom of movement within the listening area. You should not be rooted to one spot for stereo: it should be possible for several people to settle down in the listening area and hear good separation and a lot of detail. Establish the best possible arrangement and try it for a few days with a selection of records and stereo broadcasts. If necessary make minor adjustments on the basis of what has been learned.

If there is any consistent one-sidedness about the stereo you may find the answer is to adjust the angling of only one speaker—if the cause is reflections in the room. On the other hand there may be a need for slight adjustment of the balance control. A large re-adjustment of balance is likely to be a sign of malfunction in the equipment and should be investigated.

Some high-grade speakers are supplied in 'mirror-image' pairs, having



their mid/high units disposed on the inside part of the baffle (left speaker with units to the right, and vice versa). The idea is to influence the distribution pattern and keep output away from adjacent reflecting surfaces.

Finally, you will soon come to appreciate that furnishings influence tonal quality and balance. A good combination is a solid, carpeted floor and a generous selection of soft chairs and curtains. A fairly 'dead' room is better than a hard-surfaced room with few soft, absorbent materials. If you add materials to take some liveliness out of the room, do what you can to provide similar conditions for the two speakers. A great deal of soft material near one speaker, and a hard surface near the other, will produce a lack of balance. A curtain or drape extending behind both speakers is effective, and the proposal will suggest to many people a speaker location near a long window with the heavy curtains pulled for a listening session on a long winter evening! Special acoustic tiles can be used for control of room acoustics, but please note that they do not insulate you and your hi-fi from the neighbours.

Structural resonances sometimes give trouble and may call for major alterations to the fabric of the building if complete satisfaction is to be obtained. Resonances in wooden floors are more readily tackled, and the need for greater solidity—and the means of achieving it—will be fairly obvious. As for the speakers, altering their contact with the floor (by fitting short legs, say) may give an improvement without much attention to the floor, and repositioning may be necessary. Another trick is to stand the speakers on blocks of foam rubber.

Experience has yet to be gained with speaker arrangements for quadraphonics and surround sound. A genuine four-channel high fidelity system would involve care in positioning of four speakers, just as in twin-channel stereo installations. Speaker height becomes a more important factor with some kinds of system.

A postscript. Do not judge stereophony on the basis of a much-used collection consisting of three records. Some experience with a wider variety of material is needed for an appreciation of what is possible and what the shortcomings may be. The same argument applies to quick criticisms of smoothness, possible mistracking and various distortions. If you have only a very few discs they *may* all be bad ones! Do remember that there are considerable differences between modern recordings.

### **Acoustic feedback**

The transmission of vibrations from speakers to player, via the equipment mountings or floor, can disturb the pickup and may provoke continuous oscillation, known as feedback. Generally it is best to site the player and amplifier well away from the speakers as a precaution, and anyway that is the most convenient arrangement if one sits near the controls and listens at a fair distance. With a solid floor there will probably be no need for further precautions, although in difficult cases the turntable/pickup could be wall mounted, as already mentioned, to avoid structure-borne interference (mechanical feedback).

Where wall furniture is used, take special care over equipment mountings and the relative positions of the different items. Faced with more serious feedback problems the enthusiast should look at such matters as resilient mountings for the player or pads of rubber or felt under the speakers. If the player is to be treated in this way, the decoupling should be applied between the plinth and the board carrying the pickup and turntable, but these two components must not be decoupled from each other—a point that was explained earlier. In some cases it would be sufficient to stand the player plinth on pads.

## Speakers in walls

A really solid mounting requiring no cabinets: superior bass performance at low cost—these are obvious advantages of building a speaker into a wall. The idea was attractive for mono and it still appeals despite the lack of flexibility of the arrangement. Incorporating drive units in the structure in such a way that there is another room behind them will provide infinite-baffle loading, an acceptable solution if there is no objection to radiating sound in two rooms. The 'back' room can be a garage where this is part of the house. A very large cupboard is the next best thing, but in this case the door must be very heavy if it is to impose minimal colouration and there must be adequate sealing of edges.

Obviously it is only convenient to use a wall that is the normal thickness of bricks or building blocks. The bass (or wide-range) drive unit, typically a 12in. type, should be half-way through the aperture made for it—not facing into the thickness of the wall—and an airtight fit should be ensured by filling in around the chassis edge with suitable material after the unit has been positioned on lugs or in clamps. Alternatively, fit the unit to a small but massive baffle, and seal this assembly into the wall. The actual shape and details of the mounting will not matter a great deal if the apertures are masked by decorative but acoustically transparent grilles.

Now the neatest solution is a wide-range speaker unit such as a 12in. dual concentric for each channel, positioned at head-height for a seated listener. At the same time it is not possible to angle a pair inwards for stereo when they are solidly clamped and sealed into a wall. This is the main objection to the arrangement where stereo is concerned. However, it is permissible to mount bass-only units in the wall and mid-range/treble units in small

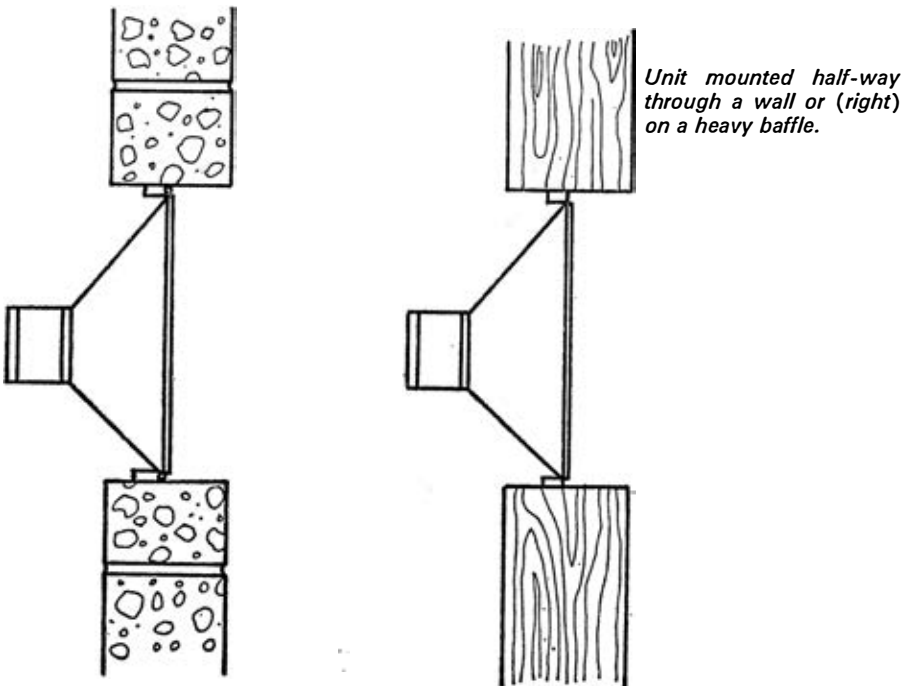

cabinets *on* the wall, close to the bass apertures. A crossover filter, one for each system, would be employed in the usual way. The upper-range reproducers would then be angled inwards as required.

Although systems of this sort have been devised, the lack of flexibility will deter many. There is the same objection to built-in enclosures of brick or concrete, though this approach keeps the sound in one room. To provide access to units, the enclosure tops can be made of very thick timber or slabs of marble. All such resonance-free mountings yield a low-range quality that is completely different from that associated with cabinets, and so it is worth weighing the snags against the obvious merits. Seek advice from leading drive unit manufacturers on choice of unit.

## **Aerials**

One of several claims that can be made for VHF/FM radio is that it provides sound of good quality against a silent background—at least for those receiving it within the service area of the local transmitter. Of course, there may be problems with fringe-area reception, an unsatisfactory signal-to-noise ratio being the most common, but to judge from the comments of some users one would suppose that the BBC's advice on the subject of receiving FM had failed to make any impact.

Indeed, many complaints about FM arise because users do not give their receivers a chance to work properly. Investigation of some of these reveals the use of lengths of wire or, at best, incorrectly sited aerials. Attention to the aerial is necessary for all users, but the solution is simplest for those who live near transmitters and receive enormous signals. For others more care is advised. Types of aerial range from simple indoor dipoles (you may find one packed with your receiver) to chimney-mounted arrays, a dipole in the loft being the happy medium for many who live within a service area. If reception is only just acceptable on FM mono with a given aerial, it will most likely be poor on stereo—another reason for lavishing some care on the installation.

The many possibilities cannot all be detailed here, and the enthusiast should seek advice from those with knowledge of local conditions. Well established radio engineers and components suppliers will often know what has been found satisfactory in your area. Where genuine problems exist—not those arising from hopeful efforts with pieces of wire—the BBC Engineering Information Dept. can advise (they are at Broadcasting House, London W1). If there are unusual local electrical interference problems it is worth trying the Post Office Engineering Dept.

The conventional FM dipole for Band II is a tuned device, similar in principle (but not otherwise) to that used for television. About 5ft across and mounted horizontally, it is made by several specialist manufacturers. If mounted in the loft, as is often the case, the feeder cable can be routed outside the house if necessary—down the wall and in through a window frame—but very long and tortuous routes should be avoided. The dipole must be turned to face the transmitter (i.e. broadside on to it). Experiment until maximum signal is received, then fix in position. Where local signal strength is very high a dipole in the listening room may be adequate, but correct orientation of the aerial is still a requirement. This may prove awkward in some instances; otherwise it may be possible to conceal the dipole while still aligning it correctly.

Typical British installations employ coaxial cable and aerial plugs of the coaxial pattern. The cable's inner wire and outer screen are connected to the inner ends of the dipole. The matching impedance is about 75ohms and the input is said to be 'unbalanced'. However, there are more imported tuners and

tuner-amplifiers than British ones, and these generally employ feeder cable of the flat twin type and have a matching impedance of about 240-300ohms. The 'balanced' system is common and the tuner input is a two-pin socket.

Consequently the need often arises to convert the one to the other—that is, to use the dipole and coaxial arrangement with the foreign tuner or receiver, using the latter's twin socket. Many users adopt the simplest solution where the input circuit permits, and this is to connect the inner wire of the coaxial to *one* of the sockets (or screw terminals if fitted) and the screen to an adjacent point on the metal case or chassis. The screen is braided copper wire, which should be unravelled, twisted, tinned and provided with a tag to fit under a screw. For proper matching, though, you need a device called a 'balun'—a balance-to-unbalance transformer which, being designed for radio frequencies, is small and inexpensive.

Some enthusiasts buy tuners that incorporate AM sections covering medium waves and possibly other bands, and they may sometimes like to pick their way through the jumble of stations and interference in a search for entertainment. A ferrite-rod aerial is a common feature of FM/AM tuners and tuner-amplifiers and will be found adequate for general use. This device should be broadside on to the station to be received, and if it is not on a swivel mounting you will have to move the tuner about for best results. Some users may wish to try a more old-fashioned device for their adventures in AM listening—a long-wire aerial, outside the house and rigged as high as possible. Whatever is done, the quality of sound will be anything but hi-fi.

# 4

## USING AND STORING RECORDS

---

THE DISC record provides the basis of hi-fi for very many enthusiasts, and therefore it is as well to include some notes on correct use, handling and storage. For instance there is the problematical subject of cleaning records. Too many collectors, scrupulously 'cleaning' what is not really dirty, almost literally kill their records with kindness. On the other hand they usually forget to clean the stylus tip. Then there are the many aids to record care: those that are helpful for the simple gramophone are not necessarily acceptable for hi-fi.

First a note on storage and the handling to which the disc must be subjected before it sees a pickup. Records are best stored at normal room temperature (or lower), or in any event where they are not exposed to damp or extremes of any sort. Protect them from dust by keeping them in their sleeves (extra outer sleeves as well if conditions seem to demand this) and store LPs vertically in such a way that they are properly supported but not jammed tight. Keep 7in. discs separate. Obviously a purpose-built cabinet is best because it provides support and excludes dust. The typical cabinet has compartments supporting, say, 20 discs in each—and, of course, doors. Record-sleeve openings should face the rear.

If your disc storage has no compartments, insert some packing at the end of the row to keep the records upright. As the collection grows, adjust the packing. To avoid uneven pressures, end the row with a 12in. square of wood and then put in the packing. Storage requirements for discs apply also to spooled tapes and cassettes as far as temperature and avoidance of extremes are concerned. In addition it is necessary to keep recorded tapes away from magnetic fields. Either a cabinet, a drawer or the equipment shelves—not too near the equipment—will be suitable.

Certain hazards are of course outside the influence of the customer, although he should voice his complaints without delay if he finds he has just purchased the results of someone's carelessness. The keen collector will learn what he can about record shops and mail-order suppliers. Some are better than others at weeding out such things as pressing faults and warped discs; but inevitably the occasional slightly imperfect copy will escape the notice of even the most observant supplier. There is some increase in the use of outer wrappings of the 'skin pack' sort, and where this kind of sealed packaging is used right through the distribution chain the customer does at least have an indication that a flaw reached the disc at the earliest stage of its journey.

### **How warped?**

However, warping and dishing are flaws that can occur at several stages and in various places—in the factory, on the way to shops, on retailers' shelves, in your car on a hot day, and in your home if you are careless over storage. One thing is certain: there is no such animal as an absolutely flat record. A nominally flat disc, acceptable to a discerning hi-fi user, is bound to have the slightest undulations, and in the average case you can see these if you look at the side of the pickup head as it tracks. This extremely slight effect will give no trouble.

A slightly worse example may still give no trouble but will be visually offensive. There soon comes a point where secure tracking is a problem

with many pickups. The actual results of attempted tracking of warped records vary according to the design and capabilities of the pickup, and some very good pickups are not perturbed by quite substantial warps—though that is not to say seriously warped new records are to be accepted.

A disc that has been in the collection for some time but has suffered warping may respond to a flattening treatment—careful pressing under a smooth surface or gentler pressure in a spring-loaded storage system, the latter taking some time and requiring occasional turning of the record until the warp has been ironed out as much as possible. The ‘pressing’ routine which some users report is reasonably effective involves placing the disc (without cover of any kind) between very clean pieces of glass and piling books on top. Extreme cleanliness is important here lest particles become embedded in the disc, and a summer temperature is necessary. However, heat must be avoided in all other circumstances. Do not leave records in an awkward position in a car, and be especially careful in hot weather.

Some critical enthusiasts make much reference to ‘swingers’—discs in which the hole is not central in relation to the groove. If slight side-to-side pickup motion can *just* be detected, the disc may still be within its manufacturing tolerances. In any case a high fidelity pickup should track a tiny swing without audible effect. Of course, a really serious lack of concentricity (up to five thousandths of an inch is the normal tolerance) makes a disc a reject.

As for the handling of individual discs, the time-honoured method must be mentioned. Perhaps everyone knows it—but not everyone applies it. Keep fingers away from the surfaces, and carefully release the disc from its inner sleeve, particularly where this is the plastics-lined sort that clings to the surfaces. It is not unduly difficult to withdraw a disc from an inner sleeve by crooking the thumb over the edge and extending the fingertips near to the label. Hold the disc by the edge when placing it on the turntable or removing it.

Keep the inners free from dust, or you may find small blemishes on the disc due to the action of especially abrasive particles. Return the disc to its sleeve immediately after use, and see that the openings of the outer and inner do not coincide. Putting the record down unprotected—on practically any surface—is a good way of collecting unwanted dirt. One surface you *have* to use is the turntable, so keep the mat clean. A removable mat is best as you can wash it.

An alternative inner wrapping can be made from a large sheet of plain, fluff-free paper. Cut it out so that it has a square middle part exactly the size of the record, plus four flaps that fold over the record, completely covering it. Obviously this offers an advantage in that it prevents any movement between record and wrapping. The record is lifted from the wrapper, not pulled out of an opening.

### **Crackle and pop**

We have looked at record storage requirements, the possibility of having to cope with a practically unplayable record, and the right way to handle records. Now we must consider what is supposed to be the most important part—putting the record on and enjoying the music. It is at this stage that many users express disappointment, not with the basic capabilities of their equipment but with the inferior signal-noise ratio that seems to plague the record reproduction. The ‘silent’ vinyl plastics LP is not even reasonably quiet, they report: it pops and crackles, bringing discredit to the whole idea of hi-fi.

They complain to their suppliers about suspected faults; they clean their discs and clean them again; so infuriated do they become that they make a special study of record manufacture, claiming that company X consistently makes better records than company Z. Of course, doubtful pressings do get through, and built-in gritty or rasping noises are bound to be reproduced by even the best and smoothest hi-fi systems. Obviously such faulty pressings can only be regarded as rejects.

But do not take it for granted that the finest audio systems are necessarily the most sensitive where disc noise is concerned. It is often thought that the use of expensive, delicate pickups and sensitive, revealing loudspeakers brings with it a penalty in the form of over-emphasis of pop and crackle. In fact the opposite is much more likely: a cheaper system, less smooth and with less accurate transient response, is more prone to show up quite tiny bits and pieces encountered in the groove of an average (not faulty) and reasonably clean disc. In any event a lot of the over-zealous cleaning—some of it positively harmful—that goes on is a response to sheer misunderstanding about hi-fi.

So we are faced with the problem of all those records that are killed with kindness. Let us be clear at the start: a large proportion of complaints about noisy disc reproduction arise from equipment incompatibility and are not directly related to the discs, whatever the buyer may think. Further, at least some of the advice given on the subject of record maintenance can be called into question for the simple reason that it is based on experience with systems that are something less than well-behaved; and it is to be expected that recommendations can be modified as equipment design progresses.

In particular, peakiness occurring in the upper range in pickups and speakers will emphasise small noises that would scarcely attract notice if the system had ideal smoothness and accuracy of transient handling. For many, this 'compatibility' question resolves into two searching glances at performance reports—one at the pickup and one at the speakers, to ensure that spiky-looking areas of response do not coincide! There is also the question of amplifier input overload, now receiving more attention than before. Distortion on input peaks is associated with inadequate handling of those transient signals—including quite big, spiky signals generated by non-musical disc imperfections.

It is not difficult to visualise the situation in which the record collector, trying to search out every last microscopic particle of foreign matter, cleans his discs too much, too often—and possibly the wrong way—while the equipment goes on doing its utmost to emphasise the slightest tick. If he has spent a great deal on the system, he may not be over-anxious to analyse possible flaws, especially those due to bad planning.

Constant cleaning may actually give a gradual deterioration of signal-noise ratio, though of course it depends on methods. Nothing abrasive, nothing wet, nothing messy—that's the rule for hi-fi. If the owner is plagued with excessive static charges, possibly due to local conditions—notably heat and lack of humidity—his frustration may be too dreadful to contemplate. In that event—dare we suggest it—he could store his records in a cooler place. . . .

The best that can be done is to offer guidance on basic methods, together with a warning or two, and urge the record user to start from there. If he has already ruined his records by cleaning them, there is probably nothing that can be done apart from buying new copies and making the right resolutions about caring for them. In this connection we might consider the good fortune of the man who can afford a large collection and must obviously have fewer opportunities to play (or clean) them all. They spend most of

their long lives under cover, away from dirt, and when they *do* come out for a spin they behave more quietly. The man who can afford only the occasional LP (perhaps he over-spent on the equipment) handles his records, and exposes them to contamination, a great deal.

Before the upsurge of interest in high fidelity stereo, and in particular before pickups were capable of tracking down in the 1gm. region where the stylus may glance off or go round bits of dirt in the groove, a lot of curious elixirs and generally messy 'cleaning' preparations were advocated. Indeed, some are still sold—to users of 'groove-grinder' gramophones, let us hope. But methods that may be thought acceptable for no-fi simply will not do at all for hi-fi. Prevention of contamination is our only hope: we have to guard against dust and ensure that nothing sticky ever reaches the record. At the hi-fi level we must remember that no preparation we can put on the disc will remove dirt.

Even that hallowed treatment, the 'barely moist cloth', sometimes recommended on record sleeves and elsewhere, is a non-starter. If it meant a subtle trace of humidity it would not be so bad, for at least it would offer the user a temporary relaxation of static (if that should be the problem worrying him). Unfortunately a greater amount of moisture will collect together traces of dirt which, having dried, will be right in the path of the stylus and ready to generate more noise. It should hardly be necessary to add that the application of anything more complex than moisture will be even more dangerous. Make music, not mud!

So any method that seems noticeably damp is certain to be too wet for safety. Sticky preparations, whether or not they are supposed to be anti-static, are even worse than H<sub>2</sub>O. And as pickups improve, tracking securely at ever lower pressures, you owe them—and your records—even more consideration.

However, we must spare a word for the tracking devices, such as Watts Dust Bug and Bib Groov-Kleen, which really do remove dust—for instance that arriving while the record is being played—and cannot do any harm if used according to instructions, though these tools of course are not the cure-all aids some people expect them to be. There are also a very few hand-held tools, the best known being the Watts Preener, designed for use on records in new condition.

Less easy to recommend are hairy or plush pads and the like, for although they may remove some dirt it seems inevitable that many people would misuse them by wielding them with a scouring action. Very odd indeed are little sweeping gadgets (on arms or attached to pickups)—brushes without dustpans, as it were. These, like the parlourmaid in the old story, are most



*Transcriptors Stylus Scales.*



likely to move dust from one point to another. Incidentally, the cautious use of dry dust-removing aids will demonstrate its value on some new records that have on them deposits of particles from packing materials.

Since the test of cleaning—how much, how little—is the presence of crackle and pop the hi-fi enthusiast, having installed his new system, should try some new records, remembering what was said earlier about smoothness of performance and the emphasis of noise. Remove superficial bits with the *gentle* encouragement of the simplest aid—perhaps a record-cleaning cloth, one of those specially made dusters, but not the heavily impregnated sort which comes under the heading of messy methods. All is quiet? Then don't spoil it with frantic cleaning! But *do* give some thought to the prevention of dirty conditions.

The author, before writing these notes, unpacked some new records and played them at a fairly high sound level. First, superficial flicking was done; afterwards, some strands of fluff on the stylus were blown away. In between, superb music and an enormous signal-noise ratio. Not one click or crackle. That was all the cleaning these discs received—and it is all they will get.

### **Exceptions to the rule**

Although damp conditions can leave you with a music-to-mud ratio, there are certain exceptions to the no-wetness rule. In fact if you have some thoroughly contaminated records, possibly fouled by sticky stuff or made noisy by microscopic mud, try washing them. It can do no harm and is likely to improve them. Do *not* use detergents. Slightly warm water in a bowl is all you will need for moderately fouled discs—but do keep the label dry. Use distilled water if the local water is very hard.

Gently scrub round the direction of the groove with an old Preener or any brush that, by the nature of its design, is certain to get down into the groove. Go round, carefully and gently, a second time. For especially contaminated discs use equal parts water and alcohol (pure industrial spirit is best), or a smaller proportion of alcohol if appropriate.

Thorough rinsing is necessary. Use slightly warm water and add a few drops of photographic wetting agent, which will overcome surface tension and ensure good results. The aim is now to dry the disc as quickly as possible—before any dirt can mix with the moisture. Lay the disc on a clean, fluff-free cloth and dab it dry. When it is absolutely dry, play the record and afterwards remove from the stylus any fluff that has been picked up. If this treatment has not considerably quietened a hopeless record, then either the grooves are damaged or the cleaning and rinsing have not been thorough.

Another exception to our rule is the wet-playing device (e.g. Lenco and Schweizer appliances). The method involves the application of considerable wetness (such as distilled water with alcohol) to the record by means of a brush-arm that tracks during playing. The deposits in the groove are thus suspended in solution while the stylus tip traces the waveforms. It is necessary to mop up at the end of each side. Not a great deal of experience has been gained with this method in the UK, but a few users have reported extremely good signal-noise in exchange for the rather messy procedure. It should be obvious that dirt remaining after playing will dry into mud, only to be placed in suspension again at the next playing. Thus the method is wet-playing, not cleaning. Once wet-played, always wet-played—that is the routine for all discs subjected to this method.

Finally, there are a number of professional cleaning services operated by record suppliers around the country. These use a special machine that wets, scrubs and dries the discs, leaving them thoroughly clean.

## The stylus

Viewing a stylus tip under a microscope offers a fair indication of record cleanliness. If any preparation has been applied, the condition of the tip may well give you an unpleasant surprise. Expecting to see a nicely shaped elliptical you may find a misshapen object, well encrusted and incapable of tracing waveforms in the precise way that was intended. Even in relatively good conditions there is some fouling due to atmospheric pollution (tobacco smoke, cooking vapours, aerosols and so forth) and regular cleaning should be a feature of hi-fi maintenance. For moderate fouling use one of the proprietary aids (e.g. Bib and Metrosound kits) but pure alcohol is more effective on stubborn encrustation. Otherwise use vodka or gin—they will not do any harm and should be cheering if the prevailing mood is one of frustration over hi-fi.

Audible improvements follow from badly needed stylus cleaning. Use a tiny brush and clean only the diamond tip, without splashing the fluid all around. The same brush can be used to remove those accumulations of fluff that often hang on to the stylus. Do this little maintenance task gently, brushing the stylus tip from back to front. Incidentally, use the brush if you simply cannot resist touching the stylus to hear whether the signal is getting through. Do not flick the stylus with a finger. If you have been indulging in this bad habit, clean the stylus anyway!

Naturally enough, hi-fi users inquire about stylus life. Some manufacturers provide estimates based on their own experience and it is worth while asking for the figures, which in some instances will reflect differences between spherical and elliptical tips, the latter having somewhat lower figures. In certain cases it is necessary to return the head to the makers for stylus replacement, but for most cartridges there are push-in stylus assemblies. In many ranges there are several styli (spherical, elliptical) for one common cartridge design, and the cartridge can be upgraded or converted as appropriate.

As a guide, assuming clean working conditions, a diamond elliptical in a cartridge designed for use in the 1-1.5gm. region is likely to give 500-700 hours of use—that is 1,500 to 2,100 LP sides—before replacement is necessary. But in offering such estimates all manner of assumptions have to be made about the pickup arm and local conditions generally, so that only the roughest of guides is possible. Keep a check on playing time. Possibly the neatest method is to use an electric digital counter that clocks up hours of use when connected to the turntable's mains input. You will have a constant and accurate reminder, provided you do not leave the turntable running for any appreciable length of time while no record is being played.

# 5

## UPGRADING YOUR HI-FI

---

IT IS very natural that the really keen enthusiast should eventually get around to making improvements. He may feel that the original system meets his needs for a considerable time—evidence of wise planning—yet one day thoughts of change will occur. New developments arrive and they may be sufficiently attractive to warrant a major alteration—the addition of Dolby-style cassette replay, for instance, to a system that was purchased for playing records. Such additions cause no problems if the equipment is versatile enough to handle a number of programme sources.

However, to most people an 'improvement' is something fairly small, and little things can often mean a lot. With that in mind the beginner with the small player or radiogram, hampered by lack of funds and still anxious to acquire the experience that will lead him along the road to hi-fi sound, thinks of upgrading in small, inexpensive stages. Enough was said earlier in this series to constitute a warning: the little that is spent can so easily be wasted at the radiogram level, and changes of components hardly ever bring about the anticipated lift in sound quality. In the worst case, throwing out that cheap record changer and putting in a modern single-disc player may well be 'upgrading', for at least it will give new records a chance in life!

As for improvements to outfits that were planned as hi-fi in the first place, it is necessary to ask yourself—what's wrong? There is no point in making random changes. Why is it you itch to alter something? It may be that you have gained experience and become more critical. You have heard more stereo in the last year or two and can now see that improvements are desirable—the sort of things you would have done at the start if you had been able to afford them. You therefore have to investigate whether this means wide-ranging changes or merely the replacement of a key item.

On the other hand you may be convinced about some specific change without which results will not be to your liking—as evidenced by the sound. Is there a hint of unnatural treble—even shrillness—on some records? Screaming violins, violent sibilants, rough brass? Have you checked the possibility of severe mistracking? Or is the pickup cartridge a cheap model, insufficiently refined for your ears and inappropriate to the system? Without doubt the biggest single improvement to be made in many systems is a better cartridge—as good as conditions of use will permit.

Do bear in mind, though, that the pickup arm imposes the limitation. You cannot match your greatest ambitions if the arm cannot safely carry an advanced type of cartridge, and in fact there are all too few high-grade arms. For the most demanding of applications we require very small pivot frictions and a generally high standard of accuracy. It is asking for trouble to fit a high-compliance, delicate cartridge in a low-cost player that started life in a budget stereo outfit.

If you use a modest integrated arm/turntable unit—as is very common—then you may have to change the entire unit in order to track a top-class cartridge. However, for many people afflicted by glassy and hard treble sound, upgrading would involve a search for a smoother-sounding cartridge (a secure tracker, too) and this would not necessarily be significantly more expensive or delicate than the existing cartridge. If upgrading *does* involve a major change of player, devote special care to the rumble aspect as well;

then you will be better equipped to make further improvements to your system in the future.

Where the mid-range and top reproduction is seriously deficient, with some distortion and false emphases plus poor signal-noise performance (as indicated by prominent disc-surface noises and the like), there may well be a coincidence of peakiness in pickup and speakers. Changing the one or the other may yield an improvement, but give yourself enough settling-down time to become used to the gain in smoothness and decide whether anything else has to be done. In any case check for accurate pickup operation (doubtful tracking; accurate setting-up) and consider whether the room is contributing to hardness and emphases due to reflections from too many hard surfaces. Some rearrangement of speakers and alteration to furnishings may be desirable.

Upgrading the bass end of the reproduction is likely to be a fairly costly business where the system already ranks as high fidelity. Very deep bass, freely reproduced and with low distortion, points in one direction—towards big speakers. If space permits and the system is technically appropriate (enough power, from a well designed amplifier) a change to bigger speakers can give you a major gain in realism. Near the other extreme, a move away from mid-fi may be achieved with the aid of scientifically designed compacts. In any event the aim is a convincing treble/bass balance, not heavy and boomy bass.

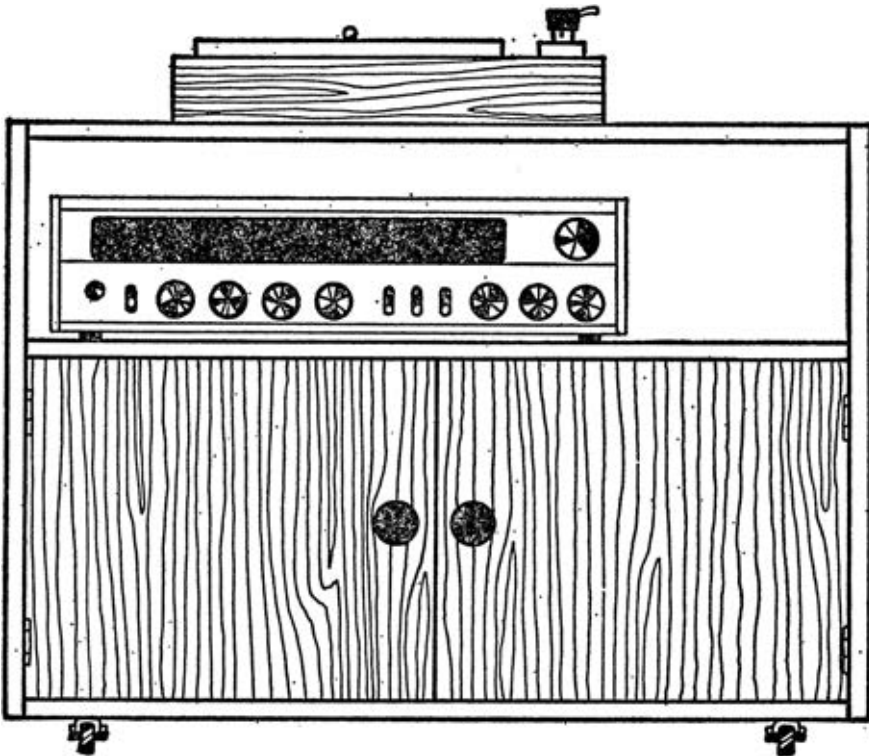

*Ensure there is adequate separation of pickup and components radiating hum fields.*

Another aspect is the problem of listening fatigue, a general lack of sense of ease and smoothness—a feeling that, despite some good features, it is still a relief to switch off and enjoy some silence. We are not concerned now with a very obvious and severe distortion of the kind mentioned above (though that would be fatiguing). Advice offered earlier on the subject of power capability and overall rating may provide a clue. Strong colouration and poor transient reproduction suggest another factor; likewise strong turntable rumble, shown up by system bass characteristics and preventing effective reproduction of a whole sector of the programme.

It may be wise to consider upgrading in power, giving due attention to the behaviour of the speakers on big inputs; or a change of speaker or pickup may be the requirement. If you have moved to another house your system may sound quite different in the new room, and you must consider the factors responsible for the change. Of course, a much bigger room will demand a more generous power reserve. If changing speakers, bear in mind the earlier comments about impedance matching and the ability to accept peaks of power.

The matter of ratings seems to be misunderstood by many who feel the urge to spend money on improvements. Indeed, it is often assumed that changing the amplifier to a more modern type will inevitably bring about a startling change in sound quality. This may be so if the old one is deficient—virtually in a fault condition—and especially if it is working in such a way that distortion is produced. But a good amplifier, appropriate to conditions of use, is primarily an unobtrusive driver of speakers. It does not contribute in a big way to the sound. When one characterises the sound, saying that it is smooth or glassy or delicate, one is referring partly to the pickup and speakers (or tape reproducer, etc.) and partly to the programme and its built-in qualities. These are points to ponder when thoughts turn to upgrading.

# 6 HI-FI MAINTENANCE AND FAULTS

---

GOOD HI-FI housekeeping is largely a matter of preventing trouble. Although many people have curious ideas about the hi-fi enthusiast, imagining he spends his time fussing over unimportant details and anticipating crises rather than listening to music, it is true of the majority of equipment owners that any fanaticism is soon stifled by the requirements of practical everyday life. There can be few—apart from those with a genuine professional attachment to the subject—who can find the time to take everything apart and put it together again at the mere mention of the word distortion or with the prospect of making some subtle 'improvement' overlooked by the designer. But let us hope that they can find the very small amount of time needed for preventive maintenance, for a few simple routines can ward off expensive problems—a sentiment which will win the approval of any unfortunate faced with a seized-up capstan bearing or a mysterious lack of signal.

## Pickups

It is perhaps rather difficult to think of any maintenance routine that *could* apply to a pickup arm (apart from polishing it for psychological reasons) but still there are a few things to check. It is possible that maladjustment, perhaps accidental, may lead to vagaries of tracking, so check occasionally that all is well with the setting-up (tracking weight, bias) using a test disc if possible. With some arms it is advisable to make a regular check of the leads to ensure these are not causing undue friction or drag.

Arm bearings should *not* be lubricated. Oil will affect normal functioning and in any case will attract dirt. Indeed, keep this component as clean as possible and close the player lid whenever possible. Blow dust out of exposed bearings and check the manufacturer's instructions for any other maintenance points.

If one cartridge is installed in the headshell for a considerable time it is wise to check the terminals for tightness. Loose connections here can cause loss of signal or problems with channel balance or noise. Terminals that touch can turn stereo into mono or have some other untoward effect, as a number of mystified *Hi-Fi Sound* readers have found. If a terminal comes adrift from its wire, pull it off the cartridge pin before you get out the soldering iron! Like transistors, cartridges do not care for heat. Stylus cleaning, fluff removal and associated matters are all routine and essential, as mentioned elsewhere.

## Turntables

Although the whole point of buying a robust transcription turntable is to obtain long, dependable service with minimum rumble and speed fluctuation, this unit cannot perform to specification indefinitely without any attention—no mechanism can. The most likely deterioration—in wow and flutter—can be anticipated, and so a preventive maintenance routine is really essential. If the turntable incorporates an idler-wheel drive, an important requirement will be to clean its running surface, the motor pulley driving it, and the surface of the platter which is driven by the idler. Use methylated spirit or carbon tetrachloride on a clean, fluff-free cotton rag. This will remove oily films and atmospheric vapours, etc. which cause slip. Treatment is required at least once a year—preferably every six months. Certain kinds of drive

belt can be given similar attention but first see the manufacturer's instructions or write to the manufacturer or importer. With the turntable platter off check bearings, levers, controls and other parts; and cover such safety points as mains connections, voltage selector terminals and earthing.

Consult manufacturers' instructions concerning lubrication before any enthusiastic work with the oil-can. A special grease may be required for the centre-spindle bearing. Small bearings (idler, pulleys) require only a couple of drops of thin oil about once a year. Use a fine oiler or drop the oil in with a matchstick. Be careful not to overdo it. Remove surplus. If bearings are dirty, clean before oiling. It is best to do lubrication before the methylated spirit anti-wow routine already mentioned.

### **Tape recorders**

There are so many different designs, some of them using new plastics materials for vital parts, that the maintenance requirements cannot be stated briefly. It is especially important to consult instructions concerning lubrication and to question the manufacturers or importers if servicing requirements do not appear to be adequately covered in literature supplied with the machine.

Maintenance applicable to turntables also applies in a general way to many tape machines. Belt drives and idlers can slip if dirty, and there are also brake and clutch devices as well as many more bearings requiring eventual attention.

Head cleaning, to remove dust and tape oxide particles, is a particularly important part of maintenance. Be careful when cleaning head faces and look for any special instructions about this job now that decks with new types of head are coming into use. Special cleaning aids, in tape or cassette form, are available. Another task is head demagnetisation, a simple job for which a defluxer is required, in the interests of minimum noise level. Inspect your stock of tapes for warped spools, which can cause damage or pitch fluctuations.

### **General**

Most audio systems are fixed and subject to little disturbance. However, make a regular check of mains cables, flexes and plug, looking for loose connections, chafing and trouble-spots. Inspect signal-carrying cables with special attention to screening and bonding—a simple routine that can show up potential causes of noise. There is little scope for amplifier maintenance and trouble-seeking is mostly confined to input and output connections. Loudspeakers do not require maintenance, although faults can develop due to gross over-driving or attack by damp, heat or dirt. Sudden application of high-power signals of a spiky, transient nature (e.g. disturbance of connections with the volume at maximum) is a likely cause of damage. Speaker terminals and leads should be checked through occasionally. Finally, keeping a supply of fuses, correctly rated for mains input, amplifier circuit protection and so forth, is an essential part of hi-fi maintenance—as you will discover if you have to search in vain for the missing link instead of listening to records.

### **Something wrong ?**

There are a hundred and one possible reasons for abnormal functioning of equipment but fortunately only a very few have to be investigated at one time. For instance, if you hear distortion it may originate in the amplifier (faulty component?), the loudspeakers (coil rubbing in the gap?), pickup (has the stylus been damaged, or is the pickup mistracking?).

Of course, the type of distortion—grating, muddly effects, screech—will often provide the clue, but a general point to be made here is that if you notice the onset of distortion from your system, look first to the transducers rather than the electronics. Although amplifier and tuner faults are not unknown, the more common distortions of an objectionable kind arise from abnormal operation of equipment, and the player offers the happiest hunting-ground.

### **Is it rumble?**

Rumble can be classed as distortion—or at any rate a serious interference with the reproduction. One thing at least should be clear from a study of this series of booklets: all turntables rumble—as long as they have parts that move! What interests the user is the signal-noise ratio and, in particular, the annoyance value of the rumble that gets through in the reproduction. A high S/N ratio is—or should be—the main attraction of an expensive turntable—it is the justification for all that money.

Before you assume there is something wrong with the turntable (or operate the rumble filter) perform a simple test. Is the low-pitched noise absolutely consistent? Listen with the pickup in the run-in groove or running through a banding groove between items. Then listen to a quiet passage of music and note whether there is a difference in the noise. It is not unknown for low-pitched noise to come up when the music starts—in which case at least some of the blame lies with the record company. Further, noise from the cutting lathe, though rare, has been heard on some discs, and in that case the rumble will be maintained through music and unmodulated grooves alike, though at a very low level. Try several records and note whether there are differences. You will soon arrive at a conclusion concerning the way you must dole out the blame.

If the rumble is always, relentlessly, the same, no matter what you try, then it *is* the turntable. A really rumbly turntable has no place in a hi-fi system; but do remember that methods of mounting—solid, resilient—can affect this reproduction of vibration. Incidentally, it is just possible that turntable rumble may be confused with hum. Try carefully swinging the pickup across the disc area with the lift control up. Is there a noise, and does it change as you move the pickup? Be reasonable, though, and listen at a realistic level, *not* with the volume control screwed right round to its stop. If an obvious hum is reproduced only when the stylus is in the groove, then the noise may be recorded on the disc; but trying a selection of records will of course tell you what you want to know.

### **Logical method**

If you hear an unusual distortion the chances are that it affects one channel more than the other; or perhaps the signal has dropped in level or disappeared. Do not pull at all the leads indiscriminately or try a number of checks at random. Try a step-by-step approach. If there is a minor distortion that occurs occasionally, particularly a splutter or fuzziness on high-level passages, the first thing to suspect is pickup mistracking, which may show up more on one channel. Since an investigation of this will not affect anything else, you can check the setting-up and tracking weight, etc. and find the fault—or eliminate this item from the chase.

Otherwise, first inspect connectors and leads throughout the system. With a noticeable fault condition affecting one channel, switch off the equipment and change over the speaker leads, putting each speaker on the opposite amplifier output. Switch on again and listen. If the fault is still evident on the same channel, then obviously the speakers can be exonerated. You must now



investigate earlier links in the chain, but first change the speakers back.

Similarly you can change over left and right pickup inputs (or inputs from other equipment) to gain further clues. If the fault seems to be at the pickup end of the system, the first things to look for are ineffective connections in the headshell, damage to the stylus assembly and serious maladjustment of the pickup arm. If necessary and appropriate, check for contact in the headshell/arm socket, in the case of plug-in headshells, and in the arm pedestal connector if the pickup has this kind of plug-in arrangement. A much less common fault is an open-circuit in the internal wiring of the cartridge.

If a distortion is fairly consistent and apparently independent of the nature of the programme, it may well indicate an amplifier fault. An occasional 'pop' from the speakers while the system is in normal use (a number of readers have mentioned this) does not necessarily mean there is a fault; and some amplifiers produce a thump, due to the charging-up of components, when switched on. Persistent noises—pops or sizzling—that are not only loud but seem to be increasing in frequency of occurrence most certainly do suggest faulty components, and a service engineer should be asked to investigate.

The causes of hum range from a 'hum loop' due to incorrect installation, as already mentioned, to open-circuit wiring in the pickup leads or headshell. If the hum is louder on one channel, try the logical method. If it is equal on both channels, likely causes include a faulty earth connection, faulty screening at some point, and hum pick-up in components or signal leads where they run too close to mains wiring. If the hum is the same whether the volume control is right down or near maximum, then either the amplifier is faulty (probably its mains section) or the speaker leads are very close to the mains so that they pick up the 50Hz field.

Users of valved amplifiers have occasionally reported a gradually increasing hum. Here, the hum is minimal when the equipment is switched on but increases after a few minutes. Often the trouble lies in the base connection of the output valves and can easily be checked by rocking the valves gently while listening for the result. The cure: clean the valve pins with emery cloth and put some contact cleaner in the valve-holder sockets. If this does not do the trick, you may have to replace the valves, and perhaps the holders as well.

Intermittent crackling, usually not very loud but still infuriating, is often traceable to faulty soldered joints or small components (resistors, capacitors). It is possible to narrow the search to one area, and then one joint or component, by gently tapping your way through the amplifier with the handle of an insulated screwdriver while listening at moderate volume.

# 7 PRACTICAL HINTS

---

HINTS AND tips, facts and figures, reminders and warnings, covering a variety of practical points and audio activities, some of them technical but all of them, it is hoped, useful, conclude this booklet.

## **Regular checks**

You cannot expect a complex system to go on functioning satisfactorily without attention. How many routine checks can you think of in half a minute, starting now? In fact there is quite a selection, apart from the maintenance jobs already mentioned, and they have to do with safety, accurate performance and good housekeeping. Here are just a few.

No doubt you will do your best to keep dirt away from your records. But remember also to clean the equipment, especially the parts that are near the records. Top of the list is the turntable mat, which should be taken into the kitchen, washed under warm running water and thoroughly dried. A squirt of washing-up liquid helps the washing. If your mat is fixed, give it a good cleaning and hide it for good by placing on top of it a loose mat. Buy a standard type and trim to size as necessary. 'Anti-static' mats (specially compounded rubber) are available.

Clean round the turntable baseplate or board and don't forget the Perspex or other dust cover. If the latter is removable it can receive the same treatment as the turntable mat. For panels and other parts there are instrument-cleaner fluids (e.g. Bib) which also come in handy for other household jobs—polishing the telephone, for instance. Pickups arms are tricky things to clean (be careful with the spiky bits) but you can blow dust away from crevices using a vacuum cleaner with its hose connected 'wrong way round'.

Check your wiring occasionally. It may have been disturbed, and attention in good time can avoid a fault condition. The most obvious points seem to be those that are ignored until something goes wrong, and the leader here is the mains plug. Open it up and see that the connections are tight and safe. This is the opportunity to substitute a fuse of more appropriate rating for the 13A that is almost inevitably fitted in modern systems! If the speaker leads are terminated under screws on the amplifier, ensure that no whiskers of wire have emerged, ready to bridge the gap with a short-circuit. Best of all, solder on to the wires a set of spade tags that will clamp neatly under the screw-heads.

If you set your pickup tracking weight carefully when you installed the cartridge, it is rather unlikely that any change will occur. However, optimum tracking is basic—absolutely essential—and there may be the possibility of disturbance to either the pressure or the bias correction, so an occasional inspection is advisable. For the utmost precision, rather than reliance on shrewd guesses, you need a tracking weight gauge, a test disc and an alignment protractor.

While attending to the pickup you may as well clean the stylus tip—but that is a job you should put on the maintenance list. If you are a tape user the corresponding task is tape-head cleaning. There are kits and special cleaning tapes for open-spool machines, and a recent addition to the cassette armoury is the head-cleaning cassette (Bib, Metrosound, etc.). Without doubt, very many users are forgetful about head cleaning—even if they

are aware of this simple requirement. They neglect it, then wonder why performance is falling off. Heads with extremely fine gaps on modern machines need frequent attention. This has been shown up particularly clearly with recently developed high-grade cassette units: their already restricted hf response must be jealously guarded lest it deteriorate—as it will without frequent use of a cleaning cassette, preferably before every listening session.

FM users should check aerial connections and, where the dipole is external, the possible need to check orientation must be considered. With all electronic units, including tape machines, ensure that manufacturers' warnings about ventilation are being heeded. It may be that some rearrangement of equipment has restricted air circulation. An example is the tape unit that has been placed on a soft, yielding surface, preventing entry of air at the bottom (a specific requirement for some models). Another is the amplifier with large rear heatsinks, pushed back into a position that stifles air circulation.

Do you know where you put your instruction manuals and other reference papers? At one end of the record cabinet is a convenient place for them. When you have rounded them up, check on the record storage and ensure all records are properly supported—neither jammed tight nor leaning over. If you have any 10in. LPs (rare nowadays: the author has six old ones!) keep them in a separate compartment. Keep any 45rpm 7inch discs in a separate place. If you have no tailor-made storage for them, they can go in little piles in a drawer or cupboard. Dust-exclusion is as important for 45s as it is for LPs, of course.

### **Playing 78s**

As pointed out in the previous booklet, *Planning and Buying Hi-Fi*, it is not so easy as it was to make provision for playing 78rpm records. At the planning stage you will find that a high proportion of the most attractive hi-fi turntables are for 33 and 45 only. Many two-speed units employ belt drive and, while it is a simple matter to make a device that pushes in one of two directions for speed-changing, it is not so easy to arrange for the belt to pick up one of three speeds. But there are still a few turntables with 78rpm.

The practical side of all this is in the provision of a second headshell, with cartridge and appropriate stylus, to plug into the arm. Since the tracking weight for 78s will be greater than for LPs, the headshell can be weighted to provide the extra pressure, thus enabling the arm setting to remain undisturbed at its stereo optimum. People who decide to sample the faded but by no means vanished delights of 78s usually forget that modern amplifiers do not have the relevant recording characteristic equalisation. It is not proposed that anything should be done about it—other than experimental twiddling of the bass and treble controls. If the bass thumps, roll it off by using the control, also sloping off the treble end of the range to taste. A reasonably smooth effect is usually obtainable if a magnetic cartridge, similar to the stereo cartridge but with the larger-radius stylus, is used. Switch the amplifier to mono.

### **Preamp for magnetic pickup**

Nowadays all good amplifiers—even some of the economy-class units—have at least one pair of inputs for magnetic stereo pickup cartridges. At the same time there are plenty of low-cost magnetic cartridges that will suit 'budget stereo' systems. Usually the input presents about 47kohms and has a sensitivity of around 3mV.

However, some of the simpler equipments, including certain popular

models of a few years ago, still giving service, cater for ceramic or crystal pickups only. These units therefore have an input arrangement that is about as wrong for magnetics as it is possible to imagine—a high impedance and inadequate sensitivity. The same is true of many tape recorders.

The well-read enthusiast knows that it is technically possible to do something about this, and he may even find it worth while to start if the basic quality of the equipment is high enough. But some less experienced users have simply changed to a magnetic cartridge and plugged into the same old input. The result, as some have accurately described it, is a tiny thin sound without any bass!

What is needed is an external preamplifier—a booster to go between the magnetic pickup and the amplifier. It has two main functions: it provides voltage amplification and imposes the necessary LP response equalisation (lifted bass and sloped-off treble, you will recall if you have read the previous booklets). Thus, in one end goes the pickup's few millivolts, and out of the other comes a substantial equalised signal. This should be connected to a 'flat response' input on the amplifier—typically an auxiliary or radio input. Goldring, Grundig, Shure and WAL are among the suppliers of preamplifiers. Before buying one consult the makers about matching and signal levels, mentioning the equipment to be used.

### Microphones

Although some enthusiasts add tape record/replay units to their hi-fi systems and become drawn to the intricacies of handling tape at high quality (experimental recording, taping FM and so on), few make serious use of good microphones. There is a world of difference between the fairly cheap dynamic microphones supplied with some recorders (they are really only suited to speech recording) and the high-grade instruments available from specialist manufacturers, and the results of using good microphones with semi-professional tape machines can be very fine indeed.

The enthusiast who is developing an interest in creative recording or aiming to record music should read test reports and manufacturers' literature and seek advice as appropriate, paying special attention to the characteristics he will require. A studio microphone of fine quality costs as much as many people would pay for a complete hi-fi outfit, but some very acceptable dynamic microphones—cardioid, bi-directional and others—can be found in the £20-35 region.

### Tape unit outputs

It is curious but true that many tape record/replay units, though intended for permanent association with hi-fi systems, do not appear to match the



*Use of potentiometer (one for each channel) to drop line output—see text.*

amplifiers with which they would be used. The common problem, so often revealed in test reports, is that the tape unit presents a high signal voltage at its stereo line outputs (up to about a volt is not unusual) ; and one naturally compares this with the recorder input on the amplifier, finding that a higher sensitivity is mentioned in the specification. Impedance matching is not often in question, but the signal voltage figures may suggest that the amplifier inputs will be overloaded at times, depending on the recording being played and the overload margin of the amplifier.

Obviously the first thing to do is to link up the equipment and check for distortion. If there is overloading it will be necessary to do what the tape unit manufacturer should have done in the first place—fit attenuators to cut down the line output voltage. This is accomplished with a couple of potentiometers, one for each channel. One is shown in the drawing. It is simply a carbon-track potentiometer, similar to the volume control in an amplifier or radio set.

A value of 10kohm is typical, though in certain cases a higher or lower value would be better. In case of doubt consult the equipment manufacturer or importer. The potentiometers, which should be linear law, permit adjustment of the signal voltage, but a fixed voltage dropper can be made from two resistors which have the same function as the adjustable component. In any case the components must be well screened (make up a small screening can) and the screens of the coaxial signal cables must be properly bonded throughout.

### **Editing tapes**

The enthusiast who wants to make full use of tape should learn how to edit his recordings. Even if he does not propose to go far with experimental recording, he will still wish to cut out unwanted fragments of sound, possibly to an accuracy of a fraction of an inch, and insert leader tapes and spacing sections as well as repair damage or simply join two tapes together.

One can soon become expert at joining tapes so that there is no significant break in the magnetic coating running past the heads. A well-made join is mechanically strong and will pass the replay head without drawing attention to itself. Materials required are special jointing tape (nothing else will serve), a razor blade and an editing block or tool, the most important features of which are a channel to hold the tape and slots to guide the cutting blade. Non-magnetic scissors are sometimes used but the razor-blade method is the most dependable for amateurs.

The tape is laid in the channel and cut as required ; then the ends are butted together and joined with a short length of the jointing tape, applied to the uncoated side of the magnetic tape. The cut is at 45° in most cases, but a 90° cut may be preferred where great precision is necessary in the editing. Most editing tools have slots at both angles. Although it is not yet generally appreciated, the  $\frac{1}{8}$ in. tape in Philips-type cassettes can be treated in the same way. It can be pulled out and taken through an editing block of the kind that has been produced for the purpose.

If you intend to do much editing you will choose a machine that has a convenient deck layout. It is difficult to work with a high degree of accuracy unless the head cover is removable, giving clear access, or hinged. If the machine has inaccessible heads, mark the tape at some point where it can be seen, using this as a reference point, in the knowledge that it is at a certain distance from the replay head. A wax pencil can be used to mark tapes.

It is possible to make permanent joins by preparing and overlapping the tape ends and fixing them with a special solvent. The fluid to be used depends on the tape material—pvc, polyester, etc.

Manufacturers supplying editing materials also market a range of useful items of interest to tape enthusiasts—head cleaning accessories, spools, containers, auto-stop foil and so forth.

### Efficient erasure

Every tape recorder owner knows that when a new programme is recorded on the tape, any old recording present is erased by the erase head—for the very good reason that a given point on the tape passes that head first when moving across the deck; and he knows, too, that for general purposes this automatic erasure usually gives acceptable results. However, some machines are better than others at this job, and in any case it is possible to achieve somewhat superior results by erasing the tape in bulk. A bulk eraser accepts the complete spool of tape and subjects it to a strong ac field—the counterpart of the erasure that takes place as the tape runs through the recorder. Walgain, Osmabet and Weircliffe are among makers of bulk erasers.

### Connecting headphones

Very many amplifiers and receivers have headphone outlets—usually a jack socket on the front panel. The instructions for use refer most often to low-impedance headphones, and in fact the majority of stereo headsets are of that type, with an impedance somewhere in the approximate range 8 to 200 ohms or so. Although newcomers do not always realise it, the matching of headphones to the output is not particularly critical, and what seems to be a substantial mismatch does not have an audible effect. The conditions are not the same as for loudspeakers, for in the case of headphones resistance is included in the relevant part of the output circuit (an arrangement that is neither necessary nor permissible with speakers).

So if the amplifier has the usual low-impedance outlet, plug in the low-impedance headset and enjoy the results. Since the aim is private listening, perhaps late at night or when others in the room are more interested in the television, one requirement is muting of the loudspeakers. In some cases this is done automatically as you plug in your headset. With a few amplifiers you have to operate a selector switch. If you have no provision for connecting

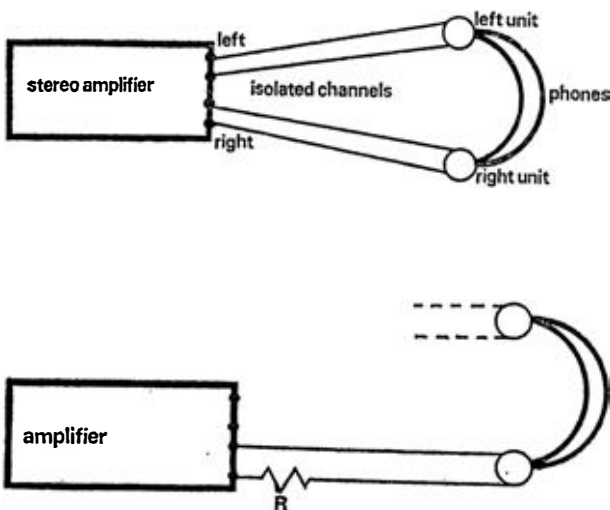

*Top: direct connection of headphones is not satisfactory. Bottom: attenuate signal so that the volume control can be used normally—the resistor  $R$  is 200 to 500 ohms, 1 watt.*

'phones and do not wish to have much to do with wiring, buy a connecting box (Koss, Howland-West, etc.) and connect it to the amplifier's speaker outputs. A typical connecting/control box has jack sockets for one or two headsets, outlets for the speakers, and a speaker/headphones selector switch.

As for the do-it-yourself approach, the first thing to note is that a basic requirement for headphones is an arrangement to ensure that a suitable range of loudness is geared to a convenient range of volume control rotation. Obviously one does not put loudspeaker power straight into headphones (they work on less than a watt) yet at the same time one wants to use the volume control in a normal way. The secret is the inclusion of a limiting resistor in series with each headphone unit. This gives scope for manoeuvre on the control and ensures the signal-noise ratio is acceptable. See illustration for details. Arrangements shown are for popular moving-coil headsets: in case of doubt consult the amplifier manufacturers.

### Technical test record

Hi-Fi Sound stereo test disc HFS69, mentioned earlier in connection with setting-up checks, includes both 'subjective' tests and more technical material. Side 1 tests can be used without measuring instruments, and side 2 places the emphasis on tests that are of value for deeper investigation of equipment characteristics. The contents can be summarised as follows.

Side 1. Test 1: Channel recognition, phasing and balance. Transient random-noise bursts with spoken announcements. Test 2: White noise, particularly useful for subjective evaluation of pickups and speakers. Test 3:

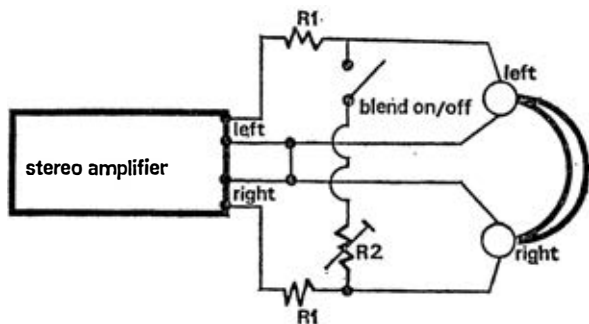

*Top: blending of channels with a combining control, four times the headphone impedance.*

*Bottom: parts can be housed in a box with a jack socket.*

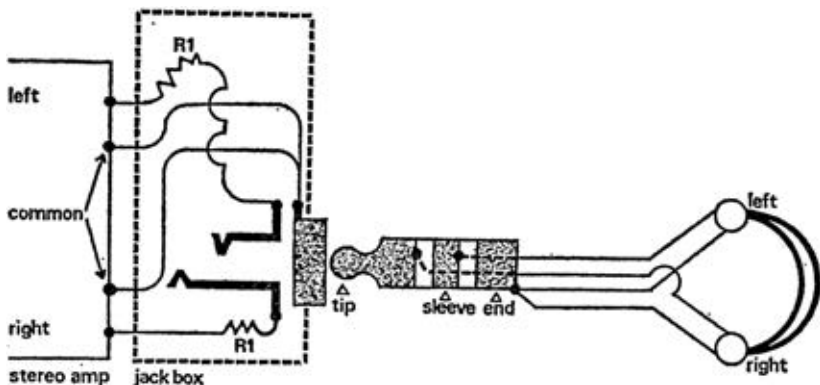

Determination of bias correction and minimum tracking weight of pickups by a dynamic test involving lateral and vertical modulations at two levels. Test 4: Recording of applause, in mono to enable two loudspeakers to be compared side by side, one on each channel. Test 5: Music test, followed by blank grooves.

Side 2. Test 1: Reference level and channel separation, with 5cm/sec tones on left and right channels. Test 2: Pink noise, useful for pickup and loudspeaker tests. Test 3: Tone bursts for loudspeaker and pickup evaluation, for which an oscilloscope is required. Test 4: Wow and flutter test, employing 5cm/sec lateral cut at 3kHz. Test 5: Rumble test, employing 10cm/sec lateral cut 1kHz reference tone followed by unmodulated grooves.

### **Test instruments**

Few enthusiasts summon enough enthusiasm to investigate equipment performance or malfunction with the aid of test and measuring instruments, but there are some whose interest in audio expands, to be fed by a study of test methods and tools. A developing interest in transducers will call for test discs and, in due course, an oscilloscope.

From a determination to chase out faults and keep everything at peak performance, thoughts may soon turn to meters and a means of generating a test signal. A taste for experiment or creative recording will lead inevitably to a quest for practical aids, tools and instruments.

If servicing work and simple investigations (absence or presence of signals) are to be undertaken, a multi-range meter will be a first acquisition and need not cost a great deal. Specialist suppliers can advise, but first consider your requirements, which can be anything from measurement of very low voltages in circuits to checking ac at mains voltage or higher. However, another type of meter is needed for checking signals in the audio range. This is the valve voltmeter (or more correctly, electronic voltmeter) which has a high impedance to prevent it loading the circuits to which it is connected. The meter must have a frequency range wide enough to embrace all audio work. A typical instrument has a number of voltage measurement ranges together with secondary scales in dB.

The oscilloscope is a versatile tool used a great deal by the experimentally minded enthusiast once he discovers and exploits its advantages. Not only will he use it to extend his ability to make tricky measurements but he will also find it valuable in fault-finding and for monitoring practically everything he does. Checking pickups—tracking ability and the effects of making small changes in working conditions—is just one example. This kind of thing may be thought rather ambitious for the amateur—until it is realised that cost can be minimised by kit construction (Heathkit). A signal generator also can be made from a kit. Although a test disc or tape yields the signals for certain types of measurement, a generator that provides sine waves and square waves on tap at low distortion is essential if very much experimental work is to be undertaken.

### **Key to fidelity**

If you collect records you will soon come to appreciate that hi-fi starts on the disc. Its built-in qualities and characteristics matter a great deal. But one recording may be hi-fi by any reasonable man's standards; another, at the same price, may be positively lo-fi. If you want the best of high fidelity you must discriminate, and for information before purchase you need record reviews.

Unfortunately not all reviews offer reliable information on the quality of



recording, and some commentators, though interesting on their musical specialities, say very odd things about the 'technical' side. One reviewer wrote '... a good sound, not quite up to the best modern standards but likely to satisfy all but the most rabid hi-fi fanatic.' Apart from wondering why a keen hi-fi user has to be rabid, the reader will be reminded of the problems encountered in subjective assessment. But the critic's world is that of the technical package known as a record, so why doesn't he take it seriously and criticise the product?

With that in mind the author concludes with the following note, previously published in *Hi-Fi Sound* under the title 'Why read record reviews?'

The title poses the question. The answer, too, is plain enough: to learn something of the merits of the records you are about to buy. Do you seek such information, and if so, do you glean enough for practical guidance? Reviews can lead you to new discoveries and help you assess value for money, and they can steer you away from expensive mistakes.

If you are a keen collector to whom music is at least part of your way of life, you will be aware that there are many expert contributors to specialist review magazines who research their subject well and present many fascinating sidelights on interpretation, performance and historical aspects in addition to comments that help contrast the records under review with other versions of the same music. But a record is a package resulting from technology and a mass-production process. Records are variable; they are the stuff of competition, sold at various prices; and they exhibit various levels of quality. If you are critical of quality and relate this to price, how well do the musicologists and other types of music-press specialist serve your interests?

Many reviewers live in the world of the 'gramophone' and are often ready to argue (not without reason, I acknowledge) that the reproduced sound is but a convenient reminder of the real thing. A few seem to be mildly interested in high fidelity and the progress of recorded sound but others are rather rude about 'hi-fi', which they regard as an abstraction or a development that is actively hostile to music. I discovered that one contributor to a respected review magazine did not really understand the difference between stereo and mono and thus had to avoid the matter as much as possible in his reviews. In fact I gave him his first demonstration of high quality stereo—several years after the first stereo discs were marketed.

The fact of the matter is that a record may be hi-fi, lo-fi, or something in between. The quality points that matter most are built in from the start and include frequency range, distortion, acoustical information, dynamic range and those bits of the sonic experience that are not so readily labelled—presence, impact, call them what you will. Success depends on all sorts of things including the expertise of the balance engineer, whether it was an 'off-day' for key personnel, whether the cutting gear (or its operator) was any good, and the possibility of the studio equipment going faulty (yes, *faulty*: I found a studio using faulty amplifiers when producing an important recording).

Recordings—and, therefore, records—have good or bad characteristics, and the better the reproducing system, the more clearly will these characteristics be revealed. Hi-fi is not a magic wand and, in general, is not supposed to make poorly recorded stuff sound much better. If anything, it will show up bad recording in all its awfulness. (A lesser player may well mask some of the deficiencies, though one cannot rely on it.) If you are serious about high fidelity you must include the records—the first link in the chain. Otherwise, all your fiddling with filters will achieve little. It is only too easy to throw the baby out with the bathwater.

Given a good standard of playback it is to be expected that the great

illusion—the most realistic and satisfying musical experience—will most often be purchased at full record price: less often at 'budget' prices. There are honourable exceptions, as we have noted in our columns. Indeed, without aiming to cover more than a representative selection of what's going, we try to point to value-for-money aspects while reflecting the varieties of approach and variations in quality currently encountered.

The authoritative pronouncements of reviewing specialists make compelling reading, but I must say that, in view of the upsurge of interest in good quality sound in the home, their work leaves much to be desired. It is not unusual to find a 500-word musical criticism followed by a sentence indicating that the record is acceptable. It is as if the reviewer has imagined himself at the performance and at the last moment has grudgingly acknowledged that it was canned music after all. So the recording is acceptable, eh? To whom? Under what conditions?

Before writing this note I scanned the pages of the review journals, partly to see what old friends had been saying and partly to select a few samples for comparison with my own findings. There was the eminent musician who wrote a marvellous essay on a costly set of classical symphonies, cleverly concealing the fact that he did not relish the task of assessing the recording. He *did* refer to the glory of the brass and the bloom on the strings but he was probably remembering the sound of the orchestra as he knows it. There was the journalist—a sort of thwarted Karajan—who to my certain knowledge plays his discs on a stereogram and loves the satisfying 'plunk' as the groove-grinder consigns yet another LP to its fate. And there was the intense young man who spends most his days boning up at the local library and has little time left actually to listen to anything.

You may like their style but would you buy discs on their say-so? As with reports on equipment in *Which?* you will be diverted and instructed but it would be wise to read a few other organs of opinion before making up your mind. Who am I to carry on so, you may ask. There is certainly no attempt to encourage this magazine's contributors to compete with the musical experts, of course, for that is not our job, but we do see records as frail products, dependent on human foibles and machines that can go wrong, and we vet them carefully on equipment of monitoring calibre. That is why I am so sure that the output of the record companies is so variable!

One record to which I returned was of a pair of romantic symphonies—very full sides, a comfortable sound but something less than Decca's best. Not the expected sparkle or revelation of detail: about middle-grade as I estimated it. One reviewer told us a lot about the conductor and his faults and said nothing about the recording. Another said quite different things about the conductor and performance (on principle, I suspect) and, in brief remarks on the recording, said nothing that would lead his readers to expect anything but the best. The BBC man said it was mellow, or nice, or something, and played a few bars to show how wrong he was. Similarly another, EMI Melodiya release was brilliant and wide-ranging to one commentator and of demonstration quality to his contemporary. Actually it was strident and a classic case of compression of dynamics. The brilliance was distortion but the reviewers clearly were not equipped to detect it.

If some reviewers are not all that hi-fi-conscious, it is equally true that some of the producers need to look to their critical faculties. Not long ago I came by a release from one of the smaller organisations that exhibited rumble—the result of a faulty cutting lathe (arising from lack of maintenance, I think, for some studio equipment is flogged to death by staff who are too busy with their pop boom to look after things properly). After inquiry I concluded that I knew more about the product than the producer did: as

far as I could discover the studio had no monitoring equipment that would expose low rumble.

Indeed, looking at recording companies in general, monitoring is often of an indifferent standard, and although the technical staff like listening to their tapes (which are often superb), they have less knowledge of the disc that the public buys. I told a recording manager that one of his recordings was short of bass: it was easily demonstrable, I said. He was not at all pleased about this and was anxious to prove me wrong—using the studio tape, of course! But the bass loss occurred after the tape stage. As for that recorded rumble, it is obviously right that the discerning buyer should have it pointed out to him. His hi-fi system may expose it even if the studio's equipment does not.

In the popular field assessment is often difficult. Most reviewers are concerned with discussing personalities and keeping up with fast-changing fashions; producers try new technical tricks. For instance, how do you review deliberately introduced distortion? Is it good or bad distortion? The companies—not to put too fine an edge on it—are too busy stimulating and meeting demand to give much attention to fostering the art and science of recording, and they know that most of their discs are played on portables. I have heard many examples, and some, intended for review, have been returned to their senders. Others have been pleasing and some are currently noted in our columns.

I must return to the original question. One reader, evidently skilled in statistics and economics, reckoned that by 'buying blind' he would make as few mistakes as he would by basing purchases on reviews. By not buying the magazines he would miss mainly subjective comment: he would save a few pounds a year and could get the information at the public library.

But for others it is a matter of gleaning a little information they would not otherwise gain without professionally monitoring each disc (or tape or cassette) before purchase. To conclude, *do* please study reviews—several if you like. If you don't find what you seek, complain about the omissions. You are buying not only music but also a technical product.

# 8

## READING ABOUT HI-FI

---

### Recent Articles in *Hi-Fi Sound*

#### Technical Articles

Measurement of Amplifier Quality—Test routines and interpretation of results. December 1970—April 1971.

Surround Yourself with Sound—Surround sound from disc. March 1971.  
Cassettes—Hi-Fi of the Future? Critical examination of cassette machines. April—May 1971.

Solid-State Story—Transistors and other semiconductor devices. February-April 1971.

Multi-Channel Sound. August 1971.

QS Matrixes and Four-Channel Stereo. August 1971.

JVC Four-Channel Disc System. October 1971.

Hall Effect and Hi-Fi. October 1971.

Dolby B Noise Reduction—Kellar KDB1. November 1971.  
Overload. December 1971.

#### Laboratory Reports

Eight Loudspeakers. July 1971.

Eight Amplifiers. September 1971.

#### Surveys

ABC Guide to Small Speakers. March 1971.

ABC Guide to Big Speakers. June 1971.

Hi-Fi Turntables. May 1971.

Plinths for Players. September 1971.

Hi-Fi Pickup Arms. December 1971.

#### General

A Little Extra Costs a Lot. February 1971.

Simple Stereo—Basic principles. May-July 1971.

Ten Faults Diagnosed. May 1971.

World of FM Radio—Readers' Queries. August 1971.

Audio Fair Preview. October 1971.

New Systems and Components. October 1971.

CBS/Sony Quadraphonics. September 1971.

CBS Demonstration of SQ Disc. November 1971.

How Compatible Can You Get? December 1971.

#### Hi-Fi Sound Annual '72.

Progress Report—Pickups, Speakers and Amplifiers.

Sound Advice—Consultant's casebook.

Hi-Fi Developments, Japanese Style.

Twin Channel Stereo from Disc.

How Dolby Works.

CD-4 Four-Channel Disc Recording System.

Crosstalk.

Hi-Fi Sound 10-20 Amplifier—Practical project.

Audio A-Z—Glossary.

Accessories Unlimited—Survey.

Budget Ideas—Low-cost stereo.

## **On Test—Selected test reports, 1971.**

### **Pickups**

Goldring 850 cartridge. January.  
ADC 26 and Empire 1000ZE cartridges. February.  
Micro M2100 Seiki cartridges. February.  
Empire 888VE cartridge. April.  
Audio Technica AT-55. August.

### **Turntables**

Garrard SP25 Mk3 and BSR MP60 players. April.  
BSR HT70. November.  
Garrard Zero 100. August.  
PE2015. November.

### **Amplifiers**

Alba UA700. March.  
Dynatron SA90. April.  
Trio KA 2002. April.  
Lux SQ507. September.  
Radford SC24/SPA50. October.  
Sansui AU101. July.  
Sugden A21/II. August.

### **Tuner-amplifiers**

Beomaster 1200. December.  
Bell & Howell 3600. July.  
Pioneer SX770. November.  
Trio KR2120. July.

### **Loudspeakers**

KEF Concerto. January.  
KEF Chorale. February.  
IMF Studio. June.  
Heco P6000. December.

### **Tape recorders**

Tandberg 3000X. January.  
Sony TC366. March.  
Uher 263. June.  
Akai GX220. November.  
Beocord 1200. October.  
Chilton 100S. October.  
Sanyo MR805. December.

### **Accessories**

Koss PRO-4AA headphones. February.  
Philips LBB9050 microphone. April  
Koss headphone controls T10A and T4A. August.

Test Report Index appears in each January and July issue.

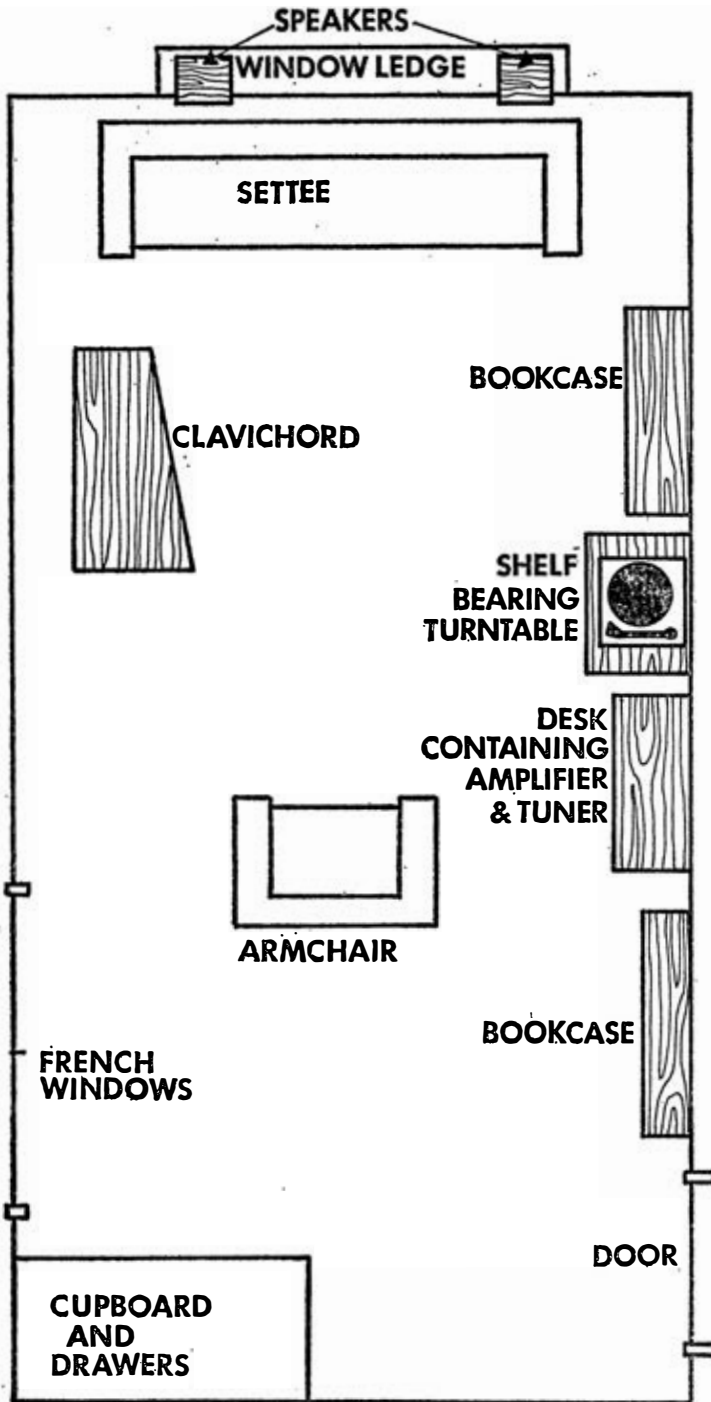

*How an enthusiast installed his audio.*

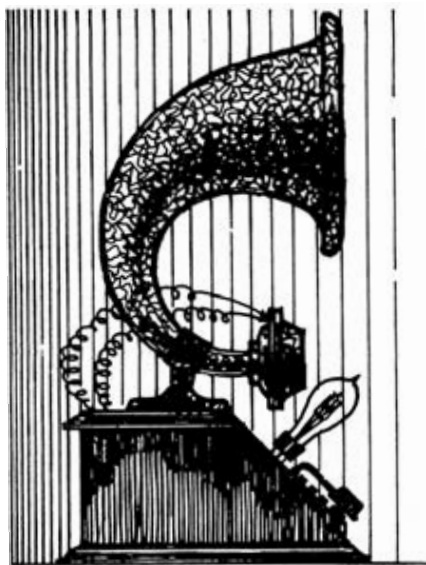

when you buy

**Celestion** Studio Series

**Loudspeakers for the Perfectionist**

you enjoy  
the sound  
experience  
of 47 years

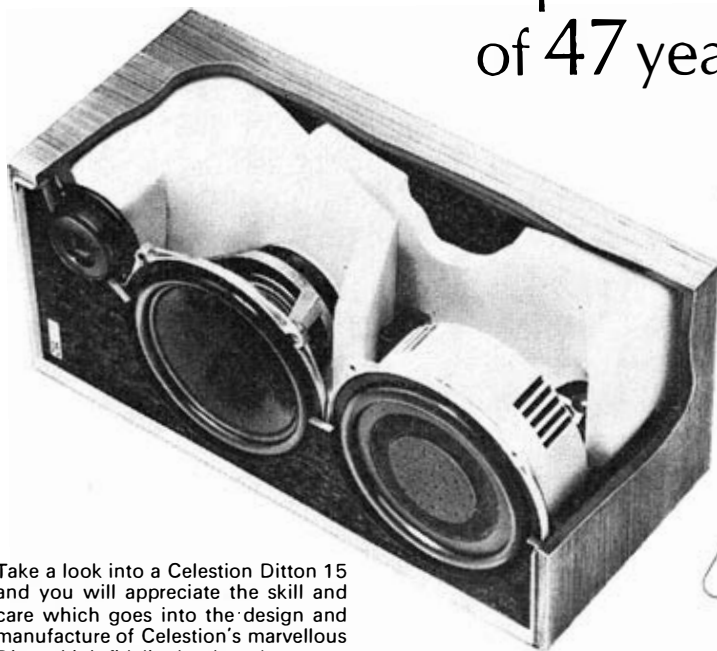

Take a look into a Celestion Ditton 15 and you will appreciate the skill and care which goes into the design and manufacture of Celestion's marvellous Ditton high fidelity loudspeakers.

Meticulous attention to detail, from the superb furniture finish right through to the precision engineering at the heart, ensure the quality for which Celestion are world renowned.

For the sheer enjoyment of your favourite music the Celestion Sound Experience has no equal. Just send your name and address and full details will be mailed at once.

**Celestion**



**ROLA CELESTION LIMITED**

DITTON WORKS, FOXHALL ROAD, IPSWICH, SUFFOLK IP3 8JP

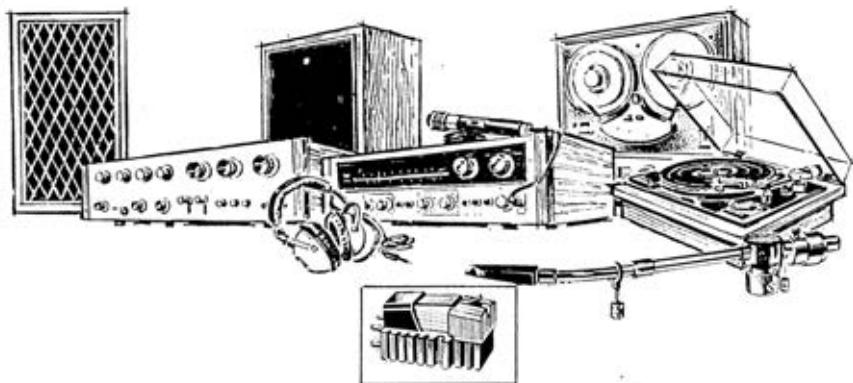

## The two greatest names in Hi-Fi

 **PIONEER**<sup>®</sup>

This is the real sound of music—devastating, true high fidelity in depth stereo sound. Stereo recordings come alive with sound so pure from top treble to deep bass. It's an incredible new achievement in the world of sound. Luxurious looking with a range of Amplifiers, Tuner Amplifiers, Loudspeakers, Turntables, Tape Decks and Headphones.

**Ask your Pioneer stockist for a demonstration of Pioneer Four Channel Sound—a stunning adventure into a new world of sound.**

 **AUDIO-TECHNICA**

In attempting to achieve crystal clear reproduction from your high fidelity stereo system the first and most important step is to choose the best cartridge—the Audio Technica—an outstanding stereophonic cartridge featuring a series of unique concepts which are considered to be the key to good performance in high fidelity cartridges. Among its many features is the fact that stylus replacement is extremely simple:

**There is a complete range from budget to professional standards—see them at your nearest Audio-Technica stockist.**

*Further details and address of your nearest stockists are available from:*

**SHRIRO (UK) LTD., 42, RUSSELL SQUARE, LONDON, W.C.1.**

**TEL: 01-580 6996**



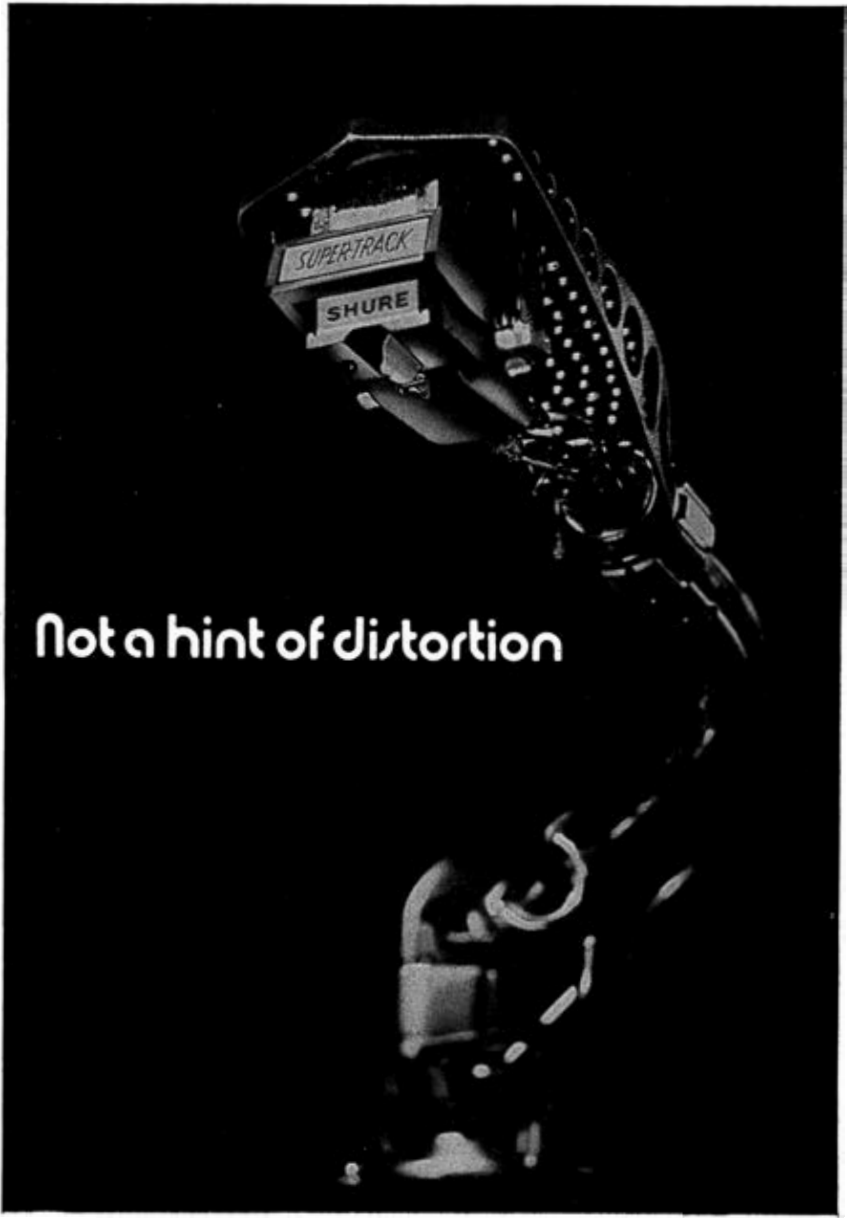

Not a hint of distortion

SHURE V-15 Type II  
(Improved) SUPER-TRACK  
with bi-radial elliptical  
stylos (0.0002" x 0.0007")  
- 15° tracking - unique  
"flip-action" built-in stylus guard.



Please send me full information on the  
SHURE V-15 Type II. (Improved)

Name \_\_\_\_\_  
Address \_\_\_\_\_



Shure Electronics Ltd.  
84 Blackfriars Rd., London SE1. Tel: 01-928 3424

---

# *We're not just after your money!*

*We think we're better. We think we give our customers the best deals. Not by giving discounts. Not by offering discontinued or soiled goods at knockout prices.*

## **What's our secret ?**

There isn't one! It's all very simple! For a decade now, we've been giving our Clients un-biased advice, so that they only buy equipment which is specially tailored to their individual—and sometimes very peculiar—needs. As a result, we have a vast number of satisfied clients and an equal number of very good friends. You see, we believe that supplying equipment is only a beginning. If something goes wrong it must be put right—and quickly. So, although everything you buy will have been tested, to try and jump on teething troubles, a breakdown can still occur and we keep a squad of highly-trained Engineers, to look after YOU—the Client—and nobody else. Everything that leaves Studio 99 (bar styli) carries a FULL GUARANTEE, for parts and LABOUR for twelve months and, thereafter, as we still have your interests at heart, we want to go on looking after you, for ever and a day, at COST.

## **Why do we do it ?**

Simple! A long time ago, we realised that YOU, the Customer, was our best advertisement. That's why over half our new friends have come to us—through recommendation. We also realised, at an early stage of our existence, that, for every £100 of equipment we sold, we made a certain amount of profit. Whether it's good or bad equipment, the profit's the same. But, we won't sell bad

equipment. We can't afford to. Not when we depend for our livelihood on YOUR recommendation and certainly not when we guarantee all our equipment.

## **What do we sell ?**

Again, simple. We only sell that equipment which we consider the BEST at each price level. That's why you can buy, with confidence, a complete High Fidelity Stereo system for as little as £80. You can also buy a system for £800. Or for any sum between. The £800 system will last no longer, nor will the £80 system keep breaking down. Certainly, the £800 system will sound better, but that's the only difference. So before you decide, listen. LISTEN to systems at £80, or £100 or £150 or £200 or even £800. But LISTEN. Here at STUDIO 99 every piece of equipment is ready for demonstration.

**WE WANT YOUR EARS TO DECIDE FOR YOU, NOT OUR SALES STAFF.**

They will discuss the equipment with you, they will advise you, but they will not try and SELL to you. OUR equipment and YOUR ears will do that. You'll be surprised how YOU will hear the difference between a speaker from K.E.F. or from Leak, or Tannoy or Wharfedale or Amplifiers from Quad or B & O, or Trio or Leak. Which is the right cartridge for you? Or turntable? Or tape recorder? Your ears will give you the answer.

# studio 99

STUDIO 99, FAIRFAX ROAD, SWISS COTTAGE, LONDON, N.W.6. Tel: 01-624 8855  
PLEASE NOTE: Open 10 am-8 pm Incl. Sat. CLOSED ALL DAY THURSDAY. Park outside. No meters. How to get there—nearest underground stations: Swiss Cottage and Finchley Road. Buses 2, 2A, 13, 113, 31.

**2 INTO 1 CAN GO!**

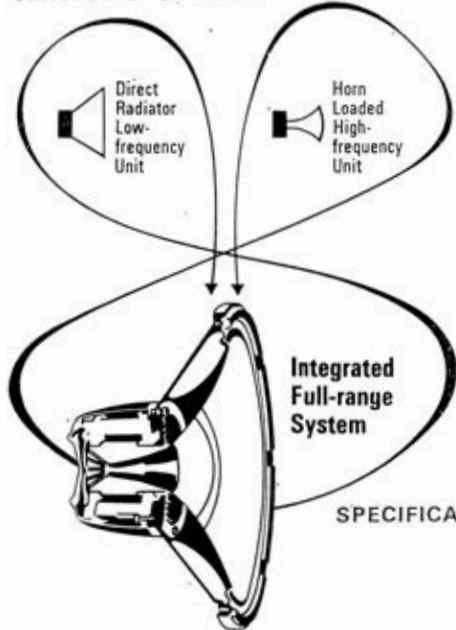

THE *Monitor*

**GOLD** \*

**DUAL CONCENTRIC**

... provides the perfect integrated source needed for stereo. The Monitor Gold is two separate transducers in a single assembly fed by a sophisticated cross-over and treble control network.

**SPECIFICATION** Frequency Response: 30-20,000 Hz.

**Power Handling Capacity:**  
15" 50 Watts, 12" 30 Watts, III LZ 25 Watts

**Impedance:** 8Ω nominal, 5Ω minimum.

**AND IT SOUNDS BEST IN A**

**TANNOY ENCLOSURE**



*"Lancaster"*  
free-standing fitted  
with 12" or 15" Dual  
Concentric. Height  
2'9½", width 1'9½",  
depth 1'0½".



The *'Chatsworth'* R.T.  
Height 33½",  
width 15½",  
depth 10¾".

70% OF THE  
MONITOR GOLDS  
PRODUCED ARE  
EXPORTED TO:  
U.S.A.  
JAPAN  
CANADA  
SOUTH AFRICA  
AUSTRIA  
ITALY  
SINGAPORE  
HOLLAND  
GERMANY  
BELGIUM  
SWITZERLAND  
NORWAY  
SPAIN  
AUSTRALIA  
NEW ZEALAND  
THAILAND  
ZAMBIA  
KENYA  
HONG KONG  
MALAYSIA  
FRANCE



*"III LZ Mk. II"*  
Aperiodic enclosure  
with III LZ unit.  
Height 1'3", width 1'11", depth 9¾".

**TANNOY**  
NORWOOD ROAD • WEST NORWOOD  
LONDON • SE27 9AB  
TELEPHONE 01-670 1131

*The Majority of Recording and TV Studios use TANNOY Monitors*



## WHY NOT BUILD YOUR OWN

### EASY TO ASSEMBLE HI-FI EQUIPMENT IN KITS

Clear pictorial illustrations and step by step instructions

**V-300 TURNTABLE KIT £18.25**

**'PAPST SYNCHRONOUS MOTOR**

**RB 101 BELT DRIVEN TT KIT £18.00**

**OPTIONAL extra for all models £9.75**

---

### NEW! P105 PICKUP ARM KIT

10½" Tracking Radius, Bias Compensator, Ultra light headshell,  
Raise/lower control, needle roller bearings

only **£11.75**

---

# VALEK LIMITED

**Lark Street Darwen Lancs BB3 2LT Tel 71881**

---

Please send me full details to

Name .....

Address .....

# KEF WHITE SOUND



nothing is quite like it

## The Cadenza; a new concept in bass reproduction

### How the KEF Cadenza offers a higher degree of low frequency than other speakers of its size

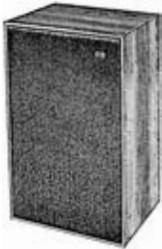

<b>Specification</b>	
Size	23 $\frac{5}{8}$ × 14 $\frac{1}{4}$ × 11 $\frac{3}{4}$ in 60 × 36 × 30 cm
Weight	34 lb 15.5 kg
Power Rating	25W
System Res.	Mechanical reflex 25Hz
Impedance	8 ohms
Freq. Range	30-30,000Hz
Units	BD139, B200, T27
Dividing Frequencies	45Hz, 3,500Hz
Finishes	Walnut, Teak, White
Grille Cloths	Brown, Grey, Beige
Recommended Price	£42.50

For many years, it was considered that the low frequency response of a speaker was dependent on the diameter of the diaphragm, and that a relatively compact enclosure could not achieve a satisfactory bass level without a loss of acoustic efficiency. The introduction of the KEF Cadenza showed that this need not be and that a compact speaker like the Cadenza is fully capable of producing fundamental tones down to 30Hz.

#### Acoustically-coupled system

The concept of bass reproduction featured in the Cadenza is based on acoustic coupling. In the Cadenza, two low-frequency radiating elements—the KEF BD139 and the B200—are acoustically-coupled to give the system an effective radiating area which is greater than that of a 12" unit. The low frequency radiator (the BD139) is acoustically-coupled to the B200 via the pneumatic spring formed by the trapped air within the enclosure. The acoustic mass of the BD139 is critically adjusted with respect to the volume of the enclosure so that it "phase inverts" the radiation from the rear surface

of the B200 diaphragm—thereby increasing the low frequency output over the range from 25-100Hz.

#### Inhibiting Colouration

Above 100Hz, the BD139 is acoustically decoupled from the B200 so that its output is progressively attenuated leaving the B200 as the only radiating source up to the upper crossover frequency of 3,500Hz. Over this frequency range, the BD139 acts as an acoustic barrier so preventing any sound radiating from the rear of the B200 diaphragm mixing with the directly-radiated sound and causing colouration.

#### A note about the B200 bass mid-range unit

The B200 has a very large magnet assembly to ensure optimum magnetic damping when used with the special bass loading system in the Cadenza. A visco-elastically damped cone minimises colouration in the critical mid-frequency band. A free air resonance of only 25Hz and a long linear suspension system ensure high power handling with low harmonic distortion.

#### T27 high-frequency tweeter

The T27 used in the Cadenza has an excellent transient response and wide frequency range extending at least one octave above the upper hearing limit—only 4dB down at 40kHz.

#### KEF exclusive 'constant impedance'

The KEF Cadenza incorporates a sophisticated 9-element two-way filter which uses close tolerance components for accurate and repeatable acoustic performance. An exclusive KEF 'constant impedance' network incorporated in this filter keeps the system input impedance flat and resistive over the frequency range from 100 to 10,000Hz. This ensures optimum power transfer from amplifier to speaker and the non-reactive load minimises the possibility of amplifier instability.



**KEF Electronics Ltd**

Tovil, Maidstone, Kent Tel: 0622 57258

# Sound like the pro you'd be if you were recording for money instead of love.

If you're serious about tape, the TEAC 3300 is a tape deck you can take seriously.

It'll accept 10½-inch reels, like a professional deck, for up to 6 hours of recorded material. And it has professional features you won't find on any other tape deck for the price.

Like the new Front Panel Bias Switch for the proper selection of bias current and recording equalization for either conventional tapes or the new low noise/high output tapes.

And expanded scale professional-type VU meters for each channel. The wide excursion scales simplify recording at higher (up to 6dB) signal levels, a must when using the new tapes, assuring better signal-to-noise ratio and an expanded dynamic range.

Another is TEAC's unique Edi-Q, an electronic pause control; it interrupts taping but keeps the recording amplifiers on and ready, eliminating recording clicks and tape bounce during quick-start operation.

Of course the 3300 has the kind of professional specs you'd expect from TEAC (after all, we make the professional systems too) — S/N: 58dB, wow and flutter: 0.06% and frequency response: 25–24,000Hz ±3dB; 30–20,000Hz) at 7½ ips.

Before you spend your money on any tape deck, spend some time with the TEAC 3300. At your dealer's.

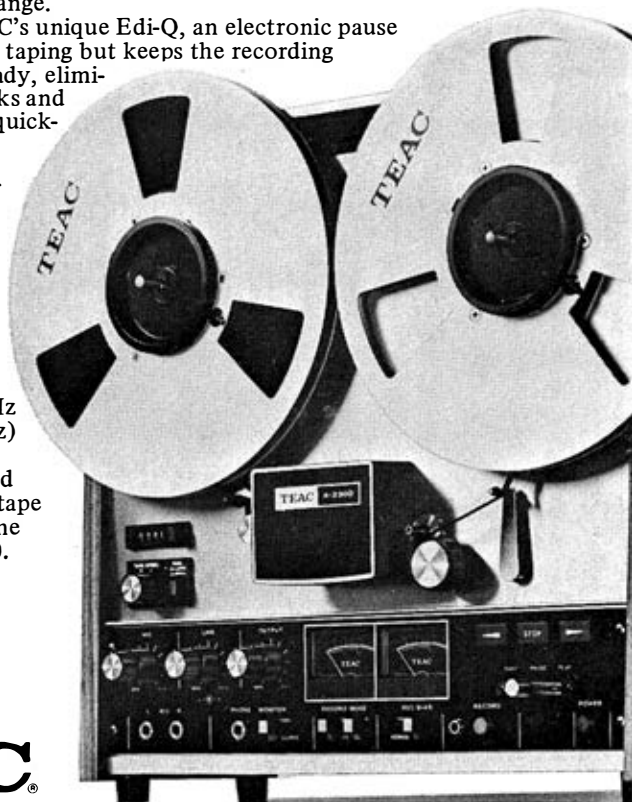

## TEAC®

A Sound Idea

TEAC EUROPE N.V., ADMINISTRATIVE OFFICE: Kabelweg 45-47, Amsterdam W.2, Holland Tel: 020-12 44 04  
TEAC EUROPE N.V., WIESBADEN OFFICE: 6200 Wiesbaden-Dotzheim, Wiesbadenerstrasse 68, West Germany Tel: 06121-42791

# Specialists in Sound

High Fidelity equipment can only safely be bought from a SPECIALIST DEALER. When buying from KEN ROSE AUDIO you get only the best equipment PLUS:—

1. *A 24 month unconditional warranty — ALL PARTS and LABOUR FREE.*
2. *FREE Loan equipment while yours is being repaired.*
3. *Hire purchase terms or Paybonds Personal Loan Scheme, NO DEPOSIT CREDIT.*
4. *Speaker comparison facilities—All outfits installed before purchase.*

## ACCREDITED DEALER FOR

Quad, B & O, Sony, Tannoy, Revox, KEF and all the other quality manufacturers.

Please Note:- *We sell Hi-fi only—we do not stock “Audio” quality components.*

Complete Hi-fi outfits from about

**£125.00**



**KEN ROSE AUDIO**

283 FLEET RD, FLEET, HANTS. tel: 5053

# Agfa Low Noise Tape in spools & cassettes

You'll know a good thing when you hear it



AGFA-GEVAERT