

hifi

FOR BEGINNERS

by John Borwick



A MILES HENSLAW PUBLICATION



SEVEN & SIXPENCE

HI-FI FOR BEGINNERS

By
JOHN BORWICK



Published by

MILES HENSLOW PUBLICATIONS LIMITED,
99 MORTIMER STREET - - LONDON, W.1



HI-FI YEAR BOOK

<i>First published</i>	1956
<i>2nd Edition</i>	1957
<i>3rd Edition</i>	1958
<i>4th Edition</i>	1959
<i>5th Edition</i>	1960
<i>6th Edition</i>	1961

HI-FI FOR BEGINNERS

First published 1961

Titles in Preparation

Stereo for Beginners
Tape for Beginners
Amplifiers for Beginners

CONTENTS

	<i>Page</i>
Chapter One.—<i>WHAT WE NEED</i>	5
What we need, and why we want it—counting the cost—Hi-Fi aims—reading the technical specifications—frequency response—purity of tone—quiet background—spacial effect.	
Chapter Two.—<i>LOUDSPEAKERS</i>	15
The importance of size—plain baffle—open cabinet—infinite baffle—folded horn—bass reflex—directional effects—woofers and tweeters—the electrostatic speaker.	
Chapter Three.—<i>AMPLIFIERS</i>	23
How many watts?—negative feed back—the power supply—the control unit—pickup matching—gramophone record equalisation—bass and treble controls—high pass and low pass filters—output voltage—planning ahead for stereo.	
Chapter Four.—<i>PICKUPS</i>	31
Crystal and magnetic pickups compared—pickup sensitivity—pickup distortions—tracking error—record wear—styli.	
Chapter Five.—<i>TURNTABLES</i>	37
Transcription motors—synchronous types—stroboscopes—turntable levelling—disc care and cleaning.	
Chapter Six.—<i>TUNERS</i>	41
The VHF/FM service—radio terms defined—advantages of VHF/FM—switched versus free tuning—self-powered tuners and “power supply needed”—earth loops—sensitivity—the transmitted signal—the propagation of wireless waves—aerials for AM only— aerials for VHF—where should the dipole be?—a do-it-yourself dipole.	

CONTENTS

	<i>Page</i>
Chapter Seven.—<i>TAPE</i>	49
Tape and disc compared—full-, half- and quarter-track tape recording—tapeheads and gap widths—tape equalisation—tape in the Hi-Fi system—recording via the Hi-Fi gear—care of tape.	
Chapter Eight.—<i>STEREO</i>	57
Stereo defined—stereo on tape—stereo by radio—stereo on disc—what you need for stereo—how to accommodate stereo.	
Chapter Nine.—<i>INSTALLING HI-FI</i>	65
The connecting cables—learn to respect the Mains Supply—other types of plug and flex—to earth or not to earth—co-axial “phono” plugs—installing a turntable—installing a pickup—installing an amplifier—using the controls—choosing and positioning the loud-speaker.	
Chapter Ten.—<i>QUESTIONS AND ANSWERS</i>	73

WHAT WE NEED

The pleasure we get from attending a musical performance—or from listening to its “canned” counterpart via radio, disc, or tape—is difficult to define, but is none the less real for all that. And the more we listen to music (look at paintings, read poetry, study chess, or occupy ourselves with any one of a hundred brain-exercising pastimes) the more critical we become; we set ourselves higher and higher standards, and come down more and more heavily on the mediocre and second rate.

In the comparatively narrow field of “canned” or reproduced sound, which forms the subject of this little book, striving for something better has enabled us, in the space of a few decades, to reproduce sounds with almost incredible realism, faithfulness, *high fidelity*; and the Hi-Fi boat continues to push ahead, with a few visionaries at “the sharp end”, and the rest of us paddling away merrily amidships.

Naturally enough, at any given moment, the best quality of reproduction needs the latest and most expensive equipment. Nevertheless, it is now possible to

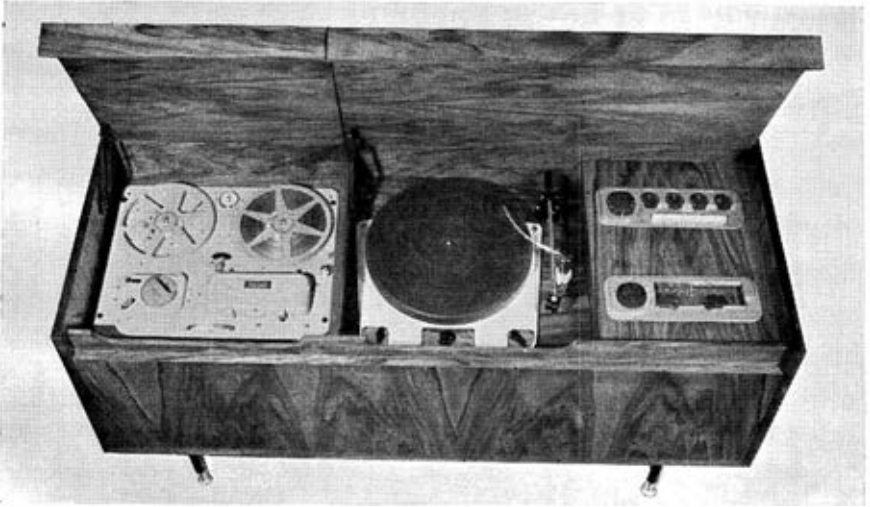

This Largs of Holborn cabinet brings together tape, disc, and radio Hi-Fi.

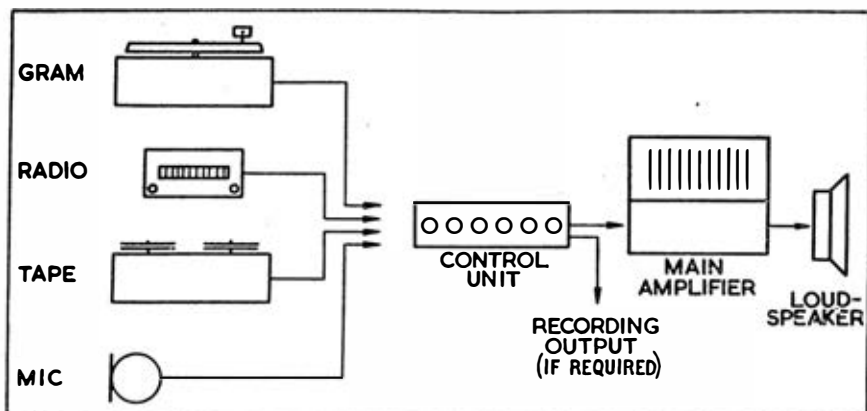

Fig. 1.1—The basic requirements for Hi-Fi may include microphone and tape facilities as well as radio and gramophone inputs. These are selected and filtered by the control unit, amplified by the main amplifier, and reproduced through one or more loudspeakers.

achieve, with a fairly simple set up, a highly satisfactory standard of quality. At a bottom price of approximately £70, or even a little less if you can make up some of the items at home, you can get sound reproduction—because, when all is said and done, it's the *sound* we're after—noticeably better than that from an autochange, gold-trim, piano-finish radiogram at twice the price.

Hi-Fi Requirements

It will be best to examine what we need for Hi-Fi, in skeleton form to begin with, and fill in the rest as we go along. Looking at the diagram (**fig 1.1**), the bones of Hi-Fi are seen to be (a) the sources of programme—gram, tuner, and tape units, (b) the control unit/pre-amplifier, (c) the main amplifier, and (d) the loudspeaker.

(a) *The sources of programme:* modern long-playing gramophone records (anyway the *best* of them) are the finest, and the most universal source of high quality programme material, but they do cost money (up to 47/- for a 12-inch LP) and it would seem obvious that the price laid out on a high quality pickup, which causes as little record wear as possible, is a sensible investment. Pickups range in price from £2 10s. to £32, and are discussed in Chapter Four.

The ordinary run of the mill gramophone motor will not do for Hi-Fi. It is too noisy—both in the mechanical and electrical sense—and we need a Transcription type turntable. This has a powerful, quiet motor, and an intentionally heavy turntable plate which will minimise undesirable speed fluctuations. Transcription turntables range in price from £17 to £54, and are discussed in Chapter Five.

BBC radio transmissions—live and recorded—are a continuous and inexhaustible source of Hi-Fi programme material, and the VHF/FM service in particular gives a high standard of technical quality. An FM tuner is what we need. This can have switched or variable tuning, and may include the ordinary

WHAT WE NEED

AM wavebands (Long, Medium, and Short) if we plan to listen to foreign stations. Tuners range in price from £15 to £50, and are discussed in Chapter Six.

The “business end” of a tape reproducing system is the tape deck carrying the spools, drive motor, and magnetic head. The signal derived from a tape head is very small, however, and there are only a few amplifiers on the market which will cope with this. The answer then is to fit a small boosting amplifier, or alternatively employ a complete tape recorder, taking the feed to the Hi-Fi system from the recorder’s own amplifier. Tape decks range in price from £13 to £60, and are discussed in Chapter Seven.

(b) *The control unit / pre-amplifier* is the heart of the Hi-Fi system. It acts as a kind of telephone switchboard, accepting the various input signals—disc, radio, and tape, correcting for any distortions, and allowing the volume and tone to be controlled prior to feeding the main amplifier.

(c) *The main amplifier* is designed to raise the strength of the programme signal from something like half a volt to the 5 to 20 watts needed to drive the loudspeaker. A modern Hi-Fi amplifier can easily handle the full audible range of frequencies, and is virtually silent in operation. Control unit/amplifier combinations range in price from £17 to £65, and are discussed in Chapter Three.

(d) *The loudspeaker* normally contains no “electronics” as such, but simply acts as a converter (transducer) accepting the electrical signals from the main amplifier and radiating these in the form of sound. A complete loudspeaker system comprises one or more *drive units* with an associated *baffle* or *enclosure*. Its operation may be compared to that of a musical instrument, and indeed the design problems have much in common. There now exist many types of speaker, ranging in price from £16 to £169, and these are discussed in Chapter Two.

Counting the Cost

It will be well, at this point, to consider the desirability of balancing the cost of the various units. Naturally enough, the range in price for each item corresponds pretty closely to an increasing standard of reproduction and flexibility.

Illustrating an ingenious space-saving set of cabinets from Record Housing. On the left is the gramophone, amplifier and tuner cabinet; and record storage is provided by the right hand cabinet. In the centre is a special corner loudspeaker enclosure.



HI-FI FOR BEGINNERS

It isn't everyone who can decide to have the best, regardless of cost—even if such a simple solution were possible—and there comes along the need to *balance* the outlay, i.e., spread it evenly over the several links in the chain. It would be foolish to over-spend on one item, and hopelessly skimp on another. The table below will give an idea of maximum, minimum, and fair average costs.

Hi-Fi Aims

To end this introductory chapter, here are the aims of high fidelity reproduction defined in fairly technical terms. This is by way of being the most difficult part of the book to understand at a first reading, and you may certainly skip it meantime and pass on to the more practical sections. Full enjoyment of Hi-Fi, and confident shopping for the right components, necessitates at least a nodding acquaintance with the technical terminology used in equipment specifications, however, and you will certainly wish to return to this section in due course.

Sound travels outwards from its source by setting an ever widening wavefront of air particles into vibration—the process has been likened to the shock wave sent along a line of goods trucks during shunting operations—and the aim of Hi-Fi is, by means of these air vibrations, to reproduce the same set of mental impressions in the listener as he would receive in the presence of the original sound. Whether reproduced sound achieves a high standard of fidelity depends on its success on four counts, as follows:

(a) *Wide frequency response*—i.e., the ability to play the lowest audible tones through to the highest that can be heard, with the same relative levels that occurred in the original performance.

(b) *Purity of tone*—i.e., avoidance of distortion.

(c) *Quiet background*—i.e., avoidance of inherent noise and suppression of interference from other sources.

<i>Item</i>	<i>Maximum</i>	<i>Minimum</i>	<i>Average%</i> <i>(approx.)</i>
Pickup and Arm	£32	£5	7½%
Transcription Turntable	£54	£16	20%
Pre-amp—Control Unit plus Main Amp	£65	£18	25%
VHF/FM Tuner	£50	£15	20%
Loudspeaker and Enclosure	£165	£16	27½%
TOTAL	£366	£70	£100



*This idea for housing Hi-Fi in home surroundings was designed by Alan B. Pear of Sheffield, and was featured amongst samples of readers' Hi-Fi in **Hi-Fi News**. Note the ventilation on the right, which is adjacent to the main amplifier compartment.*

(d) *Spacial effect*—i.e. the ability to convey the sense of breadth and depth of the original sound source.

These four points will now be examined in order.

(a) Frequency Response

The musical pitch of sounds depends on the frequency of vibration of their source, i.e., the number of complete vibrations or cycles performed per second. For example, any structure vibrating regularly at 440 cycles per second will produce the note A on the Treble Clef (established as Concert Pitch by agreement in 1939). This is the A above middle C on the piano, and 440 c/s is the vibration rate of the A strings, and of any other source of this note—air column in a trombone, circular saw, loudspeaker, etc. The human ear can respond to air vibrations over a range of about 10 octaves—20 c/s to 20,000 c/s—and Hi-Fi equipment should, ideally, handle this full range if all sounds are to be faithfully reproduced.

Readers with a mathematical bent may have calculated the frequencies of the 7 octaves of A on the piano (going up or down one octave means doubling or halving, respectively). They are as follows:—

A_4	A_3	A_2	A_1	A	A^1	A^2	A^3
27.5	55	110	220	440	880	1,760	3,520

It might be thought from this that the piano's whole range of tone could be reproduced through a system passing frequencies from 27.5 c/s to 3,520 c/s only. But the fact is that no structure—with the possible exception of a tuning fork—will normally vibrate at a single frequency only. There is the main, or *fundamental frequency*, by which we *pitch* the note, but additional frequencies or "overtones" are generally present—we call them Harmonics when they are exact multiples of the fundamental frequency—and these too must be reproduced in correct proportion for High Fidelity. That strings are particularly

HOW TO READ GRAPHS

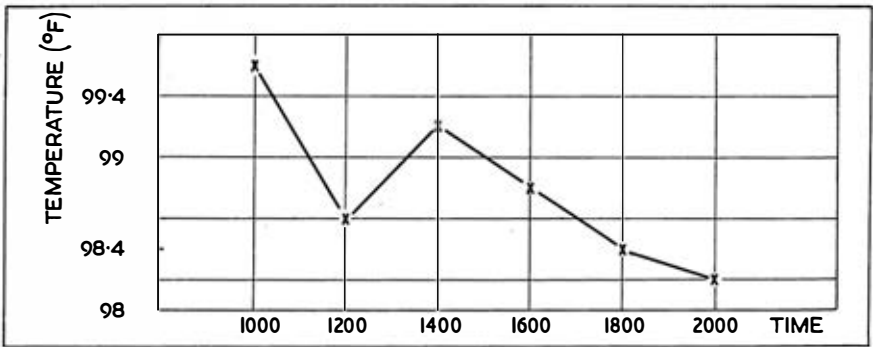

Fig. 1.3—Starting with the familiar temperature chart, in which the Temperature is plotted against Time at two-hourly intervals (x), and a graph is formed by joining the crosses with straight lines.

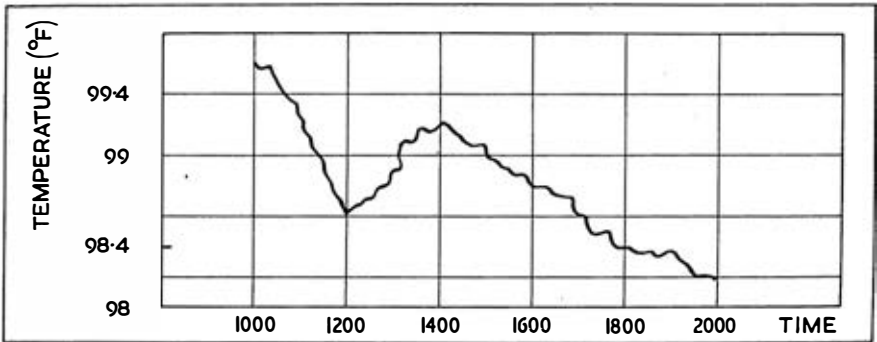
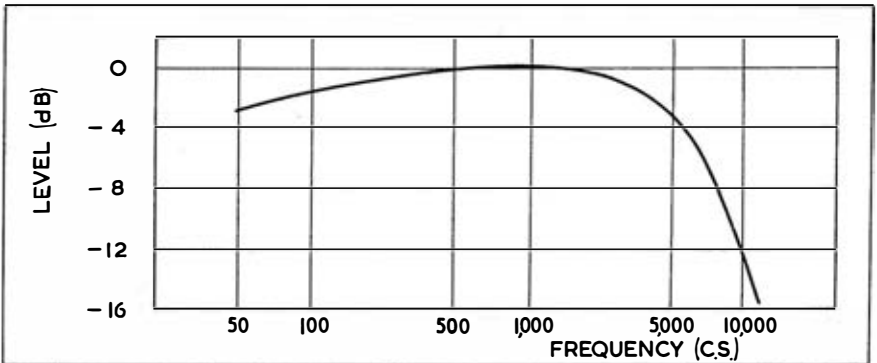

Fig. 1.4 (above)—The same temperature chart as it would appear if plotted continuously. **Fig. 1.5** (below)—A typical frequency response graph based on the readings in the Table opposite. The graph shows dramatically the drop in response at high frequencies.



rich in harmonics will be seen from **fig. 1.2**, which represents in vertical lines the relative strengths of the harmonics of the A string of a violin.

The frequency responses of pickups, amplifiers, loudspeakers, etc., is shown in the form of a graph, plotting frequency along the base line, and level vertically. In case you are unfamiliar with this use of graphs, the following digression may be useful. A graph—any graph—is a kind of shorthand method of dis-

Fig. 1.2—*The vibrations of a violin string are particularly rich in overtones or harmonics, up to and beyond the limit of human hearing.*

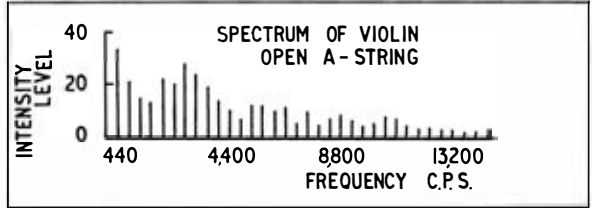

playing the results of a series of measurements or calculations. The figures involved could equally well be listed in table form, but, as we shall see, the graph has a number of advantages.

Take the familiar example of a series of temperature readings taken at regular (two-hourly) intervals. These could be tabulated as follows:

Time:	10-00	12-00	14-00	16-00	18-00	20-00	(Hours)
Temperature:	99.6	98.6	99.2	98.8	98.4	98.2	(°F.)

But marking these on squared graph paper, using the horizontal scale for Time and the vertical scale for Temperature, gives a more immediate indication of the general trend of the readings (see **fig. 1.3**). Joining the crosses by a series of straight lines is guess-work, of course, since the actual temperature variations between the two-hourly checks may or may not have taken the form of straight-line changes—almost certainly not.

An Immediate Picture

However, the graph gives an immediate picture of the day's readings. If greater accuracy were required, more frequent readings would be necessary, say at half-hourly or 10-minute intervals. In the extreme, a continuous-reading instrument on the lines of a pen-recording barometer would produce a graph covering every moment of time, and might look like the drawing in **fig. 1.4**.

In dealing with sound reproducing equipment, it is usually considered good enough to make measurements at a series of spot frequencies of the kind shown in the table below.

Frequency:	50	100	200	400	600	800	1,000 (c/s)
Level:	-3	-2	-1	-0.3	0	0	0 (dB)
Frequency:	2	4	6	8	10	12	14 (Kc/s)
Level:	-0.2	-2	-4.5	-9	-12	-14	-16 (dB)

HI-FI FOR BEGINNERS

The level readings are taken on some suitable voltmeter or wattmeter (according to whether it is voltage or power which particularly interests us in the circumstances) connected at the output of the apparatus, when a fixed level tone at each spot frequency is fed to the input. The Frequency Response graph resulting from the figures shown, would be as drawn in **fig. 1.5**.

It will be seen that a smooth curve passing through the measured points is preferred to the series of straight lines employed on Temperature Charts. The curve is felt to be a fairer guess of the response at intermediate frequencies. The frequency scale looks a little odd at first, in that equal divisions have not been allotted to an equal number of cycles per second. This type of scale—referred to as a Logarithmic Scale—is preferred at Audio Frequencies because the ear estimates pitch changes by reference to the ratio of frequencies rather than the difference in cycles per second.

The level scale too makes use of logarithmic rather than linear units, since once again the ear “thinks” in terms of ratios. However, instead of getting our-

HI-FI BUDGETS

We show here one or two suitable combinations of Hi-Fi units to comply with given fixed budgets. These should be regarded as rough guides only, since there are a great many alternatives which a reliable dealer would be able to suggest.

	£	s	d		£	s	d
Turntable —Collaro 4TR200	14	18	0	Amplifier —Pye Mozart HF10			
Pickup Arm —Goldring G60	4	3	5	Cabinet —Pye Mozart Lowboy	33	12	0
Cartridge —Goldring 580	5	6	9				
Control Unit —Dulci Stereo 8	23	2	0				
Amplifier —Dulci DPA 10	12	12	0				
Loudspeaker —Rogers 1284	26	10	0	Turntable —Garrard 4HF, with GC8			
				pickup cartridge	18	9	9
	£86	12	2	Loudspeaker —Wharfedale W3	39	10	0
					£91	11	9

	£	s	d		£	s	d
Amplifier —W. & N. Audiomaster Stereo	33	15	0	Control Unit —Acoustical Quad 22	25	0	0
Turntable —Goldring-Lenco GL59	24	16	3	Amplifiers —2×Quad 11	45	0	0
Pickup —BJ TAN/11 Arm, with BJ Stereo Cartridge	9	17	11	Turntable —Thorens TD 124	52	7	3
Loudspeakers —Two Richard Allan “Princess” in- cluding Golden Eight units	30	0	8	Pickup —Connoisseur CSI	13	0	0
				Loudspeakers —2×Quad ESL	104	0	0
	£98	9	10		£239	7	3

selves too involved in the kinds of scale used, let us see how the response curve may be interpreted.

The ideal “flat” response of an amplifier, or a microphone, say, would be a perfect horizontal line, centred on the reference zero level at 1,000 c/s. The graph of **fig. 1.5** shows a response which is fairly well maintained at low frequencies, but which falls away drastically at high frequencies. It happens that the ear can barely detect a level change of 2 dB, but the drop of 12 dB at 10,000 c/s would correspond to an extremely muffled and lifeless quality of reproduction. **Fig. 1.5** then, could be the Frequency Response curve of a very poor microphone, or perhaps an amplifier with the Treble control set to minimum top.

The significance of the final plus or minus so many dB, in a typical specification entry, such as “Frequency Response: 20–20,000 c/s ± 2 dB”, will now be apparent. It is an abbreviated way of telling us that, between the extreme frequencies quoted, the response curve remains within a pair of horizontal “tram-lines” 4 dB apart.

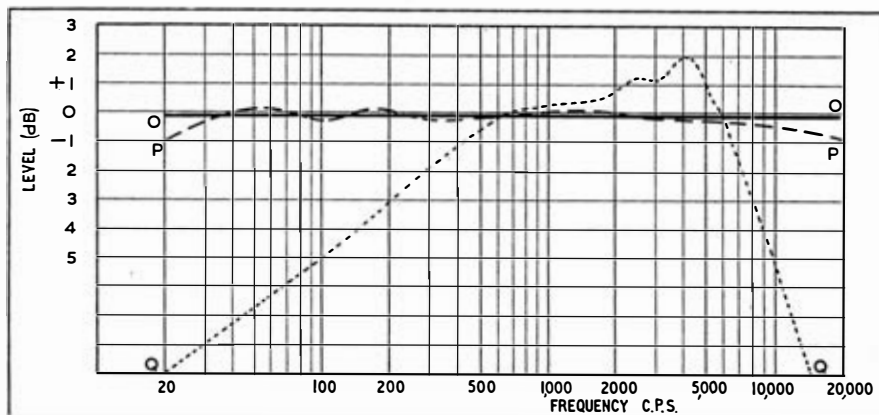

Fig. 1.6—The ideal response O—O compared with a typical Hi-Fi curve P—P and domestic quality Q—Q.

If you see a specification which omits the qualifying dB limits, be on guard, for this kind of statement is too vague for our purposes. In **fig. 1.6**, for example, the line O—O is the ideal flat response; P—P is real Hi-Fi; and could be written “20–20,000 c/s ± 1 dB”. But Q—Q, representing “Low-Fi”, might be optimistically advertised as “frequency response 20–20,000 c/s”, instead of in the more honest statements “200–4,000 c/s ± 3 dB”, or “100–8,000 c/s ± 5 dB”.

(a) Purity of Tone

Requirement (a), just discussed, is concerned with reproducing “the whole sound”. We now come to the question of reproducing “nothing but the sound”, i.e., avoiding the spurious generation of unwanted tones, or throwing certain tones into prominence. Each link in the reproducing chain may contribute distortion—and so may the transmitting and recording chains!—and there are

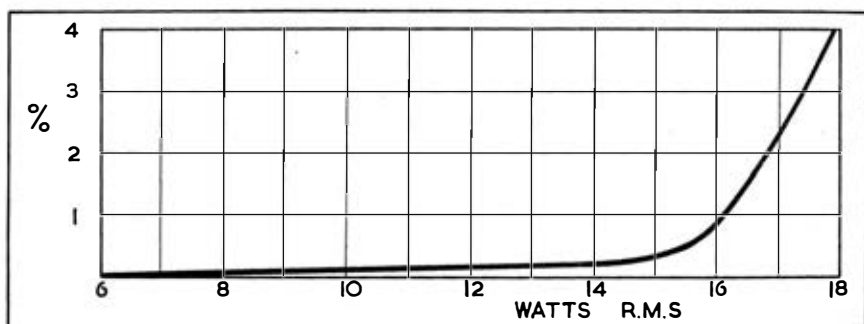

Fig. 1.7—The Distortion versus Power Level graphs (from *Leak Point One* review in *Hi-Fi News*) shows that distortion is very low indeed up to the rated 12 watts, and then rises steeply.

so many forms of distortion that too close a study of them by the ordinary listener can produce a species of audio hypochondria. That the engineers who design and manufacture Hi-Fi components should take a microscopic interest in distortion is good, of course, but the listener should rely on his ears rather than measuring instruments. For example, in the realms of Harmonic and Intermodulation Distortion, the untrained ear will tolerate the presence of the resultant spurious tones up to a level equal to some 2% of the original sound. But amplifier designers, knowing that this forms only one link in the whole chain, aim at keeping distortion below 0.1%. Distortion in an amplifier rises with signal level, so the specification is normally related to a certain power output, e.g., “Total Distortion less than 0.1% at 10 watts”. In technical reviews of amplifiers, the measured distortion at a spot frequency, usually 1,000 c/s, may be plotted against the power level. The result is a curve such as that in **fig. 1.7**.

(c) Quiet Background

The background noise in audio equipment is made up of stray signals—mostly mains hum at 50 c/s plus harmonics—picked up at points in the amplifier, leads, etc., and the inherent valve hiss. It gives rise to a voltage at the output, which may be measured and expressed in decibels as a fraction of the equipment’s rated output voltage. A *Hum and Noise* specification of 60 dB, for example, means that the rated voltage output is 1,000 times the background voltage (with the input short-circuited to earth.) This figure of 60 dB corresponds to a satisfactory quiet unit, and noise at -80 dB is completely inaudible.

(d) Spatial Effect

At best, reproduced sound can produce only an *illusion* of the original sound. For one thing, the loudspeaker is of fixed size, and yet must imitate by turns an orchestra, a single voice, a brass band, an operatic performance, etc, etc. However, the emergence of stereophonic sound reproduction, using two channels, has made possible the illusion of a broad “sound stage”, and a considerable increase in realism. A brief description of stereo is given in Chapter Eight.

LOUDSPEAKERS

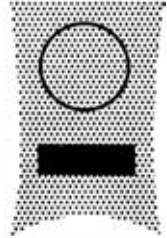

It was suggested in the opening chapter that a loudspeaker in some ways resembles a musical instrument. But there is this essential difference, that each instrument—bassoon, piccolo, violin or what have you—is built to radiate its own particular range of sound, *with its own characteristic quality of tone*, whereas the ideal loudspeaker must reproduce every conceivable sound—musical or otherwise—and do so without introducing any coloration or individual tone of its own.

Taking only the mere matter of size; the double bass is the largest instrument in the orchestra, and if you've ever seen the player struggling in and out of a taxi you must have wondered "Does it need to be so big as all that?". Well, the answer is that it does, and any smaller instrument would not produce the volume or sonority that has evolved as the modern double bass. Size is important in a

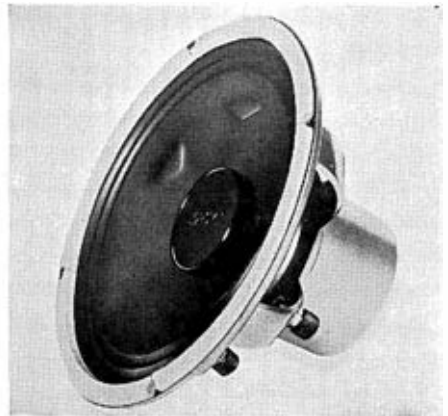
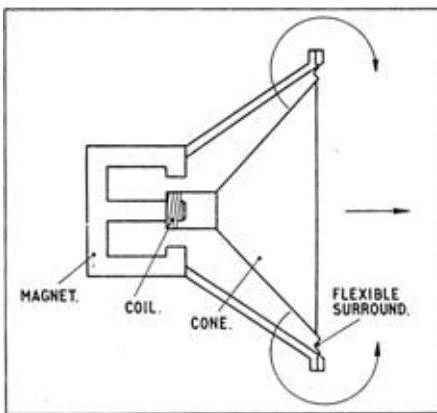

Fig. 2.1—The construction of a moving coil speaker, showing how the cone radiates backwards and forwards simultaneously. The photograph (right) is a GEC unit.

HI-FI FOR BEGINNERS

source of sound waves (or radio, light, heat waves) in two ways, and these underline the two principles involved in *generating* the sounds, and *radiating* them.

To generate sounds, some part of the instrument must be set into vibration, and the pitch of the notes on the musical scale is determined by the rate of these vibrations. (See also Chapter One.) Now the vibration rate (frequency) of any system is a function of its size (and its elasticity), and a general law applies—"The bigger the deeper". Secondly, the size of a sound source affects the efficiency with which it can radiate the waves. And once again, the low frequencies require a large source.

So the loudspeaker must comprise a generator—light and easily set in vibration; and be, or be housed in, an efficient radiator—large dimensions.

The familiar magnet/coil/cone combination constitute the generator or "drive unit", and a well-designed unit can be persuaded to vibrate evenly over a wide range of frequencies—say 40–12,000 c/s. But its radiating properties are poor since the cone vibrations send waves into the air forward and back simultaneously. The air disturbances can easily bend round the cone edge and weaken each other. (See **fig. 2.1**.)

The logical progression is to mount the speaker in a baffle (**fig. 2.2**) or an open-backed cabinet (**fig. 2.3**). This will cut down the interference of front and back waves, but not prevent it all together. To do this would require what is called an "infinite baffle", and there are two ways in which this is possible; (a) to mount the loudspeaker in a wall (**fig. 2.4**), with the back radiation "lost" into a spare room, or cupboard, or a disused fireplace! (b) to mount the loudspeaker in a totally enclosed cabinet (**fig. 2.5**). This latter solution has come much into

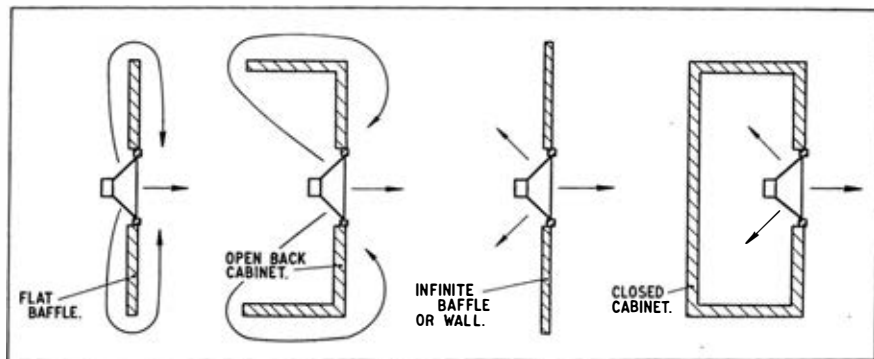

Figs. 2.2 to 2.5—Illustrating from left to right the open baffle, the open back cabinet, fixing in a wall, and the totally enclosed cabinet. In addition to preventing back radiation, the latter designs introduce a load on the drive unit.

the news in the last few years, and forms the basis of many of the small 2 ft. × 1 ft. × 1 ft. "bookcase" speakers designed to simplify the space problem for 2-speaker stereo. But the design of a totally enclosed cabinet is bristling with problems. Ideally we hope to lose the back radiation completely in imitation of an infinite baffle, and so thick layers of absorbent are packed inside, but these cannot absorb all the sound, and some drumming, or resonance, is likely,

LOUDSPEAKERS

unless the drive unit too is specially designed to match the enclosed cabinet exactly. The effect of the "stiffness" of the enclosed air on a speaker's resonant frequency may be seen from the typical figures in **Table 2.1**.

In a desire to turn the back radiation into a useful component instead of trying to lose it, a number of more or less elaborate enclosure types have been de-

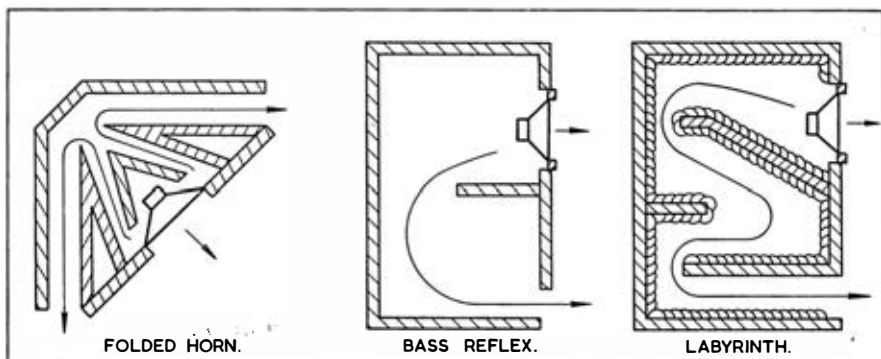

Fig. 2.6—In each of the above enclosures the back radiation is utilized.

veloped over the years. These include the folded horn (folded since the required length and taper could not be accommodated otherwise), the labyrinth, and the reflex. Elegant examples of each of these are currently available, and their outlines are sketched in **fig. 2.6**.

Directional Effects

We have avoided so far the question of directivity, but the fact is that virtually all sources of sound waves radiate in a directional manner—try walking round a trumpeter when he is playing, and you find that the sound *on the axis* is more brilliant than it is at an angle. This is due to the focussing of the high pitched

Table 1

SPEAKER	Off Baffle	BASS RESONANCE C.P.S.				
		1 cu. ft.	2 cu. ft.	3 cu. ft.	4 cu. ft.	5 cu. ft.
15" L.S.	25	105	85	77	70	65
12" "	35	116	85	75	70	65
12" "	55	120	95	85	78	72
10" "	52	105	82	74	70	68
9" "	25	116	77	65*		
8" "	75	108	92	85	80	78

* The "Q" of this resonance became too low to measure beyond this point.

A PAGE OF LOUDSPEAKERS

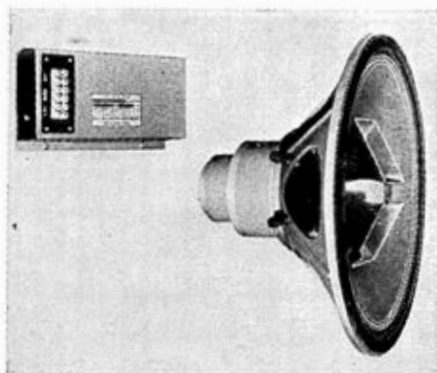

AEI K10A



Goodmans Triaxiom

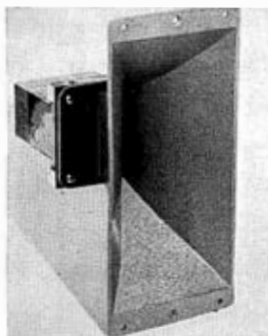

*Lowther
PM6*

*Kelly
Ribbon*

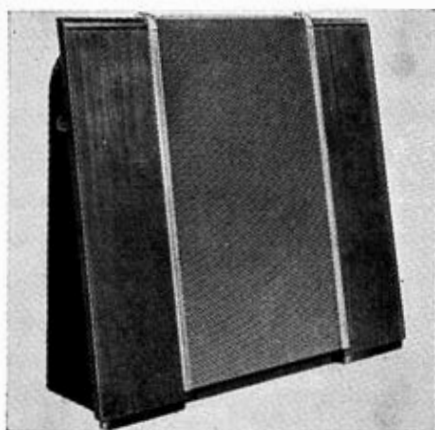

Wharfedale SFB/3

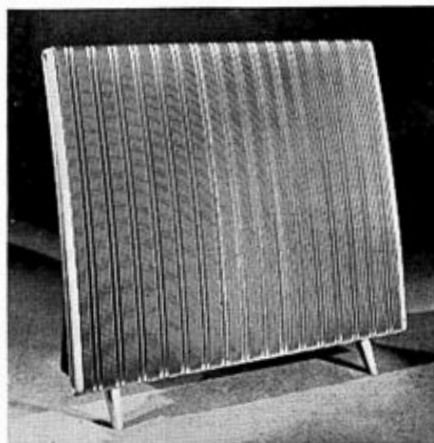

Quad Electrostatic Loudspeaker

LOUDSPEAKERS

components into a relatively narrow beam, and the same phenomenon applies to loudspeakers. A few experiments, moving your head through the axis, will demonstrate how true this is. This change in quality from one listening position to another is a great drawback, and an ingenious, if apparently wasteful, method of avoiding it is to arrange the drive unit on its back, so that the radiation is straight upwards (see **fig. 2.7**). Then no one is on the direct beam, and quality is the same anywhere on the horizontal plane. This method is generally found

Fig. 2.7—Column loudspeakers are designed to occupy a minimum floor area. The horizontal position of the drive unit gives an even radiation over the listening area, and a conical reflector is often added, as shown, to make good the loss of high frequencies.

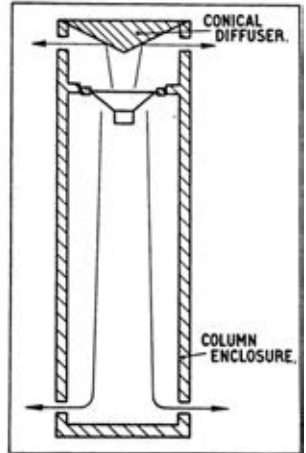
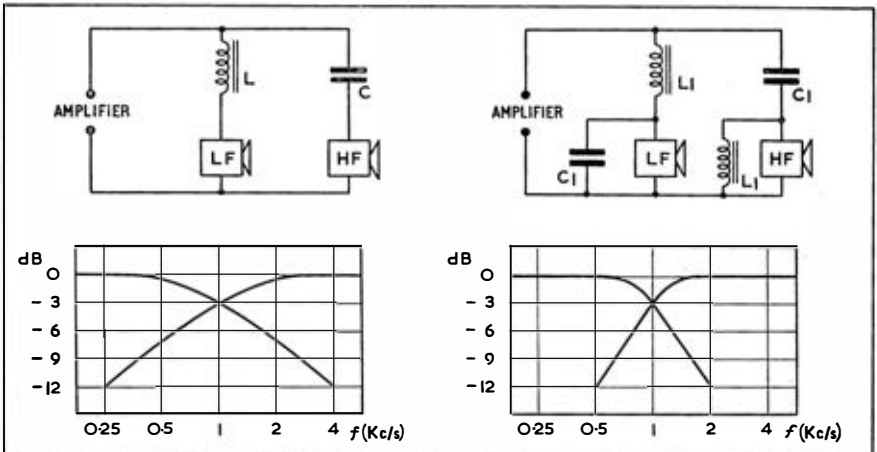

Fig. 2.8 (below)—Crossover units make use of inductance and capacitance to divide the signal between the low frequency and high frequency units. The left-hand circuit, referred to as a quarter section, introduces loss at 6 dB/Octave, and the right-hand, half section, 12 dB/Octave. To design your own crossover unit use the formulae as follows:—

$$\text{Quarter Section: } R = 6.28fL = \frac{1}{6.28fC}$$

$$\text{Half Section: } 0.707R = 6.28fL = \frac{1}{6.28fC}$$

where R = the loudspeaker impedance, and F = the required crossover frequency.



in column loudspeakers—designed primarily to occupy a minimum floor area—and there will often be a conical reflector to spread the high frequencies into the room too.

This focussing of high frequencies—which is worse with the larger coned speakers—has been a large factor too in the development of multi-way loud-speaker systems. If the signal from the amplifier is suitably shared between two

BUILD YOUR OWN REFLEX

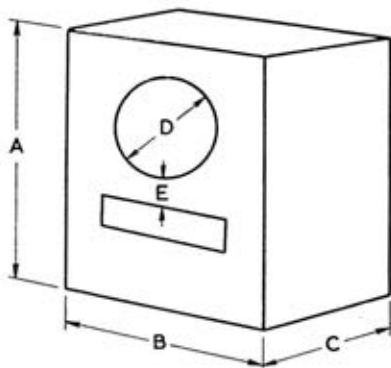

The bass reflex enclosure is rightly popular with home constructors, and thousands of these speakers have been designed and built by Hi-Fi enthusiasts.

As the diagram shows, the basic reflex cabinet consists simply of a rectangular box in which two holes are cut—a circular hole for the drive unit, and a rectangular port or vent, whose dimensions are fairly critical. First points to be settled are the drive unit's size (diameter), and its resonant frequency. The latter will be given in the manufacturer's literature, or you will find representative values in Table 2. In general terms, the drive unit's size determines the port area, while its resonance fixes the enclosure volume. You can go ahead using the dimensions listed on this page, or work these out from the following formulae:

Area of port $A =$ effective area of drive unit $= \pi R^2$, where $R =$ radius of cone.

Required volume of enclosed air for resonant frequency

$$f_0 V = \frac{4.66 \times 10^6 \times A}{f_0^2 \sqrt{A}}$$

Practical Details

You may use $\frac{3}{4}$ -in. thick blackboard, chipboard or plywood for the reflex, or even $\frac{1}{2}$ -in. thick timber at a push, but be sure that all joints are sound—glued and pinned or screwed, with corner fillets if necessary. The back may be unglued, but should be an airtight fit, with screws every 5 or 6 inches all round. The enclosure should be lined on all inner surfaces with an absorbent blanket—use glass wool, glass fibre, etc. etc. If some experimentation is required, perhaps because the drive unit resource has had to be guessed at, you can make the port area about $\frac{1}{4}$ oversize, and fit a sliding panel.

Speaker Diameter	D	E	Port Area (sq. in.)	Speaker Resonance (Average values) (c/s)	External Volume (cu. in.)	A	B	C
8	7	3	38.5	100	4,750	24	18	11
10	9	3	63	80	7,400	28	22	12
12	11	3.5	95	60	9,800	31	24	13
15	14	4	155	40	12,400	34	26	14

LOUDSPEAKERS

drive units—low frequencies to a large cone (*woofer*), and high frequencies to a small one (*tweeter*)—the directional effect is much reduced, and the listening position less critical. Some people, however, are more sensitive than others to the “detached top” effect with high and low frequencies coming from different points in space, and they will prefer the tweeter to be situated near to, or even on the axis of, the woofer.

A main *raison d'être* of the 2-way, 3-way, or 4-way speaker systems, which must be mentioned, is that it is in fact easier to design and build a speaker for 4 octaves than 8, and, provided the component speakers complement each other correctly, and have the appropriate crossover or dividing network, a very wide range system can result.

The Listening Room

It will be guessed by the careful reader of the foregoing that the room itself has a considerable effect on the performance of a loudspeaker—indeed the room may be regarded as an extension of the speaker, with the sound waves being reflected, focussed or diffused by the walls and furniture. The positioning of loudspeakers in a room is therefore worth taking some trouble over. The rear-facing horn-loaded types will need to go in a corner, of course, and indeed the corner position suits other speakers too since the side walls act as additional baffles (see **fig. 2.9**). The position of the listeners will help to determine the best speaker placement, and it will be better to avoid siting the speakers too far above or below the listeners' heads—say, 3 ft. 6 in.

A mistake to avoid is directing the loudspeaker straight towards an opposite wall, particularly if the wall surfaces are hard and reflecting, since “standing waves” are then set up by continued to and fro reflections, causing certain frequencies to stick out like the audible equivalent of a sore thumb!

The Electrostatic Speaker

The Quad Electrostatic Loudspeaker is unique in a number of ways, and every Hi-Fi enthusiast should hear it for himself, and compare the sound with conventional electromagnetic types. Firstly, it is the only full-range speaker in current production which employs electrostatic attraction to drive a flat

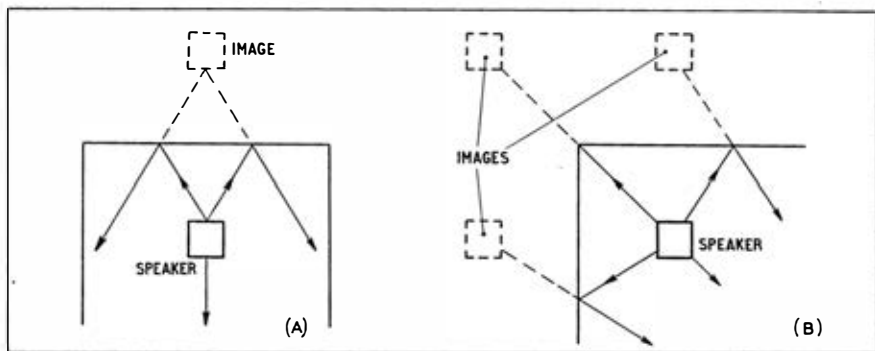

Fig. 2.9—Wall reflections behave as though secondary sound sources existed behind the wall.

diaphragm, instead of the usual moving-coil and magnet combination. Then, arising from this construction, it tends to radiate fore-and-aft, with a “dead” angle at the sides, and this, together with its complete absence of “boxiness” (there is no cabinet), gives the reproduction an “open window” effect which has many staunch adherents.

Impedances

The loudspeaker impedance will always be featured on the manufacturer’s specification, and may be 15, 7.5, or 3.5 ohms. The connecting lead—ordinary twin flex is ideal—should simply be taken to the appropriate terminals on the amplifier. When more than one loudspeaker is to be wired to a single channel, the parallel connection is used (see **fig. 2.10**), and never the series. It is important to *phase* the speakers correctly, i.e. ensure that a given voltage polarity causes both cones to move backwards or forwards. To check the phasing of loudspeakers, connect a flash-lamp battery to the leads, and observe the cone movement. If the cones move in opposite directions, reverse the leads to one of the speakers. Note that two 15 ohm loudspeakers connected in parallel present a

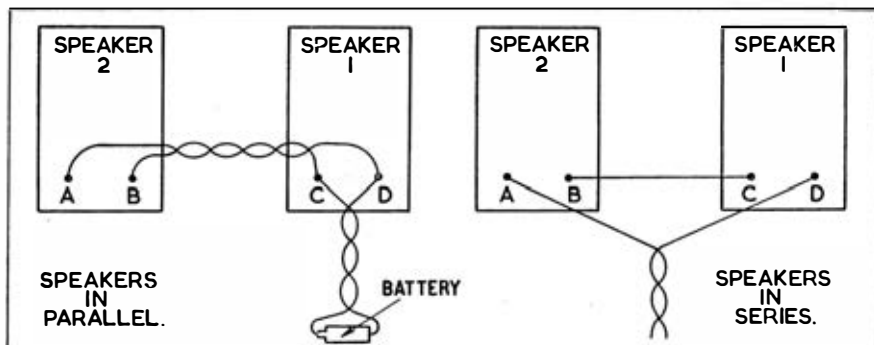
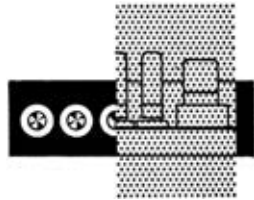

Fig. 2.10—The parallel connection (left) will usually be preferred, and may be tested using a battery.

combined impedance of 7.5 ohms, and so the 7.5 ohm amplifier terminals should be used.

The important bearing that the room has on the quality of reproduction from a loudspeaker (particularly a *good* loudspeaker) makes it vital to arrange for a trial at home, before purchase. A good dealer will gladly agree to this, or at least have a private listening room available got up to approximate domestic listening. Much more than the pickup and amplifier, the loudspeaker is a matter of individual taste, and choosing it should not be a hurried process.

AMPLIFIERS



It takes roughly 20 volts to drive a loudspeaker at a reasonable volume, and the voltage appearing at the output of the average pickup, tuner, tape unit or microphone is a mere 0.001 to 0.1 volts. The amplifier's first job, then, is to take in the tiny signal, and change it (helped by power consumed from the mains supply) into one big enough to drive the loudspeaker. To take care of the different degrees of efficiency of loudspeakers—i.e., some speakers need more voltage than others to produce a given volume of sound—and the varying loudness tastes of listeners, amplifiers are made in different sizes—2 watts, 4 watts, 10 watts, 20 watts, 60 watts, and so on. (Watts mean electrical power, found by multiplying voltage and current, and are used in this context in preference to volts as they correspond more closely to the sound intensity level.)

Whether you have a 20 watt amplifier (the largest size popular in this country) or a 4 watt, will not settle the loudness with which you can enjoy your Hi-Fi. With most loudspeakers you can make plenty of noise using a 4 watt job, but the actual power level in music or speech is continually varying over very wide limits, and the steep peaks in power—referred to as *transients*—occurring on speech consonants, cymbal clashes, etc., will be handled better by the more

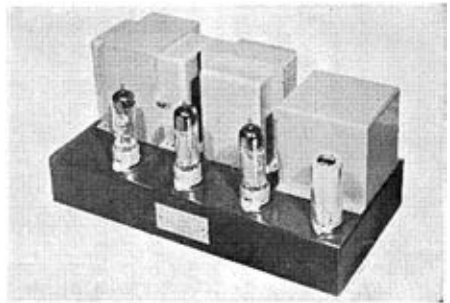
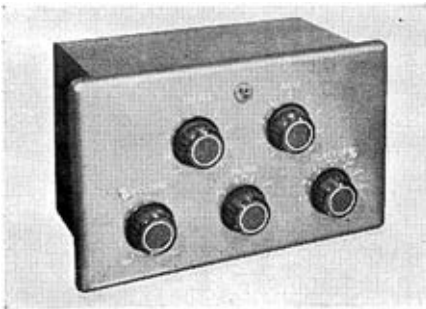

The Rogers RD Junior control unit and amplifier are designed as separate matching units.

powerful amplifiers. If asked to be specific, we should say 4 watts is an absolute minimum for Hi-Fi in a small room, and 10 watts adequate for most purposes.

The main job of amplifying the signals is straightforward enough, and power amplifiers by all designers follow a fairly established pattern. The greatest variations are found in the output circuits, i.e., the final stage valves and the transformer which feeds the loudspeaker. When a single power valve is used—generally in the low-wattage amplifiers only—this is referred to as a “single-ended” amplifier to distinguish it from the “push-pull” and “ultra-linear” types employing a pair of output valves. The latter are capable of handling more power, with less distortion, and are allied to another circuit device of which much is made in manufacturers’ literature, viz: “negative feedback”.

Advantages of NFB

Briefly this involves feeding a proportion of the signal back to an earlier part of the circuit, in reverse electrical sense. The overall result is a reduction of gain, but, more than compensating for this, a suppression of distortion. A block diagram illustrating NFB is given in **fig. 3.1**, and the effects of different amounts of feedback are shown in **fig. 3.2**. The chassis carrying the main amplifier also accommodates the power supply. This comprises a bulky transformer which takes in the 200–250 volts AC mains supply, and transforms this into the 6.3 volts AC, fed as Low Tension to the filaments of all valves, and a balanced AC voltage which the rectifier valve turns into DC. This DC is filtered via a condenser and choke/resistor “filter” and taken as High Tension to all valves. The remaining large component on the amplifier chassis is the output transformer. The final quality of reproduction is very much a reflection of the “goodness” of the output transformer, and, in the present state of the art, this calls for a fairly heavy component. Therefore any amplifier whose output transformer has been skimped should be suspect in the context of high fidelity.

The loudspeaker lead is connected to the output transformer, usually via a

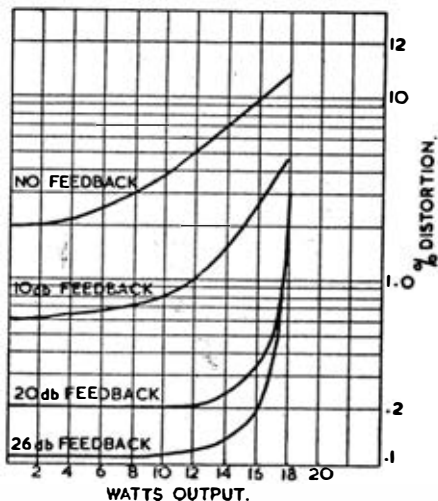
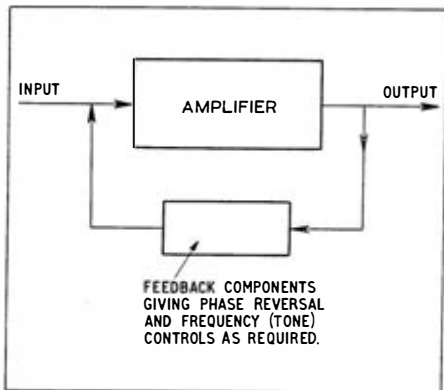

Fig. 3.1—Negative feedback reduces the gain of the amplifier, but results in improved overall performance, including reduced distortion, as in **fig. 3.2** (right).

AMPLIFIERS

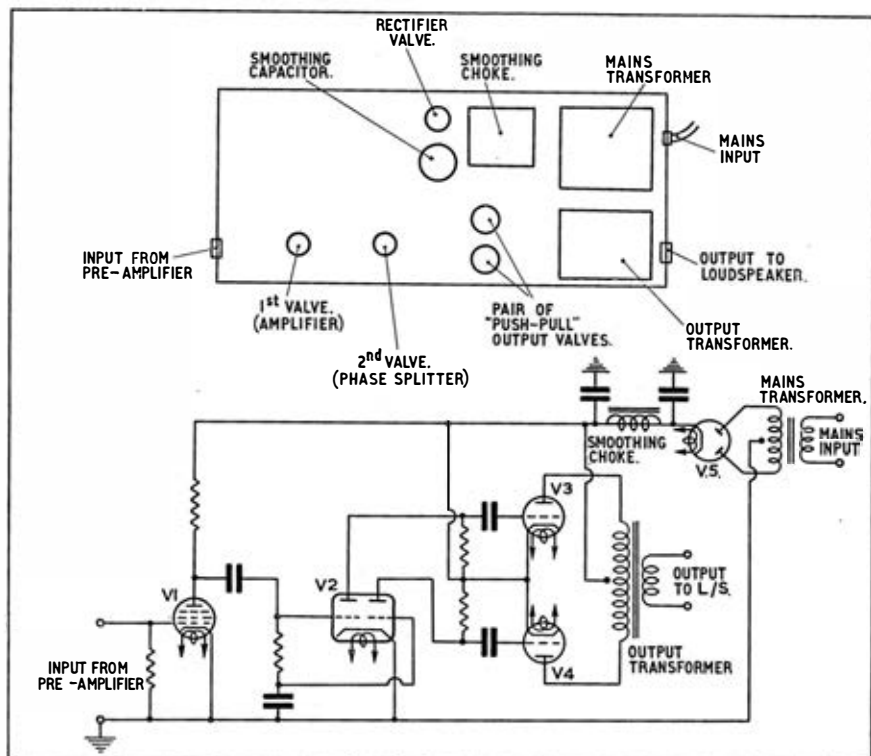

Fig. 3.3—The component layout and the valve stages in a typical Hi-Fi amplifier are shown in outline and circuit form. The power unit section (mains transformer, rectifier valve and large smoothing capacitors) will also supply HT and LT to the control unit, and perhaps a radio tuner.

tagboard carrying a pair of dome-shaped screws, and there may be alternative screws, or terminals, for matching different loudspeaker impedances. The nominal impedances standard in this country are 15, 7.5, and 3.5 ohms (see also Chapter Two), but if a unit is found rated at 16, 8, and 4 ohms (the USA standards) the small differences are not in the least serious.

The Control Unit

Whether it forms a separate box of tricks, or is “integrated” with the main amplifier, the control unit/pre-amplifier can be regarded as performing a distinct job if its own. As mentioned in the opening chapter, it is a kind of telephone switchboard and “out-patients’ department” combined. It selects the various programme sources, and “doctors” their frequency response where necessary, before feeding them to the main amplifier. The Radio input is straightforward enough, as no frequency correction is required, and a high signal voltage—anything from $\frac{1}{10}$ to $\frac{1}{2}$ a volt—is usual. So too is the extra input, labelled

A PAGE OF AMPLIFIERS

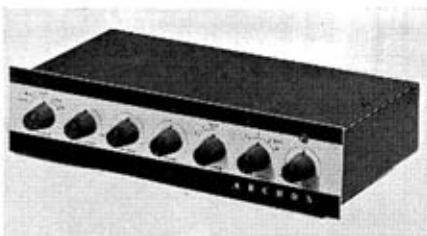
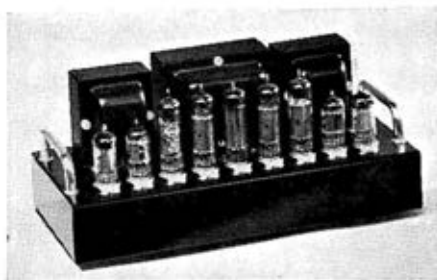

*Tansley-Howard Archon SP31 and
SL101 amplifier*



*Leak "Point One Stereo" control unit and
"Point One" Stereo 20 amplifier*



Tannoy Hi-Gain 15 combined amplifier

Rogers Master Control Unit



The "Emisonic" 555

AMPLIFIERS

Auxiliary, provided on many control units, and also the normal Tape input intended for replaying a tape recorder through one's Hi-Fi equipment. Note, however, that a number of the top line control units have a low level Tape input, designed to take the feed from a tape head *direct*, and incorporating the recognised replay characteristic (see Chapter Seven).

Undoubtedly the most varied and complicated input circuits are those for the pickup. As we explain in the next chapter, the output voltage—playing a given record—varies very much between one type of pickup and another, and so does their frequency “doctoring” requirements. Leaving the finer points of difference aside for the moment, we can say in general that a crystal pickup is rated at about 200 millivolts (0.2 volts) and requires little or no correction, whereas the magnetic pickups produce a mere 10 mV, and require bass boost and top cut. (See fig. 3.4.)

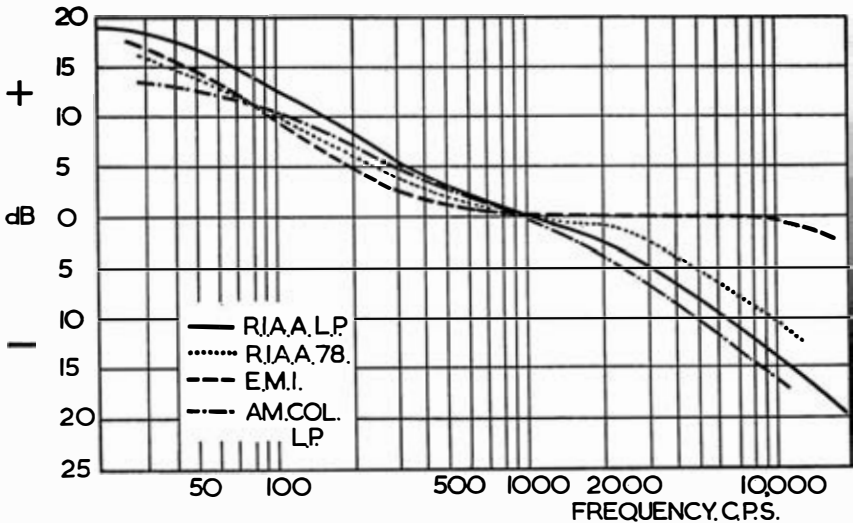

Fig. 3.4—Numerous gramophone playback characteristics have been in use from time to time, but introduction of agreed standards has made the two RIAA curves almost universal, and sufficient for most purposes. Two other characteristics are shown in the diagram for comparison.

The control unit manufacturers have employed a great deal of ingenuity to make their amplifiers capable of operating satisfactorily from any of the popular makes of pickup. They do this by including enough gain for the most insensitive pickups, and then throwing this away bit by bit to match the stronger types. Amongst the variable systems used are variable resistance (Leak), and changeable plug-in adaptors (Quad and Pye).

Gramophone Record Equalisation

At least up to 1955, the gramophone companies used different recording characteristics, that is they applied varying degrees of bass cut and top pre-emphasis during the recording process. To reproduce these discs it is therefore

HI-FI FOR BEGINNERS

desirable to select a mirror-image response curve, and many control units include switched positions, for the most common characteristics. Fortunately, since 1955 there has been world-wide agreement on the RIAA (Radio Industries

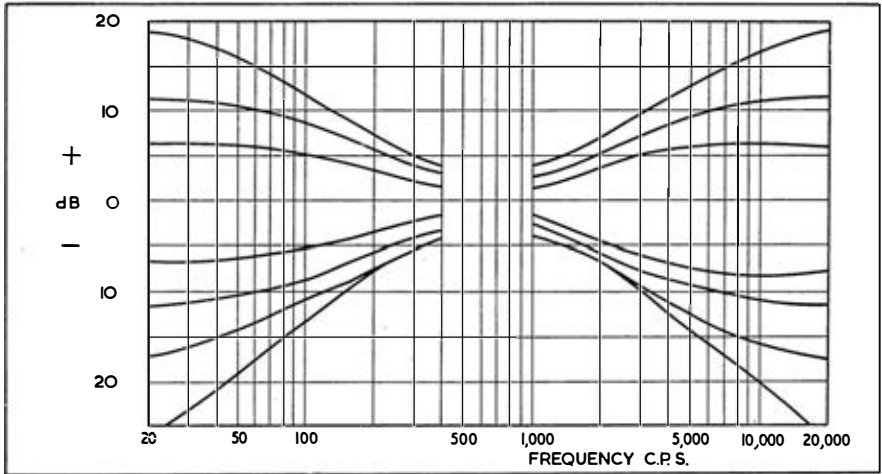

Figs. 3.5, 3.6—Comparing the passive tone controls (above) and the Baxandall type (below).

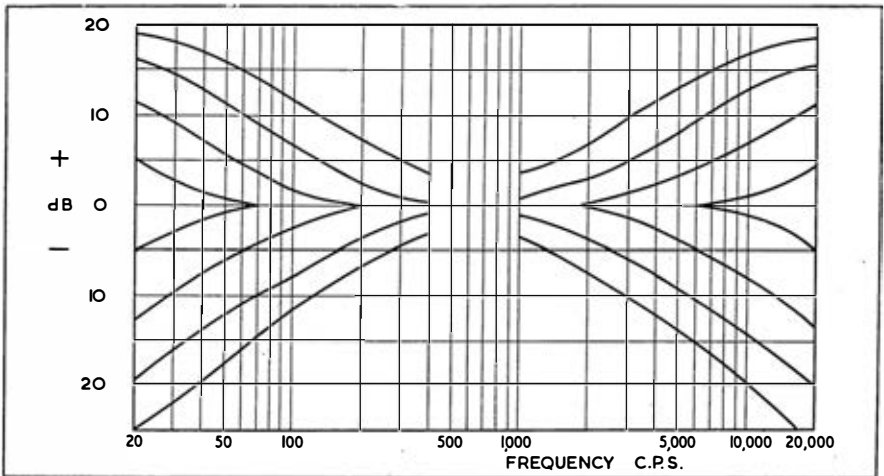

Association of America) characteristic, and most modern LPs are cut to this. In this country, the specification is sometimes referred to as BSS 1928/1955. If you possess no ancient records and no 78s, then this characteristic is all that you will want.

AMPLIFIERS

Bass and Treble Controls

There is little to be said on the subject of bass and treble controls since most people will please themselves about using them. In some hands they can be an absolute menace, and there are two species. There is the man who boosts both bass and treble until you get approximately the same sensation as you would if the amplifier were connected direct to your nerve fibres! And, by contrast, there is the bass and treble cutter, who wages a perpetual war on background hiss and rumble, to such good effect that all music appears to emerge from a long tunnel. However, used sensitively, the tone controls can often supply just the right antidote for cabinet or room acoustics, recording deficiencies, and indifferent broadcasts.

There are two distinct types of tone control circuitry in current use. The first involves no amplification (i.e., is "passive") and has the effect of swinging the frequency response about a central point, usually 1,000 c/s. Thus, even for slight amounts of bass or treble lift or cut, all frequencies beyond 1,000 c/s are affected (see **fig. 3.5**). The second, developed by P. J. Baxandall and becoming increasingly popular, introduces frequency discriminating networks into a feedback loop. This, besides keeping distortion to a minimum, has the advantage of affecting only the very high or very low frequencies to begin with (see **fig. 3.6**).

High Pass and Low Pass Filters

The comparatively gentle slope of the tone controls just discussed, usually 6 dB per octave, restricts their use somewhat when it is desired to attenuate motor rumble, or high frequency distortion on radio, etc. Accordingly, the more elaborate control units have additional filter controls. A high pass (rumble) filter can often be switched in which sharply attenuates downwards from about 35 c/s. At the high frequency end of the scale, it is usual to provide filters at a number of nominal frequencies—say, 6, 8 and 10 Kc/s, and an additional refinement is a slope control, which varies the steepness of roll-off at each switch setting—from, say, 8 to 30 dB per octave. This is illustrated in **fig. 3.7**.

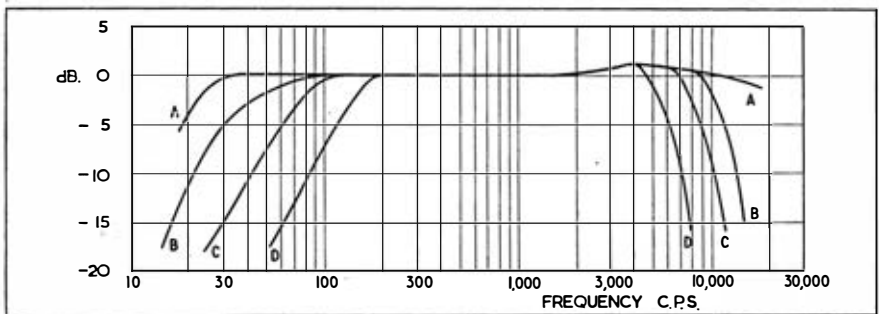

Fig. 3.7—In addition to the tone controls, special filters are often used to give increasingly sharp attenuation of high or low frequencies. These filters may be switched, or associated with a "slope" control.

Output Voltage

It is possible to provide many of the facilities of a control unit in a so-called "passive" circuit, which has no valves, and no amplification. But more flexibility and freedom from hum and noise with low level inputs demand one or more stages of voltage gain, and nowadays the terms control unit and pre-amplifier are synonymous. Just how much gain is provided varies from one unit to another, but most control units produce approximately 1 volt at the output terminals for the stated input signal.

Before attempting to "marry" a pre-amplifier to a power amplifier by a different manufacturer, you should investigate thoroughly. Even if the voltage rating is correct to load the amplifier for maximum output, it is likely that widely different plugs and sockets are fitted. Also, since most control units draw HT and LT from the main amplifier, as discussed in an earlier chapter, you must confirm that the HT voltage is correct, or can be adjusted to suit. If you are planning to record through the control unit, it is advisable to check that an auxiliary output connection exists to take to the tape recorder. Also there are very few units which feed this output via the tone and other controls. If you want this facility, look for one that does.

Why not Plan Ahead for Stereo?

Some readers will be getting organised with a stereo system, for two-channel reproduction of discs, or tape, or both. Most of the above remarks apply equally to stereo control units, the input sensitivities being quoted as "pickup 1.5 mV per channel", etc. Looking ahead to the more or less universal introduction of 2-channel reproduction, almost all makes of control unit are now being brought out in a stereo version. At the additional cost of a few pounds, it is probably a good idea to purchase the twin job, even if you are not yet ready for stereo. Adding a second power amplifier, and loudspeakers, etc., can be done later, but duplicating a monophonic control unit would be expensive, and would not provide ganged controls, and easy balancing.

PICKUPS



A gramophone pickup is essentially a generator of electricity. Wagging the needle (nowadays promoted to the rank of “stylus”) back and forth sets the generator to work, a movement to the left giving a positive voltage (let’s say) and to the right, negative. When lowered (not dropped!) on to a revolving disc, the stylus tip is forced to follow the wavy trace in the groove. If the recorded trace, for example, looked like **fig. 4.1** (a single note from a clarinet), the stylus movement would generate a voltage of similar waveform (the more similar the better).

Two physical principles are in common use for pickups—crystal and electro-magnetic. In a crystal pickup (see **fig. 4.2**) stylus movement is arranged to produce an alternating deformation of a piece of Rochelle salt. It is a property of this particular crystalline structure that bending in a certain plane produces a proportionate voltage on opposite faces. With electrical connections as shown, the required signal is obtained.

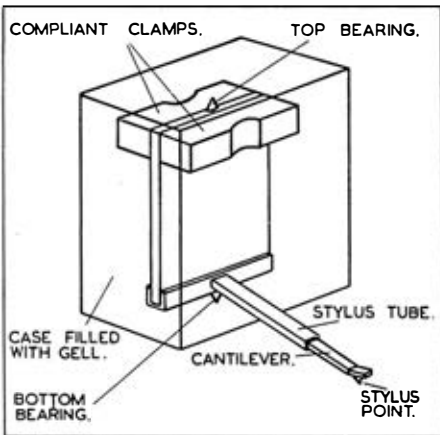

Fig. 4.1 (below)—Representation of the waveform of a single note from a clarinet.

Fig. 4.2—The crystal pickup cartridge can take a number of forms, including that shown in which the stylus vibrations are transmitted to the crystal through a cantilever. The bending motion of the crystal results in the generation of a voltage between opposite faces of the crystal.



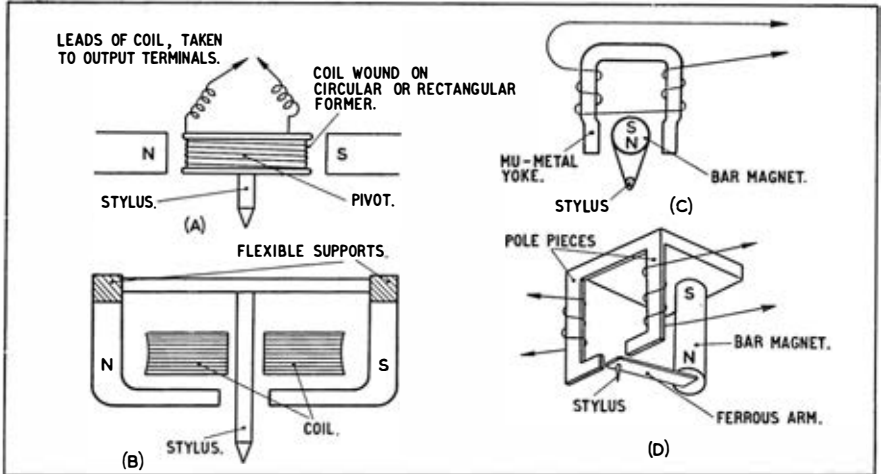

Fig. 4.3—Various types of magnetic pickup are in current use, and an idea of the construction may be obtained from the diagrams (A) Moving Coil, (B) Moving Iron, (C) Moving Magnet and (D) Variable Reluctance.

A number of magnetic types of pickup exist, employing variations on the moving coil theme developed for loudspeakers (see Chapter Two). Remembering that it is *relative* movement of the coil (or any piece of magnetisable metal) and magnet that generates current, a useful pickup output may be got either by moving the iron (moving coil types) or altering the field (moving armature and variable reluctance types). Naturally these various magnetic pickups have a family resemblance, notably in regard to their being insensitive (they produce only a tiny output voltage), their requiring equalisation (see Chapter Three), and being low impedance. All this, of course, by comparison with crystal pickups,

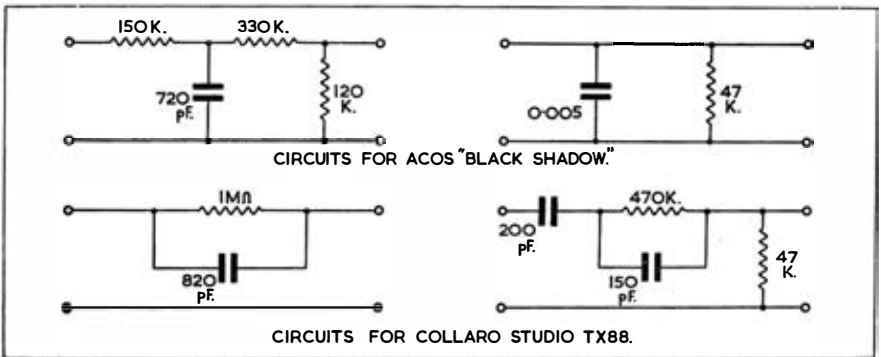

Fig. 4.4—Manufacturers of crystal pickups will often supply matching circuit diagrams to allow their cartridges to be connected to amplifier inputs which are intended for magnetic pickups. Two examples are given above, with the normal uncorrected circuit on the left, and the corrected version on the right.

which generate a higher voltage, require no equalisation or practically none, and are high impedance.

These differences make it necessary to match the chosen pickup carefully to the control unit, as we have said, and if you are determined to go *contra* to the maker's instructions, something like the circuits of **fig. 4.4** will be necessary.

Pickup Sensitivity

The sensitivity of pickups is usually quoted as a voltage, but this must obviously refer to a reference level of recorded signal. The latter is nowadays taken as a recorded velocity of 1 centimetre per second (which in fact corresponds to a rather faint sound volume), so that a typical magnetic pickup might be specified as "sensitivity: 0.001 volts (or in the more usual terminology, 1 mV) per cm./sec." A fairly usual crystal pickup specification would be 0.05 volts, i.e., 50 mV/cm./sec. As we have said, the agreed reference level is low, and a good working average for the voltage to be expected from a music LP is got by multiplying the nominal sensitivity by 10.

Pickup Distortions

There are two kinds of distortion inherent in the gramophone system—i.e., a constant-speed disc with pivoted pickup—which the enthusiast ought to understand, whether he is able to do anything about it or not. The first of these comes about through the speed of the disc passing under the stylus steadily reducing as the pickup tracks towards the centre. The number of revolutions per minute (78, 45, $33\frac{1}{3}$, or $16\frac{2}{3}$) is fixed, of course, but the disc speed "seen" by the pickup

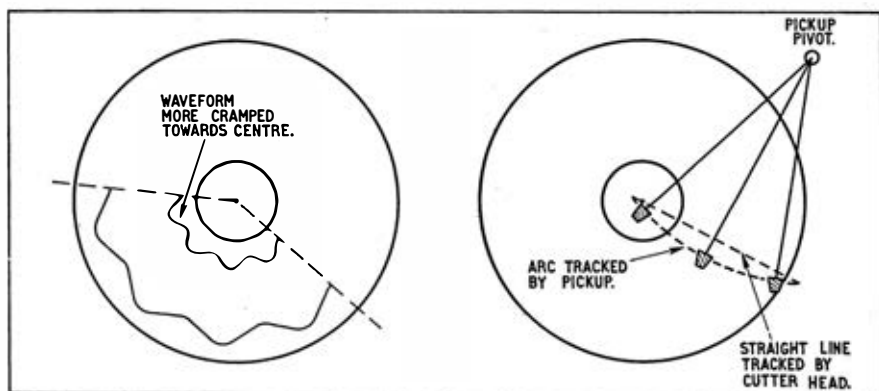

Fig. 4.5 (left)—An inherent disadvantage of the disc recording system is that recorded waveforms become cramped towards the centre. **Fig. 4.6** (right)—Tracking error is introduced since the pickup head traces out an arc, whereas the cutter head tracked along a radius.

is the r.p.m. multiplied by the groove circumference, and this falls from approximately $11\frac{1}{2}$ in. to $4\frac{3}{4}$ in. from the outside to the inside of a 12-in. disc. The effect of this is that the recorded waveform becomes progressively more cramped towards the end of a side, and the high frequencies, in particular, tend to be lost.

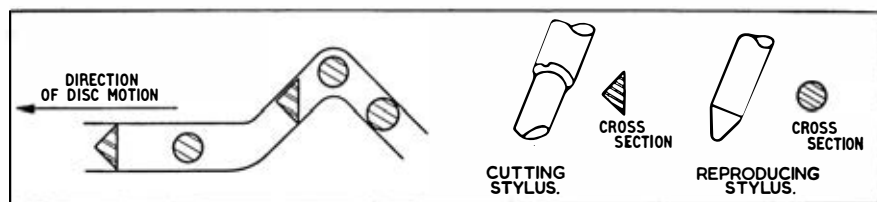

Fig. 4.10—“Pinch” effect causes the pickup to rise and fall vertically, and is due to the fact that the cutting stylus is chisel shaped, whereas the pickup stylus is circular in cross section.

The process is gradual, of course, and the recording companies will often have compensated with a judicious lifting of the top, so that we may not notice it in the ordinary way. “End of side distortion” is often obvious, however, when we switch to the beginning of Side Two immediately after the end of Side One. It is a pity too that, in the nature of things, musical compositions—and therefore LP discs—very often end with a loud climax, aggravating this species of distortion still further. The advocates of tape records (and cylinder recordings, if there are any left!) will give a knowing nod at this stage.

The second inherent distortion comes about through the pickup failing to follow exactly the path traversed by the cutter head, when the master disc was originally being recorded. The recording cutter tracks in a straight line across the disc, being suspended on a kind of gantry or bridge. By contrast, any pickup pivoted at one end will trace out an *arc*, so that the sideways vibrations of the

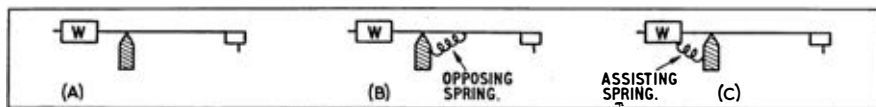
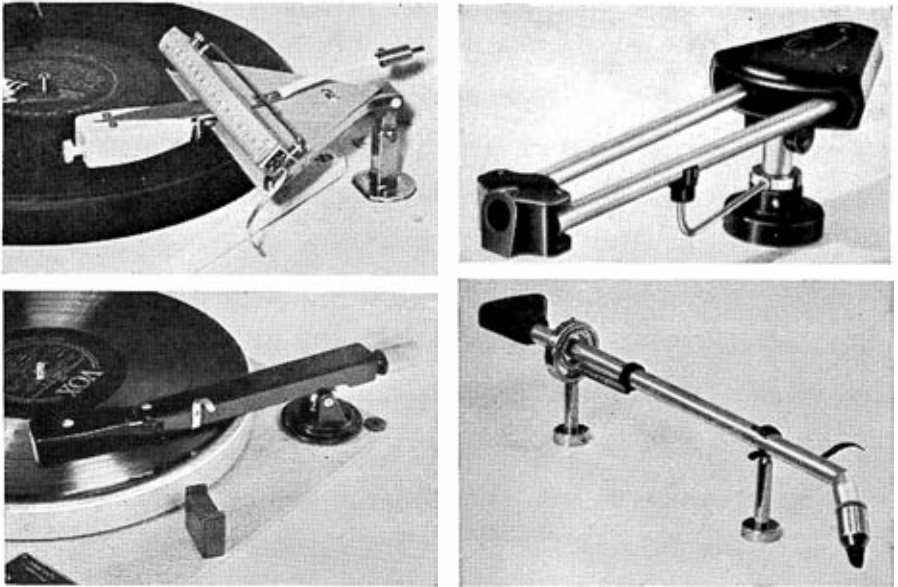

Fig. 4.11—Extra lightweight pickups are obtained by counter-balancing or the use of springs.

stylus can be exactly at right angles to the groove at one point only. At all other positions, it will be liable to introduce what is known as “Tracking Error” (see **fig. 4.6**). Using a very long arm will flatten the unwanted arc, but the need to fit into a reasonable-sized cabinet, and the difficulty of designing long arms, restricts this. The resultant distortion—an edgy quality at the beginning and/or end of discs—is reduced very considerably, however, by cranking the pickup head at a calculated angle to the arm, and very carefully mounting the pivot at its optimum position relative to the turntable spindle.

Three solutions to this “tracking error” problem are currently available. First of all, there is parallel tracking, in which a kind of carriage-way carries the pickup in a straight line in exact imitation of the cutter head’s movement. An example of this is the Mackie Parallel Tracking Arm (see **fig. 4.7**). Secondly, in the Burne-Jones Tangential Pickup Arm, a double shaft, together with elegant couplings, progressively shifts the head/arm angle to maintain the correct tracking (see **fig. 4.8**). Finally the Worden Articulated Pickup Arm, a recent introduction, progressively shifts the head/arm angle by means of a turning force transmitted from the pivot bearing through a shaft running inside the length of the arm (see **fig. 4.9**).

PICKUPS



Figs. 4.7 to 4.9—A selection of current pickup arms. The Mackie Parallel Tracking arm (top left), the Burne-Jones Tangential arm (top right), the Worden Articulated arm (bottom left), the Bang and Olufsen ST/L arm (bottom right).

Record Wear

The prevention of record wear must always loom large in any hi-fi discussion. It isn't only that long-playing records cost so much, but undue wear attacks *the fidelity* on two fronts. It introduces noise, of course, which is liable to show up more on the superior hi-fi equipment than an everyday gramophone; and ruins too the minutest etchings on the groove walls, which reproduce the high frequencies. The damage that only a few playings can cause has been a special study of Mr. Cecil Watts, whose groove photo-micrographs are well known in Hi-Fi circles.

The factors affecting record wear are (a) playing weight, (b) ease with which the stylus reacts to side pressure by the groove (compliance), (c) lightness of

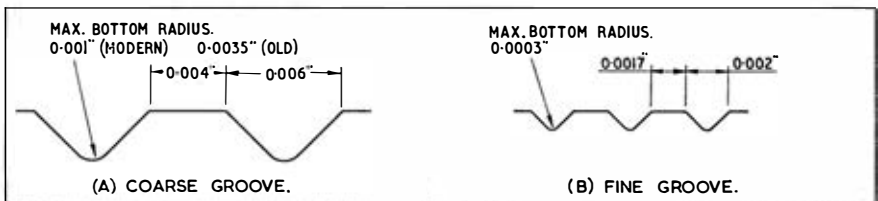

Fig. 4.12—The standard groove dimensions give approximately 100 and 250 grooves per inch on 78 rpm and microgroove discs respectively.

pickup bearings, (*d*) the stylus. Modern pickups are counterweighted or counter-sprung (see **fig. 4.11**) to be almost “light as a feather”; but this advance would have been impossible without equivalent design improvements in the stylus compliance and back bearing. As it is, as much harm can come from trying to track records at too light a pressure, for the given make of pickup, as too heavy. Therefore, when setting up a pickup which allows adjustment of the downward pressure, stick to the recommended weights. These are anything from 4 to 8 grammes for the majority of pickups, 3.5 gm. for the Decca ffs, and even less for a few special types.

Gramophone needles—styli—have changed a lot since the days when we used to perform sharpening rites on our thorn points. Then the philosophy was to use a soft point which would be worn to a snug fit after about one revolution of the disc. Nowadays, it is calculated that the stylus, provided it is ground and polished to precisely the right dimensions, should be made of as hard a material as possible. It will then *retain* this calculated profile for a large number of playings, and not damage the disc. Diamond and sapphire styli are in common use, giving safe playing “lives” of 2,000 and 50 hours respectively. It is too late to wait till you can *hear* the distortion. Have the stylus inspected after the appropriate number of playings, and if all is well you can carry on. If not, replace it at once.

The standard values for the tip radius are 0.003 in. for coarse groove (78 rpm) records, and 0.001 in.—the famous “one thou”—for fine groove (45 and 33½ rpm) monaural records. Some people feel that 0.003 is too small for 78s, and special styli may be obtained for playing large collections of these older records. For stereo discs a “half thou” (0.0005 in.) stylus is standard, though many pickups are sold with a nominally 0.0007 in. stylus in an attempt to give the best compromise for playing both mono and stereo LPs. The standard groove dimensions of discs are shown in **fig. 4.12**. At the time of writing, there are scarcely enough 16½ rpm records on the market to warrant discussion.

TURNTABLES



A gramophone turntable's job is clear enough. It must rotate the disc in the horizontal plane at exactly the selected speed (78, 45, $33\frac{1}{3}$, or $16\frac{2}{3}$ revolutions per minute), and do this as silently as possible, i.e., the turntable itself should be inaudible at a few feet distant, and any vibrations transmitted to the pickup, either through the disc and stylus or via the pickup pivot, should be so small as to be insignificant.

A "transcription" turntable is the rule for Hi-Fi—a term presumably derived from the professional equipment used in the quality copying or "transcribing" of discs. It differs from the domestic record player, at a first glance, only in so

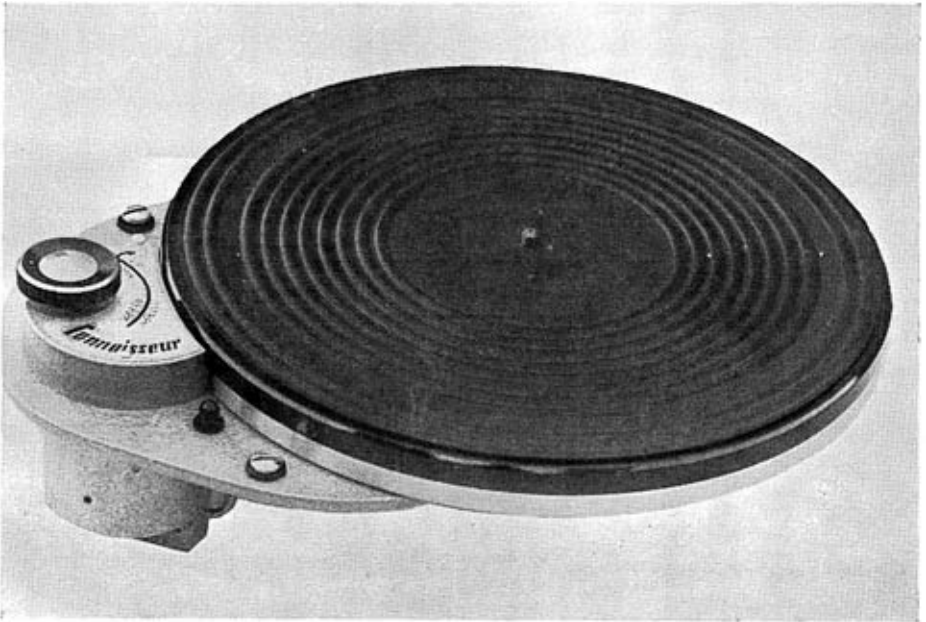

The Connoisseur 2-speed turntable operates at $33\frac{1}{3}$ and 45 rpm only.

far as it possesses a 12-inch heavy turntable instead of the more usual 7 or 10 inch job, and has an extra-powerful motor. In terms of performance, however, the differences can be very striking.

The turntable itself, and the centre spindle, are finished to extremely close tolerances on a transcription unit, to ensure that no vertical or horizontal swing is possible. The fact that a few discs come along with the hole slightly off-centre—they are referred to as “swingers”—is to be deprecated, but an off-true spindle would make *every* record sway from side to side once in each revolution. The effect is to make the musical pitch wobble or “wow”, and is rightly unpopular.

If the exact pitch of the music is to be reproduced, the turntable must rotate at precisely the same speed as did the original master disc. To ensure this, transcription motors are mainly of the synchronous type, i.e., the 50 cycles per

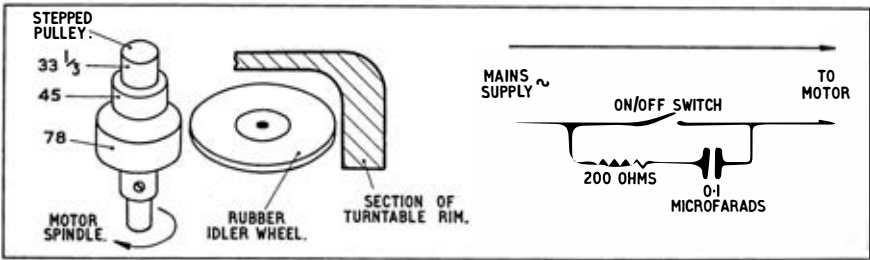

Fig. 5.1—Most rim drive turntables use a capstan with stepped thicknesses for the various speeds, and a rubber idler wheel as shown. **Fig. 5.2** (right) —A useful circuit to suppress clicks from the on/off switch.

second mains supply anchors the motor speed, and through the good offices of the local Electricity Power Station, we can “take it as read”. On some transcription units, however, an induction-type motor is used, and a fine adjustment of the speed is incorporated, to take even Mains Frequency irregularities into account, or allow exact pitching of music. The variation allowed for is usually slight, say plus or minus 5%, and no attempt should be made to adjust the setting until the unit has “warmed up”, i.e., been switched on for about 10 minutes. It will be necessary, too, to refer to a stroboscope, which is a device for checking the speed. It may take the form of black and white bands drawn radially on a disc, or vertically round the edge of the turntable, or it may consist of a neon lamp viewed through holes in the turntable rim.

A stroboscope works only when viewed in AC lighting, a feature of which is that its brightness is not steady, but reaches a maximum 100 times per second (once in each half cycle of the mains frequency), i.e., 6,000 times per minute. Therefore, for the strobe pattern to appear stationary, 6,000 bars or holes must pass a given point per minute. The number of bars required is therefore 77, 133, 180, and 360, for 78, 45, 33 1/3, and 16 2/3 rpm respectively (= 6,000 ÷ rpm). There are a number of ways in which the drive may be transmitted from the motor capstan to the turntable, including a rubber band or geared wheels, but the method in most common use is to interpose a rubber “idler” wheel between the capstan and the turntable rim (see **fig. 5.1**). In the “drive” position, the

TURNTABLES

idler is pulled gently into position by a spring. The exact running speed is determined by the revolutions per minute of the capstan (1,320 rpm is usual), and its precise diameter. (Note that the idler wheel does not influence the speed.) A convenient method of deriving the different speeds is to use a stepped pulley on the motor, with appropriate thicknesses. Speed changing consists of moving the idler into line with the required section. In all cases where an idler wheel or pressure roller is employed, it is important to switch the unit off in such a way that the rubber surface is withdrawn from the capstan when not in use. For example, if the record player derives its power from the amplifier, switching off the latter is not enough. This is to guard against a permanent deformation or "flat" being left on the rubber, with consequent "hiccoughs" or *flutter* on reproduction.

All the popular transcription units are despatched with full installation instructions, and a template to simplify cutting out the baseboard. Following these instructions to the letter should give good results, but there are a number of points worth checking periodically. One of these is turntable levelling. In general, it is the practice to mount the turntable exactly horizontal, at the time of installation, but keeping one of the small circular or T-shaped spirit levels on the baseboard is a good idea to reassure us on this important point. This is good advice too for those who have elected to go in for "dynamic levelling". Proponents of this idea adjust the turntable away from the horizontal, and make the pickup climb gently towards the centre. They thus invite the force of gravity to counteract the side pressure which the circular groove exerts tending to pull the pickup towards the centre. Dynamic levelling is a fairly tricky business, however, and most people will prefer to stay horizontal if no immediate benefit from tilting is discoverable.

On some installations the motor switch is found to produce a loud click from the loudspeakers. This can be suppressed by soldering a 0.01 microfarad condenser and 200 ohms resistor as shown in **fig. 5.2**. (The values are not critical.)

Disc Care

The correct handling of discs is not a difficult operation, and is simply a question of adopting the right habits from the start. They should be stored vertically in any cupboard with partitions between every 50 or so discs. If any section of

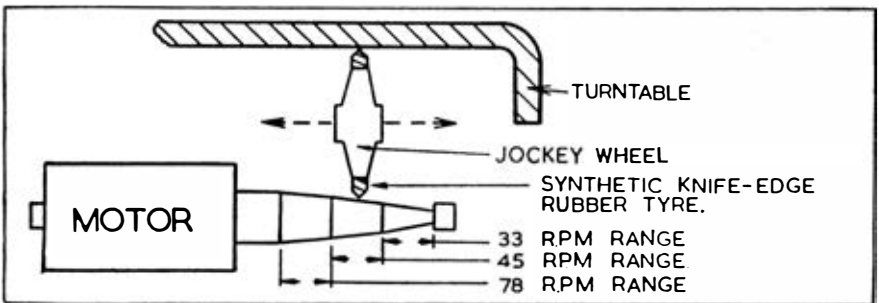
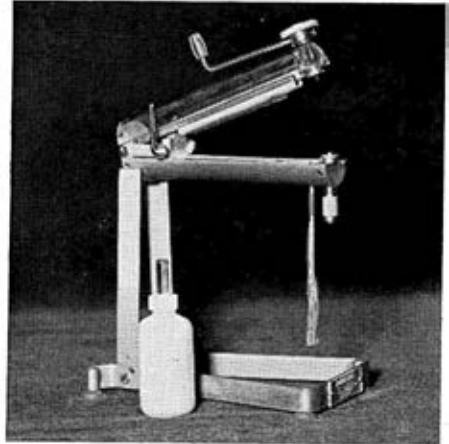

Fig. 5.3—Continuously variable speed is allowed for on this conical pulley.

the cupboard is only half full, it is a good idea to pack in corrugated paper spacers to keep the discs gently together, rather than allowing them to lean sideways and become warped. An ingenious system which has been suggested is to make two matching wedges of wood, say 12 in. \times 8 in., and push these together to take up the shelf space exactly.

The correct method of taking discs in and out of their sleeves is to press the sleeve between left hand and midriff so that it bows open. The right hand can then slide out the disc, touching the unmodulated outer $\frac{1}{4}$ in. only, and avoiding any contact with the grooves. The material of modern records is unfortunately prone to collect static electricity and therefore attract dust—just like the game we used to play picking up small pieces of paper with a rubbed comb or fountain pen. It follows then that discs should not be left out of their protective covers any longer than necessary, and should be cleaned frequently. The different cloths, sponges and fluids offered for this purpose are not all equally good, but your dealer will be able to advise. A very popular cleaning system seen in many Hi-Fi homes is the *Dustbug* (see **fig. 5.5**). This consists of a nylon brush and felt pad on a light Perspex arm which tracks across the disc during playing. The felt is periodically damped with cleaning fluid, and keeps discs scrupulously clean. Another beneficial process—also from Mr. Cecil E. Watts—is the *Parastat*, which makes discs immune to static charges for life. This instrument is now installed in a number of Record Shops, and you should make use of the Parastat service whenever it is available.

Two extremely useful weapons in the war against surface noise are shown here. They are the Dustbug (below), and the Parastat (right), which is used by a great many record dealers, and renders discs immune to static electrical charges.



TUNERS

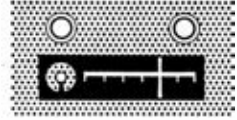

It is natural to think of gramophone records first, in connection with Hi-Fi, for the technical advances in discs have been sudden and dramatic. But the radio medium has not exactly been at a standstill. Since its inception in 1947, the BBC's VHF/FM service has grown very rapidly and now brings high quality reception of the Home, Light and Third programmes to some 98% of the population. A radio tuner should form part of any Hi-Fi system, therefore, and reading through the advanced details of programmes—in preference to random listening—will provide unlimited hours of entertainment. On the question of the quality of transmissions, it is regretted by all Hi-Fi enthusiasts that the BBC's signals are passed from centre to centre along GPO land lines which somewhat restrict band width, and introduce noise and distortion. However, the picture is not all black; the studios and microphones usually produce first rate quality, and if one listens to a “live” transmission from a studio situated not too far from one's local transmitter, very good sound reproduction is possible. Listeners within reach of the London transmitters (Brookman's Park for Medium Waves, and Wrotham for VHF/FM) are perhaps luckiest in this respect, because of the large number of London studios and Concert Halls in regular use. A “Music While You Work” transmission—usually live—or a concert from the Royal

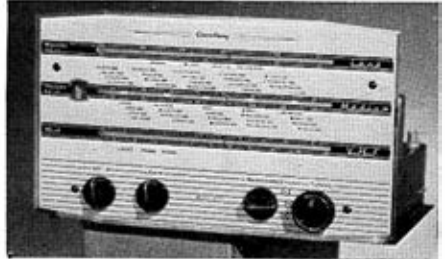

Two contrasting tuner units, the Quad FM and the Armstrong AM/FM ST3.



Festival Hall make ideal material for checking or demonstrating audio equipment.

It might be as well to define some of the OK words about radio tuners, before going any further:

A Few Definitions

Modulation is the process by which the audio signals (in the range 20–20,000 c/s, if we're lucky) are impressed on the transmitter's carrier wave—operating at supersonic frequencies, hundreds, thousands, or tens of thousands of kilocycles per second. Two kinds of modulation are in common use, AM and FM.

AM (Amplitude Modulation)—in which the Amplitude of the radiated signal is varied in accordance with the intensity of the modulating sound.

FM (Frequency Modulation)—in which the frequency of the radiated signal is varied at a rate corresponding to the frequency of the modulating sound, and to an extent depending on its intensity.

Carrier Frequency—the number of c/s of the radiated signal when no modulation is applied, i.e., the frequency to which we tune our receivers.

Sidebands—frequencies distributed on either side of the carrier frequency, and produced by the process of modulation. In AM the sideband frequencies equal the carrier plus and minus the modulating frequencies, so that the bandwidth is twice the highest modulating frequency. In FM they depend on the amplitude, and have a maximum deviation equal to the carrier ± 75 Kc/s.

MW (Medium Waves)—are used, like Long Waves and Short Waves, for long distance transmission of programmes. Still popular for listening to foreign broadcasts. Generally AM.

VHF (Very High Frequencies)—from 88 to 100 Mc/s, now used by many countries for local broadcasting. Generally FM.

FM versus AM

The majority of tuners used by Hi-Fi enthusiasts are VHF/FM only, and the reasons for this are not hard to find. Firstly, VHF/FM scores heavily over AM on *frequency response*. This is restricted on the usual superhet type of AM receiver, to dodge the sidebands of next-door stations on the overcrowded Medium Waveband, but is unrestricted on VHF. In any case, there can be very little interference on VHF because the radiation—like that of TV transmissions—is rapidly attenuated outside of a 50-mile radius from the transmitter, so the VHF band is beautifully quiet except for one's local Home, Third and Light programmes. These are always spaced 2.2 Mc/s apart and are just about the only signals to be picked up, except for possible faint reception of other BBC Regions, *occasional* Continental stations, and the Police, etc., at the top of the band.

VHF/FM is also superior to AM in its suppression of noise, electrical interference, etc. This noise, on reaching the aerial, tends to amplitude modulate the signal, and of course comes through an AM set loud and clear.

When you are choosing a tuner, therefore, you will normally go for VHF. AM will appeal to the regular listener to the Continent, however, and it must

be remembered that many of the shortcomings of AM reception do not apply if you live near a transmitter and use a suitable "Straight" tuner.

The thoughtfulness of the BBC in providing all three programmes at substantially the same signal strength has made the pre-set switchable tuner eminently practicable, and these are made with built-in Automatic Frequency Control (AFC). The circuitry is thus "pulled" into tune with the selected station, and cannot drift. AFC is also fitted on many free-tuning receivers, and simplifies tuning as well as preventing drifting, during the "warming-up" period. It is relatively difficult to tune an FM set by ear, and magic eye or neon tuning indicators have become popular for this reason.

Since a lead must be run to the Control Unit, to connect the tuner's audio output into the Hi-Fi system, it is fairly common practice to omit a power unit from the tuner and derive its HT and LT from the main amplifier's supply. This is an obvious, and very sensible, economy, since a tuner's power requirements are very modest, but it does make it necessary to be on one's guard when purchasing. If the manufacturers of your amplifier also market a tuner, and the amplifier specification includes the words "*power available for tuner, etc.*", then you are safe to buy one of their tuners, or any other which is rated as requiring the same supplies—e.g., HT 300 volts at 25 mA; LT 6.3 volts at 2.5 amps. But if your amplifier has no auxiliary HT and LT outlets, or if there is any other unknown factor, then a "self-powered" tuner is the answer, which incorporates its own power supply and simply needs connection to the mains. The different methods of wiring are shown in **fig. 6.1**. Note that the earth connection on a self-powered tuner mains lead should be left unconnected to avoid what is called an "earth loop" (see also Chapter Nine).

The final main point in which tuners differ from one another is *sensitivity*, that is the minimum radio signal voltage on which they will work satisfactorily. On FM tuners, the sensitivity is not quoted simply as a minimum voltage, but since the suppression of noise or "quieting" is more effective on a strong signal than a weak one, it refers to the minimum signal for a given amount of quieting, e.g., a tuner rated at "10 microvolts for 40 dB quieting" would be more suitable for fringe area reception than one requiring "40 mV for 40 dB quieting".

The mention of sensitivity leads naturally to the question of aerials, and it is urged that every tuner used with a Hi-Fi system should be given as good an aerial as possible. Compared with the over-all cost of the system, aerials for VHF/FM are ridiculously cheap, and after connecting up pickups, control units, speakers, and what have you, running a twin flex or co-axial lead up to the loft will be child's play.

The improvement which an efficient aerial can make to the quality of your reception—and hence your enjoyment of the programmes—can be little short of miraculous; and a number of practical suggestions are given here, beginning with a few remarks on the theory of aerials.

The Transmitted Signal

When an electric current flows through a wire, a magnetic field is set up in the vicinity of the wire, capable of turning a compass needle. Feeding alternating current into the wire sets up an alternating magnetic field, and, at the comparatively high frequencies used in radio, energy is thrown off from the wire and

TUNERS

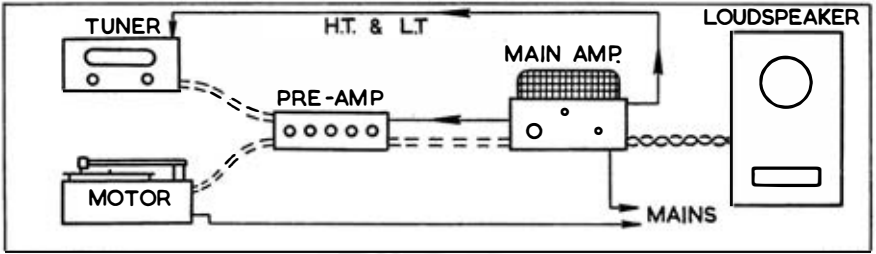
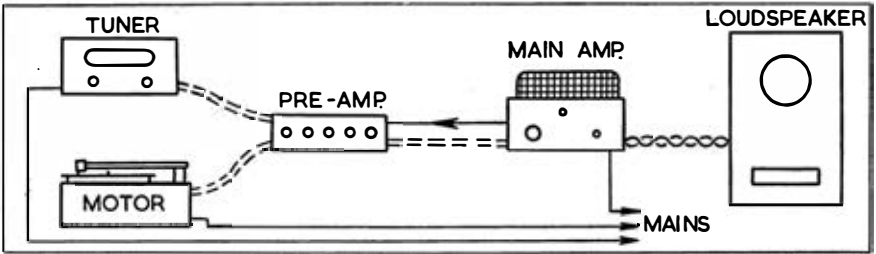

Fig. 6.1—Showing the different methods employed in wiring the tuner into the Hi-Fi outfit. Above, the tuner is powered by the mains amplifier, and, below, the tuner is self-powered.



travels outwards at the speed of light. A wire, or metal-rod receiving aerial is therefore subjected to countless tiny alternating voltages arriving from all directions (and tuning in on medium waves after nightfall it often sounds like it) and the receiving process is one of selecting the correct signal to be reproduced. This selection is primarily the job of the first stage of the receiver circuitry, but the correct aerial characteristics can help materially (*a*) by boosting the required signal, and (*b*) by suppressing unwanted signals.

Vertical and Horizontal Polarisation

In Medium and Long wave broadcasting, the electrical field reaching the receiver is vertical, that is the potential to earth increases with height, and the best receiving aerial is a vertical wire, the longer the better. Depending on the manner in which the transmitting aerial is mounted, VHF transmissions may be vertically polarised—as the MW and LW programmes are—or horizontally polarised. In most regions of this country, the vertical system is employed for television transmissions on Bands I and III, calling for an upright receiving aerial—whilst the horizontal arrangement is used for the FM sound programmes on Band II, and a horizontal receiving aerial is required.

The Propagation of Wireless Waves

A few words can usefully be interpolated here on the propagation of electromagnetic waves. The characteristics are found to vary considerably between the different wave bands. On Long Waves, for example, transmission is mainly by means of the **Ground Wave**. This spreads (almost “flows”) out from the trans-

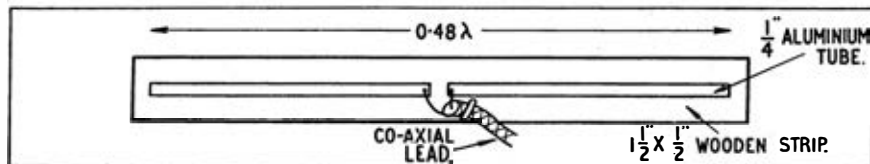

Fig. 6.2—One method of constructing a simple do-it-yourself VHF dipole.
(See page 48.)

mitter, hugging the contours of the earth. Field strength at any point is accordingly governed almost entirely by the distance from the transmitter and the total transmitter power.

On the Short Wave Band it is found that the Ground Wave is rapidly absorbed, and communication depends on a **Sky Wave**, which is bounced back to earth after one or more reflections from the ionospheric layers 60 to 100 miles up.

Medium Wave broadcasts possess something of both the previous characteristics. The Ground Wave gives fairly good field strengths up to a radius of 100 miles or so, and the Sky Wave may be picked up at greater distances. This latter effect is something of a mixed blessing, however, as it means that, particularly after sunset, reflected signals from Continental stations come crowding in strongly enough to interfere with our reception of local stations.

VHF Propagation

VHF transmissions do not conform with any of the above descriptions. The Ground Wave is absorbed almost immediately, and the Sky Wave penetrates the ionosphere without being reflected. There remains the Direct Path—of 30 to 60 miles—directly connecting the transmitting and receiving aerials (with only a slight bending to follow the Earth's curvature). So VHF is useful only for comparatively short range working; but in common with the broadcasting organisations of most countries the BBC has seized on this apparent disadvantage, and by setting up a number of low-power transmitters is providing an interference-free service over practically the whole country.

Aerials for AM only

Getting down to brass tacks, after that necessarily sketchy résumé of the theory, let us see how to set about rigging up the aerial. Taking first the aerial for AM only. For reception of the broadcast bands, we have seen that a long vertical wire is the ideal. Probably the best length, including the lead-in wire, is 75 to 100 feet; but as few of us can arrange for such a long wire straight up, it is usual to run a wire up the side of the house, and to get extra length by running a horizontal piece at the top.

Whether you do this on the outside of your house, or inside to the loft, there are a number of precautions to be observed. First of all, the aerial should have no electrical contact with the building anywhere along its length. Therefore, if bare wire is used you will have to get a number of porcelain or Pyrex stand-off insulators. These are inexpensive, and are worth while for any outdoor runs

(even of covered wire) as they do not absorb moisture. Stranded wire is better than solid wire, and any joints should be carefully made and soldered. When siting the aerial and lead-in, avoid metal surfaces such as gutters and pipes, and keep as far as possible from sources of interference. For example the back of the house is better than the front, if there is much traffic about.

Aerials for VHF

The strong signals provided by the BBC up to a 30–60-mile radius from the VHF transmitters has led to most domestic FM receivers being made with a built-in aerial. Although this gives fair reception, its efficiency both of reproducing the programme, and suppressing background noise is not good enough to be considered in conjunction with Hi-Fi equipment. You should use the so-called half-wave dipole up to 20 miles or so from the transmitter, with extra elements at greater distances. Theoretically the overall length of the dipole is exactly half the wavelength for the required frequency, which for example is 62.75 inches at a frequency of 94 Mc/s. But the thickness of the dipole has the effect of reducing the resonant length, so that a shorter length is necessary for $\frac{1}{2}$ inch diameter metal rod than $\frac{1}{4}$ inch rod or wire. There are two advantages in using a fairly thick conductor for dipoles. The first is the improved rigidity of the aerial. This is particularly important for outdoor aerials. The second advantage is that increasing the diameter is found to broaden the tuning, which allows us to get good reception over a band of frequencies.

To receive the three programmes from your local VHF transmitter—which are spaced 2.2 Mc/s apart—the length should be calculated for the middle programme frequency.

Where should the Dipole Be?

The precautions suggested for siting the broadcast aerial—away from metalwork and sources of interference—apply equally to VHF aerials. In addition, the directional properties have to be considered, and the fact that the exact height is quite critical. The directivity pattern of a horizontal dipole is a figure-

Fig. 6.3—Perhaps the simplest VHF aerial consists of ordinary lighting flex opened out to 60 in. and bound with string or tape. This may go in the loft or on a curtain rail.

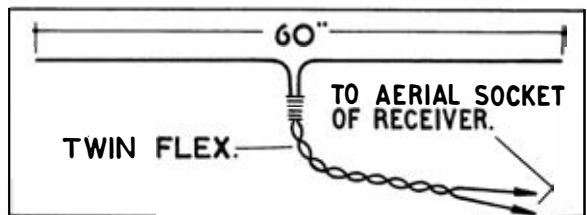

of-eight, with maximum response to signals arriving broadside on, and zero response to signals arriving end-on. If you spend a few minutes scribbling figures-of-eight on a piece of paper, you will soon discover that turning through small angles up to 30° or so makes only a small change in front and back response, but rapidly changes the rejection of end-on signals.

Therefore although you ought to position the aerial at right angles to the direction of the transmitter, it usually pays to experiment with the angle for

best freedom from interference—and possibly unwanted reflections from neighbouring buildings, etc. Various heights should be tried too, because the general rule of the higher the better is true only within certain limits and a couple of feet lower or higher might make all the difference.

If you decide on an outdoor aerial for VHF, you would be well advised to purchase a ready-made unit, and have it put up by an expert. But an indoor aerial is probably adequate up to 20 miles, and is easy to make yourself.

A Do-it-yourself Dipole

First steps are to buy a 6 ft. length of $\frac{1}{4}$ in. or $\frac{1}{2}$ in. aluminium tube and the required length of co-axial cable, and to find out the direction of the nearest transmitter from your house, and the relevant frequencies. For example, running a lead from the loft down to the ground-floor room of the normal house might need 16 yards of cable—at 9d. per yard, a mere 12/-. The three programmes from Wrotham, for example, have frequencies of 89.1, 91.3 and 93.5 Mc/s.

Take the middle frequency, and calculate the required length of the dipole. A rough rule of thumb is to divide the frequency into 5,453 to get the length in inches, e.g., for Wrotham this gives 59.7 inches. Cut the two pieces of the tubing each equal to half this length less $\frac{1}{8}$ in. (29.7 in. in our example) and fasten them to a piece of $1\frac{1}{2}$ in. \times $\frac{1}{2}$ in. or other suitable timber, so that they form a straight line with a $\frac{1}{4}$ in. gap at the centre. Fastening the tubing on to a board is advisable as it allows you to try the aerial in various positions easily, and you may lash it with string or insulating tape, or use metal cleats or small staples.

Then you must secure the co-axial lead to the dipole—central conductor to one half, and screen to the other. This may be done by drilling small holes very near the inner ends of the tubes, and using small bolts or solder tags; or you can solder directly. In either case, staple the co-axial to the board also to prevent the strain being taken by your electrical connections. Termination of the lead-in at the tuner is via the usual plug and socket, or sometimes a 2-pin connector.

Summing Up

If you live fairly near a VHF transmitter—up to perhaps 20 miles—an indoor aerial may suffice, such as the simple dipole just described. And don't forget to experiment with the angle and height, listening to the noise level, as well as the programme volume.

At greater distances, or in unfavourable positions such as the wrong side of a hill, a more directional array is desirable, and you should call in an expert.

For receiving the broadcast bands only, you cannot do better than the old-fashioned long wire, insulated from the building and extending vertically up to the roof. And do make a good connection to earth.

For AM/FM reception, a single aerial should do, because the VHF dipole or array together with its lead-in, luckily makes an acceptable Medium Wave aerial.

TAPE



It will simplify things if we discuss tape as a reproducing medium only, to begin with, and talk about complete tape recorders afterwards. The equipment used to replay tape records through a Hi-Fi system is an exact parallel to the disc player. In place of the gramophone turntable, comes the tape deck, whose job it is to transport the tape at exactly the selected speed (15, $7\frac{1}{2}$, $3\frac{3}{4}$, or $1\frac{7}{8}$ inches per second), transferring it evenly from the “supply spool” to the “take-up spool”, and to do this as silently as possible, i.e., the motor and spools should be inaudible at a few feet distant. The gramophone pickup’s opposite number is the tape playback head, over which the tape is transported, and which generates a tiny output voltage in accordance with the tape’s train of magnetised particles, a North-South magnet giving a positive voltage (let’s say) and a South-North magnet, negative.

The Tape versus Disc battle continues to rage at Company Director level, but it will be enough to summarise the points for and against, as they affect the ordinary user like you and me. Against tape must be set the difficulty of

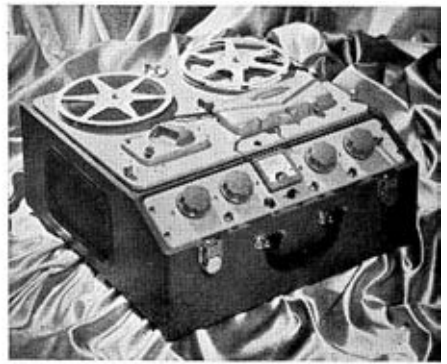

The EMI TR52 and the Ferrograph 4 A/N recorders are ideal for Hi-Fi enthusiasts.

handling and of finding a particular excerpt, compared with disc; its liability to accidental erasure, and the high cost of tape records (currently around £3 3s. for a twin-track 7-in. reel at $7\frac{1}{2}$ i/s giving about the same playing time as a 12-in. Long-Playing disc, costing 40/-). On the credit side, it is possible to amass a formidable list of advantages for tape. The frequency response and general quality can be excellent—at the $7\frac{1}{2}$ i/s speed—and is consistent throughout the tape (no “end-of-side” and tracking distortion as on disc). Further, the low background level attainable has given tape a slight lead in terms of *dynamic range*—i.e., the permissible contrast between very loud and very quiet passages, with added realism. Then, given reasonable care in handling, a tape’s performance can be still the same after 50 or 100 playings as it was to begin with, which would require super-human disc handling and a very good pickup indeed!

Tape definitely comes out on top where stereophonic sound is concerned, since, in addition to all the foregoing, it gives near perfect channel separation,

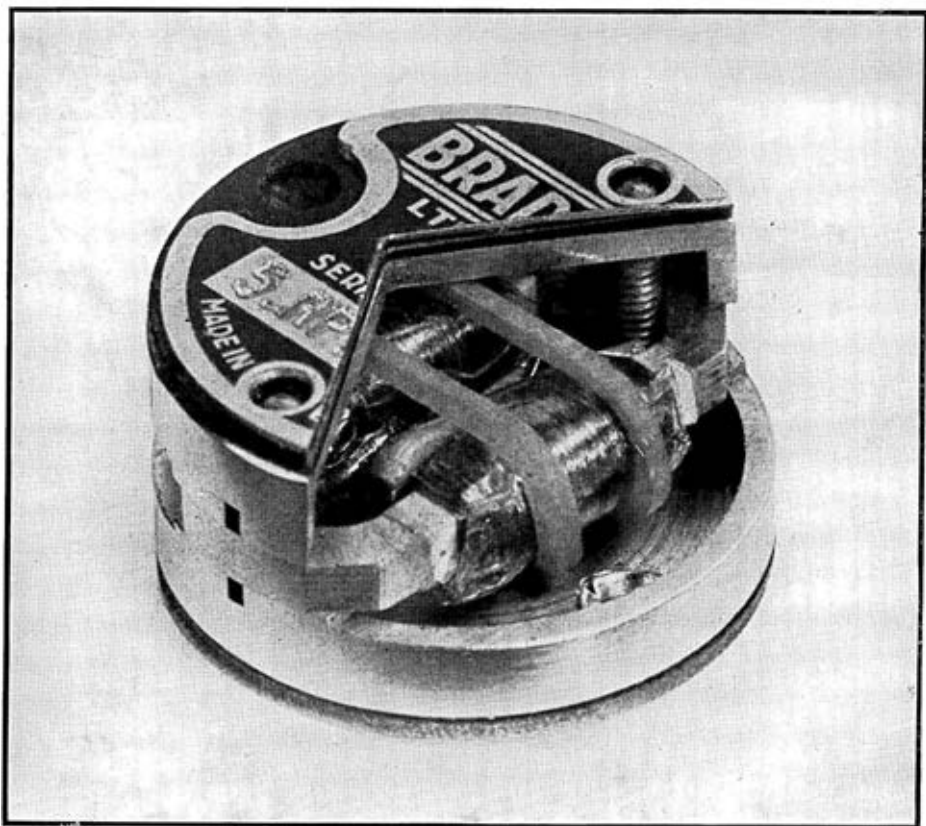

This close-up photograph of a Bradmatic stereo recording head shows the tiny coils and the frontal gaps stacked one above the other.

T A P E

Fig. 7.1—The repeated reversals of the electrical signal leave the tape in a magnetised state, with magnetic polarity reversals forming an equivalent pattern on the tape.

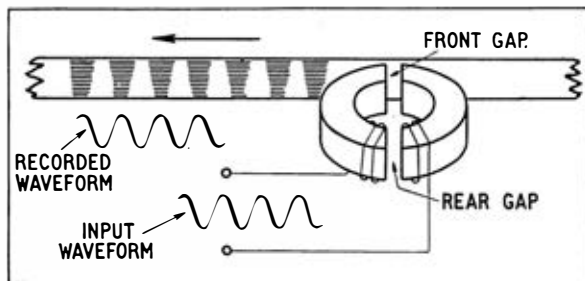

which a glance at the “cross-talk” figures for stereo pickups will demonstrate as a very real advantage. Tape advocates can claim too that the universal practice in recording studios of making the original master recordings on tape would seem to indicate its technical superiority. Finally, they can emulate the professionals, and edit their records by cutting and splicing the tape, or wipe out the music altogether, and re-record anything they like! For the price of a couple of tapes they can have an ever-changing Hit Parade of their own choosing.

To obtain the standard of speed consistency (avoidance of “wow and flutter”) of a transcription turntable needs a tape deck of more substantial construction than that built into the normal domestic portable recorder. Such decks do exist, however, though they are not cheap. The majority of quality tape records produced so far run at a speed of $7\frac{1}{2}$ inches per second, but there are signs that $3\frac{3}{4}$ i/s may become increasingly popular, so it would be best to select a deck which possessed both these speeds.

Track Widths

Full track recording, in which the magnetic trace is “printed” across the full $\frac{1}{4}$ -in. width of the tape is used only in professional circles, and half-track may be taken as the standard at the present time. Here it is a track 0.1 inch wide which is scanned just above the centre of the tape. (Strictly, a 0.11 in. track should be recorded, and 0.09 in. replayed, to allow a safety margin.) Turning the reel upside-down then permits a second track to be recorded, with 0.03 inch of “land” between (see **fig. 7.2**). It is always important, when lacing up the tape, to see that it has not become accidentally reversed so as to present the wrong face to the tape head. The dull, “coated” side must be against the head, and the shiny side towards the operator.

Quarter track tape records are now being produced, though it remains to be seen whether they will be generally accepted and replace $\frac{1}{2}$ -track. The only reasonable defence of 4-track is tape economy, and of course it increases the vital importance of the tape being accurately guided across the head, besides being liable to increased background noise since the magnetic signal now occupies only half the area. The track dimensions are given in **fig. 7.2**.

The most widely used configuration of tape heads is that sketched in **fig. 7.1**, with a double coil of wire wrapped round the ring-shaped core (really a stack of wafer-thin “laminations”) and a narrow frontal gap. It is the linking of the recorded field with this gap which generates the output voltage. In effect, as we have said, the programme consists of a train of alternating North-South,

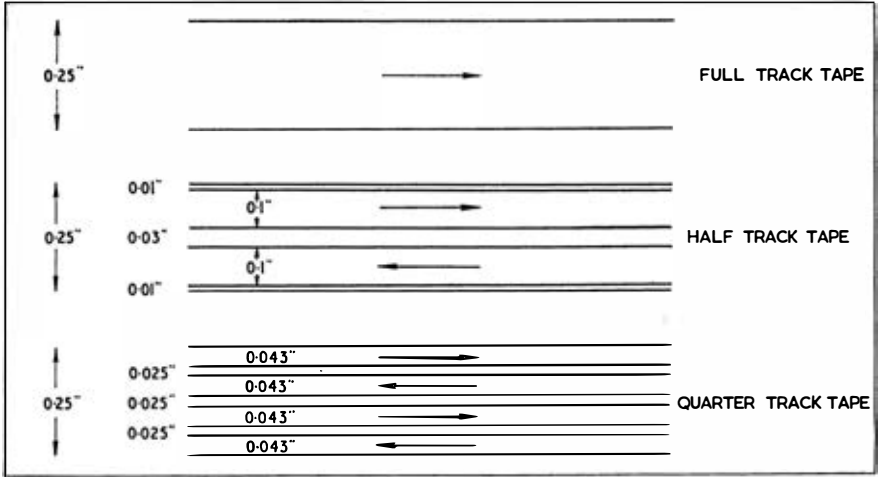

Fig. 7.2—The accepted track dimensions and direction of travel for full, half and quarter track recording are shown for the standard 1/4 in. tape. Full track recording is used only in professional circles, and quarter track is a fairly recent development now being used increasingly on domestic machines.

South-North magnets, and a moment's consideration will show that a head with a given gap width cannot respond to or "resolve" recorded magnets which approach the gap in size. To take an example, assume a gap width of 0.0005 inch, then the cut-off frequency for a tape speed of $7\frac{1}{2}$ i/s is 15,000 c/s (since the magnets corresponding to each cycle will then be $7\frac{1}{2} \div 15,000 = 0.0005$ inch long). This "top loss" effect, due to the gap and other causes, is shown graphically for the three popular tape speeds in **fig. 7.3**. It explains the continuing struggle to manufacture heads with narrower gaps, and also demon-

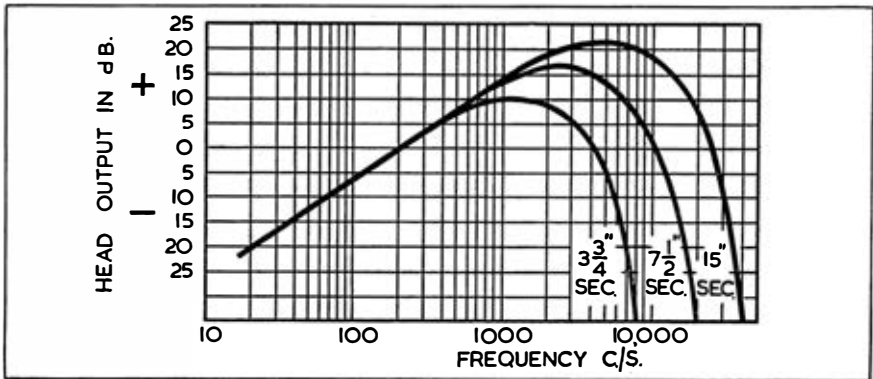

Fig. 7.3—For a given head gap width, high frequencies are lost at slower speeds.

strates why it is that, for any given head, the higher speeds have the better frequency response.

In point of fact, we have not taken into account so far the question of equalisation, i.e., frequency correction, but it will be obvious that carefully adjusted top lift could largely compensate for this "gap effect". In the majority of tape recorders, appropriate equalisation is switched into circuit for each position of the speed selector switch. When a Hi-Fi Control Unit includes an input jack for tape reproduction "direct from the tape head", no switching of equalisation is normally incorporated. Instead, a fixed correction circuit—that corresponding to the CCIR recommendations for $7\frac{1}{2}$ i/s—is supplied (see fig. 7.4) and the tone controls may be employed when tapes recorded at other speeds are being played.

If the Hi-Fi enthusiast possesses a complete tape recorder, there may be a choice of methods of reproducing the tapes through his Hi-Fi equipment. Two of the three possible outlets from a recorder are shown in fig. 7.5, and whereas

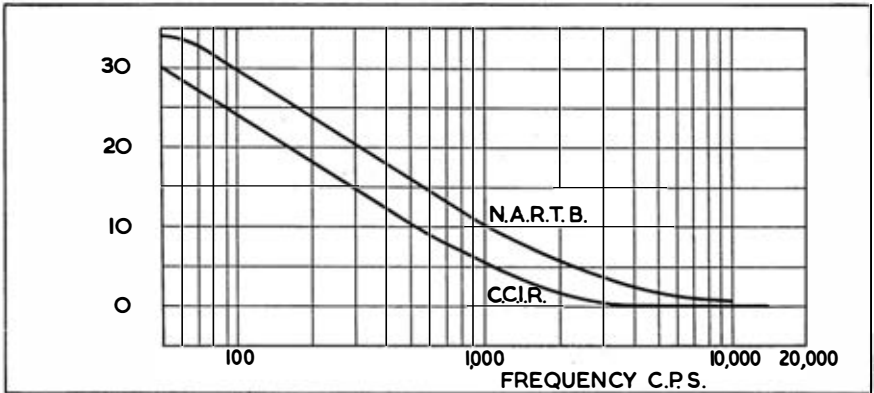

Fig. 7.4—Comparing the CCIR and NARTB recommended playback characteristics for $7\frac{1}{2}$ i/s.

the "electronics" of the professional and semi-professional machines may be up to Hi-Fi standards, it will normally be better to by-pass as much of the domestic recorder's "innards" as possible. In order of merit, then, these connections are as follows:

(a) Direct from the tape head to the 2–4 mV "corrected" input on the Control Unit. This will correspond to operating from a tape deck, as considered earlier in this chapter, but will rarely be possible, since very few tape recorders possess a Tapehead output socket.

(b) From the recorder's pre-amplifier stage to the 50–200 mV "uncorrected" Tape input on the Control Unit (the Auxiliary or even the Radio input will work equally well). This has the advantage of by-passing the recorder's necessarily lightweight and sub-Hi-Fi output stage transformer, while retaining the switched equalisation in the pre-amplifier.

(c) From the recorder's External Loudspeaker socket to any "uncorrected" input on the Control Unit. This method will not produce the highest quality, but is the only external connection allowed for on many recorders.

Length of tape in feet	Type of spool	Maximum playing times in hours and minutes											
		1 Track				2 Tracks				4 Tracks			
		15 i/s	7½ i/s	3¾ i/s	1⅞ i/s	15 i/s	7½ i/s	3¾ i/s	1⅞ i/s	15 i/s	7½ i/s	3¾ i/s	1⅞ i/s
3,600	8¼" DP	48	1 36	3 12	6 24	1 36	3 12	6 24	12 48	3 12	6 24	12 48	25 36
2,400	7" DP 8¼" LP	32	1 4	2 8	4 16	1 4	2 8	4 16	8 32	2 8	4 16	8 32	17 4
1,800	7" LP 8¼" S	24	48	1 36	3 12	48	1 36	3 12	6 24	1 36	3 12	6 24	12 48
1,700	5¾" DP	22	47	1 30	3 1	45	1 30	3 1	6 2	1 30	3 1	6 2	12 5
1,200	5" DP 5¾" LP 7" S	16	32	1 4	2 8	32	1 4	2 8	4 16	1 4	2 8	4 16	8 32
900	5" LP	12	24	48	1 36	24	48	1 36	3 12	48	1 36	3 12	6 24
850	5¾" S	11	22	45	1 30	22	45	1 30	3 1	45	1 30	3 1	6 2
600	4" DP 5" S	8	16	32	1 4	16	32	1 4	3 8	32	1 4	2 8	4 16
450	4" LP	6	12	24	48	12	24	48	1 36	24	48	1 36	3 12
400	3¼" DP	5	10	21	42	10	21	42	1 25	21	42	1 25	2 50
300	3¼" LP 4" S	4	8	16	32	8	16	32	1 4	16	32	1 4	2 8
200	3¼" S	2½	5	10	21	5	10	21	42	10	21	42	1 25

Note: The 3 tape thicknesses are listed as S (Standard), LP (Long Play) and DP (Double Play).

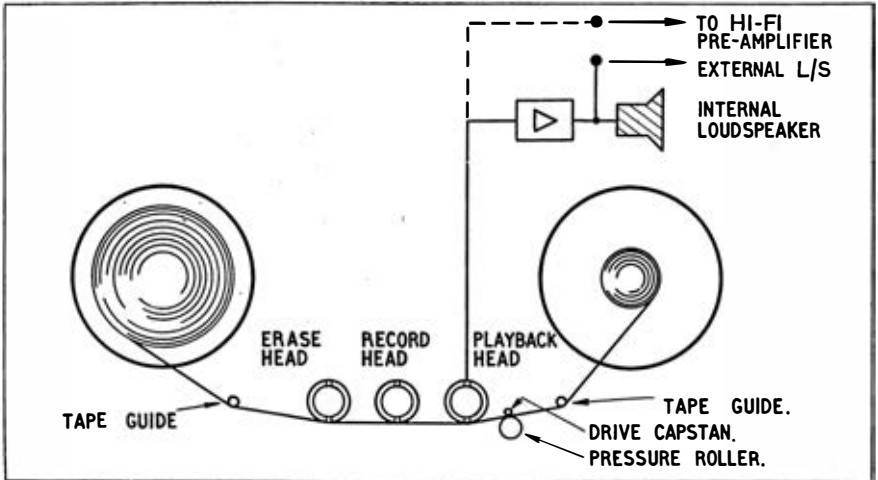

Fig. 7.5—To replay tapes through external equipment, you may use the external loudspeaker sockets (if supplied) or, if the Hi-Fi amplifier is designed for this, take a connection direct from the playback head. In the case of a portable recorder, where the built-in amplifier is necessarily Medium Fi, the latter arrangement will naturally give the best quality of reproduction.

Recording via the Hi-Fi System

It will be found that many Hi-Fi Control Units have a “Tape” or “Recording” output jack, and using this for recording purposes has many advantages. The various sources may be left permanently connected to the Control Unit, of course, and selected on the selector switch—so that recording from disc, radio, microphone, or perhaps an auxiliary tape deck, if available, is immediately on tap.

The most useful (but not the most common) take-off point in the Control Unit’s circuitry for this “Record” jack is after the tone and filter controls, but *before* the volume control. In this way, it is possible to record with exactly the desired tonal quality, and yet monitor at any volume required—or turn the Hi-Fi loudspeaker down completely, if necessary, with the recording level set independently on the Tape Recorder, presumably by reference to the Recording Level Indicator.

Care of Tape

Properly looked after, tapes may be expected to retain their physical condition almost indefinitely, though some degree of demagnetisation must undoubtedly affect recordings stored for very long periods. On the mechanical side, a certain amount of humidity is desirable to prevent tapes from becoming dry and brittle, and excessively hot conditions should be avoided. Storing tapes upright in dust-free containers in ordinary room temperatures will be best. The spools themselves should be maintained in good condition, as they can cause wow if bent or buckled, and the tape should be spooled up evenly and fairly

tightly. Folding a piece of jointing tape over the ends will prevent damage, and make it possible to anchor the loose end, keeping the tape securely wound.

Magnetically, the tape is always at the mercy of stray external fields, of course, and should be kept well away from the magnets in loudspeakers, amplifier transformers, etc. The risks are (a) induced noise, (b) partial erasure, and (c) an increase in "printing". This last effect is always present to some degree, and is the recording of faint echoes of the programme contained on adjacent layers of the tape wound on the spool. Printing is worsened by recording at too high a level, exposure to high temperatures, and stray magnetic fields. Professional users prefer to employ metal containers, to avoid spurious magnetisation, particularly when tapes are being transported or sent through the post.

Tape Editing

Tape recording has one feature which has special appeal to Hi-Fi music lovers, namely, the possibility of editing. The actual operation of splicing lengths of tape together, using a razor blade, editing block and the special impact-adhesive jointing tape, is soon learned; and collections of musical items can be gathered together in any permutation which suits the individual. These recordings can, of course, be played back as often as required with no loss in quality and can be erased at any time when it is decided to change the repertoire. In some cases, enthusiasts have been known to make tape copies of their favourite discs, so that the disc itself may be preserved in as new a state as possible, while the tape is used for general listening.

CHAPTER EIGHT

STEREO



Who was it, when asked to advise someone about getting married, said “Don’t”? Well, the same advice might have been given a couple of years ago to any Hi-Fi beginner who asked if he should invest in stereo. By now, however, the mushroom cloud over the stereo explosion has nearly cleared away, and we can take a less cynical view of the subject. That good stereo adds to the realism and articulation of sound reproduction is now proven—and bad stereo, how-

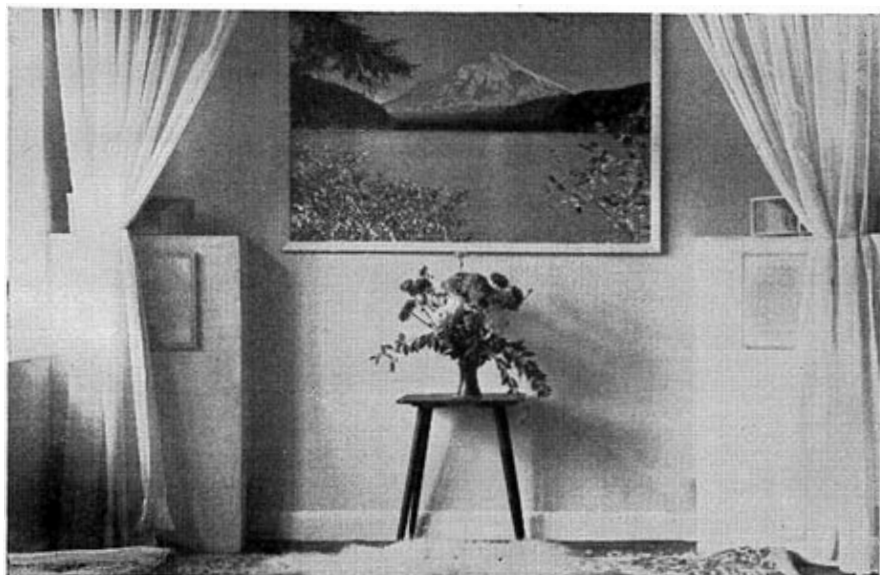

This photograph was contributed by reader John Mackie to a “Hi-Fi News” feature, and shows two concrete speakers.

ever prevalent in the beginning, has no place in our discussion here—and there are many signs that stereophonic Hi-Fi may well become the rule instead of the exception. Be reminded, however, that stereo is by no means synonymous with High Fidelity. At best it gives a pleasant spread to sound, fills out the bass frequencies, and assists us to follow the different musical lines, but at worst, it is no more than a “gimmick”. You should change over to stereo, therefore, only if this is economically and demonstrably possible without sacrificing any of the expressed standards of quality. This chapter contains a few pointers on refurbishing stereo, and the reader who wants to know more is referred to our companion book *Stereo for Beginners*.

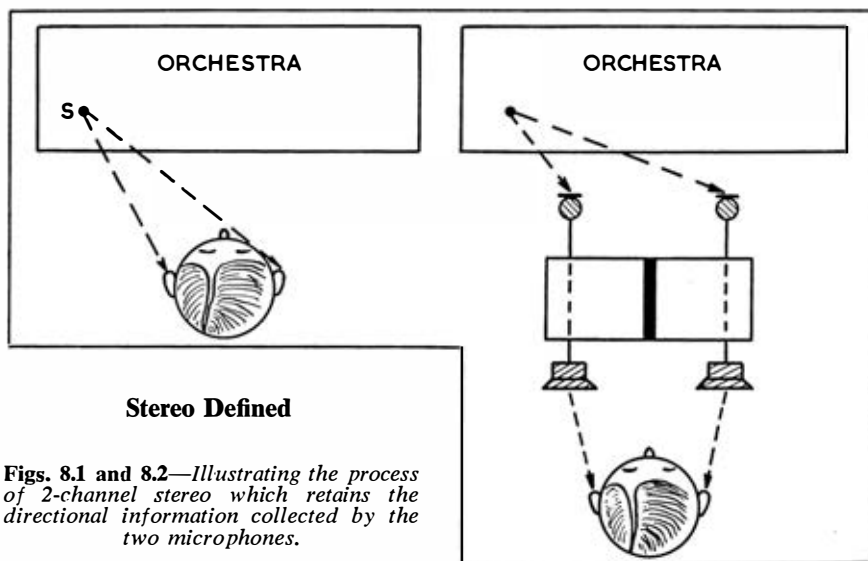

In the present use of the word, Stereophony means a system of using two or more loudspeakers to add a sense of space to recordings or broadcasts. It is not enough to duplicate the loudspeakers alone of course. A pair of microphones must have been employed, and their electrical outputs kept quite separate until they are changed back into sound by the loudspeakers.

In everyday listening, we are able to determine the direction of a source of sounds because of the tiny differences between the signals reaching our left and right ears. This is illustrated in **fig. 8.1**, and it is evident that the sound waves to our ears from the point S will differ in a number of ways—viz., *time of arrival*, *intensity* and *quality* (sounds which have to bend round our heads to reach the more distant ear suffer a small degree of filtering of high frequencies).

Now the differences between these two signals are extremely small, but tests show that our brains are able to analyse these differences so accurately as to locate the direction of sounds even to within a few degrees.

To reproduce the full gamut of directivity sensations that we experience at an actual live performance would require the setting up of a multiple loudspeaker system spread over quite a large area, but the beauty of stereo as we now have

STEREO

it is that the addition of just one more channel produces a spacial effect, in the horizontal plane at least, which, by adding a new dimension, more than doubles the realism of our listening.

A number of different microphone arrangements have been used to give satisfactory stereo listening from two loudspeakers, but in this short treatment it will be enough to consider the spaced microphone approach shown in **fig 8.2**. If the sounds picked up by these two microphones are ideally reproduced by the two loudspeakers, our observer will receive the impression of all sources, such as S, as being located just as they were at the live performance. For this ideal transmission to take place, the intervening chain of amplifiers, etc., and the loudspeakers themselves should have identical characteristics so that the relative phase, intensity, and quality of the signals is correctly radiated to the listener. For example, the loudspeaker leads may have to be reversed to preserve the correct phasing relationship. (This operation should be necessary only once, since all recordings and transmissions have an agreed relative polarity.) The exact placing of the loudspeakers has to be determined by experiment in each room, because of the influence of reflections from the walls, etc.

Although we have illustrated a system of spaced microphones, it is worth mentioning in passing that many stereo recordings are made with coincident microphones which are virtually in the same point in space. In this case, the time-of-arrival difference factor is nil; but directional microphones are used suitably angled to produce an appreciable *intensity* difference for sounds arriving from the left or right.

Stereo on Tape

So much for the basic description of how two-channel stereo operates as far as the microphones and loudspeakers are concerned. Now how about all that valuable bit in the middle?—the transmission or recording system.

The easiest case to consider is recording on tape. We are all accustomed to thinking of two tracks being recorded on tape. This is the arrangement on 95 per cent. of home tape recorders, although it is true that we usually think of the two tracks as running in opposite directions—the top track from left to right, and the lower track from right to left. But it doesn't require much of a stretch of the imagination to visualise the outputs of our stereo microphones being recorded on the upper and lower tracks of a tape, and being reproduced—still unmixed—by a pair of playback heads (see **fig. 8.3**).

In the early days of stereo on tape the record/playback heads were positioned

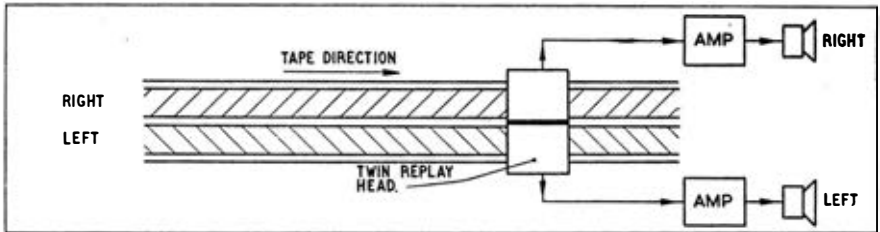

Fig. 8.3—Stereo tapes require a twin replay head, two amplifiers and a pair of loudspeakers.

side-by-side along the tape. This is called the staggered-head system, and until recently was commonly used in the United States. It is now standard practice to use a single "stacked head", in which two independent systems of coils scan the upper and lower tracks. Interference between the two signals (referred to as *crosstalk*) may arise, but is less serious than in the case of ordinary half-track recording where the lower track must be completely inaudible.

Stereo by Radio

The prospect of receiving regular broadcasts in stereo form is quite an exciting one. On top of the increased realism that stereo gives to music of all sorts, just think what it could do to "Saturday Night Theatre" or a spine-chilling programme such as "The Man in Black". So far though we have had to take our radio stereo in tantalisingly small doses—a mere one-hour programme on alternate Saturday mornings. These transmissions the BBC is careful to call "experimental", and we must assume that they form the visible one-ninth of an iceberg of activity and research into regular broadcasts in the future.

Of course these Saturday morning programmes do break all the rules of ideal stereophony which we laid down at the beginning. However good the studio reproduction is from microphones, disc or tape, the Left and Right channels

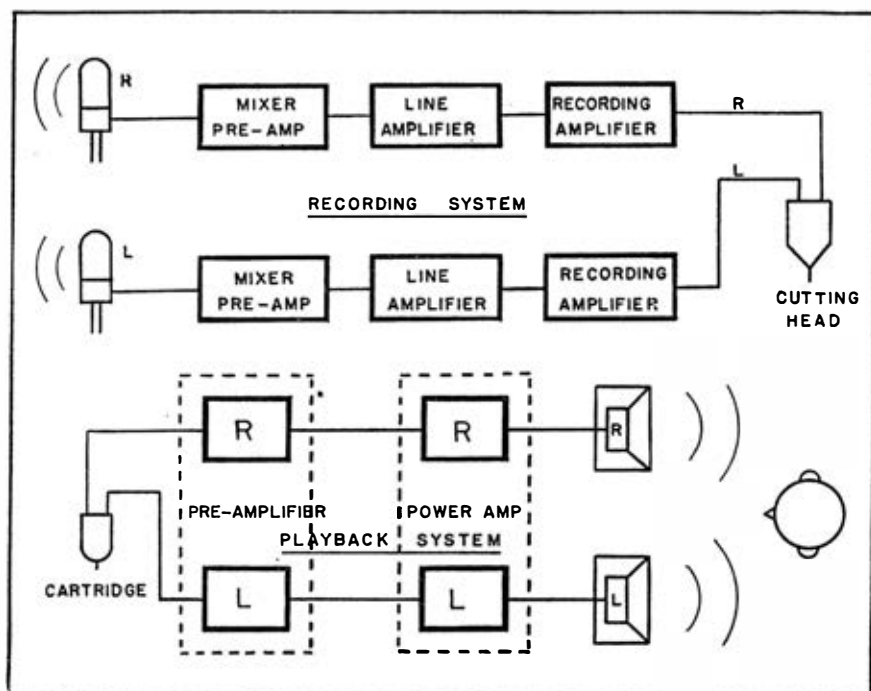

In disc stereo the amplifier channels must be independent, both during recording and playback.

STEREO

are routed to different transmitters, along land lines of dissimilar length and presumably unequal frequency characteristics. In most homes too, the conditions are far from ideal. Instead of having loudspeakers of comparable performance and carefully sited for the best balance, the Right Hand channel can only be reproduced in a television set, which will often severely restrict the quality and the positioning. Very interesting results have been obtained, however, even in remote parts of the country where one would expect the accumulated effects of distance and sometimes poor reception to ruin all semblance of stereo.

Yes the BBC has certainly whetted many people's appetites for stereo broadcasts. Full scale transmissions in this new medium will presumably have to await the introduction of a system of modulation which will permit both channels to be radiated from a common point, and be picked up on a single receiver, there to be reconstituted or "de-scrambled" into two independent channels again. A number of such systems have been suggested—referred to variously as *Multiplex*, *Matrix*, or *Sum-and-Difference*—and we must wait and see which is to be put into practice.

Stereo on Disc

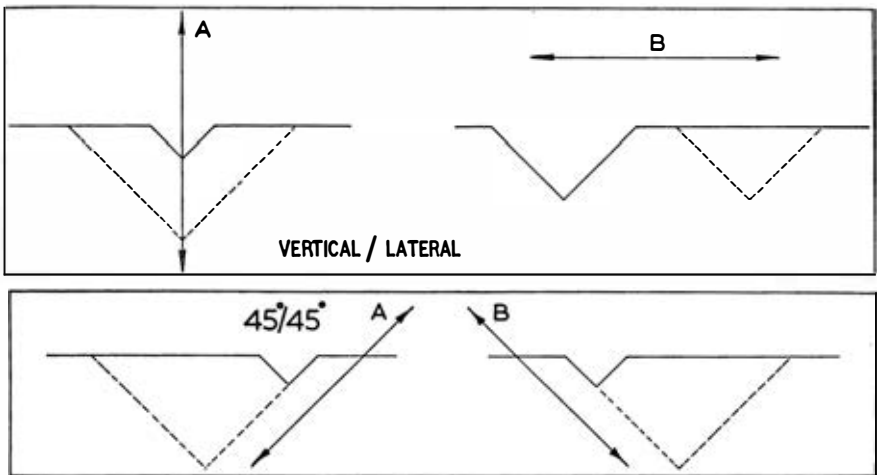

Figs. 8.4 and 8.5—Comparing the stylus movements in vertical/lateral recording and 45°/45° stereo (the present system).

The concept of stereo on disc is a little more difficult to grasp—how is it that two separate signals can be etched into a single groove and reproduced by the excursions of a single stylus? Well, as with so many things, we can get at what the present system of stereo disc recording is easiest by saying what it is not. It is not a combination of lateral (side-to-side) and vertical (hill-and-dale) movement (see fig. 8.4). It is true that it was exactly this system which sparked off the present interest in stereo on disc, when it was demonstrated by A. R. Sugden in 1956 at the London Audio Fair and the BSRA Exhibition. But a number of inequalities to which the lateral + vertical system is liable—including distortion and surface noise—led to the introduction of the so-called 45/45 system

and this has been agreed on as the standard by all major recording concerns.

As its name might suggest, the 45/45 system is in effect the lateral/vertical arrangement turned round so that the two lines of movement are still at right angles to each other, but are each at 45° to the plane of the disc. This can be seen from **fig. 8.5**, and it will be appreciated that annoyances such as surface noise and distortion are likely to be less in evidence since they will affect both channels equally. The 45/45 system also produces a *compatible* pickup, i.e., one which will play both stereo and mono discs.

What You Need for Stereo

To play stereo discs, you clearly need a special pickup which has been designed—like the example in **fig. 8.6**—to respond equally to stylus movements in the two directions as described. Instead of the 0.001 in. or “one thou” tip radius which has become standard for all LP pickups, the stereo stylus has a tip radius of 0.0005 in. (half thou) or 0.0007 in.

Stereo makes more demands of the turntable too. Since a stereo pickup has to be responsive to vibrations in all directions, any motor rumble transmitted as a vertical disturbance through the disc will be present in the output—even if it were imperceptible with a monophonic pickup.

The amplifier manufacturers have busied themselves on our behalf over this stereo problem, and an almost infinite number of combinations may be had. At one end of the scale there is the self-contained or integrated instrument which has twin pre-amplifiers and power amplifiers housed on a single chassis, with all controls ganged or coupled, and a Balance Control which compensates for small discrepancies in level between the channels of the disc or in efficiency of the loudspeakers.

By contrast, you can assemble a stereo system entirely from separate amplifiers, the kingpin being a Master Control Unit which provides balancing of the two channels.

Which of the many systems you eventually decide on will probably depend on what you already possess. Owners of high fidelity amplifier/control units are going to be naturally loath to reduce standards seriously on adding the second channel. Their best plan is to acquire a second power amplifier identical to the existing one or at least of comparable quality (though less power may be necessary) and trade in their mono control unit for its stereo counterpart.

Stereo Pickups preferred for Mono too

One practical feature which has encouraged people to play mono as well as stereo through twin loudspeakers is the fact that stereo pickups play monaural discs so well. They usually generate an equal signal in both channels, and so there is a minimum of re-plugging and re-setting of controls, when listening to a programme of mixed stereo and monaural records. The subjective effect of listening to a standard LP through two loudspeakers is quite different from that of true stereo. Of course there is no sensation of being able to locate the different musical instruments in the orchestra, but the mere fact that the sound appears to come from somewhere in space instead of being tied to a single loudspeaker grille helps the illusion of realism.

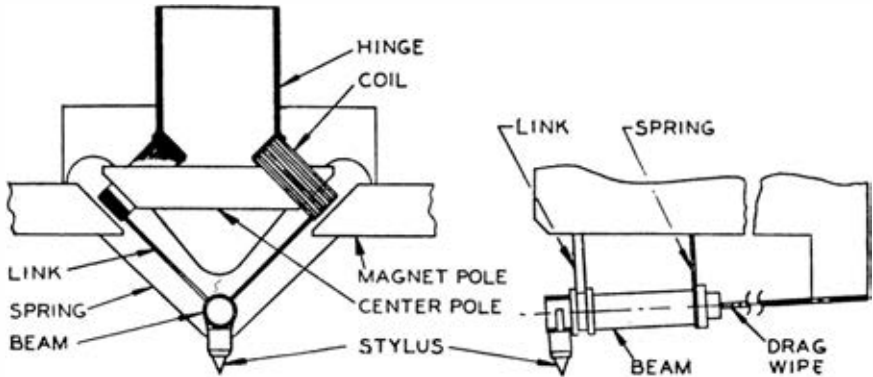

Fig. 8.6—This Westrex stereo pickup demonstrates the use of twin coils and lever systems to give a response to movements at 45° to the disc surface. Such a pickup can be used equally well for single channel lateral discs.

Very worn LPs show up rather worse when played with a stereo pickup. This is only to be expected, with the finer point of stereo styli—0.0007 or 0.0005 in. tip radius, compared with the standard LP point of 0.001 in. (one 'thou'). But here too the 2-loudspeaker system scores, because the surface noise seems to become detached from the music—at least in the writer's experience—and less of a nuisance.

How to Accommodate Stereo

Having pointed out so many of the advantages of two-channel hi-fi, what about the snags? The chief of these is cost, and the next is space. Except that the recording companies delight everyone by making the price of stereo discs the same as standard LPs, twin channel sound is bound to cost more than monaural. Ideally, if there is to be no sacrifice of quality, we should duplicate the existing amplifiers and loudspeaker.

This could be an expensive business, as can be seen by quoting two examples. Consider first of all someone who has invested in Acoustical Manufacturing Company units for monaural reproduction, i.e., Quad II Control Unit (£19 10s), Quad II Amplifier (£22 10s.) and Quad Electrostatic Loudspeaker (£52). To convert to stereo, he has three alternatives: (a) duplicate the lot, at a cost of £94, (b) duplicate the amplifier and loudspeaker, and trade in the Quad II Control Unit for the new Quad 22 Stereo Control Unit (£25), at a total cost a little less than before, and (c) acquire a less powerful and cheaper amplifier and/or a cheaper loudspeaker system, costing perhaps £35. Remember too that the above costing does not include the purchase of a stereo pickup, and assumes that the existing turntable is satisfactory.

Before analysing these alternatives, let us quote similar calculations for a man who has the Junior range of Rogers Development Corporation equipment, i.e., Junior Mark II Control Unit (£11), Junior Amplifier (£17) and, say, 1284 Column Loudspeaker (£26 10s.). To convert to stereo, the alternatives are as

before: (a) duplicate everything, at a cost of £54 10s., (b) duplicate amplifier and loudspeaker, scrap control unit for Junior Stereo Control Unit (£19 10s.), total cost similar, and (c) acquire less expensive amplifiers and loudspeaker.

In each of these examples (b) is perhaps to be preferred to (a), since the layout and ganging of the controls simplifies operation. I don't think anyone would seriously recommend (c). Of course it is a little less expensive, but should be considered only as a stop-gap or a way of employing odd standby equipment you happen to have lying around. Quite a few people I know have such an ambitious loudspeaker system for monaural that building an exact duplicate is out of the question. And it isn't every living-room that could accommodate, for example, a pair of Mr. Briggs' sand-filled baffle 3-way units.

Compromise may be necessary

This question of space is important, and the need to adjust the relative positions of the loudspeakers for best results would in any case seem to preclude the use of two *fixed* corner loudspeakers. A perfectly satisfactory compromise can be obtained by using a free-standing unit of *comparable* performance. Setting up for twin-channel reproduction then consists of positioning and angling this second speaker till it balances the fixed system.

Realising the pressure that the combined restrictions of cost and space must exert, designers have produced a number of ingenious, small shelf-mounting and column loudspeakers with a wider frequency response than used to be thought possible. The basis of one plan available from Goodmans Industries Limited, is the fact that our location of sounds depends more on the high frequencies than the lows. Accordingly a central main loudspeaker is used to handle bass frequencies, and the spaced units handle frequencies from 300 to 15,000 c/s. They are known as Stereophonic Bowls.

Another system which was given an impressive demonstration at the London Audio Fair came from Rola Celestion Ltd., and comprised a central bass loudspeaker, plus two very small tweeters fastened to the wall about 8 feet apart. The advantage of the smaller stereo systems is that they allow for experimental positioning which is necessary to get the most satisfactory spacial effect, and compensate for the room acoustics.

INSTALLING HI-FI

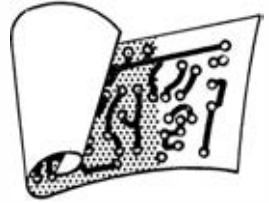

Hi-Fi equipment has been much streamlined and “face-lift”-ed over the last few years—so much so that the Design Centre even devoted an exhibition to it recently and it was gratifying to see a considerable number of pioneer names in Hi-Fi manufacture represented. This effectively demonstrated that you no longer need a maze of wires and an engineer’s ticket to pursue good quality sound. Part of this move to make Hi-Fi respectable has shown itself in the development of “packaged” high fidelity components, i.e., amplifiers, tuners, and even record players and cabinets produced as a “matching” system by a single manufacturer. But even if you “go the whole hog” and buy a coffee table or console ready crammed with disc, radio, and tape gear, plus one or more matching loudspeakers, and quite rightly put the music higher in importance than the technicalities, there are a few practical points that you cannot afford to ignore. In any case, it is a fairly safe bet that your taste for high fidelity will be sharpened

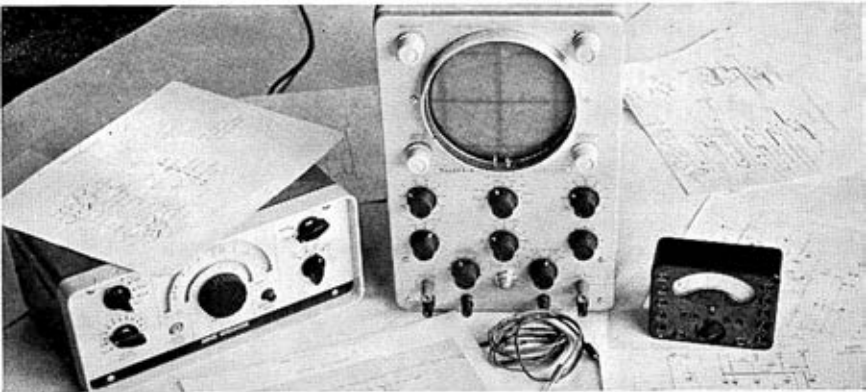

You may come to this, too—but the homely screwdriver will do for now!

as you listen, and you will want to make changes or add a few bits from time to time.

The outline diagram (fig. 9.1) shows the connections in a typical Hi-Fi rig. The solid lines are mains cables, the principal one being that to the main amplifier, which consumes more power than any other unit, and often houses a power unit strong enough to supply HT and LT to one or more radio tuners as well as to its associated control unit/pre-amplifier. This lead must be 3-core, with the earth wire firmly connected as described later. It is the usual practice to arrange that this mains supply is switched on and off from the Control Unit, so that a 2-core cable is usually extended from the Amplifier to the Control Unit's On/Off Switch, as shown. The mains cables to the gramophone motor, "self-powered" tuner, etc., may also be 2-core. In fact, if 3-core cable is supplied, it will often be found better to leave the green earth wire disconnected, as is discussed below.

Where HT and LT are supplied to ancillary units from the main amplifier, special multi-core cables are employed. No special difficulty is likely to be experienced in connecting the loudspeaker lead. This will normally consist of

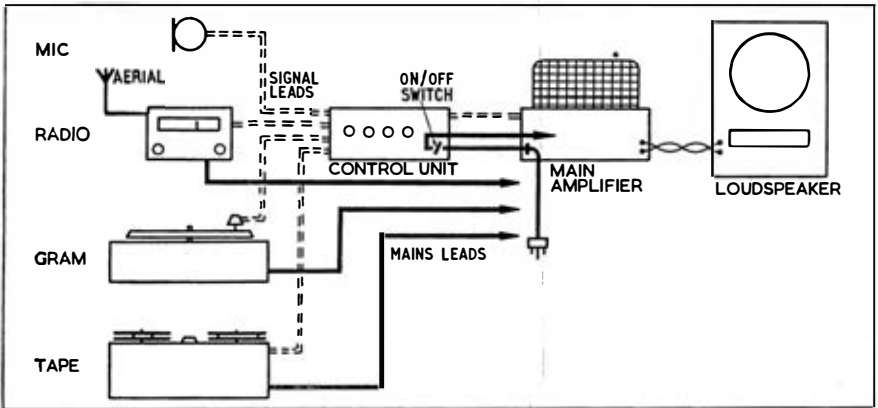

Fig. 9.1—Outline diagram of the Hi-Fi essential wiring. The mains leads are self-explanatory, except that only one earth wire will be used. All signal leads should be of screened co-axial cable and the loudspeaker lead may be of any suitable flex.

ordinary twin flex, and may be of quite thin gauge, except for distances in excess of about 20 feet. The signal leads into the Control Unit are invariably of co-axial cable, i.e., with a single central "live" wire insulated from an enveloping screen of braided wire designed to keep mains hum away from the tiny signal.

Learn to Respect the Mains Supply

First comes that well-known lethal weapon, the Mains Supply. If you are one of those types who always lets his wife mend the fuse, you should read every word that follows, and let it sink home. Fitting a mains plug is an operation everyone should learn to perform correctly. Looking at the diagram (fig. 9.2), the usual 3-pin 5-amp. plug is shown with the thicker Earth pin at the top. Held

INSTALLING HI-FI

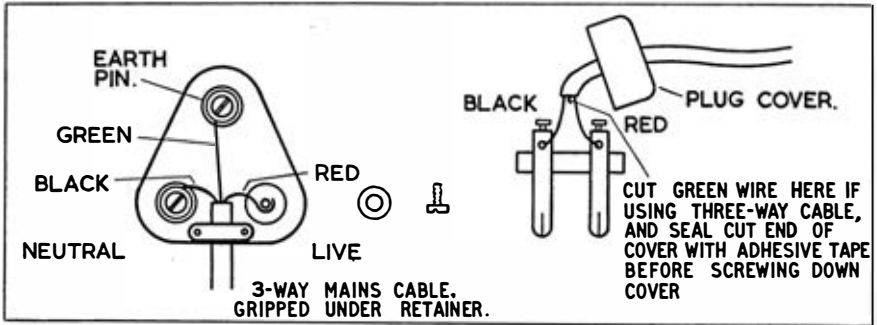

Fig. 9.2—The correct way to wire-up 2-pin and 3-pin plugs.

like this, the other two pins become Neutral on the left, and Live on the right. The regulation colour coding is Red—Live, Black—Neutral, Green—Earth, and in following this, it helps to cut the green wire slightly longer than the other two to lie easily in the plug.

I would emphasise that fixing the wires on to the pins should be done firmly and neatly, with no stray strands. Use a proper screwdriver and side cutters, or the Bib wire stripper, if you have one. Leave a small amount of slack in the plug, and tighten up the collar screws so that any tugging on the cable puts no strain on your electrical connections.

Other Types of Plug and Flex

The above description holds good for fixing a 3-wire flex to any of the types of 3-pin plug, e.g., the smaller 2-amp. type, or the flat pin, fused plugs employed in a Ring-Main system in new houses. With the latter, the clips which hold the fuse help to identify the Live (Red) pin. In yet another type of 3-pin plug the Live pin actually consists of a screw-in fuse.

If the particular piece of apparatus you are connecting up has been supplied with a 2-wire flex only, i.e., no green wire, you can connect its red and black wires to the Live and Neutral pins of a 3-pin plug as above. Alternatively it may be wired to a 2-pin plug or the bayonet-type adaptor for a lighting socket.

One combination remains—a 3-wire cable wired to a 2-pin plug or adaptor. When you do this, never leave the green wire dangling loose. Cut it off level with the end of the plug, or tape it back out of the way (see fig. 9.2 above).

Sockets fixed on the Chassis

Sometimes the mains lead enters the apparatus by means of a plug and socket instead of being permanently wired in. This is quite a good arrangement, as it enables you to isolate the equipment from the mains without diving underneath to find the wall-socket. The plug at the apparatus end of the flex has a locating key to ensure correct insertion, and the Earth pin is opposite this key. To identify the Live and Neutral pins, think of this plug as a socket, i.e., reverse left and right.

To Earth or Not to Earth

As a general rule, all apparatus should be earthed, but there are exceptions. The theory behind earthing is that, because it contains an infinite number of electrons, the Earth will impose its potential on any object electrically in contact with it. This will be our potential too, and so we cannot suffer an electric shock on touching the metal parts of a piece of earthed equipment. A second advantage of earthing is that hum voltages—causing an audible drone at the AC mains frequency of 50 c/s or two or three times this frequency—are thereby kept to a minimum.

Of course, your equipment will be at earth potential only if the earth lead has zero resistance, so make sure that earth connections are well and truly fixed, of sound wire, and no longer than necessary.

The Exception

One exception to this rule of earthing occurs when two or more pieces of mains-operated sound equipment are to be connected together. Here, illogically enough, too many earth connections are a bad thing, as loops are formed in which annoying hum currents can be set up. So in this case, earth one component—say the main amplifier—and leave the other green wires disconnected. The leads connecting programme inputs, etc., will give the necessary earthing of the other units via the sleeving, without setting up loops. One final word: do set the 200–250 mains voltage selector on each item of equipment to the value printed on the card issued with your electricity meter.

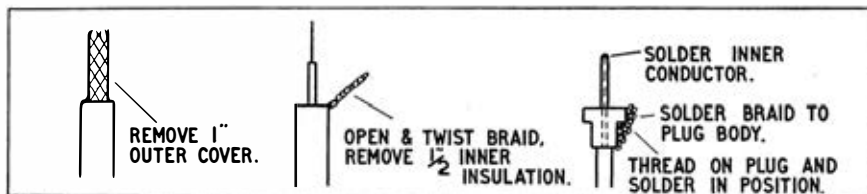

Fig. 9.3—Showing the correct procedure for fitting the small metal phono plugs to co-axial cable.

After the mains plug, we come to the plugs used to interconnect the units—and there is a bewildering assortment of these in current use. Remember that these can be just as dangerous as the mains. Therefore make it a rule *never* to disconnect the auxiliary units from the main amplifier while the mains is switched on. This warning will obviously apply to “self-powered” units, but may seem less essential for those which contain no power unit. But remember that several hundred volts HT may be present, and this wallop may, in fact, continue to exist for some little time after you switch off, while the large capacitor in the supply unit discharges to earth. In the case where an On/Off switch is provided on the pre-amplifier, then AC mains is evidently present in the lead up to the switch, *even when you have switched off*. So unplug from the mains before doing any work on the equipment. Finally, if you simply must plug in aerials, gram units, etc., with the mains switched on, I suggest you keep one hand

INSTALLING HI-FI

behind your back, or safely in your pocket. Touching a “live” component results in a nastier shock if your other hand is resting on an earthed chassis or motor board.

The miniature co-axial plugs in common use are rather fiddling to solder. The points to watch are that no single strand of wire is left free to wander from the live centre lead to the outer shield or vice versa, and that too much heat is avoided, since there is a danger of melting the insulation and allowing the live and earth surfaces to meet.

The correct procedure for fixing a plug to co-axial cable is as follows: first slice round, and pull off about 1 inch of the cable’s outer covering, without damaging the braiding. Then unpick the braiding, and twist it a few times to make a prong ready for soldering. Next, bare about $\frac{1}{2}$ inch of the inner wire, trim it carefully, push it through the centre pin of the plug, and solder. Finally, make a good soldered or screw-on connection (depending on the type of plug) between the metal braiding and the sleeve of the plug. The two most common types of co-axial plug are illustrated in **figs. 9.3** and **9.4**.

Installing a Turntable

Transcription turntables are despatched complete with instructions for setting up, but there are a few signposts which might usefully be given here. You will presumably have checked in advance that the motor board area will easily take the chosen turntable, plus pickup. Remember, too, that some pickups require quite a space allowance if the counter-balance is to swing clear of the cabinet walls. Use a motor board of a good thickness—at least $\frac{1}{2}$ inch, and try and avoid placing the turntable in a deep well. This makes disc changing and pickup handling unnecessarily awkward. Use a spirit level, as recommended in Chapter Five, and get the turntable level in all directions before going any further. If you are going to have dynamic levelling, it will be easier to fix this starting from the level position.

Make sure that the motor, too, has taken up a horizontal position, suspended freely from its rubber grommets, or other shock-proof supports. Note that many turntables arrive with special transit screws to prevent the mounting being damaged *en route*. It is obviously necessary to undo these on installation, but rumble and noisy reproduction have often been traced to failure to carry out this simple operation.

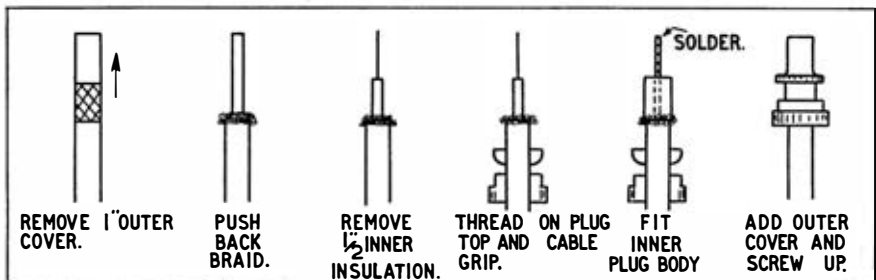

Fig. 9.4—Co-axial plugs are a little more difficult to fit, but make a well-screened connection.

Installing a Pickup

It may be that you have purchased a turntable with integrated pickup arm, and so have no positioning problem. In all other cases, however, the exact position of the pickup arm relative to the turntable must be tackled with precision. The first decision is on which side of the turntable the pickup should be fixed. Most people will prefer this to be on the right-hand side, with the pickup head nearest to the front (i.e., towards the operator). Other positions are sometimes chosen, however, or dictated by questions of available cabinet space, and there is no objection provided it is arranged that the pickup does not pass over the motor as it tracks across the disc. This proviso is made with a view to avoiding hum pick up from the motor (see **fig. 9.5**).

Having chosen the pickup's rough position, it is next necessary to find the precise point at which the centre of the pivot cut-out should come. The positioning of this depends on the length *and* design of the particular arm, and should be carried out according to the maker's instructions and template, if supplied, to within one-tenth of an inch accuracy. A quotation from the specification of the Goldring G-60 arm will show how important these dimensions are—"Tracking length $9\frac{11}{32}$ "; length from pedestal spindle to turntable spindle $8\frac{7}{8}$ in.; overhang $\frac{15}{32}$; offset angle 21.5° ; maximum tracking error 2° over 12-in disc". Except for a number of special combination designs of arm and head, such as the Decca ffss, most pickup arms have a standard shell fitting, with two holes $\frac{1}{2}$ " apart which will take any one of the popular types of cartridge. At the cartridge end of the arm, the electrical connection will usually consist of push-on terminals, to braided wire which runs the length of the arm, through the hollow pedestal, and hangs loose for a length of up to 2 feet.

Watch the Lead

This wire is nowadays made of extremely thin gauge, and must be carefully run through the pivot to ensure that no side friction occurs which would interfere

Fig. 9.5—When installing a pickup, the Makers' instructions will indicate the correct position for fitting the pickup pivot. As the diagram shows, the pickup may be anywhere relative to the turntable, provided only that the pivot is placed exactly at the recommended distance from the turntable spindle.

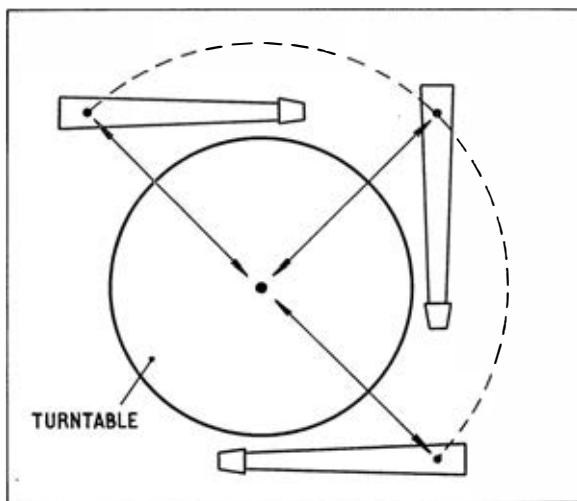

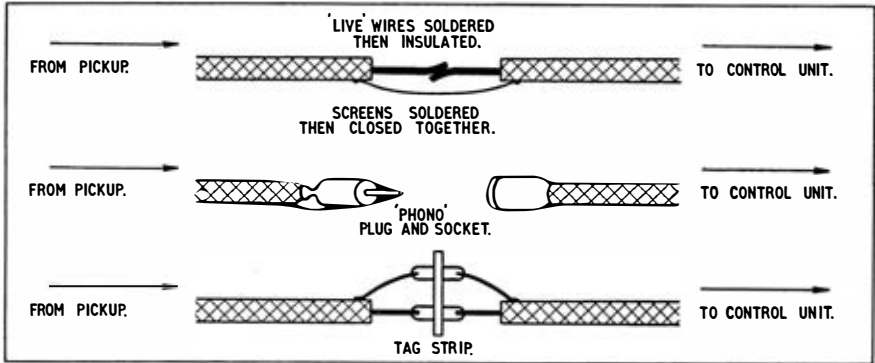

Fig. 9.6—Extending the pickup lead should be avoided, if at all possible. When necessary, however, any one of the above alternatives may be used, the essential feature being that the screening must be continuous over the whole length of the lead.

with the pickup's movement across the disc. Once again, failure to observe this simple point is a frequent cause of distortion and groove-jumping. A short loop should be left free, and the pickup lead anchored to a convenient point on the motor board, say, 6 inches from the pivot. There are a number of ways of terminating the lead. If the control unit is conveniently placed, then undoubtedly the best idea is to solder the lead directly into a co-axial plug, and plug in. But an extension may be necessary—deprecated, since the tiny signal from a pickup is particularly prone to hum induction—and you must decide whether to splice a further piece of co-axial cable direct to the lead, or via a plug and socket, or a tag board. These are illustrated in **fig. 9.6**, and it is emphasised that absolutely as little of the live wire should be left unscreened as is humanly possible. Before cleating the pickup lead into its final position, it is as well to move it into different positions by hand, with the motor running, pickup selected on the control unit, and the volume turned well up. You will then be able to choose a route which gives minimum hum pick up.

Installing an Amplifier

Ideally, the main amplifier, and particularly its transformers and power supply, should be a minimum of 2 feet from the pickup and/or tape head, to avoid hum. A fair amount of heat is being generated, too, so good ventilation is essential. For these reasons, the main amplifier is often most happily situated on the floor of the cabinet, with some kind of expanded metal or other open-work grille allowing a free circulation of air. Its exact orientation should be capable of adjustment, because it is sometimes found that turning it so that the mains transformer is at a certain angle to the pickup (or even balanced on its side!) is necessary to cut down hum.

The control unit, conversely, should be close to the pickup, tape deck, and tuner, since the connecting leads are to be kept short, and the leads joining control unit and main amplifier will usually be of about 3 feet length to allow

convenient positioning. Nowadays more and more control units—and integrated amplifiers—are being made boxed in attractive cases to allow free-standing on a shelf or table. If this plan suits the circumstances, then installation is easy, and simply a matter of tidily concealing the bundle of input and output cables. More often, however, the control unit will be mounted flush into a panel. This panel can be vertical, on the front of the cabinet or built-in fitment, or else you can suspend the control unit on its back, through a horizontal panel alongside the turntable. Either way, the installation is extremely straightforward, and consists of cutting out a shaped hole according to a template supplied with the unit, pushing the control unit through, and bolting it from behind.

Once the various inputs have been plugged into their appropriate sockets, and tested, you should not require access to the back of the control unit very often, but nevertheless you should know how to get there when necessary. Some of the inputs on the control unit may have pre-set volume controls—short shafts with a screwdriver slot in the end. When installing the gear it is best to adjust these controls till the unit in question gives ample loudness with the volume control on the front of the control unit at about half-way. Then switching from disc to radio, etc., should give equivalent volume without further fiddling. This is our cue to warn against over-addiction to “knob-twiddling”. The bass and treble controls should be adjusted during the initial setting up, to compensate for deficiencies or over efficiencies in the loudspeaker *placed in the particular room environment*, and will seldom need altering. The low-pass filter (top cut) is useful for noisy or “toppy” gramophone records and tapes, and poor radio conditions, but should not be over-worked. The high-pass filter (rumble) will be In or Out according to the quietness of the motor, and need not be moved. Volumes could be written about the correct use of the volume control (pun not intended), but suffice to say that the realism of high fidelity is very much tied up with its being reproduced at just the right volume. And too much is just as bad as too little.

The wiring of loudspeakers, using ordinary twin flex, is an extremely straightforward operation, and was discussed in Chapter Two. The choosing and exact positioning of loudspeakers is a very individual matter, however, and it is his selection from the many possible solutions—plus his choice of programme material—by which each enthusiast is able to make his most individual contribution to the continuing advance of Hi-Fi.

CHAPTER TEN



Q.1. *After hearing and enjoying Hi-Fi music in a friend's house, I decided to set up Hi-Fi for myself, but the more I look into it, the more confused I become. Does it really have to be so complicated?*

A.1. No, a home music system giving a good standard of reproduction need be no more complicated than its owner wishes. Admittedly, at one end of the scale there is an army of dyed-in-the-wool Hi-Fi enthusiasts for whom "the end justifies the means". In other words, they feel that sound reproduction of the highest technical excellence is such a worth-while objective in itself that mere questions of "lebensraum" (room to move), pounds of wire strung about in Heath Robinson profusion, or even knocking holes in the wall are considered secondary. But you are presumably not one of these.

*

*

*

Q.2. *With me, it's the music that comes first. I like what I've heard of Hi-Fi because it comes so much closer to the real sound of live music-making than my present radiogram does. I find I enjoy the music so much better when I don't have to strain to identify the instruments. But if it needs boxes all round the room to produce Hi-Fi, then I'll have to go without. What is the minimum number of actual pieces of furniture I need?*

A.2. You can have Hi-Fi with a single box, plus the loudspeaker, which I think you'll agree is a reasonable enough proposition. But the first thing to decide is which of the sources of programme material—gramophone records, tape records, radio, and television sound—you want to use, now or later on.

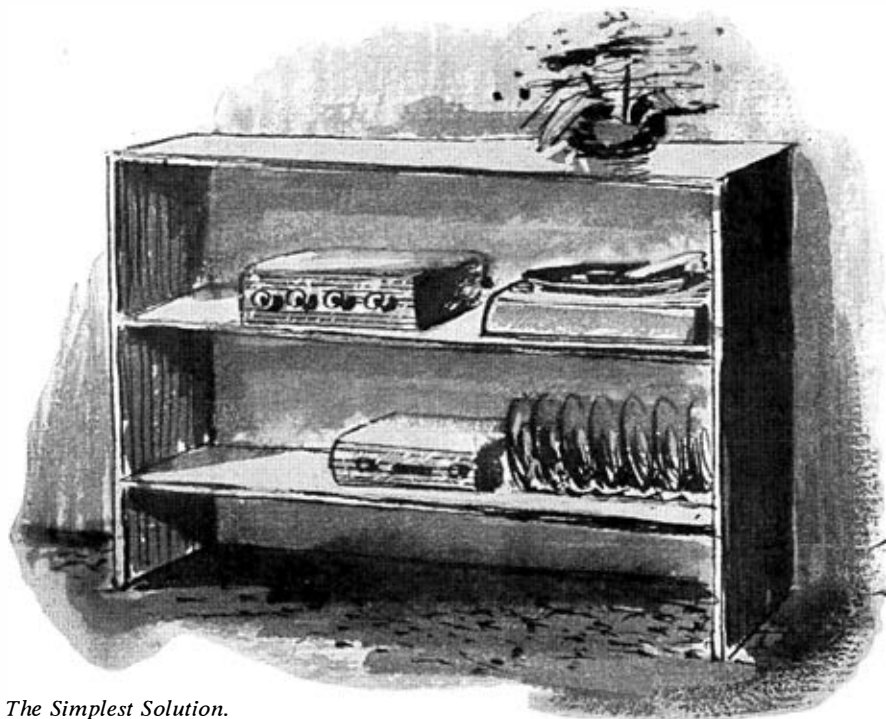

The Simplest Solution.

Q.3. *Supposing I just have discs to begin with?*

A.3. Then you need a Transcription Turntable, Pickup, Amplifier/Control Unit, with a suitable cabinet to hold them; and a Loudspeaker. If you turn to the chapters devoted to each of these components, you will soon get an idea of what to look for in buying.

* * *

Q.4. *Yes, but what would be the simplest solution, if I were anxious not to spend too much money?*

A.4. Get a turntable and pickup combined, such as the Garrard 4HF or the Collaro 4T200, and a shallow, lidded box to house it. This could then live on a shelf alongside one of the attractive free-standing integrated amplifier/control units, such as the Pamphonic 1004, Jason J10, Pye HF10M, Rogers HG88, or Tannoy "Hi-Gain 15". This would eliminate the need for a cabinet. I suggest we leave the question of choosing a loudspeaker for the moment. But if we say £20 for the speaker, £18 for the turntable and pickup, £24 for the amplifier, you have a neat disc installation for just £62.

* * *

Q.5. *And what about the simplest solution if I am prepared to pay a bit more?*

A.5. Undoubtedly to buy a fitted cabinet with turntable and amplifier already installed. There has been a good deal of activity in this direction by many of the

QUESTIONS AND ANSWERS

great names in Hi-Fi manufacture, and you will be able to choose a coffee-table type cabinet—convenient for armchair operation—or a console fitted with the components of your choice. To quote three examples, there are the Leak Southdown cabinet, costing £53 13s. complete with Varislope III pre-amplifier, and TL/12 power amplifier; the Pye Mozart Lowboy, price £33 12s. including HF10 amplifier; and the AEI Coffee Table cabinet, price £34, less units. In addition, there are a number of Hi-Fi dealers and furniture specialists who can supply this kind of tailor-made installation, using their own cabinets, or furniture you already possess. Examples are Largs of Holborn, Imhof Ltd., Record Housing, Design Furniture Ltd., Modern Electrics Ltd., and Period High Fidelity.

* * *

Q.6. *That gives me plenty of ideas for getting Hi-Fi from discs. Now can I add radio?*

A.6. Absolutely. Even if you don't include radio listening on your original Hi-Fi installation you are certain to want to add it later on—and I ought to say, of course, that practically all of the tailored cabinets we have mentioned will accommodate radio when required. What you need is a tuner which you plug into your Hi-Fi amplifier. The VHF/FM transmissions in the range 88 to 100 Mc/s (known as Band II) give better quality reception than Medium and Long Waves in most parts of the country, so a VHF/FM tuner should be your

An attractive solution to the housing of Hi-Fi equipment—both from the appearance and technical points of view—is to invest in one of the proprietary cabinet designs which exist for most of the better known types of Hi-Fi equipment. Shown in the photograph is the Southdown cabinet designed for Leak amplifiers and tuner, plus any of the popular transcription turntables.



first choice. However, if you want to listen to foreign programmes too, get Medium, Long and/or Short Waves on a so-called AM tuner, or get the whole lot combined on an AM/FM tuner.

* * *

Q.7. *I seem to remember that you included television sound as a possible source of music in A.2. Can I add this to my Hi-Fi set up?*

A.7. It is dangerous to link a standard TV set to other electrical apparatus, but you will find that one or two Hi-Fi tuners are now being made with the added facility of being switched to pick up the BBC and ITA Sound channels. Examples are the Jason JTV/2 and Monitor tuners, the Lowther D/VHF, and the Symphony Amplifiers Ltd. "Tuner Symphony".



Jason JTV/2

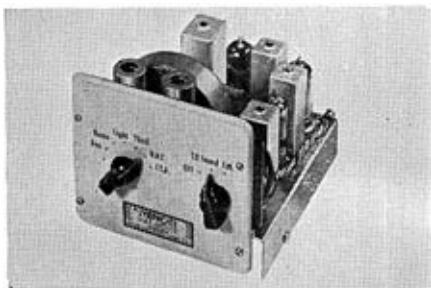

Symphony Tuner

Q.8. *What about tapes? Supposing I have set myself up with a reasonable Hi-Fi disc system, can I add tape easily?*

A.8. You can add tape *replay* facilities fairly easily, by buying a tape deck. The replay head fitted to the deck is analogous to the gramophone pickup, and many Hi-Fi amplifiers possess an input socket specially for use with a tape head. Should your amplifier not include this, you will require a small booster amplifier, costing around £5 to give the necessary extra gain, and tape frequency correction. You will find that, at the present time, the repertoire of recorded music available on tape is quite small compared with disc, but there are signs that tape records will come increasingly into vogue.

* * *

Q.9. *What must I add to my Hi-Fi equipment to give me tape **recording** as well as playback?*

A.9. You can purchase either a complete tape recorder, or a deck, as just discussed, plus "electronics". This last item is a little complicated, comprising as it does frequency-corrected record/replay amplifiers, and a bias/erase oscillator, so the non-technical beginner would be better advised to choose the first alternative—a complete recorder—which would have the advantage of being ready to operate for *ad hoc* recording work away from, and independent of, the main Hi-Fi installation.

* * *

Q.10. *Well, that makes me feel a lot happier about the equipment I need. Can I ask you something else now, about technical jargon? As soon as I began*

making enquiries about Hi-Fi I found that it seems to have a language of its own. Is it necessary for me to learn all these technical terms?

A.10. It will help you to go shopping knowledgeably for Hi-Fi, read manufacturers' specifications and installation instructions, and get the best from your gear if you have at least an elementary understanding of a *very few* special terms. The number of these is not at all formidable, and I think we can dispose of them here and now.

Specifications

Q.11. *All right, let's begin with a gramophone pickup. The specification* of the Tannoy Variluctance pickup reads: "Variluctance turnover cartridge. Output voltages: LP 10–12 mV, 78 18–20 mV. Frequency range: 20–16,000 c/s \pm 2 dB. Playing weight: 5–6 gm. Load Impedance: 50,000 ohms. Available with 2 diamonds; 1 diamond, 1 sapphire; or 2 sapphires." I think you'll agree, that to an absolute beginner like me, that might as well have been written in Serbo-Croat! To begin with, what on earth is Variluctance?*

A.11. The word "Variluctance" is Tannoy's own portmanteau trade name for this particular pickup, so it is not strictly a technical term. However, it is in fact an abbreviation of "variable reluctance" and you should be able to recognise this as a special type of magnetic pickup. As you will see discussed in Chapter Four, magnetic pickups generate their output through the stylus vibrations either making a coil move in a fixed magnetic field, or making the field vary round a fixed coil. Variable reluctance pickups belong to the latter variety.

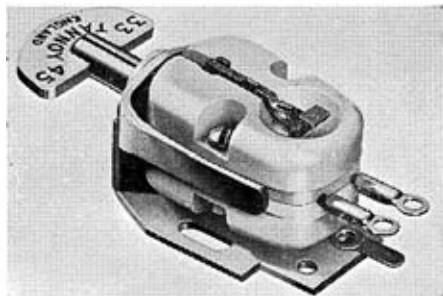

The technical specification of the Tannoy Variluctance pickup cartridge is discussed in the text. It belongs to the family of turnover cartridges combining coarse groove and microgroove styli in a single unit so that all types of gramophone record may be played. The base plate holes are fixed a standard $\frac{1}{2}$ in. apart for fitting to any make of pickup arm.

Q.12. *What is a turnover cartridge?*

A.12. The "cartridge" is the sensitive portion of the pickup head, and is often made in the form of a self-contained unit, with a mounting plate having 2 holes spaced $\frac{1}{2}$ " apart, to allow fixing to a wide range of pickup arms. Clearly, to cope with both coarse groove (78 rpm) and microgroove ($33\frac{1}{3}$ and 45 rpm) discs, different thickness styli are required and possibly different dimensions of the magnet/coil structure. This has led to the use of either separate "push-on" heads for 78 and LP or, as in this case, a "turnover" cartridge which you rotate according to the type of record to be played. Whenever any colour coding is used, red is taken to indicate LP.

* All the specifications in this section are quoted from the 1960 "Hi-Fi Year Book".

Q.13. *Why should I be interested in knowing the Output Voltage?*

A.13. Only in so far as it is necessary, when considering any given combination of pickup and amplifier, to check that the amplifier has sufficient gain and the correct characteristics to produce its full output when fed by the particular pickup. The Varilutance pickup, giving only 10–12 millivolts on LP records must be used with a fairly sensitive amplifier.

* * *

Q.14. *How can I tell whether the quoted Frequency Range is good or bad?*

A.14. The Frequency Range quoted here “20–16,000 c/s \pm 2 dB” can be regarded as very good. Firstly, the range of audibility for the average adult pair of ears is about 20–16,000 c/s, so this tells us that the pickup will reproduce all audible tones, and secondly the \pm 2 dB indicates that the pickup responds *equally* to this wide range of frequencies within a close tolerance of volume.

* * *

Q.15. *How important is the Playing Weight?*

A.15. The downward pressure of the pickup has a bearing on the degree of disc and stylus wear, the ability to track “difficult” or heavily modulated discs, and the reproduced quality. Pickup designers work to produce the best compromise between these conflicting requirements, and it pays to use their suggested weight. Surprisingly, it is just about as bad to use too light a pressure as too heavy.

* * *

Q.16. *I'm sorry, but “Load Impedance: 50,000 ohms” leaves me completely in the dark.*

A.16. Once again, this is a straightforward piece of information to assist you in checking that this pickup will match a given amplifier. The pickup will deliver its specified voltage and frequency response only if loaded by an amplifier possessing this impedance or higher.

* * *

Q.17. *What are the relative advantages of sapphires and diamonds, I mean other than to a jewel thief?*

A.17. An obvious disadvantage is that a diamond stylus costs more than a sapphire stylus. (The Tannoy pickup mentioned costs £12 with 2 diamonds, and £7 with 2 sapphires, before adding Purchase Tax.) But against this must be weighed the much greater life expectancy of diamonds—some 2,000 hours, compared with 50 hours for sapphires (these figures assume a playing weight of 10 gm.). When it is remembered that a worn stylus may ruin a disc at a single playing, the value of diamond styli becomes apparent.

* * *

Q.18. *Thank you. I feel a little more knowledgeable on pickup jargon now. Turning to amplifiers, I see that the Quad II Control Unit specification reads: “Inputs: radio/tape 100 mV; mic. 1.5 mV; gram—to suit pickup. Treble, bass, volume and on/off, filter slope controls. Filter switch, 5, 7, 10 Kc/s and ‘out’. Tape record socket, switched playback socket. Harmonic Distortion: <0.1%.*

QUESTIONS AND ANSWERS

Hum and Noise: -70 dB." What should I be able to gather from the list of inputs?

A.18 The 100-millivolt Radio input corresponds to a sensitivity level adequate for all the popular tuners on the market. The similarly rated Tape input will cope with the Monitor output of a tape recorder, or if necessary its External Loudspeaker output. A booster amplifier would be necessary if the Quad were used with a tape deck. The 1.5 mV microphone input will handle the signal from all but the most insensitive types of microphone—e.g., for running a Public Address system, or recording. The “gram-to-suit pickup” entry in the specification indicates that any known pickup can be matched to this amplifier. The principle adopted by the designers of this amplifier has been to evolve an input circuit which will deal with the weakest known pickups, and then supply a range of plug-in matching units, which present the correct impedance for any given pickup, and reduce the strength of the signal from the stronger types.

Quad Amplifier and Control Unit

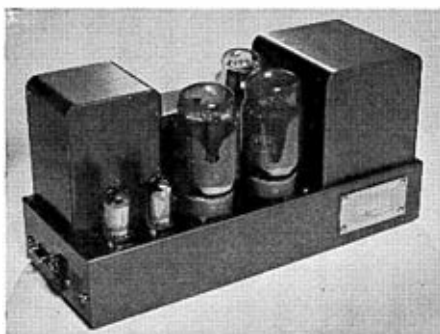

Q.19. *I am fairly happy about the treble, bass and volume controls, but what is the exact function of the Filter slope and switch?*

A.19. The extreme flexible system for controlling the response at high frequencies is a special feature of this amplifier. The switch selects at what frequency the attenuation will be applied—5, 7, or 10 Kc/s, and the slope control decides the rate at which the response will fall off at and beyond the selected

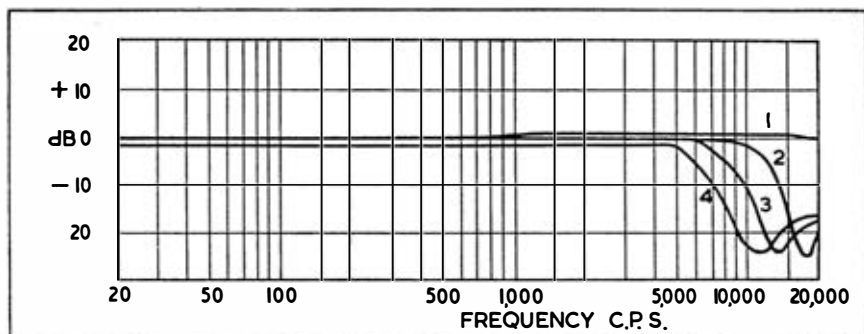

The graphs to show the maximum slope positions of the Quad treble filter system.

frequency. This can best be appreciated by examining the graphs of the filter, and you will see that this type of control allows particularly sensitive control of radio interference and whistles, poor gramophone records, and the like.

* * *

Q.20. *What about the "Tape Record Socket", and "Switched Playback Socket"?*

A.20. The former is common enough, and indicates that an auxiliary output is available for feeding a tape recorder, independent of that going to the main amplifier. This will allow recordings to be made from Radio, Disc, or Microphone without the need to run separate cables. In the Quad, it is at about 250 mV independent of tone and volume control settings. The switched playback socket indicates that the tape as recorded is ready for playback on switching to Tape on the input selector buttons.

* * *

Q.21. *Is "Harmonic Distortion: <0.1%" good or bad?*

A.21. There is a tendency in all amplifiers for this type of distortion to occur, resulting in the spurious generation of harmonics or overtones of the frequencies being amplified. The symbol < means "less than", and Harmonic Distortion at a level of less than 0.1% would be below audibility.

* * *

Q.22. *What is a good figure for the "Hum and Noise" specification?*

A.22. Anything below -60 dB is considered very good in a pre-amplifier.

* * *

Q.23. *The Quad II Main Amplifier specification reads: "15 watts. Distortion: <0.1% at 12 watts. Input: 1.4 volts rms for 15 watts. Frequency response: 20-20,000 c/s \pm 0.2 dB; 10-50,000 c/s \pm 0.5 dB. Noise Level: -80 dB with reference to 15 watts. Output Impedance. 7 and 15 ohms." Please, what is the significance of the "15 watts"?*

A.23. As you will find discussed in Chapter Three, a 10-watt amplifier produces enough power for listening in an ordinary room, but it is good to have some power in reserve. The Quad's 15 watts specification is therefore satisfactory for our purpose.

* * *

Q.24. *I recognize our old friend "Distortion: <0.1%" from Q.21, but why is there the reference "at 12 watts" this time?*

A.24. The degree of distortion which an amplifier will introduce rises as the working level is raised. It is, therefore, the recognised practice to state the power output obtaining for the quoted distortion. Thus "Distortion: <0.1%" would have little meaning by itself, but, followed by "at 12 watts", it tells us that this distortion figure will not be exceeded at all normal working volumes.

* * *

Q.25. *Why is it necessary to know that the "Input is 1.4 volts rms" (whatever that means) "for 15 watts"?*

A.25. Only if it is proposed to use this amplifier with some pre-amplifier other than the Quad. Naturally the Quad II Control Unit we have just been discuss-

QUESTIONS AND ANSWERS

ing in Q.18, and its stereo counterpart, the Quad 22 Control Unit, are designed to produce exactly this voltage, but units from other manufacturers vary a great deal in output voltage. Before coupling different makes, therefore, it is necessary to check this point.

* * *

Q.26. *The Frequency Response quoted as “20–20,000 c/s \pm 0.2 dB” looks very good to me, but why have they confused the issue by giving us an extra quotation “10–50,000 c/s \pm 0.5 dB”? Surely 50,000 c/s is supersonic?*

A.26. It is quite true that sound waves at 50,000 c/s would be inaudible—except presumably to bats and police dogs—and you may well ask why bother to specify an audio amplifier’s response to so high a frequency? The answer is that by giving proof of the unit’s ability to handle signals over a range wider than we actually require, the manufacturer reassures us that we are safeguarded from a number of distortions which can arise should the amplifier cut off *sharply* just beyond the audio extremities.

* * *

Q.27. *Again, from Q.22, I appreciate that “Noise Level: –80 dB” means a satisfactorily quiet amplifier. What does the last entry refer to, “Output Impedance: 7 and 15 ohms”?*

A.27. This helps us to make the proper loudspeaker connection. Nearly all Hi-Fi loudspeakers are rated at 15 ohms nowadays (or 16 ohms which is near enough), and so the usual procedure will be to wire the speaker to the 15-ohm terminals. However, a 7-ohm speaker *may* be met in practice, and there is the further use for the 7-ohm amplifier terminals that two 15-ohm loudspeakers connected in parallel should be wired to them (since two equal impedances wired in parallel behave like an impedance equal to half of either).

* * *

Q.28. *I’m glad that we’ve got round to loudspeakers at last. There are a number of questions I want to ask about them. For example, I like the look of*

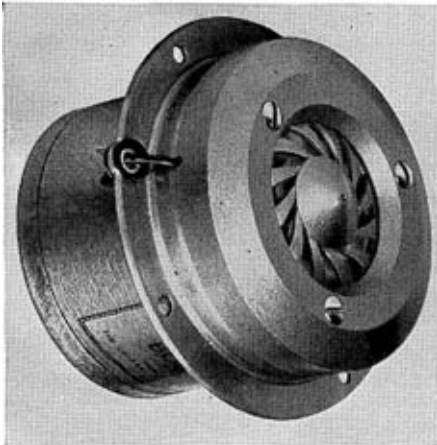

GEC Presence Unit
and Slender Periphonic Speaker

the G.E.C. Slender Periphonic Speaker, whose specification reads: "Tuned pipe reflex, forward facing. Two 8-inch metal cone drive units, plus one or two High Flux Presence Units. Size: 24 × 33 × 10 in." Please, what is a "tuned pipe reflex"?

A.28. You have chosen a loudspeaker with a number of unusual features, not the least of which is the fact that it is only 10 inches deep. A reflex loudspeaker (see Chapter Two) is simply one in which the sound waves radiated from the back of the cone are bent round so that they reinforce the front waves. The quality resulting from this arrangement is highly dependent on the length and volume of the "round about" path, and the G.E.C. design includes accurate tuning of these dimensions to match the given drive units.

* * *

Q.29. And aren't all speakers "forward facing"?

A.29. No, this fact is mentioned in the specification to distinguish the conventional forward radiating types (usually with solid backs) from the various speakers whose *front* is solid, and which are placed in a corner. Thus it is reflected sound which we hear from a rear facing speaker. This has the advantage of giving a more diffused sound, which some people prefer, and, in the case of horn-loaded loudspeakers, the walls form an extension of the horn.

* * *

Q.30. Why are there two drive units?

A.30. This is a feature of the present G.E.C. loudspeaker system, which they call Periphonic, and it involves acoustic coupling between two loudspeakers. The 8-inch metal cone unit is also a G.E.C. development.

* * *

Q.31. Finally, why does the specification say "one or two High Flux Presence Units"?

A.31. The G.E.C. High Flux Presence Unit is a sensitive high frequency speaker, measuring about 3 inches overall. Whether you choose to use one or two of these is a question of high and low frequency balance in the given room, and whether a diffused or directional effect is preferred. Each unit costs £6 10s.

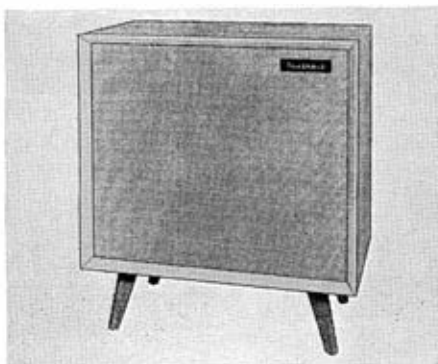

Heathkit "Cotswold" Speaker

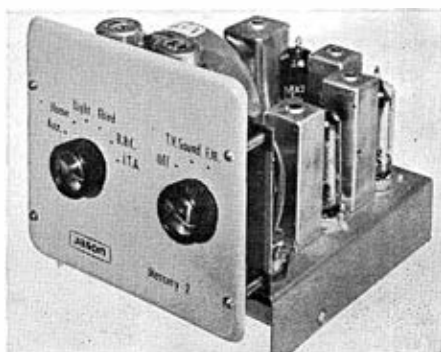

Jason "Mercury 2" Tuner

QUESTIONS AND ANSWERS

Q.32. *Wait a minute; what was all that about the room? Won't any loud-speaker work in any room?*

A.32. Yes and no. Of course the speaker will work, but the effect of the room itself cannot be ignored. In dealing with sound waves, it must be remembered that the quality of sound is coloured by the room, just as the quality of your voice is different in the bath and the lounge. The exact position of the loudspeaker in the room also has its effect, and there may be only a few places which sound right—some loudspeakers being more “choosy” than others. It is for this reason that a home trial is often recommended, before purchasing a loudspeaker.

Do It Yourself Kits

Q.33. *We hear a lot about “Do It Yourself” nowadays. I've never made anything more ambitious than a flower-pot stand. Do you think I could tackle the home construction of any Hi-Fi apparatus?*

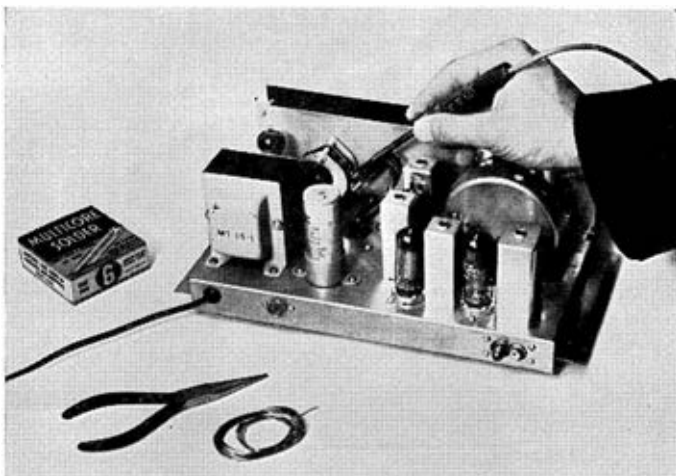

A.33. Building your own equipment from scratch, including designing, drawing out circuits, etc., would certainly call for a bit of specialised knowledge, and consume a great deal of time. To meet the demands of a rising number of people who want to make their own gear—and perhaps learn something about how it works at the same time—special construction kits are now made by several firms. These are accompanied by step-by-step instructions and illustrations so detailed that absolutely anyone can complete the construction easily even if they have never used a soldering iron before.

* * *

Q.34. *Could I build my own amplifier, for instance?*

A.34. Yes, there are monaural and stereo amplifier kits made by Heathkit (Daystrom Ltd), Jason, Altobass, and Pye. In addition to simple soldering of components (usually to a printed circuit board) all that is involved is the fitting

of the few necessary bits of iron-work. It must be admitted, however, that the “front end” of an amplifier, where the signal is at a low electrical level, needs careful assembly to minimise the introduction of hum and noise from stray fields.

* * *

Q.35. *How about a do-it-yourself tuner?*

A.35. Yes, both Heathkit (Daystrom) and Jason market tuner kits. To simplify the tricky assembly and lining up of the first stages in FM tuners, these are commonly supplied already assembled and tested.

* * *

Q.36. *So much for electronic kits, and it certainly seems as if they don't present too much difficulty, but could I, with no experience of carpentry, make my own loudspeaker cabinet?*

A.36. The Heathkit ready-to-assemble loudspeaker kits are extremely easy to build. One of these—the “Cotswold” was recently reviewed in *Hi-Fi News*, and found to perform well up to the standard of much more expensive off-the-shelf systems. There is also a handy column loudspeaker kit manufactured by D.G.C. Ltd.

Finally, if you have a little woodworking experience, or can prevail on the local timber merchant to oblige, you may obtain constructional drawings of cabinets to suit prescribed drive units from Hi-Fi loudspeaker manufacturers such as Wharfedale and Goodmans. In fact, the pursuit of Hi-Fi can really be said to be open to every type of listener, and, whether you decide to buy off-the-peg or build-it-yourself, I should like to end by wishing you what almost amounts to a definition of Hi-Fi—“good listening”.



SEEKING PERFECTION ?

Here it is!



H.M.V. AUDIO EQUIPMENT

**MODEL 555
10 + 10 WATT
"STEREOSCOPE"
INTEGRATED
STEREO
AMPLIFIER
63 gns**



Without doubt the finest integrated amplifier available today. Complete facilities for each channel include 7-position selector, 6-position function switch, high and low pass filters, loudness compensation. The "StereoScope" C/R tube (with inbuilt calibration signal) displays a modulated trace and provides for balance setting, frequency response checking and output level monitoring.

**MODEL 556 "STEREOSCOPE"
SELF-POWERED STEREO PRE-AMPLIFIER**

This unit is basically the same as the pre-amplifier section of Model 555 with additional features. It can be used in conjunction with any stereo power amplifier or pair of single channel amplifiers. It is self-powered and has cathode follower output. **39 gns**



**MODEL 557
10 + 10 WATT STEREO POWER AMPLIFIER**

A compact and completely enclosed unit. It is basically the same as the power amplifier section of Model 555. Total distortion is inside 0.5% 40 c/s to 15 Kc/s at the 10 watt level ± 1 db. Mid-range distortion 0.1% at 10 watts. For use particularly with pre-amplifiers 556 and 599. **30 gns**



**MODEL 599
STEREO CONTROL UNIT PRE-AMPLIFIER**

A high quality unit for utmost simplicity of operation. Designed for low sensitivity pick-ups. Power supply to be derived from associated power amplifier. **19 gns**

• **From your High Fidelity Dealer** •

THE GRAMOPHONE COMPANY LTD • HAYES • MIDDX

A to Z in AUDIO

A NEW BOOK

WITH **R. E. COOKE, B.Sc.(Eng.)**
AS TECHNICAL EDITOR

224 Pages, 160 Illustrations (of which 110 are original). Fine art paper. Cloth bound.

Price **15/6** (16/6 post free)

Published on 25th Nov. 1960

About 400 technical words and subjects relating directly or indirectly to Audio are explained, and commented upon in non-technical terms, and occasionally in lighter vein. Many facts and figures about loudspeakers, pick-ups, sound recording and reproduction, record players, tape recorders, television, transistors, etc., are included, thus providing a hand-book of reference.

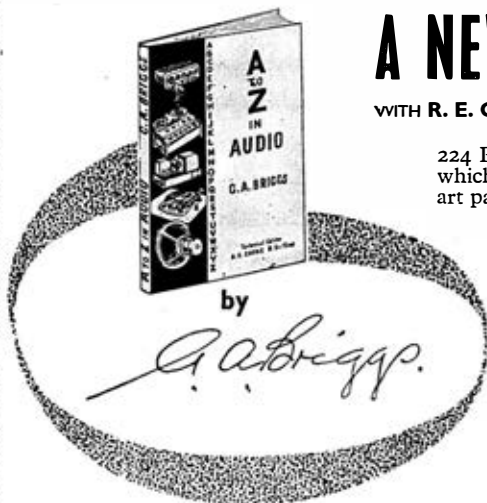

OTHER BOOKS BY G. A. BRIGGS INCLUDE



Loudspeakers
Price **19/6**
(20/9 post paid)



Stereo Handbook
Price **10/6**
(11/6 post paid)



Sound Reproduction
Price **17/6**
(18/6 post paid)



Pianos, Pianists and Sonics
Price **10/6**
(11/6 post paid)



Sold by Radio Dealers and Bookshops

IDLE BRADFORD Yorkshire

TELEPHONE: IDLE 1235/6 TELEGRAMS: 'Wharfedel' IDLE BRADFORD



STEREO AMPLIFIER AND CONTROL UNIT, TYPE S66

Twin channel, delivering 7.5 watts per channel with ultra linear output stage. Inputs for P.U., Tape and Radio, sensitivity being 6 mV. Separate treble and bass controls.

PRICE: Pre-amp £16. 10. 0 (No tax)
Amp £24. 10. 0

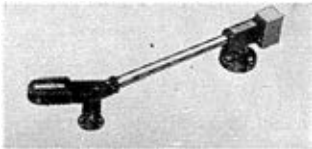

STEREO PICKUP MARK III

Designed to accept both monaural and stereo heads. Adjustable for heights of various turntables. Pickup head specification identical with the Type CSI.

PRICE: Arm only £3. 19. 11 (incl. tax)
Stereo head £7. 19. 11 (incl. tax)
Mark II Diamond head £8. 13. 3 (incl. tax)
Mark II Sapphire head £4. 13. 3 (incl. tax)



2 SPEED TRANSCRIPTION MOTOR

33 1/3 r.p.m. and 45 r.p.m. Full 12" turntable is lath turned. New nylon graphite bearings. Synchronous motor dynamically balanced. Neon indicator on/off warning light.

PRICE: £16. 13. 1 (incl. tax)

**A R SUGDEN & CO
(ENGINEERS) LTD**

Connoisseur

*the best
that money
can buy*
**FOR STEREO
OR MONAURAL**



VARIABLE 3 SPEED MOTOR

For 33 1/3, 45 and 78 r.p.m. Stroboscope fitted with internal light source. Synchronous motor dynamically balanced, resiliently mounted. Mechanical speed change giving 4% variation on all speeds.

PRICE: £27. 16. 1 (incl. tax)



STEREO PICKUP TYPE CSI

Pickup arm fitted with integral lifting device. The pickup head employs miniature ceramic units, frequency range 20-16,000 c.p.s., output 20 mV with channel separation of 20-25 dBs. Downward pressure 3 1/2-4 gram. Diamond stylus. Will accept Mark II monaural heads.

PRICE: Complete £12. 19. 10 (incl. tax)
Arm only £4. 19. 11 (incl. tax)
Head only £7. 19. 11 (incl. tax)

MARKET STREET, BRIGHOUSE

COMPACT HI-FI

by *Armstrong*

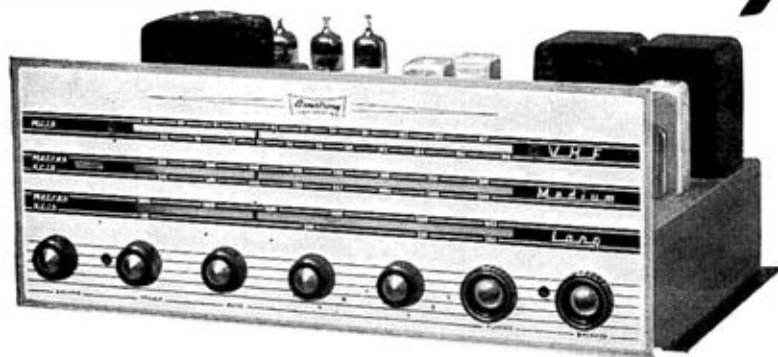

STEREO 12 Mk.2

42 GNS

TUNER-AMPLIFIER CHASSIS

The Stereo 12 Mk.2 is a new and improved version of the famous Stereo-Twelve. It is the most complete chassis ever produced, combining AM and FM Tuners, a comprehensive Control Unit and two High Fidelity Amplifiers in one compact unit. Compare the features and specification of each section with tuners and amplifiers sold separately and then compare the cost.

★ AM TUNER

Ferrite rod aerial, unique 2nd IF stage and efficient AVC provide good continental reception. Miniature tuning indicator.

★ FM TUNER

High Fidelity tuner covering the full VHF band (87-108 mc/s). Automatic frequency control ensures complete stability and easy tuning.

★ STEREO CONTROL UNIT

Separate bass and treble controls. Wide range balance control. Inputs for all pick-ups, tape record and playback. Booster unit available for low output pick-ups. Stereo radio input.

★ TWO HI-FI AMPLIFIERS

Each amplifier provides 8 watts push-pull output, 16 watts total for mono and stereo. Frequency response 20-30,000 c.p.s. \pm 2dB.

We specialise in the manufacture of high quality tuner-amplifier chassis in addition to our normal range of separate tuners and amplifiers. Other compact chassis available :

Stereo 55, 32 guineas; Jubilee Mk.2, 29 guineas; AF208, 22 guineas.

ARMSTRONG WIRELESS & TELEVISION CO. LTD., WARLTERS ROAD,
HOLLOWAY, LONDON, N.7. NORTH 3213



Hi-Fi by

Acos have long led the field in providing fine sound at a reasonable price. At the Cosmocord factory at Waltham Cross constant research and development ensures that new products are always being added to the ACOS and ACOStereo ranges.

Pick-ups—Acos Hi-Light and Acopoise

Acos mono and stereo pick-ups are the most advanced in the world. Sound reproduction is superb and record wear is reduced to an absolute minimum or virtually eliminated.

Cartridges—Acos GP67; ACOStereo 71, 73 and 81

Acos mono and stereo cartridges fit a great variety of equipment. They make ideal replacement cartridges for improved performance, reliability and good value.

Microphones—Acos 28-2, 39, 40 and 45; ACOStereo 44

There is a magnificent range of Acos mono and stereo microphones, all with excellent specifications, handsome appearance and reasonable prices. Most British tape recorders carry Acos microphones as standard equipment.

X500 Styli—Over 100 types to fit most popular pick-ups

Acos sapphire and diamond styli are individually tested at 500 times magnification and help to protect your records. The Acos Changer Dust Bug cleans records, reduces wear.

For the beginner at Hi-Fi (and for the old hand, too) Acos make sound sense.



ARE DOING THINGS IN STYLI

COSMOCORD LTD

WALTHAM CROSS, HERTS

Telephone: Waltham Cross 25206

New

High Fidelity Loudspeaker Manual



Goodmans High Fidelity Loudspeakers and loudspeaker systems have achieved world wide renown. A policy of continuous development maintains this position of leadership, and ensures that every model produced provides the best possible performance value in its price category.

Free

The NEW EDITION of Goodmans High Fidelity Loudspeaker Manual contains details and specifications of all Goodmans High Fidelity products, together with detailed information on choosing a loudspeaker, the design and construction of enclosures, stereophonic systems, stage built multiple unit loudspeaker systems, etc., etc., fully illustrated.

WRITE NOW FOR YOUR COPY!

GOODMANS

GOODMANS INDUSTRIES LIMITED, Axiom Works, Wembley, Middx.

Tel : WEMbley 1200 (8 lines) Grams : Goodaxiom, Wembley, England.

Europe's largest manufacturers and the World's largest exporters of High Fidelity Loudspeakers

SME

PRECISION PICK-UP ARMS

* *The finest
in the world*

More than just a pick-up arm the S.M.E. is a precision instrument of unrivalled quality and may be bought in the confident knowledge that no item in the reproducing chain will out-class it.

Reviewed in superlatives by leading authorities. It has come to be the standard by which other arms are judged.

An adaptor permits direct mounting of Decca heads, a combination which provides the highest quality of reproduction obtainable.

A fully illustrated brochure and technical reviews are obtainable on request. Exclusive distributing agents in principal overseas countries are listed below. They will welcome your enquiries.

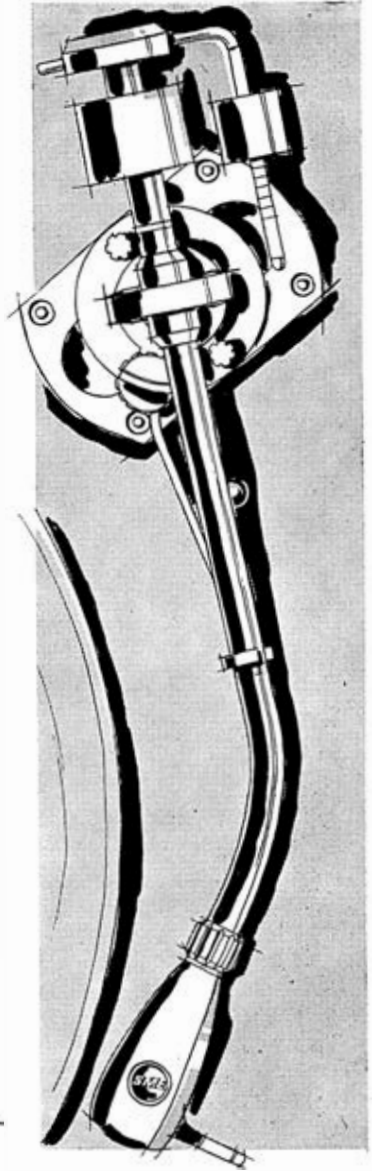

Manufactured by **SME LIMITED, STEYNING, SUSSEX, ENGLAND**

France

Innovation, 104, Avenue des Champs Elysées, Paris.

Belgium

Neon N.B., 14, rue Locquenghien, Brussels.

Netherlands

Audium, 160, Singel, Amsterdam C.

Portugal

Acros, Rue Almeida E Sousa 21, Lisbon.

U.S.A.

Electronics of City Line Center, 7644, City Line Avenue, Philadelphia 31, Pa.

South Africa

Recorded Music Specialists (Pty) Ltd., P.O. Box 2203, Durban.

Hong Kong

Universal Trading Co., 326, Prince's Building, Hong Kong.

New Zealand

Westrex Co. New Zealand Ltd., 58, Kent Terrace, Wellington.

Australia

Jomyson Industries Ltd., 400, Kent Street, Sydney.

if
you think
that all brands of
recording tape are alike...

wait
till you
try

irish
BRAND

ferro-sheen

The 5 times better tape



WILMEX · DISTRIBUTORS · LONDON



*Products
of
Experience
and
Leadership*



THE
Monitor
DUAL CONCENTRIC

The Monitor Units, latest in the long line of Tannoy Dual Concentric Loudspeakers, mark another Tannoy achievement.

From the introduction of the first Dual Concentric Loudspeaker, Tannoy have won an established place as the quality standard for faithful reproduction.

The Monitor Units embody all the unique features of the earlier widely acclaimed 12" and 15" Units, but include the revolutionary Magnetic Shunt, and the H.F. Acoustic Balance Cavity, both important contributions to improved quality of reproduction.

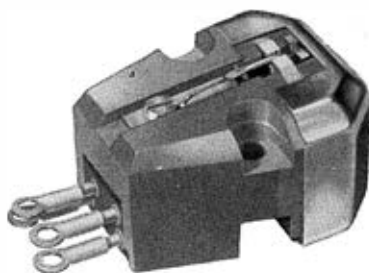

THE
VARI-TWIN Mk II

Compatible Stereo Cartridge

This triumph of Tannoy research provides a magnetic stereo cartridge completely hum-free. Mounting in close proximity to motors and power amplifiers is now a practical proposition. The Vari-Twin Mk II is designed for micro-groove stereophonic discs made to Westrex 45/45 system. It is, however, fully compatible and, with appropriate stylus, monaural discs may be played. It can be mounted in any standard shell or arm suited to its low tracking pressure of 3-4 grms.



Founder Chairman: GUY R. FOUNTAIN

TANNOY PRODUCTS LIMITED WEST NORWOOD LONDON SE27

Tel.: GIPsy Hill 1131

One of the Tannoy Group of Companies

OUTSTANDING ATTRACTIVE PRACTICAL



THE *Mozart*

HIGH FIDELITY STEREO SYSTEM



At Pye, technical excellence is also considered in relation to price and presentation. The system shown centres around the 'Mozart' stereo amplifier (model HFS20) at £35.0.0. With it are two of the new 'Mozart' Minor Loudspeakers (model HF8BS) at 18 gns. The matching FM tuner (model HFT108) is 22 gns. A matching turntable is also available. The cabinet by Dennis & Robinson of Hove is £22.11.0. It is available, like the loudspeakers, in walnut or mahogany veneers.

Send the coupon today for fullest details of Pye High Fidelity Equipment
to PYE LIMITED · HIGH FIDELITY DIVISION · BLUE TOWN · SHEERNESS · KENT

Name.....

Address.....

HF.B



RESLOSOUND LIMITED

for the highest quality performance

DYNAMIC & RIBBON MICROPHONES

IMPEDANCES

DPL	30 ohms	CRL	30/50 ohms
DPM	250 and 600 ohms	CRM	250 and 600 ohms
DPH	30 ohms	CRH	30/50 ohms

and high impedance and high impedance
each complete with 18ft screened cable

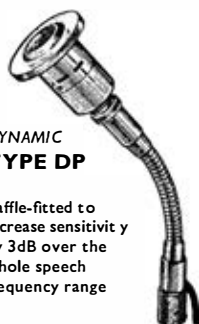

**DYNAMIC
TYPE DP**

Baffle-fitted to increase sensitivity by 3dB over the whole speech frequency range

**RIBBON
TYPE CR**

15dB average front to back discrimination

suppliers to BBC and many sound equipment manufacturers

Chapman



305 Stereo Control Unit Stereo Main Amplifier

The 305 Control Unit affords every facility for high-quality stereo or

single-channel radio, gram or tape reproduction. It accepts direct tape head signals and can reproduce pre-recorded tapes without separate pre-amp.

It can be used with low output magnet or crystal P/U, records stereo and mono tapes and is supplied (£18.18.0) ready for connection with the 305 Main Amplifier.

This instrument (£21.0.0.) gives 8 watts per stereo channel and 16 watts in parallel. FM and AM/FM Tuners similar to the 305 Control Unit are also available.

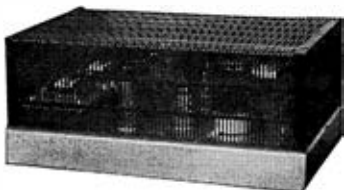

CHAPMAN ULTRASONICS LIMITED

all sales enquiries: 24, Upper Brook Street, Mayfair, London, W.1.
telephone: Hyde Park 2291

Da61BHF

The finest and
largest-selling



electronic kit-sets
in the World

*If you are considering the purchase of
Hi-Fi Equipment
you CANNOT AFFORD to miss reading the
HEATHKIT CATALOGUE
should you wish to have the
best equipment and **SAVE MONEY!***

There is a wide range of equipment to choose from and every model can be built by the absolute beginner, since no previous experience is necessary. The complete but simple step-at-a-time Instruction Manual even teaches you how to solder!



**Whether you
require an Amplifier,
Record Player, Tape Deck,
Speaker System, Radio, or an Equipment Cabinet,**

**★ BE SURE AND SEND NOW FOR
A FREE HEATHKIT CATALOGUE**

FROM

DAYSTROM LTD.

**Dept. H.F.B.
GLOUCESTER**

*From the same publicity house
as HI-FI BOOKS come, monthly*

HI-FI NEWS

Price 2/-

★ First published in June 1956, *HI-FI NEWS* is the world's most authoritative and best informed journal for the enthusiast in all branches of high quality sound reproduction and electronics. From all newsagents, monthly, price 2s. (U.K.), or by direct subscription from the publishers 30s. per annum with index, post paid (U.S.A. \$4.25).



and

the TAPE RECORDER

Price 1/6

★ First published in February 1959, the *TAPE RECORDER* is the magazine for the amateur, the serious experimenter, and the industry as a whole. It covers the complete field of tape and tape recording, including cine sound features. Finely produced and illustrated. Available from all newsagents, monthly, price 1s. 6d. (U.K.), or by direct subscription from the publishers 24s. per annum with index, post paid (U.S.A. \$3.25).

