

XTAL

JUNE

1948

Vol. 16 No. 6

for the

radio amateur

Mr. Grant Barker,
R. R. #3,
Weston, Ont.

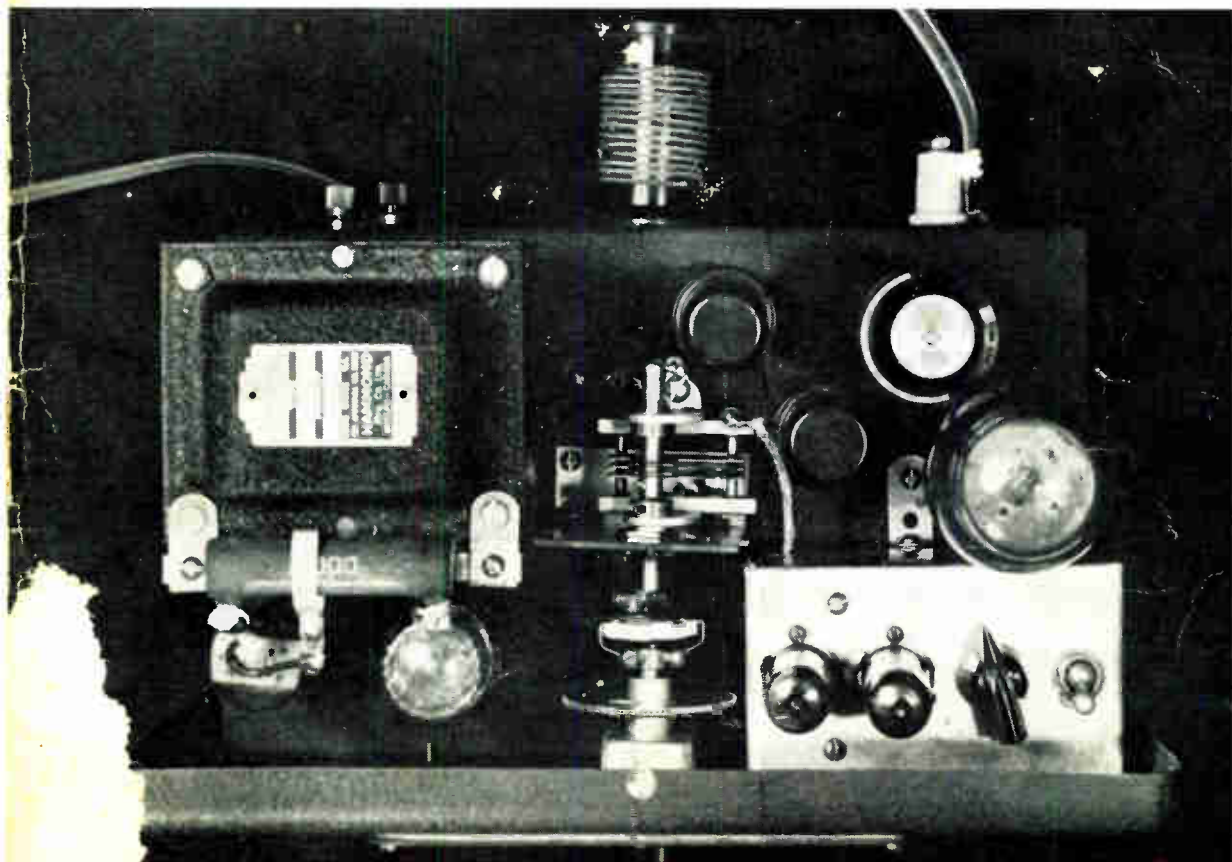

OFFICIAL JOURNAL
THE CANADIAN AMATEUR RADIO OPERATORS' ASSOCIATION
TORONTO, ONTARIO





LEADERSHIP

Hammond Plate Transformers covering a wide range of voltages at currents up to 1000 M.A.D.C. are uniformly superior because of rigid quality control during all stages of manufacture.

Final individual test and inspection insures their conformance to catalogue specifications and the high standard of performance demanded by the Canadian amateur.

BA4M! 90 to 100 OHM twin shielded R. F. Cable—will handle up to 1 KW input—unaffected by rain, sun, sleet or snow—the ideal flexible feeder for that beam. Amateur net .12 per ft plus freight.

Distributed Through Leading Jobbers From Coast To Coast

HAMMOND MANUFACTURING COMPANY

Limited

G U E L P H · O N T A R I O · C A N A D A

GET THE C.E.S. HABIT ... FOR HAM GEAR NOW

WAR SURPLUS TUBES

2X240	VR10535
5AP1	3.00	VR15035
5BP1	3.00	211	5.00
5CP1	3.00	304TH	12.00
5FP7	3.00	801A	1.60
5GP1	3.00	802	3.00
6AB740	803	8.00
6AJ7/6AC740	805	5.00
6AG540	80765
6AK7/6AG740	810	5.00
6AK657	811	1.90
6C445	813	11.00
6J640	814	4.00
12A630	815	2.00
FG27A	5.00	826	1.50
RK3965	837	3.00
RK6055	872A	3.00
EF5035	88465
95565	CK100640
956	1.00	E114835
99140	845	3.40
446A (light house)	2.00	866A95
205180	161965
719340	162540
900330	832	2.85
900430	900630
		830B	4.60

WAR SURPLUS MOTOR with Gear Reducer 40-1 ratio. Shaft speed 95 RPM. Input voltage 12 DC, can also be operated on AC voltages from 12 down to 2.5. This unit can be adapted for beam rotation..... **4.95**

NATIONAL DIALS

ICN	8.00
ACN	4.50
SCN	4.00
MCN	3.60
B	2.70
BM	2.48
N	6.75

Note New Address Below
Telephone MI. 2481 (3 lines)

BOOKS

ARRL Handbook 1948	2.00
ARRL Handbook 1947	1.29
Radio Handbook, 11th Ed.	3.25
Radio Antenna Manual (Coming)	
RCA Receiver Tube Manual40
FM Transmission-Reception	2.10

HAMMOND

Ten Meter Beam, Model 1321	34.50
BA4M Cable, 90 - 100 OHM twin CO-AX, per ft.12
83-2R Two Contact Chassis Type Receptacle	2.38
83-2SP Two Contact Plug	3.10
The above Connectors for use with BA4M and RG57U CO-AX Cable.	

BLILEY CRYSTALS

Type	Your Cost
AX2 80-Meter	3.50
AX2 40-Meter	3.50
SMC100 100-1000 KC	11.25
CF6 455KC	5.85
CCO-2A OSC Less Tube and Crystal	12.95

RME

HF 10-20 Converter, 60 Cycle	116.50
DB22A Pre-Selector, 60 Cycle	99.50

CALL LETTERS

Lapel Pins—Gold or silver back- ground. Letters in Black, Blue, Brown or Red. Brooch or screw fastener	1.25
Plaques—6" x 2" plastic material. Background colour in Black, Brown, Blue, Red, Green, White, or Grey	1.25
Plaques for Receiver Top Mounting, Etc.—Made of Plexi-Glass, size approx. 11" x 3" x 1½"	4.00

CANADIAN ELECTRICAL SUPPLY CO. LTD.

TORONTO — MI. 2481 — 543 Yonge St.
285 Craig St. W. — MONTREAL

B is for Better performance with Bud Condensers



*the difference
will amaze you!*

Here is the highest quality in variable condensers at the lowest cost. BUD condensers are sturdy and efficient. All plates are electro-soldered to the rods on small condensers. When you see the BUD condenser line you are looking at a really complete line. 248 different condensers give assurance that there is one for every need. All condensers are available from your distributor for immediate delivery.

BUY THE BEST — BUY BUD

Visit Bud booth No. 131 at the National A.R.R.L. Convention, Milwaukee, Wisc., Sept. 4-6, 1948.

Canadian Representative

HEFCO AGENCIES

1382 Queen St. East, Toronto, Canada



The mark of perfection

BUD RADIO INC.

CLEVELAND 3, OHIO

SAVE MONEY!

We list a few for price comparison.



LC-1644—Tiny-Mite Tuning Condenser. 50 mmfd. capacity. Air gap .017"..... \$1.70

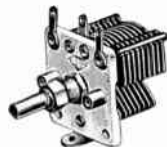

CE-2021—"CE" Midget Condenser. 35 mmfd. .030" spacing..... \$1.56



MC-1855 — Double Bearing, Semi-Circular Plate. Capacity 100 mmfd. Air gap .024"..... \$2.21

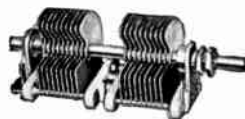

MC-911A — Double Gang Midget, Mid-Line Plate Type. For either chassis or panel mounting. 100 mmfd. .024" air gap..... \$3.75

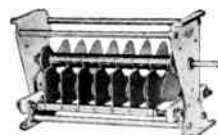

CC-1805 — Single Section Giant Condenser, precision built. 150 mmfd. .500" air gap..... \$39.64

1 This coupon is the key to the new
1 lower prices in BUD Products.
1 BUD RADIO, INC.,
1 2122 East 55th St., Cleveland 3, Ohio.
1 Send copy of NEW BUD CATALOG.
1 Name

1 Address

1 City State

Peace of Mind



If halos were in style . . . PR owners would be wearing them . . . because the happiness and serenity of T9X has no substitute. With PR Precision CRYSTALS controlling your rig frequency worries take a fast and permanent QSB. You can put your worrier to work on more important problems than "where am I?" For instance . . . the old grey matter can get busy on that super-

duper dream beam you have been planning all these years. Yes — PRs give you peace of mind. For better accuracy, stability, activity and output . . . PICK PRs! They're UNCONDITIONALLY GUARANTEED . . . at your jobber! USE PR and KNOW WHERE YOU ARE.—Petersen Radio Company, Inc., 2800 W. Broadway, Council Bluffs, Iowa. (Telephone: 2760)



PR Precision CRYSTALS



SINCE 1934

<p>10 METERS PR Type Z-5.</p>	<p>Harmonic oscillator. Ideal for "straight through" mobile operation. High activity. Heavy drive without damage in our special circuit</p>
<p>20 METERS PR Type Z-3.</p>	<p>Harmonic oscillator. Low drift. High activity. Can be keyed in most circuits. High power output. Just as stable as fundamental oscillators</p>
<p>40 & 80 METERS PR Type Z-2.</p>	<p>Rugged, low drift fundamental oscillators. High activity and power output with maximum crystal currents. Accurate calibration</p>



GENERAL ELECTRIC

VARIABLE RELUCTANCE PICKUP

● HERE'S EXTRA BUSINESS for your Service Department.

Easy to install...easier to sell...the G-E Variable Reluctance Pickup and the SPX-001 preamplifier give your customers improved reproduction from their treasured recordings. New sales are assured because listening tests prove the new pickup and pre-amp are the best yet.

The sapphire stylus rides like a feather in the record grooves, responds only to lateral motion.

Hundreds of broadcast stations have changed over to the G-E pickup for studio use. Stock is available immediately from your local jobber or nearest C-G-E office.

Take advantage of the widespread public interest in this excellent service item.

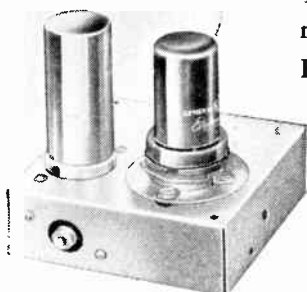

CANADIAN GENERAL ELECTRIC CO LTD

HEAD OFFICE: TORONTO

48-TU-5R



XTAL

[C R Y S T A L]

VOL. X
No. 6



JUNE
1948

Published by
THE CANADIAN AMATEUR RADIO OPERATORS' ASSOCIATION

46 ST. GEORGE ST., TORONTO 5, ONTARIO
TEL. Midway 8235

CONTENTS

	Page
Editorial	6
Radio Romance	7
A Versatile VFO	8
Ve/W Contest Results	10
Canadian Receiving Stations	11
DX News	12
VHF in Canada	13
Regulations for 1948-1949	14
Club Activities	15
National Report	17
Club Directory	21
Introducing Your DR	22
Welcome, OM's	23

STAFF

Editor
F. G. E. Powell, Ve3ZE

DX Editor
R. D. Carter, Ve3QD

VHF Editor
R. G. Coleman, Ve3ANY

Advertising Manager
Don Fairbairn

CAROA

Affiliated with
A.R.R.L. and R.S.G.B.

OFFICERS

President
T. G. E. Powell, Ve3ZE

Vice-President
R. A. R. Macdonald, Ve3APS

Secretary-Treasurer
D. W. Patterson, Ve3BBZ

Executive Secretary
H. A. M. Whyte, Ve3BWY

EXECUTIVE COMMITTEE

The Officers and,
W. H. Anderson, Ve3AAZ
R. D. Carter, Ve3QD
R. G. Coleman, Ve3ANY
D. G. Hall, Ve3TB
A. A. McArthur, Ve3DJ
A. Palmer, Ve3WK
J. V. Perdue, Ve3QK
P. Posnikoff, Ve3BBN
J. Staley, Ve3GR
H. A. M. Whyte, Ve3BWY

DISTRICT REPRESENTATIVES

R. J. Hesler, Ve1KS
F. G. Gribben, Ve2XR
R. C. Hunt, Ve3WX
Les Saul, Ve4FJ
Bill Gordon, Ve5MW
W. R. Savage, Ve6EO
Ernie Savage, Ve7FB
Jack Spall, Ve8AS

CAROA

Authorized as second class mail. Post Office Department, Ottawa.

WE STILL NEED YOUR CO-OPERATION

WE have been greatly encouraged by many letters received recently, in which the writers compliment us on the way in which CAROA is now getting down to business, and producing a better and more balanced XTAL. We greatly appreciate this encouragement, but at the same time we are very conscious of our past and present failures, and realize that there is and always will be room for building and improvement. In short, we never anticipate having enough laurels on which to rest.

It is not our policy either to talk too much about bouquets; kindly criticisms are helpful; angry kicks hurt—and we have received some of these. Some unthinking correspondents have even indicated that they consider that XTAL is Canada's answer to QST. This is not so, nor ever will be so. The 5,000-odd amateurs in Canada need their own organization which will publish XTAL to give them news and views which are essentially of a Canadian flavor, and are of primary interests to Ve's 1 to 8.

Some acrimonious comments have been made about the lack of technical articles. The executive of CAROA cannot be expected to produce of themselves a technical article each month. These should come from among the body of Canadian amateurs. Nor do we expect to publish technical articles of a lengthy or of a highly technical nature. It is rather our policy to publish simple constructional articles, remembering that the low-power boys far exceed the fat pocket-book boys. We repeat it is not our intention to publish a highly technical journal, but a publication which will share news and helpful articles with all members of the growing and noisy family of Ve's.

Some have even asked "What do we get out of it?" This surely is a wrong way of looking at things. Should the question not be, "What can we do to help?" The more members we have, the better will XTAL magazine be. So send in your articles, news briefs, suggestions, yes and criticisms, so that together we can create a national association of which we can all be proud. Of course, there are always those who will point to the errors of the past, but we all learn by our mistakes, and may we finally say that he who never makes a mistake never makes anything?

It is to the future we invite you to look, but in present we invite you to help.

Manitoba Flood Emergency Work

As we go to press Les Saul, Ve4FJ, Manitoba D.R., sends us the story of emergency work carried out by the Winnipeg Amateur Radio Club during the recent flooding in that area.

At an emergency meeting of the Winnipeg Amateur Radio Club, Friday, Apr. 23, Ve4RO, owned and operated by George Behrends, was chosen as main watch-keeping station for the duration of the Emerson flood emergency. Two radio amateurs, Don Taylor (Ve4QV) and Alex Parmley (Ve4AD) left Friday night for Emerson, equipped with a 250 watt station and a police radio car to assist the Red Cross in communicating with the base in Winnipeg and also to aid in the passing of any other information required by public services.

Radio watch was set at Ve4RO at 8 a.m., Saturday and was kept on a 24-hour basis with operators Len Cuff (Ve4LC), 286 Rutland St.; George Behrends, Joe Knowles (Ve4JK), Bob Lamb (Ve4BO) and Mervin Curley, (Ve4SS) operating on shifts to handle all traffic from the disaster area. Arthur Morley (Ve4AM), Section Communications Manager for Manitoba, is acting as monitoring station in St. Vital.

Radio station CJOB turned over part of the top floor of the Lindsay building, equipped with a 60-foot mast, to the Winnipeg radio amateurs, where another 250 watt station was established. To aid in any communications work necessitated by emergency flood conditions occurring in the Winnipeg area a four-man co-ordinating committee was set up, consisting of Rudy Peters (Ve4RP), Hugh Dollard (Ve4MC), George Smith (Ve4SJ), and Ben Tylko (Ve4SH). All communication was handled on the 80 meter band.

The meeting voted \$100 for the use of the executive in emergency organization. This is an example of outstanding amateur participation.

The army and police forces in the area offered radio equipment to assist in the arrangements set up by the W.A.R.C. and a special guest from Poland, SP1QT, gave a talk on flood and other emergency work carried out by amateurs in his homeland.

Hats off to the Winnipeg Amateur Radio Club for their readiness and ability to cope with a dangerous situation!

THE COVER PICTURE

shows a top view of the versatile VFO described on page 8. The article will tell you all about it.

RADIO ROMANCE

By Eric R. Adams

A GUY with a name like Gilbert Keefer has a fair chance of turning out to be a character that I wouldn't like. Which is exactly what happens on a certain evening in June when I encounter him at the residence of Dahlia O'Reilly who, if not my girl friend, is not exactly a stranger either. Dahlia has blond hair, nice gray eyes and a chassis that's even more beautiful than the chrome-plated one I just bought for a new speech amplifier. Now and again my enthusiastic lips give with faint cries of "Hubba, hubba!" as I gaze at her, and at such times it is not hard to wish that I had a somewhat better job than junior radio serviceman at Garfinkle's Sales and Service. If this were the case I might feel more than casually inclined to further my relationship with Miss O'Reilly.

On the evening in question I have no sooner stepped through the door of her apartment than I get the idea that she is not exactly overjoyed at seeing me. Then I spot a flashily dressed guy sitting across the room and next thing I know Dahlia is saying to me, "Joe, I want you to meet Mr. Kilbert Keefer."

Keefer gets slowly up and shakes my hand as if he's doing me a big favor and while he's looking me over I hear Dahlia saying, "Joe is in the radio business too."

"Oh, indeed," says Keefer. He pastes a pleasant look on his face and says "I presume you are a broadcast engineer." The tone of his voice tells me he presumes no such thing.

I feel myself getting red and while I'm fumbling around for words Dahlia tells him about my job at Garfinkle's and then she says to me, "Mr. Keefer is studying radio engineering at the Jones Institute. He's in his final year and he's already been hired to go to South America when he graduates." She is standing a lot nearer to him than she is to me and this I don't like.

"Mr. Keefer has been working very hard and studying to advance himself," Dahlia says to me. She gives him a fond look and Keefer says, "Say, don't you think it's time you called me Gilbert? I've known you now for two whole hours."

Dahlia giggles and moves a bit closer and the conversation continues without me for a moment or two. During this time I can't help thinking how I might have been on the way to being an engineer myself if I hadn't had to quit school to go to work. Anyway, Dahlia snaps out of it after a while and we all get

talking and I learn that Gilbert Keefer comes from out west and he met Dahlia through some babe who'd been out that way on a holiday and who was a mutual friend of both of them.

Thinking things over and trying to be fair about it, I have to admit that a guy can't blame Dahlia for getting interested in someone who seems to be doing all right. At the same time I can't help wondering why it has to be a guy like Keefer, and the more I think of it the madder I get. I also don't like the way she is talking about radio all the time to him. With me I don't dare open my mouth on the subject before she shuts it for me.

Right now, for example, Keefer is giving her a long-winded description of some station they run at the Institute. I gather that it is quite a rig, licensed as a sort of privately owned broadcast station with a power of five kilowatts.

"What's so wonderful," I says, "about that." It is kind of a dumb thing to say, I suppose, but you know how guys like Keefer make you feel, especially when they are doing too good with someone you'd like to rate as your girl.

"Why, Joe!" says Dahlia sharply. "I really think you're jealous."

Keefer looks at me and Dahlia says by way of explanation, "Joe runs one of those little amateur radio stations." She sniffs a bit and says, "When conditions on the air aren't any good he comes over to see me."

"Aw, now Dahlia," I start to say, but Keefer interrupts and starts asking me questions about the rig. "Ha, ha," he says, "you see I've never had much chance to study these small transmitters."

I feel like kicking him in the teeth, but I start out to tell him all about the rig. "It's got a single 807 in the final," I tell him, "and I run about 25 watts."

"Ha, ha," says Keefer, "I'm sure that must be very nice, Joe."

He's treating me like a five-year-old except that he doesn't try to pat my head.

"It is very nice," I tell him, "which is a lot more than I'd want to say about your personality."

"Ha, ha," says Keefer again. "You've got a great sense of humor, Joe." He's one of those guys that nothing seems to disturb.

Conversation sinks into a lull for a few moments and I realize that things are a bit awkward. We've both dropped in on Dahlia unannounced and while I mightn't mind leaving

QSY to page 24

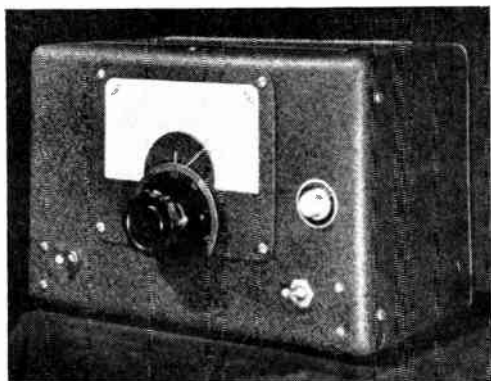

A Versatile VFO

(Plus Optional NBFM)

By D. G. Hall, Ve3TB*

No words need be wasted on the important part the VFO is playing today in many amateur stations. With the crowded amateur bands and the highly developed dx technique, a VFO might well be considered a "must."

And so to those of you chaps who are contemplating adding a VFO to your rig, or to any that are not satisfied with your present shifter, we hope that this small, simple and inexpensive VFO will be just what you are looking for.

The author takes no credit for originality of circuit design. Many VFO circuits were studied and a good point here and there taken from each circuit in an attempt to consolidate all these points in the "ideal" VFO.

The final result, as you see by the photographs, has the following good points, and is completely self-contained.

- (1) Built-in voltage regulated power supply.
- (2) Single dial tuning.
- (3) Oscillator cathode coil plugs in at rear—away from heat for stability.
- (4) Plug-in coil permits additional coils being wound for proper bandspread on each band.
- (5) Slug-tuned output—providing high output over a wide frequency range.
- (6) Output on 80-40-20 meters.
- (7) Added NBFM.
- (8) NBFM unit uses VFO power supply.
- (9) A complete fleapower phone—CW emergency transmitter.

There you have it, fellows. If that doesn't cover all the good points—add your own, or delete any to suit your taste!

Construction

While the cover photograph and diagram will probably be sufficient to follow, a few points might be added to simplify the building. The cabinet is a Hammond No. 1403D (the hinged lid type). The top view chassis layout is as follows: Left rear power transformer Hammond type No. 272, left front the rectifier (5Y3GT), next to it the voltage regulator;

centre is the bandspread frequency selection condenser (C1); to its rear is the oscillator (6SK7), and to its right is the isolating tube (6AB7). At the rear right is the slug-tuned output coil (discussed later), and centre right, the output tube (6L6). At the right front is the added NBFM (optional).

At this point it might be added that the NBFM unit is definitely not the author's brain child. All credit goes to its designer, W1ONG, and we would refer you to page 34 of February QST for full details.

Whether or not the builder intends to add this unit, it is strongly advisable that space be left for it should you get the NBFM urge at a later date.

In this particular layout, the size of it had to be cut down even smaller than the original circuit in QST—if possible. Our measurements are 4" x 2 1/4". Just imagine, fellows! A complete modulator in that space and at a cost of around five dollars—and its results are more than gratifying. Well, enough chatter on W1ONG's reactance modulator and back to the VFO.

You'll be wondering where the power supply choke is located. It is one we resurrected from the junk box and it is mounted under the chassis. The front panel contains the main tuning dial (yet to be calibrated!), lower left switch is the 110V on-off control SW1, and lower right is the switch in the B negative for VFO alone on and off. This switch cannot be emphasized too greatly, as you can readily see it enables the operator to tune to a desired frequency without swishing up or down the band. Don't be a "band-swisher"! In parallel with the switch, at the rear, are extension posts to be used in conjunction with a relay in the transmitter to avoid separate switching of the VFO for transmitting.

Directly above SW2 is the microphone socket. It is planned at a later date to add a closed circuit jack above SW1 for VFO keying if desired. The rear of the chassis contains the 110V cord, beside it the extension posts for relay, the oscillator cathode coil, and the feed-through insulator for connection to transmitter.

It will be noted from the diagram that plenty of by-passing, such as 110V line, recti-

*c/o HQ.

fier filaments, etc., was used to ensure a clean signal. Also it will be noted that plate and grid decoupling was used in the 6AB7 and 6L6 stages to completely isolate them from the oscillator. The oscillator coil used at present is 80 meters, but an equally good note was obtained with a 40-meter coil. This is contrary to many designs, but it worked very stably here. This permits output on 80, 40 or 20 meters, as the slug-tuned 6L6 will act as a straight amplifier or a doubler.

The slug-tuned coil is of the "homebrew" type, the form being 1 1/4" and the slug being made from a solid brass-round measuring 7/8" wide, 5/8" deep, drilled and tapped for an 8-32 brass bolt 2 1/2" long which is mounted in the centre of the coil by drilling through the centre bottom of the coil form.

For general wiring, it is recommended that busbar wire be used, with short, tight, insulated leads. This will be rewarded in the end by stability of the VFO.

There is no need for further special mention in construction, as the circuit is simple and straight forward.

Operation

After checking your wiring and correcting

your mistakes, you will find that a pleasing (?) note can be heard in your receiver. Set your receiver on the low end of the desired band, and with your VFO bandspread condenser at 0° adjust the bandset condenser for beat note in your receiver. Now the bandspread condenser is ready for tuning to the desired frequency¹. Probably some coil experimenting will be required for the desired amount of bandspread. Couple the VFO to the oscillator grid circuit of the transmitter. It is recommended this be done through 300-ohm line. In most oscillators the coupling line can be plugged directly into the crystal socket (grid and ground). If a triet is used refer to your handbook re shorting of the cathode coil.

A decided dip comparable to that of your crystal will be noticed in your transmitter oscillator stage as you swing through resonance in the oscillator tank circuit. Tune your transmitter and sit down to a night of bouncing hither and thither on your favourite band! An excellent output was found with this VFO. It has not been measured, but it is estimated to be in the vicinity of five watts.

QSY to page 20

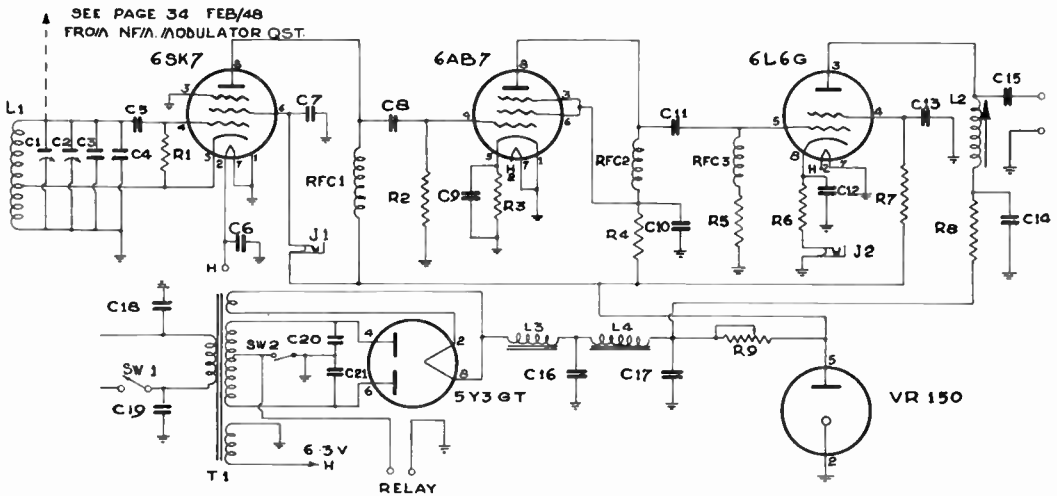

CIRCUIT DIAGRAM OF THE VFO

- | | |
|-------------------------------------|--|
| C1 - 35 MFD. VARIABLE | RFC 1,2,3 - 2.5 MH. RF CHOKE |
| C2 - 100 " SCREW DRIVER ADJ. | J1 - CLOSED CIR. JACK FOR BREAK IN KEYING |
| C3 - 100 " ZERO TEMP. | J2 - " " " ALTERNATE KEYING POSITION |
| C4 - 220 " " " " | L1 - 80M - 13 TURNS SPACED 1/4". TAPPED AT 3 TURNS |
| C5,8,11,15 - 100 MFD. MICA | 40M - 6 TURNS SPACED 1/4" TAPPED AT 2 TURNS |
| C6,7,9,10,12,13,14 - .01 MFD. PAPER | L2 - SLUG TUNED - SEE TEXT. 80M - 42 TURNS C.W. |
| R1 - 50 000 OHMS | 40M - 20 TURNS CLOSE WOUND. 20M - 11 TURNS C.W. |
| R2 - 150 000 " | ALL COILS WOUND WITH NO. 22 D.C.C ON 1/4" FORMS |
| R3 - 500 " | POWER SUPPLY T1 - HA/MOND TYPE 272 |
| R4 - 1 500 " | C16,17 - 8 MFD. |
| R5 - 100 000 " | L3,4 - 30 HENRY (DUAL) |
| R6 - 500 " | R9 - 5000 OHMS 20W. WITH SLIDER |
| R7 - 1 500 " | SW1,2 - SINGLE POLE |
| R8 - 1 500 OHMS | C18,19 - .05 MFD PAPER C20,21 - .005 MFD MICA |

VE-W CONTEST RESULTS

Ve7HC High Scorer

W1BFT Winner of M.A.R.C. Trophy

Leading with highest score in the 1948 Ve/W Contest was Ve7HC with 42,691 points, covering 274 contacts in 53 U.S.A. sections, with a power input of 95 watts. The Montreal Amateur Radio Club trophy holder for 1948 is W1BFT with a total of 15,960 points, who made 95 contacts in seven Canadian sections, with a power input of 100 watts on the 28 Mc, 14 Mc, 7 Mc and 3.5 Mc bands.

In the summary of the winners you will see that W2WC gave W1BFT a very close race—better luck next time, Frank. A lot of the boys may find their scores higher than they expected, since numerous U.S. entrants forgot to multiply their scores by the multiplier of eight, and some forgot to multiply by number of sections worked.

There were not nearly as many active stations in the contest this year—only 124 logs were submitted by closing date.

In reading over the comments, most of the boys had a good time, although some complained of the poor activity in the Ve stations.

Some stations were only on for a short period and kindly submitted their logs for checking purposes only. Our thanks for this assistance.

It is regretted that announcement of the contest was delayed due to publication difficulties. Under our new system, it is hoped that this will never happen again.

Space limitations unfortunately do not allow us to print the many letters received with logs, telling of experiences, trials and tribulations, etc.

Now for scores:

CANADA

Maritime

	Pts.	Contacts	Sect's	P'w'r
Ve1TR	20,580	173	40	B
Ve1IM	16,036	106	38	C
Ve1PA	12,022	115	35	B
Ve1EY	10,908	102	36	B
Ve1CU	5,478	84	33	C
Ve1MW	3,069	93	11	B
Ve1HG	2,838	65	22	A

Quebec

Ve2MO	13,804	102	34	C
Ve2OL	10,908	101	36	B
Ve2XR	9,338	80	29	C
Ve2FG	4,800	50	24	C
Ve2RH	3,060	51	30	A
Ve2HI	2,832	60	24	A
Ve2GE	1,071	31	17	A
Ve2ABT	780	39	10	C

Ontario

Ve3GT	37,232	182	52	C
Ve3AGX	27,905	177	53	B
Ve3AEM	31,084	201	53	B
Ve3EK	20,048	149	45	B
Ve3MI	18,765	142	45	B
Ve3ACB	11,880	83	36	C
Ve3BBR	10,914	108	34	B
Ve3BPE	8,320	69	32	C
Ve3ATR	3,600	50	24	B
Ve3BQL	2,632	47	28	A
Ve3DU	2,142	34	21	B
Ve3BOC	1,148	26	15	B
Ve3BNX	825	25	11	B

Manitoba

Ve4DG	15,792	96	42	C
Ve4NX	3,627	50	26	B
Ve4DE	324	12	9	B

Saskatchewan

Ve5QZ	29,400	152	49	C
Ve5DW	1,680	30	20	B

Alberta

Ve6EO	26,460	189	49	B
Ve6CU	10,101	94	37	B
Ve6EE	6,864	88	39	A

British Columbia

Ve7HC	42,691	274	53	B
Ve7HG	2,838	43	22	B
Ve7ABQ	1,575	25	21	B
Ve7CU	1,566	29	18	B

UNITED STATES

Atlantic Division

Eastern Penn.	W3AIZ	40	7	6,720	B
Md., Del., D.C.	W3LVJ	33	7	7,392	C
S. New Jersey	W2QEU	42	6	8,064	C
W. New York	W2KEL	46	7	5,152	A
Western Penna.	W3GJY	53	6	10,176	A

Central Division

Illinois	W9NII	79	7	13,104	B
Indiana	W9HUV	30	7	3,192	A
Wisconsin	W9STE	41	7	8,960	C

Dakota Division

N. Dakota	W0HKM	33	7	5,544	B
S. Dakota	W0PHR	48	7	5,320	A
Minnesota	No Entry				

Delta Division

Arkansas	No Entry				
Louisiana	No Entry				
Mississippi	No Entry				
Tennessee	No Entry				

Great Lakes Division				
Kentucky	No Entry			
Michigan	W8SCW	23	3	1,104 A
Ohio	W8YGR	47	6	6,768 B
Hudson Division				
E. New York	No Entry			
N.Y.C. & L.I.	W2WC	80	8	15,072 B
N. New Jersey	W2NIY	9	3	648 B
Midwest Division				
Iowa	WøCFB	85	7	13,860 B
Kansas	No Entry			
Missouri	No Entry			
Nebraska	WøRQK	5	2	240 B
New England Division				
Connecticut	W1VG	24	7	3,948 B
Maine	W1GKJ	45	7	5,040 A
Eastern Mass.	W1AWX	56	7	6,216 A
Western Mass.	No Entry			
New Hampshire	W1BFT	95	7	15,960 B
Rhode Island	W1CJH	42	7	7,056 B
Vermont	No Entry			
Northwestern Division				
Alaska	No Entry			
Idaho	No Entry			
Montana	W7EWR	23	6	3,168 B
Oregon	W7GPP	41	8	5,120 A
Washington	No Entry			
Pacific Division				
Hawaii	No Entry			
Nevada	W7KEV	40	7	4,480 A
S. Clara Valley	W6MLY	54	8	10,176 B
East Bay	W6IPH	42	7	4,704 A
San Francisco	W6MHF	53	8	13,568 C
Sacramento V'l'y	No Entry			
Philippines	No Entry			
San Joaquin V'l'y	No Entry			
Roanoke Division				
North Carolina	No Entry			
South Carolina	No Entry			
Virginia	W4IPC	32	7	5,376 B
West Virginia	No Entry			
Rocky Mountain Division				
Colorado	No Entry			
Utah-Wyoming	W7DLR	2	2	64 A
Southeastern Division				
Alabama	W4CYC	73	8	9,344 A
Eastern Florida	No Entry			
Western Florida	No Entry			
Georgia	W4MCM	26	5	2,000 A
West Indies	No Entry			
Southwestern Division				
Los Angeles	W6GHU	20	8	2,560 A
Arizona	W7JPY	18	7	2,016 A
San Diego	W6MI	30	7	5,040 B
West Gulf Division				
Northern Texas	W5JD	27	7	4,536 B
Oklahoma	W5LW	56	8	7,168 A
Southern Texas	W5LGG	49	8	9,408 B

CANADIAN RECEIVING STATIONS

We are pleased to announce the issue of the first C.R.S. numbers to successful applicants. The list is appended at the end of this column. May we repeat that the aims and objects of this listeners' section is to encourage genuine SWL's to get the best out of their hobby, and to help them graduate to a full ticket.

It is obvious that all successful C.R.S. should get down to the subject of learning the Morse code as soon as possible, and if the demand is great enough we propose calling for volunteers to give slow Morse practice transmissions in various centres through the Dominion.

Please send your choicest dx reception to Ve3QD, and remember that dx is a relative term.

C.R.S.-3 (Toronto) is a very keen listener, using a six-tube home-built superhet, and since August, 1946, has worked 79 countries on phone, and had 32 confirmed.

C.R.S.-1 (Toronto) is another keen listener, and has been combing the short waves for two years. C.R.S.-2 (Montreal) is using a S-38, and an eight-tube superhet built by DR, Ve2XR. He has 25 states and 18 countries confirmed. C.R.S.-4 (Gravenhurst) became interested in amateur radio in 1938, when he was 12 years of age, and is digging in trying to learn the code. He uses a No. 9 Marconi 3 receiver. Our first applicant from across the line is W. C. Shay of San Francisco who dubs himself "The Ham Reporter."

It has been suggested to us that we run a regular column on the activities of the C.R.S. and U.S.R.S. members of this association. If any SWL member of our organization would like to volunteer for this small labor, would they please communicate with HQ.

WAVE CERTIFICATES

We are glad to announce that the following have been granted WAVE certificates:

13—G. N. Tipton, WøCFB, Ottomwa, Iowa.

14—W. W. Simpson, W8KPL, Washington, Michigan.

15—Harold E. Moats, W8UDR, Chagrin Falls, Ohio.

16—Murel M. Ballard, W8SDR, Battle Creek, Michigan.

Note: Power Column—A — over 100 watts
B — 30 to 100 watts
C — under 30 watts

Other logs submitted after the closing date were: W1LHE, W9LVR, Ve3AZZ, W7PUM, W7DIS, W4KVX.

DX NEWS OF THE MONTH

R. D. Carter Ve3QD

Now that the annual dx contest and the B.E.R.U. are over it would appear that a goodly percentage of the dx men have closed up their stations for the summer, as reports for this month are sadly lacking, and if there isn't much of interest to report this month don't blame me, as I can only write what I'm given or told about. Anyway, the editor will be happy as he's always trying to find space for something or other.

The really big news of the month is from the boys who have added Zone 23 to their totals. C8YR is the lad who made this possible for Ve7HC, Ve4RO, Ve1SK and Ve6FK. Nice going, gang, and even though you have told me how and why, I still haven't heard him yet. No, it's not the receiver; it's just that he won't break through here the time of day I can operate. Joking aside, though, if any of you want him, he comes through around 9 to 10 a.m. EST. and apparently has VFO, as each one worked him on a different frequency. The note is about T7 and from his card see that he runs 150 watts input. Ve1SX worked him at 2235 GMT with a dipole running north and south, which is really something. 589 he got as a report. Cards have come through already to verify, so perhaps some of you soon will be WAZ. We referred to HL last month as Manchuria in error, and this should have been Korea. Ve3BHX is now in his new QTH and as soon as the painting is done promises to burst forth again. He got MI3ZJ, MD5KW, VQ4KTH, as well as some other nice ones in the B.E.R.U. Les is building a small one-watt portable for his vacation, and if any of you hear him on 40 give him a buzz. He worked three stations in the New York area all with 569 reports, so it works. Ve7EH sends in a nice report and worked KH6NE, XF1A, ZL1HM and ZL2MR on 80 meters. Nice going, OM. Ve3IJ is still in business and is anxiously waiting for a few more cards for dxcc application. Harry worked SV1RX, SV1RX, VS6CB, VS6AE, F8NE (Corsica), VK9GW, ZC1CL and KM6AH along with others for a nice month. ZC1CL is ex-MD1D and may be QSL'd via R.A.F., Amman, Transjordan. Ve1EA worked DA1CG, SM7JP, SM5DZ on 80, VQ5JTW, Ze2JZ, ZS6CT, ZS2A, ZB1AI, VP4TO and XAFQ (Truete) on 40, ending with UAKOA on 20, and says "not much doing this month." We'd say OK, Clarry. Ve1AQ got home for week-ends in April and got the key oiled up for four new countries—HA4EA, UD6AG, UC2 and VP6. Don is house-hunting in Montreal, so if any of you Ve2's know of a nice place there let him know. A couple of acres with a shack would do, but don't think the xyl would go for it. Ve2WW was a busy, busy man in the B.E.R.U. and had 367 QSO's in 53 hours on the air. Don has a nice setup in Montreal and has the station outside the city on a farm and has three V beams with legs 209 feet long which gives him general coverage and excellent re-

sults on all bands. It's not so hot, he reports, though on receiving, as it builds up the unwanted sigs at the same time the wanted ones come through. A choice one worked was FO8AA and C1AN for good measure. VO6EP says the old zepp isn't doing so well and is busy building a tower for a rotary. However, he still manages to get out and added LZ1BG and HE1EO for a couple of good ones. Ham Whyte makes the honour roll this month after only 1½ months on the air here and at the rate he's going will soon be up top once more. Some of the best for him were KG6BV, YR51, SV1RX, plus 150 QSO's in the B.E.R.U. Ve5AQ reports via his xyl, Ve5CD, and lists J9ACA, CT1IP, ZB2A, VQ4GWB with others for a PW total of 48. All with 60 watts. How about 5CD? Doesn't the OM let you in on any of the dx? Ve6FK has been adding to his total and the new ones were VQ3HJP, ZE2JU, VS4WL, PK6XA, VS6AE, EA1A, KM6AH, VS2CB and used the fone for CP1AS and ZM6AF. Don adds as a footnote "also zone 23, C8YR." Such modesty. Brag, boy, brag—it's worth it. Bert Knowles, our genial QSL manager in Ontario, keeps plugging away with the 807 and now has 57 countries confirmed. To give you an idea of the dx being worked, Bert says he handled 2149 QSL's in April. Ve3ACS is a new one on the roll and worked his 100 countries with a single 807 and 50 watts. Our congratulations, Bert. Best ones lately were OY3IGO and UD6BM, as well as WAC in April. Ve1NE reports condx poor for April but still worked 30 countries, VS9AN, MI3, UC2, UO5 and ZD1 were the best. Ve4RO has been busy handling traffic on 80 for the R.C.M.P. from Emerson, which is about 70 miles south of Winnipeg. Four operators besides George kept the station on the air 24 hours a day until the emergency was over. FB, gang, and it proves that dx men can come through in the pinch.

Sorry the column is so short this month, but that's all that's come in. By the time you read this all who have written me to date will have received sets of zone and countries lists with a covering letter explaining the purpose. These were furnished by "CQ" as a courtesy to us and are well worth having. Drop me a card if you wish sets and they will reach you pronto. To Herb Becker go our thanks in arranging this on our behalf.

DX PW Totals

Ve3QD	162	Ve3AVA	100	Ve6AO	64
Ve4RO	159	Ve3ACS	100	Ve1NE	64
Ve7HC	151	VO6EP	100	Ve3TB	62
Ve3IJ	122	Ve6FK	93	Ve4RP	55
Ve1EA	120	Ve1AQ	83	Ve8AS	53
Ve2WW	108	Ve7EH	77	Ve3BHX	53
Ve3AAZ	102	Ve3BBZ	72	Ve3BWY	51
Ve1PQ	102	Ve3QB	65		

QSY to page 20

VHF IN CANADA

Conducted by GORDON COLEMAN, VE3ANY

As we go to press, there have already been five dx openings on the 50 Mc band. The spring-summer season has started and it looks as if the hunting is going to be good! Probably one of the most exciting things about this yearly return of dx to six meters, is the return of old friends and the renewing of acquaintances with the boys across the border. Several of the newer stations on six have had that first thrill that comes of hearing stations from hundreds of miles away come pounding through on a band where usually only local signals are heard.

However, our enthusiasm has been dampened slightly by the lack of response from across Canada to the CAROA VHF Marathon. This feature has been completely ignored by all but three VHF'ers. This was to have been no gruelling SS contest, no week-end shinuzzle where it was every man for himself and the devil take the hindmost. Instead it was intended as a running commentary on the activity on all the VHF bands in all parts of Canada. It was published in February's XTAL, started on March 1, first reports were to have been in my hands by April 5, and reports were to have followed at monthly intervals thereafter. That's all! The whole business, number of stations worked in the month, which bands they were worked on, and the total claimed score, could have been put on the back of a 3-cent post card. It is now May 10 and only Ve3BBW, 30J and 3AID have sent in reports.

By the time this reaches most of you, the A.R.R.L. Annual Field Day will either be well under way, or just a few days away. We wish all VHF'ers all the luck in the world with their equipment and contacts during this event. We have heard of several clubs that plan quite an extensive array of VHF equipment for field day. We have heard also of some clubs that are not seriously entertaining the use of any VHF equipment. It is too bad that some club executives fail to realize the value of field day in respect to VHF. The field day is an emergency trial and by far the greatest amount of emergency work is done on frequencies above 50 Mc. VHF'ers attached to any field day groups could do us a great service by writing us a short resumé of any VHF work done during the field day by their group, giving the names and calls of participants, frequencies used, equipment and antennas, and the scores attained by these groups. We would be pleased also to have any pictures that you might like to send us. CAROA's finances are gradually picking up and it may not be long before we can once again "splurge" with pictures.

And now for the 50 Mc dx situation.

On April 20, at 8 p.m., six meter stations in the Belleville, Ont., group began hearing their first aurora skip, when W9PK, W9UZL, W8GTT and W8GYD were picked up on CW. No contacts were made, as there was no provision for CW operation at Belleville.

On April 22, at 11.30 p.m., a strong aurora blanket was observed by some Toronto stations and signals began to come in from across the border. Worked by Ve3APF was W9PK and by Ve3ANY were W2AMJ, W2BYM and W9PK. Signals approached S7, but of course were unreadable on phone.

On May 6, at 11.30 a.m., the first E layer opening resulted in Ve3ANY working W5ALG. This was the third opening for the boys down Texas way.

On May 8, at 12 noon, the six meter band again opened up to the Ve3 district. This time the Belleville as well as Toronto district came in for their share of dx. Three Wø's were worked by Ve3AJS, and Ve3ADJ and Ve3AAJ each worked one Wø at about 1.20 p.m. At 12.15, Ve3ANY worked WøCJS and at 12.50 Ve3APV worked WøUSI. Heard in both Belleville and Toronto areas were WøCJS, WøYSJ, WøUSI, WøBJV and WøDZM. While it lasted, the signals were S9 with rapid QSB. This opening lasted until about 1.45 p.m.

On May 9, at 11.35 a.m., W4NY was heard S9 working W2RLV. After he signed W4NY worked Ve3AGB, Ve3KM, Ve3ANY and Ve3DJ. W4GJO, W4EID and W4UN came through and continued to work numerous Ve3's and W8's and W2's until about 1.30 p.m. when the band closed. So many Ve3's were present from Toronto, Hamilton, Scarborough, Port Credit, Jordan Station and Lakeview, that QSO's must remain unrecorded until reports are forwarded. In on this opening were Ve3's, ANY, AGB, ATB, KM, APV, SB, DJ, AZC, AEZ, ARV, AXT and AVW.

With the starting of dx, we should be able to resume the VHF DX Derby. Please report all dx worked on any band, and if possible, appoint a reporter from amongst your group. We want to know who you work, when you worked the stations, and at what distance. We sincerely hope that WAS will be made by some station on six meters this year. The Canadians have as good a chance of doing this as the American stations, for when the dx comes through, power does not seem to matter much, and it cannot be said that our fellow VHF'ers to the south have any advantage. Also there are some dx distance records to be broken. A glance at the dx records here posted, and a comparison with those current in QST will show you how far behind the W's we in Canada are. What is wrong? Lack of genuine interest! I always thought that we in Canada were looked upon as the pioneer race. What do you think?

Canadian VHF Dx Records

(As of Feb. 1, 1948)

50-54 Mc—Ve7VY, W2PWP, 2,500 miles—
July 27, 1947.

144-148 Mc—Ve1QZ, W1OSQ, 500 miles—
Aug. 27, 1947.

QSY to page 20

Regulations for 1948-49

For the benefit of hams whose license renewals are not yet received, we publish conditions of operation for 1948-49.

The license, which authorizes transmission and reception only on frequencies authorized therein, must be posted in a conspicuous place in the station.

Amateur experimental stations must be so operated as not to interfere with the working of any government or commercial coast, land, ship or aircraft station, or with the reception of broadcasting.

Except as indicated hereunder, the input power to the antenna shall not exceed 500 watts. For purpose of this requirement, the final amplifier shall be considered to be operating with an efficiency of 70 per cent.

Stations with a power input to the final amplifier in excess of 400 watts shall be equipped with meters of a standard manufacture and accuracy for measuring the plate voltage and current to the tube or tubes supplying power to the antenna.

The carrier from a transmitter operating on frequencies below 144 Mc must be suppressed during periods of reception. Except for brief tests and adjustments, which must be identified by the station call sign, the emission of an unmodulated carrier is not permitted on frequencies below 144 Cc.

The direct modulation of an oscillator with a frequency stability less than that obtainable with crystal control is prohibited on frequencies below 144 Mc.

Each call and sign-off shall be made by the holder of a certificate of proficiency in radio of at least amateur grade. Nevertheless, the licensee may permit any person to take part in A3 transmissions provided that he, the licensee, is present and retains physical control of the station.

Power input to the antenna on the 420-450 Mc band must not exceed 50 watts.

Portable Privileges

All licensed amateur experimental stations are authorized to operate on radio transmitting and receiving equipment of a portable nature in the bands allocated to such stations between 28.0-29.7 and 21000-22000 Mc inclusive in a passenger automobile owned by the licensee, or at a temporary location, for communication with any licensed with any licensed amateur experimental station (including the equipment installed at the home address of the portable station), provided the following requirements are complied with:

- (a) When in use the portable equipment shall be designated by the call sign assigned in the station license, followed

by the word "Portable".

- (b) The equipment at both the home station and portable station shall be operated by persons holding Certificates of Proficiency in Radio of at least amateur grade, unless otherwise authorized by the Minister of Reconstruction and Supply.
- (c) The portable equipment shall be available for inspection at the licensed address of the station whenever required by Departmental Radio Inspectors.

Radiotelephone Transmission (A3)

Radiotelephone transmission (A3) may be used in the following frequency bands subject to conditions (a), (b), (c), (d), (e) and (f) indicated:

Amplitude Modulation

- | | |
|--------------------|-------------------------|
| 3.750-4.000 Mc/s | (a), (b), (c), (d), (f) |
| 14.150-14.350 Mc/s | (a), (b), (c), (d), (f) |
| 27.160-27.430 Mc/s | (a), (b), (c), (e), (f) |
| 28.200-29.700 Mc/s | (a), (b), (c), (e), (f) |

Frequency Modulation

- | | |
|--------------------|-------------------------|
| 3.800-4.000 Mc/s | (a), (b), (c), (d), (f) |
| 14.150-14.250 Mc/s | (a), (b), (c), (d), (f) |
| 27.160-27.430 Mc/s | (a), (b), (c), (e), (f) |
| 28.200-29.700 Mc/s | (a), (b), (c), (e), (f) |

- (a) The station shall at all times be equipped with a reliable frequency measuring device and a visual means of indicating over-modulation.
- (b) The transmitter shall be of a type which is crystal controlled or which has a stability and constancy comparable to that of crystal control.
- (c) The modulation system shall be so designed and operated as to ensure intelligible speech, must not in any case exceed 100 per cent and must not disturb the frequency stability of the transmitter. The deviation of the carrier frequency shall not exceed plus or minus 3000 cycles in transmitters employing frequency modulation.
- (d) The licensee shall have been the holder of an amateur experimental station license for at least one year during which period his station shall have been in active operation and provided he passes an examination in advanced radiotelephone theory and operation and a code test of not less than 15 words per minute.
- (e) The licensee shall have been the holder of an amateur experimental station license for at least six months during which period his station shall have been

Concluded on next page

C A R O A CLUB ACTIVITIES

CAROA has been asked many times to publish a club directory, listing the names and addresses of the various clubs and their executive. We feel, as others do, that it would be mutually beneficial to clubs if they could discuss with each other such items as public goodwill campaigns, emergency colordination, code practise classes, membership drives, etc. In this column, each month, there have been many interesting items about which some clubs and individuals would like to get more details. Since CAROA receives letters from club secretaries only, and the various club bulletins, it would save third-party participation in regard to queries, if clubs could correspond directly with each other.

We would have liked to publish a club directory long ago, but our records were, and still are, far from complete. We have records of the full executive of some clubs. For other clubs we possess only the address of the secretary, or that of some member who has been kind enough to write us with some information, or to ask a question. Executives have been listed in this column each month, as they have come to our attention. Space prohibits us from listing complete executives at this time. Such data is on record at CAROA headquarters and can be obtained by writing us for it, or by reviewing past issues of XTAL. However, we feel that we now possess enough information to make up a Club Directory, and this will be found elsewhere in this issue of XTAL.

We urge all clubs and individuals to survey the list, and if errors are present, hasten to correct us. If the listing shows our records to be incomplete, YOU can greatly assist CAROA and the other clubs by informing us of your complete executive. Do this now! We will endeavour to keep our records up to date so that all may benefit.

In this column for March we listed Doug Burrill, editor of the Loyalist City Amateur Radio Club Bulletin, as Ve1FW. Doug's correct call is Ve1FV, and his address is 32 Pitt St., Saint John, New Brunswick.

CAROA would like to hear from amateurs in districts where there is no club activity. By publicizing that information, it may enable us to find out if there is sufficient interest to warrant someone in that area forming a club. One such district is the Niagara Peninsula in

in active operation on frequencies below 29.7 Mc.

- (f) The retransmission of signals from a station with limited telephone privileges, by a station with full telephone privileges, on a restricted band, is prohibited.

NOTE—Licensees desiring authority to use radiotelephony in the above frequency bands must submit application to the nearest District Radio Office.

Southern Ontario. With almost 100 amateurs active on various bands in the cities and towns of Niagara Falls, St. Catharines, Welland, Port Colborne, Grimsby, etc., there appears to be no active club in the whole area. Any amateurs in this district anxious to form a club should get in touch with Tom Bilesko, Ve3AGB, Jordan Station, Ontario, or CAROA.

In response to numerous requests, only two clubs have applied to CAROA for Certificates of Affiliation. We welcome the Loyalist City Amateur Radio Club, Saint John, New Brunswick, with 69% CAROA membership, and the Calgary Amateur Radio Association, Calgary, Alberta, with 70% CAROA membership. May we once again remind clubs that affiliation with CAROA will be certified upon request by any club claiming membership in CAROA of 60% or more of their members.

And now for this month's news.

The St. Thomas Amateur Radio Club, St. Thomas, Ont., now has a membership of twenty. They are directing their efforts at present toward an emergency plan for assistance to communications services in the event of a disaster in the locality. In this work they are working in conjunction with the local Red Cross. They would like to correspond with other clubs who are engaged in similar activity to exchange ideas. The club participated in a recent hobby show held in St. Thomas, and despite QRM from a model railroad, were able to have 35 successful QSO's with W's and Ve's.

At the March 25 meeting of the Calgary Amateur Radio Association, Don Fleming Ve6DK, reported to the club that the code classes which had been held at the Technical School had been completed, and eight of the fifteen original enrollment have now received their certificates of proficiency from the D.O.T. The meeting was addressed by Mr. G. Stevenson, who gave an interesting talk on radio propagation, equipment and methods used during his experience with the Royal Canadian Navy. At the April 30 meeting, which was held in the Film Exchange, plans were discussed for the hamfest, details of which follow: Dates: July 31 and Aug. 1. Place: Harris Sky Room, 6th Street West, Calgary. Price: \$2.50. Program: Saturday: Registration, historical radio display, games and contests, and a demonstration by Bill Allen, an electrical genius, banquet and dancing. Sunday: A tour of Calgary and a drive to Chestermere Lake with boating. All amateurs who are able to attend are cordially invited.

The officers for 1948 of the Collingwood Amateur Radio Club, Vancouver, B.C., are: President, Ed Godinski, 7AKK; vice-president, Jim Summerby, 7ABP; secretary, Gord Clark, 7OJ. Harold Olsen, the past president, and holder of the well-known call Ve7BE, has been promoted to the job of janitor, where is expected to do a good job of cleaning up the mess, if any.

The officers for 1948 of the Vancouver Amateur Radio Club are: President, Bob Frith, 7AKF; vice-president, Bill White; secretary, Don Byrnes; treasurer, Jack Morrow, 7RF; and Ernie Savage, Ve7FB; Jim Higgins, Ve7ABY; Vern Harding and Jack Watts. Radio theory and code classes will be held at the home of Ve7ZV, 4553 W. 12th St., Starting May 5.

The Halifax Amateur Radio Club now has club rooms at the Technical College, and is making rapid plans for the coming A.R.R.L. field day. They have a good site picked out. The club meets on the third Friday of each month and attendance is between 60 and 75 amateurs and SWL's. A news sheet is circulated among the membership one week before each meeting. The officers for 1948 are: President, Oscar Sandoz, 1QZ; vice-president, F. J. Higgins, 1KY; secretary, R. R. Pattison, 1RP; and treasurer, T. G. Baker, 1SF.

The regular monthly meeting of the Kitchener-Waterloo Amateur Radio Club was held April 5 in the new club rooms at the Kitchener Y.M.C.A. Newly elected executive for 1948 are: President, Hugh Watt, 3AHQ; vice-president, Andy McIntosh, 3AOH; secretary-treasurer, Jack Fortune, 3BGD, and technical chairman, Earl Stickney, 3QW. There was much talk of the formation of a local VHF net using 50 Mc. Plans were discussed for the A.R.R.L. Field Day, and several pieces of portable equipment are being built. The members are forming a pool of test equipment that can be borrowed by payment of a small charge to the club treasury. Available equipment includes a micro-match, field-strength meter, VHF signal generator and a BC-221 frequency meter.

The Loyalist City Amateur Radio Club, Saint John, N.B., are sponsoring a large Re-union Banquet in Saint John Sept. 4 (Labour Day). An invitation is extended to all Ve1's and W1's and others. Keep this date open for a real good time. The L.C.A.R.C. Bulletin has a circulation of over 200 and is sent to amateurs in Nova Scotia, New Brunswick and Prince Edward Island.

The Ottawa Amateur Radio Transmitting Association is beginning to get somewhere in their campaign for the right kind of publicity for amateur radio in the Capital city. Several recent articles in the local newspapers have improved public relations and the comments on these have been very gratifying. In March, a "home-built equipment" contest was held, and the winner was Jim Swail, 3KF. Second prize was taken by D. Dashney, 3BDY. Another contest for portable equipable this time is under way. The club is busily planning a ham-fest, to take place some time this summer.

The regular meeting of the London Amateur Radio Club, London, Ontario, was held April 8. There was some discussion about the need for sufficient postage on QSL cards. Three cents is required in Canada on all postcards which contain any written matter in addition to the address, even if it is only one word. Type-written matter to the post office is just the same as longhand. The club will display some equipment at the coming Hobby Fair. The

meeting was addressed by Jim Potts, 3HI, who has travelled widely in the South Seas, and his talk was illustrated by slides made from pictures taken by him in the Pacific.

The regular meeting of the Hamilton Amateur Radio Club was held at McMaster University, Ont., April 15. Guest speaker was Crawford Robinson of the Hammond Manufacturing Company at Guelph, whose lecture on beam antennas was well received. Construction of equipment for the A.R.R.L. field day continues apace under the able direction of Wib. Clemence, 3KM. The H.A.R.C. hereby serves notice on the Westside Club of Toronto that the cup which they now possess should be all shined up in apple-pie order, to be ready for the Hamilton boys. Their boasting is not without foundation, as the pre-war cup was won by Hamilton so many times that they now it outright! May the best club win!

A fine example of the "spirit of amateur radio" was shown recently by members of the Scarboro Amateur Radio Club, when the entire club turned out to help Al Wilson, 3AMB, acquire a windmill tower. One day was spent in removing the tower from its location at a nearby farm and the next day was spent in erecting it at Al's location. It was a three-mile move, and several cars, a trailer, and a tow truck were employed as a convoy and moving gang. The club now has new club rooms at Stop 14, Kingston Rd., Scarboro Bluffs, Ont. Code practise classes sponsored by the club are held by 3RU on 28240 Kc every Monday night from 8 p.m. until 8.30 p.m. A club paper, known as "Dah-dit-dah" has made its appearance and bids fair to become one of the outstanding club bulletins.

We have been asked by Mr. Jay C. Finnan, 109 Hounslow Ave., Willowdale, Ontario, if any user of a converted Bendix TA12G aircraft transmitter for amateur use will kindly communicate with him, as he hopes to get his license soon, and wants information on the conversion of this set for CW use.

LEARN CODE this easy way

• This automatic INSTRUCTOR machine will teach you quickly to send and receive code (Morse or Continental). It comes complete with code tapes and instruction book, gives clear signals as fast or slow as you wish. Low Rental plans, clockwork models, for 1, 3 or 5 months. New machines for sale, Electric Models included. Write for folder giving full details.



Also Day, Night and Home Study Courses in all branches of Radio Communications.

RADIO COLLEGE OF CANADA
54 Bloor St. W. - Toronto
Canadian Rental Hdqtrs. for over 10 years.

C A R O A NATIONAL REPORT

Ve1

Ronald J. Hesler, Ve1KS, Box 160, Sackville, N.B.—HW is operating on 75 with a new modulator using an 807. WG is building a new modulator and speech amplifier. QK is going to swap his 10 meter beam for one on 20. NZ is plugging away on 10 and 20 but sometimes covers up GK on 20, we understand. IB is rebuilding his rig to get rid of a good many stray ends, so he states. KN is putting the finishing touches to his rack-mounted job using an 813 in the final. CB is still accumulating parts for his new rig. EQ recently moved his QTH. Major Harris, Allen Doane and Gordon Purdy of the Truro Club are still plugging away at code and hope to get their tickets soon now. The new officers of the Truro Club are: President, Weldon Mills; vice-president, Les Hamilton, and secretary-treasurer, Gordon Burchell. FQ is still plugging away on the 20-meter band. He informs us. He also passes the word along that the Halifax Club now at last have their own clubrooms and should soon be in the air with a Millen exciter and BC348 receiver. The new officers of the Annapolis Valley Club are: President, EA; vice, KK; secretary treasurer, LG, and FG and DY members of the executive.

CU passes along the news that the boys in the vicinity of Yarmouth have had a club going for over six months, of which we were not aware. DW is the president and I assume that CU is the secretary or "scribe" of some description. DW is working VHF along with QY and BU. QY has made quite a name for himself on 6 and is now working on 2½ meters. BU is on 75 with low power. JY works 75 and 10. HN is hitting at 20 and 10 these days and BN is on 40. HG is one of the 20-meter fans using a 6L6 and 807; so far has marked up over 69 countries to his credit. LN is reassembling his shack and is not on the air as this report is written. CU works 20, 10 and 40 CW. IE took quite a ribbing lately when his QSO with IL was recorded by EE and then played back to him. It seems that Harley was attempting to call Walt's dog over the air! HU are experimenting with 10-meter converters and hope to obtain a circuit that they will soon be able to manufacture and market for those of us who haven't time to make our own.

PC recently succeeded in contacting his brother (Ve8OE) on Nottingham Island. DQ works Ve8OE daily on 20 phone. MD is running about 180 watts with a pair of 808's and 900 volts. QU is a new ham in Grand Falls. HL recently addressed a meeting of the L.C.A.R.C. on the subject of BC sets and other matters which was extra interesting to the club's members. HB reports that the Fredericton boys are endeavouring to form a club. EI is working much and varied dx these days; among some of the more elusive contacted was M13ZJ in Eritrea and the Gatti-Hallcrafters expedition. FL is having trouble now that he belongs to the Lamplighters Society — seems that when Fred operates the big rig he receives free lighting in the house and it is reported that a neighbour heard him without his set even being on. RQ has been testing out a new 2-meter beam. VD has left the radio school and has shipped out as Sparks on a boat plying the North Atlantic. UG is working on a miniature transmitter and receiver which will fit in a small suitcase. LI reports that he doesn't get much time to work the bands now that he is out on the road. FG has built up an exciter similar to the one in May '46 XTAL. DI, who has been house-hunting lately, found himself in that ham's predicament—a receiver and no transmitter, so the other night FV "trotted" up a 6L6 oscillator for his use. UR recently had the misfortune to have his car stolen, but with the able help of the R.C.M.P. (IL) he soon recovered it. IW is busy these days dreaming about the coming sailing season. FJ has been on the air for six months using a 6L6 oscillator and NC46 receiver. FS reports that he has been confining his operations to the 10-meter phone band using an HT9 transmitter. NM, who is in the Lancaster Military Hospital, is coming along great after his recent operation, and hopes to receive permission to get on the air soon. CL is a new member of the L.C.A.R.C. 2XA (ex-BF) reports the addition of a new Junior Operator. IW continues to chalk up his dx score. FC has been having a bit of trouble with BCI lately. CJ is now located at Bloomfield and despite the handicap of having lost one arm is ironing out the bugs in his rig which used to belong to the late Dr. Daley of Sussex. VZ is the call of Madeleine the xyl of KS.

VY is a new ham in Sackville (Peter Fisher). Another xyl to join the ranks is Rose-Marie, the wife of BB, who has the call UZ. VY is using a 1155A receiver and a McMurdo 75 watt transmitter.

MZ has his RME45 up for sale, we understand. GT is active on all bands. BC and OW are back on the air again on 75 fone with 5 watts. LZ is playing around with command sets. SF is working on 6-meter equipment. NO is on 20 meters with a new transmitter using an 812 final. DQ now has a VFO and is smiling all over his N.B.F.M. EP is now VO6EP. LK recently worked M13ZJ on 10-meter phone. KY works his dx strictly in accordance with the direction of the prevailing wind. NQ has built himself an operating console. MS has been heard again on 10 meters. HT has been bitten by the traffic bug and operates on 20. JK has added an RF stage to his converter. PT finally landed a VK on 20 fone with the help from his grid leak alarm clock. TR and TF were worked on 6 by QZ and JK. AX has been procuring a lot of tubing of late and the Halifax boys are beginning to wonder if it is going into an antenna or a still. PR has a 3" scope for sale. DB, PQ and FB were amongst those who entered the B.E.R.U. contest. The Halifax Amateur Radio Club had an exhibit at a hobby show in that city, and from all indications it was a whale of a success. They handled 48 messages (originated) for as far west as Victoria and as far south as Tampa, Florida. WD is the call of a newcomer to the ranks of amateur radio—Ralph Beech. PX is heard now and then on 75 fone using N.B.F.M. BB schedules his brother in Quebec practically every night of the week. 73—Ron.

Ve2

Floyd G. Gribben, Ve2XR, D. R. Quebec, 5120 Westbury Ave., Montreal, Que., phone Elwood 5387.—Another Field Day has come and gone. If you were lucky (?) enough to have been in on it you are probably getting over the ill effects of a sleepless night, sore fist, tired tonsils, damp duds, hungry look, lack of soap, cactus face and the inevitable score raisers. . . . QLC beverages! Yes, the major effort is over, and we start settling down to increased summer QRN. Therefore it is time to rebuild or put up that new antenna, etc., before it gets too hot. Before you take on one of these jobs how about a gander around Ve2? PJ uses the arm on 80 in Beauharnois. So does ADB of Pierreville along with ACD of Grand Mere. MO in St. Lambert boasts highest Ve2 in Ve-W contest. Nice going, OM. MK says he gabbed with a few (G's using 25 watts on 20 phone with none other than a ten-meter dipole! WF, ABG, AEA do their stuff on 80. FX enjoying himself on 10 phone from Pointe Claire with PP 813's. LV considering building FM adaptor for his NC-173. OA dits and dahs on 80. Andy uses 300 watts to 813 at 4144 Marlowe Ave. in Montreal. WK QRL new R.R. job and works 75 when he finds time. Stewart boasts QSL from GVB for QSO on 75 with his 30 watts to 807. WY of 515 Victoria Ave. in Westmount joins CAROA. Ross talks to his 813 on 10 phone, swings a mean beam and sucks 'em in with an NC-173 using an R9er as a magnet. Welcome to the mob, Ross. GM bought one of those tiny BC-458-A VFO rigs. Bert now has two, one for 80 and one for 40. DI and EY beat with your BFO's on 80. MW of Shawinigan Falls (formerly Montreal) has Bendix TA12C rig on 75. AAO hands it out on ten phone. LP modulates 24G tubes on 6 in St. Lambert. RS mauls a mean mike on 10. PK can now operate on any phone band thanks to R.I. QS thinking of sampling few commercial FM VFO units to find one he wants. TJ of Quebec hopes for 6 soon. JJ fooling with new 3L beam for ten. EA does his phoning on 75 from Sherbrooke with Bendix TA12C. BN, our Pop, the grand OM of St. Eustache, is back at the old stand after operation in Queen Mary Military Hospital in Montreal. All your old pals are glad you're backs, Pop! UA runs new ham shop in Westmount known as Westmount Electronics. EM has SCR-522 job on 2 meters and says FF of Cartierville is new voice on that band.

AAV in Dorval knocks the bases off two 807's on 6 that pour the hot soup into a 3L beam (sort of a beam-soup). An AR-6 with a converter does the rest. Also in the land of vertical versus horizontal polarization you'll hear such lads as OS, KH, AE, AI, NI, AG, EX and KS.

not to mention "Broadband Bill, the Rotund Reporter" (JJ to the mystified). On 2 the sideband room is a lot more for we only find FK, EM, AX and FF. All of which proves that the boys in and around Montreal are now hitting the highs. CO reports at last that he should be on soon. Lindsay says he's found a permanent and larger QRA. Those living in "Kw Korner" (Snowed-in Junction), Montreal, will be delighted to know that your "S" meters will soon be going off scale when Lindsay cuts loose from 4457 Beaconsfield Ave. Hi Hi Dept. . . . Phone Man.: "Phone's a lot better'n CW 'cause you can say a hang of a lot more in less time!" CW Man: "Yeh—maybe so, but it sure takes you guys a heck of a lot more time to say it!" Brock Wilcox (call on way) will soon be ready to go with a pair of 24G's on 40 from 3365 Barclay Ave. in the Cote des Neiges district of Mount Royal. At long last our Convention Chairman, Herman Eberts, heard from the R.I. When you hear AEC it'll be Herman. Welcome to the airwaves, OM! WF been trying out 75 with 807. KH, our famous VHF man, who doesn't, we feel, think the bands of 80, 40 and 20 exist, finally quit putting off joining CAROA. John is 4th among the Ve boys in the 6 meter states-worked-and confirmed battle. When you hear KH, two 807's will be sweating their caps off, pouring it all into a 5L beam which rotates on the roof of the QRA of John Pavey at 2192 Addington Ave. in Montreal. If you've heard ZQ on 80 CW it was the work of Raymond Bilcoq of 165 Calixte St. in Plessisville. Ray keeps the hydro happy by using a Bendix TA12C soup box and favours Halli-crafters by using an SX-24 and S-38. Rod Stewart, an old timer at the SWL game, who sleeps at 418 Claremont St. in Westmount, joins CAROA. Welcome to the fold, Rod. Ex-VelGV now getting used to signing 21A when he's not QRL at the Northern Electric Co. in Montreal. VH has all band phone endorsement. XV of St. Rose talks on ten.

Boys in St. John's known as LQ, JN, RF, WB, GD and SG met at the home of HE to discuss formation of new club. Lots of luck in the new venture, fellows. (Club Activities Dept. of XTAL please note). VL glad to be back in Montreal with family after one-month stand at Mt. Joli field with CPA. Bud and his xyl and kids spent two weeks' holidays with the folks at home in Toronto and managed to get in a few days at Niagara Falls. RL has Bendix TA12C soup-set and an S-40 blood-box. AF dabbling with 813's in new fone rig. GE worked all continents on 20 phone but needs few cards to prove it. Gord just returned from Ve4 land where he was on business in Winnipeg. DU seems to like to build rigs to sell 'em. His PP814 75 fone has been up for sale. What now, Noel? SA, KG, GL and JJ do an FB job as reporters for the Montreal Amateur Radio Club's ham paper, the "Skywire Bulletin." Like myself, they cry continually for news for their columns. Won't you give them your support? They are doing this work for you and ham radio. Get that news to them. Write 'em or call 'em now. LZ of Quebec and DU of Bordeaux did swell job of tying in with hookups of Maritimes and Ontario stations on 75 on the night of May 6. All concerned presented local Lions Club presidents over the air to Ve3EJ set up at the Lions Club Hobby Show in Brockville, Ont. The lads taking part should be congratulated for this novel stunt. It was swell advertising for the Lions Club and a very FB job of public service by Canadian amateurs. New hams may be heard on 80 CW signing AEE, AEG and AEH. Archie Flemming, usually seen at M.A.R.C. meetings with HI (our Ethel) finally heard from the R.I. on May 6th. If you hear AEN it will be Archie who is set up at 4180 Cavendish Ave., Montreal. He uses an 807 in the final and receives with a HRO-BJ. Archie is set up in one of the Bennie Farm buildings and of course has antenna problems. Twenty meters at the moment is his speed for that reason. Welcome to ham radio, Archie. Lou Buck, long time SWL, joins CAROA and hopes for ticket soon. Says he's got an HRO to start things off. Lou is set up at 5501 Bourret Ave., in Montreal. (Take note, DL.) Get first-hand Ve ham news by listening to the CAROA Official Bulletins broadcast each Thursday at 9 p.m. HL in Quebec and DL in Montreal are the boys doing these broadcasts. These lads are doing their bit for ham radio so give them your support. Listen!

KG goes FM. By the way, you can help to advertise the Eastern Canada A.R.R.L. National Convention in Montreal this Oct. 8 and 9 if you'll write the sponsors of this big hamfest, the Montreal Amateur Radio Club, Box No. 1, Postal Station "D". They have a supply of QSL stamps telling of this big "do" which you can stick to the back of those cards you're sending out. Ask for some and help publicize this big event. Those of you who couldn't make the Apr. 28 meeting of the Montreal Amateur Radio Club, should be interested in what went on. It went like this. A bit of dx turned up, such as VP9X, Horace Flint; VQ4JAN, Ian McKenzie, from

Kenya and G8DQ, and of course the lad who took the \$5 cheque for his fine work in designing the best new crest for the M.A.R.C. He was KZ5ES, who's been around these parts for a spell. CO the CO in charge of food parcels for G's gave out with the warming news that since last October the club members have donated a total of \$310 and have sent 67 food parcels to very grateful British hams. One such lad was G3YN, who expressed his gratitude by sending over a vy FB slow-speed VFO dial which was given away by usual lucky number draw system. GL, Gordie Lynn, the A.R.R.L. S.C.M., gave interesting talk on the League Communications Organization and described the functions of the various departments such as S.C.M., R.M., P.A.M., S.E.C., O.B.S., O.R.S., O.O., etc. He wants more appointments in these groups. How about you? QQ brought along a wire recorder and played it over the club's PA. It was ham band stuff, to be sure, complete with electric razors and auto ignition. Good laughs were had by all. (Phone men note!) AEC, Herman Eberts, Convention Chairman, gave brief outline of progress of hamfest plans. Said K. B. Warner of A.R.R.L. would be one of the many prominent attenders. An intermission brought coffee and sandwiches with HI (our Ethel) as hostess, together with VV at the tap of the 15-gallon java tank, XR keeping the empty and full cups moving, and AEN (new ham) delivering the goods. As was previously requested, many of the boys brought the ladies. (Poor gals were outnumbered, and did they (the men) love it!) For door prizes one lucky gal got a toast burner. Others got half-pound boxes of L.S. candies. For the men, the top prizes were an R9er (donated by Millen) and a Bendix TA12C mod. unit (donated by Westmount Electronics). Both won by lucky number draws. The R9er went to Mr. H. A. Harries and the mod. unit to DI. In keeping with the instalment plan for club members buying convention tickets, volunteers pushed the scheme by making a collection amongst those present totalling 159 bux, representing 87 advance registrations. Those taking part in surrounding the gang for the kill while they were eating and gabbing, were Mrs. QQ, Mrs. AEC, Miss Watt (none could resist!) GE, BO, EM, FK and UJ. To top it all off, a good time was had by all. If you're wondering who GF is on 80 CW it's the work of Rosaire Nadeau of 135 Morin St. in Quebec. He has an 807 soaking 35 watts from his power supply and snoops 'mongst the kilocycles with a home-made receiver. Rosaire says he's glad a few boot-leggers were nabbed in his area. PM of Quebec is rebuilding. ABF of same town has new antenna. ZU of Quebec (brother of AO in Montreal) runs 15 watts on 80 CW. AO in Montreal travels too much to be on any other time than week-ends. Says he uses 6L6s on 75. HH of Beaconsfield spends his time on 75 too. UM puts out nice sig. on 40. AEF new Montreal ham who returned to the air on 40 on May 2 after a 10-year lay-off. He runs 50 watts to an 807 in a Harvey-Wells TBS-50 job. Welcome back, OM. TZ slaps the bug on 40. RA of Roberval and IC of Hull do their phoning on 75. QO uses 80 for his QSO's. The most reliable of our Ve2 readers, LO, John Holland, of Drummondville, sends in his regular monthly report. John is kept QRL with traffic with BB and TM and WILM of Boston which all takes place on 40. John reports that TD is new ham in his town with nice looking rig using 813. Thanks for your letter, John. Beef Dept. . . . Many an old timer will say that our present-day operating practices of both old and new hams have hit a new low in quality. Some of the reasons could be any one of the following: (1) Complicated war surplus equipment being used by beginners; (2) Old timers, in the game for years, who won't adjust their ways to present day conditions; (3) Bad notes and key clicks; (4) Off frequency operations; (5) Using high power for local contacts; (6) Testing without a dummy antenna (especially non-radiating); (7) Poor sending; (8) Long CQ's and calls; (9) Over-modulation, hum and distortion on carriers; (10) Insufficient knowledge of operating procedure; (11) Learning to use a bug on the air instead of with an audio oscillator first; (12) Phone men's tom-foolery and long-winded repetitions; (13) Search for broadcast quality instead of NB A.M.; (14) Going high power to achieve an end which could be found with original power and better operating techniques; (15) And to top it off . . . forgetting there's the other fellow! Yes, men, they are the things we must try to eliminate, but what can we do about them? Well, how about this? The A.R.R.L. has a voluntary organization in the U.S. known as Official Observers (O.O.). These fellows monitor the ham bands and note off-frequency and other poor operation and report their findings to the fellows concerned, thus tending to keep ham operating at a higher level. In so doing these W lads are keeping their own house clean and are at the same time keeping F.C.C. out of their hair. In this country the CAROA should sponsor a similar group. To differentiate they could be called Official Monitoring Stations (O.M.S.). We

could give this group the authority they would need to get the desired results. The Dept. of Transport is only interested in our BCI and off-frequency operations (and our \$2.50), so we can't expect them to do our dirty work. We were given our bands as they are (certainly bad, aren't they?) so we must do our own house cleaning. Only when our own methods fail to correct offenders, should we ask the D.O.T. for aid in enforcement. As a suggestion, the D.O.T. could call for license suspension from one to 12 months depending on the nature of the infraction. Sounds tough but it has teeth! Just what we need to make a plan such as this worth while. Our bands certainly can be a lot better than they are, so let's start the ball rolling. If you feel an organization of ham band observers is needed in Canada, then send your suggestions and comments to the Editor of CAROA at HQ. Let's get going on it now! That, fellows, does up the June package. Before you read on, though, please remember that news is wanted for this column. Others want to hear about your doings. You can make this column a lot better by your contributions. It only takes a few minutes with a pen or a telephone to send in your news. My QRA and phone number head this column, so let's hear from you, OM's. Have nice holidays. See you here next month. 73. Floyd.

Ve4

Les Saul, Ve4FJ, St. James, Man.—10 meters, CY, Brandon, is burning a groove down in California and dx land. ZK works a tentative daily sked with ZL4DP on fone. VK is working the ZL's. WB is back on again after a few weeks' absence. LC worked five countries in a week or so with a powerful 50 watts. Working out on short skip night, April 16, were KX, VK, GI, NX, SH. W9's and WO's were coming through well. EX is experimenting with a mobile rig but is troubled with modulation and ignition noise. RO gets on 10 occasionally with a 10 ft. vertical. The band has lost another old standby. WB has gone to 20 and the QRM. GI is on 10 fone and 40 CW. Skeds with his brother in Calgary three nights a week on 40. Syd is also planning a three-element job to improve his work on 10. SJ is rebuilding to 500 watts. FU works 10 fone with 2.0 watts to a three-element beam. RO received a QSL from C1CH in China with a \$3,000 stamp on it. Inflation, y'know. 10 dx is picking up with PY, LU, CE, OA, CO, VP5, KZ5, XE, KP4, KH6, VK, ZL and others coming in. Otherwise the band is dead. (hi). Mny tks to Ben, 4SH for the fb reports. JK has been appointed CAROA OBS. Listen for him each Thursday, 9 p.m. on 75 meters. 73—Les.

Ve5

Bill Gordon, Ve5MJ, D.R., Oxbow, Sask.—QB is situated at Glenavon now. DT at Grenfell on 75 fone now along with CL at Broadview. Ron also works 20. If anybody knows how he can get off the continent, let him know, before he joins the long list of blown fuses! GA gives CAROA bulletins on Thursday evenings at 10.15 p.m. M.S.T. That's about the only time Bill can give the bulletins and give the BCL's a rest at the same time. KJ has been doing a very fb job on TL "I" with his low power, as is shown by his tlc report. The regular meeting of the Regina Amateur Radio Association was held in the armouries on Monday, Apr. 5. The guest speakers for the evening were Bill Bourne, who gave an interesting talk and demonstration on power supplies, and the club's president, Don Leitch, who gave a talk on procedure and operating an amateur station. The executive is working hard to make the forthcoming hamfest a successful one. MW has a new VFO. Now with the above finished yours truly has something to get off his chest. In the March issue of XTAL, one of our very good friends from Ve4 land suggests "jacking up your Manitoba reporter or getting a new one so that we can read something besides the worn-out dope on the Ve5 75 meter corporation." I might suggest to our friend that he find out how many reports the Manitoba D.R. has received from the fellows during the past year. Half a buck says you could count them on your fingers! Almost the same applies to Saskatchewan. It just happens that I work 75 meters and that's the only reason we get any dope at all on the 75 meter corporation, for that matter. I haven't got an antenna up in the ionosphere to snag those 10 and 20-meter sigs from Saskatchewan to find out what's going on up there. So it's your column fellows—how about it? Traffic: 5KJ, 82. I guess that's enough steam for one shot, so 73—Bill.

Ve6

W. R. Savage, Ve6EO, 329 15th St. N., Lethbridge, Alta.—6LX says he is next on the list for a new car and his xyl is planning lots of trips for this summer. 6JJ is planning a trip to Seaforth, Ont., to visit ex-4GM, Bill Roberts. 6MP tells a good story on herself. After shooting trouble on the ECO all evening and not being able to have a QSO for a whole 24 hrs., she found the ECO was not plugged in. 6HB says he has a job finding the road there is so much snow; he went over the edge twice. 6AO and 6TM are sure getting optimistic; they visit the QSL mgr. in a truck to take their QSL cards back with them. What next? 6GD puts up a 20-meter beam. He can't work dx with that KW excuse he has. Next thing he will be putting a dial on the rig with both numerals and the alphabet so he can just dial dx stations like a telephone. 6FK is still working the odd new dx station with that beam and seems to get cards to prove it. 6PP now has his WAC certificate and is still working some fine dx such as G, GI, GM, ZB1. Keep it up, Pere. 6RO claims a bootlegger is using his call and sure would like to meet the person. (So would the D.O.T.) RO is using an 807 in the final with 35 watts. 6TK takes time out to send an envelope to collect his QSL cards. TNX, Jack. 6PV and 6VJ is another family ham circle, Mr. and Mrs. Tyrrell. They also have another hobby, which is rifle shooting. 6XX and 6NW only live two doors apart. We wonder how they make out for QRM. We should worry; they must have it under control. 6MZ is a cheerful soul. He informs yours truly that he worked DA7RB after the chap called me a few times without results. Ex-6SO (funny how these old pennies keep turning up) writes in a nice letter and says he is now Ve2IN of Montreal. So you fellows who would like to QSO Phil keep your ear open for his new call. Tnx for dope and write again. 6IY is operating 28 watts on 10, 20, 40 and 80 and seems to be hooking the dx okay. 6JC writes in and claims he has seen his call letters on a strange car. Maybe the D.O.T. should investigate? He is running 20 watts CW and 15 watts fone using 12-volt dynamotors. 6SL and 6BM are both active on 75 and BM is noted for burning the midnight oil. (A true ham, hi!) 6IN has a bug and is pounding brass on 80 most of the time. 6GN is using a pair of 813 in the final running 400 watts CW and 275 on fone with a 36-foot whip antenna which he does not like. 6BX is another ham at Suffield but has not moved his rig from Medicine Hat as yet. 6HU is now using an Eimac 304TH and says it's no trick to work dx. He must feed the juice to this old fruit jar with a garden hose. 6OD is going to use a small rig for a month or so while he rebuilds his transmitter into a new cabinet. 6JJ has a gang visit him on Sunday, Apr. 25 including 6GD, TM, AO, WG, FK, OD and EO. We were quite impressed with the layout that Jessop has. What really topped the visit was the wonderful meal prepared by Mrs. JJ. Now we know why Jessop always has a contented look on his face. 6MA has now got his rig rebuilt and has it on the air. Sounds fb Bill. 6BC is selling all his equipment and says he is going mobile. That will be handy. He can QSO and yl at the same time from a lonely mountain top. Hi. 6CJ is getting traffic-minded now he is an O.R.S. 6KO says he is going on 20 and 40 CW for the summer until 10 opens up again. 6MV has rebuilt his transmitter and is now thinking about getting a new motorcycle.

I want to thank all those who wrote in and contributed to the column this month, and to those who did not—you have a chance to donate some for the next issue. It certainly is appreciated fellows, so let's know what you're doing. 73—Bill.

Ve7

Ernie Savage, Ve7FB, 4553 12th Ave. W., Vancouver, B.C.—Spring is well on its way, and field days, hidden transmitter hunts and picnics are on their way. Oliver Amateur Radio Club just finished their field day trails, and the Vancouver Amateur Radio Club's second annual dance started off with a real bang—a can full of fire crackers were let off. When the smoke cleared the hall was plumb full of yl's, xyl's and their boy friends. The gang had a good time, and it looks like the Vancouver Amateur Radio Club will have to find larger place for next year.

The Collingwood Radio Club visited the 13th Club en masse on Mar. 23. They went there to see how a receiver was aligned with scope and all that does the job. (I guess now all their receivers are receiving the images.)—They even sneaked into 7HI's shack to see the reputed gallon and were given the bum's rush, but did see a pair

of bottles in the final that could loaf at 10 KW. The evening was finished with hot dogs, and to make the coffee last—it was served in small cups.

The two meter bug is getting many new victims. 7AZ Jack is heard inquiring frantically about where to get butterfly condensers, so guess that will be another signal on two in time. Also 7UU Alf, is expected to be heard down there soon. Alf, heard France working on ten. 7AME Doug, 7ADV Jimmy, 7LF Cliff, are all on two. It looks like the Collingwood Club can't trust its members, so all follow each other, either for dx or news. 7LF Cliff ops from the North Shore Mountains during the week-ends on two. 7OJ is active on ten tone and if you drive across 49th from Victoria to Fraser you can see this monstrosity that they or he calls a beam.

From Oliver Radio Club comes the first word of their field day, and it was Easter Monday that their 420, 400 and 75 meter rigs were on. The 420 Mex. rig packed up first but the rest did work well throughout. The Technical Committee, 7MC Milt, has sold his radio business and is in the honey now—a bee man. 7DB Bill has been under the weather and is blamed for no code classes. He did rebuild his modulator with the help of Hugh, who is sitting soon for his steam ticket. It would be a good idea to remember that so he can build yours for you. George has finished his scope and it will be on view at the next meeting.

Vancouver Amateur Radio Club has many things planned for the new year and looks like the station Ve7ZV will be on almost steady and also the code and radio classes will be going for sure this time. 7WR Bill is in the hospital and is doing OK. 7GF Bill is running T20-80 CW and 75 phone. 7FB Ernie has his exciter finished, and one by 7CB Chris, and soon he will be going all bands. Also if anyone has ideas and wants a good exciter he should see Ve7CB, Chris Brown, in Victoria.

Ve7CB has a VRL receiver. Ve7SW Allan is still looking for traffic and he can't block Chris's receiver now, so must crawl right on frequency to be heard. Ve7SN is back to Port Alice after his stay in hospital and feeling fine. Ve7ZV, the Vancouver Amateur Radio Club's transmitter, will be heard more often now on six meters and quite likely on 40 and 80 CW in the very near future. Ve7BK Barney is letting the country know he is still on and puts into Vancouver an R9 signal.

Ve7AIJ Hal, who seems to have deserted the gang, is now reported to be sporting a nice new car and it is said that he is buying Gon-sets and stuff, guess it's mobile ten for Hal. Ve7SL Dudley dear xyl was tired hearing him tear his carbon mike to pieces, so on his birthday she gave him a nice shiny crystal microphone to go with his PP813 low power rig (so he says). Ve7AHX Roy is running a pair of 807's at 70 watts all band and receives with an S401A.

Ve7AGE Howard is busy on ten with a portable receiver and the transmitter is also semi-portable. W7BQS Sher and W7LTE Chuck, both of Seattle, are heard on the five o'clock net pretty nearly every night. Ve7DA Stew is getting the rebuilding bug and it sounds like push-pull final. Ve7JF Dick, the Wild Irishman of Vancouver, is keeping his skeds up with W7JFB Miriam and could we mention his activities at the dance, or shall we? The Nanaimo Amateurs have got themselves together and now have a club and there will be more news from there now, so says Ve7YI Stew. Ve7WI Wally and he has for witness Ve7DZ Maxie that he is running 200 watts plate modulated with sixty (60) watts of audio and it is fully modulated. Letter from Sand Spit. Fine, Percy.

Again we ask you all to send us the news that you hear and see, please. Very 73, Ernie.

CALGARY HAMFEST

The Calgary Amateur Radio Association, P.O. Box 196, Calgary, Alberta, is going to run an "Alberta Hamfest," in Calgary July 31 and Aug. 1. The registration fee will be \$2.50, and the entertainment provided will include an opportunity to see parts of the General Electric House of Magic, historical display, a banquet with prizes, specially arranged tea and a movie for the ladies, and a trip to a local broadcast station. Last but not least, lots of ham gossip. Further details and reservations can be obtained from H. Picken, Ve6QS.

VHF—from page 13

235-250 Mc—Ve3AEZ, Ve3BNG, 15 miles—May 18, 1947.

420-430 Mc—Ve3AND, Ve3BFF, 1 4/5 miles—May 15, 1947.

Let's see someone better these records in the very near future. Also how about letting us know of activity on frequencies higher than those shown. Can't anyone claim QSO's on the microwaves?

We hear of Ve3AID and 3ZE, who have had 19 QSO's in the last month on 235 Mc using E1148's in p.p. and 9002 super-regen receivers. These boys are now headed for 420 and plan to do some fancy experimenting with antennas. Ve1QZ tells us that 144 Mc work is at a standstill in the Halifax area, and except for a few tests with the "B" set of the 19 set there is nothing doing on frequencies higher than 144. Such is not the story on 6 however, as there is a wave of enthusiasm from all over the Maritimes. In Halifax are Ve1QZ with a new plug in coil 100 watt rig, Ve1SF with a new triple conversion receiver and Ve1JK. In Chester, N.S., are Ve1TR, using an 807 final and a three element rotatable beam, and Ve1TF with 807 and folded dipole antenna. Ve1VL holds forth from Hubbard, N.S., with MOPA and folded dipole. Ve1AYL and Ve1FL in Saint John, N.B., are coming on six soon, and Ve1OD in Sydney, N.S., is building as is Ve1EA, Windsor, N.S.

The Belleville six meter stations have at last contacted the Rochester area and are working them consistently with signals ranging up to S9. W2RTX, Caledonia, N.Y. (about 18 miles south of Rochester), has the most consistent sig.

VERSATILE VFO—from page 9

It might be well to mention at this point that a small separate shelf for mounting the VFO is an excellent idea, as no movement of the operating table can then effect its stability.

Editor's Note—It is always a wise precaution to check the output signal with absorption wavemeter to make sure the output is on the correct frequency only.

DX NEWS—from page 12

QTH's. Thanks to Ve3IJ, Ve3BWY, Ve6FK and Ve1NE.

S1RX—Via RSGB.

VP6PX, Christ Church, Barbadoes.

VK9GW, c/o O.T.C., Port Moresby, Papua.

KM6AH, c/o C.A.A., Midway Island.

YR51, Box 326, Kukaresti, Roumania.

ZD1LQ, Lungi Airport, Freetown, Sierra Leone.

EA1A—Via W1AZW.

PK6XA—Bert Krygsman, c/o N.N.G.P.M., Morotai Island, Moluccas, N.E.I.

CANADIAN CLUB DIRECTORY

Clubs marked with an asterisk (*) are clubs about which CAROA does not have complete information. In some cases we only have the address of a member. Other cases, we possess only the secretary's name. Please take note of these omissions and let us know the full executive at the earliest convenience.

- *ABOVE 100 Mc CLUB, c/o 818 Mulvey Ave., Winnipeg, Manitoba.
- *ALBERNI DISTRICT AMATEUR RADIO CLUB, c/o Sec'y., 608 Redford Rd., Port Alberni, British Columbia. Secretary, Dave Dootson, Ve7PY.
- *ANNAPOLIS VALLEY AMATEUR RADIO CLUB, Bridgetown, Nova Scotia. Secretary, Fred Both.
- CALGARY AMATEUR RADIO ASSOCIATION, P.O. Box 196, Calgary, Alberta. Secretary, Hugh Picken, Ve6QS.
- *CARIBOO AMATEUR RADIO CLUB, c/o Sec'y., Box 160, Prince George, B.C. Secretary, R. J. Tate, Ve7DV.
- CHATHAM - KENT AMATEUR RADIO CLUB, c/o Sec'y.-Treas., 35 Lorne Ave., Chatham, Ontario. Secretary-treasurer, Bill Papps, Ve3BLA.
- CLINTON AMATEUR RADIO CLUB, c/o Sec'y., Albert St., Clinton, Ontario. Secretary-treasurer, Red Ultican, Ve3BHO.
- COLLINGWOOD AMATEUR RADIO CLUB, c/o Sec'y., 725 E. 52nd Ave., Vancouver, B.C. Secretary, Gord. Clark, Ve7OJ.
- *DARTMOUTH AMATEUR RADIO CLUB, c/o Sec'y., E. Edey, c/o R.C.A.F., Dartmouth, Nova Scotia.
- FRONTIER RADIO ASSOCIATION, 86 London St. W., London, Ont. Secretary, Stephen Postelnic, Ve3AXP.
- HAMILTON AMATEUR RADIO CLUB, P.O. Box 253, Hamilton, Ont. Secretary, Dan Welsh, Ve3FT.
- HALIFAX AMATEUR RADIO CLUB, c/o Sec'y., 20 Compton Ave., Halifax, N.S. Secretary, R. R. Pattison, Ve1RP.
- KITCHENER - WATERLOO AMATEUR RADIO CLUB, c/o Sec'y.-Treas., 68 Lorne Cres., Kitchener, Ont. Secretary-treasurer, Jack Fortune, Ve3BGD.
- LAKEBURN AMATEUR RADIO CLUB, c/o Sec'y.-Treas., 11 Copp St., Lakeburn, New Brunswick. Secretary-treasurer, B. Murphy, Ve1AQ.
- *LONDON AMATEUR RADIO CLUB, c/o Sec'y., Box 82, London, Ont. Secretary, Jean Calder.
- LOYALIST CITY AMATEUR RADIO CLUB, c/o Sec'y., 38 Cranston St. W., Saint John, N.B. Secretary, Iris White, Ve1AYL.
- *MONTREAL AMATEUR RADIO CLUB, c/o Sec'y., 5379 Coolbrooke Ave., Montreal, Que. Secretary, J. A. (Al) Campbell, Ve2RL.
- ONTARIO PHONE CLUB, c/o Sec'y.-Treas., 92 Elizabeth St., Chatham, Ont. Secretary-treasurer, Stan Moir, Ve3AQB.
- *OTTAWA RADIO TRANSMITTING ASSOCIATION, c/o Sec'y., 129 Beech St., Ottawa, Ont. Secretary, H. W. Hayes, Ve3BEB.
- *PROGRESSIVE RADIO CLUB, c/o Sec'y., 85 Victoria St., Waterloo, Ont. Secretary, Bill Wight, Ve3ADE.
- *QUEEN CITY AMATEUR RADIO CLUB, c/o Sec'y., 82 Kalmar Ave., Toronto, Ont. Secretary, Harold Kenmare, Ve3JO.
- SCARBORO AMATEUR RADIO CLUB, c/o Sec'y., 1227 Gerrard St. E., Toronto. Secretary, H. Langstaffe, Ve3FO.
- SHORE RADIO CLUB, c/o Sec'y., Mahone Bay, Lunenburg County, N.S. Secretary, M. I. Barry, Ve1NA.
- *SOUTHERN ALBERTA AMATEUR RADIO CLUB, c/o Sec'y., CJOC, Lethbridge, Alta. Secretary, Murray McLeod.
- ST. MAURICE VALLEY AMATEUR RADIO CLUB, c/o Sec'y., 445 Fifth Ave., Grand-Mere, Que. Secretary, Rev. C. E. Robert, Ve2EC.
- *ST. THOMAS AMATEUR RADIO CLUB, c/o Sec'y., 82 Hemlock St., St. Thomas. Secretary, W. E. Shaw.
- SUDBURY AMATEUR RADIO CLUB, c/o Radio Station CKSO, Sudbury, Ont. Secretary, R. Chinnick, Ve3AOG.
- *TORONTO AMATEUR RADIO CLUB, c/o Ve3BAV, 126 Beech Ave., Toronto, Ont.
- *UNIVERSITY OF BRITISH COLUMBIA AMATEUR RADIO CLUB, c/o Alma Mater Soc., University of British Columbia, Vancouver, B.C.
- *UNIVERSITY OF NEW BRUNSWICK AMATEUR RADIO CLUB, c/o University of New Brunswick, Fredericton, N.B.
- VANCOUVER AMATEUR RADIO CLUB, c/o President, 4490 West 12th Ave., Vancouver. Secretary, Don Byrnes.
- VICTORIA SHORT WAVE CLUB, c/o Sec'y., 1538 Amphoin St., Vancouver, B.C. Secretary, O. R. Hawkins, Ve7AHT.
- *WEST SIDE RADIO CLUB, c/o Sec'y., 470 Glenlake Ave., Toronto, Ont. Secretary, Art Frazer, Ve3ANO.
- WINNIPEG AMATEUR RADIO CLUB, c/o Sec'y., P.O. Box 26, Winnipeg, Man. Secretary, Leone Young.
- WIRELESS ASSOCIATION OF ONTARIO, c/o Sec'y., 130 Belsize Dr., Toronto. Secretary, Fred Reynolds, Ve3TC.
- *TRURO AMATEUR RADIO CLUB, c/o Sec'y., 91 Park St., Truro, N.S. Secretary, Gord. Burchell, Ve1IB.

Introducing Your DR . . .

★ ERNIE SAVAGE, Ve7FB

After a little prodding we finally obtained some information on our amiable west coast D.R. Ernie writes us an average of twice a week with the dope on Ve7 amateur doings, and is doing a fine job for CAROA.

The picture shows him relaxing at the rig. He runs phone and CW to an 810 in the final. VFO and crystals put the rig on nearly all the bands, he tells us. An SX28-A takes care of the reception end.

A BC654 sits in the shack as a portable for emergency use if he can get any help to crank out the juice for it!



Ernie started as a SWL way back in 1924 with a Browing crystal set from England and then into a Pilot Super-Wasp. In 1935 he met Ve5LQ, Charlie Bennett, and Ve5OM, Bill Orchard, who were in the B.C. police force at the Point Grey Office. He spent a lot of time up there listening to the gang, and also there was a Bill's transmitter. In 1937 they told him that he wasn't allowed in the shack till he got his ticket, so he made the grade and received Ve5FB. Went on CW eighty and forty till 1939 and made up a phone portable which put him on 75. In 1939 they took away the amateur bands so he joined the Royal Canadian Corp Signals as signalman and did all the jobs that come up in the army, and went overseas in 1940 as L/Cpl. Instrument

REVISED WWV SCHEDULE

Effective January 30, 1948

Standard frequency transmissions are made continuously day and night as a public service of the National Bureau of Standards over its standard frequency station, WWV, on the following frequencies: 2.5, 5, 10, 15, 20, 25, 30 and 35 Mc.

A 0.005-second pulse may be heard as a faint tick every second except the 59th second of each minute. These pulses may be used for accurate time signals, and their one-second spacing provides an accurate time interval for physical measurements.

The audio frequencies as interrupted at precisely one minute before each hour and each five minutes thereafter (59th minute, 4 minutes past hour, 9 minutes past hour, etc.), resuming after an interval of precisely one minute. This one-minute interval is provided to give Eastern Standard Time in telegraphic code and to afford an interval for the checking of radio-frequency measurements free from the presence of the audio frequencies. Ionospheric-disturbance warnings applicable to the North Atlantic path are given at 19 and 49 minutes past each hour. If a disturbance is in progress or is anticipated within 12 hours, the time announcement is followed by six W's; if conditions are quiet or normal, the time announcement is followed by eight N's. The announcement of the station's services and of the station's call (WWV) is given by voice at the hour and half-hour.

The accuracy of all the frequencies, radio and audio, as transmitted, is now better than a part in 50,000,000. Transmission effects in the medium may result in slight fluctuations in the audio frequencies as received at a particular place; the average frequency received, however, is as accurate as that transmitted. The time interval marked by the pulse every second is accurate to 0.000001 second. The beginnings of the periods when the audio frequencies are resumed are synchronized with the basic time service of the U.S. Naval Observatory.

Mechanic in the Five Armd. Div. Sigs., from there to 1st Canadian Corps Signals in the R.C.D., and from there, Sicily, Italy, and thru Europe. They did make him a full Cpl. (in England). Week after VE Day they flew him home. This was a dirty trick. They cut his load down to 35 pounds, and ideas of bringing home half of the army and half of the enemy radio gear and things went bloeey. They let him out in August, 1945, and he started on ten phone and then back to 75 phone and CW running 100 watts. Other hobbies are garden- ing, fishing, and for spare time the Vancouver Amateur Radio Club.

WELCOME OM'S

New Ve2 Calls

Ve2FW—Robert Black, Apt. 29, 1730 Dorchester St. W., Montreal.

Ve2VG—Florida Bodart, Villemontel, Quebec.

VE2YW—G. W. Storey, The Saguenay Inn, Arvida, Que. (ex-Ve3BCU).

Ve2ACM—Frederic John Pratt, 165 Kings Road, Valvis, Quebec.

Ve2ACN—George Addy Love, 34 Prince Edward Ave., Pointe Claire, Quebec.

Ve2ACO—Paul Boisvert, Radio Station CBF, Vercheres, Quebec.

Ve2ACP—Joseph Rodolphe, Julien Trepanier, 6E Rue, Val D'Or, Quebec.

Ve2ACQ—John McDonald Channon, 167 Chaplain St., Baie Comeau, Quebec.

V2ACR—Joseph L. F. R. Bernard, 10 Jubinville, Pont Viau, Quebec.

Ve2ACS—Donald R. Nasmith, c/o Marconi Receiving Station, Yemachiche, Quebec (Ex-Ve3BHK).

Ve2ACT—Guy Lauson, La Sarre, Abitibi Co., Quebec.

Ve2ACU—Ralph Letts, 353 Mercille Ave., St. Lambert, Quebec.

Ve2ACV—M. Aime Trottier, 128 Rue Guilbault, Longueuil, Quebec.

Ve2 Calls Cancelled

Ve20K, Ve2SF, Ve2ABW

Ve2 Calls Changed

Ve2DS—F. Senecal, Rue Victoria, Bagotville, Que. (ex-Ve2ACA).

Ve2ACA—Mrs. A. C. F. Argall, 104 53rd Ave., Dixie, Lachine, Que. (ex-Ve2ABW).

QVE

CAROA Official Broadcasts 75 Meters Each Thursday 9 p.m. Local Time

The undersigned stations have been appointed as CAROA Official Broadcast Stations. Be sure to listen for your district OBS for latest messages and bulletins of interest to all Canadian amateurs.

Ve1GD—3835 Kc—H. A. Garland

Ve2HL—3802 Kc—J. W. Labelle

Ve2DL—3827 Kc—R. Frenette

Ve3QB—3835 Kc—W. B. Knowles

Ve3CP—3775 Kc—T. Hunter

Ve4JK—3820 Kc—B. Fowler

Ve5FA—3848 Kc—W. A. G. Simpson

*Ve5GA—3847 Kc—W. T. Rogers

Ve6OD—3801 Kc—E. A. Anderson

Ve7FB—3825 Kc—H. E. Savage

Ve8AS—3820 Kc—J. Spall

*—10:00 p.m.

NEW PHONE & C.W. ASSIGNMENT

EFFECTIVE OCT. 8th and 9th

You are requested to QSY to the
Mount Royal Hotel in Montreal
for the

EASTERN CANADA

A.R.R.L.

NATIONAL CONVENTION

The Greatest QSO Party and Ham-
fest in Canadian Amateur Radio
History.

Sponsored by
The Montreal Amateur Radio Club

Tickets

For the OM.....	\$5.50
YLs and XYLs.....	\$3.50

Reservations

Send in your requests for rooms to
us now and avoid disappointment.

Information

Mail all your communications to the
Montreal Amateur Radio Club, Box
#1, Postal Station "D", Montreal,
Que.

**COME ONE AND ALL TO
MONTREAL IN THE FALL!**

RADIO ROMANCE—page 7

in favor of someone a little more likeable I have no intentions of disappearing while this inmate of Jones Institute is loose.

It is Keefer, however, who finds a way out. "What do you say," he suggests, "if we all drop over to Joe's place and look at his station? That is, if he has no objections."

I look at Dahlia and don't know what to say. Before this I haven't even been able to drag her over to the shack, but now she is smiling and saying, "Why, I think that's a perfectly lovely idea," and almost before I know it we are all on the street and headed for my place. All the time I am wondering if Dahlia really likes this other guy or if she is just making a play for him so I'll do a bit of worrying and maybe show more interest.

On the street, Keefer monopolizes the conversation. He's still talking about radio and Dahlia is still smiling. "According to McGillicuddy's 'Theory of Propagation,'" Keefer is telling her, "the normal free-space pattern of an antenna is modified by reflection of radiated waves." He flashes his teeth at her and goes on like that for five minutes and all the time Dahlia is staring at him as if he's something out of this world which I am privately inclined to think he is. She is apparently so entranced that she even stumbles at a curb and Keefer seizes her arm and holds her for a long time after she needs it.

I have the rig on 20 meters and as soon as we get in the shack I switch everything on. Dahlia sits down in an easy chair and Keefer commences to prow around. After a while he says, "Ha, ha, nice little station you've got here," but he doesn't sound as if he means it. He gives Dahlia a fond look and she smiles back at him, then he returns his attention to me and starts beefing about something he's spotted in the final. "According to Marlston's 'High Frequency Lore,' however, you've got a mighty poor LC ratio there." He frowns and peers a bit closer and I don't say anything. He pokes around a bit more and then comes up with something by a guy called Wholff who wrote a book called "Radio as I See It," after which he launches into brief quotes from three other books and then with a smug look settles down close to Dahlia. He starts to explain to her all about my QSL cards and a few other things I've never had a chance to talk about. Meanwhile, I am calling CQ and hoping I raise something good.

Needless to say, I don't. No one even answers me, a fact which inspires Keefer to a few more quotes. I keep my mouth shut as far as he is concerned, but I do give a shout to a few stations calling CQ. I raise exactly nobody.

I am pretty annoyed, especially when Keefer feels moved to say rather loudly, "Ha, ha, conditions don't seem any too good tonight, do they?"

For once I can agree with him. "Nothing is any good tonight," I retort, and I start to look over the rig. I don't think anything is wrong but you never can tell. Keefer jumps to his feet and comes right over. He pulls a neon lamp out of his vest pocket and looks as important as Don Ameche discovering the telephone. Dahlia is watching him and I wouldn't like to think that the light in her eyes is admiration.

Keefer and I both prod around the rig and I hate to think how I'd feel if he managed to find something wrong. I am exploring the final while Keefer, for reasons known only to himself, is down on his knees with his hand and head stuck inside the bottom section of my rack-and-panel style transmitter. The rig is rather generously built as far as size goes because I have dreams of some day making it into something really good and I figure I might as well have lots of room for bigger power supplies and modulators. Keefer is mumbling something a guy called Hennessy said in his book, "Effective Power Supply Design" when there is a sudden flash, a violent yell and a distinctly ominous sound as he jerks his head up and bangs it beautifully on the bottom of the unit above the power supply. Then he sort of flops forward and stays there.



Dahlia gives a startled little scream and for a moment I'm kind of excited myself. Then I realize there's not much voltage around my little rig and all Keefer has done has been to stun himself by banging his head. I'm so positive that he's not hurt that I am almost moved to say, "Ha, ha, things seem rather quiet all of a sudden." But I figure this is too much like taking advantage of the guy, so instead, I lean over to haul him to his feet.

"Darling," shrieks Dahlia, "be careful and don't get electrocuted." She looks kind of scared, like a little girl, and even a dumb character like me can see that the guy she's worrying about isn't Gilbert Keefer. I grab Keefer by the seat of his pants and haul him away from the rig. We put him in a chair and he sits there looking a bit silly and groggy.

"You saved his life," Dahlia breathes, and she looks at me in a way that really gets me. Of course I don't bother to inform her that there isn't enough voltage or current to do much to a hefty character like Keefer. After all, there are some things that a girl doesn't need to know and I figure this is one of them.

Keefer is returning to normal by now and is starting to mumble something at us. "According to Grogan's 'Practical Power Supplies,'" he begins, but Dahlia shuts him up

with a look that's colder than anything the Byrd expedition ever saw.

"According to common sense," I tell him, "it is better not to prowl around power supplies in a way that gets yourself knocked out."

What comes of all this is that I find things much more cordial between myself and Miss O'Reilly, which I discover they could of been all the time if I had not been so slow and dumb.

"After all," Dahlia tells me a couple of nights later, "what's wrong with being a service man if the guy is nice and everything?"

"It is even better," I tell her, "than a certain kind of radio engineer."

"That's what I think, too," she says, and the only reason she doesn't move closer is because it just isn't possible.

RSGB CONTESTS 1948

1. Five-meter Field Day, July 3 and 4.
2. Five-meter Contest, 2nd part, Sept. 4 and 5.
3. Low Power Contest, Sept. 20 to 25.
4. 7 Mc Contest, Nov. 27 to 28.

**For Complete Load
Matching Flexibility . . .**



B & W SERIES "3400" INDUCTORS

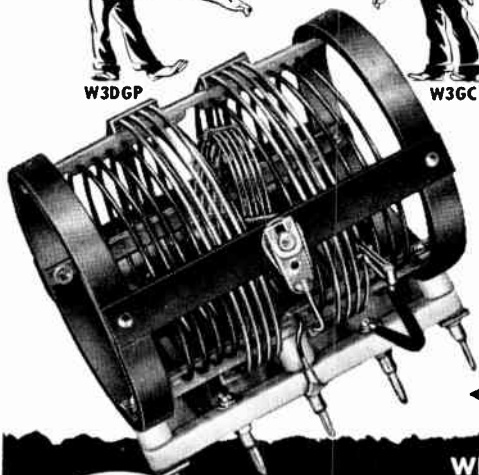

B&W Series 3400 Air Wound Inductors are for those discriminating Amateurs with medium power transmitters who want the finest that money can buy in sturdy construction and electrical flexibility. Each coil has an individual adjustable internal center coupling coil. The 40- and 80-meter coils are provided with supplemental external links in series with the adjustable internal coil for roughly adjusting the load. All Series 3400 coils will match non-reactive loads from 72 to 750 ohms . . . a feature providing ample flexibility for any rig!

◀ B & W Series 3400 Inductor—for powers up to 500 watts

B & W

WRITE FOR B & W CATALOG
BARKER & WILLIAMSON
Dept. XL68, 237 Fairfield Ave., Upper Darby, Pa.

Conodion Representative: WM. F. KELLY CO., 1207 Boy St., Toronto

NOW! A REAL DX ANTENNA AT A NEW LOW COST!

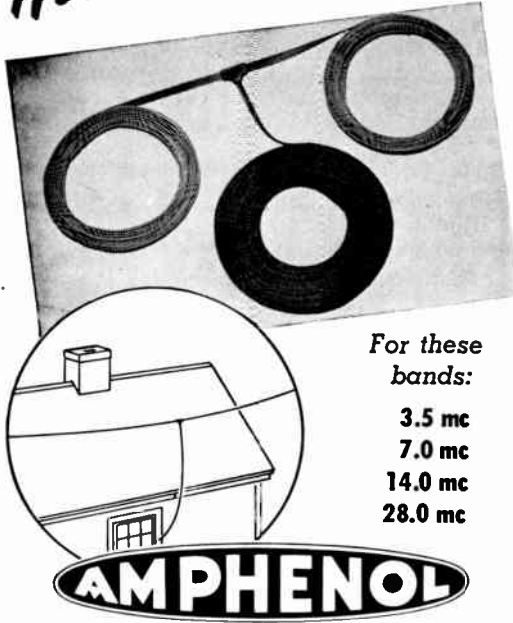

For these
bands:

3.5 mc
7.0 mc
14.0 mc
28.0 mc

AMPHENOL

TWIN-LEAD FOLDED DIPOLE AMATEUR ANTENNAS

Complete, for 28 mc Band Only \$4.63 Amateur
Net
(OTHERS IN PROPORTION)

Look to Amphenol for the new ideas in amateur radio. Now, Amphenol offers you complete packaged Twin-Lead folded dipole antennas ready-cut to your choice of four bands. Inexpensive and rugged, they offer you unusual DX, are easy to install. Simply trim to your operating frequency in accordance with instructions furnished, add end insulators and go on the air with one of the best broadband antennas ever developed.

The folded dipole antenna section is Amphenol Twin-Lead No. 14-022. Conductors are "copper-clad" steel for strength to withstand wind, ice-loading, etc. The 75-foot lead-in is Amphenol 300 ohm Twin-Lead No. 14-056. It affords a perfect match, and is joined to the antenna with a weather-proof molded polyethylene jacket.

Radio Servicemen Note!

The 7 mc antenna may be trimmed to provide top reception on the shortwave BCL 9 or 12 mc bands. See your jobber today for complete information and prices.

Amphenol Accessories Simplify Installation:

For highest efficiency, and maximum convenience, ask your jobber also for Amphenol Polyethylene Stand-off Insulators, Clear Plastic Window Pane and Silicone Compound.

AMERICAN PHENOLIC CORPORATION

1830 South 54th Avenue, Chicago 50, Illinois

COAXIAL CABLES AND CONNECTORS • INDUSTRIAL CONNECTORS, FITTINGS AND CONDUIT • ANTENNAS • RADIO COMPONENTS • PLASTICS FOR ELECTRONICS

BEAT NOTES

Word reaches CAROA that the D.O.T. net is beginning to function smoothly. We shall have further information for next issue.

Here's one for the book! On May 2, on CW, the following new Ve2 hams were heard: AEE, AEF, AEG, and AEH! The rest of the alphabet were not on hi! . . . Floyd G. Gribben, Ve2XR.

Now that Ottawa has decentralized the issuing of amateur licenses which is now being done by their branch offices across Canada, the Call Book finds it very difficult to get new QRA's and changes in old ones. If this concerns you, please write them so that you will be listed in the next edition correctly. You'll find them at the following address. Radio Amateur Call Book, 608 South Dearborn St., Chicago 5, Illinois, U.S.A.

To French speaking Ve2 amateurs. Would you like a Ve2 news column in French? Would you like to act as CAROA District Representative for Quebec's French hams? Would you like to write such a column? Do know of someone who would? The only requirements are your willingness to reliably serve your French speaking brother hams and that you are a member of CAROA. If you are interested, write Headquarters. The secretary (Ve3BWY) speaks French.

Aleck Sienkowski, W1HV, of Jewett City, Conn., tells us that it is difficult to obtain CAROA's WAVE certificate, not so much because of the difficulty of working the nine Canadian provinces on two bands, but of obtaining the necessary QSL cards from Ve's. We cannot conceive that any Canadian amateur would fail to send some sort of confirmation of a contact if asked to do so for WAVE. Has anyone else had any difficulty in getting cards from Ve's?

We learn from our D.R., Ve7FB, that the members of B.C.A.R. got together and produced a ham directory for Greater Vancouver and New Westminster, first the listing, then the call sign, the address, then the telephone number. Three companies helped in its production, the Canadian Marconi Co., Hygrade Radio Ltd., and Turner, Meakin & Co. The directory will be most useful, if one ham wishes to get another on the phone urgently, and 7FB recommends that all big cities in Ontario follow suit.

JUNK BOX TRANSMITTER CONTEST

Sponsored By

VANCOUVER AMATEUR RADIO CLUB

Date—Contest closes July 10, 1948.

Place—At clubroom, McGarvin Bakery main office, 2091 West Broadway, July 10, 8.30 p.m.

Rules—The transmitter must tune ONE of the amateur bands.

Points—Will be scored on a scale of ten, and the unit farthest removed from the manufactured article or part thereof will make the highest score.

Score—Ten points each for entering contest, neatness, home-made condensers, home-made variable condensers, home-made resistors, efficiency in output, the most unusual wire used and coils, stability of note, the most unusual construction, proof of outside QSO at least two miles.

Power—Power supply for plate voltage and filament supply for two and six volts will be provided.

Entries—Must be in by July 1, to the Activities Committee, care of Ernie Savage, 4553 West 12th Ave., Vancouver, B.C.

Judges—Mr. J. Kitchen (RI), Mr. Ed. Brooks, Mr. Jack Hings.

Prizes—First, 813; second, 805; third, parts from Hygrade Radio; fourth, parts from Taylor & Pearson; booby prize, 304-H Gammatron (never used).

QSL CARDS

The arguments for and against QSLing have been aired many times, and we are not entering into the lists of argument, but we know the majority of Canadian hams do QSL after receiving a card. This seems to us to be plain common courtesy, because the original card that was sent is surely indicative that one is needed in return.

We sometimes hear the complaint made that to send QSL's after the contests is prohibitive because of the postage bill, and it is for this very reason that QSL bureaux were formed throughout the world, for each country or call area. The QSL Bureau in the North American continent dates only from about 1937, but these forwarding agencies have existed from the earliest times of amateur radio in Europe, and very few European amateurs send their card by any other means, with a result that the QSL percentage is higher in Europe than in North America. No OZ, PA, or F, would think of sending a card direct unless particularly asked to do so, but it seems to work the other way over here, possibly because people have not tried the bureaux system, and therefore grumble at the cost of mailing.

Our advice, by long experience, is to use QSL bureaux unless asked to send a card direct, because the system really works in Canada and the U.S.A. So next time you receive a card, be sure to send one in reply.

LAMAR'S WAR SURPLUS BARGAINS

● Receiver	Type R1155	\$59.50
● Transmitters	T1154	25.00
● Trans-Receivers	GP15	50.00
● Receivers (Radar)	SW2C	85.00
● Transmitter	SW2C	85.00
● Dipole Antenna Ass'y		10.00
● Buzzer Valves		6.00
● Crystal Monitors		3.00
● Dynamotors	from	2.50
● Voltage Regulators	"	2.50
● Earphones	"	.50
● Microphones	"	.75
● Sense Units	"	.35
● Alternators	"	5.00

Also many other items and parts including, Transmitter Panels, Charging Boards complete with meters, coils, switches, rheostats, regulators, power supply units, Radar trans-receivers (IFF) units complete with tubes, etc., etc., suitable for cannibalization, all at bargain prices.

SEND FOR OUR PRICED CATALOGUE TO-DAY

... and next time you're in Montreal come browse around and get acquainted.

Special Wholesale Discounts

Prices F.O.B. Montreal

C.O.D. orders require 25% deposit.

LAMAR COMPANY

497 WELLINGTON ST.

Montreal, P.Q. - FI. 2771

Designed for



Application



90811

90811 HIGH FREQUENCY RF AMPLIFIER

The No. 90811 RF Amplifier is the same unit as used in the No. 90810 complete 2-6-10-20 meter Ham Band crystal controlled transmitter. Can be panel or base mounted. Uses 8298 or 3E29 tube with normal 75 watt output. (Higher output may be obtained by the use of forced cooling.) Provisions are made for quick band shift by means of the new 48000 series high frequency plug-in coils. Extremely compact. Chassis 4" x 7 3/4" exclusive of flanges. Over-all height 6 3/4".

JAMES MILLEN MFG. CO., INC.

MAIN OFFICE AND FACTORY
MALDEN
MASSACHUSETTS



HAM-ADS

Copy for Ham-Ads must be received before the tenth of the month preceding issue. Rate is 25 cents per line.

FOR SALE—\$40, good as new, \$115.00. J. C. Hibbs, Ve6OT, Watts, Alta.

WANTED—Two RK-23 Tubes. Can any one help Ve3HV, Box 162, Smooth Rock Falls, N. Ontario.

QSLs for discriminating hams. Distinctive! Colorful. Highest quality! \$1.50 per 100. Samples 10 cents. VE3QS Print, 344 Pape Ave., Toronto.

SELL BC-312 Rcvr 2 instr books, built in AC supply; prov. for converter. Cond. as new; ot cost—\$89.00. Ve7DY, 1614 Pinewood Ave., Victoria.

FOR SALE—Hallicrafter S-41G Receiver (AC/DC), perfect condition, includes 10-meter band. First offer \$35 takes. Ve3BSX, 257 Beatrice St., Toronto.

SELL practically new S-38, \$55.00; ship C.O.D. Require one or two 1155 receivers, one with generator. Reoson, no AC. H. A. Walker Ve5BN, Speers, Sask.

FOR SALE—U.T.C. modulation transformer S-20; B&W coil and link 20 BVL; 6 and 24-volt DC power supplies; 60 cycle recording turntable; all new. Ve3JR, 16 Reigate Rd., Toronto, MU. 5701.

NEW Silver model 701 "Atom-x", 75 watts CW, 30 watts phone, \$39.50; also new Silver model 802 "ham band" superhet, 80 to 6 meters, \$44.95. See 1948 ARRL handbook Silver Ad for dope. Write C. L. Skelding, Chateauquay Village, P.Q.

HIGH POWER Transmitter, 250TH's or 810's, etc. P-P 805 modulators, for two Hammond cabinets on special Hammond Dolly; Band-switching Exciter; separate Hammond H.D. power supplies, relay controlled, best of parts; sell complete or in units. Write for description. Also spare equipment including Tester, Gimix, speech Amplifier; BC 469-A, converted and with regulated power supply and NBFM unit; BC 459-A, new, and meters, tubes, Xtals, beam motor, etc. G. M. Arthur, 9 Cherry Street, Halifax, N.S. Ve1AX.

JAMES MILLEN MFG. CO.
INC., Products are represented in Canada by

←
ASTRAL ELECTRIC CO.
56 Wellington E., Toronto, Ont.

The Newest Thing in Ham Radio

Model "77"

AN ENTIRELY CANADIAN
DESIGNED AND BUILT PRODUCT

COMBINATION WAVEMETER MODULATION INDICATOR

Good control equipment is any Ham's dream, but when so many important control functions can be served by *one* compact instrument at a price every Ham can afford, it becomes a must.

Amateur Radio needs multi-purpose equipment and for sheer usefulness the new Model "77" is a regular "Aladdin's Lamp".

With one unit you can accurately spot your transmitter where you want it on the band, search the region between bands for harmonics and parasitics, monitor your quality, plot antenna field patterns, indicate changes in actual radiated power output, and — best of all — keep constant watch on your percentage modulation on a direct reading dial. Covers all bands up to and including 420 Megacycles.

It's the neatest thing you ever saw, accurately calibrated, precision built throughout, and represents an ingenious and typical Canadian answer to Ham Radio's oldest equipment problem.

Model 77—Size 2" x 2½" x 5¼" with coils for 10, 20, 40 and 80 meter bands \$29.50



9 FEATURES

- An accurate wavemeter band-spread for each ham band with individual hand-drawn calibration curves and a sensitive 0-75 microammeter as a resonance indicator.
- Separate plug-in coils for each of 10, 20, 40 and 80 meter bands supplied—coils for other bands available at slight extra cost.
- Additional between-band coverage available at the flip of a switch.
- Extremely sensitive field strength indicator calibrated in relative power output, for antenna adjustment and field pattern measurement.
- Push button switch for dual meter sensitivity plus provision for a plug-in antenna covers all possible field strength conditions.
- Provision for head phones for use in station monitoring and quality control.
- Finally, a direct reading Percentage Modulation Indicator, with the instrument calibrated 0-110% Modulation.
- Designed to function on the 144, 235 and 420 megacycle bands without coils, but with a quarter wave antenna section. Reads field strength and percent modulation and spots the band at these frequencies.
- Compact in size and completely shielded in an attractively finished cast aluminum case.

Bach-Simpson Limited
71 Carling St.,
London, Canada

- MICROPHONE CABLE
- RADIO ANTENNAE
- Intercommunication System Cable
- LEAD-IN WIRE
- HIGH FREQUENCY COAXIAL CABLE
- HOOK-UP WIRE
- MAGNET WIRE
- SERVICE KITS



RADIO WIRE CATALOGUE

R-46

Request a Copy Through Your Jobber

Every Type of Electrical Conductor — Steel Wire Rope
for Every Purpose



CANADA WIRE AND CABLE COMPANY