

Volume 74 Nos 1 & 2  
January/February 2006



The magazine for **AUSTRALIAN**  
radio amateurs



# Amateur Radio

\$6.50  
incl GST

## Foundation Licence

*opens doors for*



## YOUNG AMATEURS



**VK3FIRE**

**VK3FNIK**

*Inside*

- A "Simple Superhet" receiver for 80 and 40 m
- Making use of wireless LANs



# BENELEC

# YAESU

## FT-1802M



**New Release**  
**Due For Launch @**  
**Wyong Field Day**  
**19th February 2006**  
**See You There!**

### Ultra Rugged 50 W VHF FM Transceiver

- 50 Watts of Power Output
- Extended Receive: 136 - 174 MHz
- Keyboard Frequency Entry From Microphone
- Four User-Programmable "Soft" Keys on Microphone
- Illuminated Front Panel Keys for Nighttime Use
- 221 Memory Channels with Alpha-Numeric Labeling
- Eight Memory Banks for Organising Memory Channels
- Built-in CTCSS and DCS Encoder/Decoder Circuits
- Security Password Helps Prevent Unauthorised Use
- And Much More.....

The Ruggedly-built new FT-1802M brings you Yaesu's legendary mechanical toughness, along with outstanding receiver performance and crisp, clean audio that will get your message through!

Price \$ 297.50

## Ideal Foundation Licence Radio Options.....

### FT-817



Now includes FNB72 Internal Battery

- Ultra Compact 135 x 38 x 165mm
- All Mode Portable Transceiver
- 160 - 10m / 6m / 2m / 70cm
- 0.5-5 Watts Selectable

Price \$ 1,167.00

### FT-857D



Now includes DSP2 unit built-in

- Ultra Compact + All Mode Transceiver
- 160-10m / 6m / 2m / 70cm
- 100W, 100W, 50W, 20W

Price \$ 1,423.90

### FT-897D



Now includes TCX0-9 Built-in

- Portable / Mobile / Base All Mode Txr
- 160-10m / 6m / 2m / 70cm
- 100W, 100W, 50W, 20W

Price \$ 1,600.00

\* Low Power Capable!

## .....All Bands in One Box!

All Price includes GST

NSW  
Andrews Communications Systems  
Tel: 02 9636 9060 lee.andrews1@bigpond.com

Newcastle Pro Sound & Communications  
Tel: 02 4965 6899 sales@newcastleprosund.com.au

Action Communications  
Tel: 02 4732 2788 action@pnc.com.au

### Benelec Approved Amateur Transceiver Dealers

VIC  
Strictly Ham P/L  
Tel: 03 9729 7656  
vk3my@bigpond.net.au

G & C Communications  
Tel: 03 5996 3298  
gccomm@bigpond.net.au

Qld  
Kyle Communications  
Tel: 07 3857 4400  
mark@kyle.com.au

OzGear  
Tel: 07 3114 2506  
sales@ozgear.com.au

SA/NT  
Hamtronics  
Tel: 08 8342 4700  
brenton@posnav.com.au

WA  
Bushcomm Pty Ltd  
Tel: 08 9296 0496  
bushcomm@bigpond.com

[www.benelec.com.au](http://www.benelec.com.au)



# Amateur Radio

Volume 74, Numbers 1 & 2  
January/February 2006

The Journal of the Wireless  
Institute of Australia  
ISSN 0002-6859

## Editorial

Editor: Peter Freeman VK3KAI  
editor-armag@wia.org.au

Technical Editor: Peter Gibson VK3AZL

### Publications Committee Members

Brenda Edmonds VK3KT  
Ron Fisher VK3OM  
Don Jackson VK3DBB  
Evan Jarman VK3ANI  
Tom Potter VK3UBS  
Bill Roper VK3BR

### Submission of material to Amateur Radio Magazine

General and Technical articles to  
Secretary  
AR Publications Committee  
3 Tamar Court  
Mentone VIC 3194  
or armag@wia.org.au

Columns and Letters to the Editor to  
Editor  
AR Magazine  
PO Box 273  
Churchill, Vic 3842  
or  
editor-armag@wia.org.au

Hamads to  
"Hamads" Newsletters Unlimited  
PO Box 431  
Monbulk VIC 3793  
Fax 03 9756 7031  
newunltd@bigpond.net.au

Advertising  
All enquiries to  
Newsletters Unlimited  
PO Box 431  
Monbulk Vic 3793  
Phone: 03 9756 7797  
Fax: 03 9756 7031  
newunltd@bigpond.net.au

Registered Office  
10/229 Balaclava Road,  
Caulfield North VIC 3161  
Australia  
Phone: 03 9528 5962  
Fax: 03 9523 8191

## Production Deadlines

Advertising booking and articles for  
publication 10th of preceding month.

Hamads and advertising material  
deadline 18th day of preceding month

The contents of Amateur Radio are Copyright  
Wireless Institute of Australia © 2006

## GENERAL

New editor of <i>Amateur Radio</i> .....	5
Book review – "Outback radio from Flynn to Satellites" .....	18
<i>Rob Gurr VK5RG</i>	
Snapshot of amateur radio station VK3ZA .....	19
<i>John Bennett VK3ZA</i>	
A toaster oven in the radio shack? .....	24
<i>Frank Winter VK4BLF</i>	
Amateur Radio Index 2005 .....	26

## TECHNICAL

A "Simple Superhet" receiver for 80 and 40 m .....	6
<i>Drew Diamond VK3XU, Photos: Andrew Diamond</i>	
The VK5BUG "Black Stick": .....	12
<i>David 'Doc' Wescombe-Down PhD MACE VK5BUG (ex VK7CQ, VK5HP &amp; VK4CMY)</i>	
CW identification board .....	15
<i>James Cutler VK2TIM</i>	
Making use of wireless LANs .....	20
<i>Steve Fraser VK5ASF</i>	

## COLUMNS

ALARA .....	37	VK3 .....	33
AMSAT .....	38	VK5 .....	34
Awards .....	46	VK6 .....	34
Beyond our shores .....	47	VK7 .....	33
Contests .....	41	Over to you .....	31
Directory .....	56	Silent key .....	17, 32, 46, 47
DX News & Views .....	44	Spotlight on SWLing .....	36
Editorial comment .....	2	VHF/UHF – an expanding world .....	48
Hamads .....	54	WIA comment .....	3
HF predictions .....	52	WIA DXCC standings .....	45
News from .....	32	WIA news .....	4
VK2 .....	32		

## Our Cover this month

A nine-year-old girl, Janice Ampt VK3FIRE, has become the youngest person to qualify for an Australian amateur radio licence. Ten year old Nikolaas Dimitrijevic VK3FNI has also joined the ranks of those obtaining their amateur radio licence under the new entry level Foundation licence. See their stories on the inside back cover.

### Contributions to Amateur Radio

Amateur Radio is a forum for WIA members' amateur radio experiments, experiences opinions and news. Manuscripts with drawings and/or photos are always welcome and will be considered for publication. Articles on disc or email are especially welcome. The WIA cannot be responsible for loss or damage to any material. A pamphlet, How to write for Amateur Radio is available from the National Office on receipt of a stamped self-addressed envelope.

### Back Issues

Back issues are available directly from the WIA National

Office (until stocks are exhausted), at \$4.00 each (including postage within Australia) to members.

### Photostat copies

When back issues are no longer available, photocopies of articles are available to members at \$2.50 each (plus an additional \$2 for each additional issue in which the article appears).

### Disclaimer

The opinions expressed in this publication do not necessarily reflect the official view of the WIA and the WIA cannot be held responsible for incorrect information published.

## Amateur Radio Service

A radiocommunication service for the purpose of self-training, intercommunication and technical investigation carried out by amateurs; that is, by duly authorised persons interested in radio technique solely with a personal aim and without pecuniary interest.

## Wireless Institute of Australia

The world's first and oldest National Radio Society  
Founded 1910

Representing

The Australian Amateur Radio Service

Member of the  
International Amateur Radio Union

Registered Office of the WIA

10/229 Balaclava Road, Caulfield North Vic 3161

Tel: (03) 9528 5962 Fax (03) 9523 8191

email: nationaloffice@wia.org.au

http://www.wia.org.au

All mail to

PO Box 2175 Caulfield Junction VIC 3161

Business hours: 10am – 4pm weekdays

### National Office staff

Judith Oliver	Office Coordinator
Emma Trebilco	Examinations Officer
Brenda Edmonds	Office Volunteer

### Board of Directors

President	Michael Owen	VK3KI
Vice-President	Ewan Mcleod	VK4ERM
	Robert Broomhead	VK3KRB
	Glenn Dunstan	VK4DU
	Trevor Quick	VK5ATQ
	Ted Thrift	VK2ARA
	Phil Wait	VK2DKN
Secretary	Chris Jones	VK2ZDD
Treasurer	David Pilley	VK2AYD
Assistant Treasurer	Bruce Bathols	VK3UV

### Coordinators

AMSAT	Graham Ratcliff	VK5AGR
ARDF	Jack Bramham	VK3WWW
Australian ARISS	Tony Hutchison	VK5ZAI
Awards	Mai Johnson	VK6LC
Contests	Ian Godsil	VK3JS
John Moyle Memorial		
FD Manager	Denis Johnstone	VK3ZUX
Editor "AR"	Peter Freeman	VK3KAI
EMC/EMR	Gilbert Hughes	VK1GH
	Keith Malcolm	VK1ZKM
Standards	Gilbert Hughes	VK1GH
	David Wardlaw	VK3ADW
	John Bishop	VK2ZOI
	John Martin	VK3KWA
NTAC	t.b.a.	
Historian		
IARU Region 3		
Liaison Officer	Neil Penfold	VK6NE
Intruder Watch	Glenn Dunstan	VK4DU
International		
Travel Host	John Miller	VK3DJM
ITU Conference and study group	Gilbert Hughes	VK1GH
	David Wardlaw	VK3ADW
	Keith Malcolm	VK1ZKM
OSL Curator	Ken Matchett	VK3TL
QSL Manager (VK9/D)	Neil Penfold	VK6NE
Videotapes Curator	VK2 Division	
Webpage co-ordinator	Colin Thompson	VK2TRC
WICEN	John Weir	VK3ZRV

### ACA Liaison Team

Gilbert Hughes VK1GH  
Keith Malcolm VK1ZKM  
Peter Mill VK3APO  
Glenn Dunstan VK4DU

## Editorial comment

Peter Freeman VK3KAI

## From AR reader to AR editor!

Several years ago, Colwyn Low VK5UE took up the task as Editor of AR at a time when many factors were uncertain. He indicated that he would take on the task for a year or so..... It is now some five years or more later. Colwyn is finally in transition – someone else has been convinced to tackle the task. Colwyn allowed me to “look over his shoulder” as he prepared his last issue – the December edition. He is now sitting back watching from a distance. He is also forwarding material that is sent to him. I am now coming to terms with a new role: a very big change from a reader of AR to the position of Editor.

We must all recognise and appreciate the very large task that Colwyn performed. The journal of the WIA was at somewhat of a crisis point when he accepted the role as Editor. Together with the members of the Publications Committee, Colwyn gradually moved the journal onto a more even footing. Just as he became reasonably happy with the state of the journal, the WIA itself was at the beginning of an eruption. The WIA began the preparation for and then implementation of a transition from a federal organisation with only seven members (the divisions) to a truly representative national body. All of this was occurring at a time when there were

calls for substantial revision of amateur licence privileges and the introduction of a new entry-level licence to assist in a mooted resurgence of the hobby of amateur

radio. Colwyn stood the course; he saw the journal through the changes and well beyond the establishment of the new national structure of the WIA.

Some 20 or so months after the reformation of the WIA from a division-based structure to a truly national body, Colwyn is finally able to step down. I personally convey my thanks to Colwyn for the role that he has played during his term as editor.

We have seen the review of the Amateur Service by the ACA (now ACMA), the dropping of the Morse code requirement and, recently, the introduction of the

Foundation licence. We now have a tri-level service: Foundation, Standard and Advanced. It appears that the clubs, the WIA and ACMA are only just keeping up with demand for the new, simpler, entry mechanism to the Amateur Radio Service.

Some may question the new status. Many may consider that we are giving away a licence. As we saw in the December issue, our hobby was at a crossroad before the changes were implemented. Regardless of your own personal thoughts, I call upon you all to embrace the new structure and, more importantly, the new licensees as they become active.

This brings us to the state of YOUR journal – *Amateur Radio* magazine. Comments have been seen on Internet forums that certain overseas magazines are moving towards (or some would say have become) “comics”. We all face a significant challenge – how to maintain a good quality journal at the same time as having adequate content to educate our new colleagues. In addition to providing further information to our new Foundation licence holders, we need to provide information to our new Standard licensees to assist them to consider their extended privileges. On top of these considerations, we need to maintain

**We all face a significant challenge – how to maintain a good quality journal at the same time as having adequate content to educate our new colleagues.**

the interests of the many who have held licences for quite some time! After all, is not one of the key tenets of our hobby: that of self-improvement and self-education?

The challenge for us all is to provide balance in the journal for all involved in the hobby. Our hobby is diverse. This diversity cannot be represented in any single issue of a journal such as this – it will be a challenge to give balance across any given year! If you think that our balance is “off”, please help to correct it by making a positive contribution – preferably in the form of an article for publication!

I would ask all to note the new contact details for the Editor and for the Secretary of the Publications Committee.

Peter Freeman VK3KAI

## The year ahead – more change?

In the WIA comment in December 2005 Amateur Radio, I discussed the coming into effect of the new Australian amateur licence structure, particularly the introduction of the Foundation Licence, and the responses of the WIA, the clubs and many individuals to the challenges that presented.

The introduction of the new licences is only one aspect of the implementation of the ACA's (as it then was) Outcomes of the Review of Amateur Service Regulation, published in May 2004. The implementation of the other changes was delayed to enable the earliest possible introduction of the new licences.

Let me identify some of the issues that may emerge in the coming months, as ACMA continues to consider the formulation of new regulatory provisions to give effect to the Outcomes.

But first, let us remind ourselves of the stated object of the proposed changes.

They were intended to:

- update and simplify regulation of the amateur service;
- improve access to the amateur service;
- harmonise, where possible, licence conditions and qualification requirements with those of other countries; and
- maximise self-regulation within the amateur service."

The WIA has already advised ACMA that it does not agree with the retreat from the originally proposed power limits for the Standard and Advanced licences – see this month's "News".

Equally, and as a quite separate issue, the WIA, immediately on the release of the amending Determination to introduce the new licences, including the Foundation Licence, advised ACMA that it considered the 3 watt Foundation Licence power limit for CW, AM and FM unrealistic, given the availability of suitable equipment, particularly older equipment. We suggested a 10 watt power limit. We have had no response to that submission.

One issue that will be addressed is the whole question of the connection of amateur stations through the Internet,

the use of technologies such as IRLP and Echolink.

Currently the Amateur LCD permits unattended operation for an amateur repeater station, an amateur beacon station, an amateur station using automatic mode (including, for example, packet mode and radioteletype mode) or an amateur station using computer controlled mode (including, for example, packet mode and radioteletype mode), to quote the relevant provision.

One matter dealt with in the Outcomes is the issue of the removal of the restriction on the connection of an amateur station to the public telecommunication network. How interlocked that is with connection through the Internet is clear – let me extract some quotes from the Outcomes:

*Section 11 of the Amateur Determination restricts the connection of an amateur station to a public telecommunications network. The restrictions apply to automated systems where there is little direct licensee control, including an amateur repeater station, amateur beacon station, automatic mode and computer-controlled mode. ... The restrictions ... were originally put in place because, being automated, ... there is an increased risk that this may enable an inappropriately qualified amateur, in Australia or overseas, to gain access to privileges to which they are not entitled. This could also enable non-amateurs to have access ... to the Australian amateur bands. The ACA has decided to remove the current restrictions on the connection of an amateur station to the public telecommunications network. However, it will be the responsibility of the operator of an amateur station that is connected to minimise the possibility of non-amateurs gaining access to amateur bands through their station, via the network.*

The WIA is conscious of the complexities created by the existing legislation, but believes that minimum regulation is appropriate, to encourage innovation and experimentation.

Look again at the objects of the changes as identified by the authors of

the Outcomes that I quote above.

While the WIA has not adopted an inflexible policy position on these issues, our current position may be broadly stated as follows: Internet gateway nodes should be permitted to operate under either a repeater licence or a Standard or Advanced licence, with the repeater licence and unattended operation provisions of the Amateur LCD to be appropriately amended to make such use clear, the Repeater, Standard or Advanced licensee in each case to be deemed to "operate" the station and shall take responsibility for the transmission, and the licensees of the Repeater, Standard or Advanced stations providing an Internet gateway shall not allow the retransmission from a system that does not have reasonable safeguards to ensure that only qualified persons can use the system.

The WIA seeks less regulation, not more regulation, and where regulation is appropriate, simpler regulation. Quite consistent with the objects identified for the changes proposed in the Outcomes.

While it is not appropriate to revisit the fundamental policy decisions in the Outcomes, if you have a view as to how any aspect of the Outcomes can be better implemented, please let us know, by mail or better, by email to either [president@wia.org.au](mailto:president@wia.org.au) or [secretary@wia.org.au](mailto:secretary@wia.org.au).

We would appreciate your input.

The Outcomes included the following statement:

*The discussion paper offered the possibility for an amateur registration body (ARB) to manage amateur examinations, certificates and callsigns (and, if class licensing were to proceed, station location information). Examination management is currently delegated to the WIA.*

Essentially that means that the role of the WIA to manage examinations is open to review, with the possibility of what is called an ARB.

The conclusion of the Outcomes is:

*continued on page 5*

## **WIA requests ACMA to adhere to power limits proposed in Outcomes.**

In May 2004 many amateurs welcomed the proposed changed power limits for modes other than SSB that were contained in the summary to the ACA's Outcomes of the Review of Amateur Service Regulations paper. The permitted power limits specified 10 watts PEP all permitted modes for Foundation licensees, 100 watts PEP for all permitted modes for Standard licensees and 400 watts PEP all modes for Advanced licensees.

While Australian amateurs have lower power limits than amateurs in many other countries, the move to a PEP power limit for all permitted modes at least would have given Australian amateurs the same privileges as enjoyed by amateurs in the UK and New Zealand.

Last year ACMA advised the WIA that the proposal to specify transmitter output power only in terms of Peak Envelope Power would not go ahead. ACMA said that the change was due to "concerns about the potential for increased human exposure to electromagnetic radiation and increased interference resulting from what would be an effective increase in transmitter power output for some emission modes".

The WIA addressed the 3 watt power limit for AM, FM and CW specified for the Foundation Licence immediately the amending Determination was published, proposing a 10 watt limit to enable the use of readily available commercial equipment, particularly older equipment.

The WIA Board has now given careful consideration to ACMA's change of position in so far as it affects Standard and Advanced licensees, and has written to ACMA saying that the WIA believes that ACMA should not retreat from a better solution for amateurs as originally offered in the Outcomes paper.

## **New WIA DXCC Awards**

The WIA Awards Manager, Malcolm Johnson VK6LC, has announced two new DXCC Awards, replacing the old Federal Award certificates, so now there is a final and complete National WIA DXCC Awards series.

The awards are free to all WIA members, the achievement labels are at WIA cost and full details are under "Awards" on the WIA website.

## **Canadian amateurs to lose 220-222 MHz**

Barring an outpouring of "compelling arguments to the contrary", Industry Canada will reallocate the 220-222 MHz portion of 220-225 MHz from the Canadian amateur service to the mobile and fixed services. Under the provisional reallocation, which was scheduled to take effect January 25, the amateur service will be allocated the 219-220 MHz sub band on a secondary basis. Additionally, the amateur service may be permitted use of 220-222 MHz "in exceptional circumstances on a secondary basis to assist in disaster relief efforts".

## **WIA calls for comment on single letter suffix callsigns**

The WIA board has received some requests for the introduction of single letter suffix amateur callsigns (eg, VK4D, VK2A, etc). Single letter suffix callsigns with a VK prefix are currently assigned to scientific licences, and reallocation may not be possible.

On the other hand, some have argued that single letter suffix callsigns are elitist and thus not in the spirit of amateur radio. However, some 44 other countries issue these callsigns to amateur radio stations.

The WIA Board therefore seeks views on the desirability of the WIA seeking single letter suffix callsigns for Australian amateur radio stations.

## **Good news on 40 and 80 m wideband noise problem**

WIA Director and National IW Coordinator Glenn Dunstan VK4DU announced some good news on the 40 and 80 m wideband noise problem.

"ACMA advise that they have DF'd the noise to a location on the Chinese coast. They have been liaising with the Chinese Administration to have

the interference removed. The Chinese Administration has assured ACMA that action will be taken."

Glenn thanked the many amateurs who have submitted reports on this problem. He asked that reports keep coming to intruders@wia.org.au.

## **Radio pioneer remembered**

December marked the 100th anniversary of one of the most significant events in the history of amateur radio. One day in December 1905, an engineer at a receiving station based at Machrihanish in Scotland was listening in when - to his astonishment - he heard the voice of Reginald Fessenden. What made this so special was that Fessenden was at the time in North America - this was the first time that a voice transmission had been copied across the Atlantic.

Remarkably, it was purely by accident. Fessenden - a talented if eccentric Canadian scientist - had actually been talking to another station in Maryland, USA but, thanks to the wonder of propagation, his signal made its way across the Atlantic.

Thanks to the RSGB

## **Mid December sees 36 clubs offering Foundation Licence Training and Assessment**

By 14 December 2005, thirty-six clubs had advised the WIA that they are offering training and assessment for the Foundation Licence, one in the ACT, nine in NSW, seven in Victoria, seven in Queensland, eight in South Australia, two in Western Australia and two in Tasmania.

Many of the clubs listed have already commenced training and assessment and it is expected that several additional clubs will be offering training and assessment early in the New Year.

The list of clubs offering Foundation Licence training and assessment can be found on the Foundation Licence information pages on the WIA website.

ar

# New editor of Amateur Radio

**WIA President Michael Owen, VK3KI, recently announced that Peter Freeman VK3KAI had been appointed by the WIA Board Editor of Amateur Radio, following the retirement of Colwyn Low, VK5UE.**

Peter is a Lecturer in Bioscience and Biology, School of Applied Sciences & Engineering, Monash University. Since moving to the Latrobe Valley in 1987, Peter has been heavily involved in the committee of the Eastern Zone Amateur Radio Club, currently serving another term as President, and initiated in 1998 the very successful annual GippsTech Conference, and is both chair of the Organising Committee and Editor of the Proceedings.

Colwyn has been Editor of Amateur Radio since 2000, when he took over from Bill Rice, perhaps as a "fill-in" for one year. He has been trying to retire for a long time!

Michael said "In welcoming Peter and saying how delighted we are that he has accepted this very important and onerous position, we must also pay special tribute to Colwyn.

"We now live in a world where people get WIA information from different sources, the WIA broadcast, the WIA website and the WIA magazine, *Amateur Radio*. But what makes AR different

is firstly that it gets to almost every member, and what is published can be more detailed than just a 2 minute grab, and secondly, the magazine can be the source of long value technical information. We certainly hope that Peter, with his background of technical publication will bring his particular expertise for the long term benefit of amateur radio.

"I have had the privilege of attending many Publication Committee meetings with Director Ted Thrift VK2ARA, with Ted on the phone from his home near Wollongong and with Colwyn on the phone from Adelaide.

"I therefore know how much work our Publication Committee members undertake, and also, both from attending those meetings and also, as a sometime errant contributor to the magazine, how important the Editor's contribution really is.

"In particular, Colwyn has seen his role as much more than the mouthpiece of the WIA, contributing to reasonable and rational discussion. Colwyn has



Peter Freeman VK3KAI

wanted to retire well before the new Constitution was adopted, but has given the WIA in whatever form his continuing support.

"I am confident that the transfer of responsibilities from Colwyn to Peter will be orderly. Again, I thank Colwyn for his contribution to the journal," said Michael.

ar

## WIA comment continued

*The ACA has decided to proceed with the outsourcing of amateur certificates and callsign management. Outsourcing the issue of certificates is consistent with the recommendation made in the Productivity Commission's Radiocommunications Inquiry Report that the ACA delegate the conferring of certificates of proficiency for amateurs.*

It has been made clear to the WIA that its role in relation to amateur examinations is now subject to a new tender process.

Let me say this.

Whatever is the end result of the ARB proposal (a role that the WIA believes it can, and should, fulfil), the WIA firmly believes that the only acceptable outcome is for the WIA to continue to manage the amateur examinations in Australia. We shall be doing all we can to ensure that is the outcome.

So, 2006 will, again, be a year of challenge for the WIA.

ar

## WANTED Suitable cover photo for the 2007 WIA Call Book

Post to Box 2175  
Caulfield Junction 3161  
or email to: [callbook@wia.org.au](mailto:callbook@wia.org.au)

## Correction

Several errors were made in the production of the article "The VK5BR-X antennas - some modified ideas" by Lloyd Butler VK5BR. Some images are missing and some figures have incorrect captions. The editor and Publications Committee extend our apologies to Lloyd. The article will be republished in a forthcoming issue.

# A "Simple Superhet" receiver for 80 and 40 m

Drew Diamond VK3XU  
Photos: Andrew Diamond.

Some ideas are just too good to ignore. Back in 1994 I began experimenting with a scheme for a two-band receiver which had, for its inspiration, a bright idea in an old issue of QST magazine (Ref. 1).

Byron Goodman's original "SimpleX" band-imaging receiver used an IF of 1.7 MHz, and a local oscillator VFO frequency of 5.2 to 5.7 MHz, where reception of 3.5 to 4 MHz is had by  $5.2 - 1.7 = 3.5$ , and  $5.7 - 1.7 = 4$ , and reception of 6.9 to 7.4 MHz is had by  $5.2 + 1.7 = 6.9$ , and  $5.7 + 1.7 = 7.4$ , resulting in both bands tuning in the same direction. Neat but not gaudy.

Working with present-day devices and circuitry, an IF of 2 MHz was chosen (rather than 1.843 MHz, where the second BFO harmonic would put a spurious signal on 3.686 MHz) to make use of a filter made from bargain surplus crystals. Like many seemingly simple ideas, this one initially had some serious drawbacks. Firstly, conventional 2 MHz same-crystal ladder filters, although splendid for CW, were found to be too narrow for SSB. Moreover, VFO and BFO harmonics mixed to produce rather too many internal spurious signals. Strong local broadcast and TV transmitters were also getting in on the act and complicating things further.

So the project languished in the "too hard basket" for several long periods between fruitless attempts at solving these problems. 2 MHz ceramic resonators seemed to offer some promise, but their bandwidth was found to be far too wide for good CW and SSB selectivity.

Further experimental effort was applied to the crystal filter dilemma. All known circuit configurations were tested, always resulting in a band-pass too narrow for good SSB (there seems to be a "break-point" where ladders using, say, identical 3 MHz crystals yield quite acceptable SSB bandwidths, whereas it appeared to be impossible for 2 MHz crystals). Finally, a simple filter containing two parallel pairs of same-frequency crystals was tried, which gives a 6 dB bandwidth of about 1.5 kHz. Too narrow for SSB? Not at all



Photo 1 - "Simple Super" Receiver.

- recovered SSB and AM audio is good, and excellent single-signal CW reception is obtained.

Careful attention to VFO and BFO injection levels eliminated all but one of the internal spurious signals, the remaining birdie being on 3.0 MHz (or 7.0 MHz), and is equivalent to just 0.1 micro volt. Further work on the input band-pass filter has resulted in a configuration that admits only the wanted band (3 to 3.8, or 7 to 7.8 MHz).

The prototype model is what may be called a "sweet" receiver, and is a delight to use. Sensitivity is better than 0.3  $\mu\text{V}$  for 10 dB S + N:N. Reception modes are LSB, USB, CW and AM (as SSB). Rejection of the "unwanted" band is 50 dB. IF (2 MHz) rejection is 50 dB. Both bands tune in the same direction, where the 100 kHz dial calibrations align for both bands.

## Circuit

See Fig 1. Of the various LC band-pass filter configurations tried, the bottom-coupled arrangement was found, by

experiment, to provide the least insertion loss consistent with greatest rejection of out-of-band signals (strong local BC and TV/FM being the most problematic). The input is simply tuned, or "peaked", to provide reception of either 3 to 3.8, or 7 to 7.8 MHz signals.

The first mixer is a ubiquitous NE602 balanced mixer chip, where a separate VFO, adjustable from 5.0 MHz to (about) 5.8 MHz, is applied to the OSC pin 6. To produce an IF of 2 MHz,  $5 - 3$  (and  $5.8 - 3.8$ ) = 2 MHz, and  $7 - 5$  (and  $7.8 - 5.8$ ) = 2 MHz. One VFO, two bands!

After negotiating the crystal filter, the signal is presented to the input of a second NE602 as a product detector. A BFO signal at either 1.999 MHz or 2.001 MHz is applied to the oscillator port: pin 6. Rather than simply using the internal oscillators provided within the NE602, internal spur production is greatly reduced by having separate oscillator devices for VFO and BFO. It is quite difficult to "pull" a 2 MHz crystal very far from its nominal frequency, so separate optimised crystal oscillators are used to "straddle" the filter's response,





and thus obtain switch selectable USB or LSB detection, as illustrated in Fig 1.

Product-detected audio is amplified to speaker (or head-phone) level with an ordinary LM-741 and LM-386 combination. The 220 kΩ feedback resistors around the LM741 each have a parallel 1 nF capacitor to give a gradual roll-off upwards from about 5 kHz.

## Construction

My home-made aluminium case shown in Photo 1 measures 190 mm x 190 mm x 90 mm, but any similarly sized metal or plastic box would serve. The 12 V dc power supply may be internal or external, as desired. A suitable power supply circuit is included in Fig 1. All connections on the 240 V ac side of the transformer **MUST** be suitably covered to prevent accidental contact.

A suggested "paddyboard" (Ref 2) layout is depicted in Fig 2 and Photo 2, although any preferred construction style, ugly or neat, may be employed,

provided that signal-carrying wires and leads are made as short as practicable, and a "copper side up" ground-foil is used. Note the shielded wire connections for the antenna input, 10 kΩ audio potentiometer and oscillator outputs.

Main circuit board may be single or double-sided measuring 180 mm x 170 mm. The VFO is housed in a printed circuit board box measuring 80 mm x 58 mm x 50 mm LWH, made from single-sided board material soldered together, as described in Refs 3 and 4. Four brass nuts may be soldered at each corner for fixing a PC lid, in which a hole must be provided to admit a tweaking tool for the 25 pF beehive capacitor.

The four ICs are accommodated in 8-pin sockets, which, in turn, are soldered into 4-strip x 25 mm "substrates" of Vero board material, copper upwards. A single saw-cut is made down the length of the substrate to isolate the pins either side of the chip. When soldering the socket, take care that the pins do not

poke right through and risk shorting to ground foil. The substrates may be fixed to the main board with a tiny dab of super-glue, as described in Ref 2.

If you have a crystal checker and a precise frequency meter/counter, test your crystals, then select the lowest frequency unit for the 1.999 MHz BFO, and the highest one for the 2.001 BFO (my crystals had a "spread" of about 200 Hz).

Frequency coverage (for each band) is 800 kHz, so some kind of reduction drive and dial is required. Most constructors have their own ideas about dials, so just a few words about mine. An ordinary 6:1 (I would have used a 36:1 if available) planetary drive is fitted to a right-angle PC bracket (visible in Photos 2 and 3). A flexible coupler should be fitted to take up any small misalignment between capacitor spindle and drive.

A 70 mm diameter disc of opaque 3 mm Perspex is attached to the dial drive, upon which rub-on letters have

# Andrews Communications Systems

ESTABLISHED 1976

ACN 001 968 752

## ICOM DISCOUNTED

IC-756 Pro III HF+6m	\$4,999
IC-7400 HF+6m+2m	\$2,699
IC-746 Pro HF+6m+2m	\$2,699
IC-706 Mk 2G HF-70cm	\$1,499
IC-718 HF SSB	\$999
IC-910H 2m+70cm SSB	\$2,499
IC-208H 2m+70cm	\$599
IC-V8000 2m 75W	\$499
IC-T90A Triband h/h	\$499

4 Year Warranty

## ALINCO

Factory Direct Importer  
NEW DR-635T Twinbander \$699

## ICOM IC-7000



HF-70cm FLL COL. TFT DISP.  
IF DSP, Twin PBT, 508 channel  
memory and much more!

## bhi (fdi) DSP NES10-2

speaker



\$249

## NEW!

ANDREWS DUALBAND WHIPS fr	\$49
(similar Diamond). Factory Direct Importer!	
ANDREWS BATTERIES New fr.	\$10!
DIAMOND Antennas fr.	\$49!
MALDOL Antennas fr.	\$49!
COMET Antennas fr.	\$49 ea!
HUSTLER HF Antennas fr.	\$349 ea!
HIGH SIERRA HF Ant. fr.	\$499 ea!
TET-EMTRON HF Antennas.	
AVAIR ( POWER METERS, "T" LEADS, ETC.	
MFJ Antennas, Tuners, Analysers, etc.	
BENELEC RG-213/U 100m roll	\$199.
ICOM BC-143/144N/135/156	\$49 ea!

## KENWOOD DISCOUNTED

TS-570SG HF+6m+ ATU	\$1,999	TM-271A K 2m mobile	\$399
TS-480HX HF 200W+6m	\$1,999	TS-50S HF 100W	\$1,299
TS-2000 HF-70cm + ATU	\$2,999	TS-480SAT HF+6m+ ATU	\$1,899
TS-2000 HF-23cm + ATU	\$3,999	TM-G707A 2m/70cm mobile	\$499

## YAESU DISCOUNTED

FT-1000MP MkV 200W	\$3,999	FT-2800M 2m 65W	\$329
FT-1000MP MkV Field	\$3,499	FT-60R Dualband h/h	\$349
FT-7800R	\$449	FT-817ND HF-70cm Port.	\$1,049
FT-8900R Quadband	\$799	VX- 2R Tiny Dualband	\$299
FT-8800R Dualband	\$699	VX- 5R Triband H/H	\$449
FT-897D HF-70cm	\$1,399	VX- 6R Dual H/H	\$449
FT-857D HF-70cm	\$1,199	VX- 7R Deluxe H/H	\$599

YAESU ROTATORS DISCOUNTED \* 3 YEAR WARRANTY \*

Maldol and Comet Antennas Discounted!

## AMPLIFIERS

YAESU, PALOMAR, TE SYSTEMS, AMERITRON, TOPTEK, ANDREWS	
<b>ANDREWS AMATEUR BASE ANTENNAS</b>	
BF-2M2 2m 6.7dB	\$79
BF-2M3 2m 7.8dB	\$99
UVS-200 6dB/8dB	\$99
UVS-300 8.3dB/11.7dB	\$149
CBS18 5.7dB 10m	\$149

\* 3 YEAR WARRANTY \*  
Spectrum Analysers from \$1499  
Oscilloscopes from 20MHz to 100MHz

CALL (02) 9636-9060 or 9688-4301 or FAX 9688-1995

SHOP 8, 41 BATHURST ST, GREYSTANES, NSW 2145

Why pay more? MAIL ORDER TO PO BOX 240, PENDLE HILL, NSW 2145

\* <http://www.andrewscom.com.au>

\* email: [iee.andrews1@bigpond.com](mailto:iee.andrews1@bigpond.com)

E & OE  
1/06

Some items indent. Prices subject to change  
without notice - limited stock, some items.

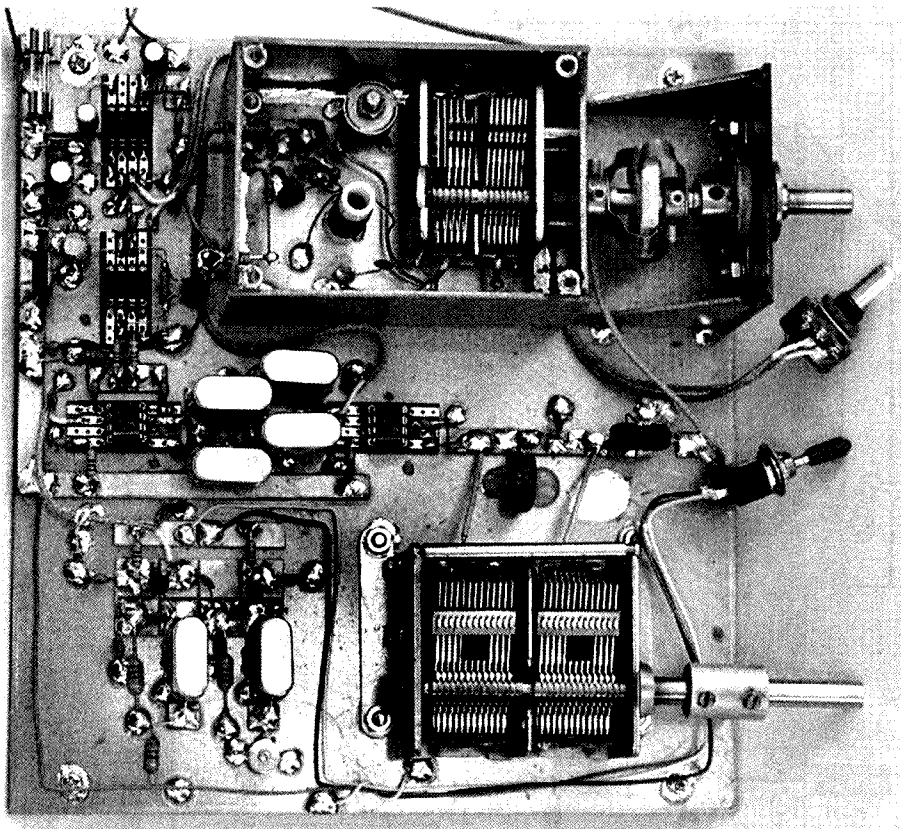

Photo 2 - Circuit board layout.

been applied (at calibration) to indicate each 100 kHz division. A similar sized disc of 3 mm clear Perspex has a single line scribed upon the inside to act as the cursor. The disc is a "nice" bung fit into an exact same size hole in the front panel. Dial calibrations may be illuminated from behind with a bright white LED, positioned such that it radiates through the opaque disc.

## Operation

Do a thorough part location and polarity check. Pay particular attention to the ICs.

With the audio potentiometer at minimum, apply 12 Vdc. You should hear just a soft hiss as the pot is advanced. Swing the input filter cap through its full range, whereupon you should perceive two distinct noise peaks, which shows that the set is "gainy" and probably working. The two input tuned circuits are slightly "over-coupled" on 3.5 MHz, and slightly under on 7 MHz, so you may find two close peaks on 3.5 MHz.

If a signal generator is

available, set it to 2.995 MHz initially at a signal level of about 1  $\mu$ V. Adjust the VFO frequency and input capacitor to obtain a signal. Now adjust the 25 pF VFO trim capacitor so that bottom 3.000 MHz band-edge is at (or near) maximum capacity (full mesh) of the VFO capacitor. The birdie on 3.0 or (7.0) MHz should be the only internally

## OzSpid Rotators

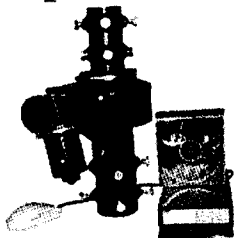

Oceania - New Zealand - Australian Distributors.

Australian Enterprise Industrial  
P.O. Box 1013

Browns Plains. QLD. 4118.

Ph. 0414 254 080.

Fax. 07 3800 8003.

aitower@spin.net.au

<http://www.spin.net.au/~aitower>



## Analizers for:

- \* 0.1-50MHz Complex impedance
- \* Antennas (140-525MHz shown)
- \* Time Domain Reflectometer (TDR)

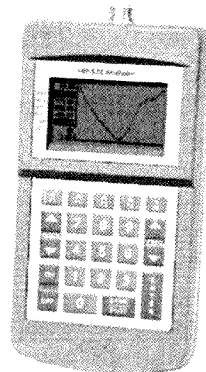

Convert your analogue transceiver  
to **DIGITAL**  
In one Easy Step!

- \* Robust OFDM modulation
- \* G4GUO open protocol
- \* Voice only or  
Voice, Data & Video

The AOR ARD 9000 series digital  
modem for HF SSB & VHF/UHF  
FM Transceivers

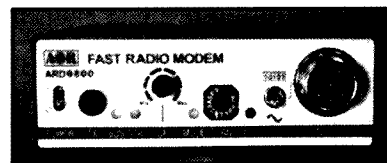

Further information from:



**Mastatek Pty Ltd**  
ABN 65 069 561 847

sales@mastatek.com.au

OR

Phone (03) 9753 4300

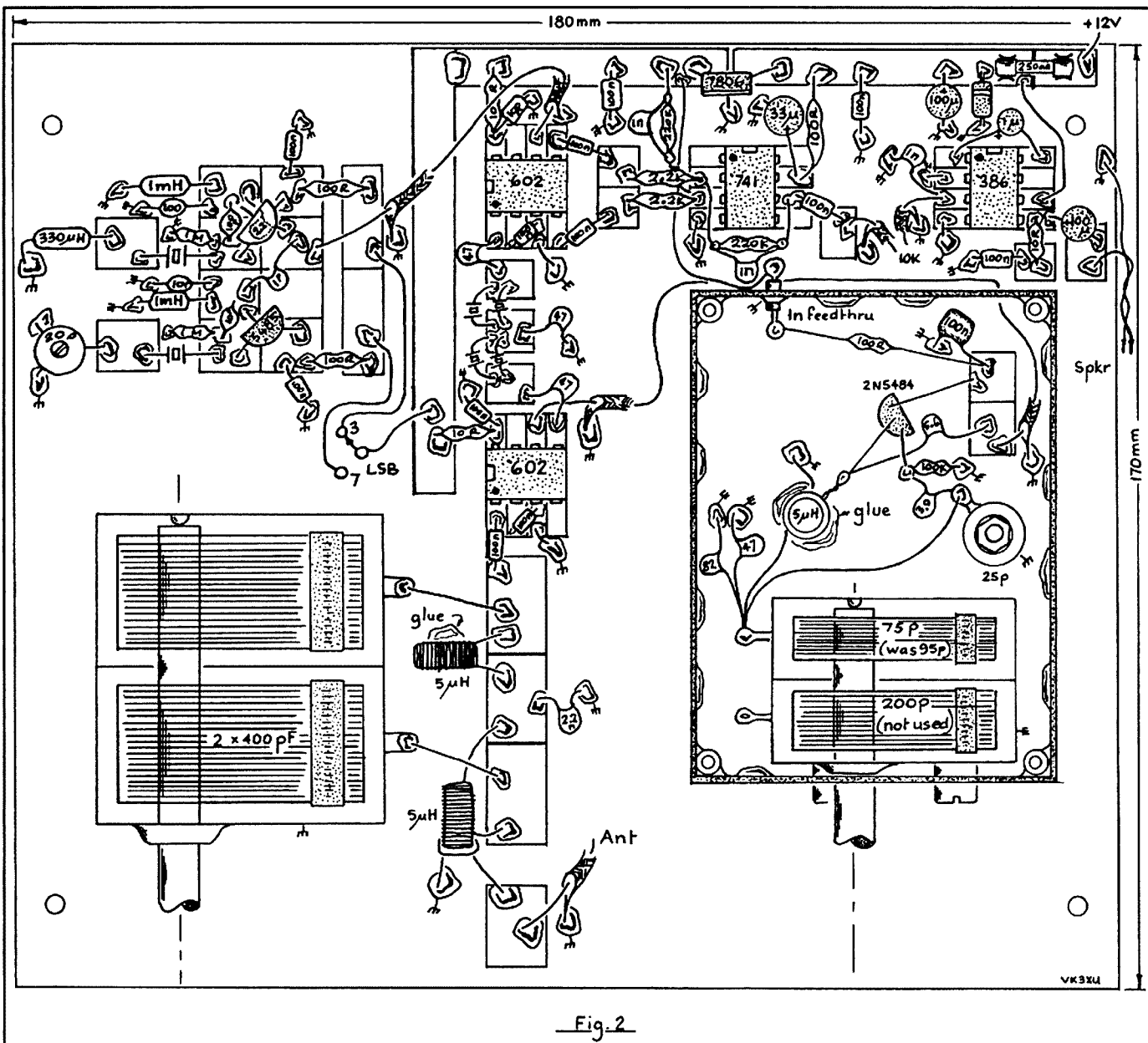

Fig. 2

Fig 2 - Suggested "paddyboard" layout for the receiver.

generated spur audible.

When the input capacitor is peaked, the received signal level should be quite strong. If your generator will go down to 0.1 µV, observe that this level is easily detectable.

With the lower sideband switch (LSB) in the 7 (MHz) position, single-signal selectivity should be very good. That is, there should be only one "beat-note" as you tune through the signal. The crystal filter's response is somewhat less than ideal where the BFO crystal lies at 1.999 MHz (about as low as it can be "pulled") to provide LSB reception on 3.5 MHz.

Connect an antenna and tune in a SSB signal. On 7 MHz, adjust the 20

pF trimmer for best sounding resolved sideband (probably near minimum capacity). On 3.5 MHz, check that LSB signals can be readily resolved.

For CW work, you may find that the "7" position of the LSB switch provides best selectivity for that mode.

### Parts

The ordinary electronic components may be purchased from our usual electronics suppliers, including Altronics, DSE, Electronic World and Jaycar. NE602s may be mail-ordered from Ocean State Electronics (<http://www.oselectronics.com/>). The 25 pF air-spaced beehive trimmer for the VFO and 1 nF feed-

through capacitor are available from Electronic World (03 9723 3860). See Hamads in Amateur Radio for your local Amidon supplier.

The variable capacitor for the VFO may be any well-made unit of about 75 or 80 pF maximum capacity (one of those excellent English Polar, dual ball-bearing, 80 pF capacitors would be ideal). An ordinary locally-made, ubiquitous MSP 95 + 200 pF capacitor must have two of the moving plates removed from the 95 pF (rear) gang to give the required value. With a hacksaw (jewellers saw) carefully cut through the phenolic insulator in two places. Apply a firm pull with long-nose pliers and

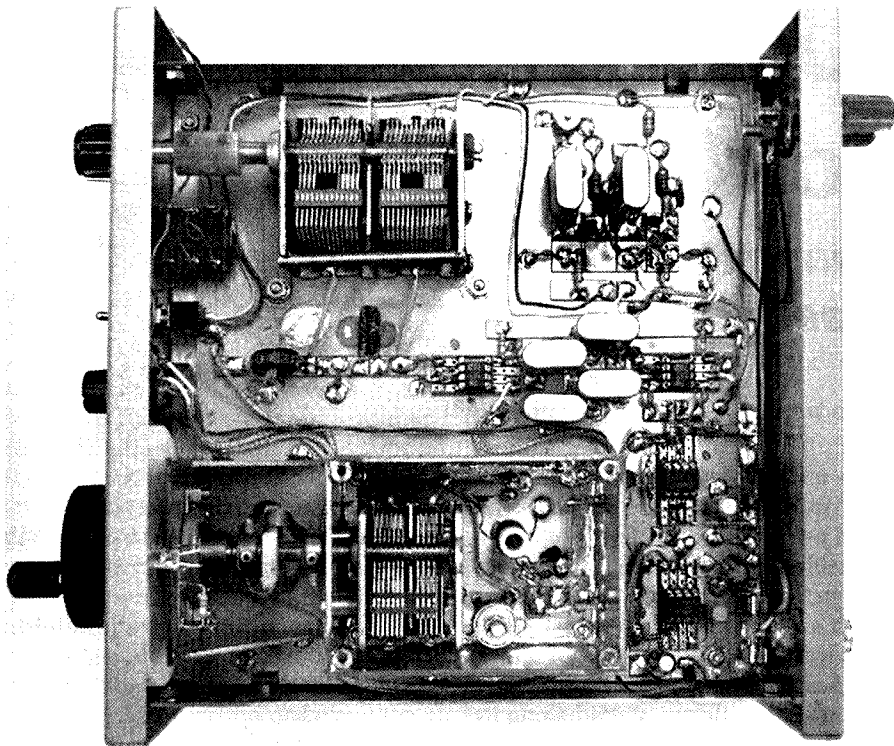

Photo 3 - Plan view.

thus singly extract two plates.

MSP capacitors and Roblan RMG-2 two-gang 415 pF capacitors are often available at ham-fest/swap-meets, etc.

For the input filter, any dual-gang of (about) 400 pF capacity will serve, but the gangs must have the same value. If you have trouble finding suitable units

locally, have a look at the Antique Electronic Supply web site at <http://www.tubesandmore.com/>

My 2 MHz crystals (P/N 10240) were purchased from Rockby Electronics (<http://www.rockby.com.au/>). Minimum quantity of crystals purchased is 10 units at a cost of 20 cents each plus postage etc. If you have genuine difficulty in locating a specific item or two, please telephone, or drop me a line (QTHR). I usually have spares on hand, or can suggest a source.

## References and Further Reading

1. "The "SimpleX Super" Receiver"; Goodman, W1DX, QST, Dec. 1958, pp 11 - 14 + 178 + 180.
2. "'Paddyboard" Circuit Construction - Revised"; Amateur Radio, May 2005.
3. "An Attenuator Set for Receiver Sensitivity Measurements"; Amateur Radio, August 1999.
4. "An Easier Way to Build PC Board Enclosures"; Kopski, K3NHI, QST, September 2003.

ar

**Healesville Amateur Radio Group Inc.**  
C/o P.O. Box 346, Healesville, Vic, 3777

**WHITE ELEPHANT**  
**VK3GH**  
**Sale**

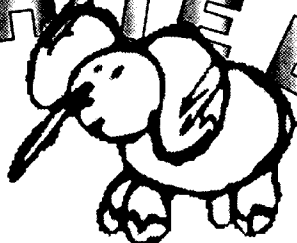

**Sales**  
of pre-loved  
Ham equipment,  
components &  
computer gear

**Sunday 26th February, 2006**  
**10am to 2pm**

**Healesville Memorial Hall**  
Maroondah Highway, Healesville

*Light refreshments  
available*

**Ample parking, \$5 entry**  
**Open to Traders at 8.30am**  
**Call in on VK3RYV - 146.725**

**For booking of trestles and further information:**

**Gavin VK3TLN 5968 8482**  
**Steve VK3TSR 0418 103 487**  
**or fax 5967 2975**

**Bring your family - you can  
also visit Healesville's famous  
tourist spots**

# The VK5BUG "Black Stick":

*a cocktail of 75 ohm transmitting twin-lead and a multi-band HF vertical aerial.*

David 'Doc' Wescombe-Down PhD MACE  
VK5BUG (ex VK7CQ, VK5HP & VK4CMY)

**No base loading – no capacity hat wires – no traps – and it works really well!**

Purists of the RF-world please be patient and accommodating: some of us want to build an aerial that works well rather than discuss the theoretical reasons why it might not! Although the recipe differs substantially from the usual mix, this home-spun vertical works really well on 80, 40, 20 & 15 metres, which are my HF bands of choice at this time. I have experimented extensively with a number of versions of this aerial since 1993 (Wescombe-Down, 1994a; 1994b) using RG58, RG213, RG8, 450 ohm TV ladder-line and 75 ohm transmitting twin-lead to feed the variants. In all cases, they have performed well for both local and DX work using low and medium power levels, but without exception, those verticals fed with 75 and 450 ohm balanced feed-lines have been better in terms of both minimum SWR and maximum output power.

I also acknowledge the similar work done by Gillespie K4TP (1978, pp. 19-20) who gave me the original idea to work with.

The setting for this current project is an inner-city suburban block with the aerial ground-mounted about three metres from a large steel workshop shed that also houses the Wireless Office (we old sea-dogs are a worry with our terminology!).

The radiator is 10.08 metres of telescoped aluminium tubing commencing with 50 mm diameter for the base section. Over the years a number of well-intentioned people have tried to assure me that conductor diameter makes no difference with HF vertical aerials as far as radiator length and/or performance is concerned, and I thank them for their input, but practical construction and operation of more than 20 such aerials has shown otherwise. I have built verticals from wire, soldered baked bean cans, metal down-pipe, TV

ribbon, ladder-line and metal tubing, from a quarter-wave length at 3.5 MHz down to a quarter-wave at 28 MHz, and in every case there has been some noticeable and measurable differences between the thin wire and 75 mm tubing used at any particular frequency.

Anyway, the base section of Black Stick has a 2.4 metre PVC storm-water pipe insulating sleeve, slotted along its entire length to allow compression by three U-bolts which secure the radiator to a three metre length of 75 by 40 mm treated pine, which in turn is bolted to a three metre length of 75 by 40 mm galvanised RHS concreted into a 600 by 600 by 600 mm concrete cube in the ground. That summarises the vertical bits! (Figure 1)

Two scrap lengths of 12 mm copper pipe, ex-bathroom renovations, were folded into L-shapes and soldered together to form a rectangle about 300 by 250 mm. This has been mounted horizontally and below the lower end of the radiator base tube section and I have soldered 24 radials to it. These are all heavy copper wire (some insulated and some not) fanned out in lengths to suit the compact surroundings and buried about 25 mm beneath the lawn and paths. The radials range from 2.4 to 20 metres long and some are not at all linear. Four counterpoises are also used: two of 10 metres and two of 20 metres, and these are woven through existing pine trellis or laid around the perimeter of the ten by four metre shed. Three 1.8 metre copper-clad earth stakes have been used: one at the aerial base and two at the shed wall where the main equipment earthing bus-bar exits the building. The areas where the stakes have been installed, is always kept wet, if not soggy. The steel shed is bonded to the system, as are two of the three neighbours' tennis court mesh

surrounds: amateurs make the most of what is at hand! (Figure 2 schematic)

Obviously one of the twin conductors in the feed-line is connected to the aerial base and the other to the copper pipe rectangle with its attached radials. The 75 ohm Belden 8222 twin-lead has been routed as directly as possible, with only one obtuse angle bend near each end and is connected to an Emtron EAT1000A matching unit for post-installation testing. The main station rig is a Ten Tec "Century 21" CW transceiver rated at 70 watts DC input, with a Yaesu FT75 (60 watts) and Oak Hills Research "Classic 2080" 5 watt QRP CW transceiver also in train. What goes on is monitored by a Heathkit SB614 station monitor and my symbiotic companion of 40 years, a Vibroplex "Champion" speed-key completes the circuit.

"To-air" results using the "Century 21" are:

Band	SWR	Watts (out)
3.5	1.1:1	40
7	1:1	45
14	1.2:1	40
21	1:1	25

all of which are as good as one could expect with the equipment used.

On air reports (VK3XU, VK3IM, et al) have been very encouraging and support the effectiveness claims attached to this quite basic aerial.

I took the time to clean and use conductive paste at every metal-metal join in the radiator; solder all connections including joins in radial wires; prepare, prime and multi-coat paint the aerial and its support structure (gloss black of course!); and replace the twin-lead with RG58 to enable immediate comparisons to be done: the coax is still in place (disconnected) buried in 12 mm garden hose routed into the shed. On test with the identical

set-up, but using the RG58, 38 watts out and 1.25:1 were the best figures that could be obtained (7 MHz). However, an acceptable match and output power level could not be achieved on 3.5 or 14 MHz, remembering that any matching unit is only trying to get a rig to look at a 50 ohm resistive load where it meets the coaxial cable.

Three polypropylene guys spaced at about 120 degrees help with aerial security and a treated pine trellis surround, with lift-out 1800 by 600 mm front section for aerial base access, has been constructed to keep grand-children and other wee-beasties away safe from the RF hot potentials.

So much for the operator's-eye view of the Black Stick, and now for some rhetoric on the theory!

Belief in such a simple aerial concept only requires some minor paradigm shifting, so pop these two in the "Baloney Barrel" at your place:

- You can't use parallel-conductor feeders with ground-mounted verticals and expect them to work well, and
- The feed-point impedance of a ground mounted vertical means you must have some kind of electrical compensation, either by loading or increased radiator length in order to achieve a decent match in multi-band use.

Of course there must be a mismatch between the feed-line and the radiator in my Black Stick, but RF loss from such a line, even if it showed an SWR of 25:1 up at 28MHz, would still be less than the loss in RG58 coax when the latter is matched!

Worth noting is that the sole purpose of the feed-line is to convey RF from the matching unit output to the aerial feed-point, including radials, as efficiently as possible. Given the very small conductor separation compared to the highest frequency of intended use, the ARRL recommendations in this regard have been complied with (1994, p. 24-1). The feed-line has also been kept as short as possible, and is less than seven metres long, in fact.

Usually with twin-lead feeders, we try to ensure each conductor "sees" the same RF pathway, and balancing the radial lengths to the radiator length is the norm. In the case of Black Stick, this is the one area of particular and intentional compromise, based on four decades

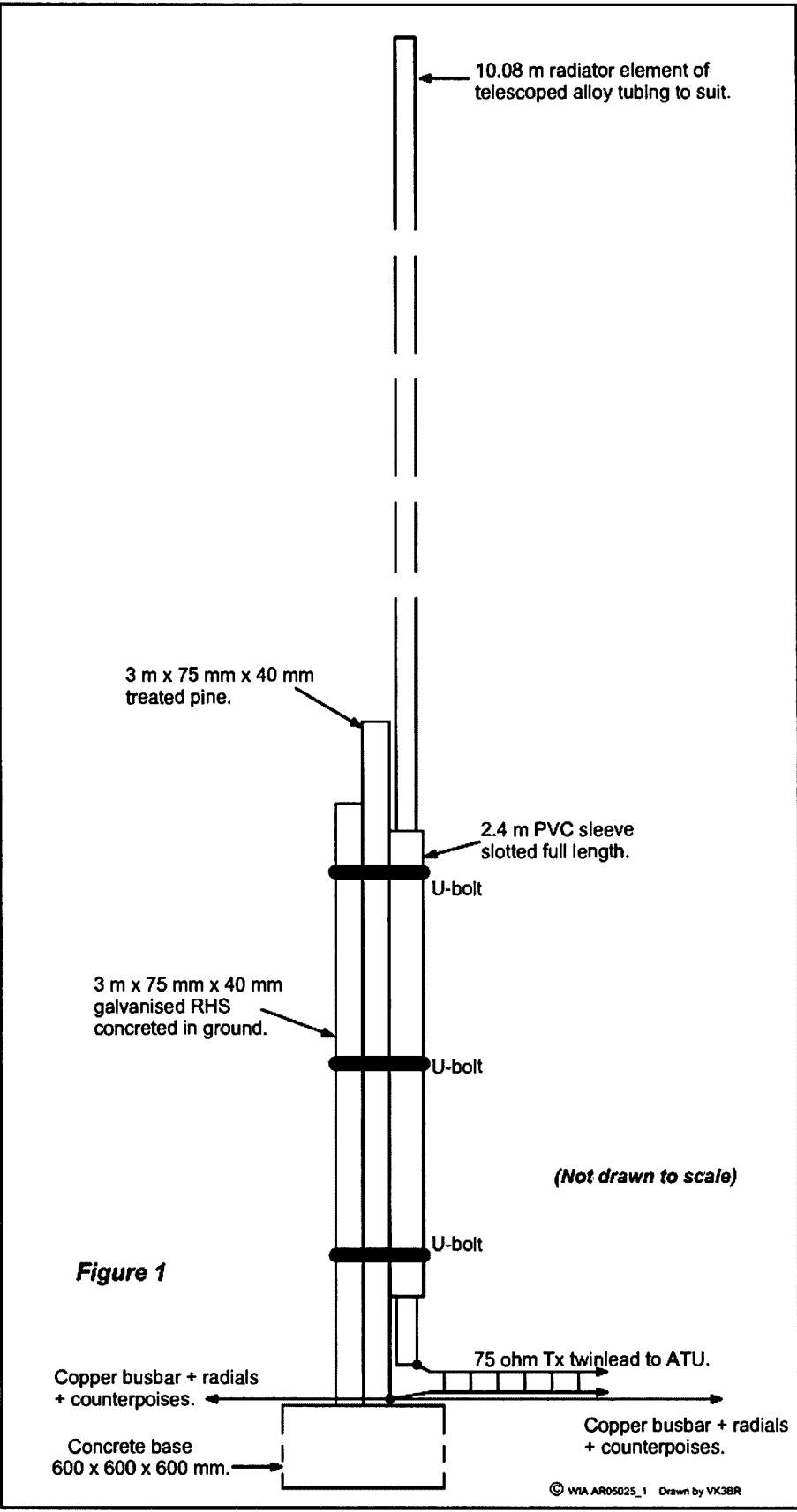

Figure 1

Figure 1

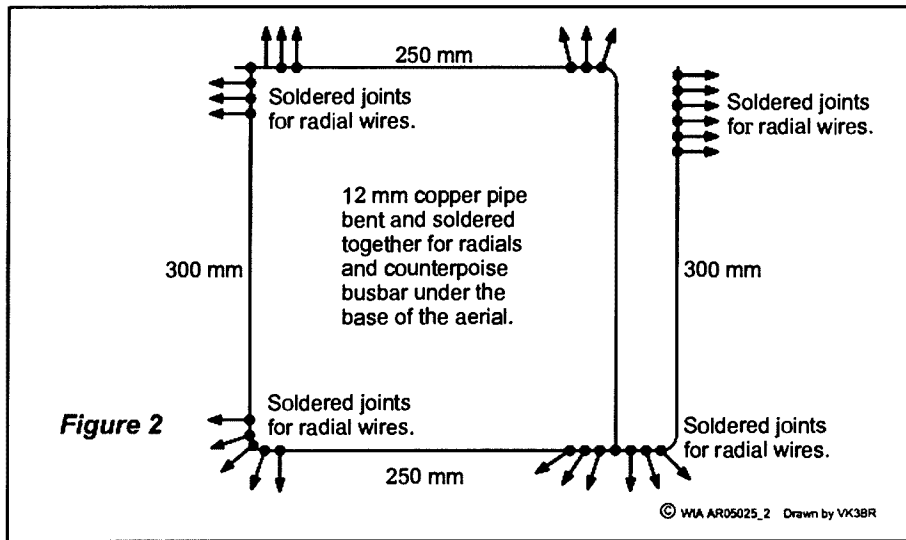

Figure 2

21", Joan VK5KYO for getting it to run so sweetly, Tim VK3IM and Drew VK3XU for their on-air feedback, Ingrid (my "Residential Contessa") for being the second pair of hands during the installation, and everyone else who has shown an interest in the concept and project.

Go ahead, throw away some of the theory and build an aerial that really works! Whatever you do in amateur radio, have fun, because we are not here for a long 'sked'.

## References

- ARRL (1994). *The ARRL Antenna Handbook*, (17th edition). Newington, CT: The American Radio Relay League.
- De Maw, D. (1988). *Novice Antenna Notebook*, (1st edition). Newington, CT: The American Radio Relay League.
- Gillespie, A. (1978). *The ARRL Antenna Anthology*. Newington, CT: The American Radio Relay League.
- Wescombe-Down, D. (1994a & 1994b). *Getting a multi-band HF vertical to go!* (three parts). Amateur Radio, January & June. Melbourne: Wireless Institute of Australia.

ar

experience of building and operating vertical aerials, in that as much effort as possible has been put into the extent of the radial system at the expense of this "balancing act". Therefore, I acknowledge that provision of ground current pathways was more important from an operational perspective than physical exactness of radials:radiator length relationships. Nothing arising from the operation of Black Stick indicates that this was a poor decision.

Transmitting-type 75 ohm twin-lead has two heavy, multi-strand conductors and a dense dielectric medium. The close spacing confines most of the RF field within the dielectric, with very little "at large" in the surrounding environment. This ensures that this type of feed-line is much less susceptible to weather influences than ribbon feeders (ARRL, 1994, p. 24-15). Velocity factors of the twin-lead and RG213 are very similar (67% versus 66%) and the capacitance of each is 19 versus 30.8 pF per foot respectively.

Wall feed-through points for balanced feed-lines need a long leakage path (ARRL, 1994, p. 24-23) and I used an insulated plate providing at least ten times the feed-line cross-section at any point where it entered the shed wall. Such feeders need to be kept away from conductive objects by at least three times their cross-sectional dimension, and bends of less than about 120 degrees are to be avoided because they will alter the characteristic impedance of any feed-line. Power reflections will occur at each bend otherwise (De Maw, 1988, p. 38).

I spent several weekends building and installing this aerial and then

burying the "radial farm", but anyone who hasn't got six children, several grand-children, lots of dependent pets, four other hobbies and full-time study commitments, could have a Black Stick up and running much quicker than that. My "Residential Contessa" prefers the gloss black finish, as do my neighbours, and it has actually grown on me too!

My thanks go to Harry W3FM for sending me the Belden twin-lead, George VK5ALS for donating the "Century

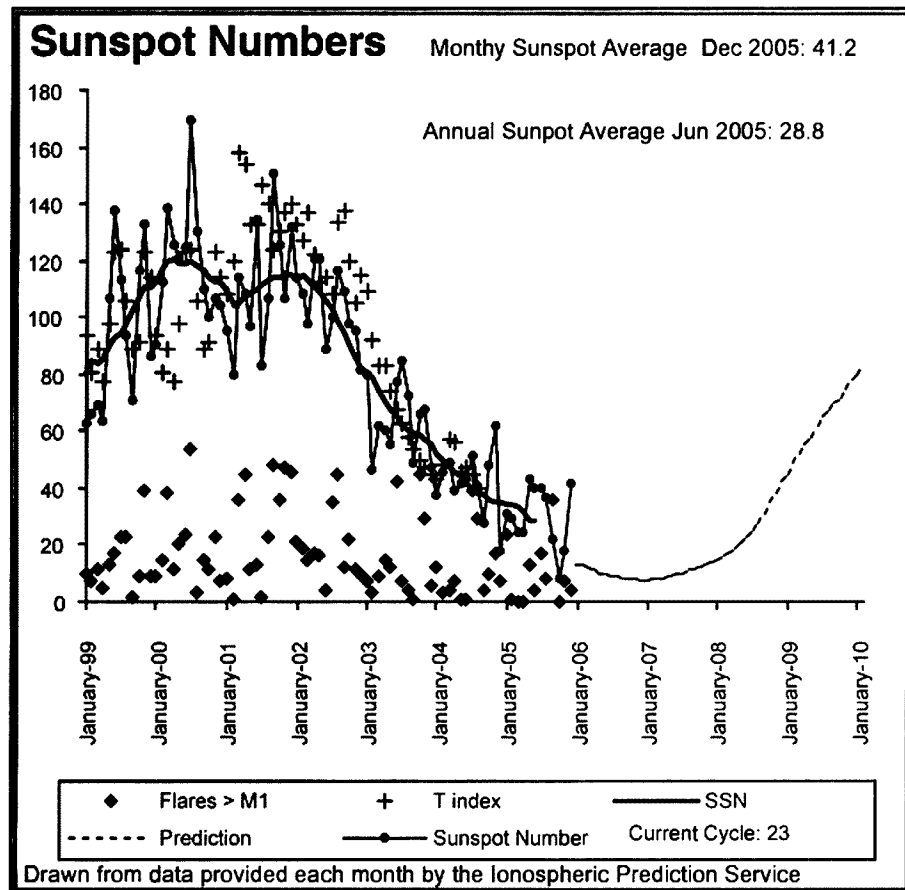





**Australian made**  
**ANTENNAS**  
*Setting a new standard*  
**COM-AN-TENA**

(formerly a j and j coman)

115 John Street  
 GLENROY 3046

23 cm 36 ele slot fed yagi beam	\$190
2 ele delta loop 10/11 metre	\$249
2 ele quad 10/11 metre	\$249
10/11 beams comp opt 5 ele	\$327
10/11 5/8 vert 4 rad 1/4 wave	\$185
Tri band IIB 35 C 10/15/20 m	\$745
3 ele 20 m comp opt	\$460
log periodic 9 ele 13 30 8.4 boom	\$990
MBV 6-12-15-17-20-40-80	\$390
40 m linear loaded 2 ele beam	\$595
M B Vert auto switch 10/80 m	\$330
6 m 7 ele yagi beam 60 mm boom	\$387
6 m 5 ele comptr opt beam	\$275
Top loaded 160 m vert	\$430
10 ele high gain 2 m 3.9 m boom	\$149
17 ele high gain 70 cm 3m boom	\$129
Rotable dipole 40 m	\$250
80 m top loaded vertical	\$239
dual band 2 m & 70 vert	\$140

**Guyed Masts**

**21 metres**      **13 metres**  
 Winch-up & tilt-over. Aluminium and stainless steel  
 three-sided construction. Auto-brake winches.

**Free Standing Masts**

9.5 metres

**New Baluns**

1-1 to 16-1 to 3kW



**03 9773 3271**  
**Mob: 0419 542 437**

the harmonics of the original square wave. The sine wave signal is then buffered and amplified by U3, an LM741 Op Amp, configured as an inverting amplifier, set up with a voltage gain of  $R9/R8 = 22k/10k = 2.2$ . This circuit yields up to roughly 1V P-P of output, with the wiper of R10 set to be closest to pin 6 (for maximum output). You can increase this output level by increasing the value of R9, but you would not want to set the gain too high, (more than say, 82k as a value of R9) as the Op Amp will clip, and you will no longer have a clean sine wave signal at the output.

**Source Code**

This code was compiled using the PICBASIC compiler, and microcode studio, both available for download on the internet. Any PIC programmer compatible with the 16F84A can be used to load the hex code onto the PIC. The EEPROM line in the source code contains the actual message information, and can be changed at will – up to 64 dits, dahs or spaces on a 16F84A,

Or up to 128 dits, dahs or spaces can be stored on a 16F628A PIC. I am happy for anyone to use the code and change the message at will, as long as credit goes to the original author.

```
*****
**      Name      : Morseidnt.bas      *
**      Author    : James Cutler       *
**      Notice    : Copyright (c) 2005 *
**               : All Rights Reserved *
**      Date      : 01/06/2005        *
**      Version  : 2.0                *
**      Notes     : Uses EEPROM within PIC to store CW *
**               : messages, so      *
**               : much less code is required.      *
*****
```

```
TRISA = %11111      'Set PORT A as
                   inputs
TRISB =             'Set PORT B as
%00000000          outputs
A VAR byte
D VAR BYTE
LET PORTB = 0
eeprom 0,[02,02,00,00,00,01,02,01,0
0,01,02,00,00,01,01,01,02,01,02,00,0
0,02,01,01,02,02]
:standby
IF PORTA.0 = 1     'Wait for button
then standby      press on PIN 0,
                   port A
:transmit
HIGH PORTB.0      'Close TX relay
gosub vk2tim
LOW PORTB.0       'Open TX relay
GOTO standby
:dit
SOUND PORTB.1,[120,05] ' DIT
```

```
PAUSE 100
return
:dah
SOUND PORTB.1,[120,20] ' DAH
PAUSE 100
return
:space
PAUSE 200         'SPACE
return
:vk2tim
'Read CW information from
EEPROM
for a = 0 to 63 step 1
read a,d
IF d = 00 then gosub dit
IF D = 01 then gosub dah
IF d = 02 then gosub space
NEXT a
return
```

ar

**John Moyle Memorial Field Day Contest 2006**  
 18 - 19 March, 2006  
*see rules page 42*

## Roy Goodwin VK5AXV

Roy passed away on 28th September 2005 at Millicent Hospital at the age of 83 years. Although inactive in recent years, he was an enthusiastic VHF/UHF operator since the mid 60s when he was first licenced as VK3ZYG in October 1966 and operated AM on 2 metres with an SCR522.



Born on April 3rd 1922, Roy lived on his parent's farm at Lillimur. He served with the army and airforce during WWII and on his return to the family farm he married Lorraine and together they had 3 daughters, Margaret, Ann and Jill.

Roy had a passion for electronics and gadgetry which led to his involvement

in the communications section of his local CFA. His ability to be level headed and think clearly in critical situations assisted him in his work as base operator. Roy was an enthusiastic member and until his death gathered weather records for their use. In 1982 Roy received the Shire of Kaniva Australia Day Citizen Award for his contribution in the area of fire communications.

Roy didn't enjoy Morse code but he didn't let it beat him so he gained his full licence, VK3AXV in October 1968.

Roy didn't like heights so this encouraged him to build two tilt over towers. These were arranged in a pair so that one tower would assist with the lowering and raising of the other. The story goes that one of his tower lift exercises resulted in his International 414 tractor being dragged backwards

with the brakes hard on while Roy clung hard to the steering wheel. "I couldn't do a thing about it" he reported to friends. Later Roy added a 44 gallon drum as a counterpoise. When more antennas were added to the towers Roy just added more water to the drum.

Roy moved to his favourite cray fishing spot, Southend near Millicent, in August 1980 where he built a new home overlooking the bay and worked the VHF/UHF DX as VK5AXV. Although he hadn't fished for crays personally for some years, he did appreciate the locals dropping a cray or two in to him on a regular basis!

Roy will be missed by his many amateur friends.

John Drew VK5DJ  
for the South East Radio Group

## We changed our name and grew, to better serve you

# Australian Radio Industries Pty. Ltd.

The RF Specialists

Formally VK Discount Cables  
We service Industrial, Commercial, Amateur & CB Radio Applications

### Specialists In

- Rg Series Coax
- Ultraflexible Coax
- Hellax Corrugated Hardlines
- Waveguides & Semi-rigid
- Hi-temp Teflon Coax
- 450 & 300 Ohm Twinfeders
- Multi-core Control Cables
- All Coax / Hardline Connectors
- Hard & Soft Drawn, Copper Wires
- Enamelled Copper Wires
- Coax Sealing Products
- Installation Accessories & Equipment
- Ceramic And Pvc Insulators
- Flat Earth Braids
- Dacron Uv Ropes
- Mobile & Fixed Antennas - Cb & Amateur
- Dipole & Wire Antennas
- Lightning Protection & Earthing
- Cable Assemblies

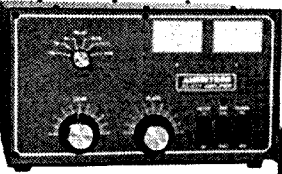

All Prices  
INCLUDE GST

ACN: 117 379 218



"Come and see us at the Wyong field day"

SUPPLIERS, IMPORTERS,  
& MANUFACTURERS

Make us your last call, as we will be your first choice on Quality, Service, Technical Advice and the best possible Price!

Visit our Website for full details of our products and service

### Hi Grade Coax Cables

- RG-213 MIL-C-17D - \$160.00 per 100m
- RG-58CU MIL-C-17D - \$55.00 per 100m
- TIMES LMR240 - \$3.40/m
- TIMES LMR400 - \$4.20/m
- TIMES LMR600 - \$9.95/m
- 1/2 inch HELIAX - \$4.95/m
- 7/8 inch HELIAX - \$9.95/m
- 300 ohm HD Ladderline - \$1.40/m
- 450 ohm Ladderline from - \$2.00/m
- (All cables in 100m, 500m or 1000m qty)
- Hi quality Patch Leads from - \$4.95ea
- 20m x RG213 terminated - \$55
- 50m x RG213 terminated - \$120
- 20m x LMR400 terminated - \$130
- Hi Power Baluns from - \$50
- 477Mhz 12dBi Fibreglass - \$245

### Australias largest MFJ Dealer

- MFJ-989D 1.5Kw Roller HD - \$649 \*NEW\*
- MFJ-986 1.5Kw Roller - \$599
- MFJ-962D 1.5Kw Roller - \$449
- MFJ-993B 300w Auto - \$479
- MFJ-994B 600w Auto - \$649
- MFJ-929B 200w Auto - \$449 \*NEW\*
- MFJ-949E 300w - \$269
- MFJ-969 300w Deluxe - \$369
- MFJ-945E 300w HF+6 - \$199
- MFJ-904H Tiny Tuner - \$269
- MFJ-267 1.5Kw Deluxe Dummy - \$289
- MFJ-250 1.5Kw Wet Dummy - \$109
- MFJ-264 1.5KwHF/VHF/UHF Dummy - \$139
- MFJ-260C 300w HF/VHF/UHF Dummy - \$78
- MFJ-269PRO 1.8-570Mhz - \$749
- MFJ-269 1.8-470Mhz - \$599
- MFJ-259B HF/VHF - \$429
- MFJ-4229 25A P/S - \$299
- MFJ-4245 45A P/S - \$369
- MFJ-655 Audio Enhancer - \$369 \*NEW\*

### Heil Microphones & Accessories

- PROSET HC4 / HC5 - \$269
- PROSET IC - \$279
- PROSET PLUS IC - \$339
- PROSET PLUS IC - \$369
- GOLDLINE GM4 & GM5 - \$269
- HM10 DUAL - \$249
- HM10/5 - \$169
- HM10/4 - \$169
- FS2 PTT FOOTSWITCH - \$85
- HS2 PTT HANDSWITCH - \$65
- TRAVELLER-ICOM - \$169
- TRAVELLER-KENWOOD - \$169
- TRAVELLER-YAESU - \$169

### DAIWA SWR/Power Meters

- DAIWA HF/VHF CN101L - \$199
- DAIWA VHF/UHF CN103L - \$199
- DAIWA HF/VHF CN801H - \$279
- DAIWA VHF/UHF CN801V - \$299

**PAY-MASTERCARD, VISA, BANKCARD**  
Disclaimer: Prices subject to change without notice.

EMAIL  
sales@arindustries.com.au

Trading Hrs: Mon - Fri 8am - 530pm, Sat - 8am - 12 noon  
Office: (02) 48 622110 BH MOBILE: 0416 099 190

WEBSITE  
www.arindustries.com.au

# **"Outback radio from Flynn to Satellites"**

**by Rodney Champness VK3UW**

Review by **Rob Gurr VK5RG** former State Manager, Department of Communications, Adelaide.

**This publication, by Rodney Champness VK3UG, is one of the best records of the history and technical development of outback radio communications an Amateur operator could read.**

It is an explanation, predominantly technical, of the need and ultimate achievement of a specialist communications system.

Many Amateur operators have been professionally involved with remote area communications, in marine, aeronautical and landbased systems. A specialist area has been outback communications, where many amateurs found employment as planners, installation staff, radio operators, servicemen and manufacturers.

There are 17 Chapters and 8 Appendices in the book. The opening chapters feature an indepth analysis of the specialist needs of outback pioneers, the technical solutions and the physical endeavours needed to overcome the many difficulties. This analysis is supported by a general technical history of the development of equipment to utilize the improved techniques and components, as they became progressively available.

A professional or amateur student would find these early chapters most valuable as an aid to understanding some essential communications fundamentals.

The latter chapters are full of technical descriptions of the equipment used over the years, including current alternatives such as Satellite, Internet, Amateur Radio (Travellers' net) etc.

Chapter 13 describes a number of other advantages afforded by the improving outback communications. The development of the "galah" sessions amongst the remote outstations with

a format similar to the later "Citizens Band Radio Service", the historical and now world famous "School of the Air", and ultimately the "Country Women's Association of the Air". These intercommunications, outside the definition of "telegram traffic" caused regulatory authorities some concern. However with the passage of time these person to person conversations became a regular part of the daily routine for most homestead owners.

The "School of the Air" gave a justified expansion to the dreary "correspondence courses" that children undertook, as they were now able to discuss daily their studies with teachers and fellow students, sometimes a thousand kilometres away. With this marvellous teaching aid, students progressed more rapidly than under the correspondence only method.

Chapter 15 held my attention specially. The reasons why the International Telecommunications Union in 1959 introduced a requirement that all High Frequency Fixed Stations should convert to Single Sideband techniques, and the technical and operational benefits of this mode are explained in clearly written detail. At this time many persons employed in the radiocommunications industry did not understand the SSB technique, and there was persistent condemnation of the need to convert to SSB. Now the changeover is 30 years behind us, there are few that can remember the difficulties of Amplitude Modulation on High Frequency.

The Appendices contain even more

enlightenment for the student. Antennas, propagation and frequency allocations, terminology and bibliography are covered in detail, and there is one appendix devoted to profiles on some of the early pioneers in this area.

Graham Pitts (VK6GF ex-VK5GE), one of these pioneers and currently living in Western Australia, came to my attention through monitoring his daily schedules with outstations on the Pt. Augusta Flying Doctor network, and later, when assisting him in the removal of television interference adjacent to the Port Augusta base. Graham wrote the "Introduction" in Rodney's book, and described briefly the extraordinary efforts required to logically determine, by questions and answers, the source of the problems at an outback station. I have heard Graham "walk" station owners through a fault analysis of their equipment, from battery supply and charging equipment, through the transceiver and on to the antenna tips. Such help to determine the source of their problems was of valuable assistance to the station owners, saving them days and sometimes weeks without communications, while the set was away undergoing repairs. There were, and still are, no maintenance people roaming the outback to call in at short notice.

The publication is A4 size, 10 mm thick, and 186 pages of technical history that has never been previously presented. It should be in every Public Library, or on your own personal bookshelf.

I recommend the book to all amateur and professional radio enthusiasts.

ar

# Snapshot of amateur radio station VK3ZA

John Bennett VK3ZA

**This station was established in western Victoria in 1982 after re-location from the shores of Port Phillip Bay and from Western Port Bay, Victoria.**

The installed equipment was capable of receiving radio signals with continuous coverage over the range 2 kHz to 6 GHz.

Several Marine bands were continuously monitored; for example, 500 kHz, 2, 4 and 6 MHz., with an Auto Alarm facility on 500 kHz.

Various wire antennas were employed with wide-ranging capability to connect to and between items of equipment; filters, Wide Band Amplifiers, Down Converters, counters etc, through coaxial RF patch panels and cords. All the coax connections within the shack utilized 50 ohm RG223 double-screened cable. Balanced feed lines were used with some antennas, including the Beverage VLF, and the lines ran in the ceiling of the room, between the balanced switching and patch panel at the Operating Position and the equipment racks at the opposite end of the room.

Six different VHF/UHF antennas were mounted on a triangular lattice mast on the roof of the Shack.

In the UHF/Microwave region, a radome-enclosed dish allowed continuous coverage from around 450 MHz to 6.0 GHz with several different feeds and LNA/LNB combinations. The dish, mounted on a gyro-stabilised base, gave an aiming accuracy of 0.18 degrees in both azimuth and elevation.

The base Intermediate Frequency 'patched around' the installation for most activity, other than amateur operation, was 70.0 MHz. Frequency synthesisers and mixers allowed adjustment of the injection frequency to maintain the 70 MHz IF over the range 0.1 Hz to 15.0 MHz

In addition to operating on most of the HF ham bands, the station, using Military callsigns and frequencies, acted as Base Station for a number of Australian Army adventure training and other exercises, including Special Forces, which took place in remote parts of Australia and in New Zealand; as well as activities in South East Asia.

While some of the station equipment was of a commercial/military nature, much of the gear was 'home-brew' or modified to suit the needs of specific projects

The station was dismantled in late 2001 to be re-located to a low-noise area in north eastern Victoria.

*(Lt Col John McL Bennett [Retd] was involved with the communications industry, particularly Amalgamated Wireless Australasia Limited (AWA) and the Australian Army from June 1950 to April 1987. In 1954, he was one of the*

*two senior engineers responsible for installation and commissioning of all the communications facilities at Avalon Airfield, near Geelong, Victoria, which was built as the home of the Australian Government Aircraft Factories. Since then, he has spent almost as much time working outside Australia as at home. He obtained his Commercial Radio Operators Certificate in 1950 and has held several amateur call signs in Australia, the Pacific Islands and Asia.)*

ar



Photo 1 - VK3ZA operating position



Photo 2 - VK3ZA satellite equipment racks

# Making use of wireless LANs

Steve Fraser VK5ASF

There are many articles available, on both the Internet and in print, about wireless LANs (Local Area Networks). However, few go beyond antennas and basic connections. Even fewer deal with ways in which amateur radio operators can make use of the facilities. This article will attempt to remedy that situation.

## Defining moments

A wireless LAN is a connection of computers, linked by radio, making use of a technical standard called 802.11. There are several variants of this standard, each having different frequencies and performance. The most common is 802.11b, which provides an 11 Mbit/sec raw data rate, using the 2.4 GHz band. That's around 10,000 times faster than the most common packet radio setup. It uses ISM bands, which overlap amateur allocations at this frequency.

The protocol used is TCP/IP. That has been available for many years on packet radio, but has never been particularly popular, mainly because it was complex to set up and never inter-operated well when on the same channel as normal AX.25. However, TCP/IP is what

operates the Internet, so it is clearly both capable of good performance and able to be used by non-technical people.

The 2.4 GHz band used is well into the microwave spectrum, and hence needs "line of sight" connections – no ionospheric bouncing for DX here! Each station must be able to see another station to which it connects. In practice, this means that large numbers of nodes or access points are required in order to provide widespread coverage.

## The correct form of address

Each computer on a TCP/IP network is identified by a unique address, called an IP number. That number is allocated to you by the station to which you connect (or "associate" in 802.11 terminology). It takes the form of four numbers, separated by dots, such as 10.107.0.37 – and no-one else in your network should use that number at the same time as you. And each system in the network knows how to get messages to that address. We call that "fully routed". It means that regardless of where you connect, you can communicate with everywhere else.

## Seems like hard work

When the South Australian Packet Users Group (SAPUG) looked at this technology a few years back, we realised that implementing a widespread, fully routed digital network

across the Adelaide metropolitan area was far beyond our resources – it'd be like building fifteen or twenty repeaters! The cost, and the manpower required, was just prohibitive.

The concept languished until we teamed up with a group called Air-Stream, who were assembling such a network for general community use. Amateurs certainly qualified as that. The Air-Stream network was very small at that stage, but we could see the potential, so we signed an agreement to pool resources and share each other's infrastructure. Since then, we have implemented several access points into the network, which itself has grown to cover a substantial portion of the Adelaide area. VK5 amateurs now have access to an 11 MBit network, over which they can carry traffic. See <http://www.air-stream.org/> for more details about Air-Stream.

## So what does it do?

Each station on the network has a unique IP number. So if VK5ASF wishes to connect to the VK5SPG BBS, he needs to know his own IP number on the network, and that of VK5SPG. As long as his software is TCP/IP capable, then he can connect. With WinPack, for example, you can use IP numbers instead of call-signs (in connect scripts) and so can connect to a BBS and download messages much faster than via conventional packet. The WinPack software takes care of the TCP/IP connection, and the network takes care of getting those TCP/IP packets to the correct location. The user just sees a much faster connection – the commands, display, and results are identical.

Of course, just reading bulletins faster may not justify the effort involved. But a much faster connection makes many functions that are just not viable at 1200 baud (conventional packet) possible.



Photo 1 – A Linksys "data transceiver" with removable antennas which are replaced by an external antenna for wireless LAN use.

As long as a route exists between two stations (because of their IP numbers) then all sorts of existing software will work over that link.

## What else is possible?

Let's have a look at a few other functions that are also possible, without getting too bogged down in "how" they are done – that's probably a subject for quite a few future articles!

The first is AXIP. Under AXIP, conventional AX.25 packets are forwarded over an IP link, and hence take advantage of its speed. As long as the Operating System on your PC supports AXIP, the existing AX.25 packet programs will run unchanged. For Linux users, the ax25ipd package does this beautifully. For Windows users, it can be done with BPQ (the 32 bit version). Any packet program that uses these interfaces can be used over the wireless LAN.

Another function is DXCluster. The VK5 network uses the wireless LAN to carry the DXCluster traffic from the wormhole where it arrives, to VK5SPG. Users on any of the conventional RF ports on 2 m and 70 cm can then make use of the DXCluster. This is a good example of software written for AX.25 operating unchanged over AXIP.

APRS traffic could be carried from one APRS node to another over the wireless LAN. Sharing APRS on channels with other AX.25 traffic is problematical

and generally unsatisfactory, due to its volume and data rates. A wireless LAN connection can easily accommodate this.

Voice Over IP is a technology whereby audio (and even video!) is carried over fast digital links. Examples are IRLP, Echolink, Skype, etc. Many of these can be carried over a wireless LAN to link repeaters, chat, or convey information.

You could even transport the Sunday morning broadcast over the wireless network! That just isn't possible over conventional packet links.

Messaging forwarding, using standard AX.25 protocols, can also be done. FBB, JNOS, etc can all use standard connection techniques (with AXIP) or can use direct TCP to forward messages. Where a number of BBSs exist within a metropolitan area, this can remove forwarding from user ports, benefiting even non-wireless-LAN connected users,

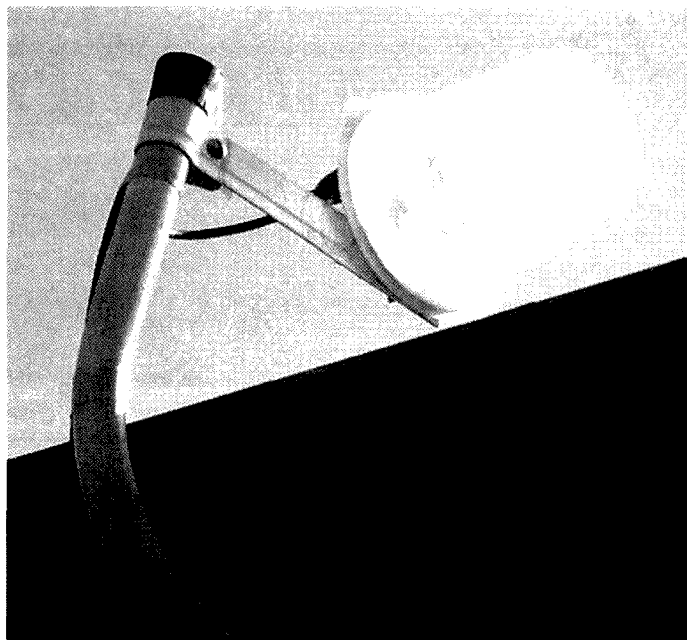

Photo 2 – A simple helix antenna is sufficient if you have a good location!

by reducing congestion. It also makes it far easier to forward messages such as 7+ with large numbers of parts.

Tunnelling is a technique whereby traffic for one network is carried by another. In our case, amateurs have a network using IP numbers starting with 44, called AmprNet. Most wormholes worldwide are connected to this, as well as BBSs, DXClusters, Converse servers, etc. It's quite possible to tunnel a connection from an amateur's home PC to a nearby wormhole, using a wireless LAN as the underlying transport, and hence enabling each amateur to have full connectivity to all parts of the AmprNet and the facilities it offers.

Finally, software libraries can be established. With Windows, the file

Photo 4 – The VK5SPG mast, showing the wireless LAN collinear and dish below the 2 m and 70 cm antennas.

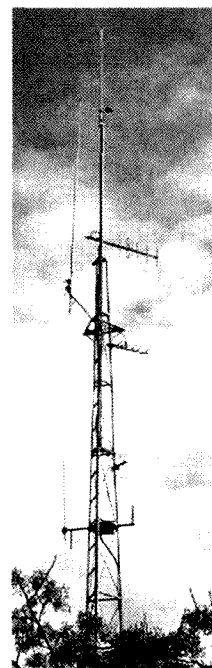

Photo 4 – The VK5SPG mast, showing the wireless LAN collinear and dish below the 2 m and 70 cm antennas.

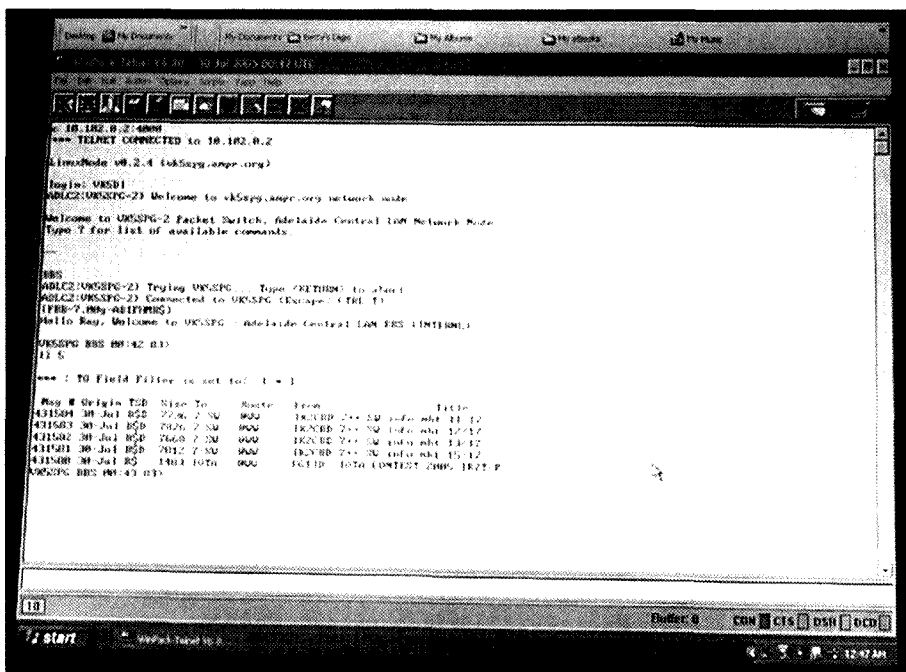
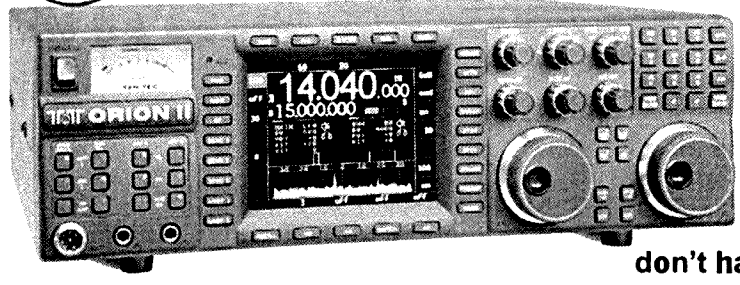



Photo 3 – WinPack being used to connect to VK5SPG.



**TTS will be at Wyong with a truck load of systems !!**



# Orion II

**First public display in Australia**  
 Shipped in the US only a month ago and already reviewers claim it to be among the best of the high end transceivers.  
 See ORION II at Wyong and see  don't have to miss.



# Argonaut V

**All Mode QRP HF Transceiver**  
 The ideal foundation licence rig

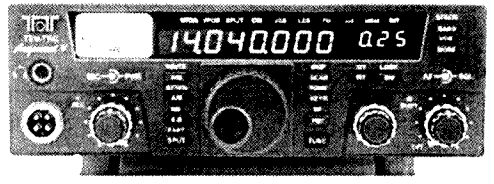

## SGC 237 Smart-Tuner

Our most popular mobile auto tuner lives up to its name

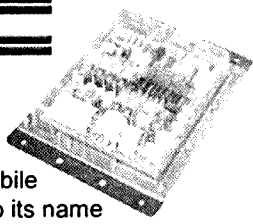

## SGC ADSP2

**Noise Reduction Speaker**  
 Little noise but the reviews are shouting about it.

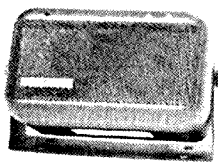

## Buddipole

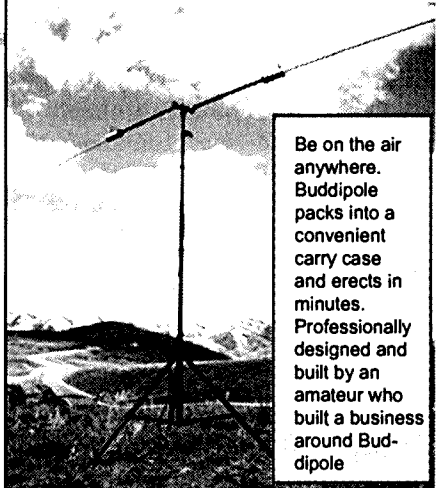

Be on the air anywhere. Buddipole packs into a convenient carry case and erects in minutes. Professionally designed and built by an amateur who built a business around Buddipole

Tune in with the



range of antenna management equipment

## Z11pro Autotuner (NEW)

## AT 1000 High Power Auto tuner

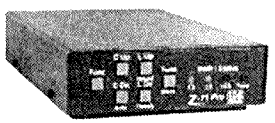

## AT 200pro Auto Tuner (NEW)

## DTS-4 Desktop Coax Switch

with optional remote control

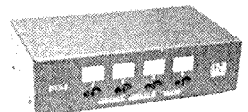
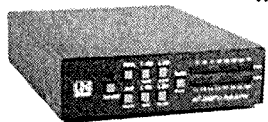

## Autek WM1

Computing Watt Meter  
 QRP to 2KW

## VNA Network Analyser

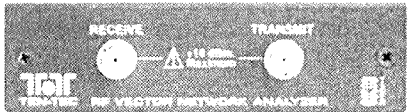

 For those serious about antenna and RF network measurements

**Come and chew the rag and get some hands-on at Wyong. Not Going? Then call us for full info or visit our website.**



# TTS Systems Communications Equipment

[www.ttssystems.com.au](http://www.ttssystems.com.au)

**FREE CATALOGUE**

**HF and VHF Transceivers, Autotuners and Kits**

**Phone 03 5977 4808. Fax 03 5977 4801 [info@ttssystems.com.au](mailto:info@ttssystems.com.au)**



sizes involved have made this quite impractical – very few people are happy to do a download that takes twelve hours over packet! With a wireless LAN connection, that can shrink to just seconds. It can even be setup so that users can just “drag and drop” to download the file.

## How to get started

Both the amateur and the server being accessed need to be able to communicate over the wireless LAN. Before purchasing equipment, it's a good idea to have someone who already has gear to do a “site survey” – to monitor just what sites can be contacted. Air-Stream did this for SAPUG, but any group setting up a wireless LAN would probably have access to suitable equipment.

The “line of sight” needed by these signals can be deceiving, so results are not always what is expected. Some apparently good sites can be very bad for operation – and vice versa! So a real

live test is a good idea.

Once a suitable connection site is identified, then the technical connection settings can be provided to you by the operator of the site. These must be adhered to in order that you can communicate with the entire network reliably – they include IP numbers, subnet masks, DNS servers etc. (If you don't understand all these, you'll soon learn once you start setting up your site!)

Finally, a BBS can start to implement the new features, such as those described above – or any others that people devise. There's a huge range of things that could be done to make packet more interesting, more exciting, and more viable, and more interesting to new-comers. A high speed connection is just the starting point.

## Summary

There are substantial potential benefits

to the amateur community from a high speed network. The RF side is just one part – amateurs also need to come to grips with digital networking techniques and standards. So there is a learning curve ahead – but also a bright and exciting future if we seize it.

www.pca.cc  
 Email from anywhere  
 via Winlink  
 2000  
 Use PACTOR-3  
 on HF to send  
 Mail, Grib Weather,  
 Weatherfax & Images  
 Contact marc@pca.cc  
 Sydney 02 8902 0107

**WIA  
 Foundation Manual  
 In Stock Now!**

Visit us at  
**www.gccomm.com.au**  
 for new product updates!

**G&C**

# COMMUNICATIONS

Authorised dealer for Icom YAESU Kenwood Barrett RFDS GME Electrophone Uniden

**See us for CAR Stereo too! ~ 'Cranbourne Car Sound'**

**NEW ICOM IC-7000 HF~70cm  
 Aust. Icom Release soon!**

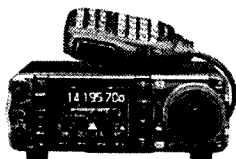

**GME UHF &  
 MARINE**

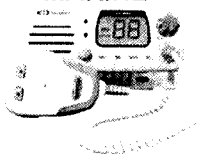

**MFJ Enterprises  
 Tuners / ETC**



**GARMIN NAVIGATION**

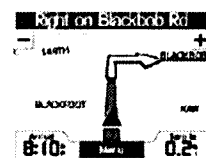

**YAESU  
 VX-6R**

**Call us for a great deal on  
 all transceivers, rotators, antennas, tuners,  
 power supplies, car entertainment,  
 two way and GPS-related products**

**KENWOOD TS-480 SAT**



**CAR CD/MP3/DVD  
 STEREO**

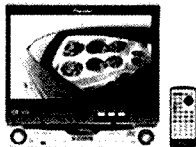

**GPS**



**NEW FTDX-9000 Elite  
 200Watt HF**

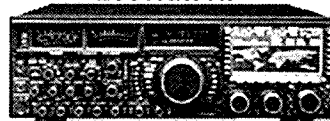

**Proudly Supporting  
 Australian Business**

**207 High St. Cranbourne VIC 3977  
 Ph: 03 5996 3298 Fax: 03 5995 0184**

**Email: gccomm@bigpond.net.au  
 www.gccomm.com.au**

# A toaster oven in the radio shack?

Frank Winter VK4BLF

More and more amateur radio projects are using SMD (Surface Mounted Devices) in their designs. The advantages are fewer parasitics in RF sections and, of course, denser construction methods. A project that might have been the size of a house brick can now be mounted in a little zippy box.

## So what does that have to do with a toaster oven?

The problem with SMD devices is that conventional soldering techniques are difficult to use. The resistors, capacitors and ICs are tiny and, unless you are very careful, they either go up in smoke or attach themselves to the iron. This makes it hard to solder them to the PCB. Professional service people use expensive hot air pencils that avoid direct mechanical contact with the chip. This works but unless you can control the airflow or glue the chips to the PCB, the component can literally blow away to be lost forever.

Another way of soldering SMD components is to use a Reflow Oven, which is basically a box which heats and cools PCBs and their components in a controlled way. Manufacturers of SMD devices provide ideal Temperature Profiles for use in Reflow Ovens to make satisfactory solder joints. These profiles are readily available from manufacturers.

If temperature profiles can be

reproduced without spending thousand of dollars, the task of soldering many of these tiny components is possible for the radio amateur. Well, it turns out that a readily available toaster oven can do that quite simply. Its insulation and heating characteristics make it easy to produce the required temperature profile. And all that for just under \$30! Lucky, isn't it. (see Photo 1)

At the time of writing, department stores sell them under the brand name of Mistral (Mistral International Pty Ltd, 324 Frankston-Dandenong Rd, Dandenong South, Vic 3175 Tel 1300 363 907). It has two 650 W ceramic heating elements in series and also features automatic temperature control. This latter feature is not necessary for re-flow soldering but comes in handy when

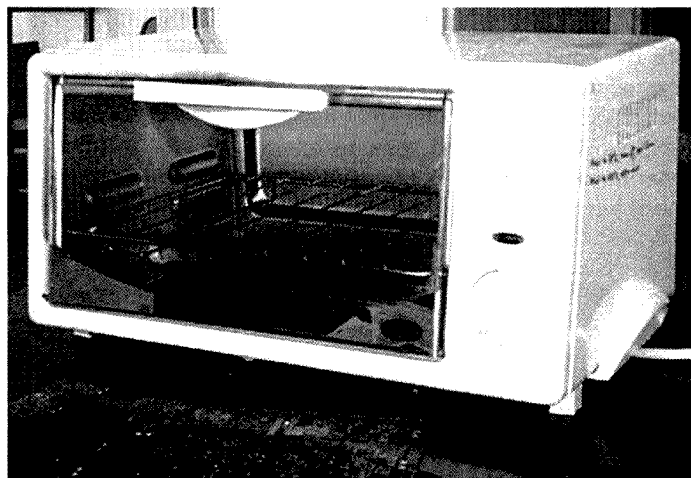

Photo 1 - Mistral toaster oven.

you re-heat a pizza. This heater has the important characteristics of thermal insulation and high power, all in a small box. Other brands may well be suitable for use as Reflow Ovens as well.

So how does it work? To start, apply solder paste (now readily available from major electronics stores) to the copper pads – a little dab will do. Next, place the components on the board and make sure they are in the right position. On a dense board this can take a while but there is no need to hurry, the solder paste remains workable for about 10 hours before it dries. When all the SMD components are placed, put the board in the oven. The natural adhesion of the solder paste is enough to keep them in place, so long as the board is handled carefully.

To begin the soldering procedure turn the oven to full and wait until the temperature reaches 80 C then turn the oven off. The temperature will continue to rise to about 100 C. Leave it at that temperature for about two minutes. This part of the procedure is called soaking, and it is necessary to reduce thermal stress between metals and plastics in the components for the next step. It also dries the solder paste and releases solvents from the paste.

Next, turn the oven on to full and

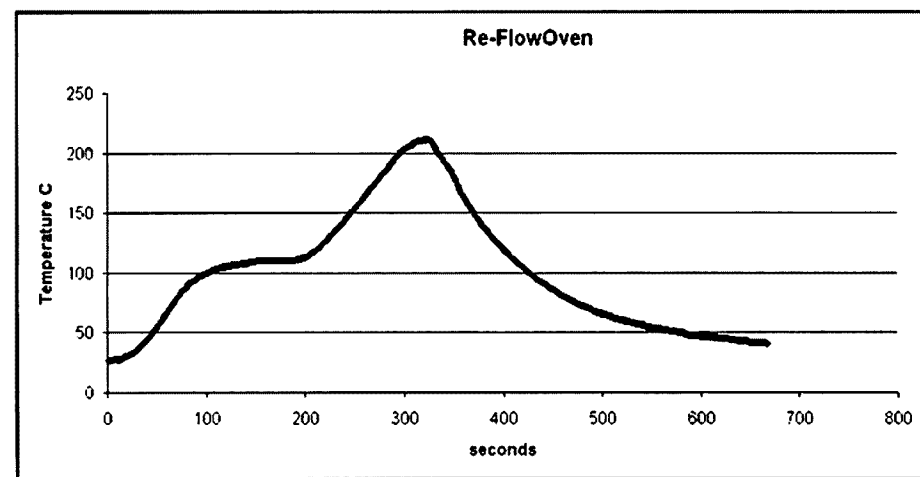

Photo 2 - Measured toaster oven temperature profile.

carefully watch the temperature. When it reaches about 140 C you can see the solder paste melting and sucking itself into the joints. Let the temperature continue to rise to about 180 C to complete the reflow step. When that temperature is reached, immediately turn the oven off and open the door fully. Leave the board in the oven so it cools down slowly.

This procedure produces almost the ideal temperature profile recommended by most component makers. It is however wise to check with manufacturers on the internet before you reflow any rare components. With practice comes experience and you will be able to tell which components need special treatment. The temperature profile (see Photo 2) displays the profile produced by the procedure just described. It was recorded in one second intervals with a digital multimeter connected to a computer and a thermocouple to measure temperature.

I have been interested in using SMDs for some time but the impetus to do something about soldering them came with the formation of a small SCARC group to build "Scotty's Spectrum Analyzer". A large number of components use SMD format and a way of soldering the boards easily and surely had to be found. The toaster oven is just perfect for this. Initially, people could not believe it was so simple - surely there must be some catch. To dispel these doubts I decided to demonstrate my "new soldering iron" to some SCARC members at one of our Sunday meetings (see Photo 3). Everybody was most impressed, so much so that three SCARC amateurs bought their own oven.

I can't claim that I came up with the idea. Using a toaster oven with an expensive temperature controller has been around for some time on the internet, but it really works without any elaborate control other than human input.

The whole procedure takes less than five minutes once you have spent hours placing the tiny SMD chips. The solder method described here makes building ham radio projects with surface mounted devices quite possible, given care and a little practice. In particular UHF and SHF devices benefit from using this construction technique.



Photo 3 - Frank Winter VK4BLF demonstrating the SMD soldering oven to club members at the Sunshine Coast Amateur Radio Club. From left to right, Harry VK4TK, Chris VK4UTT, Frank, Kevin VK4WOT and Jim VK4UAV

**Presented by the Central Coast Amateur Radio Club**

for

**CENTRAL COAST**

**FIELD DAY**

**WYONG**

Admission (Gates open 8:30)

General \$10

Children U/12 Free

Flea Market

Setup (+ entry fee for each person) \$25

Trestle (each if required) \$25

**SUNDAY 19TH FEB 2006**

**DON'T MISS THE BIGGEST FIELD DAY & HAMFEST IN THE SOUTHERN HEMISPHERE!**

*Since 1957 by*

**THE CENTRAL COAST AMATEUR RADIO CLUB INC.**

For further information **CCARC Field Day,**  
**PO Box 1408 Gosford NSW 2250 NSW**  
**Phone 02 43402500, Web [www.ccarc.org.au](http://www.ccarc.org.au)**

**Email [fieldday@ccarc.org.au](mailto:fieldday@ccarc.org.au)**

ar

# Amateur Radio Index 2005

Title	Author	Issue	Page	Title	Author	Issue	Page
<b>ALARA</b>				John Moyle Field Day 2005 rules		Jan /Feb	52
International YL meeting in Seoul	ALARA	Jan/Feb	28	Remembrance Day Contest 2005 Rules	Chris Edmondson VK4AA	July	42
<b>Awards</b>				Ross Hull VHF Memorial Contest rules		November	42
9 band DXCC presentation	Michael Owen VK3KI	December	43	VK/transTasman Contests 2005 rules		April	42
Awards 3B DXCC and 5B DXCC	Mai Johnson VK6LC	June	40	Wadda Cup 2005 Rules	Vince Henderson VK7VH	July	45
Awards WIA 9B DXCC and 11B DXCC	Mai Johnson VK6LC	October	34	IRLP Contest?	Bass AR IRLP Group	Jan/Feb	40
The fathers of radio award	Erminio Cioffi Squitieri IZ8AJQ	August	54				
<b>Contest results</b>				<b>Corrections</b>			
ALARA 25th contest results		December	42	Correction April 2005 pages 18-20 Lloyd Butler X3		May	40
CQ WW CW VK Contest results 2003		Jan/Feb	49	<b>Covers</b>			
CQ WW SSB Contest results 2003		Jan/Feb	49	Alpine Radio activities		September	IBC
Dutch PACC Contest 2005 results		November	42	Amanda VK4FRST		December	Cover
Harry Angel Sprint 2005 Results		July	41	FT-857D Technical Review item		June	Cover
John Moyle Field Day 2005 - Results		August	43	Homebrew AM TX		March	IBC
John Moyle Memorial National Field Day 2004 Results	Denis Johnstone VK3ZUX/8	March	42	John Moyle Field Day pictures		May	IBC
Oceania DX contest 2004 results	Oceania DX Contest Committee	September	43	Karsten Thole VK5ZKT		April	Cover
QRP Day 2005 results	Ron Everingham VK4EV	November	42	Ladies in Radio VK5TMC and VK5HLS		July	Cover
RD 2004 Contest results		Jan/Feb	49	Lighthouse at Bundaberg		October	Cover
Remembrance Day Contest 2003 Results	Alek Petkovic VK6APK	March	44	Multiband Award Certificates		October	IBC
Remembrance Day Contest 2005 preliminary results	Chris Edmondson VK4AA	November	44	Q meter from VK5JST		Jan/Feb	Cover
Ross Hull Memorial Contest 2004-2005 Results	John Martin VK3KWA	May	42	Remembrance Day trophy		August	Cover
Summer VHF-UHF Contest 2005 Results	John Martin VK3KWA	May	41	SSETI Express		April	IBC
Trans-Tasman Contest winners 2005	Bruce Renn VK3JWZ	October	42	VK3XU and VK2ARZ		November	Cover
Wadda Cup results	Vince Henderson VK7VH	Jan/Feb	48	VK7 promotes Amateur Radio		May	Cover
<b>Contest rules</b>				VU2RBI operating on Andaman and Nicobar Islands		March	Cover
25th ALARA Contest 2005 Rules		June	43	<b>DXCC</b>			
COQC QRP Day Contest 2005	Ron Everingham VK4EV	August	42	DXCC Standings December 2004	Mal Johnston VK6LC	Jan/Feb	43
Harry Angel Memorial Sprint 2005 rules		April	44	DXCC Standings December 2004 correction	Mal Johnston VK6LC	March	8
Jack Files Contest 2005 Rules	John Spooner VK4AJS	June	42	DXCC standings June 2005	Mal Johnson VK6LC	August	53
				<b>Equipment review</b>			
				Equipment review: Yaesu FT-857D all mode, HF, VHF, YHF mobile transceiver.	Eric Buggee VK3AX, Ron Fisher VK3OM	June	22
				The Yaesu FT-7B and the FT-77 (Know your 2nd hand equipment)	Ron Fisher VK3OM	Jan/Feb	30

# Amateur Radio Index 2005

Title	Author	Issue	Page	Title	Author	Issue	Page
Review : bhi digital signal processing units	Eric Buggee VK3AX	October	26	NIUE : Dxers delight	Murray Lycan VE7HA	August	56
The Ten Tec Orion is different!	Martin Luther VK7GN	October	22	Pounding brass in the jungle	Herman Willemsen VK2IXV	April	50
<b>General</b>				RD reminiscing	Joy Stevens	September	12
30th Anniversary Field Days Celebration 2005	Oxley Region Amateur Radio Club Inc	May	31	Remembrance Day Governor General's address		September	12
A century for a gentleman radio amateur	Jim Linton VK3PC	August	27	Remembrance day operation from Mallala War Grave Cemetery	Steve Mahony VK5AIM	August	23
A proposal for reforming amateur examination procedure	Ian Jackson VK3BUF	Jan/Feb	18	Ron Wilkinson Achievement Award presented to VK1ZKM		June	4
Amateur licence reform-just in time? A Linton-Harrison report	J Linton VK3PC and R Harrison VK2ZRH	December	25	Shanghi'd to BY4AA	Thomas E. King VK2ATJ	December	13
Amateur Radio magazine awards 2004		May	13	Sitting at history. Mawson of the Antarctic's desk supports amateur's radio	Allan Doble VK3AMD	December	19
Amateur Radio: Reports to the WIA 2005AGM	"Ted Thrift VK2ARA, Colwyn Low VK5UE"	June	26	Space station talks to St Martin's Mount Gambier	Tony Hutchison VK5ZAI	May	27
Are you ready for action?	Bill Isdale VK4TWI	November	5	The development of radios for the Flying Doctor Service. Part 2	Rodney Champness VK3UG	September	48
Are you ready for action? Part 2	Bill Isdale VK4TWI	December	11	The development of radios for the Flying Doctor Service Part 3	Rodney Champness VK3UG	October	10
ARISS: A way to get the next generation interested in amateur radio	J.A.(Tony) Hutchison VJ5ZAI	May	26	The first year of a national WIA	Michael Owen VK3KI	June	3
Calling CQ CQ	Karsten (Kas) Thole VK5ZKT	April	27	The secret radio in concentration camp 1942-1945	Arn van der Herst VK5XV	September	17
Election of Directors - Call for nominations		December	21	The WIA AGM	Michael Owen VK3KI	March	3
First Class CW Operator's club	David Pilley VK2AYD	March	36	Times of change for the Wireless Institute of Aust	James McLachlan VK5NB	March	27
Florence McKenzie Trophy presentation	Christine Taylor VK5CTY	October	36	Urunga Convention 2004		Jan/Feb	42
GA Taylor Medallion awarded to VK4BB		June	4	VI5PN operation - a great success	Peter Forbes VK3QI	June	17
Greetings from the Cook Islands	James Goodger ZL1DG	Jan/Feb	27	VK4SS makes a generous donation		November	48
How to write for Amateur Radio magazine	Bill Roper VK3BR	July	50	VK5 exam assessor training course held in Adelaide	Trevor Quick VK5ATQ	October	49
Is the remembrance Day Contest dying?	Vince Henderson VK7VH	June	28	Women in radio	Christine Taylor VK5CTY	July	28
Library amateur radio displays	Graeme Wilson VK6BSL	November	8	"Wrong place, right time"	Mrs D. Bharathi Prasad VU2RGI	March	13
Lightning protection	Kevin Peacock VK4VKD	April	24	Alpine Radio	Stephen Warrillow VK3JNH	September	13
Meet Judith Oliver WIA National office coordinator		October	50	<b>General operating</b>			
New lights in the sky. Earth generated radio lights up the ionosphere	Bill Isdale VK4TWI	December	16	Celebrating the ITU's 140th birthday	Barry Robinson VK3JBR	October	25
News from WICEN Victoria	Bruce Bathols VK3UV	March	22	Green Cape Light 2005	Ken Robertson VK3HKR	October	19
				RD Contest 2005	Alan Manson VK2GR	October	48

# Amateur Radio Index 2005

Title	Author	Issue	Page	Title	Author	Issue	Page
The International Lighthouse and Lightship weekend	Ron Bromley VK4FC	October	20	Shopping by Internet	Kevin B. G. Luxford VK3DAP/ ZL2DAP	June	45
To DX beyond the western sky. IOTA on Den Hartog Island	Nigel Dudley VK6KHD	December	22	The Institute WW2 Honour Roll is still incomplete	Col Harvey VK1AU	April	51
Working DX from 16 metres above the Indian Ocean	Graham Rodgers VK6RO	October	18	The other side of the Tasman in the 160 m contest	Bruce Renn VK3JWZ	August	52
Toyota Rally of South Australia	Colwyn Low VK5UE	October	21	Where do you get it? WIA membership costs	Phil VK2BTT Alan VK3VD	April August	51 52
<b>Grid square standings</b>				<b>Satellites</b>			
Correction to DXCC standings Jan/Feb page 43	Guy Fletcher VK2KU	March	6	Half-yearly update operational satellites	Bill Magnussen VK3JT	July	35
Grid square standings 21 March 2005	Guy Fletcher VK2KU	May	44	Operational satellites	Bill Magnusson VK3JT	Jan/Feb	44
Grid square standings to 24 December 2004	Guy Fletcher VK2KU	Jan/Feb	21	SSETI Express update	Graham Shirville G3VZV	April	39
Gridsquare standings 20 July 2005	Guy Fletcher VK2KU	August	39	<b>Silent Keys</b>			
<b>Index</b>				Alex Szopko VK7CS		July	31
Amateur Radio Magazine Index	Colwyn Low VK5UE	Jan/Feb	56	Bill Beyer VK3BHW	Bob Neal VK3ZAN	March	36
<b>Over to You</b>				David Moss VK2UMD	David Horsfall VK2KFU	August	32
A word of thanks	John L. Cartmell VK4BJ	October	40	David Robert "Dave" Gibbons VK1GD	John Clare VK1CJ	Jan/Feb	22
Amendments to Q meter article Jan.Feb 2005 page 6	Jim Tregellas VK5JST	March	25	Dick Grouse ex VK2AZG	K&J Duncanson VK4JUD &VK2AOK	Jan/Feb	31
AR Article by Michael Owen	Dave Rosan ZL1AFQ	Jan/Feb	22	Don Bottle SWL	Dale VK7NDH	Jan/Feb	39
As telecom reels from storm damage, ham radio hums	Christopher Rhoads	October	40	Don Brooks ex VK7DB		July	31
Better than watching geckoes get flies	Peter VK6APS	March	47	Donald (Don) Shand VK3DZM	George Stewart VK5ASL	November	40
Boring? Hardly	Steve VK2HHP	November	47	Fred Herron VK2BHE	John Alcorn VK2JWA	September	34
BPL interference	Rodney Champness VK3UG	June	44	Frederick Bernard Freer VK2GAE	Ted Milles VK2FLB	Jan/Feb	47
Circuit board manufacture	Kerry Power VK2TIL	March	25	Geoff Robinson VK2BRG		May	48
Comments on the John Moyle Memorial National Field Day 2005	Denis Johnstone VK3ZUX	August	44	Geoff Taylor VK5TY		July	46
Discrepancy in size descriptions	Barry Millar VK3BJM	June	44	Geoff Taylor VK5TY	Dot VK2DB	August	28
Home brew suggestion	Joe Rotenberg VK3BBN	March	25	Geoffery Hunziker VK2BGF	John Britton VK2ZJB	Jan/Feb	31
Hurricane Katrina	John Costa VK3JCA	October	40	Geoffrey (Geoff) Murray Taylor	Rufus VK5YO and Sandra Salaman	September	37
One Amateur's advice	Peter Tolmie VK2ZPT	March	46	George Gordon Smith VK4ASM		June	36
Pipes - more on dimensions	Peter Stuart VK2BEU	August	44	Herbert (Herb) Newman Stevens VK3JO	Amateur Radio Victoria	May	25
Recruiting to AR: making it interesting	Ashley Geelan VK3??? (I hope)	March	24	I.D. ( Sandy) McNabb VK3AMN	Elizabeth McNabb	Jan/Feb	17
Shack in a brief case	Ron Holmes VK5VH	March	37	Jack Henry Bell	Phil Wright VK4YPW	October	9
				Jack Townsend VK5HT	Ray Deane VK5RK	September	35
				Jim Watt VK3KBG	Bob Neal VK3ZAN	November	34
				Julie Kentwell VK2XBR	TRASH VK2XSO	November	12

# Amateur Radio Index 2005

Title	Author	Issue	Page	Title	Author	Issue	Page
Louis Arthur Jantke VK5LE	Adrian Reimann VK5AJR	October	47	Stephen Courtney-Pratt VK7ZSP		October	33
Maurice Talkes VK3VTW	H.J. Virgo VK3DVY	July	12	Tom Davis VK2STD		May	48
Murray Collings VK8NUE	Jeff VK8GF	March	43	<b>Sunspots</b>			
Peter Harrison VK6HH	Jacqueline Harrison	October	44	Sunspot numbers July 2005		September	33
Peter Naish VK2BPN (Silent Key)	Michael Owen VK3KI et al	Jan/Feb	27	Sunspot numbers June 2005		August	55
Ray Milliken VK2SRM		May	48	Sunspot numbers May 2005		July	27
Reginald Talbot Busch VK3LS	Allen VK3SM	August	52	Sunspot numbers September 2005		November	6
Robert Leslie Parnall VK3TLC		October	40	Sunspots numbers Feb 2005		April	45
Roger Steedman VK3XRS		May	42	<b>Technical abstracts</b>			
Ron MacNamara VK4ESC	Ron Marschke VK4GZ	May	39	A backpackers delight - the folding J-pole	Peter Gibson VK3AZL	August	25
Roy Haynes VK3RU	David Williams VK3KAB	May	51	A portable inverted V antenna	Peter Gibson VK3AZL	September	38
S. J. Hutchison VK2FFF		June	30	A simple wind direction monitor	Peter Gibson VK3AZL	June	19
Stanley John Hutchison VK2FFF		October	40	An efficient tuner for small 160 meter verticals	Peter Gibson VK3AZL	December	27

## TET-EMTRON NEW!

### TE-33M THREE ELEMENT TRI-BAND MINI BEAM

If you haven't got the room for a full size three element beam, but you want more gain than the two element TE-23M, then this is for you.

#### SPECIFICATIONS

FREQUENCY	14, 21, 28 MHZ BAND
MAX.ELEMENT LENGTH	5520 MM
BOOM LENGTH	4.0 M
GAIN	6 / 6 / 7 DBI
FRONT TO BACK RATIO	20/ 15/ 14 DB
FEED IMPEDANCE	50 OHM
TURNING RADIUS	3.74 M
WEIGHT	12 KG
POWER RATING	2 KW PEP

### RAWMAR ENTERPRISES

40 Blackburn Street,  
STRATFORD.  
Victoria, Australia, 3862

Ph: 61 3 5145 6179  
Fax: 61 3 5145 6821  
Email: rawmar@hotmail.com  
ABN: 87404541761

See  
you at  
Wyang

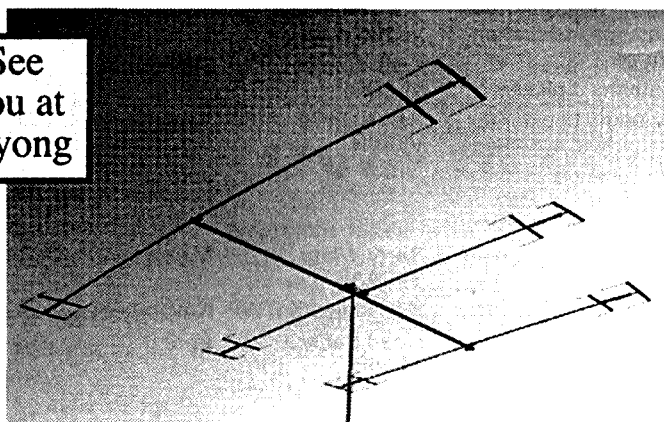

- \*ALL 6000 SERIES ALUMINIUM CONSTRUCTION.
- \*ALL STAINLESS STEEL HARDWARE.
- \*2 KW PEP POWER RATING.
- \*3.74 METER TURNING RADIUS.

#### RECOMMENDED RETAIL PRICE

ONLY **\$858** INCL. GST

If you already have a TE-23M, you can purchase the extension kit containing extra boom, director element, and everything you need to upgrade to this antenna.

Complete kit: \$255 incl. GST.

See Website [www.tet-emtron.com](http://www.tet-emtron.com)  
for dealer list.

# Amateur Radio Index 2005

Title	Author	Issue	Page	Title	Author	Issue	Page
Antenna mounts for all occasions	Peter Gibson VK3AZL	March	24	Unravelling the mysteries of connecting radios to antennas. Part 1	Brian Clarke VK2GCE	April	10
Heavy duty standoff insulators for ladder line	Peter Gibson VK3AZL	October	51	Unravelling the mysteries of connecting radios to aerials. Part 2	Brian Clarke VK2GCE	May	14
Improvements to the 2 metre copper loop	Peter Gibson VK3AZL	April	36	Unravelling the mysteries of connecting radios to antennas. Part 3	Brian Clarke VK2GCE	June	14
Mounting yagis	Peter Gibson VK3AZL	June	20	Unravelling the mysteries of connecting radios to antennas. Part 4	Brian Clarke VK2GCE	July	5
Nylon washers as VHF torroids	Peter Gibson VK3AZL	August	26	VK5BR_X3 antenna for 40 metres	Lloyd Butler VK5BR	March	5
Remote dc power through your coax	Peter Gibson VK3AZL	March	23	What a sight! An antenna with a difference.	Mark Aitken VK3JMA	December	5
Surface mount test tweezers	Peter Gibson VK3AZL	April	23	<b>Technical - ATV</b>			
<b>Technical - aerials</b>				DATV down under. Part 1	Richard L. Carden VK4XRL	November	17
A compact, effective vertical antenna for 160 m. Part 2	Drew Diamond VK3XU	Jan/Feb	12	DATV down under. Part 2	Richard L. Carden VK4XRL	December	7
A pi-coupler for the compact 160 m vertical (and HF antennas)	Drew Diamond VK3XU	April	14	<b>Technical - digital</b>			
A simple-to-make dipole for HF bands	Hayden Honeywood VK7HAY	October	5	PROCTOR and other data emissions	Marc Robinson VK2BUA	August	16
A Windom antenna	Chris Wright VK2UW	Jan Feb	20	<b>Technical - general</b>			
All HF bands in one antenna installation	Don Haberecht VK2RS	November	22	"Paddyboard" circuit construction~revisited"	Drew Diamond VK3XU	May	23
An HF-6 metre antenna diplexer	Keith Gooley VK5OQ	September	21	2005 - the year of DRM?	John L. Cartmill VK4BJ	August	9
Antenna booster for hand-held scanners	Ron Holmes VK5VH	September	19	A primer on power line carrier systems	Barry White VK2AAB	April	21
Correcting Mysteries.... May page 15 - Correction		July	19	Fuses or how to get a smaller bang for your buck I	Clive Wallis VK6CSW	October	13
FT920 antenna tuner repair	Barry White VK2AAB	March	7	Home brew - the satisfaction of "rolling your own"	David Pilley VK2AYD	August	30
Instant gratification	Bill Isdale VK4TWI	November	24	Modifications to the KR400 rotator	Barry White VK2AAB	May	50
More information on the VK5BR_X3 antenna	Lloyd Butler VK5BR	April	18	Printed circuit boards - a simple approach	Godfrey Williams VK5BGW	August	5
Multiband magnetic loop	Peter Parker VK3YE	March	16	Radiated power	Bill Isdale VK4TWI	October	15
OzSpid antenna rotator (Review and report)	Kevin Peacock VK4KKD	August	14	Round cable supression cores	Ron Sanders VK2WB	May	21
Practical HF broadband wire antennas	Marc Robinson VK2BUA	September	26	Suds to solder	Ian Jackson VK3BUF	March	9
Restoring an 18AVT multi-band vertical	Peter Stuart VK2BEU	November	10	The experimenters "Blob" board	Drew Diamond VK3XU	August	7
Small VHF beam : performance and maintenance	Felix Scerri VK4FUQ	October	4	Those bargain portable generators	Steve Mahony VK5AIM	March	21
Some useful wire antennas for HF. Part 3	Rob Gurr VK5RG	Jan/Feb	23	Using "low cost" parts in critical applications -Is it worth it?	Felix Scerri VK4FUQ	August	24
Synchronised aerials	Dave Giles VK5DG	December	9	VHF and microwave propagation characteristic.. Correction	Andrew L Martin VK3KAQ	August	38
The VK5BR-X antennas	Lloyd Butler VK5BR	December	48				



# Amateur Radio Index 2005

Title	Author	Issue	Page	Title	Author	Issue	Page
VHF and microwave propagation characteristics in ducts. Part 1	Andrew L Martin VK3KAQ	June	5	Another dc to dc converter for laptop use	Warren Stirling VK3XSW	July	38
VHF and microwave propagation characteristics of ducts. Part 2	Andrew L Martin VK3KAG	July	20	Experiments in aircraft enhanced propagation	Barry Millar VK3BJM	November	11
<b>Technical - instruments</b>				<b>Technical - transceivers</b>			
600 Hz selective CW audio amplifier	Robert Milne VK7ZAL/AX2TAR	Jan/Feb	20	A dual band CW transceiver. Part 2	Dale Hughes VK2DSH	September	5
A morse frequency meter	Phil Rice VK3BHR	November	7	A dual band CW transceiver Part 1	Dale Hughes VK2DSH	August	18
A tetrode tester	Drew Diamond VK3XU	November	13	My even further experiences with DSB QRP	Graeme Wilson VK6BSL	November	49
Aerial analyser kits		May	13	The ICOM-730 HF transceiver (Know your second hand equipment)	Ron Fisher VK3OM	June	21
An experimental HF aerial analyser	Jim Tregellas VK5JST	May	5	<b>Technical - Transmitters</b>			
Building a Q-meter	Jim Tregellas VK5JST	Jan/Feb	5	Another method of making "air wound" transmitting coils	Drew Diamond VK3XU	September	29
Making shunts for ammeters	Drew Diamond VK3XU	November	27	Notes on HF transmitting coils	Drew Diamond VK3XU	September	29
The 2002 DFD updated	Phil Rice VK3BHR	September	24				
Using the HP 8405A vector voltmeter	Richard Sawday VK5ZLR	June	12				
Yet another RF bridge	Dale Hughes VK2DSH	April	5				
<b>Technical - power supplies</b>							
A miniature variable dc supply	Jim Tregellas VK5JST	July	13				

## Over to you

approach taken with the Foundation Licence was a great improvement:

1. The study guide was clear and easy to follow and pitched at the right level.
2. The Saturday instruction program was of a high quality and very helpful.
3. The examination paper was clear and fair since all questions asked were in line with the syllabus and study guide.
4. They had confidence in the fairness of the assessment process.

My own observations were that the program was transparent in that the candidates were assessed by people other than their instructors, and that a staged appeal process was available.

Those who devised this excellent program deserve congratulations. It augurs well for the future of our hobby.

Kevin B. G. Luxford  
VK3DAP / ZL2DAP

It really sickens me to know that BPL is here and we need to fight to protect what is legally ours.

To the authority that gave Aurora permission to cripple amateur radio, I say, shame shame shame.

B McAleer VK4BCM

## Foundation Licence training and assessment

I have just observed a Foundation Licence training and assessment weekend conducted at Box Hill North in Melbourne on the weekend of 10 and 11 December with a view to perhaps getting involved in this program. The program was impressive in terms of the quality of the instruction, but most importantly, in the views of the candidates themselves.

Several commented to me that they had tried getting a novice licence several times, but had just about given up hope of getting their ticket. However, the

## BPL

I am absolutely amazed that, in spite of all the adverse publicity from USA, Austria, UK and other countries regarding the destructive consequences of BPL, a company here in Australia, can flaunt the laws and establish BPL. How on earth do they get permission to conduct these "trials" when experience has proved that interference is assured?

Surely with all that is known about BPL interference, the authorities should have prevented operations from starting up. Now that they are operational the licensed users of the spectrum should not be expected to fight the battle. However, the amateurs will fight, and win.

The amateur radio fraternity has been working hard to encourage newcomers into the hobby. This would be pointless if there is no place to operate satisfactorily. It is not "Australian" to allow giants to come in and take away the very medium of our hobby.

## VK2

Tim Mills VK2ZTM.

Members of Amateur Radio – New South Wales are advised that the Annual General Meeting of the parent company, Wireless Institute of Australia, NSW Division, is scheduled to be held on Saturday 22nd April 2006, at Parramatta.

In the lead up to the event, the following dates are important in the preparation:

*February 10th.* All Councillors' and office bearers' reports to be submitted.

*March 3rd.* Close of nominations for election to Council.

Close of Motions and other business for the meeting.

*March 24th.* All reports and other paperwork to be ready for the printer.

*April 1st.* Mail out of material for the meeting.

The first of the Tender of Deceased Estate equipment was completed last November and distributed during the Trash and Treasure at VK2WI Dural. Despite the rare occurrence of a wet day, there was a good attendance for the event. The second round of Tenders was conducted during January. The next Tender will be on line now - [www.arnsw.org.au](http://www.arnsw.org.au) - and distributed at the March 26th T & T. The closing date will be March 10th.

VK2 field days coming up include the Central Coast ARC event on Sunday

the 19th February at the Wyong Race Course. The Urunga Convention on the Mid North Coast will be held over Easter and the Oxley Region event at Port Macquarie on the June Long weekend.

AR-NSW is getting into the Foundation Licence training with both weekend and evening operations. Barry VK2AAB has taken over from Pat VK2JPA as group leader of the Parramatta based operation. Those wishing to undertake these courses should make contact with the AR-NSW office when it is open on Tuesday, Thursday and Friday between 11 am and 2 pm by either telephone 02 9689 2417 or a personal visit to 109 Wigram Street, Parramatta. At all times by FAX 02 9633 1525; the telephone answering machine on 9689 2417, Mail to P. O. Box 9432, Harris Park 2150; or email to [vk2wi@ozemail.com.au](mailto:vk2wi@ozemail.com.au) By any method, please provide contact details. Dates of the courses are included in VK2WI Sunday news

It is now two years since the requirement for Morse was dropped but the mode appears to be gaining popularity. The operators of the VK2BWI Slow Morse team have continued to provide their time and efforts several nights per week on the 80 metre frequency of 3550 kHz. The service provides a range of styles and a read back of the text sent. Like many activities, the team would like assistance from more operators. If you would like to help, get in touch with any of the operators or Ross VK2ER, who

helps coordinate the service. This and the automated VK2WI transmission on 3699 kHz is a service provided for and on behalf of AR-NSW.

The VK2WI broadcast team is still in need of operators for presentation or engineering for both the morning and evening sessions. Our numbers have been dropping and this has increased the load on those remaining. It is the practice to schedule two operators to the session of which only one needs to hold an amateur licence. This is an opportunity for those interested in either talking or operating the engineering console to assist. Contact John VK2JJV, the roster coordinator, VK2WI or the AR-NSW office if you can assist.

There are plans to add a second shed to the Dural property for storage, as well as providing a covered area for T & T operations. Some equipment is becoming available to restore the 2 and 70 beacons. The 6 metre beacon on 50.289 MHz is continuing to perform well on its wire dipole about 6 metres above ground. Jack VK2XQ, who provides the 6 metre DX report to VK2WI News advised at New Year, that it has now been heard in all VK call areas, the Pacific and Japan. Part of the Dural upgrade will be to provide some new, more elevated beacon antennas, located away from the main building. There are also reports that the central NSW Orana Region ARC has plans for beacons in their area. A break through of the 40 metre AM service into the main engineering console has resulted in recent transmissions having to be made with the lower powered SSB callback transceiver. Part of the problem is the 40 metre dipole antenna is almost above the building. It is planned to establish some new HF antennas further from the main building. Barry VK2AAB has established a 40 metre packet port at VK2WI on 7038 kHz. The 40 metre packet transmission, like the 80 metre Morse on 3699 can provide a band propagation indicator. This 40 metre transmission is in addition to the existing packet systems on 144.850 and 434.100 MHz.

All the best for 2006 from AR-NSW.  
73 - Tim VK2ZTM.

## Silent key

### Avid six metre operator passes on:

#### John ("HO") Van den Bogert VK2HO

It is with great regret we record the passing of VK2HO ("HO") John Van den Bogert, suddenly at his home in Lismore on 7th November, 2005.

John was a very keen long time 6 m. enthusiast and very well known on the band in the Southern States, VK4, VK6 and internationally.

He was a fine professional technician with great experience in VHF and UHF

tranceivers. He provided valuable assistance and advice whenever called upon.

A very good friend and associate, he will be sadly missed, especially as "HO" on 6 metres.

Our sincerest condolences to his wife Robyn and Family.

Vale John Bogert VK2HO.

Submitted by: **Wal. Munn VK2JHN.**

## VK3

### Amateur Radio Victoria News

Jim Linton VK3PC

Website: [www.amateurradio.com.au](http://www.amateurradio.com.au)

Email: [arv@amateurradio.com.au](mailto:arv@amateurradio.com.au)

#### Happy New Year!

The year 2006 began on a positive note with the amateur radio community starting to grow again after a decade of decline.

Throughout this year we will witness Foundation Licensees keenly engaging in many aspects of amateur radio activity, and possibly a third of them upgrading in coming years to at least the second tier Standard Licence.

A clear message from members through the Think-Tank exercise and in general discussion is that they believe Amateur Radio Victoria should provide licence training and other education.

Many of today's long-time VK3 radio amateurs were the product of our classes held at East Melbourne, Fitzroy and later Canterbury.

In response to the arrival of the Foundation Licence, the decision was made for Amateur Radio Victoria to re-enter the field of licence training.

A small team was formed to design a weekend training course for the Foundation Licence which saw successful sessions held in November, December and January at Box Hill North.

#### Geelong Radio and Electronics Society (GRES)

The last 3 months of 2005 were again most productive. The first talk for the quarter was given by John VK3HJS. He described his work using computer WAN cards to construct a 2.4 GHz data transmitter. He talked about the problems associated with getting the data from the computer to the antenna. He eventually solved the problem by using Ethernet cable from the computer to the WAN card at the antenna. He also reminded us of the fact that WAN networks are not secure as he was able to hear other networks on 2.4 GHz. John VK3TKH gave an interesting talk on the practical uses of oscilloscopes.

We were given instruction in basic CPR by an officer of the Victorian Ambulance Service. His theme for the

At this stage a course and assessment session is planned for each month.

Inquiries about these should be directed to Team Leader, Barry Robinson VK3JBR email [arv@amateurradio.com.au](mailto:arv@amateurradio.com.au) or phone 0428 516 001.

Thank you to those members who have directed interested people to our Foundation Licence training course. A further expansion of our licence training and education will be announced later.

#### Welcome Aussie Foundation Licensees

To celebrate Australia's new era of ham radio, in particular the entry level Foundation Licence, Amateur Radio Victoria has struck a special activity award.

To qualify for the WAFL (appropriately pronounced waffle) Award needs logged contacts with Australian Foundation Licence Stations.

Australian award claimants are required to submit evidence of contact with at least 50 while DX stations require at least 10 contacts (see rules).

The Award will run until Australia Day, 26 January 2007, coinciding with the steady induction of the new members

evening was electric shock and what to do in the event of it occurring. This information is of most value, not only in the pursuit of our hobby, but in everyday life. Hopefully we will never have to put into practice what we learnt.

A "shack visit" was held. These evenings are most popular. Members divided into 3 groups and went to visit the shacks of other members. These visits give an insight to where the signal you hear on air originate from. They also benefit the visitors by seeing first hand how other amateurs arrange their stations.

There were 2 WICEN exercises held during this time and most of our members participated in either 1 or both of them. The first was the "Otway

of the amateur radio community.

Full details can be read on the Amateur Radio Victoria website and are expected to appear in a future edition of AR magazine.

#### Membership and financial

The membership list stood at 642 and our Treasurer, Jim Baxter VK3KE, reports that the year for the organisation that ended on 31 December saw a small financial surplus achieved in line with budget expectations.

More detail will be provided in the annual reports now being prepared for the annual general meeting on Wednesday 24 May.

Behind the membership services and other activities of the organisation are members who volunteer their time and energy. Thank you to those who have assisted during the year by staffing the Ashburton Office on Tuesdays, running the QSL Bureau and more recently getting involved in licence classes.

Nominations for the 2006-2009 Council can be made on a form available from the Secretary, with the deadline being 2.30pm on Thursday 23 February, 2006.

Rod Green VK3AYQ

Challenge". This is a 160 km bike ride through the Otway Ranges and along the Great Ocean Road. There were over 200 participants and the money raised goes to heart research. The second event was the Anaconda Adventure Race. This is a race of either teams of 4, or individuals,

*continued next page*

News from...  
**WANSARC**  
**Australia's**  
**youngest amateurs**  
(cover story)  
**see inside back cover**

# News from

## VK3 continued

over a course of 42 km. It consists of swimming, running, kayaking, and mountain bike riding. This was held at the seaside township of Lorne on the Great Ocean Road and the surrounding area. It was challenging for both the 1000 plus entrants in the race and the 11 radio operators. This area of Victoria is heavily timbered rugged terrain and is not the best for radio communication. However good communications were provided between all check points

and the control station. This was due to a portable repeater being set up on Teddy's Lookout. Communication was then possible from the Lorne foreshore to the inland check points and along the Great Ocean Road.

Our Wednesday group has continued to meet regularly. They have been kept busy doing maintenance on the clubrooms, sorting out scrap metal and assessing items that have been donated

to the society. In addition to this work, classes in theory and regulations were held on these days under the guidance of John VK3TKH. Because of these classes we should be hearing some new calls on the air in the near future.

Regular meetings for 2006 will start on Thursday January 12. Visitors are most welcome. The club rooms are at 237a High St. Belmont, with meetings starting at 2000 hrs local time.

## VK5

### Elizabeth Amateur Radio Club

Members of the Elizabeth Amateur Radio Club (left to right) Keith VK5OQ, Merv VK5MX and Steve VK5AIM, prepare for the new Foundation Licence instruction and assessment event. With the changes made to the AOCIP the clubs plan to have a lot more amateurs on the bands.

It is hoped that these changes will enable people who have had an interest in electronics and amateur radio, but in the past have been deterred by the requirements for Morse code along with the higher standard of technical knowledge, to



join amateur radio. Young people who have shown an interest in electronics,

and have just tried electronics at High School, may be more inclined to improve their skills. After all, electronics are in almost every thing these days.

The EARC will establish Instruction Classes and Examinations in 2006 at the Club. Anyone living in the Salisbury, Elizabeth, Munno Para and Gawler area can phone the following EARC members for more information: Keith on 8280 7430, Merv on 8346 7042, and Steve on 8255 7397.

**Steve VK5AIM**

## VK6

### VK6 QSL bureau

The operating figures for the years 2004 and 2005 are Inwards 11796/11170, and Outwards 6356/3430. Now a listing of the countries; number of deliveries from those countries; and the number of cards received from each country as listed for 2005.

9H1-1-11; 9K2-1-9; 9M2-2-11; DL-4-2030; DU-1-32; EI-1-35; F-1-650; G-2-49; HA-2-278; HB9-1-171; HS-1-8; I-1-870; JA-10-2211; K/W-3-837; LY-1-32; OE-1-165; OH-2-355; OK-2-248; OM-2-220; ON/PA-3-423; OZ-1-15; PY-2-5; S5-1-40; SM-2-177; SP-3-420; SV-1-1; T9-1-11; UA-4-873; UR-1-76; VE-1-40; VK1-2-19; VK2-2-500; VK3-3-127; VK5-1-21; VK7-1-6; VR-2-27; YB-4-26; YL-7-55; YO-7-103.

There has been an almost 50%

reduction in the number of cards sent out in 2005, yet the incoming numbers have remained constant. Some cards were noted as having been for contacts made 2, 3, or more years ago. Are the bureaux tardy in sending them or was the amateur slow in sending the card?

It may be seen from the listing that there are many countries that have not sent any cards in the past year. More on this problem later.

With the WIA now providing a free outgoing QSL service, perhaps it is time to consider either recommencing or starting for the first time to QSL your contacts. In the past the cost of printing cards was a factor, but now with QSL printing programs available for home/amateur computers, this has removed the past high cost. Also, I am able to

supply to your address where you may have cards printed, ranging from \$30 for a single sided B/W card to a Four colour printed on both sides for \$70 per 1000, delivered to your QTH.

Overseas countries have no doubt been caught up with the escalating costs of posting mail as have we here in VK. As an example of the cost of operating the bureau, sending VK6 QSL cards to the National Bureau, (which is the Westlakes Amateur Radio Club), for sorting and to post a 1000 cards is \$8.10 for a Post Office Satchel, then assuming that the 1000 contained 350 DL cards, it then costs \$15.50 to send the 1 kg parcel to DL. That is a very basic cost to the W.I.A.

So when do I see your QSL cards starting to flow into the bureau?

**73 Neil VK6 QSL Bureau Manager**

# News from...

## VK7

Justin Giles-Clark VK7TW

Email: vk7tw@wia.org.au Regional Web Site: reast.asn.au

### Statewide ATV link attempt

On 30 December 2005 testing was undertaken with 1.2 and 2.4 GHz ATV paths between Mt Wellington (Sth), Mt Barrow (Nth) and Lonah (NW). On Mt Barrow were Tony VK7NAU and Rick VK7HBR with ATV receive facilities. At Lonah, Tony VK7AX and Bob VK7ZGR set up 1.2 GHz ATV transmitter toward Mt Barrow. On Mt Wellington, Ken VK7DY, Roger VK7ARN and Jamie VK7KEG, Wendy VK7FWJS, Toby VK7FTML, Damien VK7HDS, Karsten VK5ZKT/7 and Sam SWL assisted with 444.25 MHz, 1.2 & 2.4 GHz transmissions. 444 MHz and 1.2 GHz signal reports were received around Hobart from Allan VK7ZAR and Ray VK7FRND on 444MHz. On 2.4 GHz they were using a 1.5 metre prime focus steerable dish. Unfortunately a North - South link was unsuccessful however plans are already afoot to try try again!

### North West Tasmania Amateur Radio Interest Group

NWTARIG held a general meeting on 12 November with 15 people in attendance. Discussion was held about the proposed centenary celebration of the first radio transmissions by Marconi across Bass Strait in 1906. NWTARIG will work in conjunction with the Geelong Amateur Radio Club to stage an event in July 2006. NWTARIG held its end of year BBQ at Legion Park Ulverstone on 10 December 2005 which was well attended and a good time was had by all. AGM is 4 February 2006.

### Northern Tasmanian Amateur Radio Club

Myrtle Park hosted NTARC's Christmas BBQ on December 15, 2005 with 30-35 enjoying the night. On Dec 18, the first NTARC foundation course was held. Course facilitators were Peter,

VK7PD and Al VK7AN and five candidates sat the exam and practical assessment and congratulations to all candidates who passed. On March 2-4 of 2006 at the Inveresk Trams Shed Conference Centre there will be the 2006 Satellite

Conference & Tradeshow. This conference/tradeshow is aimed at both the enthusiast as well as the industry professional. More info at: [www.conferenceplus.com.au/satellite2006](http://www.conferenceplus.com.au/satellite2006). AGM is 8 February 2006.

### Radio and Electronics Association of Southern Tasmania Inc.

Welcome to the 15 new VK7F calls who were heard on the airwaves in December 2005. All 15 attended the November 2005 course and were successful thanks



Mt Wellington ATV: L-R Ken VK7DY, Roger VK7ARN (in car), Toby VK7FTML, Jamie VK7KEG, Damien VK7HDS and Karsten VK5ZKT/7.

### BPL Interference Watch

The BPL juggernaut continues in Tasmania! In Burnie, infrastructure has been installed in the Singline Estate (underground), and in the Malonga Drive to Taroona Avenue area and emissions have already been measured. ACMA has been taking measurements in the Mt Nelson area and we await these results. I encourage all amateurs and HF CB operators to head up to the BPL trial areas and take a listen to what BPL sounds like. Keep writing those letters to the newspapers, politicians and ACMA: we need to keep the pressure on.

*continued next page*

# OzGear

[www.OzGear.com.au](http://www.OzGear.com.au)

RadioCommunications & Electronics  
Ozhelp Services Pty Ltd T/as OzGear

Suppliers of radiocommunications, electronics and computer products and electronic test equipment.

Ph 07 3114 2506

[sales@ozgear.com.au](mailto:sales@ozgear.com.au)

Brisbane, Q'ld

Manager : Doug Hunter VK4ADC

**You want radios ??**  
Boy, do we have radios for you...

**ICOM & YAESU**

Australian-sourced radios with Australian-based manufacturer warranties.

Authorised Aust Icom and Yaesu Dealer

Antenna, cable, interface, tuner and general accessory products from...

Amidon, Andrews USA, Autek, Benelec, Bushcomm, Comet, Daiwa, Diamond, Garland, GeoSensory, GME, Icom, Kingray, LDG, Lutron, Mobile One, RFI, Sangean, SGC, TET-Emtron, Tigertronics, Yaesu, ZCG Scalar plus ARRL and RSGB publications....

# ALTRONICS

Over 8000 electronic components and accessories as listed in the Altronics catalogue with many items held in local stocks.

**Not local to you ?**

Not an issue because we ship our products all over Australia and to overseas customers every week.

**Product & pricing info ?**

Phone, email or visit us on the web at

[www.OzGear.com.au](http://www.OzGear.com.au)

for the latest product info plus on-line ordering. Our latest price list can be downloaded at any time.

Payment ?



# Spotlight on SWLing

Robin Harwood VK7RH

## Radio wars — now and then

Within days of 2006 commencing, Israeli Prime Minister Ariel Sharon suffered a major stroke, which led to instability within Israel and beyond, and a radio war quickly escalated. I noticed a sharp increase in traffic from the various Numbers stations that may be operated by intelligence services. When international tensions erupt, these signals seem to be everywhere, as are International broadcasting services. It is hardly surprising that the Middle East continues to dominate HF traffic.

The BBC World Service brought forward the axing of several European language services at the end of December, instead of waiting to the end of the B05 period. Czech, Slovak and Polish quietly ended up before Christmas, although there were protests reported in the Czech Republic. Radio Slovakia received funding to continue external programming for another six months.

The Voice of Russia announced the death after a long illness of veteran broadcaster Joe Adamov, a few weeks short of his 86th birthday. He started

work as an announcer at the foreign language service of Radio Moscow in 1942, and for over 40 years hosted one of the station's most popular programs, Moscow Mailbag. He will be remembered as the voice of the Cold War, but those who met and worked with him remember a much kinder man than was portrayed in his broadcasts.

This was one of the first programs I heard when I started out as a shortwave listener. It was primarily created for American audiences and I also remember hearing a separate International edition. After the fall of communism in 1991, Joe continued with the program trying to explain post-communist life in Russia.

I gave myself a Christmas present of a 12-month subscription to dxtuners.com, a web-based remote receiver facility. I have been able to tune around the bands from many localities. Many hams and SWLs are availing themselves of this facility. Before calling into Europe or the States, operators are quickly able to gauge if propagation is running or how congested is a favourite channel.

At present there are over 30 different sites a subscriber can remotely control, although some remain restricted. A favourite site is near Heathrow and this seems to be mainly scanning the nearby airports. It is far busier, naturally, than either Melbourne or Sydney Airports.

To get to the site, type in [www.dxtuners.com](http://www.dxtuners.com). Subscriptions start from \$5 US a week to \$50 US per annum. Also read the prompts when you sign in. This will advise you what sites are down for maintenance or due to inclement weather, such as cyclonic activity or bushfires. There is a chat window for you to communicate and share operating time with other users. Some sites are naturally very popular.

Finally, I would like to thank Colwyn Low VK5UE for his assistance and cooperation in the years he has been editor of this magazine. I hope you will have time to pursue retirement Colwyn.

Email your comments and news to me at [vk7rh@wia.org.au](mailto:vk7rh@wia.org.au) or via snail mail to 20/177 Penquite Road, Norwood, Tasmania 7250.

ar

## News from

### VK7 continued

to course convenor Reg, VK7KK. At the time of writing, the course for January was already full and February's course was filling fast. If you wish to reserve a place for the next available course please contact Reg on 6248 6824 or [regemm@ozemail.com.au](mailto:regemm@ozemail.com.au).

Don't forget those Foundation Tutor CD-ROMs to complement the excellent WIA produced Foundation Licence manual. The Foundation Tutor is available from REAST's Education Officer Reg VK7KK for \$3.50 if purchased with a Foundation Licence Manual - making it a total of \$20. Or I can supply the CD on its own for \$5.00 from Roger, VK7ARN.

We have also been privileged to have regular ATV broadcasts from the Domain each Wednesday night as part of the experimenters' nights. Our December 2005 meeting was our end of year BBQ and over 50 people attended through the day and night including Robert Broomhead, VK3KRB, and son Tim, who came along to the evening session. Robert was treated to the BPL tour before continuing on his Tasmanian holiday. Mike Harris, VK7ACQ has returned from overseas on his Churchill Fellowship studying the use of HF and digital modes and we were given a quick summary of the trip at the BBQ. REAST AGM is 5 February 2005 followed by a BYO BBQ.

ar



Reg VK7KK, VK7 WIA accredited assessor running through course material.



Marilyn VK7FMAZ, our first VK7 female foundation licensee who is also XYL of Dave, VK7KDO.

## Remembering last year

This time last year we were in the midst of helping out the unfortunate victims of the tsunami, with, for YL amateurs the special knowledge that a YL amateur, Bharti VU4RBI, who just happened to be in the Andaman Islands when the tragedy struck, rose to the occasion magnificently. I am sure there were a number of other YL amateurs who also assisted with communications at the time, but Bharti is the only one identified by name, so she is the one we

saw as representing YLs everywhere.

As an amateur I am always ready to brag to the general public about the real contribution amateurs have made on so many occasions, when natural (and sometimes not-so-natural) disasters happen. With the John Moyle Memorial Field Day coming up in March I hope all amateurs take the opportunity to hone their mobile and portable skills – just in case!

If any YLs are engaged in the JMMFD, please let me know. I will be involved myself and know that several VK5 YLs will also be involved but I would love to be able to brag about some of you others, too.

As a reporter for ALARA I can only write about the news you send me. (I speak for Dot VK2DB, editor of our own Newsletter, too.) Please tell us what you are doing.

## News from our YL associations overseas

The BYLARA magazine has a new look. A decision was made to show 'The Faces of BYLARA' on the front cover, so this issue has the first "Face" on it. A great idea. Too often we only hear each other and have no idea what we look like.

The YL in the UK have just participated in the Midwinter Contest run by the Dutch YL Committee. This is a January Contest with CW on the Saturday and SSB on the Sunday. As usual OMs are welcome in the YL Contest and as usual the most common comment is "What a friendly Contest it is". This is typical of

all the YL Contests around the world. There is an exchange of numbers but there is always time to say "Hello, How have you been since last year?" or "How are the family?" etc.

The "WARO" magazine from New Zealand is full of praise for the ALARAMEET in Mildura which is not surprising as the MEET was very successful and there were 14 ZLs at the MEET, but this issue of the WARO Bulletin also has information about the Thelma Souper Memorial Contest for 2006.

This Contest is held on 1st and 2nd of April from 0800 to 1000 Zulu on 80-metres only. It is open to all amateurs. To add to the fun, there is a Bonus station using the ZL6YL callsign for random periods. This will count as a multiplier on each night if worked.

All the details will be published elsewhere and it sounds like a lot of fun. Please participate.

Contacts made during the Contest also count towards the NZ WARO Award.

## Some Silent Keys to report

Two SKs are early supporters of WARO and ALARA. Rae ZL1NI was one of the first members of WARO and remained a member for 40 years even though she was not on the air very often. Vicky ZL1OC was among the first group of YLs who envisioned having a National YL organisation back in about 1960. She served as President for two periods and encouraged the inauguration of the Thelma Souper Contest.

She and her OM Colin were also the very first ZL attendees to an ALARAMEET. They were in Adelaide in 1987 for the second ever get-together of VK YLs and the first one officially called an ALARAMEET.

Two DX members, now SKs are memorable. Jerrie K6INK was an early sponsored member of both ALARA and WARO, and contributed to the growth of both groups and Ruth LA6ZH who at

the age of 82 attended the International YL 2000 MEET in Hamilton, will be remembered with pleasure by all there that year. Nothing daunted this lady. In New Zealand she rode the Luge Run and loved the white water experience on one of the rivers, as well as enjoying every part of the official program. We will remember them all with love and joy. Vale.

## ALARA 30 year history

To celebrate our 30 years, a History has been prepared with photos from the albums embedded in the text. Unfortunately when the cost of printing 100 pages in colour was investigated it was felt that \$100 a copy was rather exorbitant. Instead, a heat-bound copy

of the book, printed in black and white is available for \$30, with a CD attached which has all the photos on it, in colour where appropriate.

If you want any of the photos printed you should be able to take the CD along

to your local photo shop and select the ones you want.

Please contact me Christine VK5CTY email [geencee@picknowl.com.au](mailto:geencee@picknowl.com.au) or QTHR the callbook, by snail mail.

ar

## Posat set to return to amateur radio service soon

There has been some encouraging news from AMSAT-UK recently on the expected change over of Posat from commercial service back to the amateur service.

Posat was built at Surrey Satellite Technology and has served out its planned commercial service commitments. A few months ago, after some negotiation between AMSAT-UK and Surrey Satellite technology it was announced that Posat would be returned to the amateur radio community. This is great news as we have only recently seen the demise of the last such very capable digital bird.

Posat was built in the mould of the later UoSats and will have plenty of power available for store and forward communications much like UO-14 and 22/23/25 in their heydays. We can look

forward with relish to resuming use of this type of satellite system and you can be sure that lots of WiSP and KCT/T tracking gear and high speed modems will be dusted off and brought back to life.

We still have not heard from the command team at Surrey as to the features which will be available. One can but hope that they will be able to activate the earth pointing camera as well as the store and forward bulletin board, hopefully at 38k4 speed.

We have to remember of course that the command team are very busy people and they will probably opt for a mode that requires as little as possible hands-on attention on their part. When the arrangements have been worked out they will probably be announced first on the AMSAT-UK web site.

## FM usage – some thoughts

It's been interesting to follow the discussion on the BB regarding the use of FM on linear transponders.

FM is seen today as one of the "easy-sat" ways of getting newcomers into amateur radio satellite work. This has proved to be true and it is often used to justify requests for extra mode scheduling and to argue for more simple FM mode "easy-sats". Quite a number of satellites have been launched in recent years having this facility and many operators have embraced them and work them regularly with very simple gear.

Some like AO-51 with its 2.4 GHz downlink give operators the chance to "wet their feet" on microwaves as well. They are eminently suitable for this purpose. They have their problems though in areas of high usage like the USA and Europe. Essentially they are single channel devices and the capture effect of FM comes into play.

Satellite designers have turned to sub-audible tone access and other means to minimise interference and generally these schemes work well.

There was however a time before FM birds when linear transponders were

the norm. The problem of continuous mode operation has been around since that time. In those days it was frowned upon and vehemently discouraged to use any continuous carrier mode on a linear transponder.

The reasons were well known and publicised. Even one or two FM or AM or SSTV stations in the pass-band of a linear transponder and the power drain on the limited resources means that everyone's signals are attenuated, right across the pass-band.

In effect a linear transponder capable of sustaining a score of properly managed SSB contacts can be rendered useless for everyone. Memories dim somewhat over the years and recently there seems to be a push for FM to be allowed or tolerated on linear transponders.

A number of gurus have been coming out of the woodwork, explaining in clear terms on the BB why this situation ought not be allowed to become entrenched. Many see it as the thin edge of a wedge which may make the SSB linear transponders unusable if encouraged or allowed to become routine. In fairness, some of the suggestions have not been

## The AMSAT group in Australia

The National Co-ordinator of AMSAT-VK is Graham Ratcliff VK5AGR. No formal application is necessary for membership and no membership fees apply. Graham maintains an e-mail mailing list for breaking news and such things as software releases. Contact Graham if you wish to be placed on the mailing list.

## AMSAT-Australia Echolink Net

The net meets formally on the second Sunday of each month. Anyone with an interest in Amateur Radio Satellites is welcome to join in and take part. Graham VK5AGR acts as net controller. The net starts at 0600UTC and you can join in by connecting to the AMSAT conference server.

All communication regarding AMSAT-Australia matters can be addressed to:

AMSAT-VK,  
9 Homer Rd,  
Clarence Park, SA. 5034

Graham's e-mail address is:  
vk5agr@amsat.org

for willy-nilly use of FM but rather for "FM-days" being scheduled on the linear transponder birds.

Counter arguments to this idea have pointed out the number of FM birds already available and the possibility of entrenching ideas like "It's OK to use FM on the linear birds, we do it on FM days so why not all the time?"

If I was to offer an opinion, I'd side with the gurus and urge that the SSB linear transponders be left for non-continuous modes. We have two more high orbiters on the slate, one due for launch next year.

It would be a pity to see their transponders treated like easy-sats. They are not meant to be. They are meant to offer a challenge for those who want to move on and try to keep their station abreast of latest developments.

The idea of easy-sats has come of age and they are now firmly on the agenda for satellite designers and builders. So are the high orbiters. So are the linear transponders. I believe they each have their distinct place in the AMSAT scheme of things.



# SuitSat deployment delay

Frank H. Bauer KA3HDO, AMSAT V.P. for Human Spaceflight Programs and ARISS International Chairman announced in late November that he had received information that the ISS

spacewalk that will deploy SuitSat and which was planned for December 8, has been delayed to late January/early February 2006. The reason given was the cancellation of a Shuttle mission

and the subsequent 'stretching' of the on-board scheduling that this dictated. Make use of the time by reading up on the SuitSat project and readying your station for the event.

# Six-monthly review of operational satellites in the amateur radio service

This report is compiled from information gleaned from the AMSAT bulletin board and reports from the 'real world'. It's offered as a guide only and you should check the various sources for the latest information before operating. I make no mention of the many non-operational satellites still in orbit or those which are turned off in our part of the world. Satellites like AO-10 and UO-11 for example have become too unreliable to feature as "operational".

## VO-52 HAMSAT

Catalogue Number: 28650

Launch Date: May 05,2005

Status: Testing

Current Mode: U/V - Dutch Transponder

### Proposed frequencies:

#### Indian Transponder:

Uplink : 435.220 MHz to 435.280 MHz  
LSB/CW

Downlink: 145.870 MHz to 145.930 MHz  
USB/CW

Beacon : 145.859 MHz CW

#### Dutch Transponder:

Uplink : 435.225MHz to 435.275MHz  
LSB/CW

Downlink: 145.875MHz to 145.925MHz  
USB/CW

Beacon : 145.860MHz 12WPM with  
CW message

The "Dutch" transponder was turned on recently and from all reports it is working very well with good signal strength. Congratulations to William Leijenaar, PE1RAH who designed, built and largely financed the Dutch transponder himself. Hearty congratulations too to the HAMSAT team who worked so hard to integrate William's transponder into VO-52 and bring it on line faultlessly.

## AO-51 ECHO

Catalogue number: 28375

Launch date: June 29, 2004

Status: Testing

Current Mode: (volatile! see AMSAT web site)

Voice Repeater - V/U FM

Analogue voice downlink: 435.300 MHz FM, 435.150 MHz FM

Analogue voice uplink: 145.880 MHz FM

145.920 MHz FM 67Hz PL tone

1268.700 MHz FM 67Hz PL tone

Digital Downlinks: 435.150 MHz FM, 38k4 Digital, PBP, 1 watt output

2401.200 MHz FM 38k4 bps, AX.25

Digital Uplink: 145.860 MHz FM, 9k6 Digital, Pacsat Broadcast

Protocol (PBP)

Broadcast: PECHO-11, BBS: PECHO-12

To give as many users as possible a 'fair-go', AO-51 is subject to frequent mode changes. The only realistic way to keep on top of these changes is to go to the AMSAT-NA web site. The detailed AO-51 schedule is accessible from the front page. The frequency schedule printed above doesn't look right to me but that's what the latest AMSAT satellite schedule says. My advice to potential users would be to check everything using the official schedule on the day you are planning to operate. This satellite has a heap of mode possibilities and that makes for a complicated scheduling arrangement. But, on the other hand, AO-51 has something for everyone.

## SO-50 SAUDISAT-1C

Catalogue number: 27607

Launched: December 20, 2002

Status: Operational.

Uplink: 145.850 MHz (67.0 Hz PL tone)

Downlink: 436.795 MHz

To switch the transmitter on, you need to send a CTCSS tone of 74.4 Hz.

The order of operation is thus: (allow for Doppler as necessary)

Transmit briefly on 145.850 MHz with a tone of 74.4 Hz to arm the 10 minute timer.

Now transmit on 145.850 MHz (FM Voice) using 67.0 Hz to PT the repeater on and off within the 10 Minute window.

Sending the 74.4 tone again within the 10 minute window will reset timer.

## FO-29 JAS-2

Catalogue number: 24278

Launch Date: August 17, 1996

Status: Operational

Voice/CW Mode JA

Uplink: 145.90 to 146.00 MHz CW/LSB

Downlink: 435.80 to 435.90 MHz CW/USB

Beacon: 435.795 MHz

Digital Mode JD

Uplink: 145.850 145.870 145.910 MHz FM

Downlink: 435.910 MHz 1200-baud BPSK or 9600-baud FSK

Callsign: 8J1JCS

Digitalker: 435.910 MHz

## AO-7 AMSAT OSCAR 7

Catalogue number: 07530

Launch Date: November 15, 1974

Status: Semi-operational in sunlight.

Return to active status: June 21, 2002

Uplink: 145.850 to 145.950 MHz CW/USB Mode A

432.125 to 432.175 MHz CW/LSB Mode B

Downlink: 29.400 to 29.500 MHz CW/USB Mode A

145.975 to 145.925 MHz CW/USB Mode B

Beacon: 29.502 MHz, 145.972 MHz, 435.1 MHz, 2304.1 MHz

Don't expect too much from AO-7. It will often disappoint but when it goes it's a ripper. The orbit is almost circular with an average height of 1450km giving it the widest footprint of any satellite we have operating at present.

## International Space Station (ISS) - ARISS

Catalogue number: 25544

Launch date: November 20, 1998

Status: Lots of activity, voice and digital.

The current Expedition 12 crew is:

Commander: William McArthur - KC5ACR

Flight Engineer: Valery Tokarev - (no call)

Worldwide packet uplink: 145.990 MHz FM

Region 1 voice uplink: 145.200 MHz FM

Region 2/3 voice uplink: 144.490 MHz FM

Worldwide downlink: 145.800 MHz FM

Repeater Uplink: 437.800 MHz FM

Repeater Downlink: 145.800 MHz FM

Russian callsigns: RSOISS, RZ3DZR

USA callsign: NA1SS

Packet station mailbox callsign: RSOISS-11

Packet station keyboard callsign: RSOISS-3

Digipeater callsign: ARISS

The ISS daily crew schedule can be found at:

<http://spaceflight.nasa.gov/station/timelines/>

Remember that the crew operates on UTC time and sleep is a regular part of their daily schedule. Familiarise yourself with the daily schedule and download the latest keps if you want to be successful in working ISS.

## PCSAT2

Catalogue Number: 25544

Launch Date: August 1, 2005

Status: Battery-saving mode

Digital Downlink: 435.275 MHz

Digital Uplink: 145.825 MHz

PSK-31 Downlink: 435.275 MHz

PSK-31 Uplink: 29.400 - 29.403 MHz

PCSAT2 is installed on the exterior of the International Space Station and was activated on August 3, 2005.

More information on PCSAT2 can be found at:

<http://web.usna.navy.mil/~bruninga/pcsat2.html>

## NO-44 PCSAT

Catalogue number: 26931

Launch Date: September 30, 2001

Status: Operational

General Usage Uplink/Downlink: 145.827 MHz 1200 Baud

Special Usage Downlink: 144.390 MHz 1200 Baud

PCSAT is a 1200-baud APRS digipeater designed for use by stations using handheld or mobile transceivers. Downlinks feed a central web site at:

<http://pcsat.aprs.org>

## GO-32 TECHSAT-1B

Catalogue number: 25397

Launch Date: July 10, 1998

Status: Operational

Downlink: 435.225 MHz FM (9600-baud FSK)

(435.325 n/a - temperature problems)

Uplinks: 145.850, 145.890, 145.930 FM

1269.700, 1269.800, 1269.900 FM

Broadcast Callsign: 4XTECH-11

BBS Callsign: 4XTECH-12

A few reports of this satellite come in from time to time. I haven't heard it working for a long time.

## AO-16 PACSAT

Catalogue number: 20439

Launch Date: January 22, 1990

Status: Semi-operational, the digipeater command is on and open for APRS users.

Uplink: 145.90 145.92 145.94 145.96 MHz FM (using 1200-baud Manchester FSK)

Downlink: 437.026 MHz SSB (1200-baud PSK)

Mode-S Beacon: 2401.1428 MHz

Broadcast Callsign: PACSAT-11

BBS: PACSAT-12

Again, I can't hear anything from AO-16 yet the occasional report says it's going. Good luck.

## Soon to appear over the horizon (we hope):

*SuitSat* should be in operation in early February.

*Phase-3E* is on schedule for a launch in 2006.

ar

## KVK Antenna Systems

### The VK Antenna Handbook for Restricted Spaces

Packed with information on restricted space designs.

### The NuBeam Antenna

A reduced size multi-band 2-element beam.

Wyong field day special - bring this ad & get extra 10% discount. Range of unique antennas on display and orders being taken. Best VK antenna value.

Also available in CD pdf format (less 20%) for quick searches. Check web site for info, pricing and ordering.

For direct purchases

[www.grimshaw.net.au](http://www.grimshaw.net.au)

For credit card purchases:

[www.kvkantennas.com.au](http://www.kvkantennas.com.au)

or ph 07-3216 8060 or

fx 07-3216 8075

See us @Wyong

## Are you managing the estate of a 'Silent key'?

Please save any QSLs for the National QSL collection, but first contact:

The Hon. Curator,  
Ken Matchett VK3TL

on (03) 9728 5350

or email: [jeandawson@ilnet.net.au](mailto:jeandawson@ilnet.net.au)

Rare DX, special call-signs prefixes and suffixes, pictorials and pre-war QSLs are needed.

Let us save something for the history of amateur radio.

## Contest Calendar February - April 2006

Feb	4/5	Mexico Intl. RTTY Contest	(RTTY)
	11/12	CQ WW RTTY WPX Contest	(RTTY)
	11	Asia-Pacific Sprint	(CW)
	11/12	RSGB 160 Metres Contest	(CW)
	18/19	ARRL Intl. DX Contest	(CW)
	24/25	Russian PSK WW Contest	(PSK31)
	25/26	CW WW 160 Metres Contest	(SSB)
Mar	4/5	ARRL Intl. DX Contest	(SSB)
	11/12	RSGB Commonwealth Contest	(CW)
	18/19	John Moyle Field Day	(CW/SSB/FM)
	18/20	BARTG RTTY Contest	(RTTY)
	18/19	Russian DX Contest	(CW/SSB)
	25/26	CQ WW WPX Contest	(SSB)
Apr	1/2	SP DX Contest	(CW/SSB)
	1/2	EA RTTY Contest	(RTTY)
	8/9	Japan Intl. DX Contest	(CW)
	15	Holyland DX Contest	(CW/SSB)
	15/16	YU DX Contest	(CW/SSB)
	22/23	Helvetia Contest	(CW/SSB)
	22	Harry Angel Sprint	(CW/SSB)

## Greetings to all Readers—

Well, another year is under way – more hopes and challenges or more worries and despair, depending on your circumstances.

Many of you will have heard the new Callsigns making good use of the conditions on 10 metres over the Christmas/New Year period. In

welcoming these operators to Amateur Radio, may I hope that they will take an interest in Contests as one of the many facets of our hobby.

Perhaps this year we may need to consider variations to the rules of some of our VK contests in order to encourage these newcomers to the field. Perhaps they themselves will suggest ways that will help them to become involved.

However the year will progress, please

all of you feel free to write to me at any time with your ideas.

As a starting point for our 2006 calendar please see below the results of the Spring Field Day and the John Moyle Field Day rules. This is a very popular event, so please note the dates and try to be part of it.

A good year, good DX and good contesting to you all.

73, Ian Godsil VK3JS

## Spring VHF-UHF Field Day 2005: Results

Contest Manager: John Martin VK3KWA  
vhf-contests@wia.org.au

It was good to see a number of callsigns that haven't appeared in the list before. Activity has increased in VK5, and especially in VK4. In the single operator sections, the number of 24 hour stations increased while the 6 hour stations decreased. This is the opposite of the trend in recent years, and I think it reinforces the growing feeling that the "short" sections should be increased from six hours to eight.

Congratulations to the winners of each section, and to all entrants – especially the new ones – for achieving really good scores. This is a fun event, so spread the word and let's get a record number of stations active next time.

Call	Name	Location	6m	2m	70cm	23cm	12cm	9cm	6cm	3cm	TOTAL
<b>Section A:</b>											
<b>Single Operator, 24 Hours</b>											
VK4OE	D. Friend	QG51, 52, 61	-	399	515	696	660	-	-	-	2270
VK2TWR	R. Collman	QF44	59	567	830	312	-	-	-	-	1768
VK3HY	G. Brain	QF32	73	486	760	432	-	-	-	-	1751
VK3BJM	B. Miller	QF13	72	313	770	376	-	-	-	-	1531
VK4DMC	D. McCarthy	QH22	37	159	135	-	-	-	-	-	331
VK1AI	G. Parkhurst	QF44	-	282	-	-	-	-	-	-	282
<b>Section B:</b>											
<b>Single Operator, 6 Hours</b>											
VK5DK	C. Hutchesson	QF02	32	129	160	256	210	-	220	330	1207
VK5ZUC	A. Russell	PF95	52	225	290	360	-	-	-	-	927
VK5AR	A. Raftery	PF94, 95	24	198	250	-	-	-	-	-	472

Call	Name	Location	6m	2 m	70 cm	23 cm	12 cm	9 cm	6 cm	3 cm	TOTAL
<b>Section C:</b>											
<b>Multi Operator, 24 Hours</b>											
VK3ATL	Geelong ARC	QF21	128	576	755	976	800	210	220	330	3995
VK3III	Horsham ARC	QF12	96	591	745	584	-	-	-	-	2016
VK5OM	VK5OM, 3LY, 3AOX	QF03	83	556	740	584	-	-	-	-	1963
VK4WAT	Tableland R&EC	QH22	108	429	450	344	-	-	-	-	1331
VK3SOL	Shepparton DARC	QF24	55	246	410	440	-	-	-	-	1151

<b>Section D:</b>											
<b>Multi Operator, 6 Hours</b>											
VK5SR	SE Radio Group	QF02	55	348	460	456	320	210	210	210	2269
VK5OM	VK5OM, 3LY, 3AOX	QF03	55	357	425	448	-	-	-	-	1285
VK3SB	VK3SB, 3FLI	QF22	-	168	280	-	-	-	-	-	448
VK5LZ	Elizabeth ARC	PF95	48	159	195	-	-	-	-	-	402

Call	Name	Location	6m	2 m	70 cm	23 cm	12 cm	9 cm	6 cm	3 cm	TOTAL
<b>Section E:</b>											
<b>Home Station, 24 Hours</b>											
VK3EK	R. Ashlin	QF32	56	300	435	272	240	-	-	-	1273
VK4BEG	R. Norton	QH22	92	324	440	296	-	-	-	-	1152
VK3KAI	P. Freeman	QF31	-	201	280	344	320	-	-	-	1145
VK3UDX	G. Beadle	QF22	33	183	305	168	-	-	-	-	689
VK4AQ	J. R. Anderson	QH32	79	288	140	-	-	-	-	-	507
VK1WJ	W. Jirgens	OF44	26	120	135	-	-	-	-	-	281
VK5KMC	M. Clarke	PF95	-	105	170	-	-	-	-	-	275
VK5PAV	D. Stubbs	Check log	-	-	-	-	-	-	-	-	-

# John Moyle Memorial Field Day Contest 2006

Presented by Denis Johnstone VK3ZUX

18 - 19 March, 2006

0100 UTC Sat - 0059 Sun

I wish all entrants good luck, and look forward to hearing you on air during the contest!

N.B. new Email address: [jmfd2006@wia.org.au](mailto:jmfd2006@wia.org.au) and/or check out latest info at <http://www.wia.org.au/contests/>

## Overview

- The aim is to encourage and provide familiarisation with portable operation, and provide training for emergency situations. The rules are therefore designed to encourage field operation.
- The contest takes place on the 3rd full weekend in March each year, and runs from 0100 UTC Saturday to 0059 UTC Sunday, 18-19 March 2006.
- The contest is open to all VK, ZL and P2 stations. Other stations are welcome to participate, but can only claim points for contacts with VK, ZL and P2 stations.
- Single operator portable entries shall consist of ONE choice from each of the following (e.g. 6 hour, portable, phone, VHF/UHF):
  - 24 or 6 hour;
  - Phone, CW, or All modes;
  - HF, VHF/UHF or All Bands.
- Multi-operator portable entries shall consist of ONE choice from each of the following (e.g. 24 hour, portable, phone, VHF/UHF):
  - 24 or 6 hour;
  - Phone, CW, or All modes;
  - HF, VHF/UHF or All Bands.

- Home and SWL single operator entries may be either 24 hour or 6 hours, all modes, all bands.

## Scoring

- Portable HF stations shall score 2 points per QSO.
- Portable stations shall score the following on 6m:
  - 0-49 km, 2 points per QSO;
  - 50-99 km, 10 points per QSO;
  - 100-149 km 20 points per QSO;
  - 150-299 km 30 points per QSO;
  - 300-499 km 50 points per QSO;
  - 500 km and greater, 2 points per QSO.
- Portable stations shall score the following on 144MHz and higher:
  - 0 to 49 km, 2 points per QSO;
  - 50 to 99 km, 10 points per QSO;
  - 100 to 149 km, 20 points per QSO;
  - 150 to 300km, 30 points per QSO.
  - 300 kms and greater, 50 points per QSO.
- For each VHF/UHF QSO where more than 2 points is claimed, either the latitude and longitude of the station contacted or other satisfactory proof of distance such as the 6-figure Maidenhead Locator must be supplied.
- Home stations shall score:
  - Two points per QSO with each portable station.
  - One point per QSO with other home stations.

## Log Submission

- For each contact: UTC time, frequency, station worked, RST/serial numbers sent/received and claimed score. (VHF and above location of other station and distance showing the Lat Long or Maidenhead Locator to 6 figures for the station worked.)
- Logs must be accompanied by a summary sheet showing: call sign, name, mailing address, section entered, number of contacts, claimed score, location of the station during the contest, and equipment used, and a signed declaration stating "I hereby declare that this station was operated in accordance with the rules and spirit of the contest and that the contest manager's decision will be accepted as final". For multi-operator stations, the names and call signs (legible) of all operators must be listed.
- Paper logs may be posted to "John Moyle Contest Manager, P.O. Box 8739 Alice Springs NT 0871". Alternatively, logs may be emailed [jmfd2006@wia.org.au](mailto:jmfd2006@wia.org.au) or to [VK3ZUX@hotmail.com](mailto:VK3ZUX@hotmail.com) or mailed via the WIA Contest Manager JMMFD, P.O. Box 2175 Caulfield Junction, VIC 3161. The following formats are acceptable: ASCII text or Microsoft Word or Excel and electronic log programs such as VKCL. Logs sent by disc or e-mail must include a summary sheet and declaration, but the operator's

name (legible) is acceptable in lieu of a signature. Logs must be postmarked no later than 30 April 2006.

## Certificates and Trophy

- 15 At the discretion of the Contest Manager, certificates will be awarded to the winners of each portable section. Additional certificates may be awarded where operation merits it. Note that entrants in a 24 hour section are ineligible for awards in a 6 hour section.
- 16 The Australian portable station, CW section, with the highest CW score will be awarded the President's Cup, a perpetual trophy held at the Executive Office, and will receive an individually inscribed wall plaque as permanent recognition.

## Disqualification

- 17 General WIA contest disqualification criteria, as published in Amateur Radio from time to time, applies to entries in this contest. Logs which are illegible or excessively untidy are also liable to be disqualified.

## Definitions

- 18 A portable station comprises field equipment operating from a power source, e.g. batteries, portable generator, solar power, wind power, independent of any permanent facilities, which is the normal location of any amateur station.
- 19 All equipment comprising the portable station must be located within an 800m diameter circle.
- 20 A single operator station is where one person performs all operating, logging, and spotting functions.
- 21 A single operator may only use a call-sign of which he/she is the official holder. A single operator may not use a call-sign belonging to any group, club or organisation for which he/she is a sponsor except as part of a multi-operator entry.
- 22 A multi-operator station is where more than one person operates, checks for duplicates, keeps the log, performs spotting, etc.
- 23 A multi-operator station may use only one call sign during the contest.
- 24 Multi-operator stations may only use one transmitter on each band at any one time, regardless of the

mode in use.

- 25 Multi-operator stations must use a separate log for each band.
- 26 Logs submitted electronically can use a separate excel worksheet for each band linked to a summary sheet. A typical example is shown at <http://www.wia.org.au/contests/> which can be copied and adapted for the individual use of either single or multi-operators station.
- 27 A station operated by a club, group, or organisation will be considered to be multi-operator by default.
- 28 None of the portable field equipment may be erected on the site earlier than 28 hours before the beginning of the contest.
- 29 Single operator stations may receive moderate assistance prior to and during the contest, except for operating, logging and spotting. The practice of clubs or groups providing massive logistic support to a single operator is, however, totally against the spirit of the contest. Offenders will be disqualified, and at the discretion of the manager, may be banned from further participation in the contest for a period of up to 3 years.
- 30 Phone includes SSB, AM and FM.
- 31 CW includes CW, RTTY, and packet.
- 32 It is not expected that any other modes will be used in the contest, but if they are, they shall be classed as CW.
- 33 All amateur bands may be used except 10, 18 and 24 MHz. VHF/UHF means all amateur bands above 30 MHz. Note: On 50 MHz, the region below 50.150 has been declared a contest free zone, and contest CQ's and exchanges may only take place above this frequency. Stations violating this rule will be disqualified.
- 34 Cross-band, cross-mode and contacts made via repeaters or satellites are not permitted for contest credit. However, repeaters may be used to arrange a contact on another frequency where a repeater is not used for the contact.
- 35 Stations may make repeat contacts and claim full points for each one. For this purpose, the contest is divided into eight consecutive three-hour blocks: 0100-0359,

0400-0659, 0700-0959, 1000-1259, 1300-1559, 1600-1859, 1900-2159, 2200-0059 UTC. If you work a station at 0359 UTC a repeat contact may be made after the start of a new block providing, they are not consecutive or are separated by at least five minutes, since the previous valid contact with that station on the same band and mode.

- 36 Stations must exchange ciphers comprising RS(T) plus a 3 digit number commencing at 001 and incrementing by one for each contact.
- 37 Portable stations shall add the letter "P" to their own cipher, e.g. 59001P.
- 38 Multi-operator stations are to commence numbering on each band with 001.
- 39 Receiving stations must record the ciphers sent by both stations being logged. QSO points will be on the same basis as for Home Stations, unless the receiving station is portable.
- 40 The practice of commencing operation and later selecting the most profitable operational period within the allocated contest times is not in the spirit of the contest, and shall result in disqualification. The period of operation commences with the first contact on any band or mode, and finishes either 6 or 24 hours later.

If anyone wishes to contact me privately to discuss rules etc, my home phone number is (08) 8955 5642, and my snail mail and e-mail address is as shown in the Log Submission section above.

ar

## Plan ahead

# Harry Angel Sprint

## April 22

# DX News & Views

John Bazley VK40Q,

P.O. Box 7665, Toowoomba Mail Centre, QLD 4352.

Email: john.bazley@bigpond.com

I hope you were successful in working the Peter 1 Dxpediton at least on one band, for it may be a few years before we see activity from there again.

What has the New Year in store in the way of other DX? The forecast is a little time before we hit 'bottom' of the current cycle. Can we expect activity from Navassa and/or Desocheo in 2006 (as I started writing this in late December I never envisaged that we would see activity from Desocheo in 2005!)

So what have we to look forward to?

**Tanzania** - A large group of operators from the Provins ARS (namely F4AJQ, F6AML, F5JSD, F5VHQ, F9IE, F8BII, F8BUI, F2VX and F8IXZ) will be active as 5H1C from Zanzibar Island (AF-032) from 24 January to 2 February. They plan to operate on 10-160 metres CW, SSB and digital modes (PSK, RTTY, SSTV). QSL via F5TVG, direct (Franck Savoldi, P.O. Box 92, 94223 Charenton Cedex, France) or bureau. Full information on the operation can be found at <http://5h1c.free.fr/index.html>.

**Chad** - Philippe, F4EGS will be in Chad from 25 December until the end of February, and during May-July 2006, operating as TT8PK on 10-20 metres (10-40m if he can obtain another antenna) on digital modes with some SSB. You can e-mail Philippe ([koehp@wanadoo.fr](mailto:koehp@wanadoo.fr)) and let him know which bands you need Chad on. QSL via F4EGS.

Pete, SM5GMZ will be back in Thailand and Cambodia between December and March. He will operate CW, SSB, PSK31 and RTTY as much as possible in his spare time. From 6th January he will operate on all bands, 6 metres included, as XU7ADI for at least two months.

**OPERATORS NEEDED:** Frosty, K5LBU and three others will be active from Mozambique between 29 June and 13 July, IARU Contest included, with two complete stations and to operate CW, SSB, RTTY, PSK and EME. Those interested in joining the team are invited to contact Frosty ([frosty1@pdq.net](mailto:frosty1@pdq.net)).

QSL 7Q7RM: Allan, G0IAS now has the late Ron Macfarlane's logbooks, dating back to 1947-54 when Ron was GM3EAK. They cover all QSOs (HF and 6 metres) made as either ZD6RM (when Malawi was called Nyasaland)

and 7Q7RM until Ron's death. Allan says they "will stay open for one year, then they will be closed and destroyed". QSL direct only to Allan Hickman, The Conifers, High Street, Elkesley, Retford, Nottingham DN22 8AJ, UK.

P40LE (Andy-K2LE), will be active from 30th January until 1st March and will participate in the ARRL-DX-CW (18-19February). QSL to his home call.

C6ASB (Steve-AK0M), operating 15th -22nd February including the ARRL-DX-CW (18-19Feb). QSL to his home call.

Japanese operators JI5USJ, Toru, and JI5RPT, Makoto, will operate from Chichijima Island (AS-031), Ogasawara during late February 2006, with three stations, two with kW's. Activity will start around 0400Z on February 19th and end 2200Z on February 28th. They will be QRV on CW, SSB, RTTY, and PSK31 on 10 through 160 metres including Satellite (VO-52 and FO-29). Single verticals on 80 and 160 metres. On 40 they will have a pair of phased verticals. On 10-20 metres two element beams. No mention of 30 metre antennas but they will be active on that band. Toru will be operating as JD1BLX (SSB, RTTY and CW), while Makoto will be active as JD1BLY (CW only). Suggested frequencies are: CW 1.821, 1.910 (for JA), 3.511, 7.011, 10.114, 14.040, 18.098, 21.040, 24.920, 28.040 MHz. SSB 3.5 (for JA), 3.795, 7.050/7227 (for USA), 14.255, 18.128, 21.260, 24.960, 28.460 MHz. QSL JD1BLX via JI5USJ either via the bureau or direct to Toru Koyanagi, 400-6-1119 Nagasoneminami, Hikone Shiga 522-0052 Japan. QSL JD1BLY via JI5RPT also either via the bureau or to Makoto Koyanagi, 5-42-203, Kadan, Aoba, Sendai, Miyagi, 980-0815 Japan.

DJ7RJ, Willi, is considering doing a February-March 2006 Dxpediton to the Dodecanese Islands (SV5) for 160 metre enthusiasts. If it is still on your wanted list for 160 Willi can be contacted via email at [dj7rj@t-online.de](mailto:dj7rj@t-online.de).

The 1st official press release has been issued on the January 2006 warm up Dxpediton to CE0Z - Juan Fernandez Island. I say warm up as some of this team will then follow down south to Peter 1 Island (3Y0X) a few days later. The multi-national team will be QRV

from Juan Fernandez starting January 20th until the 28th. Plans are to be active on all bands and modes around the clock. The group will use the call CE0Z. This is not the first time this callsign has been issued, and was last used in September 1995. The team is authorised to operate on 30 metres, not normally allowed in Chile. CE0Z Team will include the following members of the CE3BSQ Radio Club Manquehue (<http://www.ce3bsq.cl/>), from Santiago, Chile: CE3GL, Sergio (president); XQ3SA, Guillermo (team leader); CE3GRG, Juan; CE3VII, Hector; CE3BYL, Maite (YL); CE3GFN; Ignacio; CE5RH, Roberto; and CE3BFZ, Pedro. Joining them will be 3Y0X team members K4SV, Dave; F2JD, Gerard; N2WB, Bill; and N6OX, Bob. On the island they will set up three to four stations. They will have three QSL managers, each with all of the logs. Choose which one is best for you: CE3BSQ for Central and South America, N2OO for North America, Japan and others, and F6AJA for Europe and Africa. Again QSL requests may be sent to any of the managers. After the Dxpediton they will upload their logs to LOTW. A website will be created.

G4WFQ, Dave, plans another Dxpediton, this one to Senegal. Dave plans to be on all bands 160-10 m, mostly CW and RTTY, with some SSB. The dates: February 4-17, 2006. QSL via G3SWH direct with SAE or adequate return postage or via e-mail to [phil@g3swh.demon.co.uk](mailto:phil@g3swh.demon.co.uk) for a reply via the bureau - or the old-fashioned way via the RSGB bureau.

Nine members of the Texas DX Society are going to Malta for the ARRL DX SSB March 5-6. They are N5KTN, K5UO, N5DD, NM5G, W5PF, K5WAF, W5MJ, W9DX and WF5W. Inclusive dates on the island are March 1-8. Before and after the operating event they'll be on CW, SSB, RTTY and PSK, with antennas for all bands 160-10 m.

Special thanks to the authors of *The Daily DX* (W3UR) and *425 Dxp News* (I1JQJ) and QTC DX PY2AA for information appearing in this month's *DX News & Views*. Interested readers can obtain from W3UR a free two week trial from [www.dailydx.com/order.htm](http://www.dailydx.com/order.htm)

ar

# WIA DXCC standings

(335 entities) (31st. December. 2005)

## DXCC Ex.(335)Phone

Callsign	Countries
VK5MS	335/389
VK4LC	335/382
VE6VK	335/372
VK4UA	335/370
VK5WO	335/368
VK6LK	335/360
VK3AMK	335/354
VK3QI	335/349
VK3AKK	335/348
VK2FGI	335/341
VK3DYL	335/341
VK3EW	335/341
VK3SX	335/341

## Honour

### Roll(326)Phone

VK6HD	334/360
VK6NE	333/349
VK2AVZ	333/344
VK1ZL	333/339
VK2DEJ	333/339
CT1EEN	332/336
VK3OT	331/345
VK4OH	330/337
VK6APK	330/335
VK4AAR	330/334
VK3CSR	329/338
VK3YJ	327/333
VK5FV	326/329
VK4SJ	326/327

## General listing-

### Phone

VK7BC	324/329
EA3AKN	323/331
VK3EUA	323/324
VK6ABS	322/000
VK2UK	320/325
VK4LV	319/321
VK1TX	319/000
VK6RO	312/319
VK3JI	310/325
VK6LC	309/312
DL2AWG	309/000
PY2DBU	308/315
VK4ICU	303/305
VK6DY	297/301
JA3EY	296/300
VK4EJ	296/298
DL1TC	294/295
VK3DU	292/301
VK2CSZ	290/293
VK2HV	288/000
VK4BAY	287/290
VK3KE	286/289
VK7TS	285/286
9V1RH	283/285
VK6ANC	282/286
VK2CA	286/000
VK3JMB	275/000
VK3DP	274/277
VK3UY	264/266
JA7MGP	260/000
VK2XH	257/000
DL3ASJ	256/000
VK8NSB	255/000
VK3CIM	254/258

## General listing-

### Phone

VK8DK	253/254
VK2FHN	243/000
VK4AO	240/000
VK8KTC	231/233
VK4DMP	227/228
UA6LDD	225/226
VK8AM	225/000
VK2AU	210/000
VK3DVT	206/209
VK7JAB	198/000
VK2EO	195/000
VK6RZ	187/190
G0VXX	184/000
VK3PA	178/179
9A2KL	172/175
VK6EH	170/000
VK2EJK	169/000
VK2BQS	166/169
DL6USA	162/000
VK5EMI	160/000
VK7LUV	160/000
VK4ARB	159/160
JA6KTY	156/000
VK6HZ	151/000
VK2SPS	143/145
VK3JXO	141/000
VK2QV	141/000
VK3DQ	138/152
VK8LC	137/000
OK1ZSV	136/000
DL9UBF	133/134
SV1XV	130/131
VK4FNQ	130/000
WA5UA	128/000
VK4VIS	127/129
VK5ATU	126/128
VK2IRP	125/101
CU3AAT	125/000
VK2VZQ	122/000
VK4EZ	119/125
VK5UO	112/115
VK3CML	109/000
SV1EOS	105/000
AX4EJ	105/000
VK9RS	104/000
VK6ISL	102/000
SV1GYG	102/000
SV1FTY	102/000
3W2LC	102/000
HS1NGR	101/000
VK6ZAI	100/000
VK5JAZ	100/000

## DXCC Ex.(335)CW

### Honour Roll(326)CW

VK6HD	334/355
VK3QI	334/346
VK5WO	332/348
VE6VK	329/356

### General listing-CW

VK6RZ	315/320
VK3AKK	312/317
VK3KS	307/335
VK4LV	299/306

## General listing-CW

CT1EEN	294/000
VK4ICU	291/000
VK3JI	274/299
VK6MK	249/252
VK7BC	246/255
VK2CWS	245/247
VK3DP	245/247
VK3DQ	243/270
VK3CIM	235/236
RD3AF	233/000
VK7TS	219/000
DL7PA	203/000
VK6RO	196/198
VK3KE	195/000
PY2DBU	179/181
VK4CXQ	174/000
VK5UO	171/172
SP9ADV	168/171
DK6AP	168/000
DL6USA	165/000
VK4UA	151/164
VK4AAR	144/146
VK8AM	138/000
NO7M	135/000
DL1TC	133/000
VK7DQ	131/132
DL6UGF	126/000
DJ4BG	121/000
VK5BWW	110/113
SM6GZN	110/111
T94VT	108/000
9A2KL	103/000
DL3GDS	102/000
VK2AR	100/103

## DXCC

### Ex.(335)Open

VK4LC	335/382
VE6VK	335/380
VK4UA	335/372
VK5WO	335/372
VK6HD	335/362
VK3AMK	335/354
VK3QI	335/350
VK3AKK	335/348
VK3EW	335/341

## Honour

### Roll(326)Open

VK3OT	334/348
VK7BC	334/343
VK2AVZ	333/344
CT1EEN	333/337
VK3UY	333/336
VK2UK	332/337
VK4AAR	332/336
PY2DBU	328/343

## General listing-Open

VK4LV	323/331
VK6RZ	323/329
VK3JI	322/351
VK6RO	321/328
VK4DV	315/330
VK4ICU	311/313
VK6LC	309/312
DL1TC	302/303
VK7TS	295/296

## General listing-Open

PY2DBU	294/298
VK3KE	294/297
VK2HV	289/000
VK3CIM	284/288
VK6ANC	284/288
9A2KL	280/283
UA6LDD	279/280
VK3JMB	277/000
VK6MK	256/259
VK8NSB	256/000
VK3DQ	255/284
VK5UO	251/255
VK2CWS	251/253
VK2FHN	247/000
VK4DA	237/239
VK8AM	236/000
DL6USA	201/000
SP9ADV	200/203
VK3PA	187/188
VK2BQS	183/186
VK4CXQ	179/000
DL6UGF	161/000
VK5ATU	158/160
VK3VB	153/155
VK6HZ	151/000
DL9UBF	150/152
VK3JXO	146/000
VK2SPS	144/145
SV1XV	142/144
VK4EZ	140/147
ON9MCR	129/140
VK3OZ	126/127
VK7CQ	123/125
VK2AR	121/124
VK5DC	117/118
NO7MSB	117/000
VK9RS	111/000
VK2AJE	109/000
UA0IGV	103/000
VK5GX	100/101
VK1AI	100/000
RA3BZ	100/000

## General listing-

### Digital

VK3EBP	253/255
VK3AMK	200/202
VK3KE	177/000
VK2BQS	126/128
DL4ARJ	120/000
CT1EEN	110/000
VK5RY	100/102

## Gen-listing 2m. Open

Postion Vacant

## Gen-listing 6m. Open

VK4FNQ	137/000
CT1EEN	110/000
VK4ABW	109/000
VK6JQ	103/104
VK4CXQ	101/000

## Gen-listing-Satellite

VR2XMT	112/114
VK3XDQ	106/000

## General listing-SWL

DE2DAD	100/000
--------	---------

The following Stations listed are those that have not updated since year 2000, they are now archived 1.1.2006.

Phone: OK1ZSV, TG8NE, VK1PRG, VK2GSN, VK2MH, VK3KTO, VK3MRG, VK4CHB, VK4DA, VK4IL, VK6BH.

CW: K5QNM, UR5BCJ, VK3MRG, VK3VQ, VK4CHB.

Open: LU5DYV, VK3DP, VK3MRG, VK3VQ, VK4CHB. Digital: SP3CUG.

Awards information and down loadable files are available on our WIA website <http://www.wia.org.au/awards/> or email to: [awards@wia.org.au](mailto:awards@wia.org.au) or W.I.A. Awards Manager P.O.Box 196. Cannington. Western Australia. 6987.

Mai Johnson VK6LC  
ar

# Awards

## Mal Johnson VK6LC

	Call sign	2m	6m	10m	12m	15m	17m	20m	30m	40m	80m	160m	Bands	Total
1	VK6HD			303	256	320	286	329	295	328	312	238	9	2667 296.3
2	VK3EW			278	231	304	254	328	137	292	284	106	9	2214 246.0
3	CT1EEN		110	294	290	324	305	328	146	243	163		9	2203 244.8
4	PY2DBU			198	125	185	103	279	102				6	992 165.3
5	VK5WO			155		153		252		225	134		5	919 183.8
6	9V1RH				141	264	119	222		129			5	875 175.0
7	VK3PA			133		139		253		136	187		5	648 169.6
8	VK6LC			112		134		301		168	107		5	822 164.4
9	VK2CA			160	100	194	107	203					5	764 152.8
10	VK2DEJ					114		305		101			3	520 173.3
11	VK3KE			103		148		267					3	518 172.7
12	WA5UA			102		106		128					3	336 112.0
	Averaged		110	184	191	199	196	279	170	203	198	172	5.8	1212.9 194.9

## WIA MultiBand DXCC Program 2005

### 9BDXCC

1. VK3EW David McAulay. "Open mode" 17th May 2005. (HR & DXCCE)
2. VK6HD. Mike Bazley. "Open mode" 28th August 2005. (HR & DXCCE)
3. CT1EEN. Samuel Pimenta. "Open mode" (SK) 29th July 2005.

### 5BDXCC "Classic Award" (10-15-20-40-80m.)

1. VK6LC. Malcolm Johnson. "Open mode" 1st June 2005 (HR)
2. VK3EW. David McAulay. "Phone mode" 1st June 2005. (HR & DXCCE)
3. VK5WO. Austin Condon. "Open mode" 1st June 2005. (HR)
4. VK3PA. Allan Greening. "Phone mode" 1st June 2005. (HR)
5. CT1EEN. Samuel Pimenta. "Open mode" (SK) 29th July 2005. (HR & DXCCE)
6. VK6HD. Mike Bazley. "Open mode" 28th August 2005. (HR & DXCCE)

### 5BDXCC "Premier Award"

1. VK3EW. David McAulay. "Open mode" 1st June 2005. (HR)
2. CT1EEN. Samuel Pimenta. "Open mode" (SK) 29th July 2005. (HR & DXCCE)
3. 9V1RH. David Rankin. "Phone mode" 1st June 2005.
4. PY2DBU. Helio Carota. "Open mode" 1st June 2005.
5. VK2CA. Allan Meredith. "Phone mode" 20th November 2005.

### 3BDXCC

1. VK6LC. Malcolm Johnson. "Phone mode" 1st June 2005.
2. VK2CA. Allan Meredith. "Phone mode" 1st June 2005..
3. 9V1RH. David Rankin. "Phone mode" 1st June 2005.
4. VK3KE. Jim Baxter. "Open mode" 1st June 2005.
5. VK2DEJ. John Saunders. "Phone mode" 1st June 2005.
6. CT1EEN. Samuel Pimenta. "Open mode" (SK) 29th July 2005.
7. PY2DBU. Helio Carota. "Open mode" 20th June 2005.
8. WA5UA. Robert Kyle. "Phone mode" 2nd November 2005. (R.I.P. Samuel) WIA Awards Manager. Mal. VK6LC

*DXing ending December 2005*

# Silent Key

## William Hunter Jamieson VK2XXU

It is with deep regret that we record the passing of William Hunter Jamieson, VK2XXU, of Dunbogan, near Laurieton, NSW. He was known to his friends as Wilbur.

Wilbur passed away on Monday 28 November 2005, in hospital in Port Macquarie.

Wilbur was born in 1924. He spent much of his early years in the Hastings and Manning area. His father once owned the pub at Beechwood, and Wilbur went to school in both the Hastings and Manning areas. He attended Taree High School.

After completing his apprenticeship, Wilbur worked in the skilled metal

trades in many establishments, including Garden Island. As a mature age student, he undertook tertiary study and gained his Bachelor of Mechanical Engineering degree.

He worked as a professional engineer with Carrier Air Conditioning and in later years with the NSW State Government.

He retired in the mid 1980's and moved to Dunbogan where he took up Amateur Radio as a hobby and became licensed as VK2XXU after studying for his licence. Wilbur was a member of the Oxley Region Amateur Radio Club. After serving a year as Secretary, he took on the position of Equipment Officer, a

position that he held for many years. He still held this position at the time of his passing.

The Funeral Service was held at the Port Macquarie Crematorium on Friday, 2nd December. The Amateur Radio fraternity was well represented.

To his wife, Carol, and his family, we extend our deepest sympathy. Wilbur will always be remembered as "the perfect gentleman".

Vale: Wilbur Jamieson VK2XXU  
Submitted on behalf of the Oxley Region Amateur Radio Club Inc by Henry Lundell VK2ZHE, Secretary. Thank you to Trevor Thatcher VK2TT for providing the details

ar.



# Beyond our shores

David A. Pilley VK2AYD  
vk2ayd@wia.org.au

## UK

### RSGB new president

The RSGB appointed a new president on January 1:

Angus Annan, MM1CCR, became the next president of the Radio Society of Great Britain (RSGB). On November 19, the Society's National Council elected Annan to the position for a two-year term. He will succeed Jeff Smith, M10AEX, whom the Council had reappointed last May to continue serving through the new year because it wanted continuity of leadership in dealing with current challenges facing amateur radio in the UK. However, following a challenge based on the current wording of RSGB's Memorandum and Articles of Association, the RSGB Council, with the assent of President Smith, rescinded its earlier decision, leading to Annan's election. The RSGB Board plans to revisit its Memorandum and Articles with an eye toward updating the document.

(GB2RS)

## CANADA

### VLF record

With the H.F. bands being so poor, a few radio amateurs have turned to VLF. In Canada a new record has been made on 2,200 metres. Bill de Carle, VE2IQ, in Ontario recently received Lorne Scott Tilley, VE7TIL, from Vancouver. They were using a new digital operating mode known as Weak signal Operation Low Frequency (WOLF for short). It uses forward error correction similar to that used by deep space probes.

What makes this contact truly remarkable is that VE7TIL was transmitting with an input power of only 50 watts into a very inefficient antenna system. This resulted in his radiating less than 25 milliwatts of Effective Radiated Power to span the 3400 kilometre path.

VE2IQ's reception of VE7TIL's complete message occurred after 14 minutes with 100% certainty. Other modes such as slow speed CW that are normally employed to span such distances on 2200 metres would have taken in excess of an hour to send the

same amount of data. And that without any assurance of error free reception at the decoding station receive point.

(AR Newsline)

## USA

### Dayton Hamvention

Planning ahead? The Dayton Hamvention is the largest in the world. It is said every Radio Amateur should once in his life make a sojourn to this great event. This year it is planned for 19-21 May and is held at Hara Arena in Trotwood, Ohio. Over 25,000 visitors are expected. So if you plan to attend this year you should be making your travel plans and accommodation now. Dayton Hamvention Web site is <http://www.hamvention.org/>

## ALASKA

### HAARP gets additional transmitters

We often say we would like more power – usually to compensate for the inefficient antenna system we are using. This isn't Amateur Radio, but I believe it is possibly the biggest transmitting station as regards e.r.p. in the world. Just hope it doesn't overflow into the Amateur bands!

HAARP is getting some new radio gear. This as Continental Electronics announces that it is ahead of schedule in delivering 132 ultra-low-noise transmitters to U.S. government contractor BAE Systems for use in the High-Frequency Active Auroral Research or HAARP program.

The installation at the HAARP facility near Gakona, Alaska began in 1993 with 18 transmitters. It expanded to 48 in 1998 and will grow to 180 transmitters. When the massive planar array for ionospheric research is completed in 2007, it will include a total of 180 ten kilowatt combined transmitters, which the company is upgrading specifically for the HAARP operation. The final expansion will bring the HAARP array to full power, with ERP increasing from 84 dBW to about 96 dBW.

According to Continental, the federal government is constructing the facility to conduct upper-atmospheric and solar-terrestrial research via a phased array transmitter. The goal is to learn more about the ionosphere, a section of the atmosphere ionized by solar radiation with natural electrical currents that can be modulated with radio signals.

(ARNewsline)

## Silent key

### Bruce Fleck VK2FS

It is my sad duty to inform you all of the passing of Bruce Fleck VK2FS of Sapphire north of Coffs Harbour. His death was unexpected though his illness was terminal.

Radio was Bruce's lifelong hobby. He built his first receiver in 1939, a crystal set, on which he heard then Prime Minister Menzies inform our nation that we were at War. Joining the Royal Australian Navy as soon as he was old enough, he became an ASDIC operator and served mostly on Corvettes.

A softly spoken, quiet, kind man, Bruce's career was science orientated. After completing his University Degree, he joined the Soil Conservation Service. At one time he had six Soil Conservation

Research Stations "to keep and eye on" as he put it, but his main area of concern was the New South Wales coastline: all of it.

During his time at Griffith (NSW), he and his radio friends watched the skies with interest as the first Sputnik satellite circled the globe, even twice in one night, as his wife Alison recalls.

Bruce and Alison married in 1951 and had one daughter. Bruce is sadly missed by his wife Alison, daughter Susan, three grandchildren, one great-grandson, and the members of CHADARC Inc.

Vale Bruce Fleck VK2FS.

Submitted by Peter McAdam, VK2EVB

# VHF/UHF - an expanding world

David Smith VK3HZ - vk3hz@wia.org.au  
Leigh Rainbird VK2KRR - vk2krr@wia.org.au

## Weak Signal

David Smith - VK3HZ

Welcome back from the season of excess – not only excess of food, drink and merriment with the relatives, but also an excess of substantial and diverse propagation conditions. It's almost a shame that AR takes a break over the Christmas/New Year period as it's generally one of the busiest times for VHF/UHF openings.

Tony Mann (VK6/SWL) reports that the first Indonesian tropo opening to Perth was observed late from 1600Z 12 November to 0015Z 13 November. He was receiving the 20-400 kW ERP analogue UHF TV carriers from central Java - on 495.25, 607.24976, 623.2493, 655.25025 and 671.24956. The opening was almost missed because the usual indicators, Geraldton TV on 555.224 and ABCRN FM on 99.7, were not very strong. No reports of any contacts have been received.

The first VK2 - ZL contact for the season occurred on 5 December. Ross VK2DVZ in Taree reports that at 0750Z, he worked Nick ZL1IU on 2 m with signal reports 55 each way. The opening continued until Nick went QRT at about 0745Z. At 0801Z they exchanged reports of 51 each way on 70 cm. QSB was significant on 70 cm and they had to work hard to make the contact.

On 15 December, a widespread Sporadic E opening occurred between VK8 and VK2/3/5. Leigh VK2KRR in The Rock (near Wagga Wagga) returned home from work late afternoon, switched on and found he was hearing the Alice Springs 6m beacon. He then listened on 2 m and, to his surprise, found the 2 m beacon loud and clear. He immediately rang Jeff VK8GF at Alice Springs who dropped tools and headed for home.

In the meantime Leigh posted a message on the VK-ZL logger to inform others and called Brian VK5UBC. Leigh found he could access the Alice Springs 2 m FM repeater and made contact with Jeff as he was driving home. Leigh also worked Charlie VK8HW on the repeater. Charlie could actually hear Leigh direct on his indoor dipole – impressive for over 1800 km.

Jeff arrived home and called on 144.1 SSB. His first contact was with Leigh who was receiving Jeff 5/9+20. Jeff then managed to work Rob VK1ZQR in Canberra (Jeff's 1st VK1 on 2m), David VK3HZ in Melbourne, Gary VK5ZK at Goolwa 60km south of Adelaide and Brian VK5UBC at Gawler 40km north of Adelaide.

In Melbourne, the VK8 2 m beacon was first heard at 0540Z up to S5. It remained audible - with some gaps - until 0655Z.

On 18 December, there was another Sporadic E opening, this time from VK4 to VK2/3. At around 0550Z, Leigh VK2KRR managed to work VK4ABW (Townsville), VK4MIK (Butchers Creek) and VK4FNQ (Charter Towers). Trevor VK3VG in north central Victoria reports working VK4FNQ (5/9), VK4ABW (5/9) and VK4MIK (5/2). Doug VK3UM reported hearing some voices from just north of Melbourne, but did not manage a contact. Joe VK7JG also reports hearing snippets of the VK4s.

On 24 December, Andy VK2AEH worked Nick ZL1IU on 2 m. John VK2TK also worked Nick at around this time, with signals peaking at S6 (over S3 noise).

On 31 December, Nick ZL1IU was in the thick of the action as the bands opened between ZL and VK2/3/4/7. Oddly, no other ZL stations could be heard in VK3. Robbie VK3EK near Bairnsdale was one of the first VK3s to work Nick, on both 2 m and 70 cm and continued to hear him for over nine hours. Stations who managed contacts on 2 m with Nick were VK2FZ (also 70 cm), VK2AWD, VK2AH, VK2BHO (also 70 cm), VK3DMW, VK3EK (also 70 cm), VK3ZYC, VK3KAI, VK3UH, VK3DUT, VK2BZE, VK3WRE, VK3BBB, VK2FHN, VK2BHO (also 70 cm), VK2DVZ, VK2EAH, VK2TG, VK2ZT, VK3TDV, VK3EBQ and VK3VHF.

The most westerly station worked on 2 m was David VK3QM in Lara. They also tried on 70cm but, apart from hearing traces of each other, were unable to complete a contact. Ron 3AFW and

Andrew 3KAQ in Melbourne heard traces of Nick on 2 m, but no contact was achieved.

Rex VK7MO reports that, on New Years Eve, he returned home to see on the logger that Robbie VK3EK had been working into ZL. A quick CQ and Nick ZL1IU was worked 5/1 both ways on 2 m for a new VK7 record at 2431 km. Rex asked Nick if he would be around for a while as he would like to try 70 cm and had not rebuilt his 70 cm Yagi since returning from Christmas Island. After 15 minutes Rex told Nick it was taking longer than he expected and by this time signals had risen to 5/9 +10 on 2 m. Nick kept saying very firmly "hurry" while continuing to talk to Adrian VK2FZ and Jim VK3ZYC on 2 m. Another 15 mins went by and still no 70 cm antenna with Nick now yelling "hurry" as 2 m signals reached 40 over 9. Another 10 mins and the 70 cm Yagi was finished and a 5/9 70 cm contact completed for another VK7 record. Rex then asked Nick if he had 23 cm to which Nick replied he had a Yagi in the shed and could set it up on a pole outside. Nick was outside holding the antenna, leaning inside the window to tune the rig and while no contact was completed signals were copied each way on 23 cm at S2. All goes to show, one should have everything prepared in advance for the tropo season.

Nick comments that "Rex VK7MO blew me away when he came up on 2 m and we also had S9+ sigs on 70 cm". He also said that signals from VK4 were also evident, but he was concentrating on the rarer southern stations. The VK3RGI beacon was huge to him at times, audible over several hours. The beacon at Nimmitabel was also coming in well at times.

The busy times continued on 2 January. Enhanced tropo conditions across the south of the country had been evident from early in the morning with the Albany 70 cm beacon audible as far east as Melbourne and to Leigh VK2KRR. Unfortunately, the 2 m beacons at both Esperance and Albany were temporarily off-air. At 2350Z, Colin VK5DK in

Mount Gambier worked Wal VK6WG in Albany.

Then, at 0010Z, Leigh VK2KRR managed to work Wayne VK6JR near Busselton (south of Perth) on 144.1 over a distance of 2933 km. That distance exceeds both the current VK2 and VK6 records. Leigh and Wayne first made contact on 6 m, then Wayne put up a carrier on 2 m that Leigh was most surprised to hear. Wayne's 30 W and 9 elements received a 5/2 from Leigh while Leigh's 400W / 4x17 el gained a 5/5. Wayne then rapidly drove up to a nearby high point to try 70 cm, but no luck with that. Gary VK5ZK also managed to work Wayne – the path from Leigh to Wayne passing almost directly over Gary's QTH.

The Hepburn chart showed a straight line of tropo enhancement virtually from Leigh's front door to Wayne's QTH. However, looking at the Indian Ocean chart, it appears that the duct could have continued much further out across the ocean, almost to Mauritius. What chance a VK(2) to 3B8/9 (Mauritius) contact?

To add to the confusion, at the same time, a Sporadic E opening was in progress between VK2/3/5 and VK4 (Yeppoon and Charters Towers). The opening was fairly unusual in that enhancement would occur to a particular (very localised) location only for brief periods – almost like extended meteor scatter enhancement. Many stations reported hearing other stations calling, only for the enhancement to disappear before a contact could be made. Others, not too far away, would hear nothing.

Several theories have been put forward to explain the very sporadic nature of the enhancement. Ron VK3AFW wonders if meteors passing through the E layer were causing extended E's ionisation, but only for several minutes after the meteor had passed. Denis VK3ZUX noticed that on the Weatherzone site, there was a significant lightning storm in progress around the mid-north of NSW – at about the mid path of the enhancement. There is a theory that sprites rising upwards from a lightning storm into the E's region can cause short-term sporadic E enhancement.

On 10 January, a high-pressure cell caused significant tropo enhancement between VK5 and VK7. Brian VK5UBC reports that from his holiday house at Corny Point, he worked VK7YBI and VK7AC, both on the north coast of Tasmania.

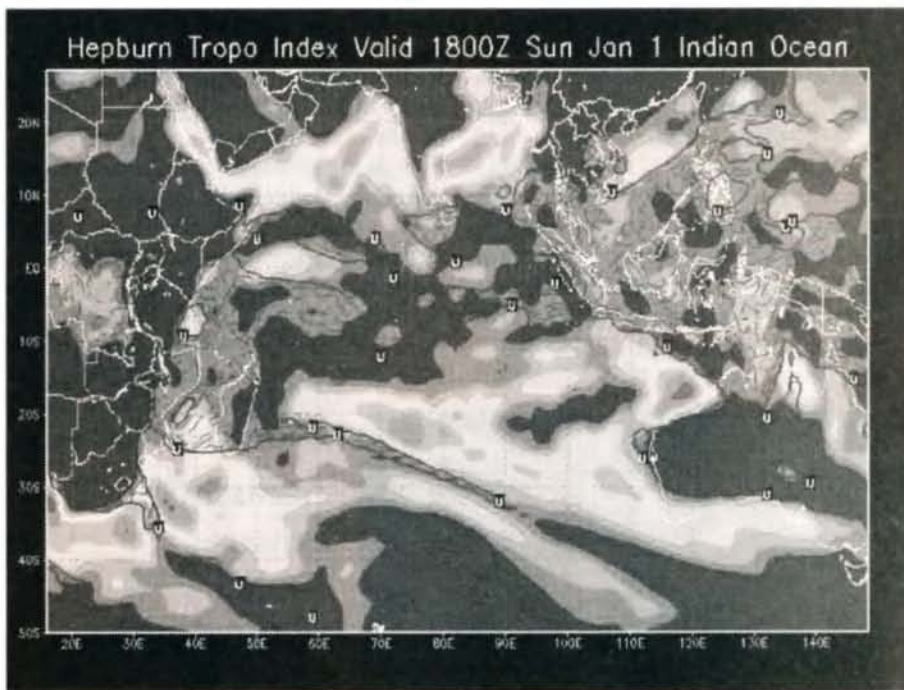

The Hepburn chart

## New 2.4 GHz ATV record

ATV doesn't get much of a mention in this column, but it is alive and well in many areas of the country. Mark VK5EME has developed many easy-to-build kits that can get you onto ATV on any band from 70 cm to 10 GHz, relatively easily. Check out his web site for more details: [www.minikits.com.au](http://www.minikits.com.au)

Jack Swart VK2TRF reports that he worked Jonathan Berry VK2TAS on 18 December for a new ATV distance record for the 2.4 GHz band. Station locations were VK2TRF near Mt. Warrawolong, and VK2TAS at Mt. Gibraltar. The distance was 173.9 km.

“Both transmitters comprise G1MFG 2.4 GHz excitors driving ex-MMDS PA's producing upwards of 20 watts. The dishes are modified commercial wireless LAN antennas giving about 22dBi of gain. The receivers are standard G1MFG modules which are very sensitive but prone to interference on this band



from AV senders and wireless LAN systems. Mercifully we did not encounter any interference due to our remote location but Jonathon, perched right on top of Mittagong, suffered some.

We still managed 2-way colour QSOs with audio. Digital video tapes were recorded at both ends for later study. Dave VK2GIO received Jonathon VK2TAS signals from Mt Gibraltar but nothing was seen from Jack VK2TRF except by Jonathon on Mt Gibraltar.

Thanks to Dave VK2GIO and Rod

VK2BQJ for their patience and help in this endeavour. Their skill and dedication to me (a newbie licensed since 24/12/04) is a great example of the amateur spirit. Also, many thanks to the Westlakes Radio Club for providing dedicated amateurs and their 4WD vehicles to enable us to access the remote location used. Amateurs involved at the Newcastle end were Jack VK2TRF, Dave VK2TDN, Steve VK2UD, Pete VK2YGM, Pete VK2TPW, Karen VK2ZKG and Matt VK2ZMT. Irene, VK2YGM's XYL, supplied a fantastic lunch for all.

## Annual Grid Squares Table (AGT) Competition

Adam VK4CP – creator of the very useful VK-ZL Logger site ([www.vklogger.com](http://www.vklogger.com)) has initiated a new competition in the hope of generating

some greater activity on the VHF/UHF bands.

As many will be aware, there is an established Grid Square League Table, maintained by Guy VK2KU on behalf of the NSW VHF DX Group. This table is an on-going and cumulative record of the number of grid squares worked by the entrants on the VHF, UHF and microwave bands.

Adam has created an annual competition, where the slate is wiped clean at 000Z on 1 January each year. Apart from that difference, the rules are virtually identical to those for the Grid Square League Table. Adam's intention is simple - to stimulate activity by making everybody start on a level playing field each year.

Adam has created a web page for the competition – [www.vklogger.com/agt](http://www.vklogger.com/agt). As of 13 January, 35 stations have already registered their tallies on the page. Full rules of the competition may also be found there.

Please send any Weak Signal reports to David VK3HZ at [vk3hz@wia.org.au](mailto:vk3hz@wia.org.au).



## Digital DX Modes

Rex Moncur – VK7MO

Waldis, VK1WJ, and Graeme, VK3GOM, have been testing a number of digital modes for use on 2 metres via Aircraft Scatter between Bendigo and Canberra on signals too weak for SSB. The signals exhibit rapid fading that seems to result from interference between the signal scattered from the aircraft and tropospheric scatter. The choice of mode is a compromise between being fast

enough to cope with the rapid fading while having sufficient sensitivity to take advantage of the weaker signals. Their experiments have concluded that the preferred mode is PSK63F.

Waldis has information on his web site ([www.geocities.com/wilgonis/digiar.htm#AE2](http://www.geocities.com/wilgonis/digiar.htm#AE2)) on how to obtain the programs for various modes and the QSO procedures that are being used.

If you are interested and within Aircraft Scatter range of Canberra or Bendigo (900 km) you are welcome to contact either Waldis VK1WJ: [ilgonis@netscape.net](mailto:ilgonis@netscape.net) or Graeme VK3GOM: [vk3gom@yahoo.com.au](mailto:vk3gom@yahoo.com.au).

Please send any Digital DX Modes reports to Rex VK7MO at [rmoncur@bigpond.net.au](mailto:rmoncur@bigpond.net.au).

## The Magic Band – 6 m DX

Brian Cleland – VK5UBC

December began with good openings on the 1st and 2nd down the eastern seaboard, including VK7 and northern Queensland. As well as the contacts between the eastern states, a good opening to JA occurred from VK3 and VK7 on 1st December with another opening from VK3 to JA on the 2nd. On 2nd December South Australia got into the act with openings to VK4 and VK2, and again on 3rd December. On the evening of the 2nd the band was still open from SA to Queensland at 11.00 pm and was again open at 8.00 am next morning, 3rd December. Jeff VK8GF at

Alice Springs was active on the evening of the 2nd and worked many VK3 and VK5 stations. On the morning of 4th December the band opened between VK5 and ZL, and in the afternoon a brief opening occurred to JA with Brian VK5UBC working JA2DDN.

The first couple of weeks of December saw openings on most days but conditions were very unsettled and varied rapidly. A good opening did occur though from VK2 to VK5 on 7th December, which extended from VK2 to VK6 in the late afternoon and early evening.

On the afternoon of 13th December

Col VK5RO and Brian VK5UBC had an interesting contact with Mike VK3BDL mobile on the Nullarbor Plains near Caiguna approx 500 km past the SA border who was driving to Perth to see the test cricket. Signals were 5/9 and they maintained contact for over an hour, including going to FM with again 5/9 signals. Mike was running 100 W to a vertical.

In the second half of December the band settled with good openings occurring on most days. VK4 seemed to get the best of conditions with openings to the south and VK5. The FK8 beacon

was audible on many days in this period in VK2, 3, 4 and 5 but unfortunately very few FK8 stations were heard or worked. Wayne VK4WS, who was portable at Nambour much of December, reports working Patrice FK8HA using an FT817 and a 5/8 2 m whip on 10th December with a 5/7 report. Wayne also worked Henri FK1TK on 20th December and Michel FK8GX on the 24th, both these contacts though with 100 W and an ended 6 m 1/2 wave vertical.

Good openings to ZL occurred on many days in December from all eastern states and VK5. As usual Norm VK3DUT worked ZLs on a regular basis but good

openings extended to VK5 on 21st and 29th November and on 3rd, 13th, 14th and 26th December. VK2 had regular openings to ZL in December and VK4 got into the act on several occasions with John VK4FNQ at Charters Towers working ZLs on 17th and 21st December.

Good VK6 openings to VK4 happened on 30th December and 6th January with Wayne VK4WS working VK6RZ, AB, IP, JJ, RO, DU and HK.

Had a note from Bill VK3DOU who made his first VK6 contact with VK6IP using CW on 29th December. Well done Bill!

Had an interesting contact with VK7JG/m near Tomahawk on the north-east tip of Tasmania from my holiday QTH, Corny Point (PF85mc) on the 7th January, Joe's signal was 5/9+++ from his car.

As I reported in the December notes, the Barossa beacon VK5RBV on 50315 has been fully operational from early December. Reports have indicated that it is being well received all over Australia.

Please remember to send any 6 m information to Brian VK5UBC at [bcleland@picknowl.com.au](mailto:bcleland@picknowl.com.au).

## 2 m and 70 cm FM DX

### Leigh Rainbird - VK2KRR

A bit behind after the Christmas break, so this edition covers DX happenings from November and December. There was quite a bit of good DX over these months, but here is a compacted summary.

November was fairly quiet in most parts. A few tropo openings were reported in the country's SE and Queensland, but these were short lived and weak.

In December, the first real opening occurred on the 05/12 in the southeast. I was able to get to the majority of the Adelaide area repeaters such as Murray Bridge, Lobethal, Crafers, Barossa Valley, all around 750 km. I found I could also access Central North at 833 km, Port Pirie at 867 km and Cowell at 961 km.

From 10/12 to 15/12, good conditions were available in Queensland along the coast and ranges. Mike VK4MIK on the Atherton Tablelands, worked into Hodgson Range at 640 km, Blue Mountain at 581 km, Monto at 951 km, Mackay at 535 km, Hayman Is. at 451 km, Blackdown Tablelands. Felix VK4FUQ at Ingham has also been very active and working to similar locations as Mike.

A rare Sporadic E opening on the 15/12 saw 146 MHz signals pass between Alice Springs and areas of the south east. All contacts were on SSB, but I was able to work into the Alice Springs repeater on 146.950 VK8RCA. Signals had some bad QSB at times, but QSO were achievable. The distance to the repeater from here is 1804 km. I was able to work via the repeater with Jeff VK8GF mobile in Alice Springs, I could hear Jeff on reverse, and also Charlie VK8HW at Alice Springs

who reported being able to hear me on reverse with his indoor dipole antenna. Unfortunately I could not hear him.

Again on Sporadic E, Felix VK4FUQ at Ingham got a rather sporadic 2m opening down the coast. Felix made it to the Glen Innes repeater on 146.950 VK2RNE. He made a brief contact with Mike VK2FMB in Glen Innes. Felix mentions that Garry VK4ABW also got into the same repeater from near Townsville.

While on a cruise on the "Pacific Sun" in mid December, Rob VK2MT encountered a major VHF opening between Noumea, where the ship was moored, back to VK2 and 4. Between a hilltop above Noumea and also on board the ship, using just his VX-7R handheld, he was able to access many VK2 and VK4 repeaters. At one stage, every repeater frequency from 6625 to 7100 returned one, if not two or three repeater tails when triggered.

Contacts were made via the following repeaters: VK4RAX Brisbane, VK4RSC Sunshine Coast, VK4RRC Redcliffe, VK4RGG Gold Coast and VK2RGL Great Lakes.

Stations contacted were VK4KOR, Spiro VK4IBR, June VK4SJ (M), Wayne VK4TWD, Bernard VK4KAC, Ray VK4YRS, Phil VK4KVK, Lee VK4KLA, Frank VK3DYE (P4), Greg VK4AML, Graham VK4JGH, Peter VK4TGV (M), Allan VK4HDM, Warwick VK4NW, Garry VK2UNI, Keith VK2AT and John VK2SWR. Signal strengths varied from S2 to S9, with some signals being saturation S30+, with many of these stations also being contacted via simplex.

The only thing that stopped more contacts was a flat battery, but that was after more than 2 hours of contacts.

Mpeg recordings were made on his digital camera of many of these contacts which helped with logging later on, plus to prove to the many doubters that these were genuine contacts. He has already e-mailed some of these recordings to those who have supplied their e-mail details.

The furthest repeater he heard and was able to partially access was his home repeater VK2RMP at Wollongong. Unfortunately, no contact was made. Distances achieved varied from 1475 km through to 2056 km.

He also notes that the FK8ZHA 2m repeater appears to require audio to access, not just carrier.

Big tropo opening in the SE on the 19/12. Very big signals from the areas surrounding Adelaide. Full scale signals from the main repeaters at 750 km. Worked VK5PO at 5/9+50 dB signal from Eden Valley 738 km on 146.500. Brian VK5UBC was able to access Macedon, Bendigo, Shepparton, Canberra, Ararat and Grampians.

On the 30/12, Felix VK4FUQ worked into the Newcastle repeater and spoke to VK2FA. Signals were weak to S5 with QSB. The Sporadic E only lasted for around 20 mins.

There is DX out there for those that want it. Have fun.

Please remember to send through any 2 and 70 FM DX reports to Leigh VK2KRR at [vk2krr@wia.org.au](mailto:vk2krr@wia.org.au)

ar

**Adelaide-London**

**132**

First F 0-5 Long 23755 km

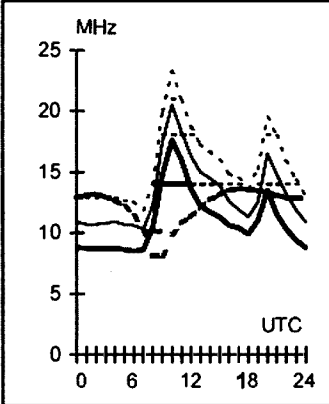

**Brisbane-Dunedin**

**148**

First F 5-8 IE0 Short 2561 km

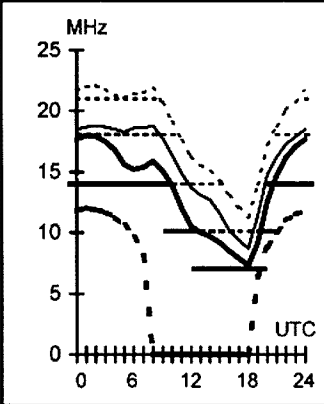

**February 2006**

T index: 16

**Legend**

Frequency scale

- UD
  - F-MUF
  - OWF
  - E-MUF
  - ALF
  - >10%
  - >50%
  - >90%
- Time Scale

**HF Predictions**

by **Evan Jarman VK3ANI**  
34 Alandale Court Blackburn Vic 3130

These graphs show the predicted diurnal variation of key frequencies for the nominated circuits.

These frequencies as identified in the legend are:-

- Upper Decile (F-layer)
- F-layer Maximum Usable Frequency
- E-layer Maximum Usable Frequency
- Optimum Working Frequency (F-layer)
- Absorption Limiting Frequency (D region)

Shown hourly are the highest frequency amateur bands in ranges between these key frequencies, when usable.

The path, propagation mode and Australian terminal bearing are also given for each circuit. These predictions were made with the Ionospheric Prediction Service program: ASAPS Version 4

**Adelaide-London**

**312**

First F 0-5 Short 16269 km

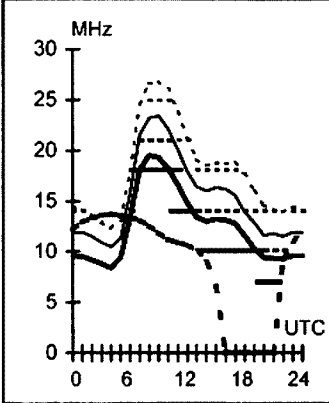

**Brisbane-Honolulu**

**49**

Second 3F5\*9 3E0 Short 7569 km

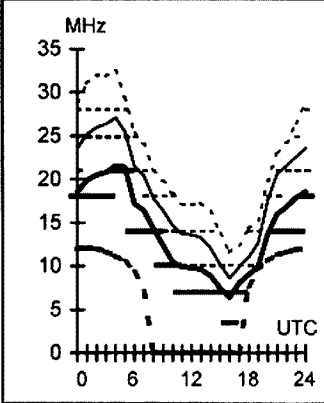

**Canberra-New York**

**68**

First F 0\*5 Short 16217 km

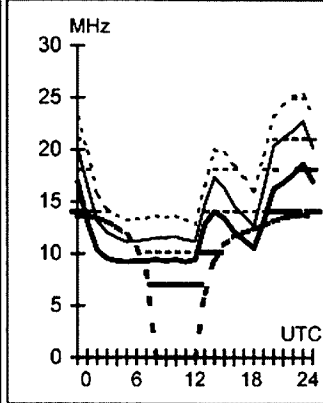

**Darwin-Auckland**

**130**

First 2F5-8 2E0 Short 2156 km

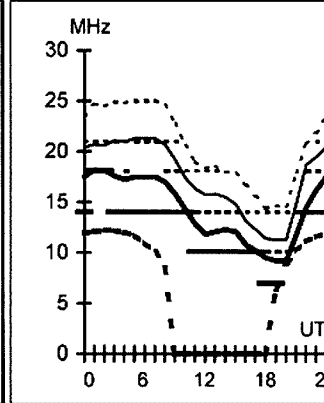

**Adelaide-Manilla**

**338**

Second 3F9-16 3E1 Short 5813 km

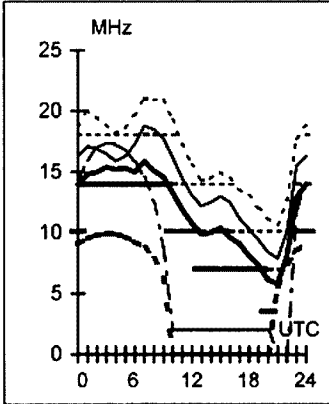

**Brisbane-Miami**

**79**

First F 0-5 Short 14761 km

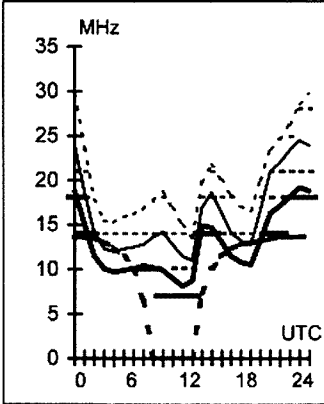

**Canberra-Tokyo**

**352**

Second 3F3-8 3E0 Short 7948 km

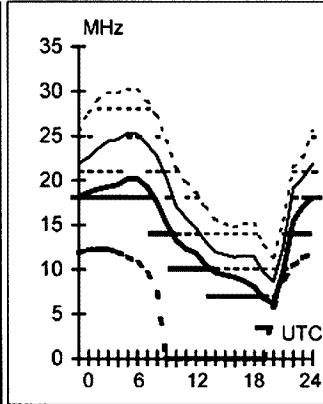

**Darwin-New Delhi**

**309**

Second 3F5-11 3E0 Short 7345 km

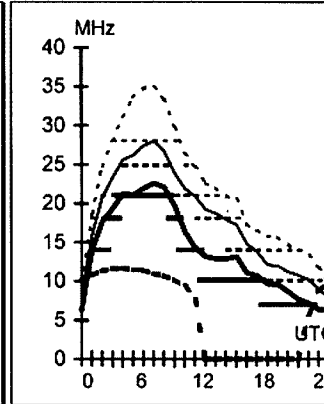

**Adelaide-Vancouver**

**59**

First F 0-5 Short 13421 km

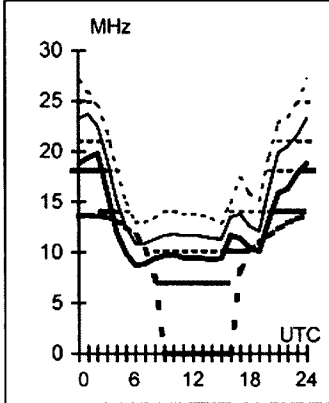

**Brisbane-Singapore**

**295**

Second 3F9-14 3E0 Short 6146 km

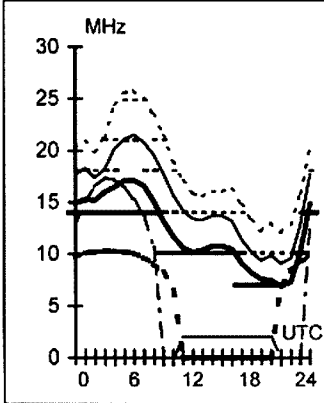

**Canberra-Washington**

**70**

First F 0-5 Short 15938 km

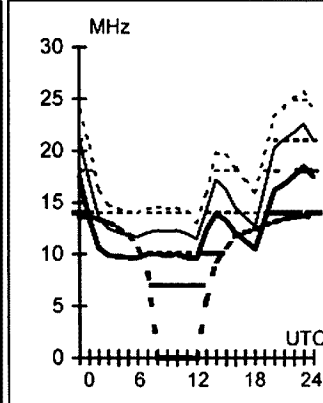

**Darwin-Osaka**

**5**

Second 3F11-18 3E Short 5262 km

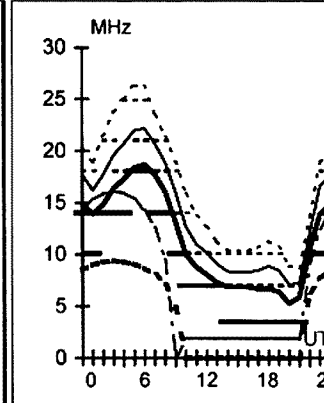

**Hobart-Cairo** 278 **Melbourne-Moscow** 316 **Perth-Dakar** 259 **Sydney-Barbados** 119

First F 0-5 Short 14266 km First F 0-5 Short 14428 km First F 0-5 Short 14918 km First F 0-5 Short 16155 km

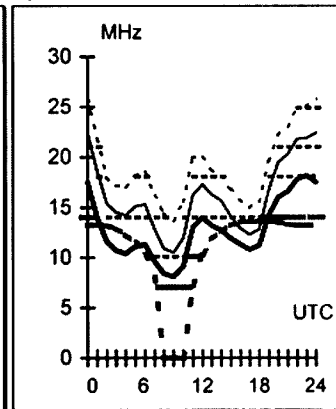
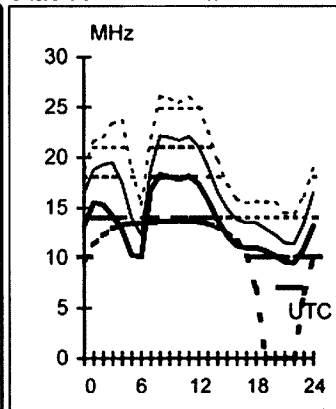
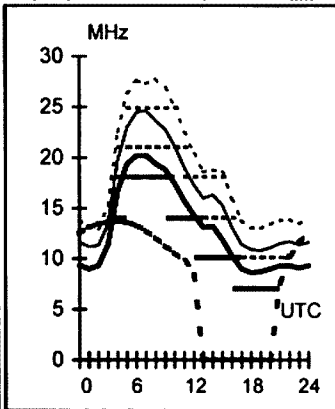
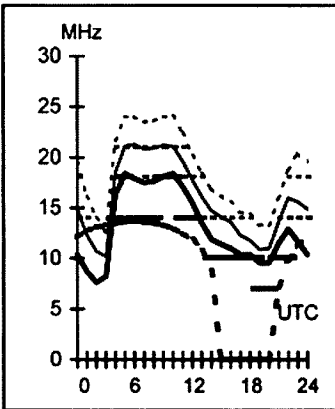

**Hobart-CapeTown** 220 **Melbourne-Ottawa** 63 **Perth-Johannesburg** 248 **Sydney-London** 139

Second 4F5-10 4E0 Short 10026 km First F 0-5 Short 16566 km Second 4F8-14 4E0 Short 8315 km First F 0-5 Long 23032 km

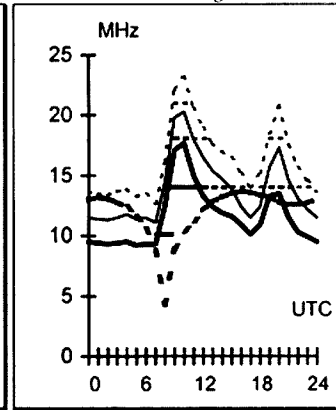
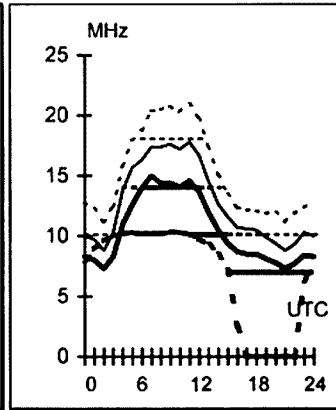
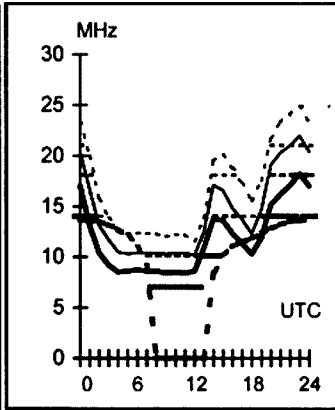
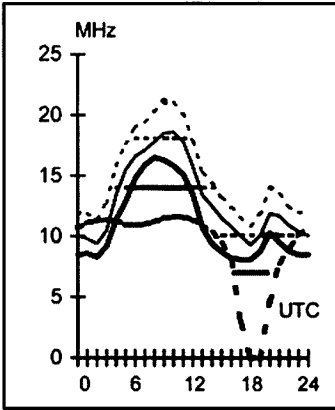

**Hobart-Chicago** 72 **Melbourne-Seattle** 50 **Perth-Montevideo** 187 **Sydney-London** 319

First F 0-5 Short 15576 km First F 0-5 Short 13178 km First F 0-5 Short 12536 km First F 0-5 Short 16992 km

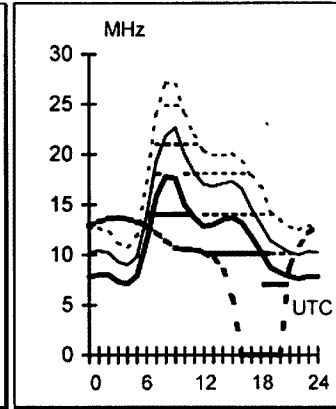
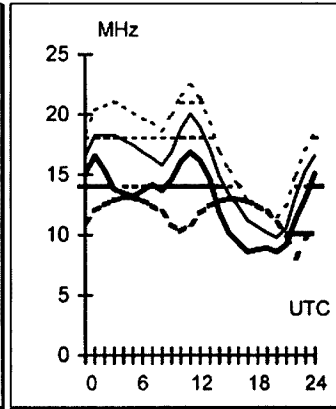
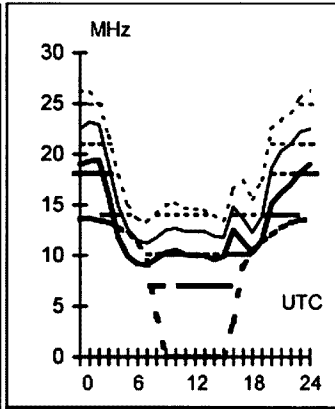
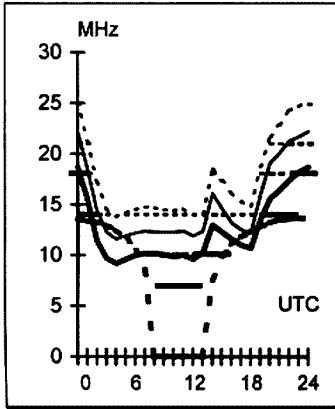

**Hobart-Santiago** 149 **Melbourne-Sofia** 296 **Perth-Tel Aviv** 302 **Sydney-Warsaw** 133

Second 4F4-6 4E0 Short 10688 km First F 0-5 Short 15132 km Second 4F3-7 4E0 Short 11091 km First F 0-5 Short 24435 km

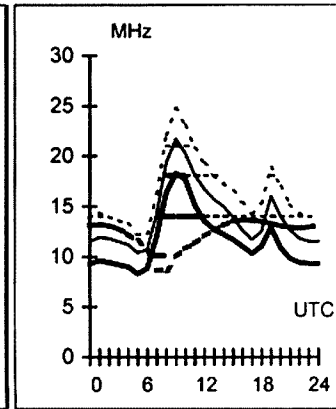
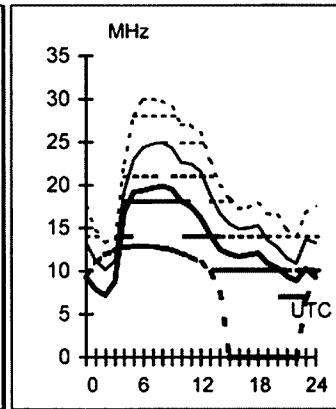
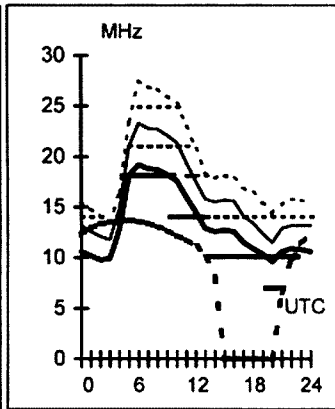
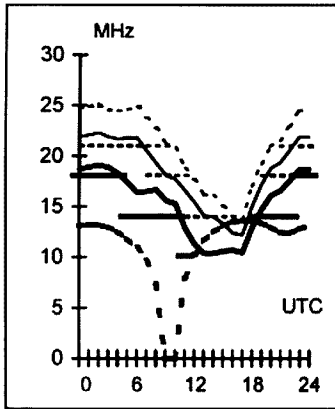

# Hamads classifieds **FREE**

## FOR SALE NSW

•Eddystone recvr model 940 0.5 to 30 MHz VGC. Best offer gets it. Call 0438 218 897.

•Ten-Tec 20/6 metre transvertor, brand new and in mint condition, 10 watt output \$200. Yaesu FT-290R MkII with matching Yaesu FT-2025 linear amplifier (25 watt); it comes with rubber flexible antenna, NiCads and mobile cradle \$390. Yaesu FT-1500 2 m mobile FM, 50 watt output, in mint condition, with mike, mobile mounting bracket, etc. Original package. \$300. Mirel, VK2BOD. Email adslqls8@tpg.com.au. Phone 02 4333 1823.

•Icom IC706 MKII HF/VHF transceiver, excellent cond. With 240 volt Kenwood p/supply, EAT 300 manual. Ant tuner, all options, portable cables etc. \$1350 ono. Doug, VK2DDR 02 9949 3426.

•Panasonic KX-P1180 Printer, \$10; 2 x FM828 A, \$15 ea; 4 x LDF4-50 female N connectors, new; \$10 ea; 8 metres LDF5-50 coax, \$20; 6.5 metres LDF 4-50 coax, \$10; Roger Woodward, VK2DNX. Rogerwoodward10@hotmail.com, 02 9547 2546.

## FOR SALE VIC

•Bushcomm PLW HF portable antenna, Broad band, 3 - 30 MHz, no tuner req. Ideal for field day or travelling, \$200. SGC ADSP2 DSP speaker, as new, \$150. VK3JM Phone 03 9801 4972.

•Philips FM 815 UHF repeater. T band 403 - 420 MHz. All interconnecting cables and set up with 3 second tail, time out timer and CTCSS decoder. \$100. Can be delivered to Melbourne. Bob Neal. VK3ZAN. Ph 03-51567654. Email dotbob@netspace.net.au

## WANTED VIC

•I am trying to restore an AN/TRC24 radio system and am particularly interested in the following parts: The transmitter unit T-302/TRC and its power supply PP-685/TRC as well as other parts such as the receiver R-417/TRC. I have about half of one station and am trying to find the parts to complete it. Can anyone help with this? John Eggington VK3EGG Mobile: 0409 234 672.

•Wanted for an aged and slightly infirm FT-101E a pair of pre-loved or new 6JS6C PA tubes. Any reasonable price. John VK3BAF 03 8502 8627 or email vk3baf@jeack.com.au.

## FOR SALE QLD

•ICOM IC25A 25 watt transceiver, with mike, and cradle. Little used, \$250. Contact VK4KD QTHR or 07 5578 2293 or jessy8@optusnet.com.au.

•Yaesu FR 101 receiver, all bands plus 4 MHz marine bands. Includes speaker and books. \$100 or close. Located Mt Tamborine (near Gold Coast QLD) ph. 07 5545 3004.

## WANTED QLD

•Australian official Radio Service Manual Volume 13, Year 1954. Will pay all costs and postage. Frederick (Eric) VK4ZAJ QTHR, Phone 07 3359 9424.

•Set of ICOM rack mounting handles, with or without screws. Happy to pay good price. Ron VK4QM QTHR Phone 07 5488 0268, email jvette@bigpond.net.au.

•Circuit diagrams for KLB1100 and KLB300 solid state amplifiers. Both were made in Japan but no further information on same. I would appreciate any info especially circuit diagrams. All expenses refunded. VK4DV QTHR

## FOR SALE SA

•Antennas for mobiles, ground, independent and elevated feed types. Bruce VK5VK 08 8298 3906.

•Aerial analyser to design by Jim VK5JST. Complete and working. Measures SWR, resistance and reactance over frequency range, 1.3 to 31 MHz. Assembled from Elizabeth Amateur Radio Club kit, \$200 incl. P&P. Phone 08 8280 7430 Keith VK5OQ QTHR.

## WANTED SA

•Technical information on AWA Teleradios from the 1950s onwards, particularly type 65, 80, 90, 215/220 and SS220, 235 sets. A photo of the type 80 needed. M Haskard VK5BA QTHR; Ph/ fax 08 8280 7192; mhaskard@chariot.net.au

## THE WIA QSL COLLECTION REQUIRES QSLs

All types welcome, especially rare DX pictorial cards, special issue. Please contact the Hon Curator, Ken Matchett VK3TL, 4 Sunrise Hill Road, Montrose Vic 3765, tel. (03) 9728 5350

## WWW.RADIOSPECIALISTS.COM.AU

Yaesu authorized Dealership in Adelaide

### Shopfront sales and not a backyard shed

243 Seacombe Road South Brighton SA  
The Radio Specialists serving Adelaide.

## RM Products Italy

are now available in Australia after the appointment of

Hamak Electrical Industries Pty Ltd

as distributor for RM products

Visit the Hamak website at

**Hamak.com.au** for

**Linear amplifiers,  
Power supplies  
and accessories**

## ADVERTISERS INDEX

AEI.....	9
Andrews.....	8
Benelec.....	IFC
Com-an-tena.....	16
TET-Emtron.....	28
G & C.....	23
Icom.....	OBC
Masta tek.....	9
Ozgear.....	35
Nippletech.....	55
TTS.....	22
Small ads.....	55
VK Discount Cables.....	17
KVK Books.....	40
Winlink.....	23
www.vk3ajj.com.....	55

# About hamads....

- Hamads may be submitted by email (preferred) or on the form on the reverse of your current Amateur Radio address flysheet. Please print carefully and clearly, use upper AND lower case.
- Separate forms for For Sale and Wanted items. Please include name, address STD telephone number and WIA membership number if you do not use the flysheet.
- Deceased estates Hamads will be published in full, even if the ad is not fully radio equipment.
- WIA policy recommends that the serial number of all equipment for sale should be included.
- QTHR means the address is correct in the current

WIA Call Book.

- Ordinary Hamads from those who are deemed to be in general electronics retail and wholesale distributive trades should be certified as referring only to private articles not being re-sold for merchandising purposes.
- Commercial advertising (Trade Hamads) are pre-payable at \$25.00 for four lines (twenty words), plus \$2.25 per line (or part thereof). Forty word maximum, minimum charge of \$25.00. Cheques are to be made out to: WIA Hamads.
- Copy typed or printed clearly please, and received by the deadlines shown on page 1 of each issue of Amateur Radio.

Email: [newunltd@bigpond.net.au](mailto:newunltd@bigpond.net.au)

Postal: Newsletters Unlimited, PO Box 431, Monbulk Vic 3793. Fax: 03 9756 7031

### TRADE PRACTICES ACT

It is impossible for us to ensure that the advertisements submitted for publication comply with the Trade Practices Act 1974. Therefore, advertisers and advertising agents will appreciate the absolute need for themselves to ensure that the provisions of the Act are strictly complied with.

### VICTORIAN CONSUMER AFFAIRS ACT

All advertisers are advised that advertisements containing only a PO Box number as the address cannot be accepted without the addition of the business address of the box-holder or seller of the goods.



## Rippletech Electronics

New to radio or perhaps need a new challenge? Want to earn the WIA's new 5BDXCC award? With a Nally tower, an 80m sloper and a 40m rotary dipole you can get low band DXCC, even from your city lot! Want DXCC on the WARC bands? The WARC band dipole on placed above your traditional tribander will get you there.

Like to travel with your new micro radio? Grab a TZ-V-3 which packs down to only 1m long, fits in the boot or on a plane & assembles in minutes. Outperforms lossy super wideband designs.

TZ-1840	1:1 1kW 160-10m Balun (1.8- 40 MHz)	\$ 59.00
TZ-330-4	4:1 1 kW HF Balun (3 - 30 MHz)	\$ 59.00
TZ-SL8	80m Sloper (use tuner for 17 & 30m)	\$ 99.00
TZ-SL16	160m Sloper (fits in a suburban lot!)	\$ 110.00
TZ-D-4080	40m/80m Trapped Wire Dipole	\$ 176.00
TZ-V-3	10/15/20m Trapped Vertical	\$ 189.00
TZ-V-4	10/15/20/40m Trapped Vertical	\$ 289.00
TZ-RD-3	10/15/20m Trapped Rotary Dipole	\$ 199.00
	Vertical Radial kits (1 rad. per band)	\$ 33.00
TZ-V-3w	12/17/30m Trapped Vertical	\$ 279.00
TZ-RD-3w	12/17/30m Trapped Rotary Dipole	\$ 289.00
TZ-RD-40	17/40m or 20/40m Rotary Dipole	\$ 279.00
TZ-1000RC	FT-1000mp remote controller acc	\$ 33.00
	5th Order HPF TVI Filter (coming)	\$ 39.00
	Mobile whip base & Z bracket combo	\$ 11.00

Our trapped antennas use high Q, high isolation coaxial traps which are fully scaled and exhibit 40 dB of isolation at the resonance.

Need something special?

Give me a call and we'll see if we can meet your needs.

[www.rippletech.com.au](http://www.rippletech.com.au)

Contact Tony - VK3TZ  
0402 622 562 or email  
sales@rippletech.com.au

Mastercard, Visa and Bankcard accepted

"Hey, Old  
Timer..."

If you have  
been licensed  
for more

than 25 years you are  
invited to join the

Radio Amateurs  
Old Timers Club  
Australia

or if you have been licensed for less than 25 but more than ten years, you are invited to become an Associate Member of the RAOTC.

In either case a \$5.00 joining fee plus \$8.00 for one year or \$15.00 for two years gets you two interesting OTN Journals a year plus good fellowship.

Write to  
RAOTC,

PO Box 107

Mentone VIC 3194

or call Arthur VK3VQ on 03 9598 4262 or

Bill VK3BR on 03 9584 9512,

or email to raotc@raotc.org.au

for an application form.

## AMIDON FERROMAGNETIC CORES

For all RF/electronic applications.

See our website for complete data on all cores including prices.

[www.catchnet.com.au/~rjandusimports](http://www.catchnet.com.au/~rjandusimports)

RJ & US Imports

PO Box 431, Kiama NSW 2533.

A 3.5" PC disk containing all data is available for \$5.00 incl. post.

### Agencies

Active Electronics, Tas  
TTT Systems, Tyabb (VIC)  
Tower Communications, Perth  
Ozhel Services, Brisbane

## HF, VHF, UHF ANTENNAS & ACCESSORIES

Aluminium towers, guys etc

Diamond VSWR/PWR meters.

HD copper antenna wire & insulators,  
TX tubes & pwr transistors,  
full range Create Rotators

Quality coax cables & connectors.  
Free advice & catalogue.

### ATN Antennas

Ph 03 5492 2224 Fax 03 5492 2666,

email atnant@iinet.net.au  
PO Box 80, Birchip Vic 3483

## JACKSON BROS JACKSON OF THE UK IS BACK

Highest quality products made by UK craftsmen

[www.jacksonbrothers.com.au](http://www.jacksonbrothers.com.au)

Full range now off-the-shelf in Australia.

Variable and trimmer capacitors, reduction

drives, dials, ceramic standoffs

CATALOGUES, PRICE LISTS AVAILABLE

CHARLES I COOKSON PTY LTD

11-13 Port Rd

Queenstown SA 8014

Tel: (08) 8240 3200

Fax: (08) 8240 3233

FreeFax 1800 673355 within Australia

Email: sales@jacksonbrothers.com.au

ALL MAJOR CREDIT CARDS ACCEPTED

SOLE AGENTS AUSTRALIA AND NEW ZEALAND



## Tunable Loop Antenna enhances AM Reception

AM radio reception (530 to 1900KHz) enhanced. Reception where none existed before; works indoors, even in interference-polluted areas High value — low cost.

Simple, no connections or batteries  
Ideal for touring, caravan, boat and fringe areas. Use anywhere.

[www.amradioantennas.com](http://www.amradioantennas.com)

pkloops@bigpond.net.au

Paul 0412 302 939

PK's Loop Antennas

## RADIOS:

	Unused	Used
Icom 706MK2G	Ring/email	\$1199
Icom 208H	\$ 550	\$ 499
Icom 910H	\$2199	\$1799
Icom 756PRO2	N/A	\$2799
Icom 756PRO3	\$4399	N/A
Icom 718	N/A	\$799
Kenwood TS2000	\$2699	\$2299
Kenwood TS2000X	N/A	\$2999
Kenwood TS480SAT	\$1699	\$1499
Kenwood TS480HX	\$1899	\$1699
Kenwood TS570DG	N/A	\$1249
Kenwood TMD700A	\$ 849	\$ 799
Kenwood THD7A	\$ 599	\$ 549
Yaesu FT8900R	\$ 649	N/A
Yaesu VX7R	\$ 529	N/A
Yaesu FT1000MP MKV	\$3599	\$2999
Yaesu FT847	N/A	\$1899
Yaesu FT857D	\$1249	\$1149
Yaesu FT897D	\$1299	N/A
Yaesu FT100D	N/A	\$1099

## ACCESSORIES:

Doss 40 AMP PSU	\$ 235	N/A
Icom AH4 ATU	\$ 499	\$ 449
Icom AT180	N/A	\$ 549
Tokyo HL700B HF Amp	\$1899	
Tokyo HL200V50 2M Amp	\$ 549	
MFJ 993 ATU	\$449	
Tokyo 2M 200W Amp	\$49	

Call / email re Heil and MFJ products

DOA warranty applicable on all items (ie if it is not 100% and in condx as described, a full money back g'tee applies)

OTHER CURRENT MODELS AVAILABLE

ALL USED GEAR IN EXC CONDX WITH ORIGINAL BOX AND ACCESSORIES

PRICES SUBJECT TO CHANGE - CHECK WEBSITE FOR LATEST (OR RING)

WILL CONSIDER TRADE-INS - BUT MUST BE CURRENT MODEL GEAR (IE LAST 5 YEARS)

Ship anywhere in VK/ZL (freight extra)

ORDER ONLINE AT

[WWW.VK3AJJ.COM](http://WWW.VK3AJJ.COM)

OR TELEPHONE PAUL ~

(03) 9018 9757

Mob. 0410 093 759

vk3ajj@iinet.net.au

NB - I am not an authorised dealer for the radio companies listed above.

These companies may refuse service on equipment sold by me - but other servicing options are available in the VK market.

Licensed Second Hand Dealer NO 10229 (Vic) (E&OE)

[WWW.VK3AJJ.COM](http://WWW.VK3AJJ.COM) - giving Aussie Hams a FAIR GO!



# Directory

## The Amateur Service:

a radio communications service for the purpose of self training, intercommunication and technical investigation carried out by amateurs, that is, by duly authorised persons interested in radio technique with a personal aim and without any pecuniary interest. 1.56 ITU Radio Regulations.

The Wireless Institute of Australia represents the interests of all amateurs throughout Australia.

WIA membership fees are: ★ \$ 75 for full members ( F grade ), ★ \$ 70 for pensioners and students ( G and S grade), and ★ \$ 50 for membership without 'Amateur Radio' ( X grade ). Payment direct to National office.

National Office	Contact	News Bulletin Schedule
10/229 Balaclava Road, Caulfield North VIC 3161, PO Box 2175 Caulfield Junction Vic 3162 Australia	Phone 03 9528 5962, Fax 03 9523 8191, 10am to 4pm daily, nationaloffice@wia.org.au http://www.wia.org.au	Subject to change. See www.wia.org.au follow National News prompts. Contact nationalnews@wia.org.au National VK1WIA news is distributed to all states.

Advisory Committees	Contact	News Bulletin Schedule
<b>VK1 Australian Capital Territory</b> VK1WX Alan Hawes VK1ZPL Phil Longworth VK1ET John Woolner VK1GH Gil Hughes	vk1advisory@wia.org.au	Sundays at 11.00 am VK1WIA 7.128, 146.950, 438.050 Canberra Region Amateur Radio Club Email newsletter will be sent on request to president@vk1.ampr.org
<b>VK2 New South Wales</b> VK2QV Chris Flak VK2XCD Chris Devery VK2BFN Adrian Clout	Phone 02 9689 2417 vk2wi@ozemail.com.au vk2advisory@wia.org.au	VK2WI - Sunday 1000 and 1930 hours local. 1.845; 3.595; 7.146; 10.125; 14.170; 28.320, 52.525; 145.600; 147.000; 438.525; 1273.500 megahertz. Plus regional relays. VK1WIA news included in the morning
<b>VK3 Victoria</b> VK3JB John Brown VK3PC Jim Linton VK3APO Peter Mill	Phone 03 9885 9261 vk3advisory@wia.org.au	VK1WIA Sunday 11.0am via HF and major VHF / UHF rpters
<b>VK4 Queensland</b> VK4BY Don Wilchefski VK4ZZ Gavin Reibelt VK4KF Ken Fuller	Phone 07 3221 9377 vk4advisory@wia.org.au	VK1WIA, Sunday 9.0am via HF and major VHF/UHF rpters
<b>VK5 South Australia and Northern Territory</b> VK5OV David Box VK5APR Peter Reichelt VK5ATQ Trevor Quick	Phone 08 8294 2992 boxesdnm@lm.net.au peter.reichelt@bigpond.com vk5advisory@wia.org.au	VK5WI: 1843 kHz AM, 3.550 MHz LSB, 7.095 AM, 14.175 USB, 28.470 USB, 53.100 FM, 147.000 FM Adelaide, 146.800 FM Mildura, 146.900 FM South East, 146.925 FM Central North, 438.475 FM Adelaide North, ATV Ch 35 579.250 Adelaide. (NT) 3.555 LSB, 7.065 LSB, 10.125 USB, 146.700 FM, 0900 hrs Sunday. The repeat of the broadcast occurs Monday Nights at 1930hrs on 3585kHz and 146.675 MHz FM. The broadcast is available in 'Realaudio' format from the website at www.sant.wia.org.au Broadcast Page area.
<b>VK6 Western Australia</b> VK6NE Neil Penfold VK6XV Roy Watkins VK6OO Bruce Hedland-Thomas	Phone 08 9351 8873 http://www.vk6.net/ vk6advisory@wia.org.au vk6ne@upnaway.com vk6xv@bigpond.net.au	VK6WIA: 146.700 FM(R) Perth at 0930hrs Sunday relayed on 1.865, 3.564, 7.075, 10.125, 14.116, 14.175, 21.185, 29.120 FM, 50.150 and 438.525 MHz, Country relays 3.582, 147.200 (R) Cataby, 147.350 (R) Busseton, 146.900 (R) Mt William (Bunbury), 147.000 (R) Katanning and 147.250 (R) Mt Saddleback. Broadcast repeated on 146.700 at 1900 hrs Sunday relayed on 1.865, 3.564 and 438.525 MHz : country relays on 146.900, 147.000, 147.200, 147.250 and 147.350 MHz..Also in "Realaudio" format from the VK6 WIA website
<b>VK7 Tasmania</b> VK7ZAX Phil Corby VK7DG Dale Barnes VK7KK Reg Emmett	Phone 03 6234 3553 vk7advisory@wia.org.au phil.corby@tassie.net.au vk7dg@wia.org.au regemm@ozemail.com.au	VK1WIA Sunday 9am on VK7WI network: 3.570MHz LSB, 146.700 MHz FM (VK7RHT South), 53.825MHz FM (VK7RAD South), 147.000MHz FM (VK7RAA North), 146.750 FM & 53.825MHz (VK7RNW North West), 146.625 MHz FM (VK7RMD North West), UHF CB Channel 15 (Hobart) and 27MHz CB - 27.225MHz LSB (Hobart). Followed at 9:30am with VK7 Regional News Broadcast also on 7.090MHz LSB & 14.130MHz USB

### Notes

1. Only three members of the state advisory committees are listed.
2. All listings are preliminary. They will be updated each month as required.
3. Membership application forms are available from the WIA web site www.wia.org.au or the national office address above.

# The new face of amateur radio

Mick Ampt VK3CH

## Janice Ampt VK3FIRE, Australia's youngest radio amateur

A nine-year-old girl has become the youngest to qualify for an Australian amateur radio licence and has thanked her father, Mike VK3CH, and grandfather Ian Ampt VK3IV, QTH of Horsham, and everyone else involved in her success.

Janice attended the training by Fred Swainston, VK3DAC, and assessment session conducted by Melbourne's North East Radio Group (NERG). On her first attempt at the written assessment, she narrowly missed a pass mark. Following feed-back from the assessor, John Weir VK3ZRV, and further study, she succeeded on her second attempt on 16/12/05 at the combined regulations and theory written test. She now has the call sign of VK3FIRE.

The new entry level Foundation licence was introduced in October 2005. Before that, the youngest to qualify for any VK licence were 11-year old males and a 12-year old female. Janice is already undertaking study to obtain her Marine Radio Operator's Certificate of Proficiency (MROCP) and the Amateur Radio Operators Standard licence. With the practical operating experience she has to date, all she is waiting for now is for the ACMA to write up the "Standard licence" exams! She has also expressed an interest in learning Morse code, the speed as yet undecided.

For Christmas presents last year, Janice gave copies of the Foundation Licence Manual to her uncles, Ben, John and Peter.

## Nikolaas Dimitrijevic VK3FNIK, Australia's 2nd youngest radio amateur

Nikolaas, 10 year old son of long time club member Chris VK3FY, has also joined the ranks of those obtaining their amateur radio licence under the new entry level Foundation licence. Nikolaas attended a training session



at Amateur Radio Victoria and NERG club and did his exams at Box Hill with Amateur Radio Victoria. Dad Chris is very pleased and proud of the achievement and no doubt has a room full of gear for Nikolaas to take his pick from. But Nikolaas is smart – he has already put the 'hard word' on the OM to get him a new Icom IC-7000!

This is a great start for WANSARC\* in the New Year to have the two youngest licensed amateur operators in VK. As both studied together for a while, they have a friendship that can continue 'on air' and have a peer to hone their 'on air' operating skills and then progress to the wider amateur community.

Wonder how long until Dad takes Nikolaas to some rare DX island for some serious contesting. Looks like we have some extra 'hands on deck' for the WANSARC\* JMFD this year!

\* Western and Northern Suburbs Amateur Radio Club (IIRC) (WANSARC) is based in Melbourne's- northern suburbs.

## Just starting out...



Merv Collins VK3AFO took this photograph of his grandson Andrew Collins listening to his first Crystal Set.

At the age of nine, Andrew is showing great interest in amateur radio as a keen SWL, regularly monitoring his grandfather's 40 m contacts at his home in Canberra.

# ICOM's Newest amateur radios

## on display at Wyong Field Day

Visit us at  
**Wyong Field Day**

Sunday 19th February 2006



### IC-7000

HF/VHF/UHF All mode Transceiver

- 100W HF/50MHz, 50W/2m, 35W/70cm • I.F DSP for improved noise rejection • Digital IF filter for Dial up selectivity • 2.5" TFT colour display for bright easy reading • Remote control DTMF Mic for fingertip control & IRLP access PLUS • digital voice storage • 2 mode band scope • Multi function meter 7 SWR display • Built in RTTY modulator



### IC-P7A

VHF/UHF (2m/70cm)  
Dual-band FM Handheld Transceiver

- Ultra compact body, light weight 47x81x28mm, 160g • Mini-power VHF/UHF dual bander with wideband receiver 0.495-999.990MHz
- 1800mAh large capacity Li-Ion battery allows 20hours operating time (Tx:Rx:Standby=5:5:90) • 1.5W output power on 2m & 1W output power on 70cm • Simple operation • 1000 memory channels with flexible memory bank system • Oversize LCD for clear display of function information

**WIN A PAIR OF ICOM TRANSCEIVERS  
at the Wyong Field Day**

**ICOM**

ICOM 71

Call your local ICOM dealer [www.icom.net.au](http://www.icom.net.au) or (03) 9549 7500

Cut out this coupon to receive your  
**FREE ICOM  
STUBBIE HOLDER**  
only available at the Wyong Icom stand  
Available while stocks last

The magazine for **AUSTRALIAN** radio amateurs

Volume 74 No 3

March 2006

# Amateur Radio



\$6.50  
incl GST

## John Moyle Memorial Field Day Contest 2006 18 & 19 March

**featuring**

**Working A051 on a budget**  
Paul Paradigm VK2TXT

**Mobile amateur radio operation**  
Steve Mahony VK5AIM

**Dr Young sheds some light on VHF flutter  
(picketing)**  
Philip Gebhardt VE3ACK



# BENELEC

# YAESU

## A Portable for All Situations..... ... with a BONUS!

VX-2



2m / 70cm  
\$343.20

FT-60



2m / 6m / 70cm  
\$375.90

VX-7



6m / 2m / 70cm  
\$695.00

VX-6



2m / 70cm  
508.00

Included with These Models

**FREE**  
Soft Hook Ear Plug  
with inline Mike & PTT



Value \$68.00

Included with These Models

**FREE**



Value \$68.00  
Speaker Mike  
with CT91

VX-170



2m  
\$290.80



## Ideal Foundation Licence Radio Options.....

FT-817



Now includes FNB72 Internal Battery

- Ultra Compact 135 x 38 x 165mm
- All Mode Portable Transceiver
- 160 - 10m / 6m / 2m / 70cm
- 0.5-5 Watts Selectable

Price \$ 1,167.00

FT-857D



Now includes DSP2 unit built-in

- Ultra Compact + All Mode Transceiver
- 160-10m / 6m / 2m / 70cm
- 100W, 100W, 50W, 20W

Price \$ 1,423.90

FT-897D



Now includes TCX0-9 Built-in

- Portable / Mobile / Base All Mode Txr
- 160-10m / 6m / 2m / 70cm
- 100W, 100W, 50W, 20W

Price \$ 1,600.00

\* Low Power Capable!

## .....All Bands in One Box!

Benelec Approved Amateur Transceiver Dealers

All Price includes GST

NSW  
Andrews Communications Systems  
Tel: 02 9636 9060 lee.andrews1@bigpond.com

Newcastle Pro Sound & Communications

Tel: 02 4965 6899 sales@newcastleprosund.com.au

Action Communications  
Tel: 02 4732 2788 action@pnc.com.au

VIC  
Strictly Ham P/L  
Tel: 03 9729 7656  
vk3my@bigpond.net.au

G & C Communications  
Tel: 03 5996 3298  
gccomm@bigpond.net.au

Qld  
Kyle Communications  
Tel: 07 3857 4400  
mark@kyle.com.au

Ozhelp Services  
Tel: 07 3273 7263  
sales@ozgear.com.au

SA/NT  
POSNAV Systems P/L  
Tel: 08 8342 4700  
brenton@posnav.com.au

WA  
Bushcomm Pty Ltd  
Tel: 08 9296 0496  
bushcomm@bigpond.com

www.benelec.com.au



# Amateur Radio

Volume 74, Number 3  
March 2006

The Journal of the Wireless  
Institute of Australia  
ISSN 0002-6859

## Editorial

Editor: Peter Freeman VK3KAI  
editor-armag@wia.org.au

Technical Editor: Peter Gibson VK3AZL

### Publications Committee Members

Brenda Edmonds VK3KT  
Ron Fisher VK3OM  
Evan Jarman VK3ANI  
Tom Potter VK3UBS  
Bill Roper VK3BR  
Ernie Walls VK3FM

Circulation enquiries: wia@wia.org.au

### Submission of material to Amateur Radio Magazine

General and Technical articles to Secretary  
AR Publications Committee  
3 Tamar Court  
Mentone VIC 3194  
or armag@wia.org.au

Columns and Letters to the Editor to Editor  
AR Magazine  
PO Box 273  
Churchill, Vic 3842  
or editor-armag@wia.org.au

Hamads to  
"Hamads" Newsletters Unlimited  
PO Box 431  
Monbulk VIC 3793  
Fax 03 9756 7031  
newunltd@bigpond.net.au

Advertising  
All enquiries to  
Newsletters Unlimited  
PO Box 431  
Monbulk Vic 3793  
Phone: 03 9756 7797  
Fax: 03 9756 7031  
newunltd@bigpond.net.au

Registered Office  
10/229 Balaclava Road,  
Caulfield North VIC 3161  
Australia  
Phone: 03 9528 5962  
Fax: 03 9523 8191

## Production Deadlines

Advertising booking and articles for publication 10th of preceding month.

Hamads and advertising material deadline 18th day of preceding month

The contents of Amateur Radio are Copyright  
Wireless Institute of Australia © 2006

## GENERAL

- Amateur radio involved in Alpine Car Rally ..... 10  
*Rob Ashlin VK3EK*
- The amateur-radio-friendly vineyard ..... 11  
*Vince Henderson VK7VH*
- Working AO51 on a budget..... 14  
*Paul Paradigm VK2TXT.*
- New draft Australian 40 m band plan ..... 17  
*Glenn Dunstan VK4DU*
- Mobile amateur radio operation ..... 18  
*Steve Mahony VK5AIM*

## TECHNICAL

- Experiments in aircraft enhanced propagation ..... 5  
*Barry Miller VK3BJM*
- Full-wave half-square antenna ..... 9  
*Lindsay Collins VK2YN*
- Dr Young sheds some light on VHF flutter (picketing) ..... 20  
*Phillip Gebhardt VE3ACK*
- Re-using microwave oven transformers for high-voltage power supplies ..... 26  
*Drew Diamond VK3XU*

## COLUMNS

- |                               |                                       |
|-------------------------------|---------------------------------------|
| ALARA ..... 37                | News from... ..... 31                 |
| AMSAT ..... 34                | VK2 ..... 31                          |
| Awards ..... 36               | VK3 ..... 33                          |
| Beyond our shores ..... 38    | VK7 ..... 34                          |
| Contests ..... 41             | Over to you ..... 25, 45, 49          |
| Directory ..... 56            | Silent key ..... 7, 19, 50, 51        |
| DX News & Views ..... 39      | Spotlight on SWLing ..... 50          |
| Editorial comment ..... 2     | VHF/UHF – an expanding world ..... 46 |
| Gridsquare standings ..... 40 | WIA comment ..... 3                   |
| Hamads ..... 54               | WIA DXCC standings ..... 45           |
| HF predictions ..... 52       | WIA news ..... 4                      |

## Our Cover this month

Our cover picture was taken by Doug Friend VK4OE of his recent Summer Field Day station/antennas just before dawn on Sunday morning. A reminder to prepare for the up-coming John Moyle Memorial Field Day on 18 and 19 March.

### Contributions to Amateur Radio

Amateur Radio is a forum for WIA members' amateur radio experiments, experiences opinions and news. Manuscripts with drawings and/or photos are always welcome and will be considered for publication. Articles on disc or email are especially welcome. The WIA cannot be responsible for loss or damage to any material. A pamphlet, How to write for Amateur Radio is available from the National Office on receipt of a stamped self-addressed envelope.

### Back issues

Back issues are available directly from the WIA National

Office (until stocks are exhausted), at \$4.00 each (including postage within Australia) to members.

### Photostat copies

When back issues are no longer available, photocopies of articles are available to members at \$2.50 each (plus an additional \$2 for each additional issue in which the article appears).

### Disclaimer

The opinions expressed in this publication do not necessarily reflect the official view of the WIA and the WIA cannot be held responsible for incorrect information published.

## Amateur Radio Service

A radiocommunication service for the purpose of self-training, intercommunication and technical investigation carried out by amateurs; that is, by duly authorised persons interested in radio technique solely with a personal aim and without pecuniary interest.

## Wireless Institute of Australia

The world's first and oldest National Radio Society  
Founded 1910

Representing

The Australian Amateur Radio Service

Member of the

International Amateur Radio Union

Registered Office of the WIA

10/229 Balaclava Road, Caulfield North Vic 3161

Tel: (03) 9528 5962 Fax (03) 9523 8191

email: nationaloffice@wia.org.au

http://www.wia.org.au

All mail to

PO Box 2175 Caulfield Junction VIC 3161

Business hours: 10am – 4pm weekdays

### National Office staff

Judith Oliver	Office Coordinator
Emma Trebilco	Examinations Officer
Brenda Edmonds	Office Volunteer

### Board of Directors

President	Michael Owen	VK3KI
Vice-President	Ewan Mcleod	VK4ERM
	Robert Broomhead	VK3KRB
	Glenn Dunstan	VK4DU
	Trevor Quick	VK5ATQ
	Ted Thrift	VK2ARA
	Phil Wait	VK2DKN
Secretary	Chris Jones	VK2ZDD
Treasurer	David Pillely	VK2AYD
Assistant Treasurer	Bruce Bathols	VK3UV

### Coordinators

AMSAT	Graham Ratcliff	VK5AGR
ARDF	Jack Bramham	VK3WWW
Australian ARISS	Tony Hutchison	VK5ZAI
Awards	Mai Johnson	VK6LC
Contests	Ian Godsil	VK3JS
John Moyle Memorial		
FD Manager	Denis Johnstone	VK3ZUX
Editor "AR"	Peter Freeman	VK3KAI
EMC/EMR	Gilbert Hughes	VK1GH
	Keith Malcolm	VK1ZKM
Standards	Gilbert Hughes	VK1GH
	David Wardlaw	VK3ADW
	John Bishop	VK2ZOI
	John Martin	VK3KWA
NTAC	t.b.a.	
Historian		
IARU Region 3		
Liaison Officer	Neil Penfold	VK6NE
Intruder Watch	Glenn Dunstan	VK4DU
International		
Travel Host	John Miller	VK3DJM
ITU Conference and study group		
	Gilbert Hughes	VK1GH
	David Wardlaw	VK3ADW
	Keith Malcolm	VK1ZKM
QSL Curator	Ken Matchett	VK3TL
QSL Manager (VK9/0)	Neil Penfold	VK6NE
Videotapes Curator	VK2 Division	
Webpage co-ordinator	Colin Thompson	VK2TRC
WICEN	John Weir	VK3ZRV

### ACA Liaison Team

Gilbert Hughes VK1GH  
Keith Malcolm VK1ZKM  
Peter Mill VK3APO  
Glenn Dunstan VK4DU

## Editorial comment

Peter Freeman VK3KAI

## Interacting with newcomers

The new Foundation licensees are starting to become noticed on the bands. Those four-letter suffixes are unusual, but I am certain that we will all grow used to them.

As mentioned last month, many amateurs will be exploring what is for them new territory. Foundation licensees will be on the Amateur bands for the first time. Standard Licensees will be exploring new bands and modes. Some Advanced licensees may also explore new modes or bands.

How do we interact with newcomers? I have heard reports of someone (a long-standing Z call) coming up on the national call frequency on 144.1 MHz late in the afternoon. One of his locals came up and gave a response along the lines of "It is useless calling at this time of day. Try between 0800 and 0900, which is when all the activity occurs." The local then said that he had to go, having other things to do. It would be very easy for this newcomer to be put off by such a response. This should give us all reason to consider how we would respond. I am not implying that the local "regular" intended to "brush off" the newcomer. I suspect that he simply did not consider how his response may be interpreted. Perhaps, having come up to talk, even if only briefly, he should have been prepared to spend a few minutes to explain that the SSB end of the VHF & UHF bands can be very quiet for much of the day. If it were me, I would hope that I would have responded in such a manner, and then made a schedule to make contact with this newcomer at a time when we could both discuss the characteristics and typical activity patterns on this band segment. An unconsidered response, whilst well intentioned, might turn a newcomer away from the activity or even the hobby. Hopefully this particular newcomer will have, by now, made some contacts on 2 m SSB and will have learnt some of the operating habits of others.

Promoted as the largest amateur get together in VK, the Central Coast ARC Field Day was held at Wyong last weekend (as I write these notes). The

day was warm and humid. It was good, as always, to catch up with amateurs that are usually just a voice on the airwaves or on the other end of the email system. It was also interesting chatting with many about the magazine, some offering contributions.

This month sees the running of the annual John Moyle Memorial Field Day. This contest is one of Australia's premier contests. I have taken a small liberty in promoting the contest on the front cover – the photograph is from the Summer Field Day. Thank you to Doug VK4OE for the picture. Here is a chance to test your preparedness for any possible emergency callout, or simply to get out onto a local hilltop to have some fun, or both. The rules were published last month and are available on the WIA web site. Note that there has been a revision in the distance/points scoring for 144 MHz and above. Locally, the club is planning to have a small group out running multi-operator all band, HF through to 10 GHz. Several newcomers to Field Day operation are expected. Now we must simply prepare and wait, hoping for good weather! Remember, the President's Cup is up for grabs for the station with the highest CW score.

Last month we published an article on a multi-band vertical antenna system. This has caused a bit of a stir – see an item in "Over to you". Recall that the author of the article said that many would question the system. We all need to remember that any antenna, regardless of its efficiency (or lack thereof), is much better than no antenna.

We finally see the conclusion to the story on aircraft enhanced propagation from Barry VK3BJM – sorry for the delay, Barry! Steve VK5AIM presents some useful options for the use of headsets by the mobile amateur. Paul VK2TXT gives us some hints on using AO51. From Canada we have a contribution explaining VHF flutter. Drew Diamond tells us one way in which we might reuse microwave oven transformers – please observe the warning notice!

That is all for now.

Cheers,

Peter VK3KAI



# The WIA continues to evolve

**This issue of Amateur Radio marks another significant step in the evolution of the Wireless Institute of Australia from a federally based organisation to a truly national membership organisation.**

With this issue sent to members are the Notice of Annual General Meeting and the Institute's accounts, as well as some information about the Open Forum and the WIA Annual Dinner.

Isn't that all the same as last year? Yes, it is. The only difference between this year and last year is that last year many people were still members of a Division, and so their membership had not formally transferred to the WIA. They were "Provisional" members.

Now "Provisional" members no longer exist, and you are either a member or not a member.

However, this year and for the first time, with this issue are the documents for a postal ballot for directors. There is a reply paid envelope, an envelope for a ballot paper, the ballot paper and a statement from each candidate for election as a director.

The WIA has 7 directors, and each is appointed for two years, three retiring one year and four retiring the next year. The first directors were appointed by name in the new Constitution, when it was adopted by the then Federal Council, the representatives of each of the State or Territory divisions, really the annual general meeting of the only members of the WIA.

Some people wondered why there could not be an election at that time, to appoint the directors of the WIA with all of the members having a right to vote.

What was done was what is usually done when forming a new company, that is the subscribers, here the existing Divisions, choose the first directors, hopefully looking for acceptable people with synergistic skills. The change from the federal based structure to a national structure is so significant that it was very close indeed to forming a new company.

As you will recall, we were all members of a Division, and it was the Divisions that were the members of the WIA. That is another reason why it

didn't make sense to have an election then, because it was only some months ago that the last of the people who were members of a Division became, if they wished, members of the WIA.

Now, the initial term of 3 of the directors appointed by the Constitution expires at the end of the next Annual General Meeting.

As noted in the December AR, clause 14.1 (c) of the WIA Constitution says, in part, that "The Board may determine that the election of Directors be conducted by postal ballot with the result of the election to be announced at the Annual General Meeting. A postal ballot shall be conducted in accordance with the regulations made by the Board from time to time."

In accordance with that provision, the WIA Board formally decided that the election of directors shall be conducted by postal ballot and after considering various comments made on the draft regulations it had published, adopted regulations to govern a postal ballot. A copy of the Election Regulations adopted by the Board has been placed on the WIA website.

The Board appointed David Wardlaw, VK3ADW, as Returning Officer to conduct the postal ballot, and David placed a notice in December AR calling for nominations.

The three retiring directors are eligible for re-election and each decided to nominate for re-election. In addition, there is a further nomination for election as a director, so there are four candidates for three positions and so there is an election and the election material I have referred to is enclosed with this issue of AR.

At a number of meetings I attended

around the time the WIA was adopting its new, national Constitution, a number of people expressed strongly a conviction that the right to nominate and the right to vote was an essential aspect of a "new" WIA.

The WIA will be posting the voting papers and the Notice of Annual General Meeting to all members who don't receive AR, such as "Family Members".

So, for the first time, all members have an equal say in the election of directors.

Each candidate is allowed 250 words to provide "biographical details or other information as the candidate wishes" and so the election material includes a statement from each candidate.

So now is the time for everyone to vote. Don't leave it to others. Exercise the right you now have. Read the instructions

**So now is the time for everyone to vote. Don't leave it to others. Exercise the right you now have.**

on the voting paper carefully. Make sure that your vote is cast in the time allowed, which is short. If your vote gets there after 27 March, it will be disregarded.

If I may conclude by referring to the Annual General Meeting, which will be held in Sydney on 6 May 2006.

As you will see from the Notice calling the Annual General Meeting, the Board has decided that it will conduct an Open Forum, as was conducted last year.

Quite apart from your right to vote, please do consider attending the AGM and Open Forum, and hopefully the Dinner, and find out what your Institute is doing, meet some friends and offer your suggestions for the future.

ar

## ACMA Policy – Practical assessment

The WIA has addressed the concern raised by a number of members in relation to the ACMA policy about when it was necessary to undertake a practical assessment.

WIA President Michael Owen, VK3KI, has written to ACMA setting out this concern, and in particular, suggesting that the policy was considered unclear in circumstances where persons holding qualifications obtained under the previous licensing and certification arrangements were only now applying for a licence.

Alan Jordan, of the Pricing and Policy Branch of the Australian Communications and Media Authority, has advised the WIA that Amateur qualifications obtained before the new licensing arrangements came into force in October 2005 continue to be fully recognised.

Persons holding an AOCPP or AOLCP will be granted an Advanced Licence without having to undergo a practical assessment. Similarly, persons holding an NAOCP or NLAOCP will be granted

a Standard Licence without having to undergo a practical assessment.

More information can be found on the ACMA website.

## WIA Board meets

The WIA Board met in Sydney on 17 and 18 February 2006 and most of the directors travelled to the Wyong Field Day on Sunday the 19th and manned the WIA stand.

Among the matters discussed by the Board were:

It was confirmed that the 2006 Annual General Meeting and Open Forum would be held in the Bankstown RSL in South Western Sydney on 6 May 2006. The WIA Annual Dinner will also be held at the same venue that evening. More details will be released shortly.

The Board reviewed the Intruder Watch program and was pleased to note some modest wins, including the removal of certain radar interference and a commercial data network on the 40-metre band.

BPL was discussed and the Board reaffirmed the WIA's position. The WIA will continue to monitor developments and take whatever steps it can to ensure the issue of interference is addressed.

Progress with the Foundation licence, the accreditation of assessors, the WIA Exam Service and the likely need for a second print of the Foundation Licence Manual were reviewed. The Board agreed to increase the resources of the WIA office to improve the turnaround time for processing exam results. The Board agreed to proceed with the next round of assessor training.

The Board discussed the progress of the WIA Bookshop, WIA publications, broadcasts and the WIA website.

The Board reviewed the WIA's involvement in the International Amateur Radio Union Region 3 and the forthcoming conference to be held later this year in India.

The Board reviewed the accounts for 2005, and adopted a budget for the current financial year ending 31 December 2006.

The Board decided to proceed with the Club Grants scheme foreshadowed last year, and details will be published shortly.

The Board decided to conduct a series

of Club Conferences in various states, to ensure that the WIA had the benefit of grass root opinion and that clubs were properly informed on WIA activities.

In addition to its face to face meetings, the directors are in continuous contact and as is noted in the Directors' formal Report to the Annual General Meeting, the directors communicated regularly by email and phone. During the 2005 year 98 resolutions pursuant to the Constitution were signed by all directors. These dealt with the admission of new members (46 resolutions), the affiliation of clubs (36 resolutions), and the balance (16 resolutions) dealing with various matters from banking to the adoption of regulations to govern postal ballot.

## Foundation licensees to be allowed transmitter power of 10 watts all permitted modes

As the new amateur licence structure, including the Foundation licence, came into effect on 19 October 2005, WIA President Michael Owen, VK3KI, said that "Our only regret is that we believe that the power limit of 3 watts for AM, FM and CW for the Foundation licence, while perfectly logical, is unrealistic given the output power of commercially available equipment, particularly older equipment, and that the power limit should be 10 watts."

Michael had already advised ACMA that the WIA believed that a power output limit of 10 watts would not result in any difficulties but would enable the use of many older transmitters, particularly VHF transmitters, which would be attractive to the Foundation licensees.

The WIA has been advised by ACMA that "Following reconsideration of the issues involved, it is agreed, under the Foundation licence, to permit a transmitter output power of 10 Watts pX on all permitted emission modes instead of the present 10 Watts pX for J3E emissions and 3 Watts pY for all other permitted emissions."

The change will formally come into effect with the other amendments to the Amateur LCD in some months' time.

*continued on page 7*

## Plan ahead

### PORT MACQUARIE FIELD DAYS

Queen's Birthday Weekend,  
10/11th June 2006

Hosted by the Oxley Region A. R. C.  
Inc.

Held at  
the Sea Scout Hall, Buller St.  
Port Macquarie

Featuring  
Disposals, Fox Hunts,  
Demonstrations and  
Home Brew Displays

For further information contact:-  
Club Secretary, PO Box 712,  
Port Macquarie, NSW, 2444  
Or Bill Sinclair, Ph. 02 6583 9303

# Experiments in aircraft enhanced propagation

(Part 2)

Barry Miller VK3BJM

In November I detailed the beginnings of my experiments in Aircraft Enhanced Propagation (AEP), on 144 and 432 MHz, from the far west of NSW. This month I'll explain how subsequent trips explored the question of how far west this mode of propagation can be relied upon.

## Trip Number 3 – November 2003

In mid-November 2003 I headed up to a spot just south of White Cliffs, to continue exploring how far north and west the AEP would support communications. This trip would activate QF19ma, and challenge my portable VHF/UHF station. From the location just west of the Wilcannia-White Cliffs Road, my GPS told me it was 811 km to Sydney, and 789 km to Melbourne. This is getting right on the theoretical limit for this mode of propagation.

I spent nearly three days on the treeless ridge in 40°C heat, drinking lots of water and hiding in the shade. I failed – just – to work back into Melbourne. The beam heading was nearly at right angles to the Sydney-Adelaide aircraft track, which meant the aircraft provided propagation for a very brief period. The two near-contacts that I had suggested that it might just be possible to work into Melbourne, but the report exchange process would have to be perfect to be completed in time.

It was a different matter towards Sydney, though...

I had managed to park myself almost directly underneath the G222 flight path – it runs between Sydney and Djakarta. Not only did this mean I was woken up at about 0600 AEDT each morning by a 747-400 passing overhead towards Sydney, it also meant I had a reference from which to time my calls to Sydney. There was also the A576 route visible a little to the north of me, running between Bali and Sydney via Alice Springs.

G222 was the key, though, as it was used by Boeing 747-400s at high altitude. The higher the aircraft, the further over the horizon your signal will be propagated. It also seems that

the bigger the aircraft, the better the propagation.

Through bad luck and bad timing, I didn't complete with any Sydney stations on the first two mornings. But on the third – Monday 17th – I concentrated on Sydney, and at 2118 Z I completed with Gordon VK2ZAB on 2 m – a report of 51 given in return for a 52. Three minutes later, we completed on 70 cm with the same reports. There was much whoopin' and a-hollerin', at my end at least... Twenty minutes later I repeated the contact on 2 m with Gordon, except this time Gordon was 56, and he gave me a 53, peaking to 54.

I think it was around 2200 Z that I spoke with Guy VK2KU on 40 m, and I agreed to leave my CW keyer running for half an hour for him to monitor with "Spectran" (a PC-based audio spectrum analysis program). At about 2235 Z we were discussing giving up as nothing much had been seen, when I heard something big and Boeing overhead. I suggested we give it another half hour!

Eventually my beacon signal started to become visible on "Spectran" and built in level until voice was viable. Finally, at 2313 Z, I worked Guy on 2 m. I gave him a report of 51, and received a 41. Signal strength seemed to be still building as we 73ed.

## Trip Number 4 – April 2004

On arriving home, I got out my maps, and flight charts, and started calculating. I wanted to see if the 900 km barrier could be broken. The best way to achieve this was to plot a beam heading from Sydney, getting it to intersect the G222 flight path at a distance of 450 km or more (from Sydney). I came up with two initial possibilities: Mt Dering QF08tm, or near Nundooka Homestead QF09ud.

A little more work suggested a spot 100 km north of Broken Hill, near Fowlers Gap QF08uv, might be better. All three locations are along the Silver City Highway, north of Broken Hill.

While I wanted to get back on the road as soon as possible, I decided I'd wait until the ambient temperature level dropped to something a little saner than

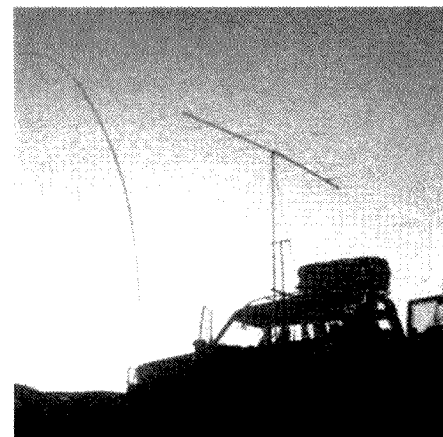

Moolooloo 24.06.01

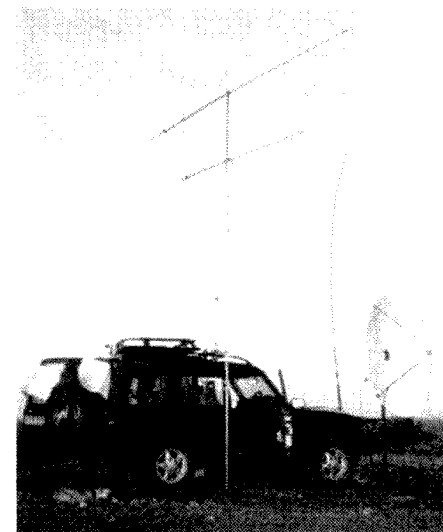

Mt Manara 16.11.02



Mt Manara 21.04.01

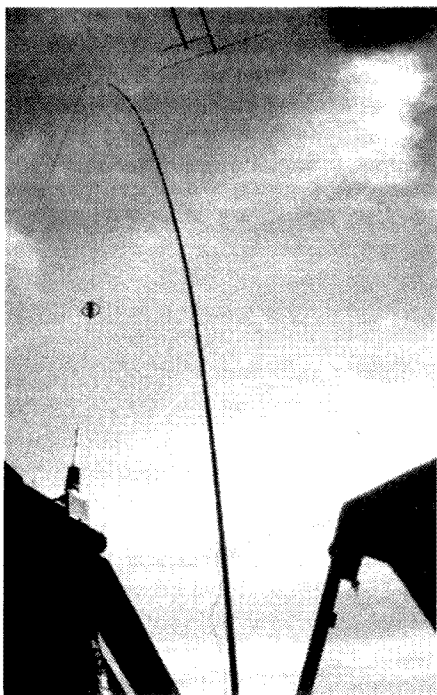

White Cliffs Nov 2003

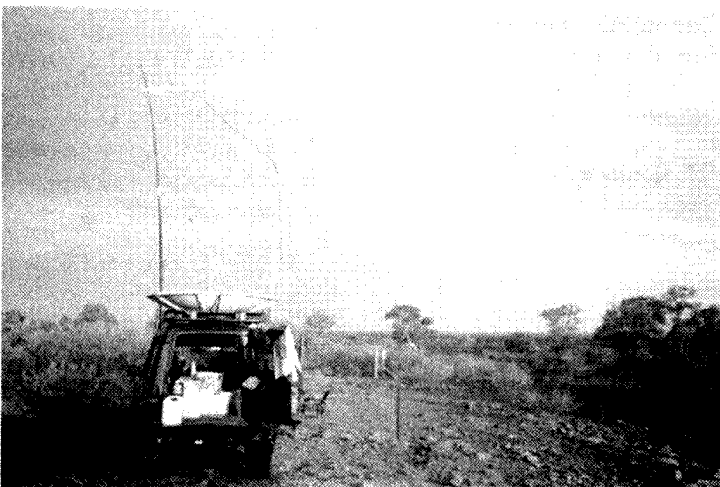

Wilcannia 17.11.02

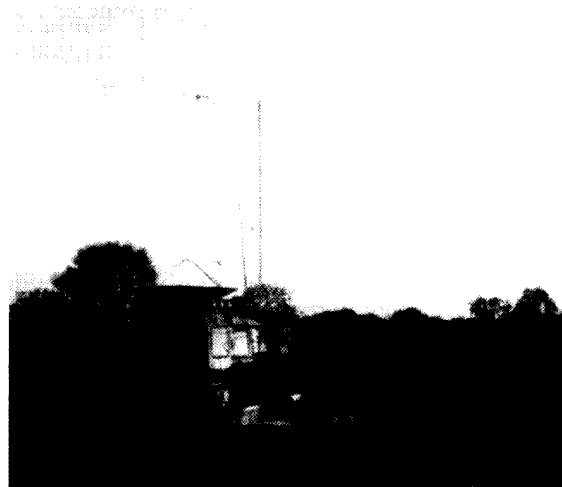

Wilcannia 18.11.02

40°C. This translated to mid-April 2004.

On Friday 2nd of April I left Kyneton for Fowlers Gap, arriving there just before midday the next day. With some much appreciated assistance from David of the University of NSW (the UNSW owns Fowlers Gap station), I set up adjacent to a trig marker on the highest part (283m

ASL) of a nearby ridge. The view from the ridge alone was worth the drive from home!

The first signal I looked for was the Ch5A vision carrier from Newcastle. It was immediately audible, and every now and then I heard the distinctive flutter of multi-path caused by an aircraft in the path. I ran the keyer towards Sydney, and it was heard by VK2ZAB almost continuously – but not at a level that would support voice. I could hear Gordon calling me most of the time, too, at RS of 41. This was the benefit of my low local noise floor, combined with his larger transmitter power. These signal levels appeared to be a result of inland tropospheric ducting (this view was strengthened by contacts with Leigh VK2KRR and Mark VK2EMA – both had constant large signals from their QTHs in central NSW). We agreed that all we needed was an aircraft suitably placed to enable the contact to be made.

I'd believed that my position should

have afforded me a view of aircraft passing on the G222 route, but I only saw one during my entire two days on the ridge. Based on my experience from the previous two trips, I asked Gordon to be available from 0500 AEST, to coincide with the morning flights I had observed. On this trip, it was dark at that time of the morning and I saw no aircraft.

Sunday morning we had two near contacts, but the enhancement was marginal – the first attempt had a report copied incorrectly, and the second fell through before confirmations were fully exchanged. Monday morning we succeeded twice (one contact showing marked aircraft flutter on Gordon's signal), with a third near contact. We tried 70 cm, too; but I heard nothing from Gordon, though he thought he heard something from me. The path distance, according to my GPS, was 923 km.

Contacts were also made into the Melbourne area (VK3AFW at a distance of 813 km, and VK3II at 882 km), Canberra (VK1DO at a distance of 860 km) and with VK5s ZK and UBC, at Goolwa and Gawler respectively.

## Station details

I'd class my portable station as modest – not QRP, but there is certainly room for improvement in most areas. All the contacts detailed in this article have been made with the following gear.

Transceiver: Icom IC-706MkII G

2m: Mirage 160 W PA, with inbuilt 21dB pre-amp (manufacturer claimed 0.6dB noise figure), and home-brew 10-element DL6WU-style Yagi at five metres above ground level.

70 cm: RFC 100 W PA, with inbuilt 12

dB pre-amp (2 to 3 dB noise figure) and home-brew 15-element DL6WU-style Yagi at four metres above ground level.

I've variously used RG213, 9913 and LMR-400 coax on all trips except the Fowlers Gap expedition, where I used six metre lengths of LDF 4-50 Heliax for both bands.

I feel that I can do much better on 70 cm by building a bigger Yagi (possibly 28 elements) and adding a better pre-amp (more gain and better noise figure). On 2 m I need more grunt. I'm building a 14-element Yagi for 2 m, and looking at a design for a 19-element version. It would be nice to obtain a 300 W solid state PA – but they're rare and cost kilo-bucks!

I use a CW keyer (the RAJE design kit) as a beacon, to save my voice. It automatically runs a simple sequence – “CQ de VK3BJM K” followed by 10

seconds of receive before repeating the call. During the receive break I listen intently for replies – if one is heard the keyer is disabled and I reply with voice. This also helps maximize the life of the battery, which in my car is an auxiliary 120 Ah deep cycle battery.

## Conclusion

The western half of NSW has very few active amateurs on VHF and UHF, and this might add to the impression that VHF and UHF is a dead loss in this remote part of Australia. In fact, the type and altitude of the aircraft flying over NSW will provide some of the best long distance Aircraft Enhanced Propagation around. Time, patience, and a little research are all that is required to exploit this.

My choice now is this: attempt to

exceed the 1,000 km barrier for an AEP contact, by going 80 km west of Fowlers Gap, or settle for activating other locations in NSW within a 900 km radius of Sydney. I want to try for the 1000 km contact, but I won't attempt this till I have improved my portable station. Stay tuned – preferably on 144.100 MHz.

Finally, I'd like to thank the many stations whose support, encouragement and participation have made these contacts possible; but especially Chris Morley VK3KME and Peter Freeman VK3KAI for assistance in research, and Ron Cook VK3AFW and Gordon McDonald VK2ZAB for their support with both research and on-air availability.

ar

## WIA News continued

The WIA President said that the WIA welcomed ACMA's decision, which should assist many Foundation licensees, and was grateful that the regulator was prepared to make an early announcement.

## ACMA responds on single letter suffix callsign proposal

ACMA has responded to the WIA's proposal for the issue of single letter suffix callsigns to Australian amateurs.

“We received 45 replies to our request for comment on single letter suffix callsigns” WIA Director, Glenn Dunstan, VK4DU, said.

“Of these replies, 38 were in favour, and 7 against.”

“In light of this small response, and in consideration of the administrative overhead required, ACMA have advised that they will not be issuing single letter suffix callsigns to amateurs for the present time” Glenn said.

The WIA wishes to thank all who replied to its call for comment.

## The UK news on GB2RS goes digital

Last December RSGB newsreaders were informed that some experimental GB2RS news broadcasts were planned for 2006 using digital voice transmissions. The first of these experiments is due to take place from GX0BAA on Sunday 12 February at 2115UTC on 1992 kHz using USB WinDRM, the successor of HamDREAM software

ar

### WANTED

#### Articles for Amateur Radio

*Technical, club activities, DXpeditions, Field Days, opinion, or whatever your experience is or has been in amateur radio*

Address for submitting articles can be found on page 1

## Silent keys

### Horace (Horrie) Stephens VK2ZES

Horrie passed away peacefully at Nimbin Hospital, 16 January, 2006. Aged 91 years, he had been deteriorating in recent months with cancer. He was a foundation member of SARC since it formed in 1959. He was well-known and popular throughout the region. He came through the motor trade into radio and TV servicing. Very knowledgeable, he was always willing to help anyone. His funeral was held at Lismore Crematorium Chapel. On Thursday 19th, almost 200 people attended to see him off. Many SARC members were present. Our condolences to his wife Jean, his family and friends. Vale Horrie VK2ZES.

### Henry David Russell VK2BSC

#### of Mount Hutton

David had recently joined Hunter Region WICEN. He spent some of his early working years in the broadcast industry in Sydney before returning to Newcastle. David was an 80 metre relay station for the VK2AWX Monday evening news session when Rodney VK2CN was not available.

Vale David VK2BSC

VK2NN

(extracted from WICEN news)

### Jack Wilson VK2XK

Jack Wilson VK2XK became a silent key on 24th January.

Jack was first licensed in 1948 and operated from his home in Gynea.

Advised by his son.

ar



# TTS Systems Communications Equipment

systems

www.ttssystems.com.au

**FREE CATALOGUE**

## HF and VHF Transceivers, Autotuners and Kits

Phone 03 5977 4808. Fax 03 5977 4801 [info@ttssystems.com.au](mailto:info@ttssystems.com.au)



### LDG FT-Meter — Plug and play, easy-read piggyback meter puts needle bounce in your voice peaks

Yaesu's popular FT-857 and FT-897 transceivers are wonders of compactness. These do-anything, go-anywhere transceivers were science fiction just a few years ago, but amateurs today are using them everywhere

About the only problem with these radios is that we amateurs with a few miles on the eyes wish that the display was just little bit bigger. Those tiny little screens are just plain hard to read!

And we like to see a real live meter needle bouncing on voice peaks. Wish they had thought of that when they designed the radio.

Well, in fact they did.

Noticed only by compulsive manual readers, is news that there is a meter jack on the bottom of the front panel. Yaesu probably knew they needed a bigger display all along, but just left it as an exercise for the user. Well, help is here! The LDG FT-Meter is a low-cost, plug-and-play solution to all your FT metering needs.

The FT-Meter presents a lush, highly readable 2.5" meter face with calibrated scales for signal strength and discriminator reading on receive, and power output, SWR, modulation, ALC action and supply voltage on transmit.

Each function is selectable from the radio's menu. Easily visible from anywhere on your desk or dash, the FT-Meter is illuminated by any external 12 vdc source. The FT-Meter comes fully assembled and ready to go; just plug it into the radio and you're in the picture like never before. Order yours today.

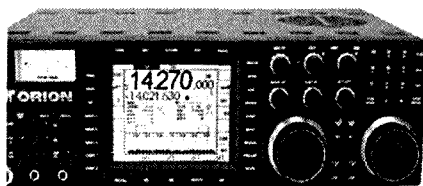

### ORION II—It's new

Super bright, TFT color display, CCFL backlighting. New 32-bit control processor using the latest generation Freescale DragonBall Super VZ chip.

Faster front panel control response and accelerated remote operation via RS-232. "HIGH SPEED SWEEP" add-on-able. All-new firmware. DSP code is refined, crafted and compacted to levels unimaginable even two years ago. Provides faster (stuck) sweep with finer resolution, enhanced DSP automatic notch and DSP noise reduction.

ORION II-specific roofing filters are arranged in a single bank to allow selection of the absolute ideal roofing filter for you. The narrow (600 and 300 Hz) filters are in with all the rest, giving subtle improvement in dynamic range. The new filters have less passband ripple than ever offered.

ORION II comes standard with 20, 6, 2.4, and 1 kHz installed. Now more affordable optional filters are 1.8 kHz (model 2000), 600 Hz (model 2001), 300 Hz (model 2002). Mixing architecture for analog stages has been re-arranged to give self-correction for frequency stability.

Variable (programmable) line level output on rear panel completely independent of front panel controls.

ORION II uses the popular 8 pin mic connector broadening the range of mikes and accessories readily available without finding or making adaptors.

### MAC-200 MASTER ANTENNA CONTROLLER (Smartuner Built-In)

Control up to 5 Antennas

Select the right antenna, for right band, at right time. The Master Antenna Controller is your base station control center, no switching and tuning. You select from five antennas and automatically get minimum SWR. Monitor your power and SWR. With MAC-200 you control your antennas.



### ADSP SPEAKER

Three modes:  
• no noise reduction; original ADSP;  
• new ADSP2 noise reduction - up to 26 dB of noise reduction.



## We have

SGC 237 Waterproof Auto Tuners  
SGC 239 Economy Auto Tuners



Autek Antenna Analysers  
Autek RF 2kW in-line Power meters  
Vantage Pro Weather Stations

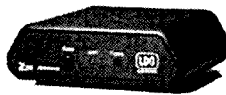

Z100 TUNER & AT1000 HIGH POWER AUTO TUNER

## TEN-TEC KITS

### Ten-Tec 3003 Acro-Bat antenna hanger.

UV resistant, S/S hardware. Hang ladder line-fed or small gauge RG-58 or RG8X coax-fed wire antenna.



### Model 516 Argonaut V IF-DSP QRP Transceiver



IF-DSP modem 20 watt HF transceiver. 20 watts output power, all modes. SSB, CW, digital modes, and FM. Front panel adjust 1-20 watts output. AM operation at 5 watts carrier power (20 watts PEP). Metering measures forward or reflected power in switchable 2 or 20 watt scales.

### LDG's DTS-4 Desktop Coaxial Switch

Switching between antennas no longer requires under-desk acrobatics to connect up, but coax switches often take up scarce desk space.

And if lightning strikes, "Did I set the switch to Ground?" If not, do you now own a pile of rubble.

With LDG DTS-4 Desktop Coaxial Switch you can instantly switch your rig between 4 antennas with the press of a button. All five coax sockets (4 in, 1 out) are on the back. The DTS-4 will fit in just about anywhere on your desk. A bright red LED indicates the antenna in use. Touch a button and all inputs are grounded. Remember that lightning strike when you are out? The DTS-4 can sense when your rig is off, and automatically ground all antenna inputs and you start up again on the last used antenna.

Using a compact remote control box (DTS-4R) you can remote-mount the DTS-4, the desktop has all the features but only a single, slim control cable running to the remote DTS-4 switch. 1500 watts of RF power on HF (1000W on 6M), it can be used with any coax-fed antenna. If the power supply fails, it grounds all inputs.

Six position version available



The very informative DTS  
4 front  
Highly organised back



### SG-237 Smartuner™

High density surface mount components in a 4 layer PCB on chassis: high efficiency, reliability, performance, excellent electrical and RF ground system. Weather resistant, factory-sealed ABS plastic.

MULTIPLE APPLICATIONS -- Use for base, mobile, portable, marine or aviation.

Rugged and small gives max. flexibility. 100W power, coverage to 60MHz, matches most popular HF transceivers. Use balanced or unbalanced antenna: whips, backstays, dipoles, loops and longwires, only 28 feet of antenna for full coverage operation.

Full info available—ask

### BUDDIPOLE

Dipole — vertical... Fits in travel bag! Optimised for transmit power, proven for DX work. Ultra light materials, High-Q coils. Zero-loss balun with Quick-Connect feedpoint.

Standard Comes with—

- Two 22" black aluminium arms. Two multi-band coils (40-10m), adjustable coil tap pre-marked system
- Two SS telescopic whips, VersaTee™ w/ 3/8" x 24 adaptors
- BNC/PL259 coax connector, 25' of RG58 coax
- Carry bag



# Full-wave half-square antenna

Lindsay Collins VK2YN

Amateur Radio has published lots of information on antennas lately, but I would like to show another one which I have used a lot here, and in Darwin when we visited our two daughters. I have one now on 18 MHz.

If anyone has room for a dipole up to 25 feet, more or less on any frequency you want, then I can recommend the full-wave half-square to you now. It is quoted as giving 4 dB gain and radiates at right angles, the same as all dipoles.

As shown in Figure 1, the antenna comprises a vertical quarter-wave leg on one side of the feed-point, with a three-quarter-wave leg on the other. Of the latter, the first half-wave runs horizontally from the feed-point and the remaining quarter-wave hangs vertically down. A stabilising mass at the bottom of each vertical section keeps these wires taut.

The overall assembly is supported by a rope at each end, using suitable insulators. Each rope should run over a pulley at the support point so that it can be paid out or hauled back to adjust the antenna height, whilst at the same time keeping the half-wave section essentially horizontal. This is the method used to vary the feed-point impedance so that it matches that of the 50 ohm coax feeder.

The feed-point should ideally be installed near the shack so that the coax can be tied for at least six feet along the horizontal support rope, between the feed-point and the full-circle pulley rope at that end. The coax is also tied to the vertical rope so that it is kept well clear of the quarter-wave leg of the antenna which hangs down from the feed-point.

At the feed-point, a small slab of plastic (around 6 mm thick) can be used to mount a SO239 socket which connects the feeder to the antenna. The centre

pin of the socket is connected to the long leg of the antenna and the metal body to the short leg. To do away with insulators, the two antenna legs and the support rope can be mechanically anchored to holes in this plastic piece.

For weatherproofing, wrap the plastic slab and socket assembly in black plastic sheet (from a garbage bag) and seal it up with black insulating tape.

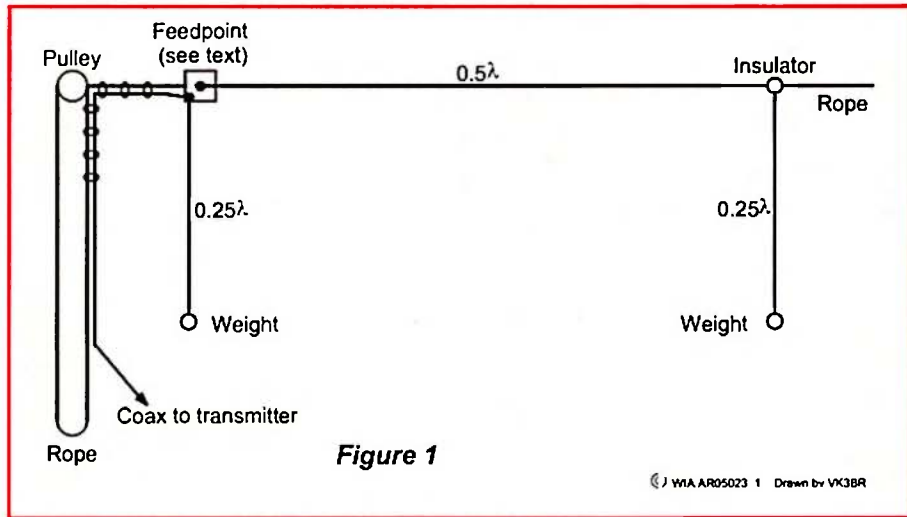



**EASTERN AND MOUNTAIN DISTRICT RADIO CLUB INC.**

## WHITE ELEPHANT SALE

**Great Ryrie Primary School**  
Great Ryrie Street Heathmont  
Doors open at 10:30 AM  
Entry \$6.00 per head

Selling space: \$18.00 per table (inc entry for one person)  
For Bookings call Peter VK3DI on (03) 9720 8874 or email wes@emdrcc.com.au by 1st April

Talk In on VK3REC

147.175 MHz

**Sunday 9 April 2006**

Hundred of components, pre-loved radios, test gear, computers, software and commercial displays.

WE ARE HERE

MELWAYS 49 K11

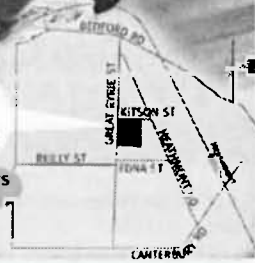

Soft drinks, hot dogs, hamburgers on sale.  
Free tea and coffee.

# Amateur radio involved in Alpine Car Rally

Rob Ashlin VK3EK

Amateur radio under its banner of WICEN (Wireless Institute Civil Emergency Network) was used extensively around the mountains of East Gippsland on the weekend of 4th and 5th December 2005 supporting the Historic Alpine Car Rally. WICEN operators were involved from control Headquarters at Lakes Entrance on Saturday morning to the finish line near Bruthen on Sunday afternoon. Amateur Radio operators from East Gippsland Radio Group, as well as a lot of support from other radio operators from various Clubs and groups that are WICEN members across Victoria, took part.

The job at hand was to report start and finish information into Rally Headquarters when a car had started in

a section, and the radio operator at the end of that section would in turn report when a car by number had finished that

section. This supplied all the necessary details to the officials and support crews of each car as to where it was placed. With cross reference checking at Rally control, each car was accounted for as to its whereabouts. In the case of breakdowns or rollovers, the safety and well being of the drivers could be tracked very quickly.

With around 80 cars in the rally and 19 sections covering the landscape from Lakes Entrance to Bell Bird, Buchan, Ensay and back to Lakes Entrance, this took a lot of organization and man hours by operators. Saturday operators began on check points from 9.00am and finished at 4.00am on the Sunday morning. Some operators camped overnight Saturday on-site and ran another stage checkpoint on Sunday. The main communications were done on 2 metres via FM repeaters; some repeaters are located in their permanent locations of Mt Nowa Nowa and Mt Bemm, while other portable repeaters were specifically set up just for the event on Mt Buck and Pheasants Hill. HF communications were also used as back up. For this type of event, Amateur Radio operators supply their time and portable radio gear on a voluntary basis, using the activity as training in the case of a disaster in the area. This type of operation is certainly not unique to Australia; with the hurricanes recently in New Orleans and the tsunami in Asia, amateur radio provided a lot of the communications to the disaster affected areas. Anyone wanting to find out more about amateur radio in East Gippsland can have a look at the group website at [www.vk3eg.org](http://www.vk3eg.org)



WICEN base at rally HQ



Peter VK3NPI operating the VK3EK portable setup at a rally checkpoint.

ar



# The amateur-radio-friendly vineyard

## A tale of two amateurs in a vineyard and the 160 m Trans Tasman Contest

Vince Henderson VK7VH

Do you know anyone that has operated an amateur station at a vineyard? Did I just hear you say, "why would you want to"? Well this is the story of two hams that said, "why not, what a great idea, lets have some fun".

Ray Smith VK7NRS, and yours truly Vince Henderson VK7VH, spent a great weekend with our sons on Bruny Island during April this year. Besides the fishing, swimming and beach cricket, we found a little time to operate a portable station.

Bruny Island is situated some 20 km down river from Hobart. Not only is Bruny Island a spectacular location, we found it very suitable for radio. Although there are a number of accommodation options, we wanted something a little different, at a price that would not break the bank, and the ability to do our own thing, especially the chance to have a play with radio.

A check of the Internet revealed such a place. Our weekend away was at Wayaree Estate, one of Tasmania's most southern vineyards. The property was a large farming operation until 1998 when the land was purchased by Bernice and Richard Woolley. They saw the potential for grape vines and Wayaree Estate Vineyard was born. It is now well established, and produces quality Pinot Noir and Chardonnay wines.

The original farmhouse was converted into a fully self-contained accommodation cottage. It is one of those special places that leave a memorable impression.

During our first sojourn to Wayaree Estate we asked Bernice and Richard if we could erect a wire antenna by throwing a line over the 70 foot tree that was at the rear of the cottage. "No problem", was the immediate answer. Within no time at all we were up and running with an 80 m dipole. There was no sign of the ever-present noise levels that I normally experience at home. The bands were quiet and the dipole worked very well, especially on 80 m

where everyone said that our signal was outstanding.

We had such a great time that a return visit seemed inevitable. Our thoughts turned to antennas. "What about doing something different?" we seemed to say in unison. Ray and I agreed that this would be the location to have a go at the 160 m Trans Tasman Contest. Talk soon turned to excitement as we realised that, with the acres and acres of room and the huge number of high gum trees, an antenna of major proportions might be possible.

It was time to put the question to Bernice and Richard. "Could we come back in July and set up a radio station and some big antennas?" Once again our hosts said yes. In fact, they said

that we were more than welcome to put up whatever we wanted and use any of the trees as mounting points. Not only were they great hosts, they were amateur radio friendly.

Putting together a mini island DXpedition is no easy task. However, when the location is nothing short of magnificent, and putting up a serious antenna for 160 metres is the driving forces, it becomes easy. We would enter the 160 m Trans Tasman Contest as a club station, using VK7CHT, the call sign of the Central Highlands Amateur Radio Club of Tasmania.

We decided to build two antennas, a 160 m dipole and a resonant three-half-wave 160 m long wire. The long wire would be nearly 800 feet in length



Photo 1 - The two DXpeditioners running the long wire from the feed-point to its termination way over there somewhere!



Photo 2 - The cottage at Wayree Estate on Bruny Island. The feed lines for the dipole and the long wire can be seen disappearing into that magnificent antenna support

the 160 m dipole, which took no time. The 800 feet long wire was a different story.

The job of measuring out the wire, and joining where necessary, took many hours. A point we will remember for the future, as prefabricating as much as possible before the event would have saved a great deal of time. The feed point for the long wire was hoisted into the big gum tree at the rear of the cottage just as the sun disappeared into the west. We just ran out of time! Mounting the ends of the long wire would have to wait until morning. At least we had the dipole in operation and we could test it out that night.

We found the dipole tuned easily on 160 m and, even though the SWR was 1.4 to 1, (which is what we expected at resonance), we decided to use the antenna coupler as my solid state TS 440s appreciates a little better match to keep the finals happy. We tuned up the 160 m dipole on 80 m and immediately found that it worked like a dream. Contact with the regular 5.00 pm 'sewing circle' net (or is that the knitting group - I am going to be in trouble for writing that!) on 3.590 MHz confirmed that all seemed OK as the signal reports varied from big to "I need a new needle for my S meter".

We had arranged a sched at 8.00 pm on 160 m. Our contacts proved that the dipole was working very well. We received great signal reports from VK7, VK3, VK2 and ZL. Most suggested that we should be very competitive in the contest. It was disappointing that we just ran out of time to get the long wire operational, as testing into ZL would have given us some indication of performance and allow changes to be made on Saturday. We knew that we would be flying blind with the long wire on Saturday night and, whatever the outcome, we would be stuck with it.

As Friday night passed, we also passed out near midnight and 'hit the hay'. Up again early Saturday morning, we launched ourselves into getting the long wire operational. After many casts of the surf rod into the trees, we finally had the support points and associated pulleys in place. The long wire (now affectionately know as "the antenna from hell") went up and the majority of the antenna was at least 90 feet high. To our surprise there was nowhere near the sag that we had expected.

and would require some serious anchor points. However, this was not a problem; the trees on the bottom boundary would be ideal and some were at least 90 feet high. We decided to feed the long wire a quarter wave from one end as this would allow us to have the feed point mounted in the gum tree near the cottage.

The main reason for building the long wire was to get some gain (almost 2 db) and a lobe that would favour New Zealand. This would increase our chances of accumulating good points from contacts into 'Kiwi land'. If the radiation pattern stayed true to theory

we could expect a good lobe into ZL. The dipole would suffice for all other directions.

After many weeks of preparation, the weekend of the 8th July was finally upon us.

We caught the Bruny Island ferry and, after a quick trip across the water, just a few kilometres, we drove to Wayree Estate arriving at noon. We were fortunate to have Ray's son Kiel accompany us for the weekend. A third pair of hands would prove invaluable. Thank you Kiel for your help. We immediately commenced putting up

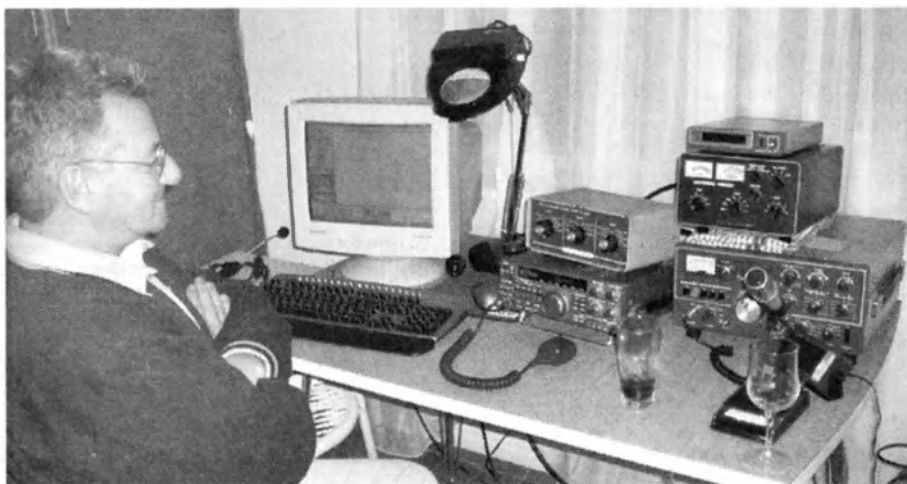

Photo 3 - Vince at the portable station - Ready to Go!!

Theory suggested that the feed point impedance should be around 110 ohms, given no reactance and little ground effects. We measured the SWR at resonance and found it to be close to what we expected, 2.4 to 1. The antenna coupler was pressed into service and, although tuning was a little fiddly, we eventually had the SWR down to an acceptable level. We then tried out the long wire on some other bands and found it to work well. Getting a test report on 160 m would have to wait until nightfall.

A little before 5.00 pm we sat down to a traditional roast lamb dinner and the obligatory glass of red wine. It was a welcome restful meal after the events of the previous two days. Earlier in the afternoon we had fired up the computer contest program and ensured that all was working as it should. We also set up a coax switch to quickly change between the dipole and the long wire. All was ready for the contest start time of 6.00 pm.

Twenty minutes before the contest, we tried out the long wire and found that it had a slight advantage into ZL. The reported signal strength was marginally better than the dipole. However, the long wire was quieter and ZL signals easier to hear compared to the dipole. This would prove to be our masterstroke, albeit without really knowing if we had the directivity of the long wire to where we wanted.

The clock ticked over to 6.00 pm and the contest was on in earnest. I started calling and immediately the pace was thick and fast. During the first twenty minutes our score rate was good and we were accumulating many contacts into ZL. The contest rules required us to move frequency after twenty minutes and finding another spot was difficult. We eventually got up and running again and the pace continued.

Ray decided that he would do the second hour, as this would allow him to look and learn from me during the first hour. Amazing as it seems, this was Ray's first foray into the world of contesting, not to mention that it was also his first time on 160 m. Hour one seemed to end quickly and Ray took over the microphone. He did not take long to hit his straps and soon had the hang of the computer logging program. Ray's scoring rate was outstanding.

We continued taking turns each

alternate hour and, although our scoring rate was OK for the first four hours, the last two hours were not so easy. Band conditions were changing and we had to listen hard for most contact exchanges. The number of ZL contacts remained high throughout the contest and this was the reason that we managed to accumulate a reasonable score at the end.

After struggling through the last hour, we decided to set up the log scoring and see how we did. We made 229 contacts and our points total was an amazing 2,190. The best news was that we scored 570 bonus ZL points compared to 460 bonus VK points. The effort in putting up the long wire antenna seemed to be justified. We felt that our final score would be competitive. We would have to wait for the results to be published to see how well we did. Regardless of the final results, we would always remember our participation in the contest as a great adventure.

The results have now been published and are as follows:

**Winner: VK/trans-Tasman Trophy -**  
(refer Multi-operator Rule):

VK3IO Ron Tremayne, Cockatoo, Vic.

**Category 6 - Phone:**

**Participation factor:**

68 ZLs divided by 119 VKs = 0.571  
- All ZLs points (not bonus points)  
for contacts with VKs x 0.571

**Equal 1st: 2203 pts, VK3IO, Ron Tremayne.**

**Equal 1st: 2232 pts, VK7CHT multi-Op Vince Henderson (VK7VH), and Ray Smith (VK7NRS) Central Highlands ARC, Newtown, TAS.**

**Note:** Under the "Multi-Operator Rule, a multi-operator station must score at least 100 pts higher than a single-operator station, to have outright claim to any prize (including the VK/trans-Tasman Trophy). If the multi-operator's margin over a single-operator station is less than 100, the Certificate will be shared, but the Trophy will be awarded to the single operator station.

**2nd: 1369, VK3BF multi-Op, Victor Punch (VK3CKD), Wheelers Hill, VIC. and Allan Tubb (VK3BF), Glen Waverley, VIC.**

**3rd: 1308, VK3FRC multi-Op, Frankston and Mornington Peninsular ARC.**

Especially in light of the above results, Ray and I both agree that our mini DXpedition to Bruny Island was well worth the effort. We had an absolute ball designing antennas, putting them up and operating in one of the best contests around. Will we do it again next year? You bet. Plans are underway for a two-element wire beam for use into ZL along with the trusty 160 m dipole. We even think that we may be able to make the wire beam three elements.

The reason that the whole weekend was such a success was due to Bernice and Richard Woolley, the owners of Wayaree Estate. They gave us the opportunity to put up whatever antenna we wanted. If you have ever thought of operating portable during a relaxed week or weekend away, then Wayaree Estate should be number one on your list of places to go. Not only do you get to operate an official IOTA island (OC-233); you get to do it in a wonderful cottage at a truly amateur radio friendly vineyard.

The Wayaree Estate web site is under construction at [www.brunyisland.net.au](http://www.brunyisland.net.au) and should be up and running soon. You can contact Bernice and Richard Woolley at 4391 Main Road Lunawanna, Bruny Island, TAS 7150. Phone and fax: (03) 6293 1088 or on mobile 0409 973 033. Their email is [wayaree@bigpond.com](mailto:wayaree@bigpond.com).

Take it from us, this has to be one of the greatest places you could stay at and operate radio. If you do decide to stay at the amateur-radio-friendly vineyard, let them know that you would like to put up some antennas and expect an extra special welcome.

If you have never given the 160 m Trans Tasman Contest a go, we suggest that you do and think about going portable to a location that would allow a big antenna. While you may not have such a great setting as we did, we are sure that you will have a great deal of fun. Look out for us next year, especially if you are in ZL, as we will possibly say "how do you read us on the three element wire beam!"

How do we sum up our time on Bruny Island? For me it is three words "what a hoot". For Ray, one word, "marvellous".

See you on 160 m.

ar

# Working AO51 on a budget

Paul Paradigm VK2TXT

IRLP Node 6335

Australian Satellite Enthusiasts Group – OZSATGROUP

www.ozsatgroup.info

Firstly, I must say from the outset that I am new to working satellites myself, having only recently gained my T call, after being away from the amateur service for a while. Most of what I am going to outline in this article is based on reading, chatting to other operators (particular thanks to VK4ZQ and VK2TRF) and my very limited experience. So, if I get something wrong, please accept my apologies in advance!

Also, this article is about working AO51 in particular, though most of what I have to say will apply to other FM Low Earth Orbiting (LEO) satellites.

Secondly, I am going to assume that you will be using (or have access to) a modern 2 m/70 cm dual/tri/quad band handheld transceiver (HT) to work AO51.

To me, working satellites on a budget means using minimum equipment, minimum antenna and includes the need for me to get out of the shack, and into an open area, with a clear view of the open sky. In most cases, the satellite you will be listening to, or working, will be more than 750 km away, so you will need a clear view to the satellite (bird)

without anything blocking the signal. At times, even light foliage can block the satellite's weak transmissions. Note AO51 transmits with an approximate power output of either 0.5 or 2 watts.

## What kind of antenna do you need?

The bottom line is that any VHF antenna will work for transmission up to the satellite. You can be successful using only the rubber ducky, which came with your handheld transceiver. However it's a little trickier on the receive side, but again, you can be successful using the simplest of vertical antenna.

A whip antenna, such as a mobile

collinear attached to the HT with a short coax lead, works a little better. Naturally, the whip will work more effectively if ground plane radials, or a ground plane mesh, are used. While using a ground plane is great, keep in mind that you will need to be holding the antenna system in one hand while operating your HT in the other. So don't make your ground plane too large or heavy!

Crossed dipoles over a ground plane mesh is probably the next step up, followed by a 70 cm Yagi. Just bear in mind that the above only applies to the receive antenna, and most of you will want to transmit as well.

As far as the transmit antenna goes, once again virtually anything will do for working LEO satellites. Your rubber ducky will do just fine on as little as 2 watts. In fact, it's best not to use a lot of power – you don't want to stomp on other users you may not be able to hear. Five or 10 watts is heaps, and you certainly do not want to use more than 20 or 25 watts.

If you are new to radio or satellites, you might be thinking that Paul's gone a bit loopy, telling us that five or 10 watts will work a repeater a thousand or two thousand kilometres away, but take my word for it, transmitting into space is easy - there are no obstacles to absorb or to deflect your VHF RF signals. You can use, say, a three element Yagi to direct your signal towards the satellite. However, if you are going to have problems, 95% of the time it's going to be on the receive side.

It goes without saying that a handheld dual band antenna or antenna system is a must for working LEO satellites. If you are just getting started in working LEO satellites, I would suggest a 2 m/70 cm

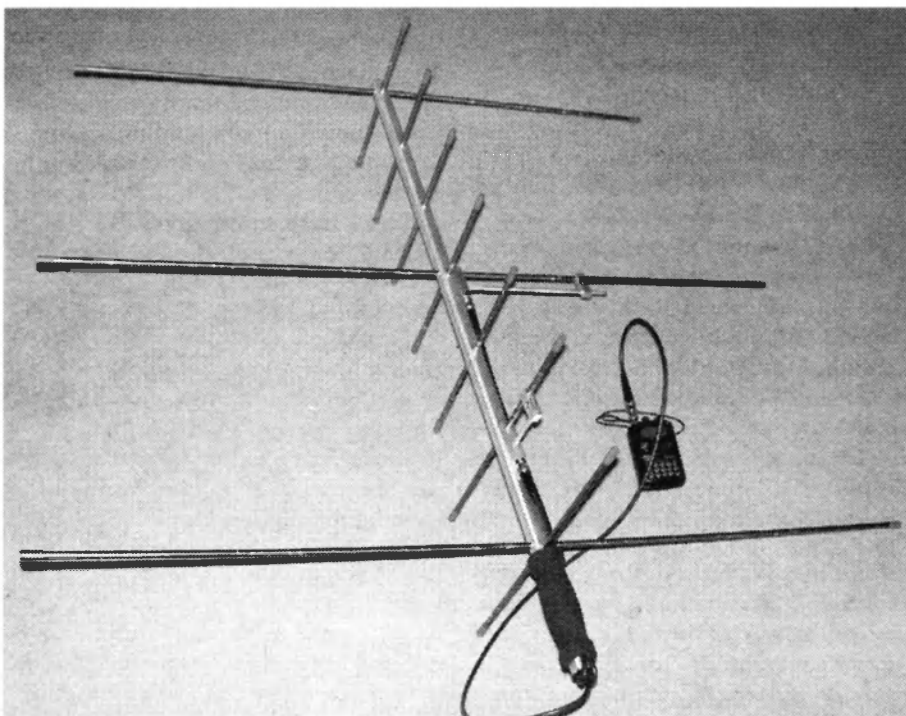

Photo 1 - The Arrow antenna.

dual band mobile collinear antenna with four to eight radials.

If you are really keen, then you might want to purchase an "Arrow" handheld satellite antenna. The arrow is a combined three element 2 m and a seven element 70 cm Yagi mounted at 90 degrees with respect to each other. Unfortunately, Arrow do not have a distributor in 'Oz' as far as I know, and they will not ship to Australia! So if you want one, you will have to buy one from a dealer in the states who offers international shipping.

### Antenna position

In the case of AO51, the satellite continuously transmits a carrier signal. This makes it easy to find the bird in the sky. You will need to move your antenna around to find the best position for your particular location. If you are using an omni directional antenna, such as a rubber ducky or whip, you will find that it will work best if you direct the tip of the antenna toward the ground at a 45 degree angle. This sounds a bit strange, but it works by maximising signal strength by utilizing the ground as a reflector. This applies equally to both receive and transmit modes, and you will find that hard surfaces work best. The 45 degree angle also helps to match the satellite's antenna polarization.

Obviously, if you are using a directional antenna, you want to aim it directly at the satellite. Rotating your Yagi on its Z axis can also be helpful. Don't forget that satellites are stabilised in space by rotating on their Z axis, changing their antenna polarization continuously. This is one of the reasons circularly polarized antenna dishes are used, whenever practicable, in commercial situations.

### AO51 Frequencies

By now you will have realised that the AO51 satellite uses two different amateur bands for reception and transmission. The downlink, or receive frequency, is 435.300 MHz, and the uplink, or transmit, frequency is 145.920 MHz. To prevent accidental triggering, AO51 requires a 67 Hz sub audible tone to overlay your FM voice signal.

### Setting up the HT

Before telling you the easiest way to set up your radio to work satellites, I want to discuss the Doppler effect. Being a licensed amateur radio operator,

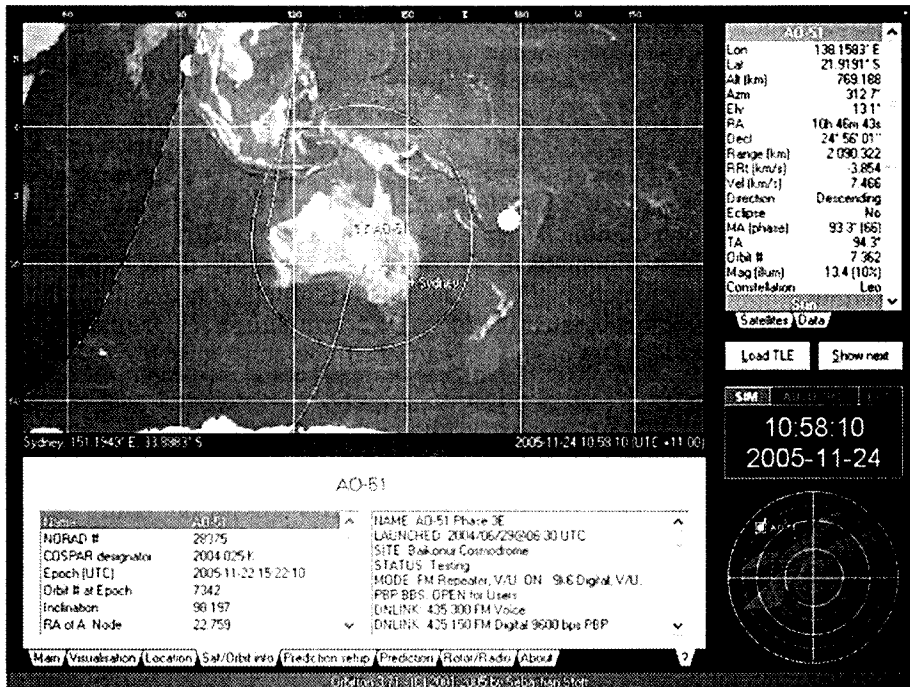

Photo 2 - Orbitron, showing a country-wide pass of AO51 in the mid morning.

you probably already know about the Doppler effect. To refresh your memory, Doppler makes a transmitted radio signal seem to change frequency as a transmitter moves toward and away from the receiving station when it is moving at high speed.

Recall that this effect is relative, meaning that it applies to both stations, even if only one station is moving. If both the stations are in motion, this complicates the situation even further!

As a transmitter moves toward a receiver, the frequency appears to be higher, and then lower as the station moves away. This effect increases with the frequency of the RF being radiated. In our case, the UHF downlink signal from AO51 will be affected by Doppler far more than the VHF uplink transmission. In fact, the VHF signal isn't Doppler shifted by all that much, so we will not have to worry about altering the uplink frequency at all.

As far as the UHF downlink is concerned, you will see about a 10 kHz shift above and below the stated transmit frequency, as the satellite traverses the sky from horizon to horizon.

Before attempting any satellite work, you will need to disable your HT's squelch control. The signals you will hear will often be too weak to break the squelch, unless you are using a very good antenna.

The easiest way to deal with the

Doppler shift on a HT or fixed step transceiver is to alter the frequency in 5 kHz steps, by manually lowering your receive VFO frequency as the bird moves toward your station. When the bird is close to, or directly above, you, your VFO should be set to the published transmit frequency. You then continue to lower the frequency as AO51 continues along its track away from your location.

To make life simpler, I pre-program five memory locations in my Yaesu VX5R as follows...

Memory Location	RX Frequency in MHz	TX Frequency in MHz
51	435.310	145.920
52	435.305	145.920
53	435.300	145.920
54	435.295	145.920
55	435.290	145.920

When the satellite appears over the horizon, as determined by the prediction software, I monitor the satellite on channel 51, and only progress to channel 52 once I lose the carrier or intelligence on the voice signal. As the carrier drops out once more, I change to channel 53, being the actual published transmit frequency of the satellite. It is at this point that AO51 is at its closest, and hence the signal will be at its strongest.

Finally, I continue to channels 54 and

55 as required. This channel changing/frequency lowering will become second nature with experience.

When you program your HT, I suggest that you use a similar scheme to that outlined above. Don't forget to set up your split to transmit on 145.920 MHz, turn on your sub audible 67 Hz Tone, and, if possible, to automatically deactivate or zero the squelch.

I used channel 51-55, just because it's easy to remember!

## Working the bird

The only thing that remains to be said is, be courteous. Working AO51 is very similar to working your local repeater, except that its coverage may encompass almost the entire country, and possibly many others such as NZ, PNG, many of the Pacific island nations, and some countries in SE Asia if you are lucky.

Unlike your local repeater, AO51 QSOs are not made equal. There are huge variations in the capabilities of the stations using the satellite. It is so easy to disrupt other users by dropping carriers on to the frequency or just by

calling CQ, when you cannot hear the satellite. Before making a transmission, listen first, and be very sure that no other operator is using the satellite. This is so important when getting started and I have to admit that it is very tempting to transmit when you are not sure whether you can hear the satellite or not. So, if you can only take one thing away from reading this article, it is this...

*AO51 continuously transmits a carrier. If you can't hear it - DO NOT TRANSMIT!*

## When is AO51 available?

AO51 operates 24 hours a day. The satellite criss-crosses the entire globe in a polar trajectory, taking about 90 minutes to complete a single orbit. In order to operate on AO51, you will need a piece of software to predict each pass of the satellite. You will also need an Internet connection to update the satellite's telemetry data (KEPS) every few days.

I use two products, both of which are available from the Internet as free downloads. On my PC I use a program

called Orbitron. This is a great free program with all the bells and whistles. You can download it from <http://www.stoff.pl/>

I also use a program called PocketSat+, which runs on my Palm handheld. This is a shareware program, which can also be downloaded from the Internet.

Many other programs are available for Windows, Mac, Linux, Palm and Pocket PC. I will leave it to you to find your best alternatives for your platform..

## Conclusion

When I first read about working satellites on the Internet it sounded difficult and very expensive. I was so wrong.

In fact, I have found that working AO51 is quite easy and, while it isn't available 24/7, at least I can make it, unlike many local 70 cm repeaters! I have spent very little money, and a little time out in the cold weather, but it works. It is a mode I can use at home with my existing gear and I can go portable with the same impressive results.

So, why don't you give it a try?

ar

# Andrews Communications Systems

ESTABLISHED 1976

ACN 001 968 752

## ICOM DISCOUNTED

- IC-756 Pro III HF+6m **\$4,999**
- IC-7400 HF+6m+2m **\$2,699**
- IC-746 Pro HF+6m+2m **\$2,699**
- IC-706 Mk 2G HF-70cm **\$1,499**
- IC-718 HF SSB **\$999**
- IC-910H 2m+70cm SSB **\$2,299**
- IC-208H 2m+70cm **\$599**
- IC-V8000 2m 75W **\$399**
- IC-T90A Triband h/h **\$449**

4 Year Warranty

## ALINCO

### Factory Direct Importer

- NEW DR-635T Twinbander **\$699**
- DR-605E Duplex dualband **\$499**
- DR-135T Mk2 2m 50W **\$399**
- DJ-V5E Dualband handheld **\$499**
- DJ-X2000E Hi-tech scanner **\$699**
- DJ-X10E All-mode scanner **\$499**
- DJ-596T Dual band handheld **\$349**
- DJ-C7 Tiny dualband h/h **\$299**
- \* 3 YEAR WARRANTY \*
- Spectrum Analysers from **\$999**
- Oscilloscopes from 20MHz to 100MHz

## ICOM IC-7000 <sup>\$2099</sup>



**HF-70cm FLL COL. TFT DISP.**  
*IF DSP, Twin PBT, 508 channel memory and much more!*

## bhi DSP NES10-2

Amazing DSP speaker

Hundreds sold!

**\$249**



## NEW!

- ANDREWS DUALBAND WHIPS frm **\$49..**  
(similar Diamond). Factory Direct Importer!
- ANDREWS BATTERIES New fr. **\$29!**
- DIAMOND Antennas fr. **\$69!**
- MALDOL Antennas fr. **\$49!**
- COMET Antennas fr. **\$59**
- HUSTLER HF Antennas fr. **\$349**
- HIGH SIERRA HF Ant. fr. **\$599**

TET-EMTRON HF Antennas in stock  
AVAIR POWER METERS, T LEADS, ETC.  
MFJ Antennas, Tuners, Analysers, etc.  
ANDREWS AMPS ..160m-10m 500W+ w/protect. **\$999**, 2m..50W FM **\$229**, 120W **\$349**, 200W **\$469**, 300W **\$999**.

ANDREWS YAESU, PALOMAR, TE SYSTEMS, AMERITRON, ICOM linear

## ANDREWS AMATEUR BASE ANTENNAS

- BF-2M2 Fibreglass 2m 6.7dB **\$99**
- BF-2M3 Fibreglass 2m 7.8dB **\$129**
- UVS-200 Fibreglass 6dB/8dB **\$129**
- UVS-300 F'glass 8.3dB/11.7dB **\$129**
- CBS18 Fibreglass 5.7dB 10m **\$149**
- Discones from **\$119**, Coax switch **\$29**

We export worldwide. We also hold some stock in New Zealand!

## KENWOOD DISCOUNTED

- TS-570SG HF+6m+ ATU **\$1,999**
- TS-480HX HF 200W+6m **\$1,999**
- TS-2000 HF-70cm + ATU **\$2,799**
- TS-2000 HF-23cm + ATU **\$3,699**
- TM-271A K 2m mobile **\$399**
- TM-D700A Dualband Mob **\$999**
- TS-480SAT HF+6m+ ATU **\$1,799**
- TM-G707A 2m/70cm mob. **\$499**

## YAESU DISCOUNTED

- FT-1000MP MkV 200W **\$3,999**
- FT-1802M 2m 50W Mob. **\$289**
- FT-7800R **\$449**
- FT-8900R Quadband **\$799**
- FT-8800R Dualband **\$699**
- FT-897D HF-70cm **\$1,399**
- FT-857D HF-70cm **\$1,199**
- FT-2800M 2m 65W **\$299**
- FT-60R Dualband h/h **\$369**
- FT-817ND HF-70cm Port. **\$999**
- VX-2R Tiny Dualband **\$299**
- VX-170 2m H/held **\$279**
- VX-6R Dual H/H **\$449**
- VX-7R Deluxe H/H **\$579**

YAESU ROTATORS DISCOUNTED \* 3 YEAR WARRANTY \*  
**Australia's Biggest Amateur Radio Stockist**

**CALL (02) 9636-9060 or 9688-4301 or FAX 9688-1995**

**SHOP 8, 41 BATHURST ST, GREYSTANES, NSW 2145**

E & OE 1/06

Why pay more? MAIL ORDER TO PO BOX 240, PENDLE HILL, NSW 2145 Some items indent. Prices subject to change without notice - limited stock, some items.

\* <http://www.andrewscom.com.au>

\* email: [lee.andrews1@bigpond.com](mailto:lee.andrews1@bigpond.com)

# New draft Australian 40 m band plan

Glenn Dunstan VK4DU  
Director WIA  
email: vk4du@wia.org.au

The WIA has developed a new draft band plan for the 40 m (7 MHz) amateur band.

The new plan is designed to

- encourage activity above 7100 kHz;
- stimulate experimentation in wideband digital modes; and
- integrate, as far as is possible, with the IARU Region 3 plan, and the plans of other countries.

The underpinning philosophy of the plan is to define band usage in terms of necessary bandwidth, rather than by mode. However, it is recognised that some modes are incompatible, such as analogue voice and data. Accordingly, these modes are each assigned their own sections in the plan.

The new plan features:

- A new broadcast segment from 7130-7150 kHz. This will provide a defined area for weekly broadcasts.
- A new wideband data modes segment from 7180-7250 kHz, which is further sub divided into unattended/automated and attended segments. The subdivision serves to prevent interference between automated and non-automated stations.
- Redefinition of the CW segment (7000-7030 kHz) to a narrow band modes segment with a maximum necessary bandwidth of 200 Hz. This means, in effect, that the previously exclusive CW segment will be shared with PSK31 and other very narrow band data modes.

The change to the previously exclusive CW segment is in accordance with evolving international practice. It is worth noting that the ZL 40 m band plan has had a CW/PSK sharing arrangement

in place for some time. Moreover, CW/PSK sharing is proposed under the new US 40 m band plan.

The new draft 40 m band plan is detailed as follows:

Segment (kHz)	Use
7000-7030	Very narrow band modes (maximum necessary b/w 200 Hz)
7030-7040	Narrow band digital (maximum necessary b/w 2 kHz)
7040-7180	Analogue telephony (maximum necessary b/w 8 kHz as per the LCD)
7130-7150	Broadcast sub-segment
7180-7190	Wideband digital, unattended (maximum necessary b/w 8 kHz as per the LCD)
7190-7250	Wideband digital (maximum necessary b/w 8 kHz as per the LCD)
7250-7300	Analogue telephony (maximum necessary b/w 8 kHz as per the LCD)

The current levels of broadcast station interference above 7100 kHz will mean that some degree of flexibility is required in use of the new band plan.

The plan is designed to be fully implemented once 7100-7200 kHz reverts to amateur primary status in 2009.

Comments on the new plan close on April 30, 2006.

Please send your comments to vk4du@wia.org.au

ar

## Australian made ANTENNAS Setting a new standard COM-AN-TENA

(formerly a j and j coman)

115 John Street  
GLENROY 3046

23 cm 36 ele slot fed yagi beam	\$190
2 ele delta loop 10/11 metre	\$249
2 ele quad 10/11 metre	\$249
10/11 beams comp opt 5 ele	\$327
10/11 5/8 vert 4 rad 1/4 wave	\$185
Tri band IIB 35 C 10/15/20 m	\$745
3 ele 20 m comp opt	\$460
log periodic 9 ele 13 30 8.4 boom	\$990
MBV 6-12-15-17-20-40-80	\$390
40 m linear loaded 2 ele beam	\$595
M B Vert auto switch 10/80 m	\$330
6 m 7 ele yagi beam 60 mm boom	\$387
6 m 5 ele comptr opt beam	\$275
Top loaded 160 m vert	\$430
10 ele high gain 2 m 3.9 m boom	\$149
17 ele high gain 70 cm 3m boom	\$129
Rotable dipole 40 m	\$250
80 m top loaded vertical	\$239
dual band 2 m & 70 vert	\$140

### Guyed Masts

21 metres 13 metres  
Winch-up & tilt-over. Aluminium and stainless steel  
three-sided construction. Auto-brake winches.

### Free Standing Masts 9.5 metres

New Baluns  
1-1 to 16-1 to 3kW



03 9773 3271  
Mob: 0419 542 437

# Mobile amateur radio operation

Steve Mahony VK5AIM

Mobile amateur radio operation is as HAZARDOUS as you make it! The hand microphone can become a nuisance with its curly cord if you are not careful. However, the hands-free single earpiece and boom mic is the answer.

The Yaesu Y2 series of headset/mic has been available for over 20 years. I have had mine since having an FT-290R, even when my wife used to call me "DAVROS" from the evil bloke in Dr WHO! I used to get funny looks until the mobile phones became popular with their hands-free systems. These hands-free earpieces and mics are an excellent source of amateur radio hands-free equipment, albeit with modifications (see my article on this conversion in the October 2001 issue of Amateur Radio pages 14 and 15).

The "safety" people will say that this communicating with mobile amateur radio is hazardous! Surely no more than conversing with your passenger! We have all seen drivers who, in chatting to their passenger, look at the passenger more than the road and the traffic ahead. What about the drivers who have their car radios or stereo systems going so loud you can hear it in your car with all the windows wound up, his and yours? You even see them nodding their head and/or tapping the steering wheel to the beat of the music. They are not concentrating on the traffic!

As regards doing two things at once, the women claim to be able to do it better than men! You have to do that, anyway, driving a car, although not quite as much with an automatic. Pilots of aeroplanes, from little Cessnas to 747s, all have to communicate wearing headsets and boom mics as well as keep an eye on all those instruments and controls. Certainly they get most of their information via the headset, but they don't have to listen for police, fire and ambulance sirens and, thank heavens,

there are not any other pilots who behave as stupidly as some of the car drivers on the roads today. As yet we have not progressed to "automatic pilots" in cars, although they are heading that way with GPS navigation and automatic speed control.

By using some common sense, enough to say to the person you are in a QSO with that the traffic is getting heavy and you had better go QRT to concentrate on the traffic, you should manage mobile amateur radio quite well.

Mankind has survived over the centuries on wheels, from his first chariot to our present day chariots, and we will go on surviving despite all the stupid things we do.

ar



Photo 1 - A mobile phone earpiece and microphone with shirt clip. It has a PTT control box.



Photo 2 - The Yaesu Y2 headset and microphone with a home-brew PTT control Box. A clip holds it onto the seat belt. The PTT switch is locking one way and spring loaded the other.



Photo 3 - A disposals ex-telephone single earpiece headset and microphone. It has a similar PTT control box to the Y2 headset combination.



## Allan M Doble VK3AMD

Allan McKenzie Doble, born on 7th September 1911 passed away on 13th February 2006. He is known to many throughout Australia as the voice of the Radio Amateurs Old Timers' club. Allan was always a contributor.

His interest in radio started with building a crystal set at age 12 and although apprenticed as a plumber, he learned radio theory by correspondence. As a young man he was required to do military service and joined the army 3rd Infantry Divisional Signals where he built their first short wave receiver. During the depression he obtained work in a radio factory, working his way up to building and later selling receivers.

He fully expected to join the signals section when World War 2 broke out, but another of his contributions got in the way. As the storm clouds of war gathered Australia began to make preparations. At this stage Allan was working as a sales representative for a company that amongst other things made sound insulation. He was attached to the Department of Aircraft Production to help with sound reduction in Beaufort bomber cockpits. At about this time he happened to see an opportunity to acquire an agency for micro-switches made in the UK. This achieved he was asked about the possibility of local manufacture. Allan knew someone who might help so he arranged meetings of the various parties and within months a full scale production had begun. Micro-switches were important to the war effort as they were the devices that detected when bomb bay doors were open or closed, undercarriage up or down, a gun mount at the end of its travel. Every plane, tank and ship had dozens of these installed. Soon he was asked to help set up a second factory to make micro-switches.

When Allan was called up, as soon as his association with micro-switches was spotted he was sent back to work. Allan was at the time disappointed that he could not join friends in the Army; however, it was all his own doing.

Allan had been a licensed amateur before World War 2 and some time after it was over was encouraged by friends to set up again with a Type 3 Mark II.

Eventually he converted to Yaesu and later Icom gear.

It was the early 70s when I moved to Hughesdale about 200 m from Allan and surprisingly it took about 5 years before I came across him on air. He asked how long I'd been there. "Oh quite a while" I said, nearly 5 years and suggested that perhaps he had moved there recently. "Ah well not exactly; he said I've been here for over thirty years".

It was about that time that the Radio Amateurs Old Timers Club of Australia was formed and Allan was amongst the foundation members. In due course I joined the club too and it wasn't long before Allan started asking if I might join the Committee. Too busy at work I said.

Allan could never take "No" as an answer for such things. His persistence was legend. We were in regular contact and as soon as I retired from full time work Allan was twisting my arm and eventually propelled me onto the Club committee. I was to find all the other committee members had similar stories of how they got there.

Allan had served as broadcast announcer for 11 years and was president of the Club for many years stepping back to vice president only recently.

He was singularly successful in obtaining first class speakers for our twice a year luncheons, no doubt due to that inability to accept "no". Recent speakers included the senior electronic designer for the Stealth bomber and a RAAF officer involved in running Australia's Over the Horizon Radar. He was actively involved in the club up to a few days before he died.

There were two other things he was justly proud of. One was proving the official war historians wrong over the midget submarines used by the Japanese to attack Sydney harbour. Allan's research, prompted by Col, VK1AU, unearthed circuit diagrams and detailed descriptions of the two way radios used for rendezvous with the mother submarine. Even the present day Japanese historians were surprised



Photo by Bill VK3BR

by Allan's discovery – the Japanese destroyed many technical records as the Americans advanced.

The other achievement was to do with the desk used by Mawson and Shackleton during their Antarctic expeditions. One of Allan's friends, Myrvin "Snow" Campbell, had purchased the desk at auction in 1930. After Snow's death Allan with assistance from Snow's widow Marjorie, orchestrated the refurbishing of the desk and its donation to The Antarctic Division where it is on display as part of the country's heritage.

In his long and productive life there were many interesting stories of his contributions, such as his involvement in devising the equipment to make the sandblasted finish on the bottles of Gilby's Gin.

He played two rounds of golf each week until a year or so ago, and until just before the end of 2005 still hit a few balls on the practice fairway each week.

The Chapel was filled to overflowing at his memorial service on 20th February 2006, showing that although he had outlived many friends he continued to make new ones. Many radio amateurs and members of the Moorrabbin and District Radio Club and the RAOTC are indeed grateful to have had Allan as a colleague. He pressed us to do more than we thought we could and we are better for it. He will be missed.

Ron VK3AFW

# Dr Young sheds some light on VHF flutter (picketing)

Philip Gabhardt VE3ACK  
e-mail: radio\_meteor@yahoo.ca

If you have spent much time operating FM mobile on the 2 metre band you have probably been plagued at times by rapid fading or picketing. Sometimes you can hear it on the FM broadcast band or see it on TV signals. If you live near a large airport, you'll hear the rapid fading of FM broadcast signals as planes take off or land.

We can turn to light waves and an experiment you may have learned about in school to gain an understanding of how the received radio signal can vary so rapidly. The similarities between light and radio waves are explored further in Appendix 1.

## Young's experiment

The key to understanding flutter is found in an optics experiment conducted in

1801 by English physicist Thomas Young. Figure 1 shows how the experiment was set up. Light from the bulb on the left shines through a slit in the first plate. The slit acts as a point source of light. Spherical waves from this slit pass through two slits in the second plate. These two slits now act as two point sources of light. And because they were produced from a single source, the light waves from these two slits will always

be in phase; that is, they are a pair of coherent sources. See Appendix 3 for further explanation of coherent sources. When the two coherent light sources in Young's double slit experiment shine on a screen, they produce the interference pattern shown in Figure 2. Notice that distances  $r_1$  and  $r_2$  (the distances from the slits to the screen) in Figure 1 are equal. Therefore light from the two sources arrives at this point on the screen in phase and total constructive interference produces an area of maximum brightness. As you move across the screen from this central point,

distances  $r_1$  and  $r_2$  are no longer equal ( $r_1$  increases and  $r_2$  decreases, or vice versa) and the two wavefronts are out of phase. The brightness decreases until a point is reached on the screen where the two wavefronts are  $180^\circ$  out of phase ( $r_1 - r_2 = \lambda/2$ ) and total destructive interference causes them to cancel. A dark region (minimum light) appears here. Moving further away from the central point results in the wavefronts coming back in phase ( $r_1 - r_2 = \lambda$ ) and constructive interference produces another area of maximum brightness. The cycle repeats as you move further away from the central point. Total constructive interference occurs whenever  $r_1 - r_2 = m\lambda$  (where  $m = 0, 1, 2, 3, \dots$ ); total destructive interference occurs whenever  $r_1 - r_2 = (2m+1)\lambda/2$ . Similar light and dark regions appear on the screen to both left and right of the central point. See Appendix 2 for a simple experiment to demonstrate this effect.

Young's experiment illustrates how flutter on radio signals is produced. Imagine that you are in a tiny car driving from the left to the right of the screen in Young's experiment. You would alternately pass through regions of bright light (maximum signal) and darkness (minimum signal). You would see flashes of light as you drive along the screen. The faster you drive, the faster the light flashes.

## The VHF radio situation

Now look at Figure 3. This time, you really are in your car and you're driving along a country road. In this case, your 2 metre antenna detects two signals, one direct from the transmitting station and another which is a reflection of the same signal. The reflecting surface could be a large building, for example.

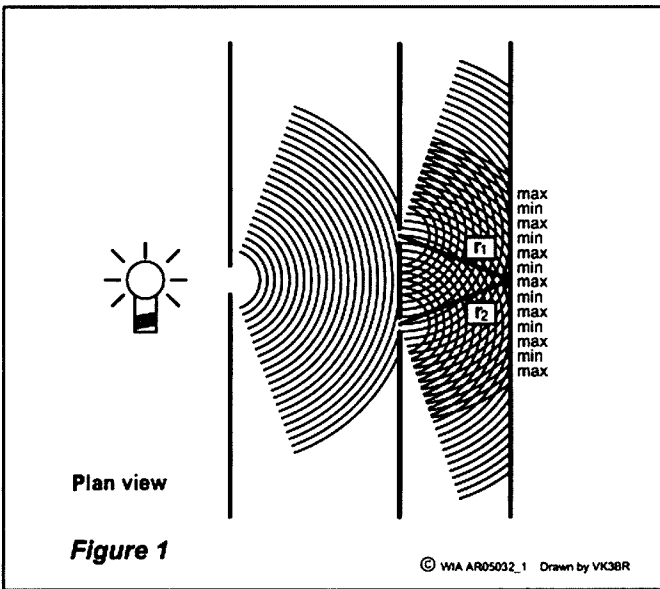

Fig 1 - Young's experiment.

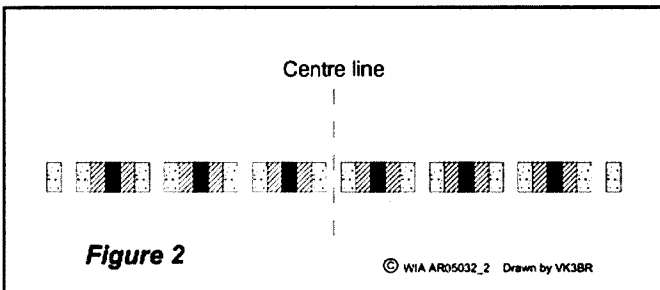

Fig 2 - Representation of interference pattern created in Fig. 1.

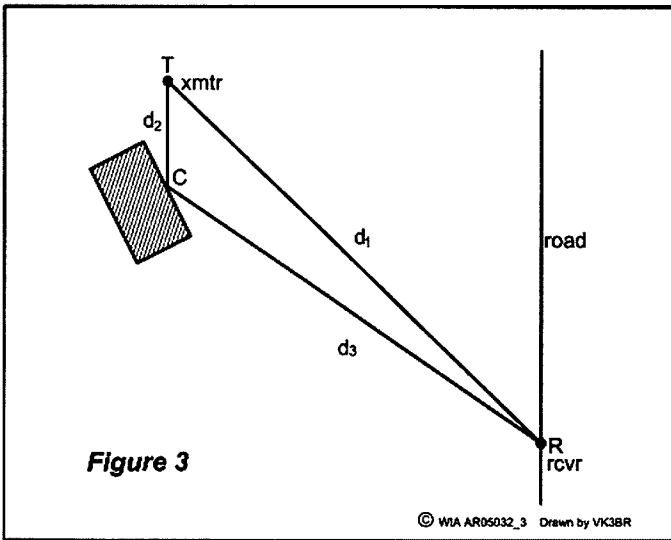

Fig 3 - Direct and reflected signal paths.

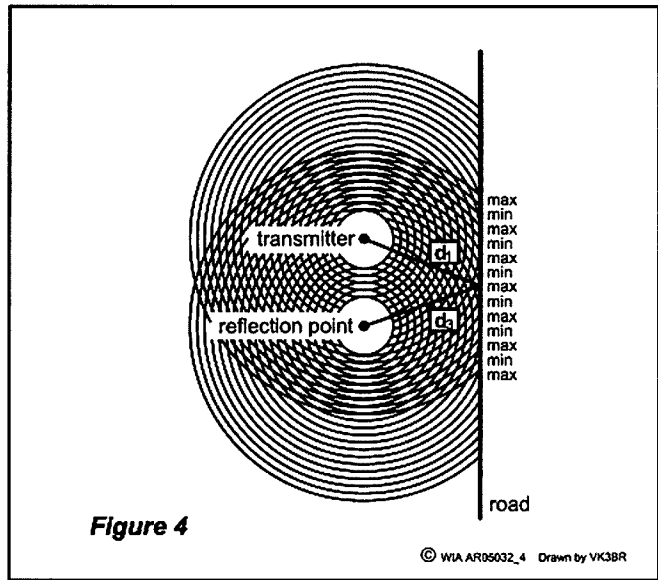

Fig 4 - Radio version of Young's experiment (compare with Fig. 1).

Both signals (like the two sources in Young's experiment) are generated by a single source - the 2 metre transmitter. They may not be exactly in phase, but their phase relationship never changes. Therefore, like the two point sources in Young's experiment, these two radio signals are coherent.

In Figure 4, which shows the radiating wave-fronts in a similar style to that in Figure 1, the screen is replaced by the road traversed by your car. The interaction between the two signals

creates interference patterns in all the space they share, and you sample a cross-section of this as you drive along the road. Just as the two slits in Young's experiment cannot be replaced by two light bulbs, the two radio sources here cannot be replaced by two separate transmitters. The frequency difference between the transmitters would result in a rapidly-changing, time-dependent phase difference which would cause the interference patterns to average out to zero.

Now we complete the rectangle ADRB. The length of side RB is  $S_r$ , the receiver offset. The length of side DR, labelled  $d$ , is the distance of the receiver from the transmitter; not direct, but projected back onto our reference line ACB along the reflecting surface. Note that side AD, which is equal to RB, is made up of lengths  $S_t$  and  $(S_r - S_t)$ .

Finally we construct triangle ACE, which is identical to triangle ATC because the angle at which the signal departs the reflecting surface is equal to its arrival angle. The purpose of triangle ACE is to create the larger triangle EDR, two sides of which have lengths directly related to the positions of the transmitter and receiver.

Using Pythagoras theorem, in triangle TDR -

$$d_1^2 = d^2 + (S_r - S_t)^2$$

where  $d_1$  is the direct path length.

Therefore,

$$d_1 = \sqrt{d^2 + (S_r - S_t)^2} \quad \text{Eq'n 1}$$

Also, in triangle EDR -

$$(d_2 + d_3)^2 = d^2 + (S_t + S_r)^2$$

where  $(d_2 + d_3)$  is the reflected path length.

Therefore,

$$d_2 + d_3 = \sqrt{d^2 + (S_t + S_r)^2} \quad \text{Eq'n 2}$$

Subtracting Eq'n 1 from Eq'n 2 yields

$$(d_2 + d_3) - d_1 = \sqrt{d^2 + (S_t + S_r)^2} - \sqrt{d^2 + (S_r - S_t)^2} \quad \text{Eq'n 3}$$

where  $(d_2 + d_3) - d_1$  is the difference in path length between the direct and reflected signals.

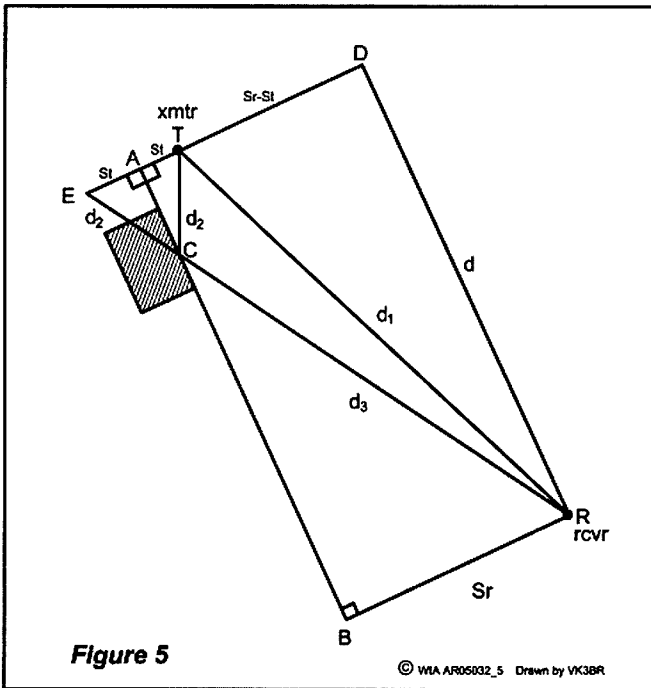

Fig 5 - Analysis of reflected signal phase delay (modified Fig. 3).

# OzGear

www.OzGear.com.au

RadioCommunications & Electronics  
Ozhelp Services Pty Ltd T/as OzGear

Suppliers of radiocommunications,  
electronics and computer products and  
electronic test equipment.

Ph 07 3114 2506

sales@ozgear.com.au  
Brisbane, Q'ld

Manager : Doug Hunter VK4ADC

## You want radios ??

Boy, do we have radios for  
you...



Australian-sourced radios with  
Australian-based manufacturer  
warranties.

Authorised Aust Icom and Yaesu Dealer

Antenna, cable, interface, tuner and  
general accessory products from...

Amlon, Andrews USA, Autek,  
Benelec, Bushcomm, Comet, Daiwa,  
Diamond, Garland, GeoSensory, GME,  
Icom, Kingray, LDG, Lutron, Mobile  
One, RFI, Sangean, SGC, TET-Emtron,  
Tigertronics, Yaesu, ZCG Scalar plus  
ARRL and RSGB publications....

# ALTRONICS

Over 8000 electronic components  
and accessories as listed in the  
Altronics catalogue with many items  
held in local stocks.

Not local to you ?

Not an issue because we ship our  
products all over Australia and to  
overseas customers every week.

Product & pricing info ?

Phone, email or visit us on the web at

www.OzGear.com.au

for the latest product info plus on-line  
ordering. Our latest price list can be  
downloaded at any time.

Payment ?



We can also calculate the phase delay  
of the reflected signal, based on this path  
difference.

$$\delta = \frac{360 \times \sqrt{[d^2 + (S_r + S_t)^2]} - \sqrt{[d^2 + (S_r - S_t)^2]}}{\lambda}$$

Eq'n 4

where  $\delta$  is the phase delay (in degrees)  
of the reflected signal,  $\lambda$  is the wavelength  
of the signal and  $d$ ,  $S_r$ ,  $S_t$  and  $\lambda$  are in the  
same units of length.

Equation 4 shows that the phase  
delay of the reflected signal depends  
on  $d$ ,  $S_r$  and  $S_t$ . That is, it depends on  
the relative positions of the transmitter,  
the reflection point and the receiver  
(your car). Fortunately Equation 4  
can be simplified by doing a binomial  
expansion of Equations 1 and 2 and  
substituting them into Equation 4. This  
yields:

$$\delta = 360 \times \frac{2S_r S_t}{\lambda d} \text{ or } \frac{720 S_r S_t}{\lambda d}$$

degrees of phase delay

## Linking the VHF radio situation to Young's experiment

We can relate VHF flutter to Young's  
optical experiment using Figure 6. As  
illustrated in Figure 4, a radio signal  
is radiated direct from point T, and by  
reflection from point C, and we explore  
the interference pattern created along  
the road PQ. And, as in Figure 5, the  
distance from the transmitter to the car  
is  $d_1$ , the distance from the transmitter  
to the reflector is  $d_2$  and the distance  
from the reflector to the car is  $d_3$ .

Here we use several simplifying  
assumptions. The first is that the signal  
path from the transmitter to the reflection  
point is parallel to the (straight) road.  
The second is that the reflection point  
is much closer to the transmitter than it  
is to the receiver (car). This means that  
the angle between the direct and reflected  
signals arriving at the receiver is very  
small.

Now we construct  
triangle FGR. F is the  
mid-point between  
the two signal  
sources and FG is a  
line perpendicular

to the road PQ. So point G is equidistant  
from both points T and C, corresponding  
to lengths  $r_1$  and  $r_2$  in Figure 1. The  
angle  $\theta$  is approximately equal to that  
in triangle TEC.

To obtain an expression that relates all  
the signal path lengths -

TR - CR = TE (approximately,  
because  $d_2 \ll d_1$ )

And from triangle TEC, TE =  $d_2(\sin\theta)$ .

Therefore -

$$d_1 - d_3 = d_2(\sin\theta) \quad \text{Eq'n 5}$$

For  $d_2 \ll d_1$ ,  $\theta$  is small and  $\sin\theta \sim \theta$   
( $\theta$  in radians)

So Eq'n 5 becomes -

$$d_1 - d_3 = d_2\theta \quad \text{Eq'n 6}$$

Now, in triangle FGR,  $\tan\theta = y/z$

Also, since  $\theta$  is small,  $\tan\theta \sim \theta$   
( $\theta$  in radians). Therefore -

$$\theta = y/z \quad \text{Eq'n 7}$$

Substituting Eq'n 7 into Eq'n 6,

$$d_1 - d_3 = d_2 y/z \quad \text{Eq'n 8}$$

For total constructive interference  
to occur (and produce a maximum in  
the received signal), the path length  
difference between direct and reflected  
signals must be an exact multiple of the  
wavelength; ie,

$$d_1 - d_3 = m\lambda \quad \text{Eq'n 9}$$

where  $m = 0, 1, 2, 3, \dots$

Now compare this to Young's experiment  
where  $r_1 - r_2 = m\lambda$ .

From Eq'n 8 and Eq'n 9,

$$d_2 y/z = m\lambda$$

and therefore -

$$y = mz\lambda/d_2$$

where  $y$  is a position of maximum signal  
strength (along the road, and measured  
from point G in Figure 6).

Finally, if we increase  $m$  by 1, and

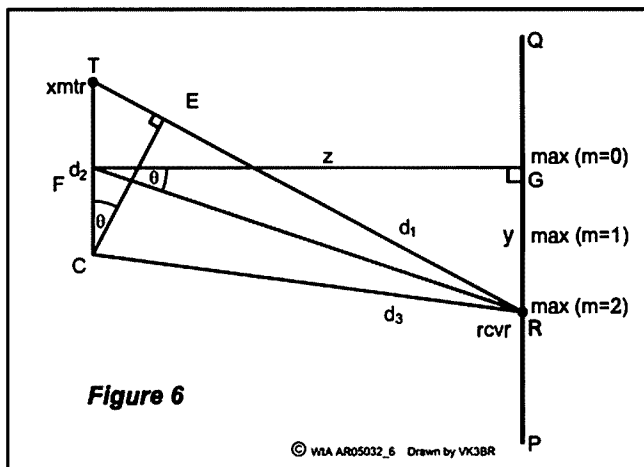

Figure 6

© WIA ARO5032\_6 Drawn by VK3BR

Fig 6 - Calculating the locations of signal maxima.

subtract the previous value of  $y$ , the distance between two consecutive maxima is -

$$\Delta y = [(m+1)z\lambda/d_2] - [mz\lambda/d_2] \text{ Eq'n 10}$$

## Example to illustrate VHF flutter

$z = 30 \text{ km}$  (distance from transmitter to road, approximately)

$m = 5$  (the wavelength multiple)

$\lambda = 2 \text{ m}$  (the VHF signal)

$d_2 = 1 \text{ km}$  (distance from transmitter to reflection point)

Then -

$$\Delta y = [(m+1)z\lambda/d_2] - [mz\lambda/d_2] \text{ Eq'n 10 above}$$

Now insert actual values, all in metres

$$\Delta y = [(5+1) \times 30,000 \times 2/1000] - [5 \times 30,000 \times 2/1000]$$

$$\Delta y = 360 - 300 = 60 \text{ m (distance between signal maxima)}$$

In this example, if a car is travelling at 100 km/h, the time taken to travel 60 m is 60/100,000 hours or 60 x 60 x 60/100,000 seconds = 2.16 seconds.

Therefore a maximum in signal

strength occurs every 2.16 seconds.

## Practical interpretations

For flutter to occur, one of the three locations (the transmitter, the reflection point, or the car) must be moving. In the case of a 2 metre mobile station, the transmitter and the reflection point are fixed while the car moves. In the case of flutter on the FM broadcast band at receiver locations near airports, the

transmitter and the receiving site are fixed while the reflection point (the aircraft) is moving.

In order for Figure 6 to match the classical mathematical solution to Young's experiment and to maintain a general solution to the problem, several assumptions have been made. It has been assumed that the direct signal and the reflected signal are in phase. This will only happen for specific values of

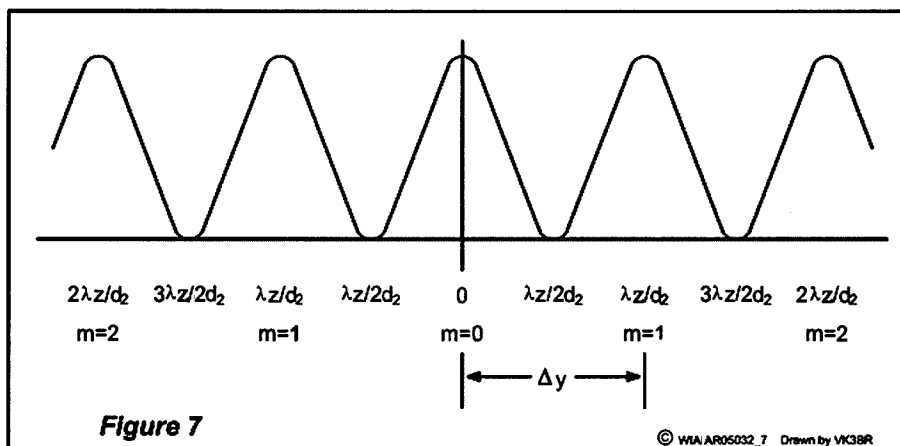

Figure 7

© WIA/AR05032\_7 Drawn by VK3BR

Fig 7 - Signal strength variation with distance along the road.

# TET-EMTRON

## NEW!

### TE-33M THREE ELEMENT TRI-BAND MINI BEAM

If you haven't got the room for a full size three element beam, but you want more gain than the two element TE-23M, then this is for you.

#### SPECIFICATIONS

FREQUENCY	14, 21, 28 MHZ BAND
MAX.ELEMENT LENGTH	5520 MM
BOOM LENGTH	4.0 M
GAIN	6 / 6 / 7 DBI
FRONT TO BACK RATIO	20/ 15/ 14 DB
FEED IMPEDANCE	50 OHM
TURNING RADIUS	3.74 M
WEIGHT	12 KG
POWER RATING	2 KW PEP



- \*ALL 6000 SERIES ALUMINIUM CONSTRUCTION.
- \*ALL STAINLESS STEEL HARDWARE.
- \*2 KW PEP POWER RATING.
- \*3.74 METER TURNING RADIUS.

#### RECOMMENDED RETAIL PRICE

ONLY **\$858** INCL. GST

If you already have a TE-23M, you can purchase the extension kit containing extra boom, director element, and everything you need to upgrade to this antenna.

Complete kit: \$255 incl. GST.

See Website [www.tet-emtron.com](http://www.tet-emtron.com) for dealer list.

## RAWMAR ENTERPRISES

40 Blackburn Street,  
STRATFORD.  
Victoria, Australia. 3862

Ph: 61 3 5145 6179  
Fax: 61 3 5145 6821  
Email: [rawmar@hotmail.net.au](mailto:rawmar@hotmail.net.au)  
ABN: 87404541761

$d_2$ , the distance from the transmitter to the reflection point. Nevertheless, the direct signal and the reflected signal are coherent (ie, have a fixed phase relationship) for all values of  $d_2$  and therefore the two signals will produce an interference pattern. Depending on the value of  $d_2$  and therefore the relative phase of the two signals, the maximum and minimum points will simply shift along the road. Furthermore, due to the reflection process, there will be a phase shift introduced at the reflection point, which will also displace the maximum and minimum points.

Also, the road in Figure 3 runs parallel to  $d_2$ . Obviously, this is not necessarily the case. As with the phase shift, the orientation of the road will simply alter the positions of the maximum and minimum points. You will notice that, in Figures 3, 5 and 6, the distance between the transmitter and the reflection point is small compared to the distance between the transmitter and the receiver. This too does not necessarily hold true during mobile operations.

Earlier it was mentioned that when the two signals are  $180^\circ$  out of phase, there is destructive interference and the two signals cancel. However, there will only be total destructive interference (minimum signal equals zero) when the two signals have the same amplitude. If the reflected signal is weaker than the direct signal, then the destructive interference will produce a minimum (but non-zero) signal.

Clearly there are many conditions under which flutter can arise. Nevertheless, just knowing how flutter

occurs may be enough to make it more tolerable when you're trying to carry on a QSO.

## Appendix 1 - Light and radio waves

Various types of radiation (radio, heat, light, etc) have differing wavelengths, but they are not fundamentally different. They all travel through free space at the same velocity and are generally understood in terms of the same theory. For example, both light and radio waves are subject to reflection, refraction and diffraction. What characterises the various 'kinds' of radiation are the means by which they are generated and detected. Consequently, observations made on one 'kind' of radiation can usually be assumed to be true of the other 'kinds' (with the exception of observations which are dependent on wavelength).

This concept is known as the unity of radiation. The unity of radiation enables you to apply to radio the principles you learned about light in high school. The concepts dealing with constructive and destructive interference presented in this article are based on the unity of radiation and an understanding of how light waves (and therefore radio waves) behave.

## Appendix 2 - Observing interference patterns

You can recreate the double slit experiment which Thomas Young performed in the early 1800s. The

interference pattern which appears in this experiment is a series of bright and dark fringes of light similar to Figure 2. The pattern is an optical version of the picketing or flutter experienced on VHF signals.

At optical wavelengths, the slits need to be very narrow and closely spaced. This is difficult to achieve, so it is easier to use pinholes. Either configuration (slits or circular apertures) is known as a wavefront-splitting interferometer. Punch two small pinholes in a thin piece of aluminium foil. The pinholes need to be extremely small, so use the smallest sewing needle you can find and press it into the foil only far enough to produce a hole. Pushing the needle right through the foil so the hole is the diameter of the needle will probably produce a hole which is too large. The spacing between the centres of the two holes should be approximately three radii.

Do the experiment at night. Your light source can be any strong source such as a streetlight or a car headlight. I obtained good results with streetlights at least 100 metres away. Hold the foil directly in front of and very close to your eye. You will find the best distance from the foil to your eye by experimentation.

## Appendix 3 - Young's double slit experiment.

The apparatus is known as a wavefront-splitting interferometer because the two slits in the second plate split the wavefronts approaching from the left into two separate sources. Wavefronts from these sources then interact to produce an interference pattern, which appears on the screen at the right.

You might wonder why we don't simply replace the two slits with two light bulbs as sources. The problem is that the filaments in lamps contain a large number of atoms. Each atom is capable of radiating a wave train for about  $10^{-8}$  seconds. Therefore, the maximum time the two lamps can maintain their relative phases is, at best,  $10^{-8}$  seconds. They would indeed produce an interference pattern, but the pattern would only remain constant for that brief time, after which it would change as the relative phases shifted. The pattern would then remain constant for another very short time before it changed again.

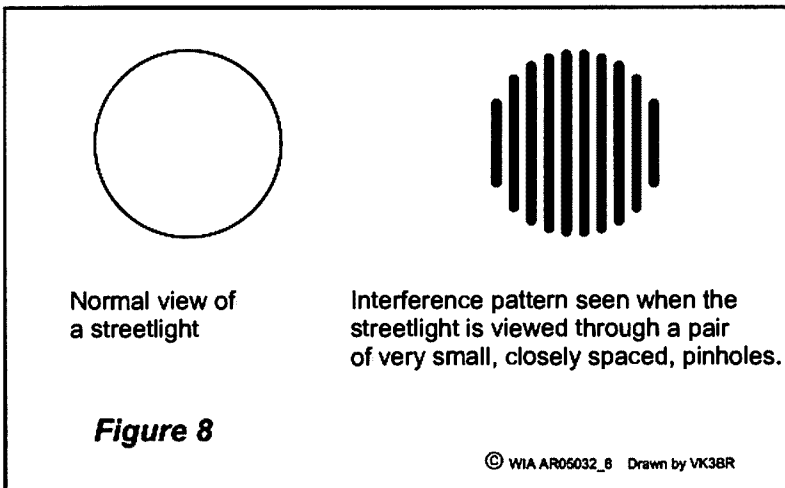

Fig 8 - Experimental interference pattern.

## The Black Stick errors

I write with reference to the article *The VK5BUG Black Stick*, which appeared in the last edition.

While construction of the 'Black Stick' as described in the article may well result in an antenna that provides wide frequency coverage, performance will be mediocre, at best.

The only really effective way to feed a vertical antenna is to match the antenna to the transmission line at the antenna feed point – not at the transmitter end as described in the article. Attempts to match the feed line impedance at the transmitter end result in high losses because of the very high VSWR on the feed line. Of course, VSWR and therefore loss varies with frequency.

For instance, total loss in the "Black Stick" antenna, feed line and ATU at 3.5 MHz is approximately 13dB, - i.e. only 5% of the transmitter output power is radiated.

Moreover, the 'Black Stick' configuration will also generate radiation from the feed line - it is effectively part of the antenna - thereby increasing the chances of RFI at the radio end with all that implies for EMC/EMR.

Unfortunately, the author is in error when he states that:

"Of course there must be a mismatch between the feed line and the radiator in my Black Stick, but RF loss from such a line, even if it showed an SWR of 25:1 up at 28 MHz, would still be less than the loss in RG58 coax when the latter is matched."

A 7 m length of Belden 8222 operating with a VSWR of 25:1 at 28 MHz exhibits a loss of 5.5dB.

A 7 m length of RG58C/U operating into a 50 ohm load at 28 MHz (i.e. VSWR 1:1) exhibits a loss of 0.54dB.

I understand that the Belden 8222 cable the author uses for his feed

line may no longer be commercially available.

The most effective and convenient method of feeding an unloaded vertical antenna for multi band operation is to use a remote automatic tuner at the base of the antenna. There are a number of commercial units available, with the most popular being made by the American company SGC.

Use of a remote tuner means that the transmission line impedance is matched to the antenna feed point impedance, minimising VSWR (and therefore loss) on the feed line. This configuration also minimises the possibility of RF energy being present inside the operating room.

More information on the care and feeding of multi band vertical antennas may be found at

<http://www.vk1od.net/>

73 Glenn Dunstan VK4DU

## Technical article shortage

The most likely reason for the shortage of technical articles is that many members regard that task as a waste of time best devoted to the next project. Also, asking for technical "articles" implies a requirement for magazine quality and that is probably a disincentive. Writing a technical report is a different exercise and experimenters and constructors appreciate the purpose and value of a report to finalise a project. So, publish "technical reports" not technical articles.

The purpose of a technical report is to record the processes involved and the conclusions drawn after the completion of the experiment or construction project. Writing the report improves the author's understanding of the subject and provides useful information for future reference and to invite discussion and criticism. Publication in AR serves those latter purposes and editorial policies should include provision for

that in a regular "technical discussion" column.

A technical report should be strictly utilitarian – providing technical information clearly and concisely. Presenting the facts is more important than style of presentation but style should not be neglected entirely because it determines readability and ease of understanding. Most technical authors are not skilled word spinners and a high degree of that skill is not needed. Editorial scrutiny for technical accuracy will not be necessary because a report is just that; a report of actual experiments or construction projects carried out by the author. Scrutiny by readers and their published comment will reveal technical inaccuracy and likely misleading information.

The school laboratory report

format is a simple, adequate presentation, and particularly suited for the new generation of Foundation Licensees. Examples have appeared in past issues of AR and from memory the sections are aim, apparatus, method, results discussion and conclusions.

Lindsay Lawless VK3ANJ

**The views expressed in the *Over to you* column are those of the authors, and do not necessarily reflect the official policy of the Wireless Institute of Australia.**

## OzSpid Rotators

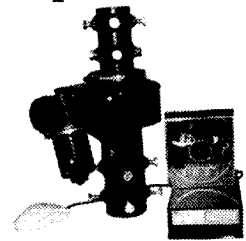

Oceania - New Zealand - Australian  
Distributors.

Australian Enterprise Industrial

P.O. Box 1013

Browns Plains. QLD. 4118.

Ph. 0414 254 080.

Fax. 07 3800 8003.

[aitower@spin.net.au](mailto:aitower@spin.net.au)

<http://www.spin.net.au/~aitower>

# Re-using microwave oven transformers for high-voltage power supplies

Draw Diamond VK3XU

One of the difficulties for the linear amplifier builder is in obtaining high-voltage power transformer(s). A popular requirement for (say) a 1.3 kV plate supply is a transformer with a secondary voltage of typically 1 kV RMS at perhaps 500 mA or 1 A. A costly item, even second-hand, and as a made-to-order part? It hardly bears thinking about.

A few resourceful enthusiasts have had some success with transformers rescued from defunct microwave ovens. They certainly look attractive to the handy amateur. Let me list some of their features: cheap (usually zero cost), well-made to high electrical and mechanical standards, core/primary rating of about 400 ~ 500 VA, re-workable for low and high-voltage PSUs, large volts-per-turn, crude voltage regulation provided

(by running in saturation mode), and quiet operation (due to welded laminated core).

Their disadvantages are: increasingly poor efficiency when operated above about 200 V AC primary voltage (and therefore runs very hot if powered continuously), secondary HV winding

connected to core (easily altered - see later), and the welded core makes disassembly impossible.

In its usual application, the transformer runs in 'saturation' mode, where the primary magnetizing current is quite large (typically 1.5 A). This, together with the magnetic shunts fitted to the core, provides a degree of output DC voltage regulation, and so allows for a wide range of loads upon the 2 kV secondary winding that powers the magnetron oscillator (Reference 1). Intermittent domestic use normally provides prolonged cooling-off periods for the transformer, so a much smaller core may be

employed. To prevent damage, however, a number of thermal cut-outs are fitted to vital components within the appliance (Reference 1).

The estimated number of turns found on the typical "rescued" transformer primary is about 240, which is one volt per turn - a very high figure. If one makes some reasonable assumptions about the core flux density; application of the usual winding formula (References 2 and 3) confirms that the primary is actually better suited to 120 V AC, giving (usually) 0.5 volts-per-turn.

A solution is to run two identical or similar transformers with their primary windings in series (120 V AC across each primary) from a 240 V AC supply. Magnetising current is then only about 180 mA. Their secondary windings may now be connected in parallel to give 1 kV AC (about 1.3 kV DC), or in series to produce 2 kV AC (about 2.6 kV DC) for "voltage-hungry" tubes like 4-125s or 813s. We thus have two 400 VA transformers, loafing along, each capable of delivering its rated VA continuously.

## WARNING.

*Voltages in equipment in this article are lethal. This article is only for experienced operators. Rigorous attention to safety is mandatory.*

*Particular attention should include making sure that contact with this equipment during operation is impossible, even by accident such as bumping and fainting. A second person as a safety observer who can disconnect the power and call for help is recommended.*

Technical Editor.

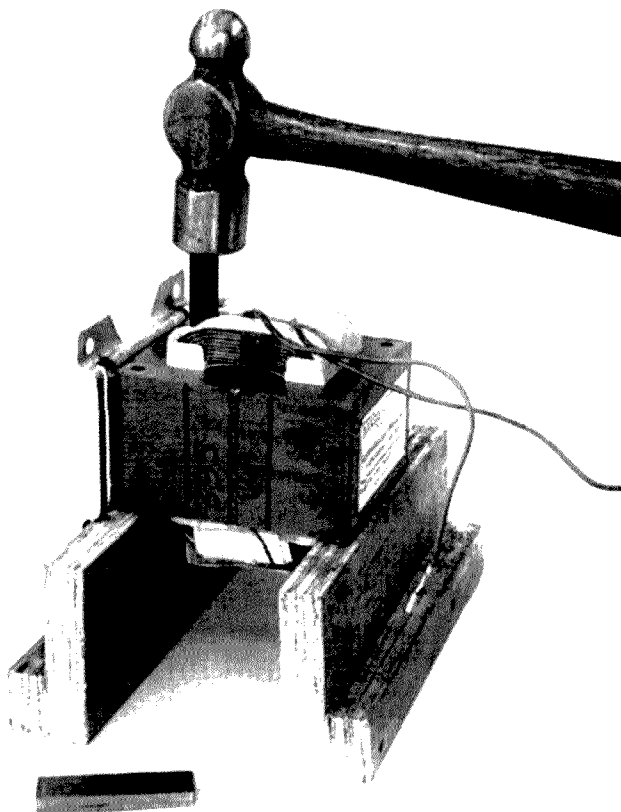

Photo 1 - Removing magnetic shunts.



## Method

Before I go further, let me state the following warning: Tests upon, and modifications to, mains transformers, as described here, must only be done by suitably experienced and/or qualified persons. **There is a real danger of ELECTROCUTION should skin contact occur.**

### Here are some essential rules:

- **Keep hands off when mains voltage is applied. Do not rely upon the insulation of multimeter test prods and leads.**

Therefore

- **Connect your meter using suitable connectors, and then adopt a strict "hands off" attitude whenever mains is applied.**
- **Always earth the cores to mains ground.**
- **Never leave a test set-up unattended by you. Disconnect and remove the mains lead when each work session is completed.**

Find two or more discarded ovens (they should be heavy - newer ovens use switch-mode power supplies) of similar power rating. Upon disassembly, save the spade connecting wires, particularly the valuable HV wires that connect the diode, magnetron and capacitor assemblies.

With a multimeter on ohms x1, measure the resistance of the primary winding, which should be about 1.5 ohms. The secondary winding is measured between the mounting plate and the single spade lug. A slow reading of about 60 ohms to 90 ohms should be obtained. If there are no "brown" smells, the transformer is probably serviceable.

The transformers must be fairly well matched for VA rating. Measure the winding-limb area, shown marked upon the core in Photo 1. VA may be calculated:

$$VA = (5.58 \times L \times W)^2 \text{ (References 2 and 3) where L and W are in inches, or}$$

$$VA = (0.00865 \times L \times W)^2 \text{ where L and W are in mm.}$$

To test a transformer, you will need a multimeter capable of measuring to 2.5 kV AC (such as an AVO Model 8). Wire a mains lead to a 240 V 60 W lamp connected in series with the primary winding, as shown in Figure 1. All connections MUST be insulated. Apply mains power. The lamp should only

light to about half brilliance, indicating that the transformer is probably good.

Carefully measure the voltage across the reactance of the primary winding, which should be about 120 ~140 V ac. Remove power, then connect your meter, set to 2.5 kV fsd across the HV winding. Apply power again. You should obtain about 1 to 1.3 kV ac across the secondary. If your two transformers give similar voltage readings, and their core VA ratings are the same or similar, then it is quite practicable to connect them as described later.

For amateur applications that require a well-regulated, low-ripple HV supply, it is impracticable to use a secondary that has one side grounded to the core (and don't even think about 'floating' to core). In most instances the coil wire may be carefully 'lifted' from the ground lug, so that the winding is isolated. Extensive tests upon a number of transformers have shown that the quality of insulation normally fitted is easily capable of withstanding 2 kV AC RMS between winding inner and core.

The aforementioned magnetic shunts

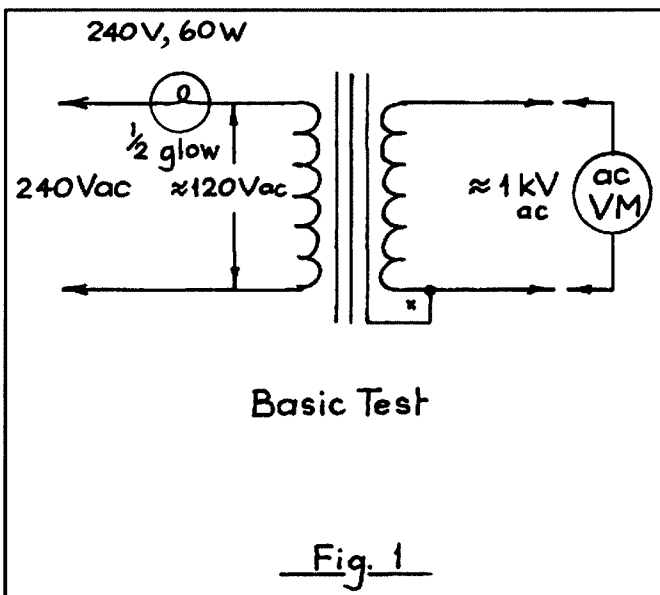

should be removed. Place the transformer upon two pieces of timber then, using a suitably sized length of steel or brass, drive the two shunts out of the core, as depicted in Photo 1. One thus removed shunt may be seen in the foreground. The 'flying' leads are those of the 3.3 V heater winding. They may be simply clipped, leaving the winding intact, or the (usually) three turns may be unwound from the core, as desired.

Photo 2 shows a typical modification, where the ground connection has been severed, and a new length of high-voltage wire soldered to the enamelled wire where it emerges from the coil. Use a cable-tie, or similar, looped

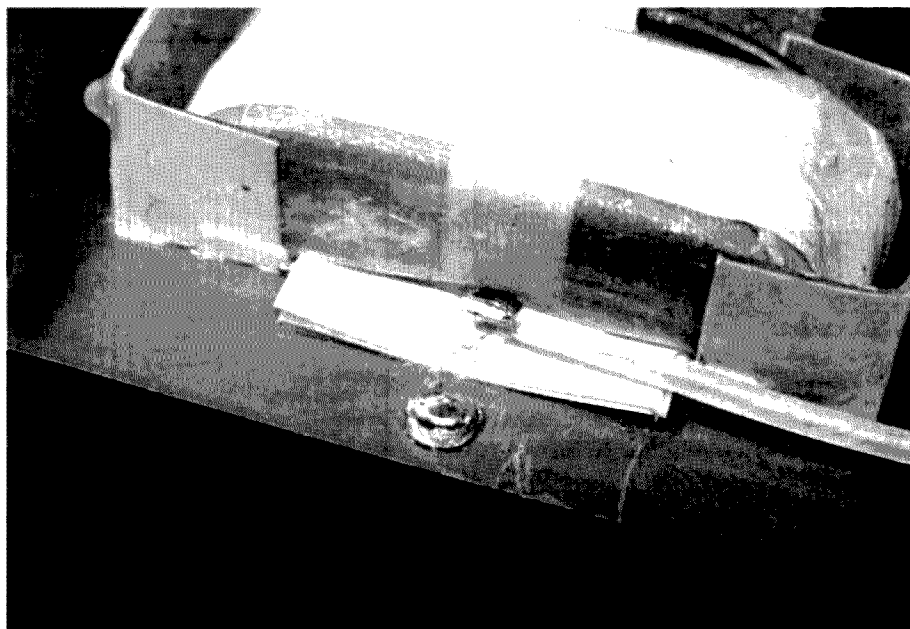
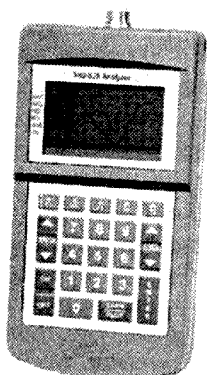

Photo 2 - New HV wire connected.



## Analizers for:

- \* 0.1-50MHz Complex impedance
- \* Antennas (140-525MHz shown)
- \* Time Domain Reflectometer (TDR)



Convert your analogue transceiver  
to **DIGITAL**  
In one Easy Step!

- \* Robust OFDM modulation
- \* G4GUO open protocol
- \* Voice only or Voice, Data & Video

The AOR ARD 9000 series digital  
modem for HF SSB & VHF/UHF  
FM Transceivers

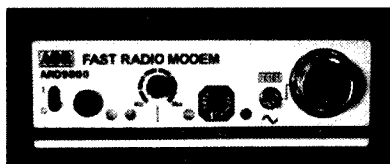

Further information from:

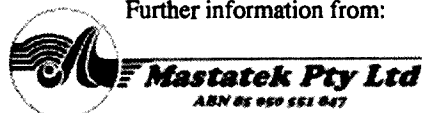

sales@mastatek.com.au  
OR  
Phone (03) 9753 4300

around the winding, where necessary, to anchor the new wire. The connection, and the area around the wire's exit, must be covered with a layer of acid-free silicone, as pictured in Photo 3.

Fabricate a rectangle of Bakelite, phenolic, or similar insulating material such that it spans two of the core mounting holes. Fit two well spaced (from each other, and ground) screw terminals and/or spade connectors to suit your planned project. The insulator may be mounted upon the transformer using  $\frac{5}{32}$ " Whitworth or 4 mm all-thread in a

manner like that shown on Photo 4.

## 1 kV AC Secondary

Having thus modified two transformers, it only remains to find the correct 'phasing' of the windings. Wire the primaries in series with your 60 W test lamp, as shown in Figure 2. Arbitrarily connect the secondaries in parallel. Apply mains power. If the lamp is bright, the phasing is wrong. Reverse either the connections to one primary, or those of one secondary, and try again, whereupon the lamp should glow

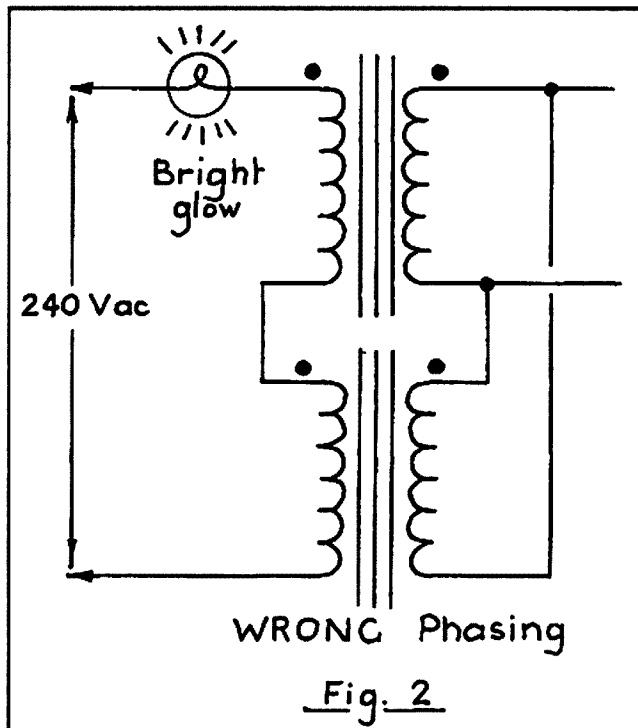

dimly (Figure 3). With the lamp out of circuit, measure the secondary voltage, which should be about 1 to 1.1 kV AC. Each primary should have 120 V AC applied, as shown. Suitably mark your connectors accordingly.

## 2 kV AC Secondary

The secondaries are connected in series, as shown in Figure 4, such that the formerly grounded sides of each winding, marked 'x', are wired together (thus greatly reducing the stress on the insulation). Arbitrarily

wire the primaries in series. Connect your multimeter set for 2.5 kV AC to the whole secondary. Apply mains power. If near zero volts, phasing is wrong - reverse one primary. If 2 to 2.2 kV AC - phasing is correct.

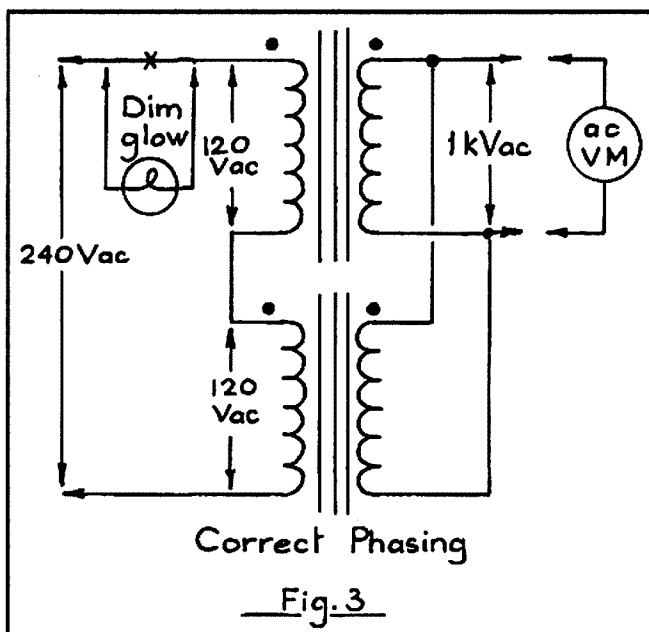

## Rectifier Circuit

An appropriate rectifier/filter rather depends on application. However, for a 1 kV AC primary, a full-wave diode bridge



Photo 3 - Siliconed HV wire connection.

comprising at least 3 x 1 kV PIV/3 A diodes per leg (12 diodes) is suggested. The filter capacitor may comprise 4 x 220  $\mu$ F/400 or 450 V in series, with a 100 k 3 W metal-film bleeder resistor across each capacitor. No-load output will be about 1,300 V DC. At a load current of 400 mA, voltage will (typically) fall to 1100 V. Double the diode and capacitor numbers for a 2 kV ac secondary. Typical rectifier circuits may be found in References 4, 5 and particularly 6.

### Primary Circuit

For either secondary configuration, the primary side should be wired in accordance with Figure 5. Include a 4 A 'slow-blow' fuse in each side of the mains supply. A slow-start circuit was found not to be necessary. All connections must be suitably covered to prevent accidental contact.

*continued next page*

VX-150 2m H/Held  
Special Buy  
Only \$249.00!

Visit us at  
[www.gccomm.com.au](http://www.gccomm.com.au)  
for new product updates!

# G&C

## COMMUNICATIONS

Authorised dealer for Icom YAESU Kenwood Barrett RFDS GME Electrophone Uniden

See us for CAR Stereo too! ~ 'Cranbourne Car Sound'

### ICOM (Australia) TRANSCEIVERS

IC-756 Prof III HF + 6M	\$4,999
IC-7400 HF +6M +2M	\$2,699
IC-7000 NEW! HF-70cm Mob	\$2,299
IC-706MKIIG HF-70cm	\$1,449
IC-718 HF SSB	\$999
IC-910H 2M/70cm Multimode	\$2,499
IC-2720H 2M + 70cm D/Band	\$699
IC-208H 2M + 70cm	\$579
IC-2200H 2M H/Power 'NEW'	\$449
IC-T90A Tri-Band H/Held	\$479
IC-V82 2M @7W H/Held	\$349

2 YEAR ICOM (Aust.) Warranty!

★ Full Product Range Available! ★

Full range of Communications/Scanner Receivers available from Icom, Uniden, Yaesu \$ POA

Comet CHA-250B HF Vertical  
3.5 ~ 57 MHz \$699

### Antenna Tuners



### Antenna Rotators G450A (shown)



- G-2800DXC
- G-1000DXC
- G-800DXA
- G-650C
- G-450C
- G-5500
- G-550

TE series EMTRON HF ANTENNAS  
Australia wide orders welcome  
Credit card Cheque Money order

### YAESU Transceivers

FTDX-9000 Elite HF Base	\$16,499
FT - 1000MPMKV Field	\$3,499
FT - 897D HF - 70cm	\$1,399
FT - 857D HF - 70cm	\$1,299
FT - 817ND HF - 70cm	\$1,049
FT - 8900R Quadband	\$ 799
FT - 8800R Dualband	\$ 699
FT - 7800R Dualband	\$ 469
FT - 2800M 2MT 65Watt	\$ 339
FT - 60R Dualband H/H	\$ 369
VX1R w/2 batt Dualband	\$ 249
VX2R Dualband H/H	\$ 329
VX-6R Dual/Band H/Held	\$499
VX -7R Tri-Band H/Held	\$599
VX -170 2M Rugged H/Held	\$279
VR-5000 Receiver	\$1,199
VR-500 H/H Receiver	\$499
VR-120D H/H Receiver	\$ 279

Call in and see our range of power supplies, cables and connectors

Comet & Diamond  
Antennas & Accessories

Proudly Supporting Australian Business

207 High St. Cranbourne VIC 3977  
Ph: 03 5996 3298 Fax: 03 5995 0184

Email: [gccomm@bigpond.net.au](mailto:gccomm@bigpond.net.au)  
[www.gccomm.com.au](http://www.gccomm.com.au)

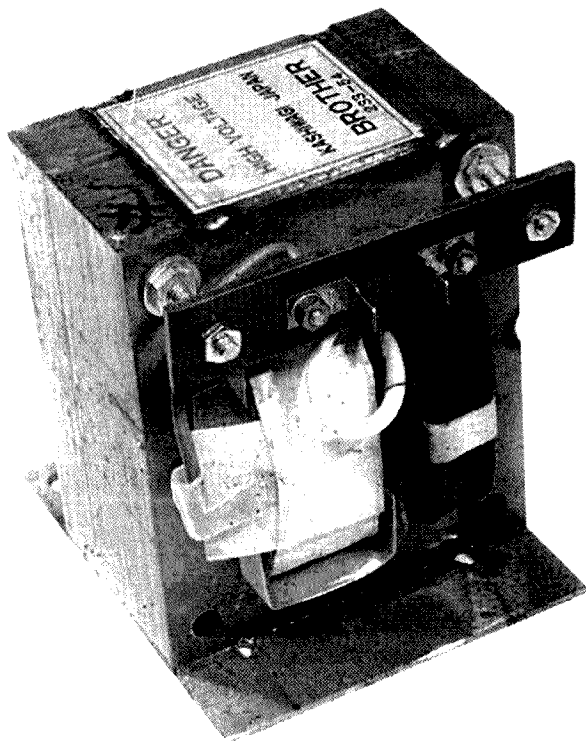
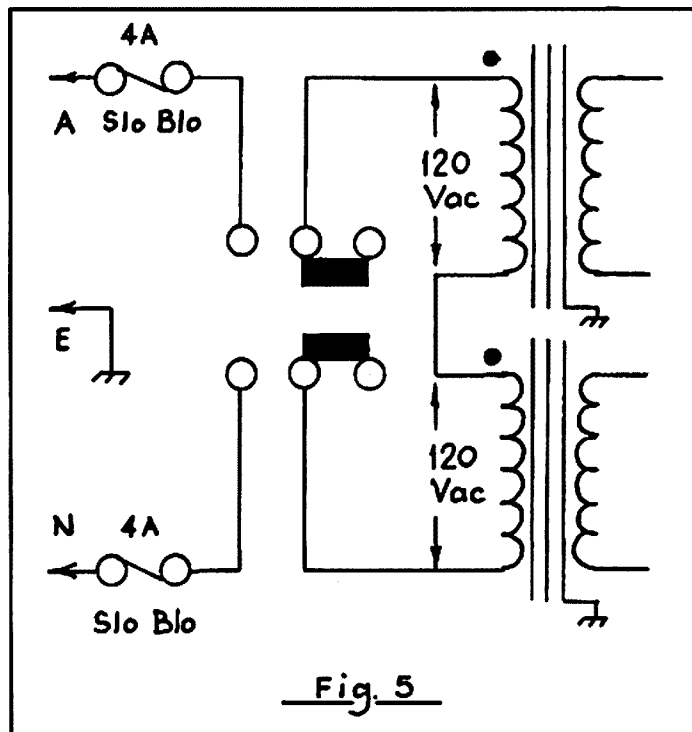
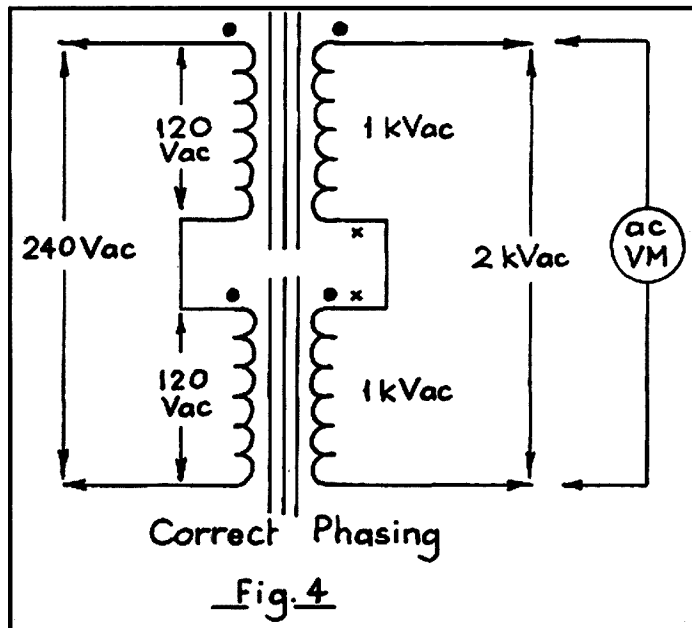

Photo 4 - Terminal strip fitted.



## References and Further Reading

1. Microwave Oven Operation and Service Manual; R. Humphris, RMIT.
2. Radio(tron) Designer's Handbook; F. Langford-Smith, 4<sup>th</sup> Ed, Ch 5, Sec 5.
3. Coil Design and Construction Manual; Bernards Radio Manual #160, Ch 4.
4. The ARRL Handbook for Radio Amateurs (any recent Ed), Ch 11 and 13.
5. Radio Communication Handbook; RSGB, 7<sup>th</sup> Ed, Ch 15.
6. Radio Handbook; W. Orr, SAMS, 23<sup>rd</sup> Ed, Ch 19.

Photography: Andrew Diamond

ar

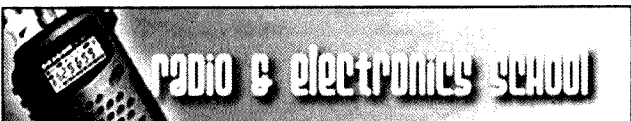

## Become a radio amateur

Check out the courses on offer from Australia's premier training institution for radio amateurs and hobbyists.

## Already licenced?

Upgrade to the Standard licence using our self paced multi-media CD ROM course. The easiest way to become a licenced radio experimenter.

Discover digital communications, get more power and more bands

## Still want more?

Be guided by one of our experienced facilitators using our proven on-line study methods and get your Advanced licence.

## Visit

<http://www.radioelectronicschool.com>  
for more information,  
or email the course manager at

[info@radioelectronicschool.net](mailto:info@radioelectronicschool.net)

Telephone 07-5573-2795 12-5PM AEST

Amateur radio – a bridge to careers in radio communications technology

## VK2

Tim Mills VK2ZTM.

Members of AR-NSW are advised of a minor adjustment to the close of nominations for election to Council and for Motions and other business for the AGM on the 22nd April 2006. It will now be at noon, Saturday the 11th March 2006. Details are given in the weekly news bulletins from VK2WI.

AR-NSW will conduct the next Foundation assessment as well as exams for either the Standard or Advanced on a weekend in early April. For bookings, contact the office on 02 9689 2417 or email at vk2wi@ozemail.com.au.

This month is another round of tenders which will close off on March 10th. Check out details on www.arnsw.org.au . Collection will be available at the March T&T on Sunday the 25th.

Travelling over Easter? A reminder that the Urunga Convention is held on

Easter Saturday and Sunday. Urunga is on the NSW Mid North Coast, just to the south of Coffs Harbour.

The VK2WI team has gained a couple of operators. Tony VK2ACV and Nick VK2ZNF. The second quarter roster - April to June - will be compiled soon and further help is required as a couple more have had to drop out for a while. Please consider joining the broadcast team. Contact John VK2JVV, the roster coordinator or the AR-NSW office. We need to spread the load.

The Eastern suburbs of Sydney are well served by the Waverley Amateur Radio Society which has club rooms at Rose Bay. They have a Project afternoon on the first Saturday afternoon of the month and a monthly meeting on the third Wednesday. They go back to just after the First World War and have been

operational, with a few quiet periods, since then. Check out their details at www.vk2bv.org . They have an annual auction Saturday in June. They operate repeaters on 2 metres and 70 cm.

An active country club is the Oxley Region ARC at Port Macquarie. They have a monthly meeting on the first Saturday afternoon and informal gathering on the second and fourth Friday evenings. The meetings are currently held at the SES building. They operate 2 metre and 70 cm repeaters from two locations in the region. They have a field day over the long weekend in June.

Jeff VK2BYY recently wrote a science fiction novel - "Barefoot Times", which has done well. Jeff has been back on the keyboard and in a few weeks time will have his second novel released.

73 - Tim VK2ZTM.

## 2006 Urunga Radio Convention Inc.

It is that time of year again where we are getting organized for the 2006 **Urunga Radio Convention over the Easter Weekend 15-16 April**

The 2005 convention went off well with some new "foxes" being tried, apart from a few teething problems all went well, Domenic VK2YDD and Pat VK2BPH proved they were up to the job of being cunning and devious hiding the foxes, while Brian VK2BI was kept busy with the "kids" events, which as usual went without a hitch,

The hall was agog with the usual trading of pre-loved gear, the kitchen and lounge area were popular and well patronized, Thanks to the ladies for their hard work, the quizzes and competitions were also popular, The dinner on Saturday night was well attended.

Thanks again to Bryan Ackerly VK2YNG for his donation of 80 m O Ring foxes and the informative talk on their use.

### Jack Gerard Memorial Award

Adam Scamell VK3YDF, 3 events

### Brian Slarke Memorial Award

Rodney Sommerville VK2URK, Overall 2 days

Ken Golden, VK2DGT

Sec. WIA Urunga Radio Convention Inc.

ph 02 6652 3177

(Check out Urunga Radio Convention web page)

see pictures of 2005 Convention inside back cover

### Results of the 2005 WIA Urunga Radio Convention Inc.

<b>Saturday</b>	
<b>80 MHz mobile</b>	Adam Scamell VK3YDF
<b>2 m Pedestrian</b>	1st. Rodney Sommerville VK2URK 2nd. Chris Williams VK2YMW
<b>2 m Mobile</b>	1st. Rodney Sommerville VK2URK 2nd. Chris Williams VK2YMW
<b>Talk In Mobile</b>	1st Rodney Sommerville VK2URK 2nd. Adam Scamell VK2YDF
<b>Junior 80 MHz</b>	1st. Stefan Winkler 2nd. Kelly OBrien
<b>Sunday</b>	
<b>Urunga Scramble</b>	1st. Grahame O'Brien VK2FA
<b>40 m Fun event</b>	1st. Chris Williams VK2YMW
<b>2 m Mobile</b>	1st. Adam Scamell 2nd. Rodney Sommerville VK2URK
<b>2 m Pedestrian</b>	1st. Chris Williams VK2YMW 2nd. Rodney Sommerville VK2URK
<b>Talk In 2 m Pedestrian</b>	1st Adam Scamell VK3YDF
<b>Junior 2 m</b>	1st. Stefan Winkler 2nd. Reece Austin

### Amateur Radio Victoria News

#### Special Event Callsigns

After six months of planning the time has arrived to activate the two special event callsigns AX3GAMES and AX3MCG to celebrate the Melbourne Commonwealth Games.

A roster of Amateur Radio Victoria members has been set up in the Members Only section of our website for AX3GAMES, allocating operating slots through the entire month of March. If you would like to fill any vacant slot please let the Vice President, Barry Robinson VK3JBR know immediately.

The other callsign AX3MCG (Melbourne Commonwealth Games) is being activated by David McAulay VK3EW (who ran our successful AX3OLY Olympic callsign in 2000) and Peter Forbes VK3QI who was the key operator for AX3ITU for the ITU's 140th birthday in May last year.

Commemorative QSL cards will be designed and issued for both AX3GAMES and AX3MCG.

If the popularity of the Manchester Commonwealth Games 2002 special event callsigns is any guide, the

Melbourne event callsigns will be popular.

The ACMA, when granting Amateur Radio Victoria the two special event callsigns, also announced that all radio amateurs may use the substitute prefix AX during the games period 1-31 March.

About 70 nations which represent a third of the world's population take part in this major sporting event.

#### Education Activity Expansion

As hinted in last month's column, Amateur Radio Victoria is stepping up its role of providing amateur licence education.

Building on the four Foundation Licence and Assessment Sessions that have been held since November last, the next obvious need was to make available training for the 2nd tier Standard Licence.

The concept of a Standard Licence Bridging Course was initially formed last year and required an enormous amount of work to develop and refine. The aim is to bridge the knowledge gap

for Foundation Licensees wanting to upgrade.

Our Instructor, Kevin Luxford VK3DAP, with the assistance of others worked through December, January and part of February to create a course that not only complies with the new Standard Licence syllabus, but can be delivered over four weeks.

The course began on 1 February with four candidates who attended at the Ashburton rooms weekly and then underwent further tuition during a combined training and assessment weekend session.

The outcomes of the course will be published in this column next month. It may be possible to run up to three bridging courses a year if there's sufficient demand.

After his 5th Foundation Licence training session helping 30 become new radio amateurs, Murray Lewis VK3EZM has taken leave due to a work commitment with Kevin VK3DAP taking up the weekend Foundation classes.

ar

### GippsTech2005 announcement

The Eastern Zone Amateur Radio Club (Inc) is pleased to announce GippsTech2006. This year the event will be held on Saturday July 8 and Sunday July 9. This event has a well-recognised reputation as the premier technical conference in VK considering techniques applicable in the VHF, UHF and microwave bands, especially for weak-signal contacts. In addition to the Conference, a Partners' Tour will be conducted, together with an informal social gathering for dinner on Friday and a Conference Dinner on Saturday.

Copies of the Conference Proceedings

volume from 2005 will be available for sale during this year's event. Previous years' Proceedings are available - see the web site for details.

#### Call for Papers

Amateurs (and others with material to contribute) are invited to submit titles and outlines for topics to be presented at GippsTech2006. Presentation slots can be brief (5 -10 minutes) through to 1 hour. Anything longer - you will need to justify!!

Presentations can be formal or informal, or display. We use a lecture

theatre for the formal (& semi-formal) presentations. Displays are open during coffee/tea breaks and after lunch. Potential presenters are welcome to contact me direct for further information or to suggest a topic.

The conference is held in Churchill, about 170km east of Melbourne.

Further details can be found at the Eastern Zone Amateur Radio Club web site at:

<http://www.qsl.net/vk3bez/>

ar

## VK7

Justin Giles-Clark VK7TW  
Email: vk7tw@wia.org.au  
Regional Web Site: reast.asn.au

### New VK7 records set

Congratulations to Rex, VK7MO for setting some new VK7 2m and 70cm distance records. Rex on New Year's Eve set a distance of 2432.6km on both 2m and 70cm between VK7 and ZL1 with Nick ZL1IU.

### 2005 VK7 callback stats

The VK7 Regional News Broadcast callback stats for 2005 have been compiled and overall we have a 13% increase in callbacks. Last year also saw a record 111 callbacks on 25 September.

### New north-south link

Joe, VK7JG and Brian, VK7RR have established a new 70cm link from Barren Tier to Mt Barrow. This receives on 146.700MHz, VK7RAD and retransmits on 439.950MHz. The link is on all the time and is linked into 147.000MHz, VK7RAA for the Sunday morning broadcast. Thanks to Joe and Brian for their work on this. This enables the broadcast feed from the South on VK7RAA via a reliable high quality 70cm FM link.

### Foundation Forum

Mitch, VK7FMCH informed me of a newly created web forum for Foundation Licensees he has established. It's called the Australian Foundation Licence Holders Forum and can be found on the forum pages on QRZ.com. It is designed to allow foundation licence holders within VK to discuss all forms of Amateur Radio.

### Tassie repeater map

Roger, VK7ARN has prepared a map of the Tasmanian amateur repeater network designed primarily for visiting amateurs. It provides repeater location, frequency, offset, access tone if needed and linking information. Echolink and IRLP links are also given. It's all on one page, in colour, and prints OK in black and white. Page is available from: [http://wicen.taswireless.net/SOPs/Rpt\\_Map.htm](http://wicen.taswireless.net/SOPs/Rpt_Map.htm)

### BPL interference watch

Bryan VK7KBE and yours truly have been undertaking emission measurements of BPL installations at both ends of the State. Some of these have been published on the VK7 BPL Watch Page. On a lighter note, Les, VK7LS has come up with a very good analogy of BPL. Les suggests it's the modern day version of the spark transmitter HIHI! A very apt description indeed, as most experiencing the interference level of BPL will agree! Keep writing those letters to the newspapers, politicians and the ACMA, we need to keep the pressure on.

### North West Tasmania Amateur Radio Interest Group

NWTARIG held its AGM on Feb 4, and the office bearers for 2006 are: President: Tony, VK7AX, Vice President: Ross, VK7WP, Secretary: Steve, VK7EQ, Treasurer: Shirley, VK7HSC, and Executive Officer: Winston, VK7EM.

Planning is well underway for the Marconi centenary celebrations, to mark the first radio transmission from Devonport to Queenscliff in July 1906. The date has been finalised for the weekend of 15-16 July 2006.

### Northern Tasmanian Amateur Radio Club

NTARC's AGM was held on Feb 8 with the following office bearers elected for 2006: President: Al, VK7AN, Vice President:

Kevin, VK7KVN, Secretary: David, VK7YUM and Treasurer: VK7KRR.

Don't forget the Satellite 2006 Conference & Tradeshow on March 2 - 4 at the Inveresk Tramshed Conference Centre, Launceston.

### Radio and Electronics Association of Southern Tasmania Inc.

A special mention of Gavin, VK7HGO, who is involved with the CB Emergency monitoring (TASVEC) group. Gavin took an emergency radio call from Mt Wellington where a climber had fallen. Through Gavin's quick action Police Search and Rescue were on the scene.

In January, Reg, VK7KK held another foundation licence course with 8 attendees who successfully passed. The course included 3 school students with 12 year old Sam now being the youngest VK7 foundation licensee. FL Manuals and Tutor CD's are available for purchase from McCann's Model World in Elizabeth.St. Thanks to Barry, VK7TBM, for this service. The VK7RAD-VK7RHT link is up and going and working a treat, thanks to Dave, VK7DM, and his band of repeater experimenters.

Feb 5 was REAST's AGM with 40 members attending. Office holders for 2006 are: President: Justin, VK7TW, Vice-President: Clayton, VK7ZCR, Secretary/Public Officer: Ben, VK7FBCS, Treasurer: Roger, VK7ARN, Committee Members: Rod, VK7TRF, and Brian, VK7HSB.



REAST's AGM - standing room only!

# AMSAT

Bill Magnusson VK3JT

## The AMSAT group in Australia

The National Co-ordinator of AMSAT-VK is Graham Ratcliff VK5AGR. No formal application is necessary for membership and no membership fees apply. Graham maintains an e-mail mailing list for breaking news and such things as software releases. Contact Graham if you wish to be placed on the mailing list.

## AMSAT-Australia Echolink Net.

The net meets formally on the second Sunday of each month. Anyone with an interest in Amateur Radio Satellites is welcome to join in and take part. Graham VK5AGR acts as net controller. The net starts at 0600UTC and you can join in by connecting to the AMSAT conference server.

All communication regarding AMSAT-Australia matters can be addressed to:

AMSAT-VK,  
9 Homer Rd,  
Clarence Park, SA. 5034

Graham's e-mail address is:  
vk5agr@amsat.org

## Suitsat Saga

The Suitsat project grabbed the public imagination and was afforded an unusually high degree of publicity via NASA and the media generally, as well as in amateur radio circles. Come the day it was disappointing to find that the voice, telemetry and SSTV signals from Suitsat were almost undetectable even by well equipped amateur radio stations. Suitsat could not be heard at all using simple scanners.

It was declared a failure in the media almost immediately but in the true spirit of amateur radio, lots of antenna gain and lots of sophistication and sensitivity were brought to bear on the problem.

Over a day or two reports which were at first quite disappointing were replaced with more optimistic ones. People were hearing the signal albeit weakly. Some were able to piece together bits of the voice messages and even some telemetry was being recorded here and there. The SSTV picture was more elusive but what had been an initially gloomy situation was taking on a new life.

It was obvious after only a day or so that this was going to be a real challenge. I had decided to give it my best shot early on and had spent some weeks making certain that all was in order here. The first pass over Milawa was not until some six and a half hours after deployment. The whole episode was broadcast live by NASA on TV and the www and when the empty spacesuit was finally pushed gently away from ISS it looked like the project was going to go on to a successful conclusion with people all over the world being able to receive the signals on very simple scanning receivers. Hams were looking forward to recording the telemetry and decoding the SSTV picture, even if they didn't have Oscar capability.

Unfortunately something went amiss. When the pass was due over Milawa I had my gear all ready. The tracking antennas had recently been down for overhaul. The pre-amp had been re-installed after the EME attempt last year. The co-ax was all checked out. The auto-track and auto-Doppler system was working perfectly. Fresh keys installed that morning. I even had the MMSSTV program running on

my laptop computer. Maximum strength S-9+60 dB signals had been received from the ISS packet system during the trial period.

Sadly very little was heard from Suitsat on the first pass. Certainly nothing intelligible. Maybe a very slight rise in the noise level indicating something not quite breaking the squelch occasionally and the slightest hint of a voice. The AMSAT-BB exploded with hundreds of reports, mostly coinciding with my own experience. One or two came from people who had EME capable arrays and several of these were pressed into service. You would think they'd make the job easy but EME arrays are designed to track one very slowly moving object, the moon. They have great difficulty in tracking a fast moving object like Suitsat.

Despite this problem one or two managed to follow it long enough and signals were strong but getting continuous usable data proved difficult for them too due to "deep fades".

All in all it didn't auger well. Since there was no string attached to Suitsat when it was launched, the only way out seemed to be to configure the transceiver on ISS as a cross band repeater to receive Suitsat's 2 m signal and re-broadcast it on 70 cm. Presumably the 2 m signal would be quite strong at the ISS receiver, at least for a couple of days. The astronauts were asked to check out this possibility.

Reports came in that the cross band repeater was configured on Sunday 5th February. Someone had obviously been able to pull some strings at NASA. After all, with all the publicity, they had a stake in this experiment too.

In the meantime my friend Heinz VK3BEW had been doing some work with the Spectran program to display Suitsat's FM carrier. Spectran is capable of digging very weak signals out of the noise level and is often used in conjunction with the WSJT moon bounce and weak signal software. Initial tests were surprising. Even on his first try the display showed strong traces plotting out the classic Doppler shift curve. There was no mistaking it. Suitsat

## KVK Antenna Systems

### The VK Antenna Handbook for Restricted Spaces

Packed with information on restricted space design

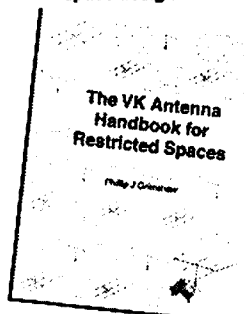

Also available in CD pdf format (less 20%) for quick searches. Check web site for info, pricing and ordering.

For direct purchases  
[www.grimshaw.net.au](http://www.grimshaw.net.au)  
For credit card purchases:  
[www.kvkantennas.com.au](http://www.kvkantennas.com.au)  
or ph 07-3216 8060 or  
fx 07-3216 8075



was easily detectable even on a simple ground plane antenna without a pre-amp. I tried it too and, using my tracking antennas, Spectran was displaying the carrier tens of dB above its noise floor with the 2 m receiver in SSB mode. You could plainly see the FM sidebands on the waterfall display yet switching to FM resulted in only the occasional word or two being copied. Even in its weakened condition Suitsat would have been 100% readable if it had used SSB rather than FM modulation.

We eagerly awaited the first Monday afternoon pass. The 70 cm ISS frequency was silent. The same thing was observed on subsequent passes on the Monday afternoon and evening. There were no reception reports of the 70 cm signal on the BB but the ISS fan-club site contained reports from several operators who had received bursts of 1200 baud packet on 70 cm. These obviously were coming from automated packet stations on 145.990 MHz.

Despite many appeals being made in the run-up to the Suitsat experiment for owners of automated packet stations to

turn off their TNCs, these appeals had gone unnoticed or been ignored.

On the third pass of the day I began to hear strong bursts of 1200 baud packet on 70 cm. The repeater was at least working. The strong packet bursts were triggering the repeater on and off. At the same time I was receiving the 145.99 MHz signal from Suitsat yet that signal was not being repeated. That could mean only one thing. The signal from Suitsat to ISS was simply not strong enough to open the squelch so the repeater wasn't repeating anything except the packets. It looked like Suitsat had drifted too far away from ISS for strong signals to be picked up. It was leading ISS by about 200 km on the morning of 6 February but still in range of ISS. Its height had not dropped significantly below ISS. The cross band repeater had offered a reprieve and the possibility of strong signals from Suitsat but sadly that wasn't going to happen.

Looking back it was a very enjoyable learning exercise even though hard results were thin on the ground. It would have been nice to receive the SSTV picture. It would have been nice to

hear the voices of the children loud and clear and of course the telemetry would have told us a lot more about what was happening on Suitsat. By the time you read this Suitsat-1 will have re-entered the atmosphere and burned up. But as Bill McArthur said, "There are plenty more redundant suits up here" so I feel sure we can look forward to more Suitsat experiments from ISS and the lessons learned from this one will certainly be applied in future.

*continued next page*

www.pca.cc  
 Email to: [marc@pca.cc](mailto:marc@pca.cc)  
 via Winlink  
 2000  
**Use FACTOR-3**  
 on HF to send  
 Mail, Grib Weather,  
 Weatherfax & Images  
 Contact [marc@pca.cc](mailto:marc@pca.cc)  
 Sydney 02 8902 0107

# Australian Radio Industries Pty. Ltd.

The RF Specialists

Formally VK Discount Cables  
 We service Industrial, Commercial, Amateur & CB Radio Applications

## Specialists In

- Rg Series Coax
- Ultraflexible Coax
- Hellax Corrugated Hardlines
- Waveguides & Semi-rigid
- Hi-temp Teflon Coax
- 450 & 300 Ohm Twinfeeders
- Multi-core Control Cables
- All Coax / Hardline Connectors
- Hard & Soft Drawn, Copper Wires
- Enamelled Copper Wires
- Coax Sealing Products
- Installation Accessories & Equipment
- Ceramic And Pvc Insulators
- Flat Earth Braids
- Dacron Uv Ropes
- Mobile & Fixed Antennas - Cb & Amateur
- Dipole & Wire Antennas
- Lightning Protection & Earthing
- Cable Assemblies

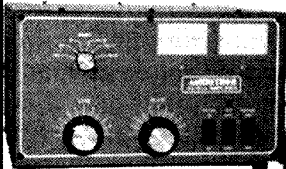

All Prices  
**INCLUDE GST**

ACN: 117 379 218



WEB  
 SITE  
 ON THE  
 WAY

### Hi Grade Coax Cables

- RG-213 MIL-C-17D - \$160.00 per 100m
  - RG-58CU MIL-C-17D - \$55.00 per 100m
  - TIMES LMR240 - \$3.40/m
  - TIMES LMR400 - \$4.20/m
  - TIMES LMR600 - \$9.95/m
  - 1/2 inch HELIAX - \$4.95/m
  - 7/8 inch HELIAX - \$9.95/m
  - 300 ohm HD Ladderline - \$1.40/m
  - 450 ohm Ladderline from - \$2.00/m
- (All cables in 100m, 500m or 1000m qty)
- Hi quality Patch Leads from - \$4.95ea
  - 20m x RG213 terminated - \$55
  - 50m x RG213 terminated - \$120
  - 20m x LMR400 terminated - \$130
  - Hi Power Baiuns from - \$50
  - 477Mhz 12dB Fibreglass - \$245

### Australia's largest MFJ Dealer

- MFJ-989D 1.5Kw Roller HD - \$649 \*NEW\*
- MFJ-986 1.5Kw Roller - \$599
- MFJ-962D 1.5Kw Roller - \$449
- MFJ-993B 300w Auto - \$479
- MFJ-994B 600w Auto - \$649
- MFJ-929B 200w Auto - \$449 \*NEW\*
- MFJ-949E 300w - \$269
- MFJ-969 300w Deluxe - \$369
- MFJ-945E 300w HF+6 - \$199
- MFJ-904H Tiny Tuner - \$269
- MFJ-267 1.5Kw Deluxe Dummy - \$289
- MFJ-250 1.5Kw Wet Dummy - \$109
- MFJ-264 1.5KwHF/VHF/UHF Dummy - \$139
- MFJ-260C 300w HF/VHF/UHF Dummy - \$78
- MFJ-269PRO 1.8-570Mhz - \$749
- MFJ-269 1.8-470Mhz - \$599
- MFJ-259B HF/VHF - \$429
- MFJ-4229 25A P/S - \$299
- MFJ-4245 45A P/S - \$369
- MFJ-655 Audio Enhancer - \$369 \*NEW\*

### Heil Microphones & Accessories

- PROSET HC4 / HC5 - \$269
- PROSET IC - \$279
- PROSET PLUS IC - \$339
- PROSET PLUS - \$369
- GOLDLINE GM4 & GM5 - \$269
- HM10 DUAL - \$249
- HM10/5 - \$169
- HM10/4 - \$169
- FS2 PTT FOOTSWITCH - \$85
- HS2 PTT HANDSWITCH - \$65
- TRAVELLER-ICOM - \$169
- TRAVELLER-KENWOOD - \$169
- TRAVELLER-YAESU - \$169

### DAIWA SWR/Power Meters

- DAIWA HF/VHF CN101L - \$199
- DAIWA VHF/UHF CN103L - \$199
- DAIWA HF/VHF CN801H - \$279
- DAIWA VHF/UHF CN801V - \$299

SUPPLIERS, IMPORTERS,  
 & MANUFACTURERS

*Make us your last call, as we  
 will be your first choice on  
 Quality,  
 Service,  
 Technical Advice  
 and the best possible  
 Price!*

Visit our  
 Website for full details of our  
 products and service

**PAY—MASTERCARD, VISA, BANKCARD**  
 Disclaimer: Prices subject to change without  
 notice.

EMAIL  
[sales@arindustries.com.au](mailto:sales@arindustries.com.au)

Trading Hrs: Mon - Fri 8am - 530pm, Sat - 8am - 12 noon  
 Office: (02) 48 622110 BH MOBILE: 0416 099 190

WEBSITE  
[www.arindustries.com.au](http://www.arindustries.com.au)

## Latest news on KiwiSat.

The latest update from KiwiSAT Project Leader Fred Kennedy, ZL1BYP, has been well received. 2005 has seen concentrated efforts in 3 areas, the U/V Linear Transponder, the Integrated Housekeeping Unit (IHU) and the Attitude Determination and Control (ADAC) system. Fred's report is available by visiting the AMSAT-ZL web site.

It features many excellent pictures of the equipment at present under construction, under test or completed. Everyone associated with the project is to be congratulated on the obvious progress so far. This report is definitely worth reading.

## Bill McArthur KC5ACR on the ISS

Bill McArthur has provided ISS fans with great opportunities to work ISS on the amateur radio bands. He is a very enthusiastic amateur radio operator. The ISS Fan Club maintains a web site at <http://www.issfanclub.com/> and this is the most current source of information if you are interested in contacting Bill or working the various packet configurations on ISS.

## AO-7 enters a no-eclipse period

Now is the opportunity to work some satellite DX and sharpen up your SSB transponder skills for P3E. AO-7 is performing very well and some astounding contacts are being made via this, the oldest operating amateur radio satellite. The regression of the orbit continues and AO-7 is now orbiting

more or less along the grey-line and it should remain in permanent sunlight for some months. That in turn means that it can be expected to switch regularly from mode-A to mode-B each day at approximately 0900 UTC. The 24 hour timer seems to be working reliably. AO-7 is definitely a QRP satellite. Start by using minimum uplink power and try an omni-directional antenna or a simple 3 or 4 element Yagi. When AO-7 was first launched back in 1974 the usual mode-A station configuration was 10 W into a ground plane for uplink and a full-wave loop for downlink on 29 MHz. My loop was indoors, strung around the picture rails and door tops. The copper wire ground plane was built around an SO-239 co-ax socket and attached with cord to a chimney top. Orbiting at a height of 1450 km, the footprint of AO-7 is huge. It covers all of Australia and New Zealand and the islands to our north at the same time. AO-7 is a great old timer and it's always a pleasure to hear the voice come back through circuits which in satellite technology terms are almost ancient.

## Proposed new launches for 2006

2006 looks like being a bumper year for amateur radio satellite launches. No fewer than 15 new satellites are listed as being under development and having proposed launch dates this year. A number of cubesats are listed for a multiple launch in mid-May. With the excitement of the Suitsat project and the approaching launch of Phase3E, 2006 is shaping up as a year to be remembered.

## New Release of SatPC32

Do you use an FT-847 trx for satellite work? They were and are a very popular rig here in VK. Or maybe you have one of the new 450 degree rotators.

Erich Eichmann DK1TB has released SatPC32 version 12.4a. The earlier versions of this software have been well received by many operators. The changes in this version are of interest mainly to users of the Yaesu FT-847 transceiver or the newer models of the G-5500 rotator. Many newer rotators have 450 degree rotation to allow interruption-free tracking of the satellite passes which "cross the stop" during their pass over your QTH.

A lot of people have problems running their co-ax to allow auto-flip so SatPC32's ability to cope with the full 450 degrees rotation of the newer rotators will please many operators.

Larger 3D maps are also available for the new version. The program now includes support for the Yaesu FT-847 when used with in-band satellite repeaters like that on ISS. The number of selectable com ports is increased.

The demo version is fully functional except that the user must enter latitude and longitude every time the program is started. It can be made fully functional by purchasing a registration code from AMSAT-NA, AMSAT-UK, or AMSAT-DL. Why register? Erick has donated this software as a fundraiser for AMSAT so your registration will help future satellite building. The demo version can be downloaded from the author's web site at:

<http://www.dk1tb.de/indexeng.htm>

ar

## Awards

Malcolm K. Johnson VK6LC

WIA Awards Manager.

### Formal Awards title change from "RTTY" to "Digital"

The WIA Awards program has officially updated all of its awards to reflect "Digital" where it represents an "Award Title" or a "Group Title" only.

We have made this change keeping pace with the expanding world of Digital Data Communications.

At present Digital does not fit in all cases to the "RTTY" title category.

Certificates will be titled "Digital" and endorsed with the appropriate awarded "Data Mode". Digital will represent all data transmitted modes for our awards and details are below:

### Award Modes

#### Open

(combined Phone, CW & Digital)

#### Digital

RTTY (BAUDOT, ASCII, AMTOR, PACKET, PACKTOR, FSK, PSK, BPSK, MFSK, MT, AFSK, etc) including Digital (narrow band FSK).

ar

## The Foundation Licence explosion

As most amateurs will have realised by now, the introduction of the Foundation Licence into our world has created a large number of new licensees to appear on the scene and on the air. Isn't it great?

As far as ALARA is concerned we are delighted that in almost every Foundation Licence class there are one or two (or even more) YL applicants. What is more they are beginning to appear on the air waves already.

The Monday night Net on 3.5800 +/- has had the first YL F-call join in the chat. On Monday 23rd January Lia, VK3FLIA called in and was welcomed by us all. Lia has an OM who has had a licence for some time, but was delighted to tell us that her daughter and grandson also sat for and passed their Foundation Licence exam at the same time as she did, in Bendigo. Well done to them all. I hope they enjoy amateur radio as much as we have done over the years.

## ALARA's special Foundation licensees

ALARA's first President, Norma, now VK2YL, is proud to report that her THREE daughters, Christine, Michelle and Lorraine all sat and passed the Foundation exam held in January (at a Pizzeria) in Baulkam Hills. That makes five amateurs in their family, Norma's mother-in-law Bobbie VK2PXS and her OM, Frank VK2AKJ are also amateurs.



Norma VK2YL's daughters with Dot VK2DB's son Peter at their Foundation Licence exam.

## State reps please take note

With so many new amateurs appearing everywhere, we are asking our State Reps to keep an ear on happenings so we can invite all the new YL amateurs to join ALARA. I am sure they will find the comradeship of the 'oldies' encouraging for the 'newies'.

New amateurs can feel isolated once the first thrill has worn off, as we know so let us all help to welcome all the new voices,

Please note, YLs, you do not have to be a member of ALARA to join in the Monday night Nets. In fact we welcome OMs to join in, as well. We just ask that you wait for the first round or so to finish before you join us. You will find out where we all live and hear something about our activities as we go round. We all save stories of the most interesting things to happen to us during the week, to share with each other. I understand we have quite a number of eaves-droppers who enjoy our stories each week, already.

To add pleasure to the story, Peter, son of the ALARA editor, Dot VK2DB, and her OM John, VK2ZOI, was in the same class and also passed. Peter was planning to apply for the callsign VK2FOOL, very appropriate, according to Dot.

Our congratulations to these ALARA family members, in particular.

We also welcome into the ALARA family several other new F-calls. In December, the youngest F licensee, at that time, Janice VK3FIRE, became a member of ALARA as soon as she passed her test. Janice is 9 years old. Janice featured in the January/February issue of AR magazine. For Christmas presents, she gave three of her uncles copies of the Foundation Licence Manual. Warning!

## The Morsecodians at Tarnworth

The Morsecodians have been mentioned several times previously in this column, so it was interesting to hear that they were at the Tarnworth Country Music Festival this year.

To add interest to the story, it appears that they were running a program that allowed them to accept messages from the public, to send the messages by Morse Code and to have the messages translated into SMS messages that could be received on a mobile phone.

Someone has combined an old technology with a new one in a very innovative way. Never say there is nothing new in amateur radio.

Well done, Morsecodians!!

## The International YL Meet in Mumbai

A message from Sarla VU2SWS tells us that between 55 and 60 YLs will be attending the MEET later this year. We wish them all great weather and good company. The planned program sounds most interesting with a chance to see something of Mumbai and time for eyeballs as well.

Sarla also tells us she has gained her DXCC. That takes a lot of time and effort. Our congratulations to Sarla.

## YL contests coming up soon

The CLARA and Family HF Contest will be on 18 and 19 March. It commences at 1700Z and runs for the 24 hours on all the HF bands. You may use CW or Phone and OMs as well as YLs are welcome.

On the 1 and 2 April from 0800Z to 1000Z on the Saturday and the Sunday the Thelma Souper Contest will be run by the WARO, (ZL YLs) on 80 metres only but using both CW and Phone.

In both contests there will be extra points for contacting a YL and in the WARO Contest there will again be a bonus station operating at different times and on different bands.

Like the ALARA Contest, these contests are laid back, with time for a chat as well as an exchange of numbers. Please join in, you are all welcome.

# Beyond our shores

David A. Pilley VK2AYD  
vk2ayd@wia.org.au

**There is very little happening on the international scene. The HF bands have been 'dead' most days so I thought perhaps a look at some of the digital systems may be appropriate.**

## Digital

An article in an ARNewsline reported that Sony Europe has announced it is to cease selling analogue-only television sets, and sell only integrated digital televisions. These sets include both analogue and digital terrestrial television tuners. As Australia uses the same PAL system I wonder how long it will be before this has an effect here. Latest news says the USA has passed a law effective from 31 Dec 2008 that all TV broadcasters will switch to all-digital mode. It was also voted to put aside \$US830 million to help those with analog TVs to convert. We hope our government will make a similar provision when the time comes.

After nearly 60 years as a radio amateur I still get a big kick out of trying out new communications technologies. Back in the 50s when we were building phasing and crystal lattice SSB rigs, everyone said 'Donald Duck' will never take off! Having tried most digital keyboard communications on the HF bands (fascinated with PSK31 – try it!), I was recently taken with a new digital voice unit advertised.

Using digital technology to transfer pictures is great on HF. You have hand-shaking with the receiving station and, with a little patience, you eventually have a perfect picture. However, there is no hand-shaking with digital voice. It's a one way system. It works excellently when the signal is S-9+, but as soon as the signal drops and QRM/QRN/QSB joins in, there's a problem. Digital voice technology appears to work well in VHF and above where signals are S-9, but there is still a lot to be learnt on HF.

Talking of VHF and above, the latest from the ARRL is a system called 'D-Star'. In the USA repeater sites are being established on 1.2 GHz. Commercial equipment supplied by Icom is capable of up to 128kbps. (I thought some

computer wireless communications had this capability years ago). How this will progress amateur radio communications is going to be interesting.

In Tempe Arizona they have decided not to use BPL but to blanket the entire city with Wi-Fi for its 160,000 residents. They say this will mean approximately 400 antennas for the system. Relay boxes will be mounted on light poles throughout the city to stitch together the network. Imagine the reaction from certain shire councils here who are objecting to simple vertical antennas.

## VoIP and RCoIP

As technology advances VoIP is becoming very popular around the world. At last it has given those restricted with little possibility of using HF, to contact other amateurs around the world. In February "QST" there was an interesting article by Carl Ferguson, W4UOA, on Remote Control over the Internet. An interesting concept for those wanting to run their home station from a hotel room or vacation cottage! It uses a program called "TRX Manager" in association with "NetMeeting" or "Skype".

Where will technology take us next? Let us hope that authorities do not forget that it is the amateur that is often the forerunner of new technologies, and he needs to be given some freedom to develop ideas.

A new group in the UK has appeared promoting IRLP (Internet Radio Linking Project). This was originally pioneered by Dave Cameron VE7LTD, to link amateur radio repeater systems and radio gateway nodes together. It is a little different from most systems as the only means of access is by radio linking.

## Bandwidth

The ARRL recently presented a petition to the FCC to segment the amateur bands by emission bandwidth rather than mode. The petition pointed out that the current licence is a remnant of times gone by when only Morse telegraphy, single sideband, double sideband and amplitude modulation were in fashion. The petition is needed to bring amateur radio into the new millennium,

especially with the advancement of digital technology. It was interesting to read in RSGB Band Plan the January *RadCom* was already referring to bandwidth and not mode; for example, Telegraphy had a maximum bandwidth of 200 Hz on HF and All Modes shown as 2700 Hz.

## Ultra Wide Band

### UK concerned about UWB impact on ham radio

This is a wireless version of the USB technology used to connect devices such as mice and keyboards to computers.

UWB is unlike other radio technologies in that it generates short pulses made up of lots of frequencies, rather than modulating a signal on a particular carrier frequency. Known as carrier-free radio, it allows massive amounts of information to be transferred quickly. However, there are serious concerns the technology could threaten the amateur microwave bands, especially if used outdoors as an alternative to wireless network technologies like Wi-Fi.

In the response, the RSGB and its partners wrote: *We recognize that UWB short-range links will have a useful role and observe that UWB vendors are exerting considerable pressure for UWB's adoption. We stress that UWB must fully comply with the International Radio Regulations and that all such devices must operate on a non-protected, non-interference basis.*

The RSGB and its partners are therefore calling for the technology to include masking to protect the amateur bands. *In order to protect our services (notably in the 3.40-3.41 GHz band) we urge the adoption of the mask proposals without due concession to UWB proponents,* they wrote in their response.

(ARNewsline)

## 500 kHz

The Maritime Radio Historical Society (USA) is seeking to have the 500 kHz band designated as an international memorial frequency. The idea is that museums and historical initiatives would be issued with coast station licences specifically for this band.

ar

John VK400,

P.O. Box 7665, Toowoomba Mail Centre, QLD 4352.

Email: john.bazley@bigpond.com

On 27th January as I write this, I and other VKs, have been trying to work the CEOZ. It has been hard to hear him let alone work him. Let's hope the signals from 3Y will be better!

We will see more amateur activity from Andaman and Nicobar Islands in April, thanks to NIAR.

Amateur radio organisations, DX forums, and individuals lobbied NIAR for a suitable event to highlight the benefits of amateur radio technologies for social and scientific development.

NIAR then proposed to the Government of India that an International Convention of Amateur Radio Operators, "HAMFEST (VU4) INDIA-2006", be held at Port Blair, Andaman and Nicobar Islands April 18-20, 2006. So we can expect some operating from there in April.

Australia's Macquarie Island (VK0/M) may soon be 'basically vacated'. That is indeed bad news. After mid 2007 only a small core of meteorologists will staff the outpost. The good news is Australia's Antarctic Division will then concentrate major sub-Antarctic research on Heard Island (VK0/H). Macquarie Island has from 20 to 40 scientists each season. "Macca" has been the main scientific base for Antarctic scientists for over 50 years. "Our work on climate change is much better served by our work on Heard Island", says Professor Michael Stoddart, an Antarctic Division chief scientist.

The ARRL LOTW web site, was down for 3 1/2 days for maintenance towards the end of January, and now supports the Worked All States (WAS) award.

The DXCC award has been supported for a year, but WAS has been "work in progress" until January. You may now apply for a "WAS account" and have your existing QSOs credited to it based on rules you specify. No WAS certificates or award credits on the LOTW site yet but you can see which of your QSOs qualify. WO5I, David Black, notes the ARRL has not yet announced this available feature change on the main League web page. KE3Z says, on the LOTW web page, though, *January 16, 2006: Preliminary WAS support added. The first stage of LOTW upgrades to support the ARRL Worked All States (WAS) award has been completed. Under the Awards menu,*

*you can add one or more WAS account to select credits for the WAS award. Applications for WAS via LOTW, are not presently being accepted, but this feature is expected to be available by the end of February.*

**DXCC news:** D2DX from Angola (current operation as of 15 December 2004) and KH9/W0CN from Wake Island (17-28 September 2005) have been approved for DXCC credit.

So what have we got to look forward to in the coming weeks?

**VP2V/G6AY** will be on from the British Virgin Islands February 23-March 1. Ops G3RTE, Jim, and G3SWH, Phil, will concentrate on CW, 80-10 m, with some SSB and possibly some 160 m CW. With two 100-watt stations they will be on the air as much as possible. QSL via G3SWH with a stamped SAE, via email or the bureau for a bureau card in return.

**FT - Gildas TU5KG** is back to the Southern Indian Ocean on a fishing boat. Between 15 January and 3 February he will be sailing in the Kerguelen area, then in the Crozet area until early March, and back to Kerguelen until the end of March. When on land, he expects to operate as FT5XP from Kerguelen and as (probably) FT5WK from Crozet.

The **T30DX operation** has been cancelled, because the OH Pacific DX Team (<http://www.ohpacificdx.com>) has not been successful in securing flights to and from Western Kiribati. "However, the effort put in by the team and all of you supporting us will not be wasted", they say. *We are already preparing a fresh new start to get back to Pacific before Christmas 2006.* Details will be announced in due course.

Do not waste time on **5T5T** (spotted on 20 and 40 metres CW, 20m RTTY). Maurice, F5NQL reports that the QSL manager's callsign (F5DIF) has not been issued to anyone, while Jean 5T0JL says that the only two other operators licensed are Feng Wang 5T0WF (ON6WFO, in Mauritania until 15 January) and Nicolas/5T5SN (plus 5T5BN, Bernard, pending). Another licence will soon be issued to Fernando, EA1BT.

**Visalia 2006.** The Southern California DX Club (<http://www.scdxc.org/>) sponsors the 57th annual International

DX Convention to be held at the Holiday Inn Hotel & Conference Centre, Visalia on 21-23 April. Information at <http://www.dxconvention.org/>

**F5NRY**, Christian Quintin, is currently on a 2-3 year work assignment in the Central African Republic and QRV as TL8QC. Look for activity on 15, 17, 20 and 40 metres on CW only. QSL via his home call F5NRY. QRX for exact address as there are at least three different addresses out there.

**F4BQO**, Claude, is active as TR8FC from Libreville, Gabon now until May 2006. Look for activity on 14190 on SSB starting around 1800Z. Also watch 21020 and 24900 on CW. If you want a sked email him at [b4bqo@orange.fr](mailto:b4bqo@orange.fr). QSL via F4BQO, either direct to Claude Franck, 56 rue de la Treille, 95490 Vaureal, FRANCE or via the bureau.

**K3LA**, Barney, is in Khartoum, Sudan with a licence to operate as ST2LA. He took a brand new Icom IC7000 with him and will be on the air from locations with installed antennas. QSL via K3LA.

**OE3JAG**, Karl, reports to *The Daily DX* he will be QRV from the Madeira Islands (AF-014) as CT3/OE3JAG from 15 to 22 May. Plans are to run QRP with a dipole or long wire, mainly on CW, PSK and RTTY on 20 and 30 metres. QSL via OE3JAG. See info at <http://www.qrz.com> and <http://www.oe3jag.com>.

**TY- Ronald/PA3EWP, Andrea/IK1PMR, Claudia/K2LEO and Tom/GM4FDM**, all of T33C fame, will operate from Benin on 15-20 March. Requested calls are TY5WP, TY1MR, TY2LEO and TY4TW respectively. They hope to be active on 160-10 metres all modes, with 100 watts and maybe a linear using verticals and wires from a near beach location. Expect some activity during the BARTG RTTY Contest and maybe the WPX SSB Contest. QSL TY1MR and TY2LEO via IK1PMR, TY5WP via PA7FM and TY4TW via GM4FDM.

Thanks to *The Daily DX* (W3UR) and *425 Dx News* (I1JQJ) and *QTC DX PY2AA* for information appearing in this month's *DX News & Views*.

You can obtain from W3UR a free two week trial from [www.dailydx.com/order.htm](http://www.dailydx.com/order.htm)

ar

# Gridsquare Standings at 3 February 2006

Guy VK2KU

## 1442 MHz Terrestrial

VK2FLR	Mike	113
VK3NX	Charlie	104
VK2KU	Guy	102
VK3KAI	Peter	81
VK2ZAB	Gordon	78 SSB
VK2KU	Guy	69 SSB
VK3CY	Des	68
VK3PY	Chas	68 SSB
VK3HZ	David	65
VK2DVZ	Ross	63 SSB
VK2TK	John	62
VK3EK	Rob	62 SSB
VK3QM	Oavid	56 SSB
VK2EI	Neil	54
VK3TMP	Max	53
VK7MO	Rex	53
VK3BJM	Barry	52 SSB
VK3ZLS	Les	51 SSB
VK3BDL	Mike	50
VK3KAI	Peter	48 SSB
VK2DXE	Alan	47
VK2KU	Guy	47 Digi
VK3WRE	Ralph	46 SSB
VK4TZL	Glenn	45
VK2DXE	Alan	43 SSB
VK3CAT	Tony	40
VK3KEG	Trevor	39
VK3KAI	Peter	36 Digi
VK2TK	John	35 SSB
VK4KZR	Rod	35
VK7MO	Rex	35 Digi
VK3ZUX	Denis	33 SSB
VK6HK	Don	33
VK7MO	Rex	33 SSB
VK3ZYC	Jim	31
VK4CDI	Phil	29
VK2KRR	Leigh	28 FM
VK3KME	Chris	28 SSB
VK4CDI	Phil	28 SSB
VK2TK	John	27 Digi
VK2EAH	Andy	26
VK4DFE	Chris	26 SSB
VK5ACY	Bill	26 SSB
VK2TG	Bob	25 SSB
VK3BBB	Brian	25
ZL3TY	Bob	24
VK3DMW	Ken	23
VK3YB	Phil	23
VK3HV	George	21 SSB
VK1WJ	Waldis	20
VK3TLW	Mark	20 SSB
VK6KZ	Wally	20
VK3AL	Alan	18 SSB
VK3BG	Ed	17 SSB
VK6KZ/p	Wally	16
VK1WJ	Waldis	15 Digi
VK2EAH	Andy	15 SSB
VK3ZYC	Jim	14 SSB
VK2CZ	David	12
VK7ZSJ	Steve	12
VK2EAH	Andy	11 Digi
VK2EI	Neil	11 Digi
VK3UDX	Geoff	11 SSB
VK2DXE/p	Alan	10
VK3ANP	David	10
VK6DXI	Mirek	6
VK6HK	Don	6 Digi
VK1WJ	Waldis	5 SSB
VK2TWO	Andrew	5
VK3ZDR	David	5 SSB
VK2AKR	Neil	3 Digi
VK2DXE	Alan	3 Digi
VK4TJ	John	3 SSB
VK1WJ	Waldis	2 CW
VK2AKR	Neil	1 SSB
VK3QM	David	1 Digi
VK4CDI	Phil	1 Oigi

## 144 MHz EME

ZL3TY	Bob	190
VK2KU	Guy	189
VK2KU	Guy	171 Digi

VK7MO	Rex	153 Digi
VK2FLR	Mike	114
VK3CY	Des	70
VK2KU	Guy	39 CW
VK2KRR	Leigh	30
VK4CDI	Phil	16
VK3HZ	David	14
VK3KEG	Trevor	4
VK3NX	Charlie	4
VK2DVZ	Ross	2
VK2DXE	Alan	2

## 432 MHz Terrestrial

VK2ZAB	Gordon	57 SSB
VK3PY	Chas	50 SSB
VK3NX	Charlie	47
VK3QM	David	47 SSB
VK3ZLS	Les	40 SSB
VK2KU	Guy	38
VK2KU	Guy	34 SSB
VK3EK	Rob	34 SSB
VK3HZ	David	34
VK2DVZ	Ross	32 SSB
VK3BJM	Barry	32 SSB
VK3CY	Des	32
VK3KAI	Peter	29
VK3KAI	Peter	28 SSB
VK3BDL	Mike	27
VK3WRE	Ralph	26 SSB
VK3TMP	Max	25
VK3KEG	Trevor	21
VK2TK	John	18
VK7MO	Rex	18
VK2TK	John	17 SSB
VK3CAT	Tony	16
VK3ZUX	Denis	15 SSB
VK3BG	Ed	14 SSB
VK4KZR	Rod	14
VK3TLW	Mark	13 SSB
VK4TZL	Glenn	13
VK6KZ	Wally	13
VK2KRR	Leigh	11 FM
VK3AL	Alan	10 SSB
VK3ANP	David	10
VK3UDX	Geoff	10 SSB
VK3YB	Phil	10
VK2TG	Bob	9 SSB
VK3BBB	Brian	9
VK4DFE	Chris	9 SSB
VK3KME	Chris	8 SSB
VK4CDI	Phil	8
VK6KZ/p	Wally	8
VK2FLR	Mike	6
VK6DXI	Mirek	6
VK7MO	Rex	6 Digi
VK2KU	Guy	5 Digi
VK3HV	George	5 SSB
VK3KAI	Peter	4 Digi
VK3PY	Chas	4 Digi
VK3QM	David	4 Digi
VK3ZYC	Jim	4 SSB
VK1WJ	Waldis	3 SSB
VK2CZ	David	3
VK2TWO	Andrew	3
VK2DXE/p	Alan	2
VK3DMW	Ken	2
VK4TJ	John	2 SSB
VK2AKR	Neil	1 SSB
VK2TK	John	1 Digi

## 432 MHz EME

VK4KAZ	Allan	14 CW
VK7MO	Rex	6
VK3NX	Charlie	5
VK7MO	Rex	5 Digi
VK3HZ	David	3
VK2KRR	Leigh	1

## 1296 MHz

VK3QM	David	35 SSB
VK3PY	Chas	34 SSB
VK3NX	Charlie	32
VK2ZAB	Gordon	29 SSB
VK3ZLS	Les	26 SSB

VK2KU	Guy	25
VK2KU	Guy	22 SSB
VK3EK	Rob	20 SSB
VK3KAI	Peter	20
VK3KAI	Peter	19 SSB
VK3KWA	John	19
VK2DVZ	Ross	17 SSB
VK3WRE	Ralph	16 SSB
VK3BDL	Mike	12
VK3BJM	Barry	12 SSB
VK3HZ	David	11
VK3TMP	Max	11
VK2TK	John	10 SSB
VK4KZR	Rod	10
VK7MO	Rex	10
VK3BG	Ed	6 SSB
VK3TLW	Mark	8 SSB
VK3AL	Alan	7 SSB
VK4TZL	Glenn	6
VK2CZ	David	5
VK3HV	George	5 SSB
VK3UDX	Geoff	5 SSB
VK3ZUX	Denis	5 SSB
VK3ZYC	Jim	5
VK6KZ/p	Wally	5
VK2KRR	Leigh	4
VK3BVP	Shane	4
VK3YB	Phil	4
VK3ZYC	Jim	4 SSB
VK6KZ	Wally	4
VK2KU	Guy	3 Digi
VK3BBB	Brian	3
VK3KEG	Trevor	3
VK6DXI	Mirek	3
VK2DXE/p	Alan	2
VK2FLR	Mike	2
VK3CY	Des	2
VK3KAI	Peter	2 Digi
VK3KME	Chris	2 SSB
VK3QM	David	2 Digi
VK4TJ	John	2 SSB
VK3DMW	Ken	1
VK3ZYC	Jim	1 Digi
VK7MO	Rex	1 Digi

## 1296 MHz EME

VK7MO	Rex	4 Digi
-------	-----	--------

## 2.4 GHz

VK3PY	Chas	12 SSB
VK3QM	David	12 SSB
VK3NX	Charlie	9
VK3WRE	Ralph	9 SSB
VK3KAI	Peter	7 SSB
VK3EK	Rob	5 SSB
VK3HV	George	4 SSB
VK6KZ	Wally	4
VK3BJM	Barry	3 SSB
VK3HZ	David	2
VK3KAI	Peter	2 Digi
VK4KZR	Rod	2
VK3BG	Ed	1 SSB
VK3TLW	Mark	1 SSB
VK3ZUX	Denis	1 SSB
VK4TZL	Glenn	1

## 3.4 GHz

VK3NX	Charlie	9
VK3KAI	Peter	6 SSB
VK3QM	David	6 SSB
VK3WRE	Ralph	6 SSB
VK3HV	George	4 SSB
VK6KZ	Wally	4
VK3EK	Rob	3 SSB

## 5.7 GHz

VK3NX	Charlie	11
VK3WRE	Ralph	9 SSB
VK3KAI	Peter	7 SSB
VK3QM	David	7 SSB
VK6KZ	Wally	4
VK3BJM	Barry	2 SSB
VK3EK	Rob	2
VK3HV	George	2 SSB

VK3KAI	Peter	2 Digi
VK6BHT	Neil	2 SSB
VK3ZUX	Denis	1 SSB

## 10GHz

VK3NX	Charlie	10
VK3QM	David	10 SSB
VK3KAI	Peter	9 SSB
VK6BHT	Neil	9 SSB
VK3WRE	Ralph	6 SSB
VK3PY	Chas	7 SSB
VK3EK	Rob	5 SSB
VK6KZ	Wally	5
VK3HV	George	4 SSB
VK3TLW	Mark	3 SSB
VK3ZYC	Jim	3 SSB
VK5ACY	Bill	3 SSB
VK2EI	Neil	2 SSB
VK3BJM	Barry	2 SSB
VK3DMW	Ken	2
VK3ZUX	Denis	2 SSB
VK7MO	Rex	2
VK3BG	Ed	1 SSB
VK3HZ	David	1
VK4KZR	Rod	1
VK4TZL	Glenn	1

## 24GHz

VK6BHT	Neil	3 SSB
VK2EI	Neil	2 SSB
VK3NX	Charlie	2
VK6KZ	Wally	2

## 474THz

VK7MO	Rex	1
-------	-----	---

Additions, updates and requests for the guidelines to Guy VK2KU, vk2ku@tsn.cc, or by mail (QTHR 2005).

The guidelines (and the latest League Table) are also available on the website of the NSW VHF Dx Group at [www.vhfdx.radiocorner.net](http://www.vhfdx.radiocorner.net) - click on Gridsquares.

Next update of this table will be in mid May 2006.

Stations who do not confirm their status for more than 12 months may be dropped from the table.

**NEW CONTEST**

# QRP Hours

## Saturday,

# 8 April

## Contest Calendar March – May 2006

March	4/5	ARRL Intl. DX Contest	(SSB)
	11/12	RSGB Commonwealth Contest	(CW)
	18/19	John Moyle Memorial Field Day	(CW/SSB/FM)
	18/19	Russian DX Contest	(CW/SSB)
	25/26	CQ WW DX Contest	(SSB)
April	1/2	Marconi Contest	(CW/SSB/RTTY)
	1/2	SP DX Contest	(CW/SSB)
	1/2	EA WW RTTY Contest	
	8	QRP Hours	(CW/PSK31/RTTY/SSB)
	8/9	Japan Intl. DX Contest	(CW)
	16	Holyland DX Contest	(CW/SSB)
	15	TARA Skirmish Digital Prefix Contest	(PSK)
	22	Harry Angel Sprint	(CW/SSB)
	22/23	SP DX RTTY Contest	
22/23	Helvetia Contest	(CW/SSB)	
May	6/7	CQ-M Intl. DX Contest	(CW/SSB/RTTY)
	13	VK/trans-Tasman 80 Metres Phone Contest	
	20/21	Baltic Contest	(CW/SSB)
	27/28	CQ WW WPX Contest	(CW)
	27	VK/trans-Tasman 80m CW Contest	

## Greetings to all Readers.

### Revised dates

In the December 2005 column I listed the dates of VK Contests for 2006. At the time I did not have certain dates available, so below I have amended the list. Please note a few changes, especially in the VK/trans-Tasman Contests dates, and some additions from the QRP Club. I know that 27th May date conflicts with one of the big international contests, but I am sure there will be plenty of room on 80 metres for our local event.

### John Moyle Memorial Field Day

This annual event in March is proving very popular, not only as a field day event, but with home stations as well. The rules were published last month, so I hope that you are all getting your stations ready. Please note the revision in 2 m and above scoring.

May I also remind you that Alan VK4SN has a logging program for this

contest. It is a good program, but be warned that it uses MS Access as found in Office XP. If this is a problem in the field, then entries may be made from rough sheets after the contest. Contact Alan via email on ax4sn@austarnet.com.au.

I urge everyone to become involved in this event, even the newcomers to our bands. Contesting is not difficult and need not be a "pressure" thing that can be associated with international contests. Please read the rules carefully and don't be afraid to seek help if you are still not sure of what to do.

### Something new

The term "QRP" conjures up various things to various people. For most of us it means a maximum output power of five (5) watts of carrier and it has tended to be used for CW mode. When you think about it, though, this definition fits any hand-held transceiver or transmitter where the power has been turned down.

The CW Operators' QRP Club has decided to try two QRP events in 2006

– to be called "QRP Hours". The Club hopes that all its Members will take part, but also invites all amateurs to join in.

The first of these will be on Saturday, 8th April, for just two hours, with each separate hour being devoted to different modes. If anyone wants to take part in both hours, please feel free to do so! The rules are below, so please add this date to your diary. This is a simple, basic contest where everyone can make contacts and benefit from the experience.

### Harry Angel

Finally, a reminder that the Harry Angel Sprint will again be held on the Saturday night prior to ANZAC DAY. In 2006 this will be Saturday, 22nd April. Again, a date for your diary.

### RD Results

I have not yet received a copy of the full results from the 2005 Remembrance Day Contest from the Contest Manager. The results will be published as soon as they become available.

Good contesting and 73

# Australian Contest Dates 2006

March	18/19	John Moyle Memorial Field Day	(CW/SSB/FM)
April	8	QRP Hours	(CW/PSK31/RTTY/SSB)
	22	Harry Angel Memorial Contest	(CW/SSB)
May	20	VK/trans-Tasman 80 metres Phone Contest	
	27	VK/trans-Tasman 80 metres CW Contest	
	28		
June	4	VK/trans-Tasman 80 metres CW Contest	
	10/11	ANARTS RTTY Contest	
July	8	VK/trans-Tasman 160 metres Phone Contest	
	22	VK/trans-Tasman 160 metres CW Contest	
August	5	QRP Day Contest	(CW/SSB/FM/PSK31)
	12/13	Remembrance Day Contest	(CW/SSB/FM)
	26	ALARA Contest	(CW/SSB)
October	7/8	Oceania DX Contest	(SSB)
	14/15	Oceania DX Contest	(CW)
November	18	VHF Spring Field Day	(CW/SSB/FM)
December	26	Ross Hull Memorial VHF Contest	

**“Hey, Old  
Timer...”**

**If you have  
been licensed  
for more  
than 25 years you are  
invited to join the  
Radio Amateurs  
Old Timers Club  
Australia**



or if you have been licensed for **less than 25 but more than ten years**, you are invited to become an **Associate Member** of the RAOTC.

In either case a **\$5.00** joining fee plus **\$8.00** for one year or **\$15.00** for two years gets you two interesting OTN Journals a year plus good fellowship.

Write to  
RAOTC,  
PO Box 107  
Mentone VIC 3194  
or call Arthur VK3VQ on 03 9598 4262 or  
Bill VK3BR on 03 9584 9512,  
or email to raotc@raotc.org.au  
for an application form.

## QRP Hours Contest

**Saturday, 8th April, 2006**

*0930 - 1030 UTC CW/RTTY/PSK31*

*1030 - 1130 UTC SSB*

Sponsored by the CW Operators' QRP Club, the aim of this contest is to make as many contacts as possible within a one-hour period using your choice of mode. Whilst it is hoped that the event will be strongly supported by QRP Club Members, it is open to all licensed amateurs.

### Output Power:

Preferably 5 watts, but not more than 10 watts of carrier power. This is to stress the QRP nature of the event.

### Modes:

*First Hour* - CW (including RTTY and PSK31) 0930 UTC (1930 Eastern Standard Time)

*Second Hour* - SSB 1030 UTC (2030 Eastern Standard Time)

### Frequencies:

CW/PSK31/RTTY 3.500-3.540 MHz  
SSB 3.550-3.630 MHz

Exchange a three-digit serial number starting at 001 and incrementing by one for each new contact.

Score one point per contact.

Logs must show the name, address and callsign of the operator and the number of points claimed.

Send Logs by mail to:

Ian Godsil VK3JS,  
363 Nepean Highway,  
Chelsea, 3196;

or by email to:

vk3js@bigpond.com

Please consider using email and sending the log immediately after the event. Otherwise logs should be received by last mail on

*Friday, 21st April, 2006.*

Certificates will be awarded to the highest scorers in each Mode in each State.



# Ross Hull Memorial VHF-UHF Contest 2005 – 2006: Results

Contest manager: John Martin VK3KWA

This is the second year of the new rules. The main developments this year have been a resurgence in VK4, less than usual activity in VK3, and a mixture of old and new callsigns.

The upsurge of VK4 was led by Glenn VK4TZL, who now chalks up a third contest win. Other top scorers were Colin VK5DK, Roy VK4ZQ, and Rod VK2TWR. In Section B, Glenn scoops the pool again, followed by Peter VK3KAI and Colin VK5DK. And in Section C, Rex VK7MO seems to be

quite unassailable. Congratulations to these and to all entrants.

I'm still thinking about the rules and trying to work out how to boost the activity back to the level of the "good old days" in the eighties and early nineties. The three new contest sections don't seem to be achieving that. I have received several suggestions that it would be better to go back to the original seven-day and two-day sections – and maybe the distance-based scoring

system needs to be reviewed. But the only practical alternative would be a grid square system, as used in the VHF-UHF Field Days. Worth a try perhaps? There is definitely a need to find a way of getting more stations on the air and attracting newcomers to the fascinating world of VHF DX.

Any comments or suggestions would be gratefully received – VK3KWA (QTHR) or vhf-contests@wia.org.au.

## Ross Hull Contest 2005 - 2006

Call	Name	50	144	432	1296	2.4G	3.4G	5.7G	10G	24G	TOTAL
<b>Section A: VHF-UHF (6m – 23cm)</b>											
VK4TZL	G. McNeil	85	2028	755	872	-	-	-	-	-	3740
VK5DK	C. Hutchesson	16	1623	765	480	-	-	-	-	-	2884
VK4ZQ	R. O'Malley	375	1368	755	312	-	-	-	-	-	2820
VK2TWR	R. Collman	18	714	785	336	-	-	-	-	-	1853
VK3UH	L. Mostert	138	450	545	496	-	-	-	-	-	1629
VK7MO	R. Moncur	22	135	650	-	-	-	-	-	-	807
VK3HV	G. Francis	132	162	220	272	-	-	-	-	-	786
VK2TG	R. Demkiw	19	468	255	-	-	-	-	-	-	742
VK4KZR	R. Preston	-	204	110	264	-	-	-	-	-	578
VK3KAI	P. Freeman	1	150	125	280	-	-	-	-	-	556
VK2ZRE	R. Gilbert	-	450	95	-	-	-	-	-	-	545
VK4CDI	P. Moat	1	264	150	-	-	-	-	-	-	415
VK6DXI	M. Rozbicki	9	159	105	32	-	-	-	-	-	305
VK1WJ	W. Jirgens	35	27	20	-	-	-	-	-	-	82
<b>Section B: Microwaves (23cm and above)</b>											
VK4TZL	G. McNeil	-	-	-	952	-	-	-	-	-	952
VK3KAI	P. Freeman	-	-	-	280	110	100	90	130	-	710
VK5DK	C. Hutchesson	-	-	-	488	40	40	40	70	20	698
VK3HV	G. Francis	-	-	-	272	-	-	-	30	-	302
VK4KZR	R. Preston	-	-	-	264	-	-	-	-	-	264
<b>Section C: Digital modes, All Bands</b>											
VK7MO	R. Moncur	-	1011	1090	-	-	-	-	-	-	2101
VK1WJ	W. Jirgens	-	165	-	-	-	-	-	-	-	165

## Ross Hull Contest: List of Winners, 1950 - 2006

1950 - 1951	VK5QR	R. Galle	1969 - 1970	VK3ZER	R. W. Wilkinson	1988 - 1989	VK5NC	T. D. Niven
1951 - 1952	VK5BC	H. Lloyd	1970 - 1971	VK4ZFB	E. F. Blanch	1989 - 1990	VK3XRS	R. K. W. Steedman
1952 - 1953	VK4KK	A. K. Bradford	1971 - 1972	VK5SU	J. W. K. Adams	1990 - 1991	VK3XRS	R. K. W. Steedman
1953 - 1954	VK6BO	R. J. Everingham	1972 - 1973	VK5SU	J. W. K. Adams	1991 - 1992	VK3XRS	R. K. W. Steedman
1954 - 1955	VK4NG	R. Greenwood	1973 - 1974	VK5SU	J. W. K. Adams	1992 - 1993	VK3XRS	R. K. W. Steedman
1955 - 1956	VK3GM	G. McCullough	1974 - 1975	VK5SU	J. W. K. Adams	1993 - 1994	VK3XRS	R. K. W. Steedman
1956 - 1957	VK3ALZ	I. F. Berwick	1975 - 1976	VK5SU	J. W. K. Adams	1994 - 1995	VK3XRS	R. K. W. Steedman
1957 - 1958	VK3ALZ	I. F. Berwick	1976 - 1977	VK4DO	H. L. Hobler	1995 - 1996	VK2FZ/4	A. Pollock
1958 - 1959	VK3ALZ	I. F. Berwick	1977 - 1978	VK3OT	S. R. Gregory	1996 - 1997	VK2FZ/4	A. Pollock
1959 - 1960	VK4ZAX	D. R. Horgan	1978 - 1979	VK4DO	H. L. Hobler	1997 - 1998	VK2FZ/4	A. Pollock
1960 - 1961	VK3ARZ	W. Roper	1979 - 1980	VK3ATN	T. R. Naughton	1998 - 1999	VK3XPD	A. P. Devlin
1961 - 1962	VK5ZDR	M. J. McMahon	1980 - 1981	VK6KZ	W. J. Howse	1999 - 2000	VK3EK	R. G. Ashlin
1962 - 1963	VK4ZAX	D. R. Horgan	1981 - 1982	VK6KZ	W. J. Howse	2000 - 2001	VK4TZL	G. R. McNeil
1963 - 1964	VK5ZDR	M. J. McMahon	1982 - 1983	VK6KZ	W. J. Howse	2001 - 2002	VK4TZL	G. R. McNeil
1964 - 1965	VK3ZER	R. W. Wilkinson	1983 - 1984	VK6KZ	W. J. Howse	2002 - 2003	VK3EK	R. G. Ashlin
1965 - 1966	VK3ZDM	J. R. Beames	1984 - 1985	VK3ZBJ	G. L. C. Jenkins	2003 - 2004	VK3EK	R. G. Ashlin
1966 - 1967	VK5HP	J. H. Lehmann	1985 - 1986	VK3ZBJ	G. L. C. Jenkins	2004 - 2005	VK3UH	L. Mostert
1967 - 1968	VK3ZER	R. W. Wilkinson	1986 - 1987	VK3ZBJ	G. L. C. Jenkins	2005 - 2006	VK4TZL	G. R. McNeil
1968 - 1969	VK5ZKR	C. M. Hutchesson	1987 - 1988	VK5NC	T. D. Niven			

# Summer VHF-UHF Field Day 2006: Results

Contest manager: John Martin VK3KWA

The last Field Day was well supported. For reasons yet to be understood, the weather was good and so was the propagation! Some quite noteworthy contacts were made, including a new

VK3 record for the 2.4 GHz band. Congratulations to the winners of each section – VK3KAI, VK3WRE, VK3UHF, VK5SR and VK2KRR. To those who

participated for the first time this year, congratulations also on excellent results, and we hope to see you again next time round.

Call	Name	Location	50	144	432	1296	2.4 GHz	3.4 GHz	5.7 GHz	10 GHz	24 GHz	TOTAL
<b>Section A: Single Operator, 24 Hours</b>												
VK3KAI	P. Freeman	QF21,22,31,32	21	429	455	960	790	780	780	940	-	5155
VK2TWR	R. Collman	QF44	77	756	1125	608	-	-	-	-	-	2566
VK3HY	G. Brain	QF32	158	774	1000	480	-	-	-	-	-	2412
VK4OE	D. Friend	QG61	-	444	455	328	450	-	-	-	-	1677
VK5OM	J. Bywaters	QF02	71	441	505	456	-	-	-	-	-	1473
VK6DXI	M. Rozbicki	OF88	46	207	250	208	-	-	-	-	-	711
<b>Section B: Single Operator, 6 Hours</b>												
VK3WRE	R. Edgar	QF31	-	279	465	624	790	760	770	890	-	4578
VK3KAI	P. Freeman	QF21,22,31,32	21	399	430	658	670	660	560	820	-	4248
VK3HGY	D. Wright	QF31	-	261	655	256	210	-	430	-	-	1812
VK3UH	L. Mostert	QF21	57	249	355	504	-	-	-	210	-	1375
VK3HV	G. Francis	QF21	56	246	350	504	-	-	-	210	-	1366
VK3YFL	B. Dunkley-Smith	QF12,22	65	444	625	-	-	-	-	-	-	1134
VK5OM	J. Bywaters	QF02	57	297	355	396	-	-	-	-	-	1105
VK2TPK	P. Kohlmayer	QF66	33	114	165	-	-	-	-	-	-	312
VK5DC	D. Cavies	PF94	58	74	-	-	-	-	-	-	-	132
<b>Section C: Multi Operator, 24 Hours</b>												
VK3UHF	GUMEG (1)	QF21	124	681	975	1152	600	460	450	750	210	5402
VK3EG	EGRG (2)	QF42	116	570	340	432	230	230	250	240	-	2408
VK3ATL	GARC (3)	QF11	50	456	655	448	350	-	-	250	-	2209
VK3III	Horsham ARC (4)	QF12	144	768	720	576	-	-	-	-	-	2208
VK2AES	(5)	QF45	48	444	345	312	-	-	-	-	-	1149
VK5AR	(6)	PF94	158	486	465	-	-	-	-	-	-	1080
<b>Section D: Multi Operator, 6 Hours</b>												
VK5SR	SERG (7)	QF02	96	615	630	608	160	140	120	160	-	2529
VK3WWW	(8)	QF22	122	384	445	-	-	-	-	-	-	951
<b>Section E: Home Station, 24 Hours</b>												
VK2KRR	L. Rainbird	QF34	24	507	625	376	-	-	-	-	-	1532
VK3UDX	G. Beadle	QF22	80	378	495	424	-	-	-	-	-	1377
VK3UH	L. Mostert	QF21	78	303	445	456	-	-	-	-	-	1282
VK3BG	E. Roache	QF24	32	174	235	176	-	-	-	-	-	617
VK3DMW	K. Brown	QF31	34	384	175	-	-	-	-	-	-	593
VK1WJ	W. Jirgens	QF44	77	177	170	-	-	-	-	-	-	424
VK2CZ	D. Burger	QF56	-	228	-	-	-	-	-	-	-	228

- (1) Geelong UHF/Microwave Experimenters' Group: C. Gnaccarini VK3PY, D. Learmonth VK3QM, C. Kahwagi VK3NX.
- (2) East Gippsland Radio Group: R. Ashlin VK3EK, R. Donnan VK3VHF.
- (3) Geelong Amateur Radio Club: L. De Vries VK3PK, K. Jewell VK3NW, I. Westerland VK3VIN.
- (4) Horsham ARC: T. Morgan VK3JTM, D. Timms VK3YLV, G. Richards VK3FIQ, A. Clark VK3SSB, C. McGrath VK3HSV.
- (5) A. Sayers VK2AES, D. Hughes VK1DSH, R. Manning VK1JRM.
- (6) A. Raftery VK5AR, A. Russell VK5ZUC.
- (7) South East Radio Group: C. Hutchesson VK5DK, D. Walshaw VK5HDW, T. Aubrey VK5EE, J. Drew VK5DJ, M. Williamson VK5HMM.
- (8) J. Bramham VK3WWW, M. Chadwick VK3WT.

ar

**Are you managing the estate of a 'Silent key'?**

Please save any QSLs for the National QSL collection, but first contact:

The Hon. Curator,  
Ken Matchett VK3TL  
on (03) 9728 5350  
or email: jeandawson@iinet.net.au

Rare DX, special call-signs prefixes and suffixes, pictorials and pre-war QSLs are needed.

Let us save something for the history of amateur radio.

## Keep it up, VK7HAY!

I had intended to write after reading the article by VK7HAY in October AR; alas, I let the moment pass. After reading the editorial in November AR, I will say what I intended to say.

What struck me forcibly on reading VK7HAY's article was the sheer enthusiasm of this young bloke. I have seen mention of him in AR previously in connection with the activities of his club; he seems to be most passionate about his radio activities.

People like VK7HAY are our future, whether in radio or in the myriad activities of life. Nothing gives me greater pleasure than seeing young people bursting with energy and full of enthusiasm for life and what they are doing in it.

Conversely, nothing saddens me more than the contrary view that is sometimes expressed by so many of my fellow senior-cits: "Flamin' noisy kids, why don't they grow up?"

Keep it up, Hayden; may your passion never diminish.

That was what I thought (and still think) after reading the article; now I gather from the November editorial that

there has been criticism of the technical content.

Yes, the article was basic: there is nothing wrong with that. Hayden described an antenna which is simple to construct and will get an eager beginner on-air very quickly. This antenna will work in all but the most extraordinary circumstances. It is unlikely to be perfect; it may be unbalanced by nearby objects, it may have some current on the outside of the feedline sheath, it may not be a perfect match to 50-ohm feedline and its radiation pattern may differ from that of a dipole in free space.

But it will work!!

Once it is working the builder may well find that it has an SWR of 2:1, that it doesn't work well in certain directions or, in extremis, that it causes some odd effects from RF in the operating room. The builder, in the amateur tradition of enquiry and experiment, will ask "Why is it so?"

This will lead to further research and experimentation, along the lines of "Hey, there was an article by VK4TWI in November AR, wonder what that says?"

VK4TWI's article is a rather deeper exploration of the subject; that does not make it a better article than VK7HAY's. VK4TWI's article is an excellent one but it could be criticised as, apparently, VK7HAY's has been; it could go further.

For instance, there is a great deal more to be said about feedpoint impedance vis-à-vis height (in wavelengths) above ground than is contained in the article.

This is not a criticism of VK4TWI's article; I am just making a point.

The difficulty is that whole books have been written about the deceptively-simple dipole; the subject is considerably more-complex than might at first appear.

That is the nature of radio; despite our advances in technical knowledge there is still much art in the amateur's activities.

I think that the reader, not the editor, must be the filter. If the editor is to act in this capacity, almost every technical article would require a "consumer warning" to the effect that there is more to the relevant subject than is covered in the article.

An intelligent reader should understand the level at which an article is written. The "nanny society" has invaded amateur radio (and our lives) to a considerable extent already and we must stop somewhere.

This is not to say that articles which propound serious technical errors should be published; that is a horse of an entirely different hue. All technical articles should be scrutinised for accuracy.

VK7HAY's article is not inaccurate; it simply treats its subject at a basic level. That is part of the learning process. The outcome for the reader who decides to follow the article will be a device that is not perfect; further study (including, perhaps, reference to VK4TWI's article) and experimentation will improve that device to better suit the builder's requirements but it will never be "perfect" (whatever that means).

The amateur who starts with VK7HAY's design and develops it into something better is just acting in the true spirit of amateur radio.

Kerry Power VK2TIL.

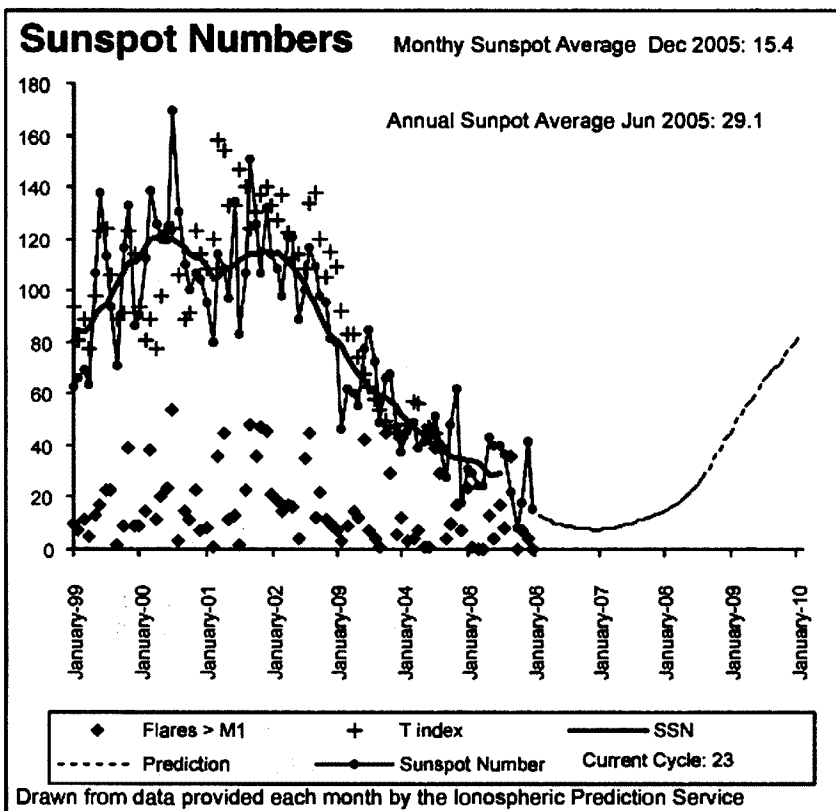

# VHF/UHF - an expanding world

David Smith VK3HZ - vk3hz@wia.org.au  
Leigh Rainbird VK2KRR - vk2krr@wia.org.au

## Weak Signal

David Smith - VK3HZ

The Summer VHF/UHF Field Day over the weekend of January 14/15 was blessed, in this southeast corner of the country anyway, with good conditions – both weather and propagation. Many stations – club and individual - were out on the mountaintops for the duration. On Saturday night and Sunday morning, good tropo conditions occurred across the south of VK3 into VK5. Ralph VK3WRE set up his portable microwave station on Mt Tassie in central Gippsland and worked Colin VK5DK near Mt Gambier on all bands to 10 GHz over a distance of 531.1 km. In the process, they set new VK3 records for the 2.4 GHz and 3.4 GHz bands.

On the Sunday evening, the Mt Gambier beacons were the loudest I've ever heard them in Melbourne. The 23 cm beacon was well over S9. The 70 cm beacon was S7 when it WASN'T keyed, rising to S9+40 when keyed.

Paul VK7BBW reports that there have been several good openings from northern Tasmania up to VK3/VK5. On January 13, he worked Chas VK3PY on 70 cm at S3-4. The following day, he worked John VK5NJ on 2 m FM at S5. On January 20, he did the "traps" with John working him on 2 m SSB (S1) and 70 cm (S1). The opening also included

contacts with various VK3's including VK3HZ and VK3XL. Finally he reports the somewhat old, but nevertheless very interesting, news that he worked VK4CV on 2 m SSB around Christmas 2004.

On the evening of January 24, an opening from VK3/5 to VK6 produced a number of good contacts. At 0830Z, Phil VK5AKK reports working Wally VK6WG on 2 m (S7) and 70 cm (S6). They attempted a contact on 23 cm, but nothing was heard. At 1050Z, VK6WG worked VK3II, VK3UH and VK5UBC. VK5ZBK then worked Wally on 70 cm. VK5RU had success on 2 m, 70 cm and 23 cm.

On Friday evening January 27, the bands opened from the east coast across to ZL. Bob ZL3TY seemed to be holding up the eastern end of the opening and had a bumper time working many stations in VK2 and VK4.

By the Saturday evening (January 28), the opening had extended southwards to southeast Victoria, and several interesting contacts were had. See the following Digital DX Modes section for more details. Southern stations worked by ZL3TY include VK7MO, VK3HZ, VK3VHF and VK3EK. The opening continued into Sunday with contacts to VK1WJ (FSK441), VK3BDL, VK3AMK,

VK3DUT, VK3KAQ, VK3BBB, VK3ZYC, VK3KAI, VK3II and VK3ALA. Conditions finally faded out at about lunchtime on the Sunday. Unfortunately, Bob's 70 cm antenna was down, so all contacts were on 2 m. He reports that it was a great weekend for him, working 20 x VK2, 12 x VK3, 3 x VK4, VK7MO and VK1WJ and a near miss with 2 x VK5.

At the same time, conditions were excellent along the east coast between VK2 and VK4. Chris VK2DO near Canberra worked Trevor VK4AFL in Brisbane and Kev VK4KKD on 2 m. Chris then worked Trevor on 70 cm at S3. Rod VK2TWR worked Glen VK4TZL on 2 m.

Finally, it's good to hear of a station in a rare area becoming active on the low end of the band. Doug VK9ZLH is on Lord Howe Island for the next 3 years. Kerry VK2BXT to the south of Sydney reports that on Friday January 27, he worked Doug on 2 m with signals peaking to S9+40. Kerry was Doug's first 2 m contact, as he had only put up his 10-element beam the day before. Doug runs 80 watts. Many Sydney stations subsequently worked him during the opening that extended to ZL.

Please send any Weak Signal reports to David VK3HZ at vk3hz@wia.org.au.

## Digital DX Modes

Rex Moncur - VK7MO

From 25 to 29 January 2006, Peter VK5ZPG undertook a DXpedition to the northern Flinders Ranges to activate the rare grid square PF99 on 2 m using FSK441. Peter had some equipment problems, which reduced his power output to around 50 watts, and advises that this was a learning experience. However, he did copy 11 stations and completed contacts with VK2KRR, VK3HZ, VK3ZYC, VK3KAI and VK3II.

On 27 January 2006, Bob ZL3TY worked Dave VK2AWD, Dave VK3HZ, Rhett, VK3VHF and Rex VK7MO on JT65 on 2 m. There were two interesting things:

Firstly, there was a strong tropo-duct opening to VK2 that was allowing Bob to work the VK2s on SSB but the Hepburn chart showed this did not extend to VK3 and VK7 and no SSB contacts were made South of Wollongong. The extra sensitivity of JT65 allowed an extension well beyond that indicated by Hepburn but still took advantage of the tropo-duct at ZL3TY's end. From the Hepburn chart it would appear that the first 500 km or so from VK3/7 would have been achieved by tropo-scatter and the last 1500 km by tropo-duct. From this one can conclude that it is worth attempting JT65 contacts when ducts do not extend

over the full path – up to a further 500 km or so to take advantage of possible multi-mode propagation.

Secondly, the JT65 contacts were affected by meteors and both Bob ZL3TY and Dave VK3HZ noted many meteor pings on a path of 2287 km. In the past, attempts at meteor scatter over this path have not shown any pings at all. The fact that meteors were being received suggested that tropo-ducting might be extending the range of meteor scatter. A little later Garry VK5ZK (at Goolwa, 2892 km from ZL3TY) reported he could see some pings from Bob's JT65

transmission and a sked was set up using FSK441. Bob decoded a number of pings from Garry. Peter, VK5ZLX at Angaston (2919 km) then reported pings from Bob and started transmitting. Bob also saw pings from Peter. The best was a short burn of 1.1 seconds reported by Peter. However, no contacts were completed.

The following day, ZL3TY made numerous SSB and JT65 contacts into VK3/7, as far as Melbourne, indicating that the duct had extended further South and further towards VK. A further attempt was made between ZL3TY and VK5ZK/VK5ZLX but only one decodable ping was received by ZL3TY. A few hours later, when the duct was no longer reaching Melbourne, a second attempt was made and VK5ZK received 5 decodable pings but nothing was received by ZL3TY or VK5ZLX. During the same day Ian, VK3AXH, near Ballarat, reported pings when listening to ZL3TY's JT65 signal over a path of 2387 km at the time when Bob was working JT65 into Melbourne – but JT65 was not detectable on tropo at Ian's QTH.

While a VK5 contact was not completed, this exercise was sufficient to show that the normal limit of around 2300 km for meteor scatter can be extended if there is a good tropo-duct at one end.

It is worth some conjecture about what conditions allow a tropo-duct extension of meteor scatter. It would be expected that for efficient entry to a duct the signal would need to arrive at a very low angle and thus the meteor scatter component of the path would need to be reasonably long - say 1500 km or more. Inspection of the Hepburn chart indicates this was the case between ZL3TY and the VK5s. However, the pings received by VK3AXH and VK3HZ are unlikely to have entered at the start of the duct, which was within a few hundred km, as the entry angle would be several degrees. Also, meteor scatter is unlikely over such a short path. This in turn suggests that some of the meteor extensions were entering the duct somewhere in the middle of a region which is shown on the Hepburn chart to suggest a duct. There is some evidence on the Hepburn chart of variability in the strength of the duct nearer to ZL. Thus while the best situation might be a strong duct at one end combined with a non-ducted region of around 1500 to 1800 km it seems

000830	21.4	160	2 26	22	3TY VK5ZK3 L3TY K ZHZQF3
004130	4.6	100	5 16	109	ZL3TY VK5ZK ZN3DY
004130	4.8	140	2 26	109	3TY VK5ZK ZL3PY VK5ZK
004130	4.6	160	1 26	109	I3TY FK7YK ZL3TY VK5ZK ZN
004130	4.6	120	4 26	109	K ZL3TY VK5ZK ZN3DZ
004130	4.8	140	2 26	152	Y VK5ZK ZL3PY VK5ZK /
004130	4.6	120	4 26	109	K ZL3TY VK5ZK ZN3DY
004730	11.4	360	3 26	109	9 VK5UK ZL3TY VK5ZK ZL3TY VK5ZO ZL3TY3RK
004730	12.0	240	2 26	152	ZL3TY VK5ZK ZL3TY VK5ZK ZL3TY VK5ZK E
004830	10.1	100	4 16	-21	L3TY 26 VK5ZLX 6Y
005830	19.3	280	4 26	109	I#K TQ R25 LY6A F 26 D 5ZLX F3 G5YLK
005830	19.3	280	3 26	109	E1TY BT 87G6 TI UK X8KZH3F P/K MHFQ
005930	7.7	220	3 26	65	LX 2626WZL3VY 26 VK5ZLX 2226 ZO1EQ
005930	8.0	200	5 26	65	ZLX 2626 ZL3TY 26 VK5ZLX 2626 Z
005930	8.2	440	4 26	65	VK5ZLX 2626 ZL3TY 26 VK5ZLX 2626 ZL3TY

Table 1. Decodes received by VK5ZK on the second day of testing.

one should not overlook the possibility of entry somewhere in the middle of a duct.

The results achieved into VK5 suggest that it is well worth looking for tropo extensions of meteor scatter to the west of the Great Dividing Range whenever Hepburn indicates enhanced tropo conditions at the ZL side of the Tasman. Contacts of 2900 km and more seem to be possible (see Table 1).

While Garry heard around 15 pings on the first day of testing, these did not decode due to a set-up problem with clip set to full at 99, thus eliminating meteors (Murphy's Law). Note that while hard clipping can be useful for eliminating meteors from tropo signals on JT65, clip should not be used on FSK441. Later versions of WSJT avoid this problem by automatically changing to the default values on change of mode.

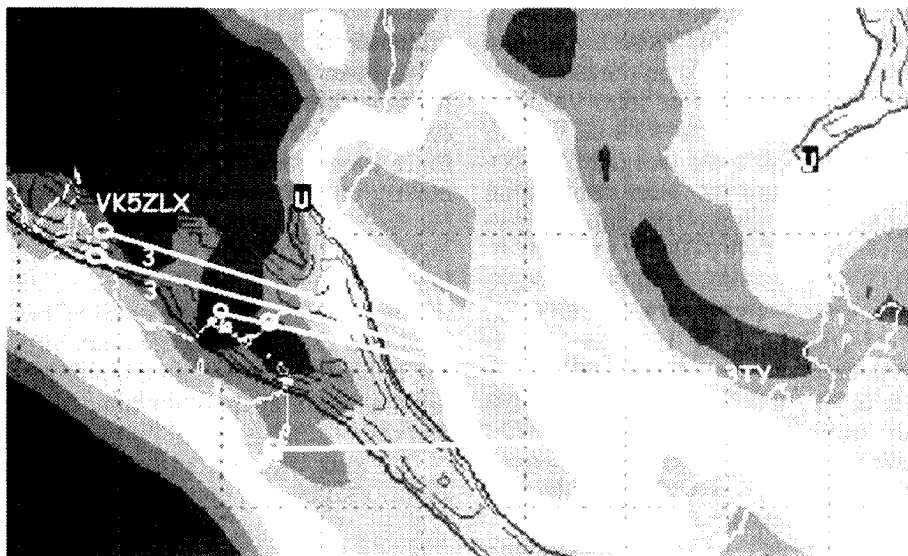

Hepburn chart for 1800 UTC on 27 January 2006

1. Tropo-ducting to Sydney area
2. Tropo-scatter extending duct to Melbourne and Hobart
3. Meteor-scatter extending duct to VK5ZK and VK5ZLX

Please send any Digital DX Modes reports to Rex VK7MO at [rmoncur@bigpond.net.au](mailto:rmoncur@bigpond.net.au).

*continued next page*

## CASTLEMAINE RADIO TRADE DAY & SWAP MEET

Sunday April 23, 2006 10 am

Corner Hargreaves and Lyttleton St

Tables available, Door Prizes, many opportunities all in one of Victoria's beautiful old gold mining towns

Bruce Lees 0427 271 071 for details

# The Magic Band – 6 m DX

Brian Cleland – VK5UBC

Sporadic E openings continued to occur during January and early February without any highlights although some good openings occurred from VK6. Odd openings occurred on many days in January with good openings down the eastern seaboard and to VK5 on the 12th, 14th, 15th and 16th January with the band being open several hours on these days. Norm VK3DUT made a good contact with VK6KDD in Port Hedland on the 16th January.

Bumper openings occurred from VK6 to VK5, 3 and 2 on the afternoons of the 4th and 6th February. Many VK6s including VK6HK, ZAK (Kalgoorlie), JJ, JR, AB, IP, RZ, RO, KDX, ZWZ, CO were worked in VK5 and on 4th February the opening extended to northern NSW where Leigh VK2KRR worked 8 VK6s on his dipole. Also during this opening Noel VK6ZAK in Kalgoorlie was able to work stations in the Perth area on backscatter. On the 6th February the opening extended to northern VK3 where Norm VK3DUT worked several of the VK6s. It was great to hear so many VK6s on the band.

A good opening from John VK4FNQ in Charters Towers to VK6 on the 9th January when John worked VK6RO, IQ, ZKO, JJ and RZ. John also had an opening to ZL on the 7th January where he worked ZL2TPY and ZL2BPL.

On the 7th January ZL'S were also worked by Brian VK5UBC from his portable QTH at Corny Point (PF85mc).

It is also worth looking out for the odd tropospheric contact. Recently I have worked Leigh VK2KRR (The Rock 760km) and Terry VK3ATS (Mildura

300km) early in the morning. These contacts are normally possible when good tropospheric conditions are being experienced on 2 m.

Received a note from Jack VK2XQ in Sydney summarising December/early January activities as follows:-

Only two openings to Japan noted in December, nothing in January so far. The two JA openings have been quite short, only 10 to 20 minutes or so and on 4th December I worked JA2DDN. Nothing from South Korea, Hong Kong or China heard.

The path to ZL is the only regular event, sometimes open as early as 2000UTC and closing as late at 1300UTC. All of ZL call areas (ZL1, ZL2, ZL3 and ZL4) have been heard/worked in Sydney.

New Caledonia is also fairly regular from mid to late morning onwards, from 2230UTC right through to 1000UTC on some occasions. FK8SIX beacon often 20dB over, but only operator heard this season was FK1TK working VK4s.

Interstate DX has been good with all of VK4 noted. Although VK4ABP beacon has been heard many times, as yet no one has been worked in Longreach, there have been odd paths to VK3, mostly on scatter and the VK7 path has been irregular, but when open the regulars from Hobart and Launceston have been worked or heard. VK6 path in the afternoon to late evening has produced some lengthy openings with good signals, not regular though, just have to be on at the right time to get this path.

VK5 and VK8 Alice Springs also about, VK8 beacon comes in when the

VK5s are strong indicating the path has extended.

Jim VK9NS has not been heard on six this season. Usually when the FK8 beacon is strong, Norfolk Island can be worked.

Not many new ops on six this season, same old voices, same old grid squares means I have lost a little interest. The radio often runs for hours but I have not worked anyone but have heard the same old calls etc. Many of the regular six ops in Sydney are absent this season too, some days I am the only Sydney station on air.

Despite being reported as back on air in "test" mode, I have yet to log the Launceston beacon, the VK5RBV beacon beats the VK5VF beacon hands down. The ZL1VHF beacon in Auckland is off air until further notice. Only VK4 beacons on air are RTL, ABP and RGG, rest are off air and have been for some time.

Thanks Jack, my observations in VK5 are fairly similar, my log indicates that the number of contacts and different stations worked this season to be about 30% down on the previous season. Generally there appear to have been fewer regular openings with activity down. One very disappointing aspect is there is very little activity from the NT with Jeff VK8GF in Alice Springs being the only active station with no reported contacts into the Darwin area. Also I do not know of any beacons or activity from Papua New Guinea.

Please remember to send any 6 m information to Brian VK5UBC at bcleland@picknowl.com.au.

## 2 m & 70 cm FM DX

Leigh Rainbird - VK2KRR

FM DX during January was quite eventful with some good openings, mainly in the south of the country.

A pretty big duct opening occurred on the public holiday Monday 02/01/06. This opening spanned the legendary Great Australian Bight Path. During this opening, conditions noted from my QTH were reasonable to the Adelaide area repeaters. However, better signals were noted from the repeaters at Mt Gambier and Naracoorte. Of more significance,

I was also able to access the VK6RMS Boddington, Mt Saddleback repeater on 147.250 MHz, approximately 120 km SE of Perth and 2817 km from my QTH. Did not hear any response to my CQ calls and the repeater signal was only as good as an S2 here.

Things were very quiet in VK4 during January. But one quick report from Mike VK4MIK near Cairns showed a long path on 04/01/06, where Mike was able to get into the VK4RGA Monto repeater

over a big 951 km distance down the coast. Sadly no reports of Papua New Guinea 2 m signals heard in VK4 again this summer.

Noted on the 09/01/06, a rare contact from Grant VK2AXB in Orange way down to Mt Macedon VK3RMM. Here Grant worked John VK3HJW mobile and some other VK3s.

More big tropo openings in the south on 13th and 14th January and a Bight Path opening on the 25th January made

## Can you help?

### Australian QSL card request for a book on our Ham Radio Stations

Many of us have seen the plethora of books on the subject of Crystal Radio sets as well as Valve Broadcast sets from the 1920s to 1960s. But how many books have you seen on the subject of Amateur Radio Equipment and more important, the Stations of the Hams of the early days up to the beginning of commercial equipment in the shack in the 1960's.

Well in an attempt to address this void in our history and to give something back to this great hobby of ours, I am undertaking to write a book on exactly that. My book will be based on the information provided by the Stations history itself in the form of QSL Cards.

I plan to look at the stations of the day and seek out information of the equipment that was used, the valves, the aerials, and forms of modulation. A general census you might say of how we as amateur radio operators in Australia went about the hobby of ham radio.

This is to be a long term project, and I am hoping that you, the readers of "AR" might like to contribute with perhaps some early cards from the 1920s to say the pre World War Two, covering the introduction of TWO Letter call QSL Cards, be they scanned on a disc or simply donated, should you wish

to part with them. The next bracket of cards for information would again be Two-Letter Cards covering post WW2 to the 1960s. This way I can obtain a pretty good demographic of the way things were from the 1920s to pre WW2 and beyond when stations started to become ex disposals right up to the commercial period. Best of all, it also becomes a time capsule of our past.

I look forward to hearing from you one and all with any assistance you might like to offer in the form of QSL cards or information to make this project a success. I can be contacted as below:

**Michael J. Charteris VK4QS.**

Email: [empire1963@hotmail.com](mailto:empire1963@hotmail.com)

Or ph: (07) 3282 9539

## Valves in Class C

I have read Brian VK2GCE's comments that I have made errors on the efficiency of various types of valves in class C. Sorry Brian, I do not agree with your comments about the efficiency of valves in class C. The efficiency is not necessarily dictated by a particular formula, but more by the characteristics of the particular valve type and how it is used in a circuit. I did a number of tests with small battery valves of similar types and characteristics to the ones used in the early Flying Doctor Radios and built replicas of these early sets. The best efficiency I could get was around 40% in class C. I really did think that I was doing something wrong and persisted with my tests for some time.

I then happened on information in the RCA Transmitting Tube Manual on the

3A4, a small battery transmitting valve similar to the 33 used in some early FDS radios. Surprise, surprise, it has a plate circuit efficiency of around 40% in Class C. The 807 is around 62.5% with 400 volts on the plate, and the Eimac 4CV100,000E is around 85% efficient with 13 kV on the plate and drawing 9 amps plate current, with 117 kW in for 100 kW out. All three types are quoted as running in Class C.

Brian you also say that the total efficiency of the AC valves (heater/filament, screen and plate) will not be as good as the battery type valves. This also is not true. The 3A4 total power consumption to give 1.2 watts output is 4 watts, an efficiency of 30%. The 807 with 400 volts on the plate (similar to early FDS radio transceivers of the 40s

and 50s) is 48.9 watts input total for 25 watts output = 51% efficiency. If you want to include the 4CV100,000E the total input, heater/filament, screen and plate equals 122 kW for 100 kW out which gives 82%.

On this last point I realise that the big valves need to be on for some time, 30 seconds or so, before they are ready for full output, but as I said in my article they are only used for short periods and the receiver is run with the transmitter heaters off most of the time to conserve electrical energy.

You will see more detail on my experiments and the types of sets used in the Flying Doctor Service in my book "Outback Radio from Flynn to Satellites".

**Rodnsy Champness VK3UG**

## VHF/UHF – an expanding world *continued*

for some big signals. VK5 repeaters such as Lobethal, Crafers, Barossa Valley, Central North, Naracoorte, Bordertown, Murray Bridge, Port Lincoln, Port Augusta were all 5/9+ into my location at some stage. A call on 146.500 produced a small pile up from here with stations VK2PDW Wagga, VK2AYM Albury,

VK3YLV Horsham, VK3FIQ Stawell, VK2RO/m Yarrawonga, VK3JRA/m Kyabram. VK5AEP at Port Lincoln was also worked on a separate occasion.

Please remember to send through any 2 and 70 FM DX reports to Leigh VK2KRR at [vk2krr@wia.org.au](mailto:vk2krr@wia.org.au)

# Amateur Radio

## -100%

## amateur radio!

# Spotlight on SWLing

Robin Harwood VK7RH

**Autumn has arrived and the days are rapidly drawing in. Propagation has altered due to the seasonal variations with signals coming in the late afternoon to early evening.**

Traditionally the end of this month sees the major frequency alterations to coincide with the introduction of Daylight saving in the Northern Hemisphere on 26th March at 0100. This usually coincides with those Australian states reverting to Standard Time. However because the final day of the Commonwealth Games falls on that date, they have extended Daylight Saving by one week in Victoria, Tasmania and NSW. I do not know if this applies in SA.

Another international broadcaster has departed shortwave. Radio Tashkent in Uzbekistan went quietly. It may still be using shortwave for relays of its domestic service. I remember hearing them in the early 60s in English but lately they have been very hard to hear. Their targets were Afghanistan, Iran, India, Pakistan and the Islamic minority in NW China. After the breakup of the USSR, Uzbekistan developed an independent foreign policy and initially warmed to the US. After 9-11, the Americans and their coalition partners needed airbases in Uzbekistan to refuel on their way to Afghanistan. The Uzbeks supported the anti-Taliban coalition

and there is a sizable Uzbek minority in Afghanistan's western provinces. After initially supporting the so-called War on Terror, Uzbekistan closed the US bases, after the Americans criticised the autocratic actions of its government.

Radio Slovakia International has obtained a reprieve and will be continuing shortwave broadcasting. A permanent funding mechanism is being worked out.

The VOA in Washington made huge cuts in its broadcasting output on February 1st. A major change has been the reduction of available channel capacity. The aim is to eliminate shortwave in 2007 but this, they concede, is impossible, particularly in Africa, where the Internet is non-existent. Surrogate broadcasters such as Radio Farda to Iran, Radio Free Asia and Radio Marti to Cuba will be unaffected. Programs of Radio Liberty to Eastern Europe have already been severely cut back with the emergence of an independent media. Programming to Zimbabwe will be significantly increased in radio and television.

In last month's column, I remarked on being able to use the dxtuners website to remotely access worldwide receivers. My favourite site is located in Johannesburg, South Africa and I find the best time is around 0300. This is when many stations in this region sign

on. For example, I am hearing Zimbabwe on 6612 and it is full-scale deflection, despite it being a harmonic of 3306.

It is therefore odd that the fundamental is not heard in Johannesburg yet I am informed that both can be heard within Zimbabwe. They say the broadcaster does not have funds to repair the sender.

Many older listeners may recall the voice of Keith Glover over Radio Australia. He was the compere of their very popular Mailbag program as well as the voice of the Saturday afternoon Sports Panel on the ABC. Sadly Keith died on 3rd February. I was privileged to meet him when RA was based in Burwood VIC, as part of an ARDXC tour in the early 80s.

This month also sees the Commonwealth Games in Melbourne from the 16th to the 26th. I expect that many Commonwealth broadcasts will be live or have frequent reports on the events.

Also voting in the Israeli General Election will be on the 23rd. Kol Israel in Jerusalem has been covering it in detail and this station tenuously remains on shortwave. Because this election is so important, it has also been extensively covered by the worldwide media, each reflecting a different viewpoint.

Well that is all for this month. My email address is vk7rh@wia.org.au or 20/177 Penquite Road, Norwood TAS 7250

ar

## Silent keys

### Lindsay Collins VK2YN previously VK5GZ

Lindsay passed away on 27th November 2005 in northern NSW where he lived with and is survived by his wife Beryl and daughter Judy.

He would have been well known particularly to us more mature operators and very few would have missed a CW contact with him at some time in the past.

Lindsay was a member of the Royal Australian Signal Corps during WW2 and served in the Middle East and

New Guinea. Later he became an active "Ham" achieving life membership of the Royal Signals Amateur Radio Society and also became active in the Royal Australian Signals Association here in South Australia.

He is noteworthy for his dedication and in fifty years of operating his enthusiasm never wavered. In fact as his health deteriorated in the few weeks before his death he was still active on the bands.

Submitted by Godfrey Williams VK5BGW

### Elwyn Harriss VK7EH

Elwyn Harriss VK7EH, of Beauty Point, passed away on 9 February 2006 after a long battle with cancer. Elwyn was a supporter of the VK7 WIA Division and the Northern Tasmania Club for many years. He was a keen and consistent supporter of the VK7 Sewing Circle 80m Net and a couple of other HF activities, and for a long time kept his condition known only to a few close friends. Pretty hardy, staying with us and active in the hobby for a couple of years after the terminal point specified by the medical men. Vale Elwyn.

Justin Giles-Clark VK7TW

ar



## Graham Pitts VK5GE/VK6GF

8 August 1915 - 12 November 2005

I first met Graham when, as a young PMG Cadet Radio Inspector, I was required to perform a typical beauracrat task, and interview this then famous Outback Communicator on the matter of his changing his Amateur Station Licence, from Alice Springs to Pt. Augusta without permission from the PMG! Such a petty task seemed trivial to me at the time and still would. We started our friendship on a very sour note.

Graham was famous in both the above cities as the local radiocommunications "guru", and listening to him in contact with outstations of the RFDS network, I learned even more about his unusual technical ability. He later came to my attention through monitoring some of his daily schedules with outstations on the Pt. Augusta network, and hearing him fault find a transceiver by 'walking' station owners through their equipment from battery supply to the tip of the antenna in their outback stations.

The logic and analysis used was extraordinary, and his help was of valuable assistance to the station owners, saving them days and sometimes weeks without communications, while the set was away undergoing repairs. There were and still are, no maintenance people roaming the outback, to call on at short notice.

My later professional contact with Graham occurred when the RFDS was being 'drummed' out of Pt. Augusta, by residents living close to the Base Station. A 1000 watt AM transmitter was causing interference to TV reception from Adelaide, some 400 km away. Graham had changed his delta fed dipoles to coaxial cable feed with baluns, with great improvement to most of the complainants, however there remained a significant number of close by persons affected. Graham and I worked together on the output stages of the transmitters, installed high Q traps in each anode lead, and adjusted them to the appropriate harmonic.

Our efforts saved RFDS the extreme expense of moving out of town at that time, however with the changeover to

SSB a few years later, a move to remote operation was arranged.

In his retirement Graham set up an Amateur station at Kensington Gardens in Adelaide, and provided numerous contacts with other retired professionals from the Broadcast, Communications and related industries, on nightly schedules on 3.5 and 7.0 MHz. I visited him and his wife at that location on a number of occasions, enjoyed their hospitality, and later joined in on this interesting Net when I retired.

Graham moved to Bunbury some years ago, and I lost contact with him for a while, however in recent years, the Internet provided the opportunity for some spasmodic exchanges.

I have lost a good friend.

**Rob Gurr VK5RG**

I came to know Graham in 1999 when I was researching the story of the development of radio communications in the outback of Australia for a book I was writing. Without his assistance my book *Outback Radio* would not have been as accurate or complete as it is. We, collectively, would have lost so much of our history of communications in the outback without Graham's help. He provided me with circuits, copies of early letters, manuscripts of talks and seminars, technical manuals, etc. He provided the introduction to the book and many interesting little asides appear in it. I could run various scenarios past him and through all of these discussions, I came to know a gentleman who was passionate about the Royal Flying Doctor Service (this title was bestowed on it in 1955) and who was concerned that the history of communications in the outback be preserved. He proofed various sections of the book and he saw it in its final format and was well satisfied with the end result.

Graham obtained his First Class Commercial Certificate of Proficiency in the 1930s. At the time this was the highest qualification obtainable unless you had an engineering degree. He was a radio officer on several ships and then

transferred to the Marconi School of Wireless in the early days of WWII. On marrying Evelyn in 1943 he obtained a position at a broadcast radio station in Adelaide. In 1944 he applied for a job at Alice Springs at the Flying Doctor Service base as the Base Director, which he obtained. This was the start of his association with the service that lasted officially until 1980 when he retired. However, he did not lose his interest in the service or radio communications and acted as a consultant to other communication services for a number of years.

Perhaps the pinnacle of his career was the part that he played in the establishment of the now quite famous and important School of the Air. The School of the Air was the brain child of Adelaide Meithke (OBE) a retired school Inspector. Graham was the nuts and bolts man who worked out how the equipment of the Flying Doctor Service radio network could be used to make sure that the School of the Air would be successful. When the first broadcasts took place in 1950 the radio equipment available to accomplish this task was not suitable for the task. Like any good amateur radio operator, Graham had to modify the equipment so that it would achieve the results sought after.

Graham's actions improved the quality of communications and education in the outback from which many people have benefited. Like Rob I also have lost a good friend.

**Rodney Champness VK3UG**

*Plan ahead*

**Harry Angel  
Sprint  
April 22**

**Adelaide-Ottawa**

**58**

**Brisbane-Auckland**

**128**

First F 0-5 Short 1901 km

First IF7-9 IE0 Short 2291 km

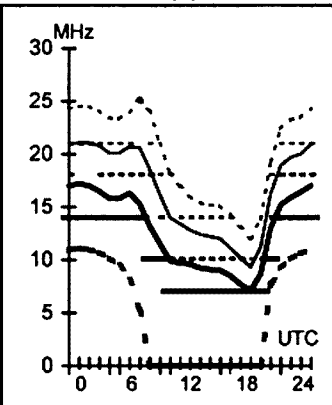
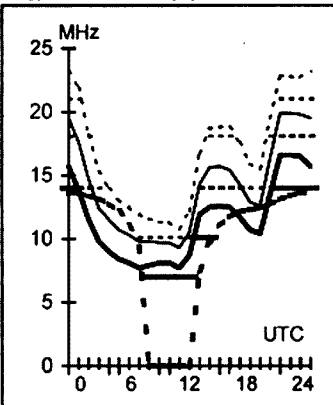

**March 2006**

T index: 15

**Legend**

Frequency scale

- UD
- F-MUF
- OMF
- E-MUF
- ALF
- >10%
- >50%
- >90%

Time Scale

**HF Predictions**

by Evan Jarman VK3ANI

34 Alandale Court Blackburn Vic 3130

These graphs show the predicted diurnal variation of key frequencies for the nominated circuits.

These frequencies as identified in the legend are:-

- Upper Decile (F-layer)
- F-layer Maximum Usable Frequency
- E-layer Maximum Usable Frequency
- Optimum Working Frequency (F-layer)
- Absorption Limiting Frequency (D region)

Shown hourly are the highest frequency amateur bands in ranges between these key frequencies, when usable.

The path, propagation mode and Australian terminal bearing are also given for each circuit.

These predictions were made with the Ionospheric Prediction Service program: ASAPS Version 4

**Adelaide-Singapore**

**311**

**Brisbane-Las Vegas**

**59**

**Canberra-London**

**136**

**Darwin-Honolulu**

**65**

Second 3F11-15 3E Short 5414 km

Second 4F3-6 4E0 Short 11564 km

First F 0\*5 Long 23042 km

First F 0-5 Short 8635 km

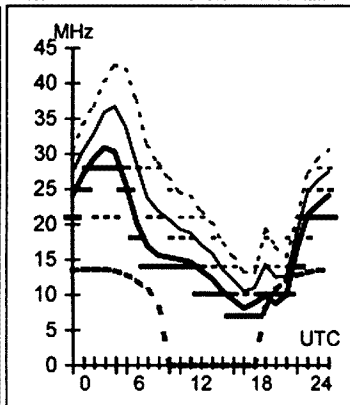
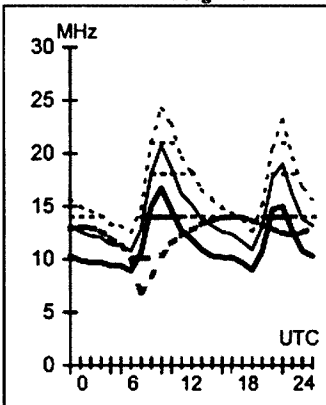
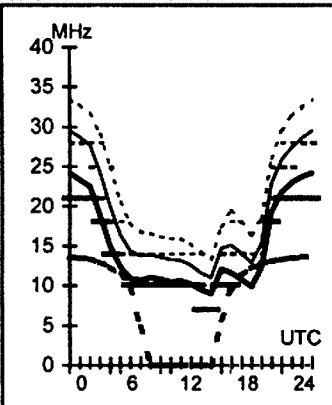
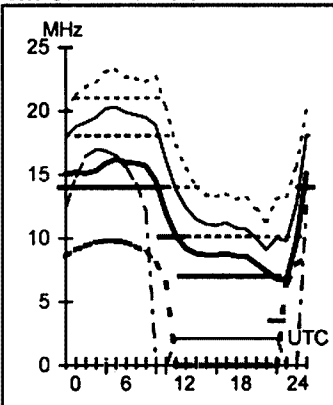

**Adelaide-Tel Aviv**

**291**

**Brisbane-Manila**

**320**

**Canberra-London**

**316**

**Darwin-Osaka**

**5**

First F 0-5 Short 13125 km

Second 3F9-16 3E1 Short 5811 km

First F 0-5 Short 16982 km

Second 3F11-18 3E Short 5262 km

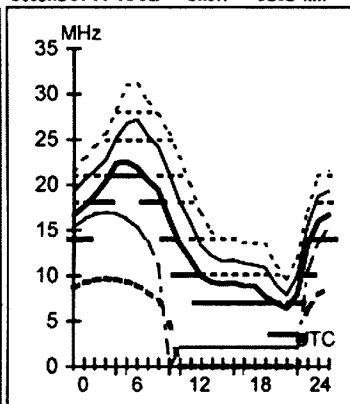
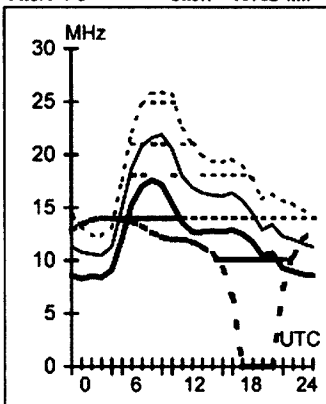
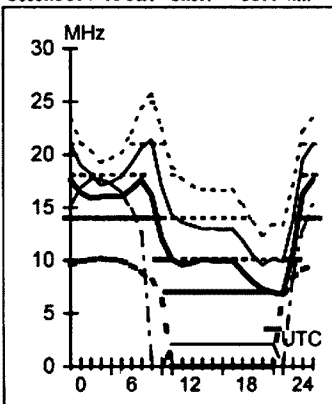
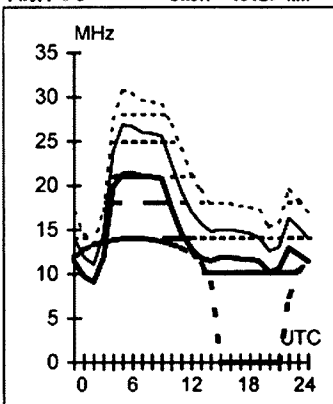

**Adelaide-Wellington**

**114**

**Brisbane-Rome**

**305**

**Canberra-Pretoria**

**231**

**Darwin-Seattle**

**44**

Second 2F13-17 2E Short 3214 km

First F 0-5 Short 16107 km

Second 4F4-7 4E0 Short 10824 km

First F 0-5 Short 12282 km

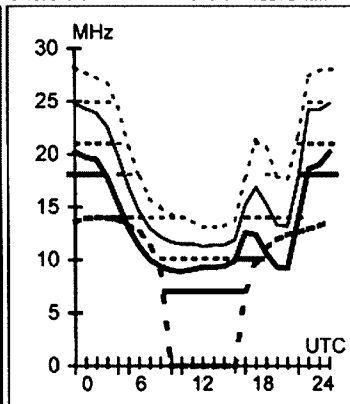
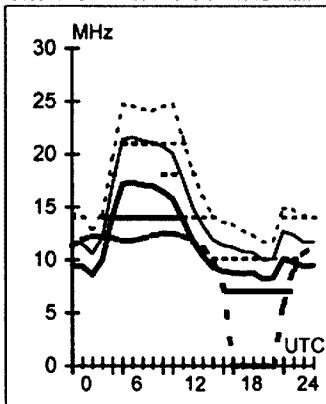
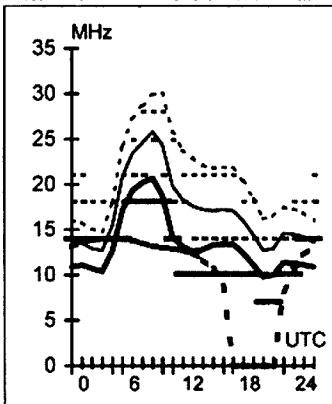
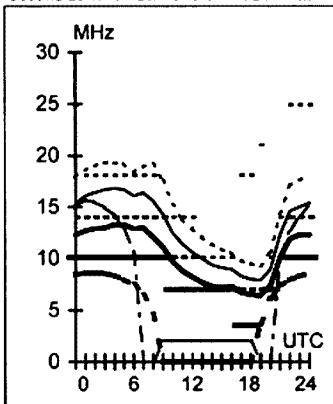

**Hobart-Cairo 278**    **Melbourne-Capetown 222**    **Perth-Johannesburg 248**    **Sydney-Barbados 119**

First F 0-5    Short 14236 km    Second 4F5-8 4E0    Short 10318 km    Second 4F8-12 4E0    Short 8315 km    First F 0-5    Short 16155 km

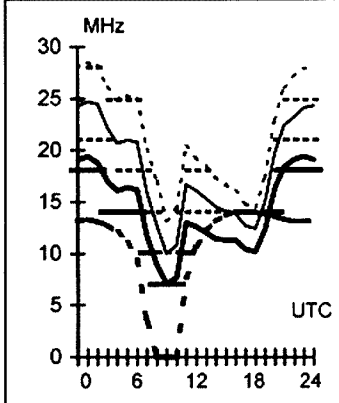
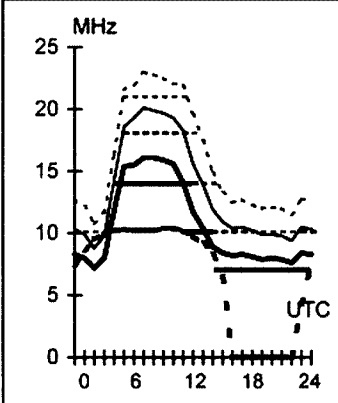
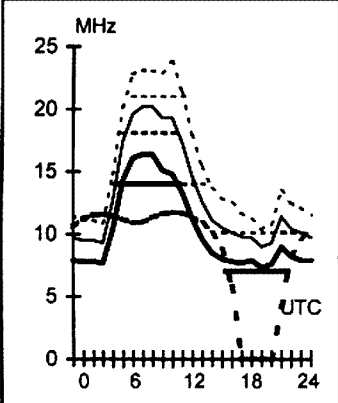
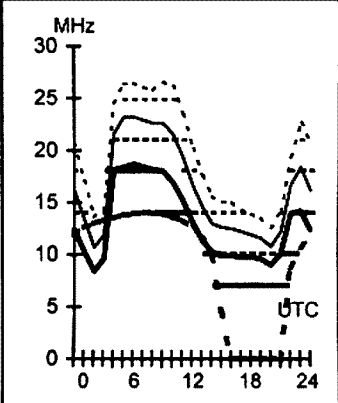

**Hobart-Chicago 72**    **Melbourne-Moscow 316**    **Perth-London 133**    **Sydney-Nairobi 255**

First F 0-5    Short 15576 km    First F 0-5    Short 14428 km    First F 0-5    Long 25543 km    First F 0-5    Short 12148 km

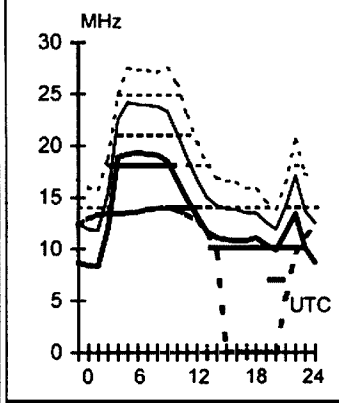
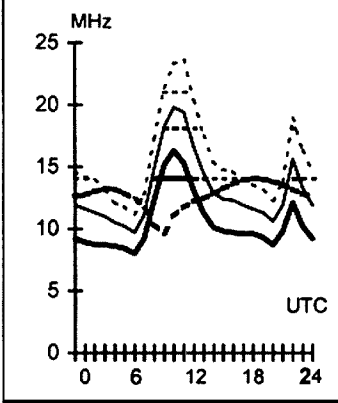
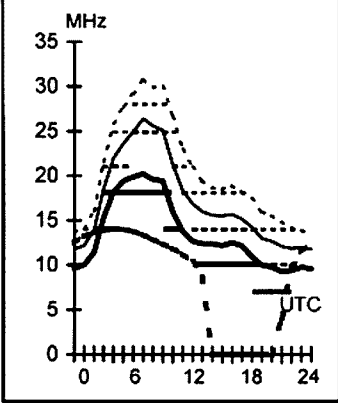
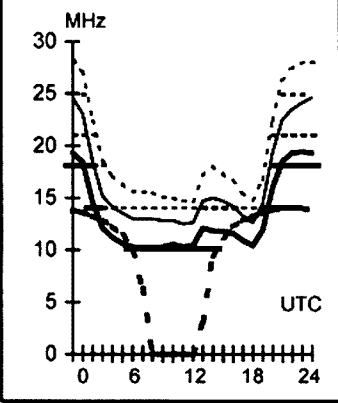

**Hobart-Oslo 138**    **Melbourne-Quebec 60**    **Perth-London 313**    **Sydney-Seoul 340**

First F 0-5    Long 23451 km    First f 0-5    Short 16903 km    First F 0-5    Short 14481 km    Second 4F8-12 4E0    Short 8325 km

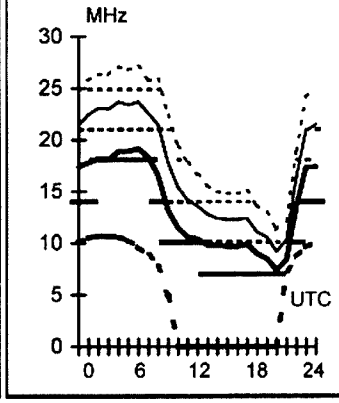
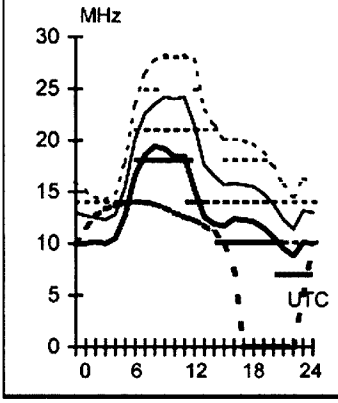
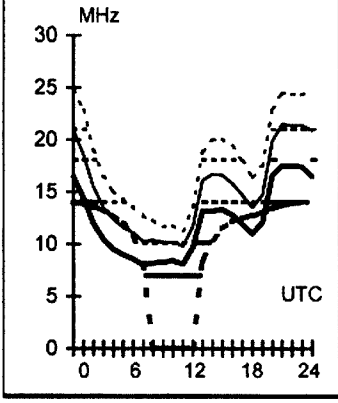
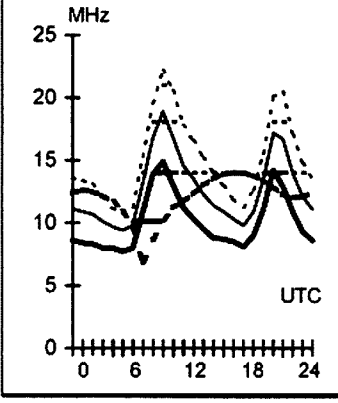

**Hobart-Santiago 149**    **Melbourne-Senegal 219**    **Perth-Tokyo 20**    **Sydney-Vancouver 45**

Second 4F4-5 4E0    Short 10688 km    First F 0-5    Short 16910 km    Second 4F4-8 4E0    Short 7923 km    First F 0-5    Short 12501 km

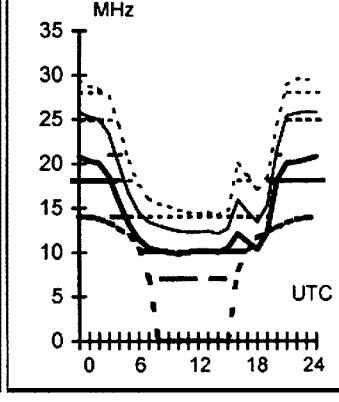
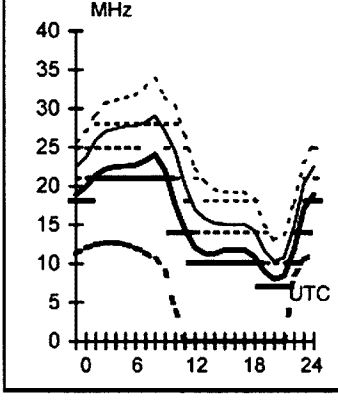
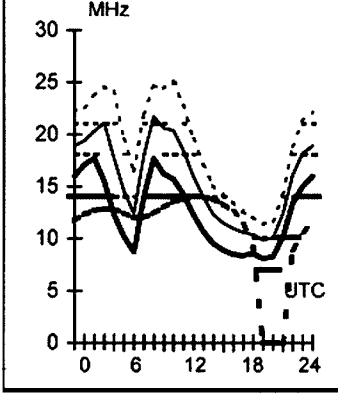
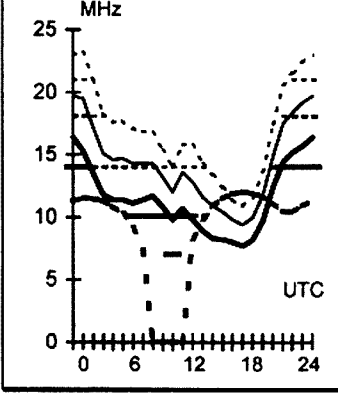

# Hamads classifieds **FREE**

## FOR SALE NSW

•3 stage tower with base plate, 17 m in height, needs winch wire, repainted and in good condition. Cannot use because of space restrictions, \$450 ono. Cushcraft ant, A50-3S, 6 m 3 element Yagi, brand new in box, never opened, \$295 ono. QRP PIUS, by Index Laboratories, HF 10m to 160m, including WARC Bands, 5 watt to milliwatt levels, in-built iambic keyer plus much more. Mint condition. Never used on air only into dummy load. \$950 ono, can send photos if required. Handheld carry case by Icom, LC-37, Brand new in wrapping, \$20. Bencher paddle, black base, good condition, \$75 ono. Mr S P Smith VK2SPS QTHR Phone 02 9456 0130, mobile 0415 559 784.

•Yaesu FT980 100 watt HF transceiver with books. Yaesu FC-700 antenna tuner. Kenwood DM-81 dip meter, \$300. Henry Brown VK2BIA Epping, Phone 02 9869 1980, email henrybrown@optusnet.com.au

•Moved retirement village! IC735 HF GWO S/N 42475, box, cable, man, mic \$600 ono. FT747GX HF GWO minor scratches S/N 8G070440 box, man, cable, mic \$550 ono. Matching FP757 heavy duty pwr supply \$150. Stan VK2EL 02 4233 2783 sbourke@shoal.net.au

Lots of manuals for all sorts of radios, some quite old. Also Amateur Radio, Amateur Radio Action, QST magazines, yours for the taking. Other 'stuff' too that you may like. David VK2BDT Goulburn 02 4821 5036 QTHR

## FOR SALE VIC

•Kenwood TR7200 Gil 2m \$50 ono. Russ White VK3MWR 03 5941 6998

•Philips FM 900, with J pole aerial and coax \$200. Yaesu FT 200 and power supply, manual

and notes \$100. Werner Wolfe 5 element tribander beam, not trapped, \$250 with fold over mast. Approx. 35 feet and stub tower, winch and S.S. cable \$70 plus 2 metre beam. Kantronics packet radio communicator 3 with 2 Compaq L.T.E. 386s 20 laptops and software etc. \$200 ono. VK3CMS email Otterburn@netspace.net.au. Phone 03 9749 2748.

•2 ele Quad cast alloy centre spider (commercially made) plus arms and fibreglass spreaders to build Quad for 20m (and 17/15/12/10 if required). The best of all amateur HF antennas \$200. Email: vk3dbd@dodo.com.au or phone 02 6027 0570

## WANTED VIC

•I am restoring an AN/TRC24 radio system and am looking for the following parts: Transmitter, T-302/TRC, power supply PP-685/TRC, receiver R-417/TRC, A band plug-in AM-1180/GRC and any other bits and pieces for this radio. John Eggington VK3EGG, email johne@telpacific.com.au, mobile 0409 234 672

## WANTED QLD

•Selsyn motors, 30 Magslip transmitter. Also prop pitch motor. Ken VK4VC QTHR. Phone 07 5441 1342, email kchiverton@flexinet.com.au

•For RAAF Museum Townsville. Donation of top cover, dial pointer, and companion transmitter for AWA C6770 receiver, any other military communication equipment, older type (FT101B etc) transceiver in GWO for our amateur radio station VK4KG. We have an AR7 receiver and No.11 set PSU available for swap. Wayne VK4WDM QTHR melrosew@optusnet.com.au ph 07 4788 8781

•FT 200 DEAD OR ALIVE! Looking for an FT 200 any condition Phone 07 4979 0329 or email vk4kkq@hotmail.com

•Set of ICOM rack mounting handles, with or without screws. Happy to pay good price. Ron VK4QM QTHR Phone 07 5488 0268, email jvette@bigpond.net.au

## WANTED SA

•Enquiry for HF radio with built-in power supply 240V operation. At this stage please advise price and condition. M Gell VK5ZLC QTHR

•Copy of manual and/or circuit for the 1960s Japanese receiver HCR-62. Brought into Australia by Electronic Industries Ltd and sold under the brand name E.I.L. and by Warburton Franki selling under the SANWA name. Malcolm Haskard VK5BA QTHR, Phone/Fax 08 8280 7192, email mhaskard@chariot.net.au

## FOR SALE TAS

•2C39BA valve new \$50, also one used \$30. 20 X 2SK1058 MosFETs \$9 ea. Continuously variable voltage auto transformer 270V max 4A \$120. Robert Milne VK7ZAL QTHR.

## THE WIA QSL COLLECTION REQUIRES QSLs

All types welcome, especially rare DX pictorial cards, special issue. Please contact the Hon Curator, Ken Matchett VK3TL, 4 Sunrise Hill Road, Montrose Vic 3765, tel. (03) 9728 5350

Do you sell amateur radio equipment regularly?

Or perhaps you provide a service to amateurs?

This sized ad, a '54', is a great way to let interested people know what you can provide.

Contact: John Nieman at Newsletters Unlimited  
captnnemo@ozemail.com.au

or  
03 9756 7797

## About hamads....

- Hamads may be submitted by email (preferred) or on the form on the reverse of your current Amateur Radio address flysheet. Please print carefully and clearly, use upper AND lower case.
- Separate forms for For Sale and Wanted Items. Please include name, address STD telephone number and WIA membership number if you do not use the flysheet.
- Deceased estates Hamads will be published in full, even if the ad is not fully radio equipment.
- WIA policy recommends that the serial number of all equipment for sale should be included.
- QTHR means the address is correct in the current

WIA Call Book.

- Ordinary Hamads from those who are deemed to be in general electronics retail and wholesale distributive trades should be certified as referring only to private articles not being re-sold for merchandising purposes.
- Commercial advertising (Trade Hamads) are pre-payable at \$25.00 for four lines (twenty words), plus \$2.25 per line (or part thereof), Forty word maximum, minimum charge of \$25.00. Cheques are to be made out to: WIA Hamads.
- Copy typed or printed clearly please, and received by the deadlines shown on page 1 of each issue of Amateur Radio.

Email: [newunltd@bigpond.net.au](mailto:newunltd@bigpond.net.au)

Postal: Newsletters Unlimited, PO Box 431, Monbulk Vic 3793. Fax: 03 9756 7031

### TRADE PRACTICES ACT

It is impossible for us to ensure that the advertisements submitted for publication comply with the Trade Practices Act 1974. Therefore, advertisers and advertising agents will appreciate the absolute need for themselves to ensure that the provisions of the Act are strictly complied with.

### VICTORIAN CONSUMER AFFAIRS ACT

All advertisers are advised that advertisements containing only a PO Box number as the address cannot be accepted without the addition of the business address of the box-holder or seller of the goods.

## ADVERTISERS INDEX

AEI.....	25
Andrews .....	16
Banelec .....	IFC
Com-an-tena.....	17
TET-Emtron .....	23
G & C.....	29
Icom .....	OBC
Maete tak .....	28
Ozgeer .....	22
Rippletech .....	55
TTS.....	8
Small ads.....	55
ARI .....	35
KVK Books .....	34
Winlink.....	35
www.vk3ej.com.....	55

## EMPLOYMENT

### PRODUCTION ENGINEER/TECHNICIAN

A production engineer/technician is needed for small-volume production of specialty telecommunications products for an award-winning export-oriented company. Duties will include liaison between R&D and production, prototyping and testing, maintaining up-to-date technical documentation, organising and supervising production, and quality control. Suits a hand-on quality-conscious person with a deep interest and good knowledge of radio electronics.

Please submit your resumé to:

Operations Manager  
WINRADIO Communications  
15 Stamford Road  
Oakleigh Vic 3166  
Tel: 9568 2568  
Fax: 9568 1377  
www.winradio.com

## Rippletech Electronics

New to radio or perhaps need a new challenge? Want to earn the WIA's new 5BDXCC award? With a Nally tower, an 80m sloper and a 40m rotary dipole you can get low band DXCC, even from your city lot! Want DXCC on the WARC bands? The WARC band dipole on placed above your traditional tribander will get you there.

Like to travel with your new micro radio? Grab a TZ-V-3 which packs down to only 1m long, fits in the boot or on a plane & assembles in minutes. Outperforms lossy super wideband designs.

TZ-1840	1:1 1kW 160-10m Balun (1.8- 40 MHz)	\$ 59.00
TZ-330-4	4:1 1 kW HF Balun (3 - 30 MHz)	\$ 59.00
TZ-SL8	80m Sloper (use tuner for 17 & 30m)	\$ 99.00
TZ-SL16	160m Sloper (fits in a suburban tot!)	\$ 110.00
TZ-D-4080	40m/80m Trapped Wire Dipole	\$ 176.00
TZ-V-3	10/15/20m Trapped Vertical	\$ 189.00
TZ-V-4	10/15/20/40m Trapped Vertical	\$ 289.00
TZ-RD-3	10/15/20m Trapped Rotary Dipole	\$ 199.00
	Vertical Radial kits (1 rad. per band)	\$ 33.00
TZ-V-3w	12/17/30m Trapped Vertical	\$ 279.00
TZ-RD-3w	12/17/30m Trapped Rotary Dipole	\$ 289.00
TZ-RD-40	17/40m or 20/40m Rotary Dipole	\$ 279.00
TZ-1000RC	FT-1000mp remote controller acc	\$ 33.00
	5th Order HPF TVI Filter (coming)	\$ 39.00
	Mobile whip base & Z bracket combo	\$ 11.00

Our trapped antennas use high Q, high isolation coaxial traps which are fully sealed and exhibit 40 dB of isolation at the resonance.

Need something special?

Give me a call and we'll see if we can meet your needs.

[www.rippletech.com.au](http://www.rippletech.com.au)



Contact Tony - VK3TZ  
0402 622 562 or email  
sales@rippletech.com.au

Mastercard, Visa and Bankcard accepted

[WWW.RADIOSPECIALISTS.COM.AU](http://WWW.RADIOSPECIALISTS.COM.AU)  
Yaesu authorized Dealership in Adelaide

**Shopfront sales and not a  
backyard shed**

243 Seacombe Road South Brighton SA  
**The Radio Specialists serving  
Adelaide.**

## AMIDON FERROMAGNETIC CORES

For all RF/electronic applications.

See our website for complete data on all cores including prices.

[www.catchnet.com.au/~rjandusimports](http://www.catchnet.com.au/~rjandusimports)

**RJ & US Imports**

PO Box 431, Kiama NSW 2533.

A 3.5" PC disk containing all data is available for \$5.00 incl. post.

Agencies

Active Electronics, Tas  
TTS Systems, Tyabb (VIC)  
Tower Communications, Perth  
Ozhelp Services, Brisbane

## RM Products Italy

are now available in Australia after the appointment of

**Hamak Electrical Industries Pty Ltd**

as distributor for RM products

Visit the Hamak website at

[Hamak.com.au](http://Hamak.com.au) for

**Linear amplifiers,  
Power supplies  
and accessories**

## JACKSON BROS JACKSON OF THE UK IS BACK

Highest quality products made by UK craftsmen

[www.jacksonbrothers.com.au](http://www.jacksonbrothers.com.au)

Full range now off-the-shelf in Australia.

Variable and trimmer capacitors, reduction drives, dials, ceramic standoffs

**CATALOGUES, PRICE LISTS AVAILABLE**

**CHARLES I COOKSON PTY LTD**

11-13 Port Rd  
Queenstown SA 5014

Tel: (08) 8240 3200 Fax: (08) 8240 3233

FreeFax 1800 673355 within Australia

Email: [sales@jacksonbrothers.com.au](mailto:sales@jacksonbrothers.com.au)

**ALL MAJOR CREDIT CARDS ACCEPTED  
SOLE AGENTS AUSTRALIA AND NEW ZEALAND**

## Tunable Loop Antenna enhances AM

### Reception

AM radio reception (530 to 1900KHz) enhanced. Reception where none existed before; works indoors, even in interference-polluted areas

High value — low cost.

Simple, no connections or batteries  
Ideal for touring, caravan, boat and fringe areas. Use anywhere.

[www.amradioantennas.com](http://www.amradioantennas.com)

[pkloops@bigpond.net.au](mailto:pkloops@bigpond.net.au)

Paul 0412 302 939

**PK's Loop Antennas**

## RADIOS:

	Unused	Used
Icom 706MK2G	Ring/email	\$1199
Icom 208H	\$ 550	\$ 499
Icom 910H	\$2199	\$1799
Icom 756PRO2	N/A	\$2799
Icom 756PRO3	\$4399	N/A
Icom 718	N/A	\$799
Kenwood TS2000	\$2699	\$2299
Kenwood TS2000X	N/A	\$2999
Kenwood TS480SAT	\$1699	\$1499
Kenwood TS480HX	\$1899	\$1699
Kenwood TS570DG	N/A	\$1249
Kenwood TMD700A	\$ 849	\$ 799
Kenwood THD7A	\$ 599	\$ 549
Yaesu FT8900R	\$ 649	N/A
Yaesu VX7R	\$ 529	N/A
Yaesu FT1000MP MKV	\$3599	\$2999
Yaesu FT847	N/A	\$1899
Yaesu FT857D	\$1249	\$1149
Yaesu FT897D	\$1299	N/A
Yaesu FT100D	N/A	\$1099

## ACCESSORIES:

Doss 40 AMP PSU	\$ 235	N/A
Icom AH4 ATU	\$ 499	\$ 449
Icom AT180	N/A	\$ 549
Tokyo HL700B HF Amp	\$1899	
Tokyo HL200V50 2M Amp	\$ 549	
MFJ 993 ATU	\$449	
Tokyo 2M 200W Amp	\$49	

Call / email re Heil and MFJ products

DOA warranty applicable on all items (ie if it is not 100% and in condx as described, a full money back g'tee applies)

**OTHER CURRENT MODELS AVAILABLE**

**ALL USED GEAR IN EXC CONDX WITH ORIGINAL BOX AND ACCESSORIES**

**PRICES SUBJECT TO CHANGE - CHECK WEBSITE FOR LATEST (OR RING)**

**WILL CONSIDER TRADE-INS - BUT MUST BE CURRENT MODEL GEAR (IE LAST 5 YEARS)**

Ship anywhere in VK/ZL (freight extra)

**ORDER ONLINE AT**

**WWW.VK3AJJ.COM**

**OR TELEPHONE PAUL ~**

**(03) 9018 9757**

**Mob. 0410 093 759**

**vk3ajj@iinet.net.au**

NB - I am not an authorised dealer for the radio companies listed above. These companies may refuse service on equipment sold by me - but other servicing options are available in the VK market.

Licensed Second Hand Dealer NO 10229 (Vic) (E&OE)

**WWW.VK3AJJ.COM - giving  
Aussie Hams a FAIR GO!**



# Directory

## The Amateur Service:

a radio communications service for the purpose of self training, intercommunication and technical investigation carried out by amateurs, that is, by duly authorised persons interested in radio technique with a personal aim and without any pecuniary interest. 1.56 ITU Radio Regulations.

The Wireless Institute of Australia represents the interests of all amateurs throughout Australia.

WIA membership fees are: ★ \$ 75 for full members ( F grade ), ★ \$ 70 for pensioners and students ( G and S grade ), and ★ \$ 50 for membership without 'Amateur Radio' ( X grade ). Payment direct to National office.

National Office	Contact	News Bulletin Schedule
10/229 Balaclava Road, Caulfield North VIC 3161, PO Box 2175 Caulfield Junction Vic 3161 Australia	Phone 03 9528 5962, Fax 03 9523 8191, 10am to 4pm daily, nationaloffice@wia.org.au http://www.wia.org.au	Subject to change. See www.wia.org.au follow National News prompts. Contact nationalnews@wia.org.au National VK1WIA news is distributed to all states.

Advisory Committees	Contact	News Bulletin Schedule
<b>VK1 Australian Capital Territory</b> VK1WX Alan Hawes VK1ZPL Phil Longworth VK1ET John Woolner VK1GH Gil Hughes	vk1advisory@wia.org.au	Sundays at 11.00 am VK1WIA 7.128, 146.950, 438.050 Canberra Region Amateur Radio Club Email newsletter will be sent on request to president@vk1.ampr.org
<b>VK2 New South Wales</b> VK2QV Chris Flak VK2XCD Chris Devery VK2BFN Adrian Clout	Phone 02 9689 2417 vk2wi@ozemail.com.au vk2advisory@wia.org.au	VK2WI - Sunday 1000 and 1930 hours local. 1.845; 3.595; 7.146; 10.125; 14.170; 28.320, 52.525; 145.600; 147.000; 438.525; 1273.500 megahertz. Plus regional relays. VK1WIA news included in the morning
<b>VK3 Victoria</b> VK3JJB John Brown VK3PC Jim Linton VK3APO Peter Mill	Phone 03 9885 9261 arv@amateurradio.com.au	VK1WIA, Sunday 11am and 8pm, 3.615 and 7.085 (LSB), 10.130 (USB), VK3RML 146.700, VK3RMM 147.250, VK3RMU 438.075.
<b>VK4 Queensland</b> VK4BY Don Wilchewski VK4ZZ Gavin Reibelt VK4KF Ken Fuller	Phone 07 3221 9377 vk4advisory@wia.org.au	VK1WIA, Sunday 9.0am via HF and major VHF/UHF rpters
<b>VK5 South Australia and Northern Territory</b> VK5OV David Box VK5APR Peter Reichelt VK5ATQ Trevor Quick	Phone 08 8294 2992 boxesdnm@lm.net.au peter.reichelt@bigpond.com vk5advisory@wia.org.au	VK5WI: 1843 kHz AM, 3.550 MHz LSB, 7.095 AM, 14.175 USB, 28.470 USB, 53.100 FM, 147.000 FM Adelaide, 146.600 FM Mildura, 146.900 FM South East, 146.925 FM Central North, 438.475 FM Adelaide North, ATV Ch 35 579.250 Adelaide. (NT) 3.555 LSB, 7.065 LSB, 10.125 USB, 146.700 FM, 0900 hrs Sunday. The repeat of the broadcast occurs Monday Nights at 1930hrs on 3585kHz and 148.675 MHz FM. The broadcast is available in 'Realaudio' format from the website at www.sant.wia.org.au Broadcast Page area.
<b>VK6 Western Australia</b> VK6NE Neil Penfold VK6XV Roy Watkins VK6OO Bruce Hedland-Thomas	Phone 08 9351 8873 http://www.vk6.net/ vk6advisory@wia.org.au vk6ne@upnaway.com vk6xv@bigpond.net.au	VK6WIA: 146.700 FM(R) Perth at 0930hrs Sunday relayed on 1.865, 3.564, 7.075, 10.125, 14.116, 14.175, 21.185, 29.120 FM, 50.150 and 438.525 MHz, Country relays 3.582, 147.200 (R) Cataby, 147.350 (R) Busseton, 146.900 (R) Mt William (Bunbury), 147.000 (R) Katanning and 147.250 (R) Mt Saddleback. Broadcast repeated on 146.700 at 1900 hrs Sunday relayed on 1.865, 3.564 and 438.525 MHz : country relays on 146.900, 147.000, 147.200, 147.250 and 147.350 MHz.. Also in "Realaudio" format from the VK6 WIA website
<b>VK7 Tasmania</b> VK7ZAX Phil Corby VK7DG Dale Barnes VK7KK Reg Emmett	Phone 03 6234 3553 vk7advisory@wia.org.au phil.corby@tassie.net.au vk7dg@wia.org.au regemm@ozemail.com.au	VK1WIA Sunday 9am on VK7WI network: 3.570MHz LSB, 146.700 MHz FM (VK7RHT South), 53.825MHz FM (VK7RAD South), 147.000MHz FM (VK7RAA North), 146.750 FM & 53.825MHz (VK7RNV North West), 146.625 MHz FM (VK7RMD North West), UHF CB Channel 15 (Hobart) and 27MHz CB - 27.225MHz LSB (Hobart). Followed at 9:30am with VK7 Regional News Broadcast also on 7.090MHz LSB & 14.130MHz USB

### Notes

1. Only three members of the state advisory committees are listed.
2. All listings are preliminary. They will be updated each month as required.
3. Membership application forms are available from the WIA web site www.wia.org.au or the national office address above.

# Urunga!



Photos from the 2005 Urunga Convention. Held on the Easter weekend each year just south of Coffs Harbour, the Convention has fox-hunting as a major focus. Find further details at the Convention website at: <http://users.tpg.com.au/goldy2/>

# ICOM's Newest amateur radios

Amateur



## IC-7000 HF/VHF/UHF All mode Transceiver

- 100W HF/50MHz, 50W/2m, 35W/70cm • I.F DSP for improved noise rejection • Digital IF filter for Dial up selectivity • 2.5" TFT colour display for bright easy reading • Remote control DTMF Mic for fingertip control & IRLP access PLUS • digital voice storage • 2 mode band scope • Multi function meter 7 SWR display • Built in RTTY modulator

## IC-P7A VHF/UHF (2m/70cm) Dual-band FM Handheld Transceiver

- Ultra compact body, light weight 47x81x28mm, 160g • Mini-power VHF/UHF dual bander with wideband receiver 0.495-999.990MHz • 1800mAh large capacity Li-Ion battery allows 20hours operating time (Tx:Rx:Standby=5:5:90) • 1.5W output power on 2m & 1W output power on 70cm • Simple operation • 1000 memory channels with flexible memory bank system • Oversize LCD for clear display of function information



ICOM

ICOM 75

Call your local ICOM dealer [www.icom.net.au](http://www.icom.net.au) or (03) 9549 7500



Volume 74 no 4

April 2006

# Amateur Radio



The magazine for **AUSTRALIAN** radio amateurs

\$6.50  
incl GST

**Hayden Honeywood**

**VK7HAY**

*reviews*

**The**

**Diamond**

**X-200A**

**antenna**

- ★ **Build a super-compact portable 20 W auto-tuner for HF and 6 metres**
- ★ **Calculating characteristic impedance ( $Z_0$ ) of unknown twin cable**
- ★ **Broadband Powerline Communications: ~~Where~~ where are we now?**



# BENELEC

# YAESU

## FTDX9000 Series... Now All Available!



### FTDX9000 Contest 200 W Version HF/50 MHz

**Configurable to you.....your needs**

#### Options:

- RXU-9000 Dual Receive Unit
- VRF-9000 Sub band VRF Unit
- MTU-160 RF u-tuning Unit A (160m band)
- MTU-80/40 RF u-tuning Unit A (80m/40m band)
- MTU-30/20 RF u-tuning Unit A (30/20m band)
- DMU-9000 Data Management Unit
- TFT-9000 TFT Display Unit

**Base Price \$9,428.60**



Dual Meters + LCD, VRF Installed in Main Receiver, Extra Key and Headphone Jacks, Internal Switching Power Supply.

### FTDX9000D 200 W Version HF/50 MHz

#### Options:

- Amber Screen **\$17,279.20**
- Blue Screen **\$17,560.20**



Large TFT Display, Built-in Memory Board, Main and Sub Receiver VRF, Full Dual RX, "μ" Tuning (3 modules) Installed, Internal Switching Power Supply.

### FTDX9000MP 400 W Version HF/50 MHz

**Configurable to you...  
....your needs**

#### Options:

- MTU-160 RF u-tuning Unit A (160m band)
- MTU-80/40 RF u-tuning Unit A (80m/40m band)
- MTU-30/20 RF u-tuning Unit A (30/20m band)
- TFT-9000 TFT Display Unit

**Base Price \$18,682.10**



Dual Analog Meter Sets, LCD Display, Memory Card Installed, Main and Sub Receiver VRF, Full Dual RX, Switching External Power Supply/Twin Speaker Enclosure.

**Benelec Approved Amateur Transceiver Dealers**

**All Price includes GST**

**NSW**  
Andrews Communications Systems  
Tel: 02 9636 9060 lee.andrews1@bigpond.com

**Newcastle Pro Sound & Communications**  
Tel: 02 4965 6899 sales@newcastleprosund.com.au

**Action Communications**  
Tel: 02 4732 2788 action@pnc.com.au

**VIC**  
Strictly Ham P/L  
Tel: 03 9729 7656  
vk3my@bigpond.net.au

**G & C Communications**  
Tel: 03 5996 3298  
gcomm@bigpond.net.au

**Qld**  
Kyle Communications  
Tel: 07 3857 4400  
mark@kyle.com.au

**Ozhelph Services**  
Tel: 07 3273 7263  
sales@ozgear.com.au

**SA/NT**  
POSNAV Systems P/L  
Tel: 08 8342 4700  
brenton@posnav.com.au

**WA**  
Bushcomm Pty Ltd  
Tel: 08 9296 0496  
bushcomm@bigpond.com

**www.benelec.com.au**



# Amateur Radio

Volume 74, Number 4  
April 2006

The Journal of the Wireless  
Institute of Australia  
ISSN 0002-6859

## Editorial

Editor: Peter Freeman VK3KAI  
editor-armag@wia.org.au

Technical Editor: Peter Gibson VK3AZL

### Publications Committee Members

Brenda Edmonds VK3KT  
Ron Fisher VK3OM  
Evan Jarman VK3ANI  
Tom Potter VK3UBS  
Bill Roper VK3BR  
Ernie Walls VK3FM

Circulation enquiries: wia@wia.org.au

### Submission of material to Amateur Radio Magazine

General and Technical articles to Secretary  
AR Publications Committee  
3 Tamar Court  
Mentone VIC 3194  
or armag@wia.org.au

Columns and Letters to the Editor to Editor  
AR Magazine  
PO Box 273  
Churchill, Vic 3842  
or editor-armag@wia.org.au

### Hamads to

"Hamads" Newsletters Unlimited  
PO Box 431  
Monbulk VIC 3793  
Fax 03 9756 7031  
newunltd@bigpond.net.au

### Advertising

All enquiries to Newsletters Unlimited  
PO Box 431  
Monbulk Vic 3793  
Phone: 03 9756 7797  
Fax: 03 9756 7031  
newunltd@bigpond.net.au

### Registered Office

10/229 Balaclava Road,  
Caulfield North VIC 3161  
Australia  
Phone: 03 9528 5962  
Fax: 03 9523 8191

## Production Deadlines

Advertising booking and articles for publication 10th of preceding month.

Hamads and advertising material deadline 18th day of preceding month

The contents of Amateur Radio are Copyright  
Wireless Institute of Australia © 2006

## GENERAL

WIA National QSL Collection.....	16
<i>Ken Matchett VK3TL</i>	
Old Timers turn 30.....	17
<i>Ian Godsll VK3JS</i>	
The man and his shack ~ Guy, VK2KU.....	24
<i>Peter Freeman VK3KAI</i>	
Broadband Powerline Communications: Where are we now?.....	26
<i>WIA EMC Group</i>	

## TECHNICAL

The Elecraft T1 Kit .....	5
<i>Chris Meagher VK2LCD</i>	
Calculating characteristic impedance (Zo) of unknown twin cable.....	7
<i>Ron Sanders VK2WB</i>	
Observations on VHF antenna height and other VHF path curiosities .....	8
<i>Felix Scerri VK4FUQ</i>	
Try EchoLink yourself.....	10
<i>Paul van der Weegen VK2EX</i>	
The VK5BR-X antennas.....	11
<i>Lloyd Butler VK5BR</i>	
Review of The Diamond X-200A antenna .....	18
<i>Hayden Honeywood VK7HAY</i>	
Voltage Conditioners for IC-703 and FT-817 (Technical abstracts) .....	22
<i>Peter Gibson VK3AZL</i>	

## COLUMNS

ALARA.....	32	News from.....	36
AMSAT.....	46	VK5.....	36
Beyond our shores.....	33	VK3.....	37
Contests .....	40	VK2.....	38
Directory.....	56	VK7.....	38
DX News & Views .....	34	Over to you.....	50
Editorial comment .....	2	Silent key.....	23
Hamads .....	54	Spotlight on SWLing .....	51
HF predictions .....	52	Technical Abstracts.....	22
Know your 2nd hand equipment.....	20	VHF/UHF – an expanding world .....	48
		WIA comment.....	3
		WIA news.....	4

## Our Cover this month

The cover photo shows Hayden VK7HAY after having installed his Diamond X-200A antenna onto the mast. See Hayden's review of the equipment page 18.

*All should note the use of appropriate safety equipment when climbing a tower.*

### Contributions to Amateur Radio

Amateur Radio is a forum for WIA members' amateur radio experiments, experiences opinions and news. Manuscripts with drawings and/or photos are always welcome and will be considered for publication. Articles on disc or email are especially welcome. The WIA cannot be responsible for loss or damage to any material. A pamphlet, How to write for Amateur Radio is available from the National Office on receipt of a stamped self-addressed envelope.

### Back Issues

Back issues are available directly from the WIA National

Office (until stocks are exhausted), at \$4.00 each (including postage within Australia) to members.

### Photostat copies

When back issues are no longer available, photocopies of articles are available to members at \$2.50 each (plus an additional \$2 for each additional issue in which the article appears).

### Disclaimer

The opinions expressed in this publication do not necessarily reflect the official view of the WIA and the WIA cannot be held responsible for incorrect information published.

## Amateur Radio Service

A radiocommunication service for the purpose of self-training, intercommunication and technical investigation carried out by amateurs; that is, by duly authorised persons interested in radio technique solely with a personal aim and without pecuniary interest.

## Wireless Institute of Australia

The world's first and oldest National Radio Society  
Founded 1910

Representing

The Australian Amateur Radio Service

Member of the

International Amateur Radio Union

Registered Office of the WIA

10/229 Balaclava Road, Caulfield North Vic 3161

Tel: (03) 9528 5962 Fax (03) 9523 8191

email: nationaloffice@wia.org.au

http://www.wia.org.au

All mail to

PO Box 2175 Caulfield Junction VIC 3161

Business hours: 10am – 4pm weekdays

### National Office staff

Judith Oliver	Office Coordinator
Emma Trebilco	Examinations Officer
Brenda Edmonds	Office Volunteer

### Board of Directors

President	Michael Owen	VK3KI
Vice-President	Ewan McLeod	VK4ERM
	Robert Broomhead	VK3KRB
	Glenn Dunstan	VK4DU
	Trevor Quirk	VK5ATQ
	Ted Thrift	VK2ZARA
	Phil Wait	VK2DKN
Secretary	Chris Jones	VK2ZDD
Treasurer	David Pilley	VK2AYD
Assistant Treasurer	Bruce Bathols	VK3UV

### Coordinators

AMSAT	Graham Ratcliff	VK5AGR
ARDF	Jack Bramham	VK3WWW
Australian ARIS	Tony Hutchison	VK5ZAI
Awards	Mai Johnson	VK6LC
Contests	Ian Godsil	VK3JS
John Moyle Memorial		
FD Manager	Denis Johnstone	VK3ZUX
Editor "AR"	Peter Freeman	VK3KAI
EMC/EMR	Gilbert Hughes	VK1GH
	Keith Malcolm	VK1ZKM
Standards	Gilbert Hughes	VK1GH
	David Wardlaw	VK3ADW
	John Bishop	VK2ZOI
	John Martin	VK3KWA
	t.b.a.	
NTAC		
Historian		
IARU Region 3		
Liaison Officer	Neil Penfold	VK6NE
Intruder Watch	Glenn Dunstan	VK4DU
International		
Travel Host	John Miller	VK3DJM
ITU Conference and study group		
	Gilbert Hughes	VK1GH
	David Wardlaw	VK3ADW
	Keith Malcolm	VK1ZKM
QSL Curator	Ken Matchett	VK3TL
QSL Manager (VK9/0)	Neil Penfold	VK6NE
Videotapes Curator	VK2 Division	
Webpage co-ordinator	Colin Thompson	VK2TRC
WICEN	John Weir	VK3ZRV

### ACA Liaison Team

Gilbert Hughes VK1GH  
Keith Malcolm VK1ZKM  
Peter Mill VK3APO  
Glenn Dunstan VK4DU

## Editorial comment

Peter Freeman VK3KAI

March has been a busy month for many. Many clubs, smaller groups and individuals made the effort to establish stations in the field to participate in the John Moyle Memorial Field Day. Did you participate, even if only to give those in the field some points through your contact/s? If you did not participate, consider planning ahead so that you can "enter the fray" next year. Moving some of the radio equipment out into the field for a contest often brings interesting insights. It certainly improves your preparedness for unexpected emergencies, such as the devastation wrought in Innisfail and surrounding region by Cyclone Larry. I am sure that you will all join me in wishing everyone involved a prompt recovery, even if it will take weeks or months.

As noted in the VK3 notes, there have been many stations using the AX prefix for the month of March, in celebration of the Melbourne Commonwealth Games. Amateur Radio Victoria members have been operating the special event call signs of AX3MCG and AX3GAMES. I am sure that the QSL cards will be in great demand from around the world.

The magazine team is planning something special for next month, as a trial. I will not reveal details now, but expect to see some special coverage of the Commonwealth Games stations and John Moyle Memorial Field Day activities.

### Our WIA

One important aspect of the operations of our WIA is often overlooked by many people with whom I have interacted to date. Much of the work of the WIA is conducted by volunteers. Our organisation is not like those of the ARRL or the RSGB, both of which are much larger organisations with paid staff members in addition to the volunteers involved. The WIA has only a very small paid staff. The rest of the work is done by volunteers. Many of the team are undertaking full time paid jobs and contributing to our hobby in their precious spare time. This aspect applies to the organisation at many levels, including the Publications Committee. As a result, some issues may take longer to resolve than if we had many paid staff members.

### Magazine production

This issue of AR represents the third that I have guided as Editor. It has been an

interesting experience, getting up to speed and attempting to meet the deadlines. I have received several enquiries from authors regarding when their contribution will appear in this journal. I thought that perhaps you all may be interested in how the whole process of production is organised.

Authors interested in contributing should firstly download the Instructions to Authors document from the AR section of the WIA website (<http://www.wia.org.au/armag/index.php> – look for the link on the left hand side of the page). This document will outline how you can make our job easier through the following stages. Then prepare your article and submit the document and any images to the Secretary of the Publications Committee. Receipt of the article will be acknowledged – you have reached the first milestone.

The article will then be passed on to either myself or to one of the Technical Editors for consideration. At this stage, several things could occur: the article may be rejected as unsuitable; it may require clarification from the author, or minor editing. Once the Technical Editor has approved the item, it is returned to the Secretary for the next stage of registration and the preparation of images and drawings into a form suitable for publication.

Once these steps are completed, the article is added to the pool of available articles and sent on to me for consideration. I usually attempt to publish first those articles that have been in the system the longest, although there are a variety of reasons why an article may be given a fast track. The whole process may take several months.

Each month, I will choose several articles from the pool and forward them to our publication house for inclusion in the next month's issue. The article is prepared into the final layout and returns to myself and some other team members for proof reading. Once finalised, the whole of the issue is forwarded to the printer. About 2 weeks later, the magazine appears in your mail box, all going well.

Until next month, may you all enjoy your radio activities.

Regards  
Peter  
VK3KAI

## What is an Amateur?

It is a question worth asking, because every now and then one hears someone say that a person is not a true amateur or that is not true amateur radio.

Since 1947 the International Telecommunications Union has been a specialised agency of the United Nations. However, the ITU is very much older than the United Nations, first formed as the International Telegraph Union in 1865 following the signing of the International Telegraph Convention in Paris intended to facilitate the international interconnection of the telegraph.

The first International Radiotelegraph Convention was signed in 1906 in Berlin.

In 1927 the International Radiotelegraph Conference in Washington D.C. allocated bands to various radio services, including the amateur service, and annexed what was called General Radio Regulations to the International Telecommunications Convention. Article 1.[14] of the General Radio Regulations defined an "amateur station" as:

*"A station used by an "amateur", that is, by a duly authorised person interested in radio technique solely with a personal aim and without pecuniary interest."*

Then at the Madrid Conference in 1932, the 1865 International Telegraph Convention and the 1906 International Radiotelegraph Convention were combined to form the International Telecommunication Convention and the International Telegraph Union became the International Telecommunications Union, since then the international organisation responsible for the international regulation and coordination of the radio frequency spectrum.

It is interesting to reflect on how much has changed in the use of the radio frequency spectrum in the 79 years since the Washington Conference.

How much it has changed is illustrated by the fact that the highest frequency band allocated to the amateurs then was 56,000 to 60,000 kilocycles.

It is trite to say that amateur radio is as old as radio itself.

While the technology has changed, how much has 'what is amateur radio' changed?

Since 1927 the General Radio Regul-

ations, now the Radio Regulations, have grown significantly, and the need to regulate new uses, such as higher frequencies and the frequencies and positions of satellites have seen the Regulations grow ever more complex.

But the definition of "amateur service" is not startlingly different.

Today that definition

*Amateur Service: A radio-communication service for the purpose of self-training, intercommunication and technical investigations carried out by amateurs, that is, by duly authorised persons interested in radio technique solely with a personal aim and without pecuniary interest.*

The essential elements of the 1927 definition, the concept of a *duly authorised person interested in radio technique solely with a personal aim and without pecuniary interest* has remained part of the definition since the first international regulation of the amateur service.

Inserted into the definition in the conferences after the Second World War was the purposes of the amateur service, *self-training, intercommunication and technical investigations.*

I think the specification of the purposes of amateur radio is very important. It reminds us that learning, the "self training" is as much a part of amateur radio as is "intercommunication", the simple art of communicating, which in turn is as much a part of amateur radio as is "technical investigation".

Amateur radio is not only the hobby of an elite few who have the highest technical qualifications. It is the hobby of those who are fascinated by the art of communicating, be it in a contest, recognised by an award, or simply talking across town or across the world. It is the hobby of those who see it as a means of learning, and of applying what they are learning.

What amateurs do must change as the means of using the spectrum change now interfacing with the Internet.

When the International Amateur Radio Union's Future of Amateur Radio Committee published its 17 page Discussion Paper in April 1996, seeking to formulate an international position to the international regulation of the

amateur service and inviting comments from societies and individuals, among very many other issues that it addressed, it offered the suggestion that Morse Code should cease to be a treaty requirement for the qualification of an amateur to operate below 30 MHz. That resulted in an incredible number of individual responses and even "petitions", arguing that the removal of Morse code as an essential element of the qualification of radio amateurs was striking at the very heart of amateur radio, and was totally misconceived.

Others saw Morse code as a barrier to entry, technically no longer relevant.

Yet without the Morse code requirement, and with many new initiatives to attract new amateurs around the world, in Australia with the introduction of a new entry level licence, the Foundation licence and, currently, the revision of the regulation of the amateur service to encourage the better use of the Internet by amateurs, we are at last seeing a new wave of people joining the ranks of radio amateurs.

So, what is an amateur?

Since "amateur" was first formally defined in a 1927 international treaty, better defined after World War II, 'what is an amateur' has not changed at all.

When first introduced into our country, the "Z" call was as much an amateur as the "Full Call", even though then as a "Z" call I knew that some "Full Calls" didn't think so. Today, the Foundation licensee is as much an amateur as the Advanced licensee.

Let us always remember that the essential elements of the most elegant and the most important definition of what we are covers our different interests and different levels of qualification, with that most important element of self-training encouraging all of us as we enter at one level to aspire to a higher level, but always as someone "interested in radio technique solely with a personal aim and without pecuniary interest."

Or, to put it another way, I know that amateur radio is that aspect that interests me, but I have to remember that amateur radio is also what interests you.

## ACMA issues Foundation licence number 250

During the week of February 27, four short months since its introduction, the Australian Communications and Media Authority, ACMA, has issued the 250th Australian Foundation licence. This period includes the Christmas break when there was very little training and assessment activity.

The WIA is currently processing assessments at a rate averaging around 40 each week and at the end of the week commencing February 27, had processed just over 400 packs. So we can look forward to seeing ACMA issue the 500th licence in the not too distant future.

Meanwhile, the number of clubs offering training and assessment for the Foundation licence continues to grow and the WIA has received a number of applications for Assessor training from members of clubs yet to commence Foundation licence training.

Training of additional Assessors will commence shortly and on completion the WIA will have around 200 qualified assessors.

## A Foundation Licence course in Melbourne with room for some more candidates

The Frankston and Mornington Peninsula Amateur Radio Club (FAMPARC) in the Bayside area of Melbourne, are now offering places for their April Foundation Licence Course. The course will have a duration of 4 weeks and an exam day on the following Sunday. Start date is Thursday, April 6th at 7.30pm.

The club was offering only 10 places at its excellent learning facilities at St Leonards College, Patterson Lakes.

So if you are interested in studying for your foundation licence and/or becoming part of a great amateur radio club, contact Peter VK3TQ on BH (03) 9644 5733 or 0438 093 318 mobile before 8.30pm.

## Commonwealth Games Special Event Stations

On air for the entire month of March were special event stations - AX3GAMES and AX3MCG - being activated by members of Amateur Radio Victoria in celebration of the Melbourne Commonwealth Games. A roster of about a dozen on Phone and CW have volunteered for AX3GAMES, while AX3MCG is being operated by top DXers Peter VK3QI on CW and David VK3EW on phone.

While AX3GAMES and AX3MCG are the only special event call signs issued by the ACMA, it has also released the alternative AX prefix for use by all VK stations during the games period 1-31 March.

## TransACT announces BPL trial in Canberra

Howard Dahdah, of PC World, reported this week that Canberra telecommunications provider TransACT is to commence a trial of BPL.

Dahdah reports: "TransACT CIO and general manager Carsten Larsen said the company is looking at delivering the Broadband over Power Lines (BPL) service to office buildings, because many of the houses and medium-density units in Canberra and Queenbeyan already have TransACT's fibre cables running past them".

"The first test site for the service, which will deliver download speeds of 200Mbs on a shared network, will be TransACT's own head office, Larsen said. "The engineering is being drawn up. If we go from here to a connected environment, we can take the lessons from here to a live site. We have to feel all the bumps and problems with it. But we will give it a push and see if it works."

Should the trial prove successful, TransACT propose a commercial rollout later this year.

## WIA Awards Office is moving

Malcolm K. Johnson, VK6LC, WIA Awards Manager, advises that the WIA Awards Office is moving to a new larger office.

The transitional period will be between 1 March and 15th April 2006.

All postal, email applications and updates will be responded to but not processed for this period, but if you have not received any response by the 15th April please re-submit your request.

Mal apologises for any delays.

## Hams help out following mud slide

RSGB reports that radio amateurs have helped coordinate rescue operations after a devastating mud-slide on the Philippine island of Leyte buried an entire village.

More than 1,800 people are thought to have died when the village of Guinsaugon, on the southern part of Leyte, was engulfed by mud on 17 February following a week of torrential rain and a small earthquake. The International Radio Emergency Support Coalition (IRESC) has been supporting the relief effort by providing communication links between the disaster area and the International Red Cross. The IRESC specialises in connecting up traditional ham radio systems - HF transceivers and VHF/UHF repeaters - with Voice over Internet Protocol technology over the Echolink network.

ar

## Errata:

In the review of the book *Outback Radio from Flynn to Satellites* by Rodney Champness, Rodney's callsign was incorrectly cited in the heading text. His correct callsign is VK3UG. Interested readers should note that Rodney had articles on *The development of radios in the Flying Doctor Service* published in the September and October issues of AR. Please note that the book is available from Rodney (QTHR) for \$39.99 plus \$8 postage within Australia.

# The Elecraft T1 Kit

## Build a super-compact portable 20 W auto-tuner for HF and 6 metres

Chris Meagher VK2LCD

For some time since building an Elecraft K2 transceiver I had been looking around for a suitable small tuner for backpacking and other low-power field operations, that would suit both the K2 and my FT-817. At first, I imagined buying a ready-built manual tuner. Another possibility considered was building a unit, from scratch or from a kit, with a Z-match or reversible L-match the most likely options.

When the Elecraft T1 20 W auto-tuner kit was launched in 2005, it didn't take long to decide this was it; I already knew first-hand about the high standard of Elecraft's design, parts, instructions and back-up. The idea of an auto tuner was something I hadn't considered at first, but it seemed to make sense with the advantage of speed, and built-in power and SWR indication. Also in the equation was a keenness for kit construction – bags of parts and the smell of resin!

### Construction

The kit arrived from the US via the post in five days and, thankfully, no duty or GST to pay. On the same evening I began the recommended checking of the parts inventory and everything was there. The first step is to solder the BNC connectors to the main board. This requires some instant heat, and for the job I used an 80 W iron with chisel bit.

The rest of the soldering is mostly detailed work and the boards are quite densely packed with components. A fine bit, temperature-controlled iron is ESSENTIAL. Don't even think about working without one. Also, small diameter solder is needed. I used 5% silver Multicore brand, 0.71 mm diameter.

There are some surface mount devices but these were not a problem as they come pre-installed. The only component requiring static protection is the micro-controller. The boards are double-sided with all holes plated through. You need to work fastidiously, and double check the identity and placement of components. They can be very difficult to remove once soldered. I used a magnifying visor throughout the assembly and a hand lens to check in fine detail for shorts and cold joints. Of

course, there weren't any!

There are two boards. The main one holds seven inductors and seven capacitors for the L-C network, 15 relays, a 28-pin micro-controller, the SWR bridge and ancillary components. The relays are latching, so that power is only consumed during tuning. This allows the unit to run easily from a 9 V battery. The small control board plugs in piggy-back on the main board and has the control switches and indicator LEDs.

The only problem I encountered was a modification by Elecraft to beef-up the SWR bridge. This required replacement of two ¼ watt resistors with 1 watt. Fortunately I had only put one of them in before I found out about this, but unsoldering was something I didn't like. The modification also involved using two stacked toroid ferrites instead of one, and this part was fiddly to fit into a tight space. Patience and perseverance paid

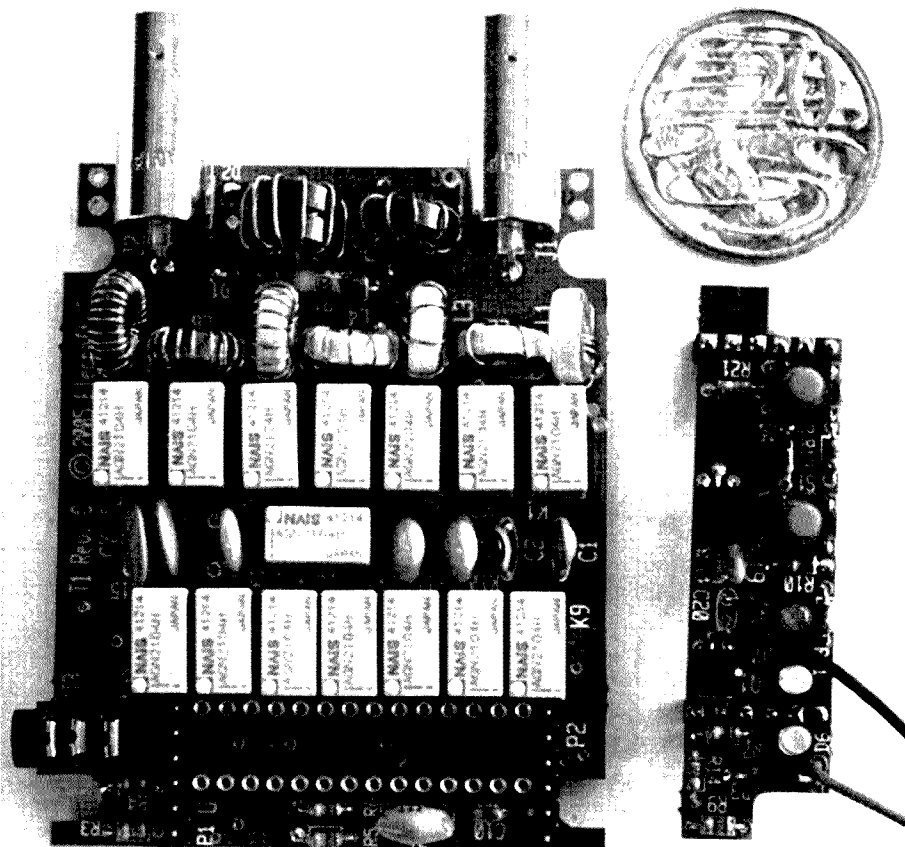

Photo 1 - T1 circuit boards with the processor not installed. The small board plugs into the main board over the top of the processor.



Photo 2 - The completed T1 installed in its case. The battery fits into a compartment in the back.

off in the end and, after three sessions of building, there it sat in one piece on the bench.

### Testing

The detailed assembly manual provides tests at various stages to confirm all is well. Once the kit is completed, the micro-controller is able to test the L-C settings and relay function with a procedure which reports to you in Morse code, either visually via the LEDs or with a Morse-encoded RF signal re-routed back into the transceiver. Amazing!

The moment of truth: insert the battery and start the test procedure. My unit worked first

go, no hitches. I connected the G5RV and the T1 tuned across the HF range with little effort. The table below summarises the results.

R and X are the radiation resistance and reactance of the untuned antenna, measured with an MFJ259B analyser. (+X indicates inductive and -X indicates capacitive reactance.)

Freq MHz	SWR un-tuned	R ohms	X ohms	SWR tuned	Time to tune (secs)
3.600	1:3.7	69	-90	1:1.2	2
7.100	1:2.8	23	-32	1:1.1	2
14.100	1:1.6	88	0	1:1.2	3
21.100	1:4.7	9	+4	1:1.1	4
28.400	1:2.4	24	-75	1:1.1	2

The T1 holds settings in its memory, and will tune much faster on re-tune providing that it sees an SWR of 1.5 or less. This is very handy when re-tuning within the same band as the time taken is usually less than a second. You can set the memory tune threshold at an SWR

of 2 to speed up tune with very touchy antennas. A power level of 0.5 to 1 watt is fine to initiate an auto-tune, using carrier or sideband.

### Overall assessment

While the T1 tuner is not a particularly complicated kit, it is definitely not for the inexperienced or hasty person. But for the keen kit builder and low power portable operator, a 20 W tuner measuring 121 x 63 x 20 mm and weighing less than 160 grams with the battery installed is indeed an attractive proposition.

Don't be put off by the idea of winding toroid inductors. It seemed to me a bit daunting at first but, after winding a few of them, it became familiar and almost therapeutic.

The component quality is very high, in keeping with the standard set by Elecraft with the K2 transceiver. The plated-through circuit board is a beautiful thing. As with all kits, once you've built it, the construction excitement and challenge is gone, but the T1 is likely to continue to reward your efforts with its superbly implemented user interface. Everything is there on the front panel, including the basic operating instructions. Usually I'm pretty keen on meters to indicate things like power and SWR, but the simplicity, reliability and space saving of the LED indicators in this unit has won me over.

The performance was not tested with any extreme impedances. Judging from user reports it performs well with a wide variety of antennas, including long wires. Personally, I was amazed by its tuning speed and, with the shirt-pocket size and simplicity of operation; it really looks the goods for backpack work. Now I just have to quit my job, get fit and head for the hills.

My experience with Elecraft sales staff was that they are courteous and the service is hassle-free. If you need help, advice, or just want to see what the Elecraft owners are on about, you can join the e-mail discussion group. For kit details, go to [www.elecraft.com](http://www.elecraft.com). Please note that I have no connection with the company other than having purchased their products, and this is an unsolicited review.

ar

**2006**  
**Urunga**  
**Radio**  
**Convention**  
**Easter**  
**Weekend**  
**15-16 April**

Check out *Urunga Radio Convention* web page for details of this family-friendly event

<http://users.tpg.com.au/goldy2/>



# Calculating characteristic impedance (Zo) of unknown twin cable

Ron Sanders VK2WB

When winding matching transformers, such as baluns, for use from 1 – 30 MHz, the best results are obtained at the high frequency end of the range when the windings are made from transmission lines which satisfy the following matching criteria:

The transmission line should have a  $Z_o = \sqrt{(Z_1 \times Z_2)}$ , where  $Z_1$  and  $Z_2$  are the input and output impedances. For example, matching a 50 ohm cable to 200 ohms requires a cable with  $Z_o = 100$  ohms.

(See the article in *Amateur Radio* July 2005 for more information on winding arrangements.)

Coax cable characteristics are readily available, but it is often necessary to use twin cable as the transmission line when winding a ferrite toroid or rod as the core of a matching transformer.

Calculation of  $Z_o$  can be made by measuring the inductance (L) and capacitance (C) of a length of cable.  $Z_o = \sqrt{(L/C)}$ .

## Test set-up

By using an L/C meter which operates at 0.5 MHz or more, and can display  $\mu\text{H}$  and pF as three or more significant figures, we can achieve sufficient accuracy for amateur use.

At HF amateur frequencies, the transmission line used for winding should never exceed one metre in length. However, to obtain sufficient significant figures in the measurements of L and C, the cable should be made at least two metres long. Where two individual wires are used they should be kept in close contact so that any air spacing is minimised. A small amount of twisting is permissible to satisfy this requirement, especially with thin enamelled copper wire (ECW).

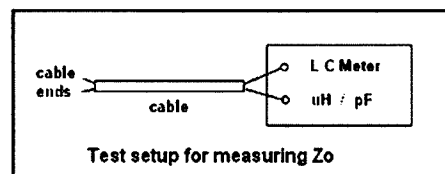

## Measurements

With the cable ends open circuit measure the cable capacitance. Short the ends together and measure the cable inductance. Cable  $Z_o = \sqrt{(L/C)}$ .

Note that L and C must take account of measuring units.

With a 2 m cable the following range of L and C values is to be expected:

L: 0.5 - 2  $\mu\text{H}$

C: 50 - 200 pF

Some actual measurements are listed below, with accuracy probably 20% or better.

- 30 AWG twisted pair ECW, 2 m long  
L = 1  $\mu\text{H}$ , C = 200 pF  
 $Z_o = 70$  ohms
- 24/0.2 PVC twin speaker cable (Dick Smith W 2012), 2 m long  
L = 1.6  $\mu\text{H}$ , C = 85 pF  
 $Z_o = 137$  ohms
- 2 x 1.0 mm ECW, 2 m long  
L = 0.8  $\mu\text{H}$   
C = 180 pF  
 $Z_o = 67$  ohms
- 24 AWG PVC twisted pair, (ex IT 12 pair ribbon cable), 2 m long  
L = 1.5  $\mu\text{H}$ , C = 120 pF  
 $Z_o = 112$  ohms
- 2 x 24/0.2 PVC cable (Dick Smith W 2260), 2 m long.  
L = 1.65  $\mu\text{H}$   
C = 75 pF  
 $Z_o = 148$  ohms

A check of known coax cable was made with an LC meter at about 1 MHz, with the following results:

RG-58, approx 3 m long.

L = 0.9  $\mu\text{H}$ , C = 332 pF

$Z_o = \sqrt{((0.9 \times 10^{-6}) / (332 \times 10^{-12}))} = 52$  ohms

## Conclusions

The cables in 1 and 3 would be suitable transmission lines where a  $Z_o = 70 - 75$  ohms is required. The cable in 3 above would probably be suitable down to 50 ohms.

The cable in 4 would be suitable for use as a 100 ohm line such as required for a 50:200 ohm transformer.

The cables in 2 and 5 would suit a 75:300 ohm transformer. Most IT and telecom cable pairs have a nominal  $Z_o = 100$  ohms at frequencies >1MHz.

## Plan ahead

### PORT MACQUARIE FIELD DAYS

Queen's Birthday Weekend,  
10/11th June 2006

Hosted by the Oxley Region A. R. C.  
Inc.

Held at  
the Sea Scout Hall, Buller St.  
Port Macquarie

Featuring  
Disposals, Fox Hunts,  
Demonstrations and  
Home Brew Displays

For further information contact:-  
Club Secretary, PO Box 712,  
Port Macquarie, NSW, 2444  
Or Bill Sinclair, Ph. 02 6583 9303

**Australian made**  
**ANTENNAS**  
*Setting a new standard.*  
**COM-AN-TENA**  
 (formerly a j and j coman)

115 John Street  
 GLENROY 3046

23 cm 36 ele slot fed yagi beam	\$190
2 ele delta loop 10/11 metre	\$249
2 ele quad 10/11 metre	\$249
10/11 beams comp opt 5 ele	\$327
10/11 5/8 vert 4 rad 1/4 wave	\$185
Tri band IIB 35 C 10/15/20 m	\$745
3 ele 20 m comp opt	\$460
log periodic 9 ele 13 30 8.4 boom	\$990
MBV 6-12-15-17-20-40-80	\$390
40 m linear loaded 2 ele beam	\$595
M B Vert auto switch 10/80 m	\$330
6 m 7 ele yagi beam 60 mm boom	\$387
6 m 5 ele compr opt beam	\$275
Top loaded 160 m vert	\$430
10 ele high gain 2 m 3.9 m boom	\$149
17 ele high gain 70 cm 3m boom	\$129
Rotable dipole 40 m	\$250
80 m top loaded vertical	\$239
dual band 2 m & 70 vert	\$140

**Guyed Masts**

**21 metres**                      **13 metres**  
 Winch-up & tilt-over. Aluminium and stainless steel  
 three-sided construction. Auto-brake winches.

**Free Standing Masts**  
 9.5 metres

**New Baluns**  
 1-1 to 16-1 to 3kW



**03 9773 3271**  
**Mob: 0419 542 437**

# Observations on VHF antenna height and other VHF path curiosities

Felix Scerri VK4FUQ  
 felixscerri@bigpond.com.au

**This article could be titled, "Is additional height really any great advantage in the overall scheme of things?" Conventional wisdom would suggest that, of VHF signals on "normal" terrestrial paths, the higher VHF antenna will always perform better. But is this always true?**

Over the last year or so, as part of my never-ending VHF antenna tinkering, I've done a lot of raising and lowering of small 2 m beams on various simple pipe masts of differing heights. In the course of those experiments I've come away with the feeling that additional height is not always as advantageous as one might think. In recent times I've been able to put up two identical Yagi beams on two separate pipe masts of differing heights and adequately spaced to avoid interaction. Using this arrangement, I've conducted numerous evaluations. My observations indicate that, on the longer 'DX' type of VHF path, such as is frequently seen up here in the North, with coastal tropospheric ducting, etc, the 'higher' beam is generally superior; yet on at least one 'moderate' distance path, the lower height beam is superior. That path is to our 'local' 2 m repeater situated on Mt Stuart in the Townsville area, around 70 miles from my QTH at Ingham.

None of my pipe masts is particularly high. My 'short' pipe mast has a maximum height of only slightly over 20 feet. My longer mast reaches about 25 ft. Yet, in rapidly switched comparisons, at least on the path to the Townsville 2 m repeater, the shorter mast always provides the stronger signal, sometimes by several "S" points, as evidenced by indicated receiver signal strength readings from the repeater.

Why? I don't really know. It would be nice to be able to check signal levels with even higher masts, but that option is not readily available to me. However I have checked things with even lower mast heights (around the ten foot level), and signals rapidly drop off at that point, possibly due to the large number of signal-attenuating physical obstructions present (houses, buildings, trees, etc).

Perhaps I shouldn't be surprised at this. Interestingly enough, another situation where the "lower" Yagi appears to perform better is in working mobile stations direct. However, strange things do happen at VHF frequencies.

Over the years I've become aware of lots of documented and anecdotal situations in rural areas (especially regarding TV reception), where antennas mounted on high masts and in the clear did not work as well as an antenna mounted in a seemingly bad location. My own observations with 2 m confirm this. Years ago, when the Cairns 2 m repeater was located at Mt Bellenden-Kerr (a very high location), while driving to Ingham from Townsville, along a certain kilometre or two section of the Bruce Highway, around the township of Rollingsstone, I was able to access that repeater for a very quick mobile QSO!

That path always seemed to exist over the years, but only for a short and defined section of road and, dare I say it, Rollingsstone was a long way from that repeater's primary coverage area, especially for a mobile 2 m station!

I've often tried to analyse these strange, unexpected, but reliable VHF paths. There are a large number of possible factors and reasons, ranging from localised ducting effects, geographically induced reflections, 'knife edge' refraction effects, and/or other exotic propagation modes that defy rational explanation, but these mysterious things do seem to happen at VHF frequencies. Perhaps my observation about the improved path to my local repeater with my 'lower' Yagi mast is another example of slightly improbable VHF path complexity and enhancement.

I wonder if others have also observed their own VHF path curiosities. I'd be interested to hear about them.

ar



# TTS Systems Communications Equipment

www.ttssystems.com.au

FREE CATALOGUE

## HF and VHF Transceivers, Autotuners and Kits

Phone 03 5977 4808. Fax 03 5977 4801 info@ttssystems.com.au

### New From LDG Electronics — DTS-4 Desktop Coaxial Switch

It can be tough switching between your 6-over-6 Yagi; your 4 element Quad, your 600' terminated Rhombic, and your full-size 160 meter vertical. Crawling under the desk, wrangling stiff pigtailed of RG-213 up to the rig. Even with a coax switch, most have the connectors at all angles, leaving the coax running all over the place, taking up half the desk. And then, you have to be able to reach the switch knob, so all that RG-213 is right there in your face.

So you get all that sorted, you're out when a killer lightning storm occurs. "Did I set the switch to Ground?" If not, will you have a smoking heap of rubble where your rig was. Help is at hand. The LDG DTS-4 Desktop Coaxial Switch is made for hams, by hams, to solve these very problems. With the DTS-4 you can instantly switch your rig between 4 antennas with the press of a button. All five coax sockets (4 inputs and one output to your rig) are lined up across the back of the switch, so all the coax can run straight back. This means the DTS-4 will fit in just about anywhere on your desk. A bright red LED indicates the antenna in use. At a touch of the control buttons, all inputs are grounded, helping to protect your radio from Mother Nature.

Remember that lightning? The DTS-4 can sense when your rig is turned off, and automatically ground all antenna inputs! You simply run a line from a DC-out port on your rig (most modern rigs have at least one) to the DTS-4 and set it to Radio Sense mode with a simple button-press. From then on you're protected; Power up and the DTS-4 automatically resets to the last used antenna. Use your radio's auto power off feature and it will even protect you if you forget!

But that's just the beginning! How about remote-mounting the DTS-4, say on the floor under the desk, or even in the basement to keep all that pesky coax at bay, and using a compact remote control box on your operating desk? The DTS-4R remote control fills the bill, with a full set of control buttons and indicator lights, but only a single, slim control cable running to the remote DTS-4 switch. The DTS-4 handles up to 1500 watts of RF power on HF (1000W on 6M), and can be used with any coax-fed antenna. The Radio Sense feature needs at least 2 volts

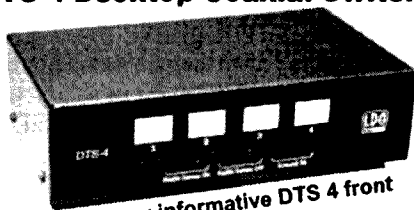

The very informative DTS 4 front



The highly organised back

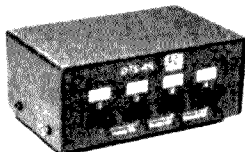

The space saving desktop remote

from your rig, at 1 mA current. The DTS-4 features Teflon SO-239 connectors, and requires an external 12 VDC power supply at 250 mA. If the external power supply fails, all inputs are grounded, so it's fail-safe. Switching is done by rugged, sealed industrial relays. Add the DTS-4 and DTS-4R to your shack soon; it's the modern coax switch you've been waiting for.

A six position version will be available in the near future.

### ADSP SPEAKER



Three modes:  
• no noise reduction;  
• original ADSP;  
• new ADSP2 noise reduction  
– up to 26 dB of noise reduction within the passband.



### Z100 TUNER AND AT1000 HIGH POWER AUTO TUNER

## TEN-TEC KITS

### Ten-Tec 3003 Acro-Bat antenna hanger.

UV resistant polycarbonate plastic, S/S hardware... Hang ladder lined or small gauge RG-58 or RG8X coax-fed wire antenna, or ladder line with internal pegs.

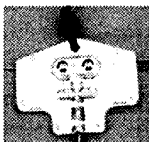

### MAC-200

MASTER ANTENNA CONTROLLER (Smartuner Built-in)

#### Control up to 5 Antennas

Select the right antenna, for the right band, at the right time with the MAC-200. The Master Antenna Controller operates as your base station control center, eliminating complicated switching and tuning. With the MAC-200, you can select between up to five antennas and tune automatically to minimum SWR. You can monitor your power and SWR with two convenient meters on the front panel of the unit. The MAC-200 puts you in control of your antennas.

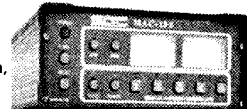

Full info available—ask

### SG-237 Smartuner™

High density surface mount components in a 4 layer PCB on a chassis plate: all providing high efficiency, reliability, performance with excellent electrical and RF ground system. Fully waterproof (.6metre/24 submerged). Case is weather resistant, factory-sealed ABS plastic.

**MULTIPLE APPLICATIONS** -- Use for base, mobile, portable, marine or aviation. Rugged construction and small size allow maximum flexibility. 100W power rating and frequency coverage to 60MHz, matches most popular HF transceivers. Works with balanced or unbalanced antenna: whips, backstays, dipoles, loops and longwires, and requires only 28 feet of antenna for full coverage operation.

Full info available—ask

### BUDDIPOLE

It's a dipole... It's a vertical... It fits in your travel bag! Optimised for transmit power, proven for DX work. Ultra light composite materials and High-Q coils. Zero-loss balun with Quick-Connect feedpoint. Standard Buddipole antenna comes with—

- Two 22" black anodised aluminium arms
- Two multi-band coils (40m - 10m) with adjustable coil tap pre-marked system
- Two stainless steel telescopic whips, the VersaTee™ with 3/8" x 24 adaptors
- BNC/PL259 coax connector, 25' of RG58 coax
- "Packcloth" carry bag thermo-plastic carry case; ops manual.



### Model 516 Argonaut V IF-DSP QRP Transceiver

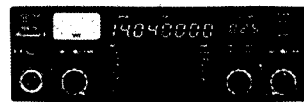

IF-DSP in a modern 20 watt HF trans-ceiver. 20 watts output power, all modes. SSB, CW, digital modes, and FM. Front panel adjustable from 1-20 watts output. AM operation at 5 watts carrier power (20 watts PEP). Metering measures forward or reflected power in switchable 2 or 20 watt scales.

## We have



### SGC 237 Waterproof Auto Tuners SGC 239 Economy Auto Tuners



### Autek Antenna Analysers Autek RF 2kW in-line Power meters



### Lutron Measuring Instruments

### Vantage Pro Weather Stations

# Try EchoLink yourself

Paul van der Weegen VK2EX

**Having been a ham since 1978, I have seen some wonderful transformations in our hobby. I started off on SSB with a converted CB radio, and moved on to bigger aerials and more powerful radios with more bands and features. I first experienced computer interfacing with my uncle VK2DDA and his PET computer playing RTTY, and quickly became hooked on digital communications.**

After RTTY came Packet, AMTOR and FAX with a PK232MBX. I had a load of fun. Then came along JVFax and full colour SSTV in its various modes. "What a breakthrough", I thought. A few years later and the sound card revolution started. No longer was there a need to buy expensive hardware, dedicated to only a few modes. You could now easily hook up your computer to the mic and speaker sockets, and get onto the latest digital modes.

I found PSK31 to be a fantastic meal for my digital appetite. I experimented with many stations on many modes and was even able to hold a two way contact with an American radio amateur on 10 metres with 0.5 watt of power through the beam. There are many other modes like PSK31, all running through the sound card.

A few months ago I found myself with a dilemma. My 13 year old daughter cuddled up to me one night on the couch and asked if she could have a room to herself. Well, what was a dad to do but look at my shack and realise that my

daughter had more right to a room of her own than my radio gear. So, I packed up the gear and gave ham radio a rest for a few years (or so I thought).

However, my need for ham radio finally got the better of me. I went in search of other activities to entertain myself and quickly found K1RFD's EchoLink again. I had played with EchoLink a few times some years ago, but considered it just like MSN Messenger and VOIP (Voice over Internet Protocol), so I was not initially taken by it. But, after a good look over the program and talking with a friend of mine, I found it too could be hooked quite simply to a transceiver and used remotely.

This revelation caught my interest and, for the first time in about 10 years, I pulled out the soldering iron and resurrected my old JVFax modem which I had built all those years ago. I managed to hook up the old Dick Smith Commander to the computer, hung a 'rubber ducky' 2 metre aerial off the bench, and quickly found I had some serious feed back problems!

Not to be beaten, I soon realised that it would be necessary to decouple the radio and computer electrically. I purchased four small audio transformers from the local electronics store and wired them between the radio and the computer on the audio lines. It worked.

I was most impressed to find that I could now talk to many people in many countries from my hand-held in the kitchen, the back yard, the lounge room and even 'maritime mobile' from the pool on an air mattress.

I have since made many improvements to the system, including building a new half wave J-pole antenna and hooking up my old FM900. The FM900 is a good radio for this type of work as it has a time-out timer built-in which is very necessary if you are going to consider using this system remotely and unattended.

My wife Sheralyn, VK2LUV, and I have been chatting for years on a 2 metre

simplex frequency to keep in touch, so I decided that quiet frequency would be ideal for the EchoLink experiment. Well, that frequency is far from quiet now! We still use it, of course, but the contacts I have made and the new friends I have found on this fascinating system have revitalised my interest in good old fashioned rag chewing, and ham radio as a whole. Every day on the 10 km drive to work I talk with a fellow EchoLinker in the UK, sometimes mobile to mobile. Let's see you do that on MSN or Yahoo Messenger, Skype or CQ Phone.

The technology in this program is, quite frankly, jaw dropping. You can buy a ready made interface or, with the simple home brew interface I have outlined in this article, you can have full DTMF remote control of the program via your radio. You are able to connect to other stations, disconnect, check node status, and even disable and enable the link. The system has time-out timers that you can adjust to suite your needs. You can also control what type of users you will allow to connect to your system, such as allow only RF links, single computer users, repeaters only, or everything.

The EchoLink system is also well regulated. When you first download the program you are asked for your call sign and a password. Your call sign is then verified and it is confirmed that you are a licensed amateur before you are able to connect to the EchoLink server. This helps ensure that only hams are on the system.

If you are considering taking the leap into something different, and have a spare computer and preferably a broad band internet connection, please give this technology a good look. You might be very surprised and impressed as I have been. This is what ham radio for me is really about: Experimenting with new forms of communications. With the current solar activity, this seems the perfect way to keep those skeds alive.

ar

## BARCFEST 2006

When: **Saturday 13<sup>th</sup> May**

At **Mt.Gravatt Bowls Club**  
1873 Logan Road Upper Mt.Gravatt.  
Opening time 1000

Club Displays Disposals  
Commercial Displays and Sales  
Computer Gear  
Bar and Canteen by Bowls Club

Contact Colin Gladstone VK4ACG on 3217 9589  
(BARC Secretary).

Or

Visit the BARC Website at <http://www.qsl.net/vk4ba>  
and select Barcfest for full details of venue location  
as well as an application form for table space and  
other important information...!



# The VK5BR-X antennas

## Some modified ideas on how they work and how they perform

by Lloyd Butler VK5BR

*(Further experimentation has revealed more about the causes of rise in antenna resistance. Also we see that more radiation can be achieved by unbalancing the antenna circuit.)*

Earlier estimates of radiation efficiency in the X2/X3 antennas were based on measuring the difference between total antenna resistance and series coil loss resistance. The difference was thought to be radiation resistance resulting from the crossed E and H fields. It is now clear that this difference is due to other factors and the antennas are now not considered to be operating in a crossed field mode.

Further experimentation has also shown that, rather than be enhanced by crossed fields, the radiation can be increased by connecting the antenna circuit so that it is out of balance. This causes a common mode current component in the feeder, particularly high at the antenna end, so that the antenna itself forms an efficient top loading element for the common mode current as a radiator.

### Foreword

The original concept of the X antennas was based on the controversial crossed field theory. The open magnetic fields from coils in series with the short dipole legs are arranged so that they interact with the electric field between the two dipole legs. It was considered that at least part of these fields would be at right angles to the electric field and, because

the current through the coils must be in phase with the voltage across the antenna resistive load, the magnetic field from the coils must also be in phase with the electric field across the dipole. This constituted much of the requirement for crossed field antenna operation. For more detail, refer to my first article on the X antennas published in *Amateur Radio*, July 2004.

The simplest form of the X antenna is the X2 connection shown in Figure 1. Here we have a balanced dipole antenna, about 2% of a wavelength, loaded with two series coils and fed via a balanced but tunable line controlled by a Z Match antenna tuner.

The antenna dipole capacitance is very low and somewhat less than 10 pF for the higher frequency HF antennas, to a little more than 10 pF for the 80 metre

antenna (so we see reactances of over 1000 ohms at 14 MHz and 3000 ohms at 3.5 MHz). The total inductive reactance of the two coils in series is selected to be close to the capacitive reactance of the

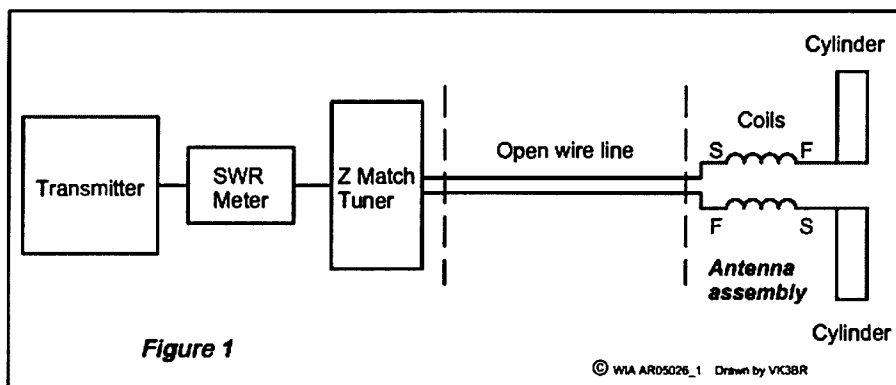

Figure 1 - Tuning arrangement VK5BR\_X2 antenna.

### Editor's note

This article first appeared in a reduced form in the December 2005 issue of AR. Unfortunately, several errors crept into the presentation of the material. Several people, including the author, noted the errors. To ensure that all are happy and can read the article as a more comprehensible story, we are publishing the complete article. We have previously noted the errors and have apologised to Mr Butler.

Peter VK3KAI, Editor

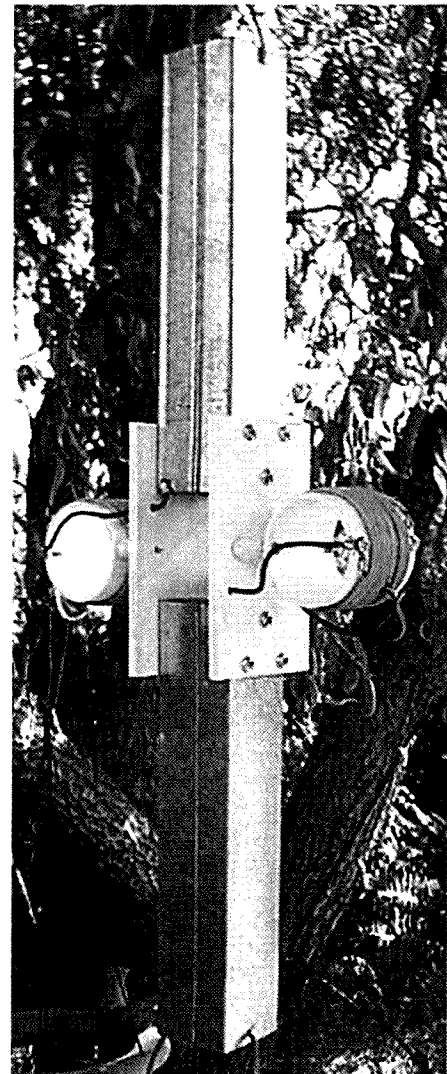

Photo 1 - 20 m X3 antenna

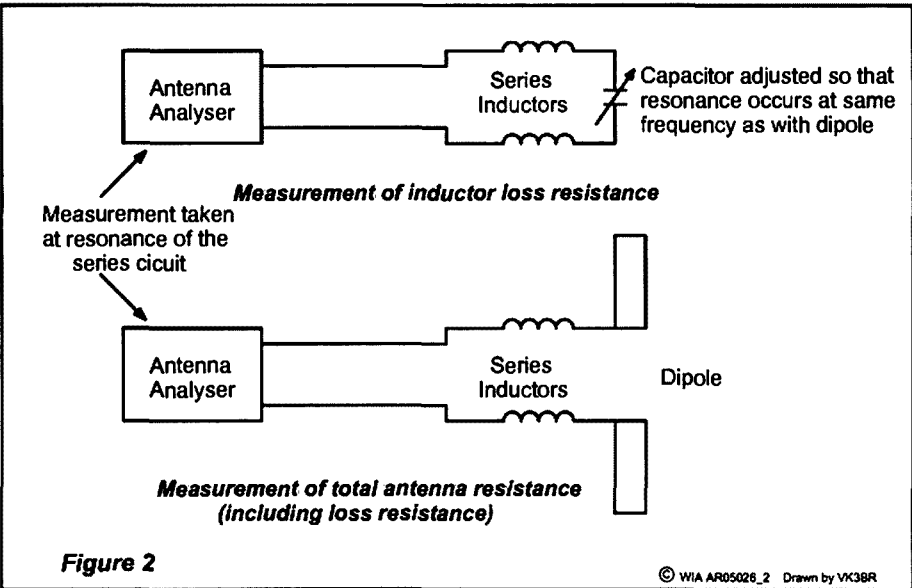

Figure 2 - Measurement of coil loss resistance and total antenna resistance.

dipole at a frequency within the band of operation. Precise equality between the two reactances is not imperative as resonance at the frequency of operation is made with corrective reactance (where necessary) reflected up the balanced line by adjustment of the Z Match.

The total load resistance of this antenna has been assumed to be the sum of the loss resistance in the coils

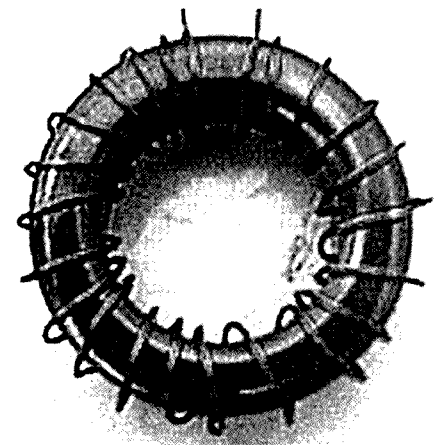

Photo 2 - Toroidal coil.

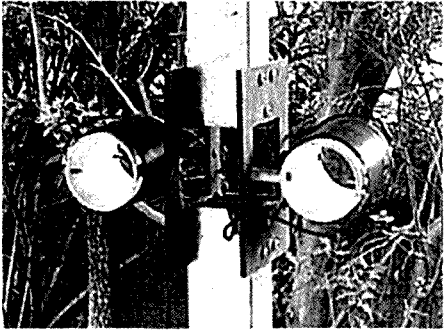

Photo 3 - 40 metre antenna assembly with centre of separating plates cut out.

and the load resistance presented by the antenna itself resulting from electromagnetic radiation and induction into nearby objects. Measurement of coil loss resistance and total resistance of the antenna series circuit is shown in Figure 2.

Based on formulae to calculate radiation resistance, a dipole of about 2% of a wavelength would have a radiation resistance of around 0.1 to 0.2 ohm. So, in measuring total resistance of the antenna, a resistance little different from that of the coil loss resistance would be seen.

Coil loss resistance varies between around 4 ohms for 10 metres to 10 ohms for 80 metres. However, in making measurements, total resistance considerably higher than the loss resistance has been recorded in the region of 15 to 40 ohms. Some of this can be shown to be induction into objects or earth which are too close to the antenna. But the remainder has been taken as radiation resistance very much higher than that of the calculated figure for the basic dipole and assumed to be due to the interacting E and H fields.

One questionable aspect of this explanation is that the antenna still seemed to work when the coils were rotated by 90 degrees away from their maximum line of field. This was discussed in my article in *Amateur Radio*, April 2005 and explained away by virtue of the fact that a field around an open coil spreads at all angles.

However, it was suggested to me that

the theory of interaction could be tested by substituting the open coils with two coils of equal inductance but wound on toroidal iron dust cores. This would confine their magnetic fields essentially to the toroidal core and limit most of the interacting magnetic field.

So I wound two coils (Photo 2), 6.5  $\mu\text{H}$  (23 turns) on 50 mm T200 iron dust cores and tried them on both of the 20 metre X3 antennas I had, but used the X2 connection because I needed to take resistance measurement. The series loss resistance measured at resonance, with a fixed capacitor substituted for the antenna capacitance, proved to be 1 or 2 ohms less than the open coils.

Assuming that all the magnetic field from the toroidal coils was confined, the resistance reading with the antenna dipole connected should have been almost the same as the previous coil loss resistance reading. Not so! In fact, the total resistance with the toroidal coils was considerably higher than with the open coils. This resistance on one antenna, resonating at 14.8 MHz, was as high as 24 ohms, nearly three times the loss resistance. It almost suggested that the circuit with the highest unloaded Q gives the highest radiation resistance.

Further to this, when powered the antenna seemed to be operating and radiating at least as well as (if not better) than when using the toroidal coils.

All this leads to assumption that my original theory for the X2/X3 antennas operating in a crossed field or field interacting mode was wrong. There had to be some other explanation why the apparent radiation resistance is raised well above that of around 0.1 or 0.2 ohms derived from a common formula for the 2% wavelength dipole.

### Dielectric loss induction loss

My previous test procedure has been to assume that losses in the antenna circuit were essentially due to losses in the series coils. However, as discussed above, the high Q creates a very high impedance across the capacitance of the antenna. Quoting the example of a series resistance of 20 ohms and a Q = 50, the shunt resistance across the capacitance at resonance is  $20 \times 50 \text{ squared} = 50,000 \text{ ohms}$ . Such resistance could, in part, be due to excessive dielectric loss resistance in the insulating plates separating the dipole elements.

It seemed strange to me that the series resistance measurement on the 10 metre antenna was so much lower than on the 20 metre antenna. The only difference was that the insulating plates for the 10 metre antenna were made of plexiglass (which appears to be a form of polystyrene) whereas those for the 20 metre antenna were made of hardboard. So I re-made the separating plates for the 20 metre antenna in plexiglass and this lowered the series resistance by about 8 ohms to a value nearer to the loss resistance determined for the coils.

I then operated on the 40 and 80 metre antennas. In these I cut the centres out of the hardboard separating plates so that a skeleton plate was left sufficient to fix the dipole elements apart and provide mounting for the coils (see Photo 3). This lowered the series resistance of the 40 metre antenna by 6 ohms and the 80 metre antenna by 5 ohms.

The resistances of these two antennas were still considerably higher than the coil resistances, but at these lower frequencies it appears that considerable coupling takes place to surrounding objects and particularly earth. In particular, the resistance of the 80 metre antenna rises considerably as its height above the ground is increased, increasing to values as high as 44 ohms.

Whilst I was on the job I thought I should check out other available insulating materials, so I also tested the 20 metre antenna with plates made from PVC sheet and the 10 metre antenna with plates made with polyethylene sheet. These gave similar results to the plexiglass. It was only my hardboard which clearly showed the high dielectric loss.

These latest tests have shown that this added resistance is more to do with dielectric loss between the dipole plates and induction loss than the result of crossing or interacting of the E and H fields as previously assumed.

The induction loss into earth and other objects is particularly apparent for the lower frequency antennas. This could be pure absorption loss but it could also be induction into other structures which re-radiate. This latter idea would seem to have real significance if the field spreads around another antenna wire which happens to be resonant near the frequency of the local field or is harmonically related.

## E-H phase testing

The design of the X2/X3 antennas was originally based on the in-phase relationship between the H field generated by current through the coils and the E field generated across the dipole plates. I checked this relationship with probes connected to a dual trace CRO. I have to say this was a bit tricky as the CRO leads pick up stray longitudinal voltage which can give false indication of what is being read.

Figure 3 shows the arrangement I eventually used to carry out these tests on the 40 metre X2 and X3. As shown on the diagram, I cast aside the usual high impedance probes and used direct connection to the CRO inputs across a very low terminal resistance which discourages stray signal pick-up.

The H probe, which I poked near the end of either of the coils, had a few turns around a ferrite rod and terminated in a very low resistance (10 ohms) so that the voltage fed to the CRO gives a picture of the current induced from the magnetic field.

The E probe was a short dipole which was terminated in as low a resistance as possible, but sufficient to get a reading on the CRO when the antenna was fed from the highest level available from my 'sig-gen'. By using this and isolating with my candelabra balun to reject longitudinal pick-up, I was able to get sufficient pick-up of the antenna electric

field by holding the dipole a few inches away from the centre of the antenna.

The tests were carried out for both the X2 and X3 connections and sourced with a signal generator fed direct to the antenna input as well as using the transmitter output fed via the Z Match and a short length of open wire balanced line. The tests confirmed the in-phase relationship required.

## Some interim conclusions

Referring to previous articles, I had assumed that the considerable rise in series antenna resistance was due to the crossed field condition set up by interaction between the E and H fields. However, the more recent tests show that is not the case and the antenna radiation is not being enhanced to a significant degree by the interacting fields. I have to assume one of the following:

- (1) The fields are not correctly oriented or not in phase and my testing procedure to monitor this was inadequate in verifying this.

or

- (2) The fields are oriented suitably for the crossed field condition but they do not produce the degree of radiation enhancement which has been promulgated as characteristic of a crossed field antenna.

Either way, I cannot continue to

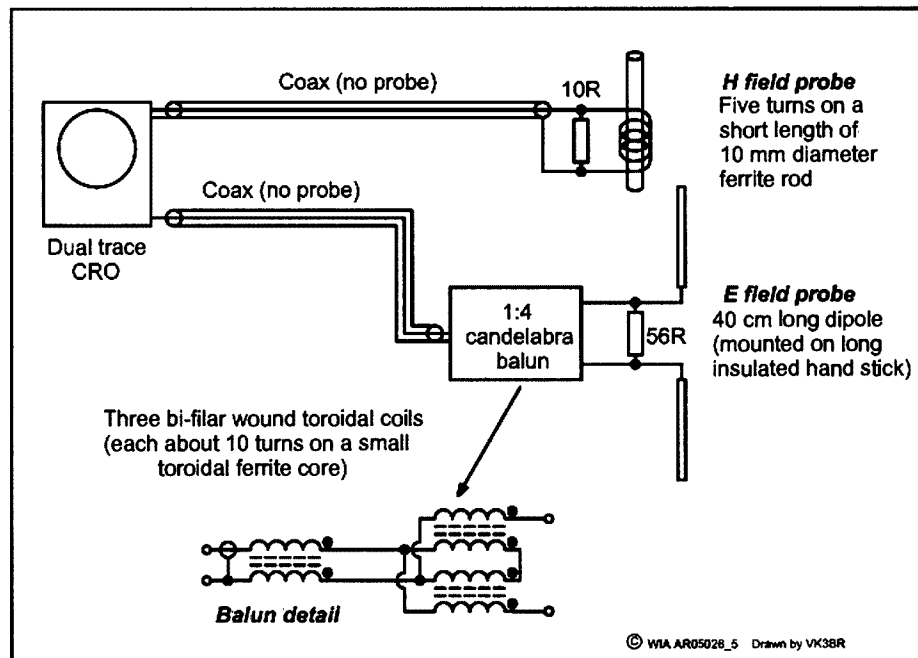

Figure 3 - Measurement of phase between E and H fields on X2/3 40 metre antenna.

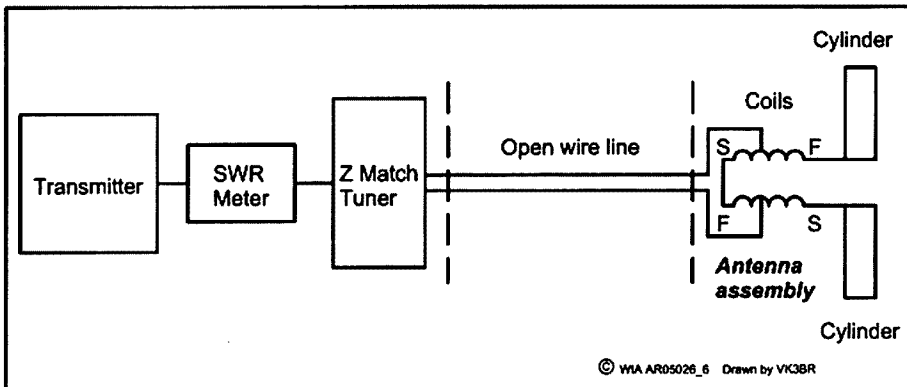

Figure 4 - VK5BR\_X3 antenna tuning and matching system

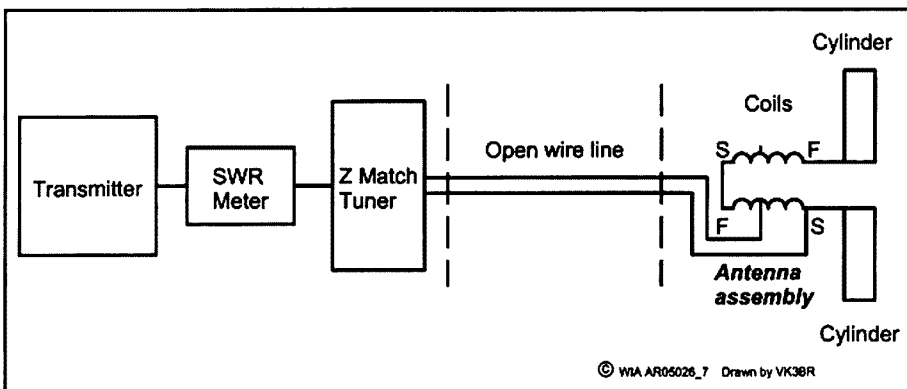

Figure 5 (X3U) - X3 antenna tuning and matching system with antenna circuit unbalanced.

with their fixed taps. The connection arrangement shown in Figure 5 seemed to produce the best field strength result. I will give reference to this antenna arrangement as the X3U.

Using this X3U arrangement there was still field measurable around the dipoles but much less than for the balanced connection of Figure 4. However, using an H field detector with LED display, I was able to track consistent magnetic field right down the length of the transmission line from the antenna to the Z Match output. This was clearly caused by imbalance of current between the two legs of the line.

The X3U antenna was hung about two metres above the ground with the feedline on average about 1.5 metres above the ground. There was seven metres of feeder in open space plus four metres entry under the car-port and shielded by its steel roof. On test, the received level now appeared slightly higher than the Inverted V antenna. On transmitting, I received several signal reports from stations on the east coast of Australia. These reports indicated similar signal levels being transmitted from either antenna. Further reports on another day from a network of stations put the X3 at a higher level than the Inverted V.

From the tests, I conclude that by putting the short balanced dipole out of balance, the field strength is increased from that inherent to the short dipole to something close to that of a full sized half wave antenna.

What I think happens is that the tuned dipole takes over the role of being prime radiator to providing a differential termination for the transmission line. But because of the unbalance, a longitudinal (or common mode) current component also runs on whatever length of line is now left without a balancing or common mode rejecting interface. This current tends to be quite high at the antenna end of the antenna system compared to a base loaded antenna system which has very low current at its apex. One might consider that the dipole, resonated with its inductors, forms a sort of top loading function to the common mode current component.

In the May 2004 issue of *Amateur Radio* concerning EH antennas, I discussed how the unbalance leads to unequal dipole leg currents via capacitance to earth. Voltage at the dipoles is multiplied by the very high

a reference end fed half wave inverted V antenna with its apex about 10 metres above the ground. Received levels are also several S points below that from the inverted V. Considering that I now believe there is no enhancement from crossing E and H fields, these figures seem consistent with those which could be predicted from a simple dipole.

Much of the information gathered for the EH antenna seems to point to best performance when the antenna has a degree of unbalance to generate a longitudinal (or common mode) current in the antenna system. In both the L+T and Star EH antennas one dipole leg is directly connected to the braid side of the transmission line. For the L+L EH antenna we found it necessary to wind one inductor with fewer turns than the other. When the Star antenna was tried in balance, it didn't perform so well.

Following along this theme, some tests have been carried out to see what happens when the X3 antenna circuit is deliberately unbalanced making it look more like the type of circuit used in the Star EH antenna which has one dipole element directly connected to one leg of its transmission line. I tried several connections using the coils as they exist

classify the antenna as working in a crossed field mode.

Actual radiation resistance is clearly much lower than previously assumed and difficult to quantify as a means to derive radiation efficiency. Claudio Re I1RFQ tried a different method. He carried out some field measurements on a 10 metre X3 antenna in comparison to a ground plane reference antenna. He derived figures of 10 dB down and an efficiency of the X3 as 10 %. In amateur radio terms this represents about 1.5 S points down and seems to agree with some test reports I have received at 1 to 2 S points down on a full size antenna. Of course this was the original balanced X3 antenna and we are going to look further at what happens when it is put off balance.

## The X3 antenna unbalanced

The original balanced 40 metre X3 antenna system is shown in Figure 4. The antenna is driven in its balanced form via open wire tuned line and a Z Match Tuner. In this arrangement, the antenna has been given signal reports around two S points below the level of



Q of the shortened antenna circuit and this leads to multiplication of those currents.

I figured that more measurement might reveal how the longitudinal current component might vary over the length of the line. It did seem to me that if the antenna coupling were set such that the dipole circuit loads the transmission line with resistance equal to the line characteristic impedance, current in the line (even if unbalanced) would possibly be fairly constant over its length.

I was able to monitor more carefully the relative strength of common mode current right down the line to the X3U by sliding a large ferrite toroidal core over both wires of the pair and coupling the core to a milli-ammeter with detector. The tests showed maximum common mode current at around one quarter wavelength down from the antenna and at about three times the current near the antenna input and the Z Match Tuner output. However, the current maximum could be shifted to the antenna entry point by shifting the location of the Z Match tuner so that the open wire line section was seven metres long and less than  $\frac{1}{4}$  wave. In this case, the current was near constant to about four metres down the cable, and falling to a low value at the output of the tuner. Despite this, the former test connection, with the longer line, produced higher signal level reports on air test.

I then set about repeating the experiment for the 20 metre and 80 metre X3 antennas using the out of balance connection. Even better for these antennas, the common mode maximum was at the topmost end of the open line where I figured it could be most effective. For the 80 metre test, the common mode current was almost constant over the 13 metre length of line.

One objection raised for allowing the feeder line to be part of the antenna system in the EH antenna was the interaction between antenna tuning and the length or position of the feeder. The same applies to the unbalanced X3 but tuning correction is easily made in the radio shack using the Z Match Tuner.

## Some conclusions

The original design of the X2/X3 antennas was based on the controversial cross field theory. Earlier measurements of high antenna circuit series resistance led me to believe that the antenna was

working in this mode. However, more recent investigation has shown that as far as the balanced form of the antenna is concerned, the high value of resistance is due to other factors, not radiation resistance resulting from the crossed fields. I now assume that radiation from the antenna, in its balanced form, is simply that which can be predicted as normal in any dipole.

However, I have shown that by unbalancing the form of the dipole (as for the X3U connection) so that the feedline is activated with common mode (or out of balance) current, the radiation level can be raised to nearer that of a full sized resonant dipole.

So it seems that first setting out to make a balanced small dipole which was supposed to demonstrate how interacting or crossing its electric and magnetic fields could enhance its radiation, we have discovered that it doesn't. But, instead, if we put the antenna circuit off balance, we have a magnificent top loading device for a radiator formed from the feedline out of balance current. But I guess that is what experiments with amateur radio are all about.

Before concluding, a short note on EH antennas seems in order. Having written quite a bit about these and their operation in a crossed field mode, I now have similar doubts about whether this mode is the radiation enhancing factor. From what we have learned about the EH antenna, it's antenna circuit is clearly unbalanced and it does seem to need at least a short feeder tail for best operation. I suspect that the same sort of process takes place as I have described for the unbalanced X3.

## References

1. Refer to articles on the VK5BR\_X antenna in previous issues of Amateur Radio, November 2004, March and April 2005.
2. Refer to articles on the EH Antenna by VK5BR in previous issues of Amateur Radio, April and November 2003, and May, July and September, 2004.
3. Refer to articles on the X3 and the EH Antennas by VK5BR at <http://www4.tpgi.com.au/users/lbutler/>

Or link from:- <http://www.qsl.net/vk5br/>

ar

# Amateur Radio Bookshop

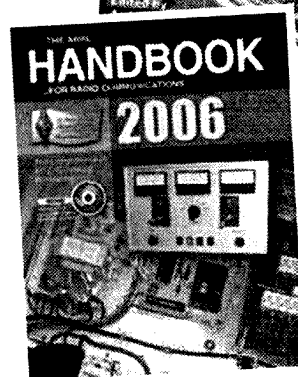
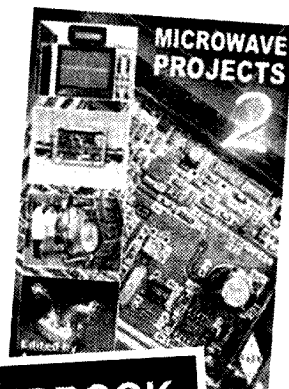

Download our catalogue at

<http://www.wia.org.au>

Amateur Radio Bookshop  
PO BOX 3084  
EAST BLAXLAND  
NSW 2774

Office: WIA National Office  
Tel 03 9528-5962  
Fax 03 9523-8191  
[bookshop@wia.org.au](mailto:bookshop@wia.org.au)

**ARRL - RSGB  
publications  
- books  
- magazines -  
CDROMs - DVDs**

# OzGear

www.OzGear.com.au

RadioCommunications & Electronics  
Ozhelp Services Pty Ltd T/as OzGear

Suppliers of radiocommunications, electronics and computer products and electronic test equipment.

Ph 07 3114 2506

sales@ozgear.com.au

Brisbane, Q'ld

Manager : Doug Hunter VK4ADC

## You want radios ??

Boy, do we have radios for you... ○



Australian-sourced radios with Australian-based manufacturer warranties.

Authorised Aust Icom and Yaesu Dealer

Antenna, cable, interface, tuner and general accessory products from...

Amidon, Andrews USA, Autek, Benelec, Bushcomm, Comet, Daiwa, Diamond, Gariand, GeoSensory, GME, Icom, Kingray, LDG, Lutron, Mobile One, RFI, Sangean, SGC, TET-Emtron, Tigertronics, Yaesu, ZCG Scalar plus ARRL and RSGB publications....

## ALTRONICS

Over 8000 electronic components and accessories as listed in the Altronics catalogue with many items held in local stocks.

### Not local to you ?

Not an issue because we ship our products all over Australia and to overseas customers every week.

### Product & pricing info ?

Phone, email or visit us on the web at

www.OzGear.com.au

for the latest product info plus on-line ordering. Our latest price list can be downloaded at any time.

### Payment ?



# WIA National QSL Collection

## Ducie Island VP6DIA

Ken Matchett VK3TL

A very welcome donation to the WIA QSL Collection was a Ducie Island VP6DIA QSL. It was donated by one of our top DX-ers and DX-peditionists, Gwen Tilson VK3DYL.

The National Collection now has QSLs from every DXCC country, including all deleted countries, since the start of the Post-War DXCC award in 1947. When North Korea was a much wanted DXCC country some six years ago it was another excellent DX-er, Jim Smith VK9NS on Norfolk Island, who helped us out by donating a P51BH QSL.

Ducie Island is the most isolated of the Pitcairn group of islands, lying nearly 500 km to the east. Ducie Island is a coral islet with an area of 0.7 sq. km.

Despite very high coastal temperatures, several storms and enormous pile-ups, the Pitcairn Island ARA, together with several volunteers, managed to make no fewer than 51,000 QSOs during their eleven days on the island.

*Footnote:* Thanks to all the DX-ers who have already contributed to the Collection. Are there other DX-ers out there who would like to save something for the future through the WIA Collection?

ar



# Old Timers turn 30

Ian Godsil VK3JS  
Secretary, RAOTC

Today it is hard to ignore the fundamental need of almost every Club you hear about – they all need that extra dollar. However, sometimes you meet one that is successful, has a good Membership base and has stood the test of Time.

Such a Club is the Radio Amateurs Old Timers Club Inc. (RAOTC) which officially celebrated its 30th Birthday on 10th March this year.

The Club was apparently formed in 1975, but the Constitution was not adopted until March 1976, so it is from this date that President Ron Cook VK3AFW reckons the lifespan of the Club.

As slang terms change from time to time, so too do more traditional terms like "Old Timer" in our AR hobby. Traditionally an Old Timer is thought of as an operator of 25 years' standing. This gives the impression of an "old" man or woman, or at least a Senior Citizen; but someone licensed at 20 years of age

would be an Old Timer at 45, definitely not an old person!

Our RAOTC Inc. has had good support in its 30 years. It is a national organisation, even though the Committee is Melbourne-based, with strong support groups in VK5 and VK6. It has a monthly on-air Broadcast and Net on the first Monday of each month under the call signs VK3OTN and VK6OTN. Membership hovers around 430.

Sadly, one of our stalwart members recently became a Silent Key. Allan Doble VK3AMD had been Secretary, President, Broadcast Officer and Historian in his time and will be very sorely missed by the Club. He was also

a regular contributor to *OTN*, a twice-yearly magazine of very high calibre prepared by Bill Roper VK3BR.

To mark the Club's 30th Birthday there will be an on-air QSO Party later in the year – this to allow time for publication in the next magazine.

Also, the Club will welcome in to membership any amateur who has been licensed for ten or more years – and there are quite a few of you out there!

Please contact the Secretary at PO Box 107, Mentone, 3194, or via email at raotc@raotc.org.au for information and help us say Happy Birthday RAOTC!

ar

## Andrews Communications Systems

### ICOM DISCOUNTED

IC-756 Pro III HF+6m	<b>\$4,999</b>
IC-V8000 2m 75W	<b>\$399</b>
IC-746 Pro HF+6m+2m	<b>\$2,699</b>
IC-706 Mk 2G HF-70cm	<b>\$1,499</b>
IC-718 HF SSB	<b>\$999</b>
IC-910H 2m+70cm SSB	<b>\$2,299</b>
IC-208H 2m+70cm	<b>\$579</b>
IC-2200h 2m 60W	<b>\$399</b>
IC-T90A Triband h/h	<b>\$449</b>

**\*4 YEAR WARRANTY\***

### ALINCO

<b>Factory Direct Importer</b>	
NEW DR-635T Twinbander	<b>\$699</b>
DR-605E Duplex dualband	<b>\$499</b>
DR-135T Mk2 2m 50W	<b>\$349</b>
DJ-V5E Dualband handheld	<b>\$499</b>
DJ-X2000E Hi-tech scanner	<b>\$699</b>
DJ-X10E All-mode scanner	<b>\$499</b>
DJ-596T Dual band handheld	<b>\$349</b>
DJ-C7 Tiny dualband h/h	<b>\$299</b>

**\*3 YEAR WARRANTY\***

Spectrum Analysers from	<b>\$1499</b>
Oscilloscopes from 20MHz to 100MHz	

### ICOM IC-7000 \$2199

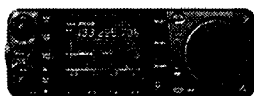

**HF-70cm COLOUR TFT DISPLAY  
IF DSP, Twin PBT, 508 channel  
memory and much more!**

### bhi DSP NES10-2

Amazing DSP speaker

Hundreds  
sold!  
**\$249**



### KENWOOD DISCOUNTED

TS-570SG HF+6m+ ATU	<b>\$1,999</b>	TM-271A K 2m mobile	<b>\$349</b>
TS-480HX HF 200W+6m	<b>\$1,999</b>	TM-D700A Dualband Mob	<b>\$999</b>
TS-2000 HF-70cm + ATU	<b>\$2,799</b>	TS-480SAT HF+6m+ ATU	<b>\$1,799</b>
TS-570DG HF + ATU	<b>\$1699</b>	TM-G707A 2m/70cm mob.	<b>\$499</b>

### YAESU DISCOUNTED

FT-1802M 2m 50W Mob.	<b>\$289</b>	FT-60R Dualband h/h	<b>\$349</b>
FT-7800R Dualband	<b>\$449</b>	FT-817ND HF-70cm Port.	<b>\$999</b>
FT-8900R Quadband	<b>\$799</b>	VX-1R H/held 2 batts	<b>\$249</b>
FT-8800R Dualband	<b>\$699</b>	VX-2R Tiny Dualband	<b>\$319</b>
FT-897D HF-70cm	<b>\$1,399</b>	VX-170 2m H/held	<b>\$269</b>
FT-857D HF-70cm	<b>\$1,299</b>	VX-6R Dual H/H	<b>\$469</b>
FT-2800M 2m 65W	<b>\$319</b>	VX-7R Deluxe H/H	<b>\$579</b>

**\*YAESU ROTATORS DISCOUNTED\***

**\*3 YEAR WARRANTY\***

**Australia's Biggest Amateur Radio Stockist**

### NEW!

ANDREWS DUALBAND WHIPS frm \$49 (similar Diamond). Factory Direct Importer!

ANDREWS BATTERIES New fr. \$29!

DIAMOND, MALDOL, COMET, HUSTLER and HIGH SIERRA antennas all in stock.

THP, LDG, MFJ, ALINCO, ICOM, YAESU Automatic antenna tuners in stock

TET-EMTRON HF Antennas in stock

VAIR POWER METERS, T LEADS, ETC.

MFJ Antennas, Tuners, Analysers, etc.

ANDREWS AMPS ..160m-10m 500W+ w/protect. \$999, 2m 120W \$329, 200W \$449, 300W \$999.

ANDREWS YAESU, PALOMAR, TE SYSTEMS, AMERITRON, ICOM linears

**ANDREWS AMATEUR BASE ANTENNAS**

BF-2M2 Fibreglass 2m 6.7dB \$99

BF-2M3 Fibreglass 2m 7.8dB \$129

UVS-200 Fibreglass 6dB/8dB \$149

UVS-300 F'glass 8.3dB/11.7dB \$199

CBS18 Fibreglass 5.7dB 10m \$149

Discones from \$129, Coax switch \$29

We export worldwide. We also hold some stock in New Zealand!

**CALL (02) 9636-9060 or (02) 9688-4301 or FAX (02) 9688-1995**

Shop 8, 41 Bathurst St., Greystanes, NSW 2145

**MAIL ORDER to PO Box 240 PENDLE HILL NSW, 2145**

<http://www.andrews.com.au>

email: [lee.andrews1@bigpond.com](mailto:lee.andrews1@bigpond.com)

**WHY PAY MORE?**

Some items indent  
Prices subject to  
change without  
notice  
Limited stock  
some items  
E&OE 4/06

# Review of The Diamond X-200A antenna

Hayden Honeywood VK7HAY

The Diamond X-200 was featured in 1992 in an article in *Amateur Radio Action*. After having read this article and borrowing the antenna for a short time from another amateur (and having good results), I decided to lash out and buy one from Andrews Communications Systems at a cost of \$149. The antenna is currently available from Dick Smith Electronics for \$199.

The X-200 is a 2 m/70 cm Vertical antenna which is 2.5 m long. The X-200 is made of white fibreglass and is a two 5/8-wave on 2 m and a four 5/8-wave on 70 cm. The antenna is supplied with three ground-plane radials for a clean radiation pattern; however the antenna

can be mounted without the radials for portable use. The antenna's gain is 6 dB on 2 m and 8 dB on 70 cm. The Diamond X-200A is one of seven similar models made by Diamond with the smallest being a X-30 at 1.3 m long and the longest a X-700H at 7.2 m long. Gain increases with size, with the X-30 at a gain figure of 3/5.5 dB and the X-700H with a gain of 9.3/13 dB. The X-200 is one of the most popular, and the third shortest. The X-200 is a great antenna for Field Day operation and also a good base station antenna.

## Assembly

The antenna has arrived! I slipped off the postal packaging. The antenna was housed in a very good quality plastic bag, suitable for fishing rods. I checked the list of components to make sure that none were missing. Everything was OK.

Now to remove the antenna from packaging. Let's see where to start. So much sticky tape! Scissors should fix that. Okay, all free from the plastic.

Wow! The construction of the Diamond X-200 is absolutely wonderful. The white fibreglass is excellently made. The instructions say to connect the upper and lower elements together. Slide the set-screw clamp down the tube to where the bottom half of the element is - now attach the elements together. After fixing the element at the element joint bracket, connect the upper and lower outer shells with the outer shell joint bracket. Fasten the outer shell joint bracket with a wrench. Next attach the mast brackets

to the support pipe. Then connect coaxial cable to the feed point (SO-239 type) through the support pipe. Just before inserting your PL-259 connector, remove the plastic inside the socket. By aligning the holes at the bottom of the antenna and upper part of the pipe, fasten the pipe with lock screw. Just before mounting the antenna, install the radials provided and put it up the mast. Total construction time was around 30 minutes.

## Performance/Tests

I live in an area surrounded by hills and the only repeaters are at least 40 + km away. A recent move of one of the strongest repeaters to my location has put a downhill slide in my activity on VHF. Fortunately, another repeater I am able to access will be linked to the moved repeater.

I decided to mount the antenna on my tower at a height of 10 m. I ran 22 m of RG-213 coax to my station. This coax is a very good coaxial cable for medium runs (under 15 m) on UHF and on VHF for high runs (20-30 m). 15 m of RG-213 on 450 MHz is a 2.3 dB loss which is quite easy to live with. 30 m of RG-213 on 144 MHz is a 2.6 dB loss; this is quite good as well.

I ran the coax in and decided to do a test on the SWR. I couldn't measure the UHF SWR but, if the VHF is good, I can only assume the UHF is the same. The lowest point of SWR according to the charts is at 145 MHz where it is 1.1. It rises to 1:3:1 on 146.500. On UHF it is a different story. The lowest point is at 435 MHz with SWR at 1.1. This antenna may be used with UHF CB as well. I read a review on one of these antennas and found the SWR to be around 1.7 at UHF CB frequency.

The first repeater I chose to hit was

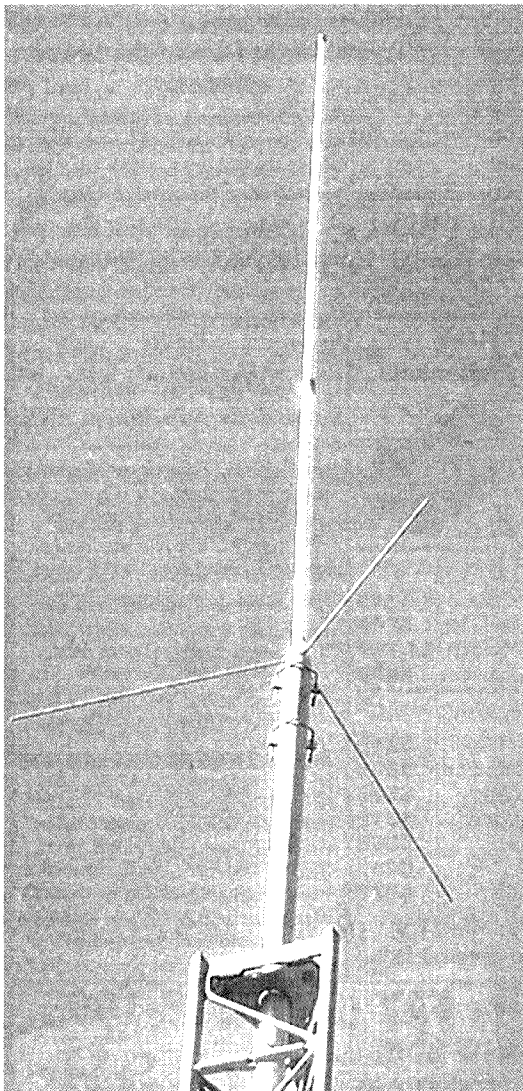

Photo 1 - The Diamond X-200A installed and ready to go.

VK7RTC on Mt Nelson in Hobart. This is a fair signal into here and the only UHF repeater in southern VK7. The repeater came back with a signal strength of S3. I thought, that's strange, it should be stronger than that? I went back up the tower to make sure everything was in place. After talking to another amateur, who said it might be the wind blowing the mounting pipe near the antenna, I lowered it down to a level where it wasn't blowing about as much. The repeater signal jumped up to S6. Any increase in signal is good here!

The next target I chose was VK7RHT on Snug Tiers. This repeater is my main VHF repeater. The signal is normally S3 or 4. The repeater came back at S5. Another station said that it was the best readability he had ever heard me!! I tried another repeater on Mt Faulkner in Hobart. This is blocked by hills including Mt Wellington at a height of 1200 + metres. I got the repeater back at signal strength 1-2. Not the best, but I have another antenna for that repeater.

I then tried to work VK7RAD in Hobart on the Domain. This repeater is completely blocked from me but, with a mobile antenna, I can hear the repeater around an S2 about 2 km down the road. I was hoping the X-200A would pull the repeater out of the noise. It wasn't the case. I tried listening for it when the broadcast was on, and I could just hear it in the noise; however, readability was 0.

Simplex around the local area was outstanding. I was hearing stations I have never heard before. A mobile near Hobart on 2 m was an S2 and steady going through a valley of hills. Also, another station on 2 m was heard. He lives in New Norfolk which is a little town off to the west of me. A huge (500-600 m) hill is directly behind me. This station is located on the other side. The X-200A pulled him out of the noise with an S2 and nice audio.

All in all, the X-200A performed well in most areas. The X-200A is now my main VHF/UHF antenna installed on the top of the tower. My radio shack is just starting to be built and I will be able to reduce my coax line. I hope some increases in signal will happen after I reduce the coax losses by half.

VK7RAA on Mt. Barrow, which is over 160km from here, has been heard and worked about 3-4 times now at about S2. The X-200A was the only antenna that

could deliver a signal out to it and no other antenna on site could work, or even hear, the repeater.

## Instruction manual

The instruction manual is a single slip of paper with lots of clear diagrams and descriptions of the X-200A. When I first looked at the manual, I saw all the Japanese characters and thought to myself, "How am I going to follow just the diagrams"? However, I turned the slip of paper over and found a nice little section in English, with all the required details, including VSWR and the specifications chart needed to construct the antenna.

## Conclusion

The Diamond X-200A is a very nice VHF/UHF base station/portable antenna. It does, though, have limitations when it comes to hilly terrain operating. However, if you can get one of these antennas out in the clear and high up, it may be the best antenna on site. For portable use it's also excellent.

It folds down to 1.5 m (if you want to disconnect the electrical connections inside) for travel or portable and is very useful for base station applications. People in non-mountainous cities, or in the country, should consider an X-200A carefully. If possible find someone in your area who has an antenna like this and try it out. You may be surprised. Many dealers advertising in this magazine deal with Diamond antennas.

My review of the antenna contains my personal views and results may vary depending on a number of factors (e.g. repeater location, conditions, etc).

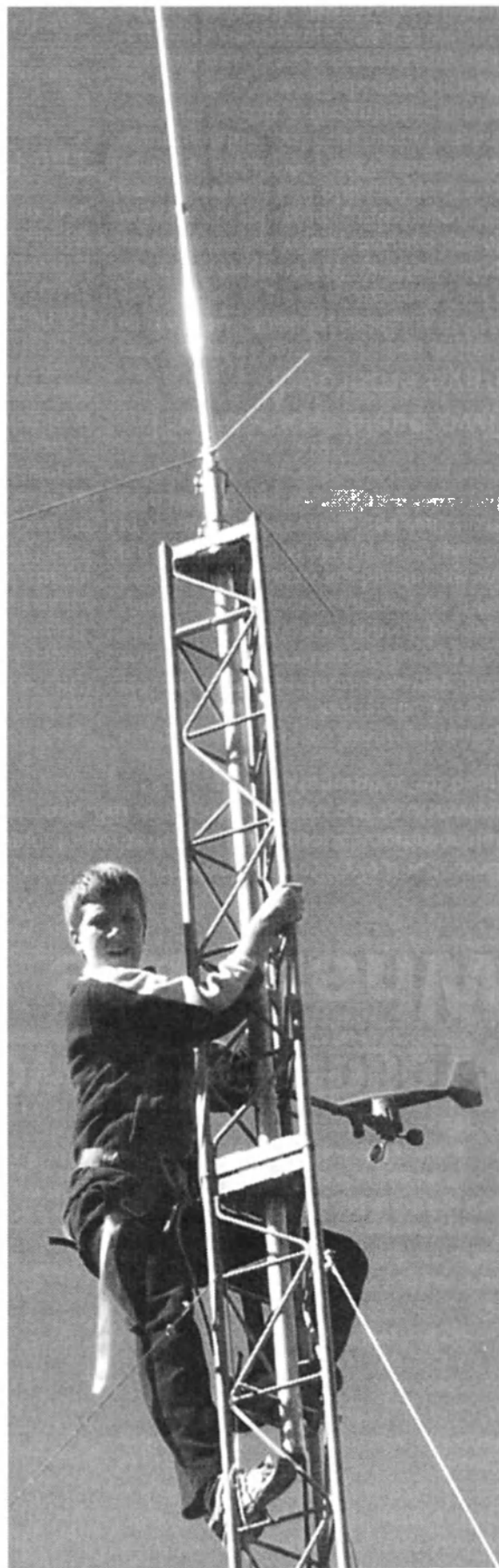

ar

Photo 2 - Installing the antenna was a breeze.

# Know your secondhand equipment

Ron Fisher VK3OM

## SWR and power meters

Not the usual old equipment reviews this time, but a look at possibly the most common piece of test equipment found in the amateur radio shack, the SWR/power meter. The operation and interpretation of these instruments is not always understood, particularly by many new amateurs.

I have always thought that a good way to describe what we see with a typical meter is that a good SWR reading can mean two rather different things. First, you have a good SWR and second, you haven't. We will have a look at some common SWR/power meters and discuss what they can and cannot be expected to do.

I will also give you some idea of what

you should expect to pay for them on the secondhand market. I have decided to make this a pictorial article - with a description of each as we go.

Photo 1 shows a very common meter, often found for sale at hamfests. They come with other brand names but I think they all come out of the same factory. It is an SWR meter only and cannot measure actual power output. It is what is called

a through line meter, which varies its forward sensitivity with frequency. The lower the frequency, the more power is required to give a full scale reading on the second meter.

A transmitter output of 30 or 40 watts might be needed to get a meaningful reading. Obviously not good for a foundation licensee with a 10 watt maximum power limitation. Once you know all this, though, it can be a very useful adjunct to the shack. Having the twin range is a big advantage over a single meter unit. These will

even work with reasonable results on two metres.

So, what are they worth? I have seen them sell at hamfests for as little as \$10, but perhaps be prepared to spend a little more.

Photo 2 is of a meter which is very similar in construction and application to the previous meter. It was originally sold by the VICOM company, early agents for ICOM equipment. All the limitations of meter No 1 also apply to this one.

One difference is that it was supplied with a chart to give an actual power reading. For instance, if the centre knob was set to 7.2 a full scale reading on the "power" meter would be equal to 120 watts. Unfortunately, the chart is often lost with secondhand examples. Don't expect this to be highly accurate but it's perhaps better than nothing. Also, this would only be for a steady carrier and not for a peak reading with SSB. More on this later.

These meters sell for up to around \$30.

Most of the above also applies to the Osker Bloc SWR-200. Unfortunately, I don't have a photo of the Osker Bloc, but they are a very solidly built piece of gear and are often highly prized by their owners. They sell for up to \$50. I believe they are over-rated and, in many cases, overpriced.

Photo 3 shows a Welz SP-15M which is in a different class from the previous meters. First, it uses a toroidal RF pickup system which means that it has a flat power sensitivity right across its frequency range. You don't have to set a critical control to measure RF power. Simply select the power range and there you are.

SWR is measured in the same way, though. Set full scale on the power range and then select SWR. However, even this meter has its limitations. It is very accurate with steady power but it is not designed to measure peak power

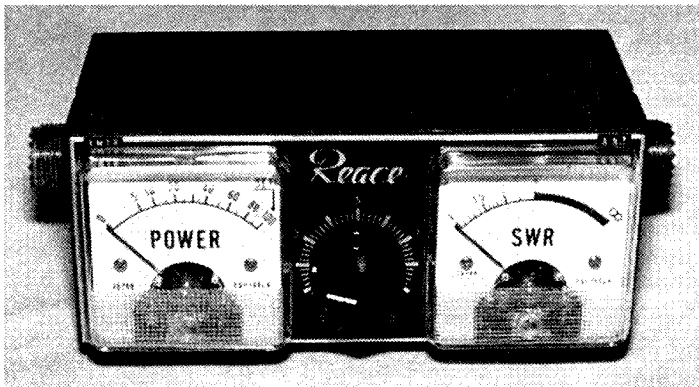

Photo 1

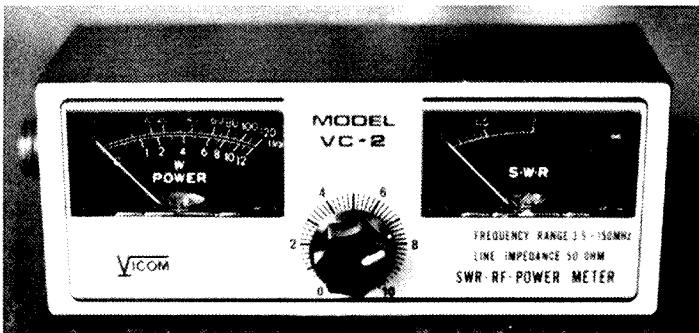

Photo 2

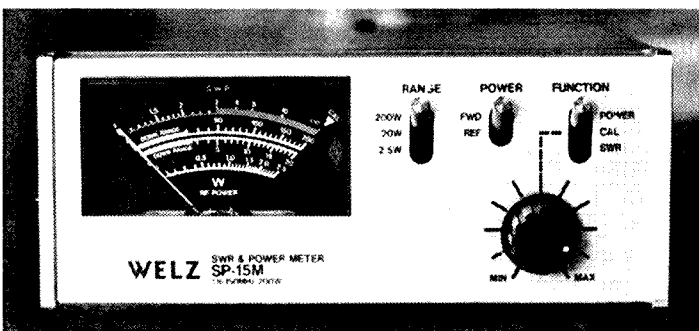

Photo 3

on SSB. We need to go a step further for this. A meter like this would sell for around \$50.

Photo 4 shows a cross needle type which has become very common and popular over the last several years. As far as I can tell, Daiwa were the originators of the cross needle system but it has been copied by others, mainly MFJ.

The Daiwa CN630 pictured is actually for use on VHF and UHF bands but Daiwa produced identical models for HF use. Accuracy is excellent on the power ranges, but again it is not designed to read PEP power on SSB.

Opinion on cross needle meters is divided. I prefer a standard meter for easy reading of SWR but the choice is yours.

A meter of this type would sell for around \$60.

Photo 5 shows another Daiwa cross needle variant. This one was designed for mobile use, but is still very useful in the shack. The same comments apply as for the previous Daiwa model.

Now we come to a different type of power meter. The next two will actually read PEP power for reasonably accurate measurements of SSB output. Again, you need to watch out.

There are two types of PEP meters, passive and active. The active meters include an electronic circuit which, in turn, usually requires a 12 volt DC power input. Some have a DC power supply built in and run from 240 volts AC.

Passive meters use a high value capacitor which the designers hope will charge up to the full peak voltage. Sometimes this will work but often it won't. Some passive meters will give a reasonable reading if the transmit audio is heavily processed which gives the

capacitor more time to charge up. In other words, the active type is much more desirable. The following two are both of the active variety.

Photo 6 is of a Revex which came in several versions. Some were even sold under the Yaesu brand name. Major differences were in power ratings, with some having a 2 kW full scale, others with a 200 watt full scale.

Some had an illuminated meter face, some didn't. Overall they worked quite well with perhaps the only criticism being the rather small meter face. They all require an external 12 volts DC power supply. Depending on just what you want, they can be a good buy. Expect to pay around \$70.

Now we are getting into the "Rolls Royce" class, the Kenwood SW200 (see photo 7) and SW-2000. These have large easy-to-read meter faces which are clearly illuminated. The PEP function is easy to follow and, when compared to professional power meters, they give very accurate indication.

The actual power sensors are external to the meter/control box so you don't have to bring heavy coax cables up to the operating position. And you can connect up to three sensor units to the one controller, perhaps one for HF, one for VHF and one for UHF. The difference between the SW-200 and the SW2000 is the maximum power rating. Both require a low current 12 volt DC supply.

The price? Well this depends on what you get. A

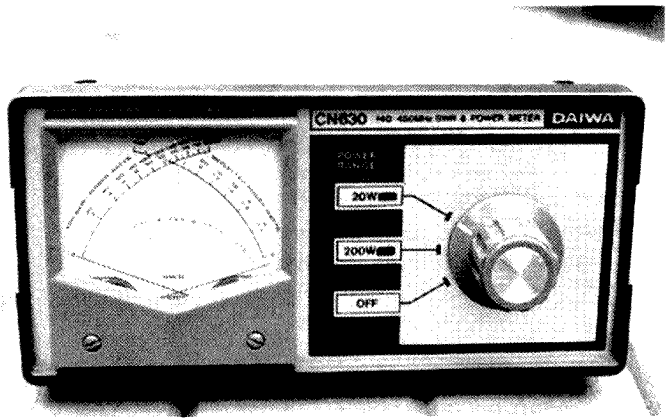

Photo 4

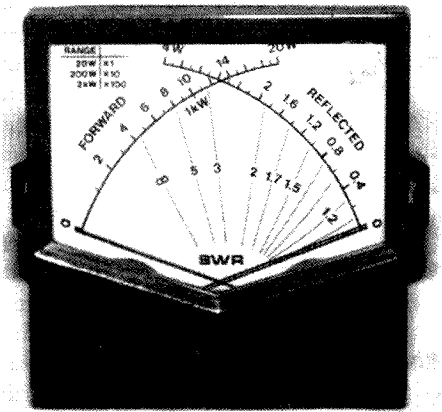

Photo 5

control unit with three sensors might be worth up to \$140. With one sensor, which is the way most come, perhaps \$100. These meters are not all that common on the second-hand market and additional sensors are almost impossible to find. If you have an SW-200/2000, you tend to hang on to it.

I hope all of this might throw some light on what you can expect from the humble SWR meter. Of course, there are dozens of different types out there and I have only covered some of the more common examples that I either have, or have used, over the years.

ar

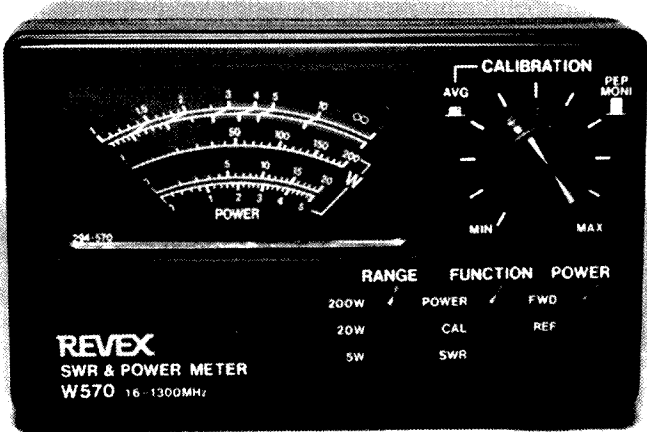

Photo 6

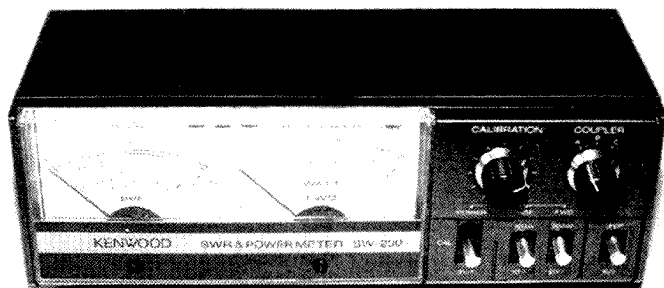

Photo 7

# Technical abstracts

Peter Gibson VK3AZL

## Voltage Conditioners for IC-703 and FT-817

Phil Salas AD5X has described a number of voltage conditioners for two commonly used portable transceivers in two recent magazines.

In *CQ* for June 2005, Phil described a simple voltage conditioner for the IC-703.

In fixed station operation, the power source is not changed often and is normally stable. However, portable and mobile operation requires a little more care in the choice of power supply. Also, it has been reported that some switching supplies put out high transient spikes when turned on.

The schematic of the power conditioning circuit is shown in Figure 1. The heart of the circuit is the 15 volt 600watt voltage transient-suppressor diode and the 5 amp Shottky diode. The transient-suppressor diode will take care of any voltage transients above 15 volts (and can sink up to 100 amps for 10 milliseconds), and the 5-amp Shottky

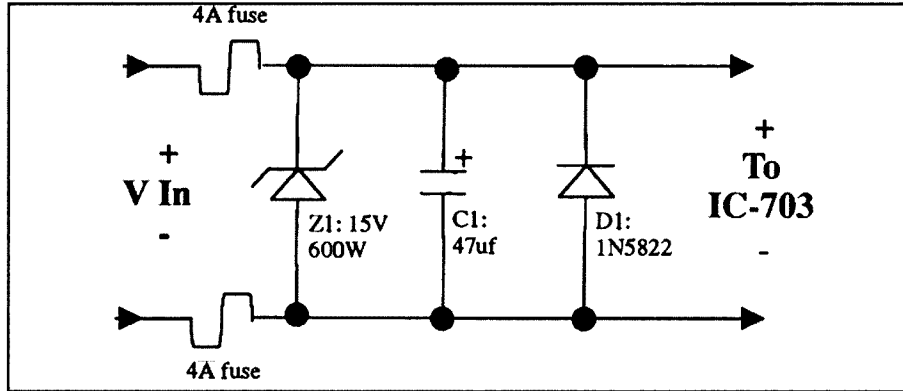

Figure 1 – Schematic of the IC-703 voltage conditioner circuit

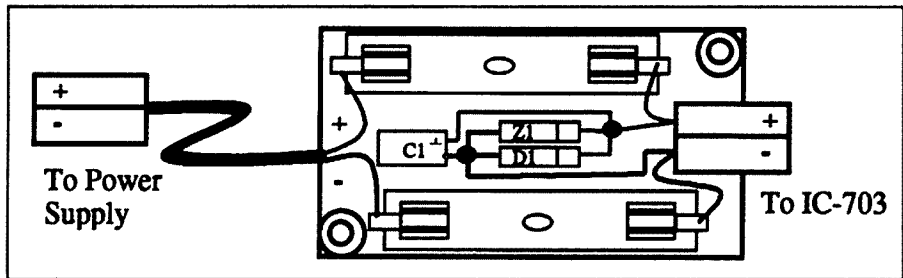

Figure 2 – Internal Component mounting

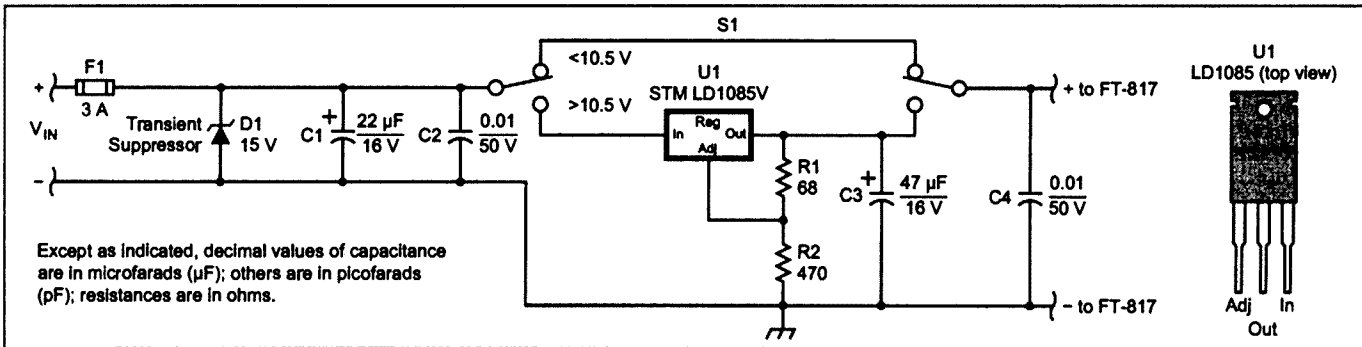

Figure 3 – Schematic of FT-817 voltage conditioner

**NEW CONTEST**  
**QRP Hours**  
**Saturday,**  
**8 April**

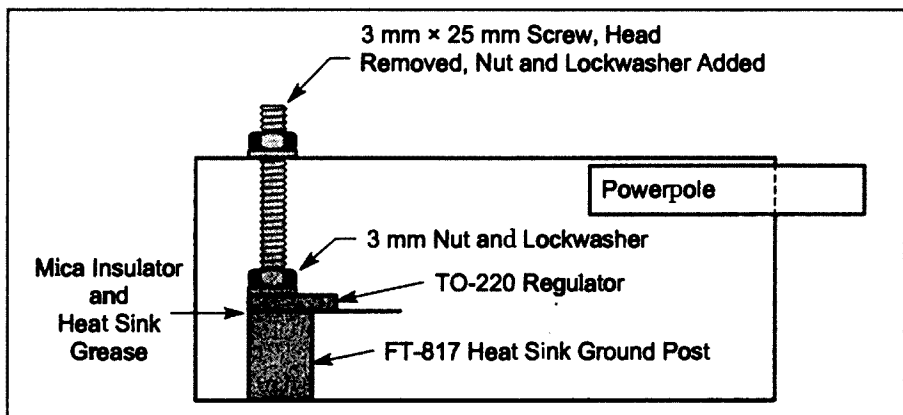

Figure 4 – A side view, showing the regulator mounting



diode provides reverse protection by blowing the fuse. Low frequency capacitive filtering is also included and 5x20mm fuses are used because of their small size and availability.

The circuit is housed in a small plastic box. The layout is shown in Figure 2.

In QST for June 2005, Phil describes a more sophisticated input voltage conditioner for the FT-817. In this case, the aim is not just to protect the radio against transients, but to control the input voltage to minimize power dissipation.

A characteristic of the FT-817 is that it draws the same amount of current across most of the useful voltage range for a given power output. That is, at 5W power output, the FT-817 typically draws 1.9A, whether the supply voltage is 9.6V or 13.8V. Therefore at the higher voltage, you are dissipating up to 8W more power inside the radio.

Therefore, the conditioner not only provides reverse power and transient protection along with inline fuses, but limits the voltage provided to the FT-817 to about 9.6V.

Figure 3 shows the complete circuit of the power conditioning circuit. The heart of this circuit is the STM LD1085V

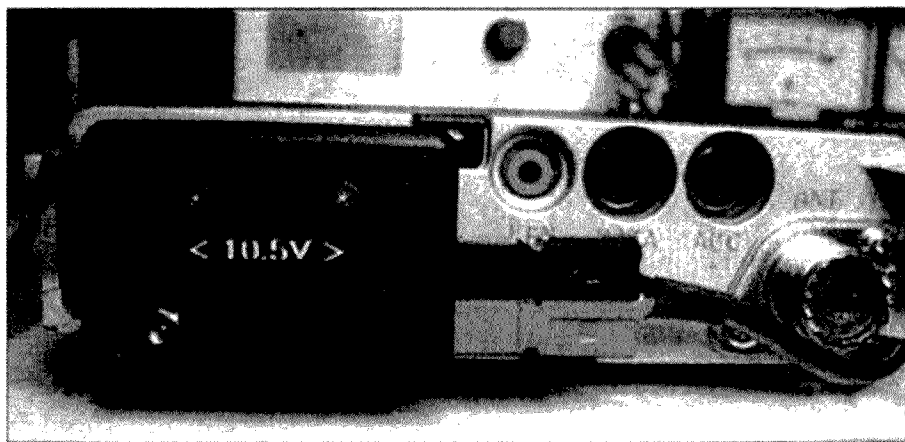

Completed unit mounted on rear of FT-817

low voltage drop-out adjustable voltage regulator. It is packaged in a TO-220 case and is rated at 3 Amp output. At full rated output, only 1.2V is needed across the regulator. The output voltage is set by the two resistors, R1 and R2. In this case, the values chosen give 9.6V output. For both transient and reverse voltage protection, a 15V/600W transient suppressor diode is used. Due to room considerations, the inline fuse is a miniature unit, soldered in place. In addition, a bypass switch is included to

allow external voltage sources less than 10.5V to be used or the higher voltages that are needed for charging the internal batteries.

The unit is packaged into a small plastic box to fit on the back of the radio. The wiring is point to point and the regulator IC is attached to the ground post on the rear heatsink. Figure 4 shows part of the internal layout of the box. The photograph shows a picture of how the unit is mounted on the rear of the FT-817.

ar

## Silent keys

### Clifton John Arnold VK3AJA

20-7-1915—11-10-2005

It is with regret that we advise East Gippsland amateurs and his many on-air friends that Clif has become a silent key. Clif was first licensed in 1947 and operated from his home in Stratford where he had lived since 1922.

Clif was born in Ulverstone Tasmania, but the family moved to Stratford as Clif was beginning his schooling. Clif's schooling at the local Stratford school was cut short because of the depression years and he joined the workforce at an early age, digging sugar beet for the sugar mill at Maffra.

Clif had a distinguished war record. He joined the signal corps at Williamstown before the war, and became interested in Morse code and ham radio. He spent six years in the army, logging 776 days of active duty in New Guinea from 1941

to 1944. Most of the active service was with heavy anti-aircraft artillery battery. Service records indicate that he received a promotion, which he declined, electing to take a demotion and return to active war service as a gunner, rather than remain as an instructor. He was twice mentioned in dispatches.

Photography was one of his passions, having left the family a wonderful legacy of childhood photos. He was a member of the Bairnsdale Field Naturalists for many years and the Stratford Historical Society was another involvement.

Radio played a big part in his life, mainly operating CW, even up to the last month of his life. Sympathy is extended to his family of nieces and nephews.

Bob Neal. VK3ZAN.  
Secretary EGARC

### Alan McCaskill VK4SKL

It is with deep regret that I have to advise you of the passing of Alan McCaskill VK4SKL early on Monday morning 27th February after a short illness.

His voice may be silenced, but his memory will live on in the hearts and minds of those who knew him. It is always sad when we lose a member of our special "community" of amateur radio operators. He recently befriended a newly licensed Foundation level operator in the town where he resided and was helping him to increase his knowledge of the hobby to upgrade at the time of his death.

VALE Alan.

Ed Roach VK3BG

# The man and his shack ~

## Guy, VK2KU, Marulan, NSW

Peter Freeman VK3KAI



Guy Fletcher, VK2KU, was previously located at Hazelbrook in the Blue Mountains, where he was a very well known station on VHF & UHF. He was a regular on the Aircraft Enhancement morning activities. Like many of the weak signal operators in the Sydney region, he regularly appeared in the logbooks of ZL stations when tropospheric conditions arose. He was also active on 2 m Earth-Moon-Earth (EME), but these activities were constrained somewhat by the location and neighbourly considerations. Guy built up a very high score on the Grid Square Standings table, which he instituted and maintains to this day.

He moved to the Southern Tablelands in April 2004, to find an RF-quiet location with no neighbours (the nearest is 1.5 km away), and no significant council problems. This location was chosen with EME activities in mind and is excellent for this purpose and also gives a realistic possibility of applying for a high-power permit. It has a less than ideal outlook in all directions, but still is a reasonable site for tropospheric weak signal communications.

The radio shack occupies a separate room in one-third of a large shed. It is purpose-built, air-conditioned, and has lots of power points. One end of the shack is set up for electronics work, the

other for operating. Any metalwork is done in the main part of the shed.

In early February 2005, a severe thunderstorm moved through the Marulan area. Guy suffered a near miss – a strike “landed” an estimated 150 m from the house and shack, causing much consternation and damaging many items of electrical equipment, including gear in the shack – a “near total wipe-out” in Guy’s own words. Guy took the opportunity to rethink his approach to VHF. He wanted a better receiver than the now-dead FT-736R. The outcome was to use transverters, though this has only happened on 144 MHz at present. All coax, rotator cables, preamp and

relay cables etc now terminate at an aluminium patch panel in the window, and are ALL disconnected when not in use. All earths from towers, shack and AC mains are bonded.

On 2 m EME, Guy uses a 4-bay array of 12 element Yagis of his own design, horizontally polarised on 6 m booms at 12 m, with elevation to 50 degrees. A Yaesu FT1000 MP Mk5 drives an Elecraft XV144 transverter (chosen because of its flexibility in configuration using jumpers, low drive requirement on tx, low noise factor on rx, and OCXO option on 116MHz crystal). In turn, this drives an aging home built amplifier with 2 x 4CX250B tetrodes, which runs at the legal power limit. On receive, RFham preamps (NF 0.25dB) are planned on 144, 432 and 1296, but only 144 is running at present.

As you can see in the photographs, Guy typically uses 2 computers when running EME with JT65 mode. One computer running the WSJT software under Win98SE and locked to GPS time, another connected for internet access, other programs, and a second WSJT receive channel.

The shack contains the following major instruments: HP Spectrum Analyser, VHF Sig Gen (R&S SMS), HP 275 MHz CRO.

Guy lists his major pending radio construction projects as:



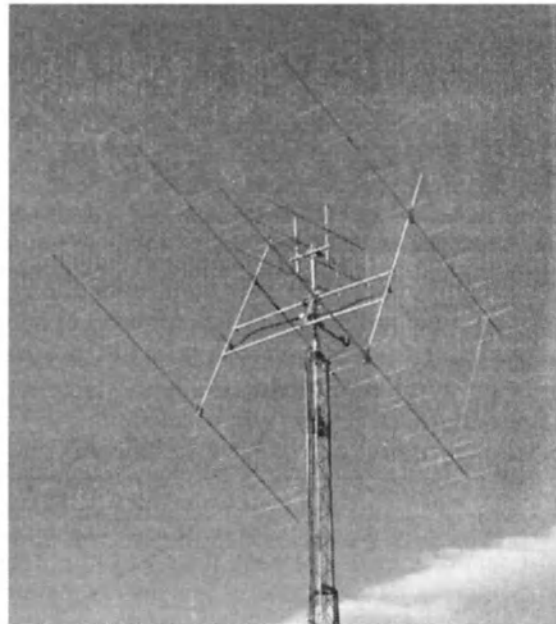

- new g1 and g2 supplies for the linear (half finished for the last 5 years),
- a new linear with more grunt in anticipation of being allowed to run QRO, or at least able to loaf along at present power limits,

- bigger antennas for EME, possibly both V and H (see empty tower)
- GPS locked 10 MHz frequency reference

Guy's major interest is working EME on 144 MHz, both CW and JT65. As at

March 2006, he has worked roughly 260 initials and over 200 grid squares on 2 m EME.

ar

*See inside back cover for colour pictures*

## AMATEUR RADIO BOOKSHOP

**RSGB Radio  
Communication  
Handbook**  
-- 8th Edition

**Edited by  
Mike Dennison, G3XDV and  
Chris Lorek, G4HCL**

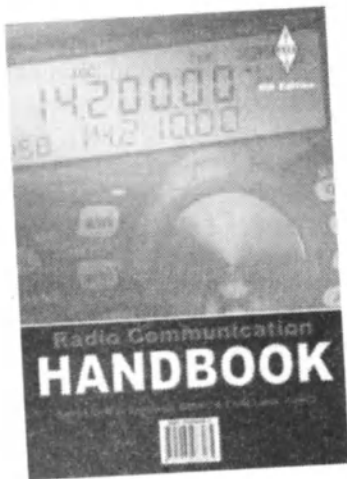

*One of the largest and most comprehensive guides to the theory and practice of Amateur Radio communication since it was first published in 1938.*

*New larger format, with over 1,500 illustrations, 26 chapters and two appendices.*

**BONUS CD-ROM INCLUDED.**

**764 pages. 8th Edition, © 2005,  
Radio Society of Great Britain (RSGB).**

**(ISBN: 0-905086-09-1) #9642**

*Available now from the Amateur Radio Bookshop*

Special  
Offer to WIA  
members.

**QST**  
**Magazine**  
Subscriptions



**Now you can receive QST, the official magazine of the ARRL, delivered to your letter-box !**

**You can take out a yearly or two yearly subscription to QST which also gives you membership of the ARRL.**

*Available now from the*

**Amateur Radio Bookshop  
bookshop@wia.org.au**

# Broadband Powerline Communications: Where are we now?

WIA EMC Group

**Broadband over Power Line communications, BPL, (aka Power Line Communications – PLC, or Power Line telecommunications -PLT), is a method of injecting and carrying high speed data over the electricity distribution network, or the transmission grid. BPL promises a broadband signal at every power connection, without the need for additional cabling.**

Communications over power lines is not new; it has been used for communications and network control functions for many years. Recent availability of low cost semiconductor chipsets, together with increasing community demand for broadband services and improved access, especially in fringe and regional areas, has encouraged development of BPL technologies to meet perceived consumer needs.

## Two basic types of BPL have emerged:

“In-House BPL” carries in-house data within a building typically using “Home Plug” standard modems at each access point. In-House BPL competes with Wi-Fi and conventional wired networks.

“Access BPL” provides broadband access into a building for services such as internet, VOIP telephone services, entertainment, gaming, video, remote meter reading, and other services typically provided by a service provider. The broadband signal is coupled (inductive or capacitive coupling) into the mains distribution wiring typically up to a hundred meters from the customer.

Access BPL may be carried on the local low voltage or medium voltage (LV or MV) distribution network or on the high voltage (HV) transmission network. Often, injection points are located at the medium voltage to low voltage transformer, and a series of repeaters used to increase the range from each injection point to the customer premises.

BPL systems inject multiple carriers on to the power line about every 1 kHz over a very broad frequency range (many MHz bandwidth segmented over the range 3-80 MHz). Each carrier is modulated by the broadband data. Data

speeds of around 200 Mb/s are claimed achievable with the second generation (DS2) chipset. First generation chipsets achieve 45 Mb/s. However, due to the ‘branch and twig architecture’ and inherent difficulties of using a largely unsuitable transmission medium, this speed is greatly reduced in real world networks, with 10 Mb/s probably being more a realistic maximum data rate achievable at the customer’s premises.

Trials of BPL technology are occurring worldwide. Currently there are 23 active trials in the United States (1) and 7 in Australia (2).

In NSW Country Energy (3) has trialled 45 Mb/s technology and in Tasmania Aurora Energy (4) and its telecommunications subsidiary Tastel (5) has the first Australian commercial trial, using 200 Mb/s technology.

## The Pros and Cons

At first glance a broadband power line delivery system appears socially beneficial. The last hundred metre connection into customer premises is often the most expensive element in any service delivery. By ‘illuminating’ the power network, BPL proponents claim to be able to provide quality broadband services quickly and economically, especially in areas not currently well served, (city fringe and regional towns). Further, utilities can lever off existing infrastructure and ‘bundle’ broadband and telecommunications services along with electricity and gas.

Command and control of the power network, automatic load shedding, dynamic pricing, and remote meter reading are increasingly seen as important applications for BPL technologies, especially as energy costs increase and nations attempt to reduce carbon emissions.

However, many believe the potential

social benefits of BPL are outweighed by external costs. Power lines were never designed to carry the high frequency signals used by BPL, and they certainly don’t do it very well, being full of discontinuities and connected to notorious sources of electromagnetic noise. In fact they do it so badly that significant energy must be coupled into the line in order to achieve any useful transmission distance, causing high unnecessary and unintentional emissions across the entire spectrum occupied by BPL system carriers.

The interference potential from BPL to HF radio communications users is continuous, broadband, uniform across the frequency band used by the BPL system, very high level, and geographically widespread. The entire mains distribution system within the service area radiates the BPL signal, and the signal is always on regardless of traffic levels.

The potential for interference to a diverse range of radio communications users is very high, including FM broadcasting and television.

The UK regulator OFCOM performed measurements at Crieff UK, including interference regression with distance.

*Below 30 MHz the magnetic field regression, measured at 10, 30, 100 and 300 metres from the overhead line, was approximately 27 dB/decade and the electric field regression, over the same path, varied between approximately 16 and 21 dB/decade.*

*Above 30 MHz the electric field regression, measured at 10; 30; 100; 300; 1000 and 3000 metres from the overhead line, varied between 10 and 20 dB/decade. (6, 7)*

Interference from BPL systems exceeds the background noise levels at considerable distances from the BPL enabled area.

## International regulations

The International Telecommunications Union (ITU) (8) is the world body for the coordination and regulation of telecommunications. The Constitution of the International Telecommunications Union is the basic instrument of the Union and, together with the Convention and the Radio Regulations, forms a binding treaty to which Australia is party.

Article 15.12 of the ITU Radio Regulations provides as follows:

*15.12 Administrations shall take all practicable and necessary steps to ensure that the operation of electrical apparatus or installations of any kind, including power and telecommunication distribution networks, but excluding equipment used for industrial, scientific and medical applications, does not cause harmful interference to a radiocommunication service and, in particular, to a radionavigation or any other safety service operating in accordance with the provisions of these Regulations. (Note that Article 15.13 imposes a similar requirement with respect to ISM equipment.)*

The amateur service is a radiocommunications service as defined in the treaty.

The Radiocommunications Act, 1992, is the Australian instrument which gives effect to the ITU agreements. Section 197 of the Act prohibits a person from knowingly or recklessly causing interference to radiocommunications (9).

## The ACMA position

The Australian Communications and Media Authority (ACMA) (10), formerly the Australian Communications Authority, (the ACA) is charged with administering the various instruments relating to radiocommunications, telecommunications, broadcasting, and electromagnetic compatibility and susceptibility, in Australia.

The (then) acting ACA Chair commented: *the challenge for the ACA is to set regulatory arrangements that do not unnecessarily inhibit the adoption of BPL technology but at the same time protect radiocommunications services from harmful interference.*

The ACA published BPL trial guidelines

(11) through a web information portal in order to assist with minimising the potential impact of BPL trials. In April 2005, ACMA released a BPL Discussion Paper (12) which attracted 275 responses (13) from a wide range of organisations.

The majority of the submissions show a high level of concern regarding BPL interference and its management. The lion's share of the submissions--222 in all--came from radio amateurs, including a significant submission (14) from the amateur radio peak body, the Wireless Institute of Australia (WIA).

Others were from telecommunications companies, broadcasters and government agencies. One commenter, telecoms provider Optus, recommended a "cautious approach" and expressed concern over potential BPL interference to its cable services as well as over the issue of regulatory and competition certainty. Broadband cable and DSL provider Telstra worried about interference to its broadband and HF radio services saying its calculations indicate *ubiquitous BPL could have serious consequences for cable modem networks and could lead to significant degradation of VDSL in cases where power and telecommunications lines are in close proximity.* Commenting through their industry association--the Personal Emergency Response Services Association (PERSA), medical alarm providers concluded that electromagnetic interference from BPL to PERS is potentially severe, continuous and widespread. *BPL interference*

*could prevent a call for assistance in a life-threatening situation, resulting in death or injury,* PERSA asserted. Not surprisingly, submissions from the BPL industry recommend less onerous management techniques.

ACMA have indicated they will review the BPL trial guidelines in response to submissions received, have consulted stakeholders, and embarked on a comprehensive examination of the communications regulatory issues.

Clearly ACMA are taking a light handed approach to BPL, not wanting to prevent a potentially beneficial technology from being trialled and further developed, while on the other hand attempting to administer their responsibility under the Radiocommunications Act to licensed radio communications users.

Some suggest ACMA is taking a more economic rationalist position than in the past and, in the absence of conclusive evidence of the economic viability of Access BPL, believe there is no need for immediate regulatory action - i.e. the problem may simply go away.

## The extent of the interference problem

The ACMA measured unintentionally radiated interference emission levels at BPL trials in Queanbeyan and Moruya NSW. Their report "Queanbeyan BPL Trial Measurement February 2005" (15) compares measured emission levels with the US FCC part 15 standards. All of the emissions were above the Part 15.209 maximum, and the range was 9

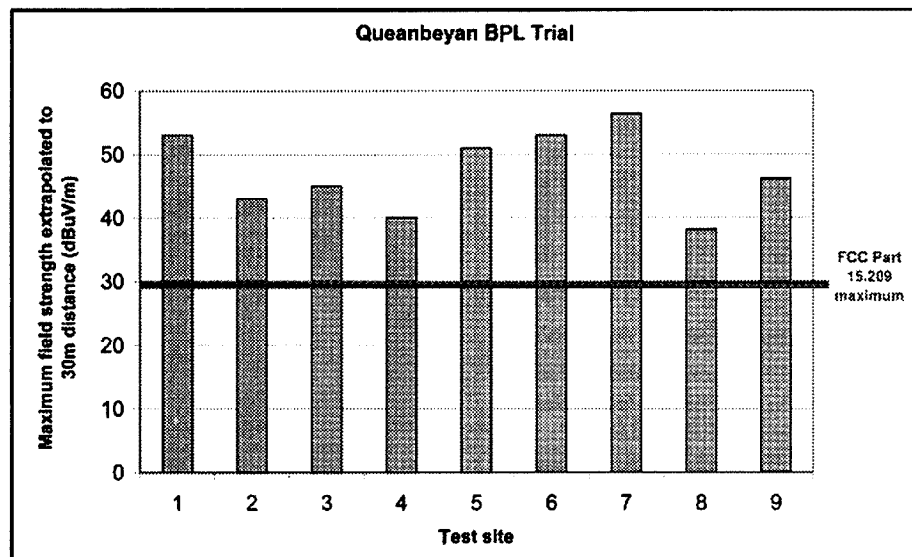

Figure 1. Queanbeyan BPL Trial emissions compared to FCC Part 15.209.

dB to 27 dB in excess, the average of 9 sites is 18 dB in excess of the Part 15.209 maximum.

Telecommunications and IT consultant Owen Duffy, (VK1OD), published the measurement data of the Queanbeyan trial in graphical form, on his website (16). The chart, which is Duffy's

presentation of the ACA's measurements documented in their published report, is reproduced in Figure 1.

Duffy draws the conclusion, *An amateur radio station located in a residential environment where a similar BPL system was deployed would not be safely able to transmit at all on the 7 MHz, 14 MHz, and 21 MHz bands because of the high risk of interference to possibly active stations that would not be heard through the BPL interference, effectively curtailing all activity on the band by such a station.*

To date, traceable interference measurements have not been published for the Aurora Energy trials in Tasmania using the new 200 Mb/s technology. Aurora is continuing to make changes to the technology, and ACMA have indicated that they will not take measurements themselves while changes are likely to be made (naturally, the results could easily be discounted).

Radio amateurs have made

measurements at the Aurora Energy trial using a new technique for measuring field strength developed by Duffy and Hare. FSM (for Field Strength Meter) (17) is a software application that extends a conventional SSB receiver to allow measurement and calculation of field strength of radio signals or interference.

FSM measurement data and observations by amateur radio operators suggest that the interference levels from the new technology Aurora Energy trial are also high, though possibly not as high as earlier 45 Mb/s technology trials such as Queanbeyan (18).

One local Hobart radio amateur has filed an interference complaint with both Aurora Energy and ACMA.

Aurora claimed to have achieved a "90% reduction" in emissions after making modifications to the coupling method. Although a "90% reduction" might sound a lot to a lay person, it amounts to only a 10 dB power reduction

www.pca.cc  
 Email from anywhere  
 via **Winlink**  
 2000  
**Use PACTOR-3**  
 on HF to send  
 Mail, Grib Weather,  
 Weatherfax & Images  
 Contact marc@pca.cc  
 Sydney 02 8902 0107

VX-150 2m H/Held  
 Special Buy  
 Only \$249.00!

Visit us at  
**www.gccomm.com.au**  
 for new product updates!

# G&C COMMUNICATIONS

Authorised dealer for Icom YAESU Kenwood Barrett RFDS GME Electrophone Uniden

**See us for CAR Stereo too! ~ 'Cranbourne Car Sound'**

**ICOM (Australia) TRANSCEIVERS**

IC-756 Prof III HF + 6M	\$4,999
IC-7400 HF +6M +2M	\$2,699
IC-7000 NEW! HF~70cm Mob	\$2,299
IC-706MKIIG HF-70cm	\$1,449
IC-718 HF SSB	\$999
IC-910H 2M/70cm Multimode	\$2,499
IC-2720H 2M + 70cm D/Band	\$699
IC-208H 2M + 70cm	\$579
IC-2200H 2M H/Power 'NEW'	\$449
IC-T90A Tri-Band H/Held	\$479
IC-V82 2M @7W H/Held	\$349
IC-P7A New Mini D/band	\$395

**2 YEAR ICOM (Aust.) Warranty!**  
 ★ Full Product Range Available! ★  
 Full range of Communications/Scanner Receivers available from Icom, Uniden, Yaesu \$ POA

**Antenna Tuners**

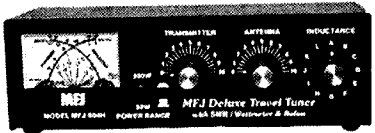



MFJ-902      MFJ-902H  
 MFJ-904H    MFJ-945E  
 MFJ-949E    MFJ-929

**More Details on Website**

**Antenna Rotators**

**G450A (shown)**

G-2800DXC  
 G-1000DXC  
 G-800DXA  
 G-650C  
 G-450C  
 G-5500  
 G-550

**YAESU Transceivers**

FTDX-9000 Elite HF Base	\$16,499
FT - 1000MPMKV Field	\$3,499
FT - 897D HF - 70cm	\$1,399
FT - 857D HF - 70cm	\$1,299
FT - 817ND HF - 70cm	\$1,049
FT - 8900R Quadband	\$ 799
FT - 8800R Dualband	\$ 699
FT - 7800R Dualband	\$ 469
FT - 1802M 2MT 50Watt	\$ 295
FT - 60R Dualband H/H	\$ 369
VX1R w/2 batt Dualband	\$ 249
VX2R Dualband H/H	\$ 329
VX-6R Dual/Band H/Held	\$499
VX -7R Tri-Band H/Held	\$599
VX -170 2M Rugged H/Held	\$279
VR-5000 Receiver	\$1,199
VR-500 H/H Receiver	\$499
VR-120D H/H Receiver	\$ 279

**3 YEAR AUSTRALIAN WARRANTY**

**Proudly Supporting Australian Business**

**3.5 ~ 5.7 MHz Base Antennas**  
 Comet CHA 250B HF Vertical \$699  
 Diamond CP-6 HF Vertical \$499

**TE series EMTRON HF ANTENNAS**  
 Australia wide orders welcome  
 Credit card Cheque Money order

*Call in and see our range of power supplies, cables and connectors*  
**Comet & Diamond**  
 Antennas & Accessories

**207 High St. Cranbourne VIC 3977      Email: gccomm@bigpond.net.au**  
**Ph: 03 5996 3298      Fax: 03 5995 0184      www.gccomm.com.au**

and falls far short of what is required to ensure that interference is not caused to radiocommunications services.

The American Radio Relay League (ARRL) (19) is the peak body representing 700,000 United States radio amateurs. The ARRL states: *Many, if not all, of the BPL designs that have been deployed to date suffer from a number of technological weaknesses. Perhaps the most critical of these is that BPL is seriously degraded by nearby transmissions from low-powered transmitters from sources like Amateur Radio or CB. In several BPL cities in the US, amateurs have done experimentation that shows that as little as 5 watts of power from a nearby radio transmitter can seriously degrade the performance of BPL. In some cases, the interference logged off a BPL user, requiring a reconnection to the network* (20).

Motorola released a new BPL delivery method (21) which it claims greatly reduces the potential interference to (and from) amateur radio stations. Named "Powerline LV," it only uses the local low

voltage LV line from the transformer to the home to deliver the BPL signal, using a "Home plug" type format. Motorola have also included proper RF level filtering for amateur radio frequencies at both the transformer injection point and the in-home modem. Unlike other access BPL technologies, the Motorola system only carries data when actually in use.

However, if the Motorola BPL system was used in Australia, unacceptably high levels of interference to HF users might still occur due to the greater length of line from the MV-LV transformer to the customer premises in our 240 V system, and the likely necessity for higher injected power

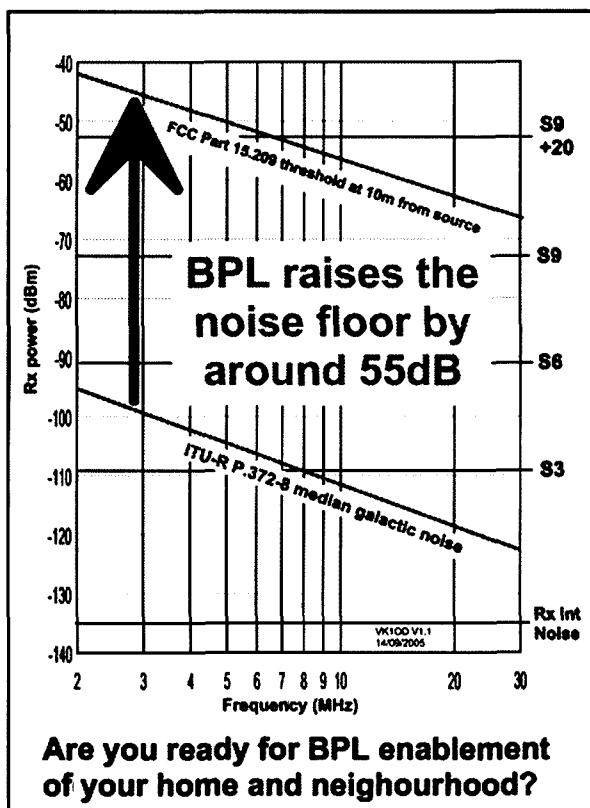

Figure 2

# Australian Radio Industries Pty Ltd

Service to Industry, Commercial, Amateur & CB Radio Applications

The RF Specialists  
ABN: 67 117 379 219

## SPECIALISTS IN

- RG SERIES COAX
- ULTRAFLEXIBLE COAX
- HELIAX CORRUGATED HARDLINES
- WAVEGUIDES & SEMI-RIGID
- HI-TEMP TEFLON COAX
- 450 & 300 OHM TWINFEEDERS
- MULTI-CORE CONTROL CABLES
- ALL COAX / HARDLINE CONNECTORS
- ALL COAXIAL ADAPTORS
- HARD & SOFT DRAWN, COPPER WIRES
- ENAMELLED COPPER WIRES
- COAX SEALING PRODUCTS
- INSTALLATION ACCESSORIES & EQUIPMENT
- CERAMIC AND PVC INSULATORS
- FLAT EARTH BRAIDS
- DACRON UV ROPES
- MOBILE & FIXED ANTENNAS - Cb & Amateur
- BIPOLE & WIRE ANTENNAS
- LIGHTNING PROTECTION & EARTHING
- CABLE ASSEMBLIES

SUPPLIERS, IMPORTERS,  
& MANUFACTURERS

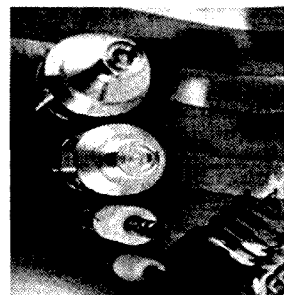

## ARI QUALITY CABLES & PRODUCTS

- RG-213 MIL-C-17D - \$160.00 per 100m
- RG-58CU MIL-C-17D - \$50.00 per 100m
- TIMES LMR400 - \$4.20/m
- TIMES LMR600 - \$8.95/m
- 1/2 inch HELIAX - \$4.95/m
- 7/8 inch HELIAX - \$9.95/m
- 300 ohm Ladderline - \$1.40/m
- 450 ohm Ladderline from - \$2.00/m
- 1.6mm IID Copper wire - \$30.00/Kg
- 3mm Dacron UV/Rot proof rope - \$1/m
- 5mm Dacron UV/Rot proof rope - \$1.50/m
- Hi quality Patch Leads from - \$4
- 20m x RG213 terminated - \$45
- 50m x RG213 terminated - \$110
- 20m x LMR400 terminated - \$110
- Scotch 23 Self Amalgamating tape - \$20/roll
- Hi Power Antenna Baluns from - \$50
- 477MHz 12dB Fiberglass Vertical - \$245

## Australia's largest MFJ Approved dealer

- MFJ-9982 2.5Kw Roller - \$1199 "NEW"
- MFJ-989D 1.5Kw Roller - \$649 "NEW"
- MFJ-986 1.5Kw Roller - \$549.00
- MFJ-962D 800W Roller - \$429.00
- MFJ-969 300W Deluxe - \$329.00
- MFJ-949E 300W Tapped - \$269.00
- MFJ-945E 300W HF+6 mobile - \$195.00
- MFJ-902 150W Travel Tuner - \$260.00
- MFJ-904H Deluxe Travel Tuner - \$449.00
- MFJ-993B 300W Auto/Remote Tuner - \$559.00
- MFJ-994B 600W Auto/Remote Tuner - \$599.00
- MFJ-250 1.5Kw Dummy - \$100.00
- MFJ-264 1.5Kw HF/VHF/UHF Dummy - \$135.00
- MFJ-260C 300W HF/VHF/UHF Dummy - \$75.00
- MFJ-267 HF+6 Deluxe Dummy - \$269.00
- MFJ-269PRO Extended UHF Analyser - \$749.00
- MFJ-259B HF/VHF Analyser - \$409.00
- MFJ-269 HF/VHF/UHF Analyser - \$590

\*\*\* All MFJ catalogue items available \*\*\*

## HEIL MICROPHONES and ACCESSORIES

- PROSET HC4 / HC5 - \$269
- PROSET IC - \$279
- PROSET PLUS - \$369
- GOLDLINE GM4 & GMS - \$269
- HM10 DUAL - \$249
- HM10/5 - \$169
- HM10/4 - \$169
- FS2 PTT FOOTSWITCH - \$85
- HS2 PTT HANDSWITCH - \$65
- TRAVELLER HEADSETS - \$169

## AMERITRON LINEARS & RCS UNITS

- AL-811AX 600W - \$1629
- AL-811HX 800W - \$1999
- RCS4 4 Position Remote switch - \$299
- RCS-8VX 5 Position Remote switch - \$319
- RCS-10VX 8 Position Remote switch - \$339

YAESU ROTATORS, DAIWA SWR METERS,  
PALSTAR TUNERS, HENRY AMPLIFIERS,  
ALPHA DELTA, ARI ANTENNAS

PAY BY - MASTERCARD, VISA,  
BANKCARD

Disclaimer: Prices subject to change  
without notice.

Prices inclusive of G.S.T.

*Make us your last  
call, as we will be  
your first choice on  
Quality, Service,  
Technical advice  
and the best possible  
price!*

Trading Hrs: Mon - Fri 8am - 530pm, Sat - 8am - 12 noon

Office: (02) 4862 2110 BH FAX (02) 4869 4424

EMAIL: sales@arindustries.com.au

WEBSITE: www.arindustries.com.au

to enable the BPL signal to span that greater distance. However, the Motorola system appears to be a step in the right direction.

## The effect on radio amateurs

Amateur radio operators are particularly adversely affected by any interference, because they very often carry on communications using weak signals that are just above the local spectrum noise floor (RF noise background). Hence, signal-to-noise ratios are low – often considerably lower than those normally expected by other services. However, in sparsely settled rural areas, commercial and emergency service users are likely to also need to establish communications at similarly low signal to noise ratios.

Most amateur radio stations are located in suburban areas, where the spectrum noise floor encountered is generally tolerable for the majority of amateur radio activities. A proportion of radio amateurs are located in rural regions, where the spectrum noise floor is comparatively low, which permits operating with lower signal levels.

Amateur radio stations use antenna systems that are typically located within a suburban backyard and are not far from mains power lines. Even in rural areas, radio amateurs locate their antennas close to houses, not far from power lines.

The graph (Figure 2) by Duffy

highlights the harmful effect of BPL operation at the FCC part 15 levels on HF radiocommunications. Australian BPL trials measured to date exceed FCC Part 15 levels (22).

The graph shows the expected receiver input power from the natural noise floor (galactic noise (from ITU-R P.372-8)); and the expected receiver input power from BPL that is of intensity sufficient to result in a maximum field strength of 30  $\mu\text{V}/\text{m}$  at 30 m distance as specified by FCC Part 15.209. Duffy documents the assumptions underlying the model, and compares the model with measurements by Australia's communications regulator (ACA/ACMA) of an Australian BPL Trial of DS2 BPL. The graph's receiver power axis is scaled in both dBm and in "S-units".

## Notes:

The upper noise line is the noise at 10 m from a radiator that is of intensity sufficient to result in a field strength of 30  $\mu\text{V}/\text{m}$  at 30 m distance as specified by FCC Part 15.209. The interpolation uses the factor specified in 15.31(f)(2), and is done to reflect the realistic distance of an amateur receiving antenna from BPL excited power lines or power wiring. The assumption is that BPL operators will operate the system at the highest permitted power level to obtain the best speed/distance performance.

Many of the BPL systems trialed and measured in Australia and elsewhere have had emissions in excess of the FCC Part 15.209 specified limits (see below).

The lower noise line is the galactic noise level predicted by ITU-R P.372-8 formula. Galactic noise is the dominant source of noise above about 4 MHz in quiet locations, and is unavoidable. At lower frequencies, galactic noise may fall off, but man-made noise of similar intensity replaces galactic noise.

All predictions are for a receiver noise power bandwidth (NPB) of 2 kHz. (Nominal 3 kHz SSB voice receivers often have an NPB closer to 2 kHz.)

Rx Int Noise is for a typical modern HF transceiver, older equipment might be up to 10

dB to 15 dB higher.

S values on the right axis are S-meter readings based on  $S9=50 \mu\text{V}$  in  $50 \Omega$  (-73dBm) and 6 dB/S-unit.

## BPL Standards development

Standards development is largely a consensus driven process, and lack of progress towards the development of any meaningful international standard for BPL is a direct result of the huge gulf (some 50-60 dB) between the unintentional emission levels that radio communications users can live with, and what BPL providers can make work. There seems little chance of arriving at any form of consensus anytime soon.

A good overview of the development of a BPL standard is at: <http://www.iee.org/OnComms/PN/emc/Broadband%20RF%20Emission%20From%20Data%20Networks.pdf>

## The BPL Industry response to radio amateurs interference claims

Stakeholders in this battle strongly defend their positions. Radio amateurs proclaim BPL providers are reckless spectrum polluters akin to technological carpetbaggers, and BPL providers view radio amateurs as technological Luddites who would deny broadband to the masses rather than give up their quaint hobby. *We can not have people 'back in the days of pulse dialling systems' lobbying against technology that will bring this country into the 21st century!*

In the face of mounting evidence of BPL generated interference, The PLC Forum (23) proclaims, *Even if the promoters of competing alternative infrastructures may be disappointed... there are still no cases of proven harmful interference despite tens of thousands of users, hundred of thousands of connected properties, and a number of independent and comprehensive measurement campaigns! Moreover, would any local EMC (electromagnetic compatibility) troubles appear, current features of PLC technologies enable the removing of emission frequencies to avoid such troubles.*

BPL proponents continue to deny the harmful effects of BPL interference in the face of enormous evidence worldwide to the contrary. Denying the existence of harmful interference has been the 'modus operandi'. In the beginning, there was no interference, then there

## OzSpid Rotators

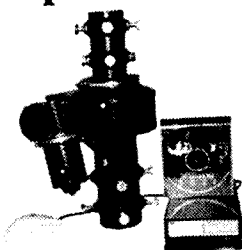

Oceania - New Zealand - Australian Distributors.

Australian Enterprise Industrial

P.O. Box 1013

Browns Plains. QLD. 4118.

Ph. 0414 254 080.

Fax. 07 3800 8003.

[aeitower@spin.net.au](mailto:aeitower@spin.net.au)

<http://www.spin.net.au/~aeitower>



was some interference, and now it has become "who needs HAM radio?"

Ed Hare is the technical manager for the ARRL. Hare puts it this way:

*Assume you are a PSK-31 (slow digital mode) operator who has a 10-minute 'brag tape'. 'When you get on the air, a harmonic from your station blanks out your neighbor's TV. He complains. You switch to Morse CW, which "reduces" the interference to a steady on/off blinking. Will your neighbor think that the interference is improved?*

*He complains some more, so you "notch" his spectrum by 20 dB. This "reduces" the interference from complete blanking to a strong herringbone. He can hear the sound now, but the picture blinks on and off with a herringbone under which one can just make out the picture.*

*You then tell him that you have done all that you are going to do, but if he has interference on another channel, you will be willing to consider fixing it. You then tell all of your neighbors that you have fixed his problem, but that he is pretending that you didn't and his complaints are not valid.*

*He knows all this, and, having seen you lie, he knows that if he indicates in any way that the interference isn't quite as bad as it was, he can expect that you will tell all your neighbors that you admitted that he fixed it. And you know that if you do recognize this non-fix as the least bit improved, you will lessen the chances that anyone will require him to fix the remaining, serious interference.*

*This is exactly what the City of Manassas (in the US) and COMTek (a US BPL provider) are doing. Any incremental improvements have not dropped the interference below the level of serious, ongoing, widespread harmful interference. Instead of S9+30 dB, it's now "only" S9. That is not a change in the interference status.*

### Is HF radio dead?

Another pro-BPL argument is that HF radio is mostly dead, and any services that still exist could be moved off HF onto satellite or the internet. However, HF radio is enjoying somewhat of a resurgence. New digital streaming techniques for HF broadcasting, such as Digital Radio Mondiale (DRM) (24) can mostly overcome HF's disadvantages including annoying fading and noise,

and also provide improved sound quality.

Cyclone Katrina (25) and the tsunami in Asia (26) proved beyond doubt the benefit of HF radio, being a simple, easy to deploy, long range communication system which does not rely on any infrastructure. In fact, amateur radio operators are routinely first on the scene at disasters providing critical first line communications until government and emergency communications systems are activated (27).

Australia relies heavily on HF radio. The ACMA licence register identifies 33,000 licensed HF radio users. Military, civilian, aviation, and emergency communications systems rely heavily on HF radio. HF radio is a valuable backup system to other long range communications systems used by many agencies including the Department of Defence.

Clearly, the success or otherwise of BPL depends largely on its economic viability and its ability to attract customers in the face of stiff competition from other broadband technologies. Experience in the US is mixed with some trials claiming success and others terminating for various reasons, including poor economic viability and competition from other technologies.

Many believe if BPL is to find a place it is likely to be in city fringe or regional towns which are not well served by other broadband technologies. Even in these areas, given recent initiatives by Telstra to speed their rollout of broadband optical fibre, the window of opportunity for BPL may be quite short. BPL may find its major application in niche markets such as security, industrial, or in-building applications.

Radio amateurs are not opposed to any technology which will improve access and competitiveness of any service, BPL included. Radio amateurs are strongly opposed to any technology that causes such very high levels of electromagnetic interference they can no longer enjoy their hobby.

### References:

1. <http://www.arrl.org/tis/info/HTML/plc/deploy.html>
2. [http://www.acma.gov.au/ACMAINTER.65640:STANDARD:1047299885:pc=PC\\_2846](http://www.acma.gov.au/ACMAINTER.65640:STANDARD:1047299885:pc=PC_2846)

3. <http://www.countryenergy.com.au/>
4. <http://www.auroraenergy.com.au/>
5. <http://www.tastel.com.au/>
6. [http://p1k.arrl.org/~ehare/bpl/OfCom/OfCom\\_Summary\\_All.htm](http://p1k.arrl.org/~ehare/bpl/OfCom/OfCom_Summary_All.htm)
7. <http://www.ofcom.org.uk/research/technology/cet/powerline/>
8. <http://www.itu.int/home/>
9. <http://www.comlaw.gov.au/ComLaw/legislation/ActCompilation1.nsf/previewlodgementattachments/0E390E6E63310AFBCA2570260025330E?OpenDocument>
10. <http://www.acma.gov.au/>
11. <http://www.acma.gov.au/acmainterwr/lib284/bpl%20access%20guideline%20final.pdf>
12. [http://www.acma.gov.au/ACMAINTER.2163012:STANDARD:pc=PC\\_9240](http://www.acma.gov.au/ACMAINTER.2163012:STANDARD:pc=PC_9240)
13. [http://www.acma.gov.au/ACMAINTER.2490560:STANDARD:1591880964:pc=PC\\_9240](http://www.acma.gov.au/ACMAINTER.2490560:STANDARD:1591880964:pc=PC_9240)
14. [http://www.wia.org.au/BPL/BPL\\_WIA\\_Response\\_to\\_ACA.pdf](http://www.wia.org.au/BPL/BPL_WIA_Response_to_ACA.pdf)
15. <http://www.acma.gov.au/acmainterwr/lib284/queanbeyan%20trial%20feb%202005%20final%20public%20report.pdf>
16. <http://www.vk1od.net/bpl/>
17. <http://www.vk1od.net/fsm/index.htm>
18. <http://reast.asn.au/2006/Tasmanian%20BPL%20Trial%20Emissions%20Measurement%2020060202.pdf>
19. <http://www.arrl.org/>
20. <http://www.arrl.org/tis/info/HTML/plc/degrade.html>
21. <http://www.arrl.org/news/stories/2005/05/23/1?nc=1>
22. <http://www.vk1od.net/bpl/AreYouReady.htm>
23. <http://www.plcforum.org/>
24. <http://www.drm.org/>
25. <http://www.arrl.org/qst/2005/11/KATRINA.pdf>
26. <http://www.rsgb.org/news/tsunami.htm>

# ALARA

Christine Taylor VK5CTY

## New Foundation Licences

Almost every time we listen to our radios these days we hear about a new licensee, and quite a number of them are YLs. Our members have been keen to include these new YLs into the ALARA world, I am pleased to say.

We welcome them all and hope they will get as much pleasure from the ALARA friends they make as we, longer time members do.

We are particularly glad that Mandy, VK4FRST, the first YL F class licensee,

joined up almost immediately and we look forward to welcoming Norma's daughters, Lorraine VK2FICQ, Michelle VK2FMYL and Christine VK2FIZI, because of the link with our earliest years.

I was pleased to get an email from Brenda VK3KT, telling me that, now that her granddaughters have their Foundation licences, there are three generations of YL licensees in her

family (as she also has two sons and two grandsons with licences she can also boast three generations of OM licensees but that news belongs elsewhere in this magazine).

Brenda was Education Officer for the WIA for many years and is well known to readers of AR in that role. The whole story will appear later.

Congratulations to Brenda and family.

## The Gosford Field Day

As usual Dot VK2DB was at Gosford to wave the flag for ALARA, but this year she has provided us with a different sort of photograph of the occasion. The callsigns around the table are, from left to right, Tony VK2TJF, Steve VK2HIP,

Roger VK2FOTO, John VK2ZOI, Greg VK2TEQ, Peter VE2ZPT and Mark VK2FRST.

The other, more normal photo shows Beryl VK2BBM and her OM Doug VK2YI manning the table (Dot cut herself and

her OM, John out of this picture to make a change).

Many people, OMs and YLs stop to chat and look at the material on show which keeps ALARA in the public eye.

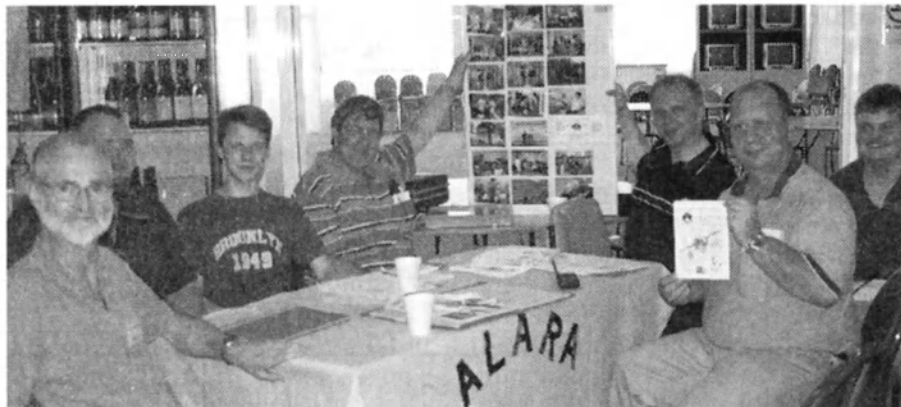

## The ALARA/YL nets

ALARA has a regular net every Monday evening on 80 metres. All YLs are welcome to participate. If you do not have a licence or a callsign, your OM can call in for you and then pass the microphone to you. We will welcome you and as we each take our turn to speak we will probably tell you where we live and perhaps a little about ourselves so you feel you know a bit about us.

There is a Net Controller who calls everyone in and lists the participants in the order they are heard. Then we pass the microphone on to the next one in the list when we finish our over.

The Net Controller sorts it out, so if

we are not sure who to pass the mike to we can pass it back to her. The whole thing is very friendly and easy. Please join us sometime.

The net starts at 1000 Zulu in the summer and 1030 Zulu in the winter and is run on or near 3.580 MHz. The change of time allows us all to get to bed at a reasonable time, regardless of where we live or whether our state has daylight saving or not!

The photo shows Shirley VK5JSH, a regular on a Monday, a picture of concentration; but most of us are also knitting or

sewing while we talk (and make notes of what others have had to say (as Shirley is doing) so we can respond when our turn comes around.



## USA nostalgia

### The ever changing world

The telegram has become a relic of a by-gone past and it looks as if the Morse code may not be too far behind. A message from Western Union said *Effective January 27, 2006, Western Union will discontinue all Telegram and Commercial Messaging services.* The world's first telegram was sent on May 24, 1844 by inventor Samuel F.B. Morse. The message, "What hath God wrought," was transmitted from Washington to Baltimore in the USA. According to an article by "LifeSciences.com", Western Union goes back to 1851 as the Mississippi Valley Printing Telegraph Company. In 1856 it became the Western Union Telegraph Company after acquisition of competing telegraph systems. By 1861, during the Civil War, it had created a coast-to-coast network of lines. With telephone calls being so cheap and internet international, the need for telegrams no longer exists. Ah, those were the days!

## DX Most Wanted

### Geography knowledge

Reading the *DX Magazine* Most Wanted list I was surprised at my lack of geographic knowledge after 65 years of AR. The most wanted DX country is Scarborough Island (BS7H) followed by Lakshadweep (VU7). Other places mentioned were Navassa (KP1),

Desecheo (KP5), Glorioso (FR/G) and Andaman & Nicobar Island (VU4). It's worth testing your knowledge to find these – or ask the children!

## UK: GB2RS digital news

### The RSGB news service is going digital

(Last month I wrote about my experiences with digital voice on HF, now I read the RSGB is already using it – I'm learnin')

Last December RSGB advised readers and listeners some experimental GB2RS news broadcasts were planned for 2006 using digital voice transmissions. The first of these experiments took place from GX0BAA on Sunday 12th February at 2115 UTC. The transmission was on 1.992 MHz using Upper Sideband WinDRM.

WinDRM is the successor of HamDREAM software. DREAM is an open software implementation of Digital Radio Mondiale, which was developed by the University of Darmstadt in Germany. It was later modified by Cesco, HB9TLK, to an amateur standard that fits into a narrower 2.5 kHz bandwidth. The software can be downloaded free from the web.

(GB2RS)

## UK: Lifetime licence

UK telecommunications regulator, Ofcom, has announced its decision to restructure that nation's amateur radio

service with a lifetime licence. That means once someone has passed the test, his licence is good until the day that he or she becomes a silent key.

Ofcom said it was taking the action to reduce the administrative burden on the UK's 63,000 amateur radio users. Under the new regulations, Ofcom will issue amateur radio licences which will remain valid for life as long as the licence details remain correct or until the licence is revoked by Ofcom or surrendered by the licensee. The agency will require licensees to confirm their licence details at least once every five years, but will also provide an online licensing service as an alternative to the postal service. The regulatory agency will also issue electronic licences to users of the online licensing service but will continue to make paper licences available, subject to an administrative charge.

At present, the Royal Mail processes amateur radio licences through the Radio Licensing Center. As of October 1st Ofcom will take over this function, which will include issuing, renewing and amending licences. Ofcom says that this new approach to amateur radio licensing will reduce unnecessary bureaucracy on what it calls a very popular international hobby.

We hope our government body ACMA takes notice and guidance from this development.

(RSGB)

ar

---

## ALARA continued

### A DXpedition to Norfolk Island?

It seems there may be a DXpedition to Norfolk Island this year to help celebrate the sesquicentenary of the landing of the "Bounty" mutineers. ALARA has been invited to send a YL operator but nothing has been arranged to this date.

Watch this space for more information if and when it comes to hand.

Good Luck to the participants, in any case.

### Do you realise how fortunate we are?

As radio amateurs, we can go into another room in our house and talk to our friends or find new friends, without having to drive to their place, or they drive to us.

Think about it.

If someone is off colour, we can call him or her and cheer them up. If someone is lonely they can find someone to talk to without leaving home.

Many nets keep people in contact at regular times, and the regular members let each other know what they are doing and why they may be missing for a while. We can quietly keep tabs on how we are coping with our problems so we, perhaps, know when a visit might help.

All the pain and strain of study is worthwhile.

ar

# DX News & Views

VK40Q

P.O. Box 7665, Toowoomba Mail Centre, QLD 4352.

Email: john.bazley@bigpond.com

The Peter 1st Island DXpedition is now history. I hope you managed to work them at least on one band. The logging facility, which we have come to expect, enabling one to confirm that you are in the log, was a great asset.

Before we move onto other operations, it's worth recording the tremendous effort made by many people to put all the 3Y stations on the air. Bob Allphin, K4UEE, and Ralph Fedor, KOIR, co-lead a 22 member team. Worldwide, many others assisted and supported the operation. The 3Y0X boys were on the air for two weeks, with at times eight stations active, during which they made 87,034 QSO's. An absolutely superb effort.

It is all too easy, to sit in a comfortable shack and wonder why aren't they active now on a particular band, and at a particular time.

It is incomprehensible to a lot of Amateurs why certain people attempt to stop the operation by continuous jamming of their transmitting frequencies. What exactly are these

faceless people trying to achieve? To stop the operation? To inconvenience as many people as possible? They did achieve inconvenience but they will never succeed in stopping an operation. There must be amateurs out there who have some idea where these transmissions are coming from. Recently, Roger, G3SXW made a plea for information regarding these people – so if you do have any information that can help track them down, please contact Roger, G3SXW QTNR.

I have mentioned the possibility of further operations from the Andaman Islands. The current news is that there will be at least two DXpeditions, one by K3LP who requests QSL's via W3ADC and the other by DL7DF who has also announced that he will be active with the following team and equipment: DL7DF, DK1BT, SP3DOI, SP3GEM and SP3CYY, 3 transceivers, a Titanex V80DX lowband vertical, a 5 band Hexbeam, a R7 and verticals for 30 m & 40 m plus laptops, filters etc.

The latter team will be heading to VU4 on April 15 to have enough preparation time. It appears that operating will be for 2 days April 18th to the 20th. QSL the latter operation to DL7DF.

The following précis of the KP5 operation is with the kind permission of Bernie, W3UR, the producer of 'The Daily DX'.

N3KS realised that in November 2005 equipment that his company supplied to the US Government was likely to be used in a planned operation near Desecheo Island. He immediately 'volunteered' to help with the technical aspects of the operation and asked if when their operation was complete could they get permission to land him on Desecheo Island for an official amateur radio operation. Permission was granted just 6 days before the scheduled departure date! With the help of K3LP all the necessary gear was obtained. They planned for a 48 hour operation. Checking with the airline they could not guarantee acceptance of 16 items of luggage for both N3KS & K3LP. They decided to ship as much as they could afford by FedEx to be held at their offices in San Juan. Fortunately the rest of their

luggage made it safely aboard the plane and they collected all the packages from the FedEx offices – so far so good.

With the gear now loaded aboard the vessel they prepared for departure at 0400 Thursday December 15th. By mid-day it was apparent that they would have an opportunity to land. The Captain stipulated that they would land by dingy and that they must set up camp in the vicinity of the helipad and must stick to the area between the landing zone and the helipad.

Access to the landing zone was through a 30' gap in the rocks on the SW side of the island, which is particularly hazardous due to 3 barely submerged rocks. The helipad was 300 yards across uneven rocky terrain, which also included a 6' sheer vertical climb. They decided to take only the absolutely essential items, including two generators, for if they needed anything else a second landing could be made. Thursday night was spent setting up camp and the radio equipment together with a temporary 40 m vertical and the 80 m vertical. N3KS decided to work 80 SSB and after 200 stations were in the log joined K3LP for some much needed sleep!

Then came the task of assembling the two BigSteppIR verticals. They operated during Friday, and then the bad news. A U.S. ham had contacted the U.S. Fish and Wildlife Services and demanded that they stop the operation. This request was made to both the Atlanta, Georgia and Washington DC offices. They were informed of this by the Captain of the vessel who also told them that they would have to end their operation the following evening. They then decided to maximise the number of QSO's and operated with minimal sleep until Saturday afternoon when they started dismantling the station.

Finally two quotes from N3KS.

*I consider the complaints regarding the operation to be a shame, and certainly a violation of DXCC Rule 12 by the guilty "ham buddy" whoever he is but at the time we were in no position to negotiate.*

*In all we made 7,229 QSO's on 7 bands (6 with VK and 13 with ZL).*

## KVK Antenna Systems

### The VK Antenna Handbook for Restricted Spaces

Packed with information on restricted space designs.

### The NuBeam

As seen at Wyong, the reduced size multi-band 2-element beam.

Now you can buy it - 3 or 4 or 5 or 6-band NuBeam 10,14,18,21,28,52 MHz.

Nothing comes close. 7/10/14 MHz NuBeam available to. Imagine - a 7 or 10MHz beam no wider than 7m.

All books available in CD pdf format (less 20%) for quick searches. Check web site for info, pricing and ordering.

For direct purchases

[www.grimshaw.net.au](http://www.grimshaw.net.au)

For credit card purchases:

[www.kvkantennas.com.au](http://www.kvkantennas.com.au)

or ph 07-3216 8060 or

fx 07-3216 8075

We regret not making as many QSOs in Europe and Asia as we would have liked. The combination of exhaustion and the unexpected shortening of the operation prevented us from taking time to round out the log with more areas of the world. Our congratulations to those who did manage to work us, and our apologies again to those who did not get the chance.

Now to forthcoming operations.

The 2006 DXpedition to Glorioso Island (AF-011) is again postponed. In February 2005, an outbreak of chikungunya (a form of viral fever spread by mosquitoes) hit about 20% of the residents on Reunion with 77 deaths linked to the virus.

A conditional clearance to organize the DXpedition to Glorioso (<http://glorieuses2005.free.fr/>) has been given by the military HQ on Reunion. But with the current local health situation (treatment nor vaccine are currently available for chikungunya), the organizers were advised to put it off until October or November.

WB5JAM, Bill, is heading back to St. Lucia and expects to be QRV with a J68 call this time. Look for activity after April 8th. He will be putting an emphasis on 30 metres. QSL via WB5JAM.

8Q7BO (Simon-M0BOX), will be active from 7th to 20th April, 40 metres to 10 metres inclusive on SSB, RTTY and PSK31. QSL to his home call.

3B8/ON4LAC (José) will also be active on SSB, RTTY and PSK31 from 17th March to 13th May. Please QSL via his home call.

VI9NI will be a special callsign from Norfolk Island from May 25th until June 20th to commemorate the 150 years since the landing of the HMS Bounty mutineers. The operation, by members of the Oceania Amateur Radio DX Group Inc., will be on 160 – 6 m CW, SSB and RTTY. There are still operator openings. If you would like to do some of the operating in this month-long event, contact the organizers at vi9ni@wstnet.com.au. Donations to cover shipping of equipment to Norfolk Island are also sought.

GUINEA-BISSAU. Peter, HA3AUI is QRV as J5UAP and is there for a few weeks. Lately he has been active on 15 and 17 meter SSB.

**DXCC NEWS.** The following operations have been approved for DXCC credit: T6X Afghanistan Current operation effective 8 March 2005; D2DX Angola Current operation effective 15 December 2004; TS3A Tunisia 24-28 March 2005; TT8PK Chad 27 December 2005 - 11 February 2006; XW1A Laos Current operation effective 29 October 2005; XW1LLR Laos Current operation effective 29 October 2005; XW1X Laos Current operation effective 29 October 2005; XW1M Laos Current operation effective 29 October 2005.

Special thanks to the authors of *The Daily DX* (W3UR) and 425 Dx News (I1JQJ) and QTC DX PY2AA for information appearing in this month's DX News & Views.

For interested readers you can obtain from W3UR a free two week trial from [www.dailydx.com/order.htm](http://www.dailydx.com/order.htm)

ar

# TET-EMTRON

## NEW!

### TE-33M THREE ELEMENT TRI-BAND MINI BEAM

If you haven't got the room for a full size three element beam, but you want more gain than the two element TE-23M, then this is for you.

#### SPECIFICATIONS

FREQUENCY	14, 21, 28 MHZ BAND
MAX.ELEMENT LENGTH	5520 MM
BOOM LENGTH	4.0 M
GAIN	6 / 6 / 7 DBI
FRONT TO BACK RATIO	20/ 15/ 14 DB
FEED IMPEDANCE	50 OHM
TURNING RADIUS	3.74 M
WEIGHT	12 KG
POWER RATING	2 KW PEP

## RAWMAR ENTERPRISES

40 Blackburn Street,  
STRATFORD.  
Victoria. Australia. 3862

Ph: 61 3 5145 6179  
Fax: 61 3 5145 6821  
Email: [rawmar@hotmail.com](mailto:rawmar@hotmail.com)  
ABN: 87404541761

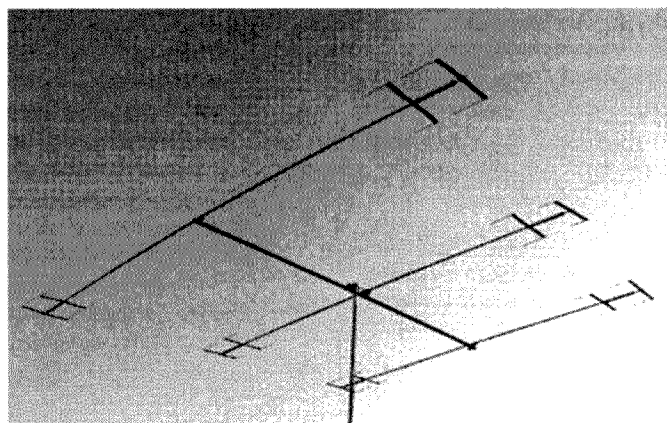

- \*ALL 6000 SERIES ALUMINIUM CONSTRUCTION.
- \*ALL STAINLESS STEEL HARDWARE.
- \*2 KW PEP POWER RATING.
- \*3.74 METER TURNING RADIUS.

#### RECOMMENDED RETAIL PRICE

ONLY **\$858** INCL. GST

If you already have a TE-23M, you can purchase the extension kit containing extra boom, director element, and everything you need to upgrade to this antenna.

Complete kit: \$255 incl. GST.

See Website [www.tet-emtron.com](http://www.tet-emtron.com)  
for dealer list.

## VK5

### Adelaide Hills Amateur Radio Society

Christine Taylor VK5CTY

It was the AGM in February. There were more nominees for the committee than needed so a ballot was conducted. However, the nominee who missed out was co-opted onto the committee to continue the task he had undertaken!

The Committee is now, President Jim VK5NB, Vice-President John VK5EMI, Secretary Leith VK5QH, Treasurer Hans VK5YX, and committee members Jim VK5JST, Barry VK5ZBQ, and Christine VK5CTY, co-opted member Dale VK5DC.

The Dennis Grieg Award was given to Jim VK5JST in recognition of the world-wide use now being made of his "antennalyser". Letters of admiration for the instrument have been coming in thick and fast. Unfortunately Jim was not well enough to attend the meeting that night so the presentation of the plaque was made at his home the next day. Well done Jim.

A photo marks the occasion (though Jim was not feeling or looking his best that day).

At the request of Dennis' widow, one of the plaques was also given to Christine VK5CTY in recognition of the important part her OM Geoff VK5TY had played in AHARS over the last 14 years before his untimely death last year. It was accepted on behalf of the family and will always be a reminder of how important the club was to Geoff.

Several smaller presentations were made in recognition of services to the club. Items bought at the RSGB headquarters will now be used instead of sitting idle.

A world Callbook was given to John VK5EMI to help him in his continuing DX chasing.

The RSGB Journal Archive was given to Jim VK5JST as a keen AR archivist.

A book of Antenna Topics was given to Greg VK5ZBD in appreciation for his video recording of the club speakers, with perhaps a sly dig at the number of antennas that sprout over Greg's home. Hi. Hi.

At the end of the AGM a general meeting was held during which a minute's silence was held for Doug VK5DUG who became an SK recently. Doug had been a stalwart of the club for many years undertaking many tasks on the club's behalf.

A short talk was given that night by Rob VK5RG about the amount of technical information that is

available in the various radio magazines on sale around the world.

He mentioned such topics as the accuracy or otherwise of a comparison of forward and reverse power when tuning up; using an inverted Vee versus a horizontal dipole; bar LEDs versus analogue SWR meters; the importance of the height above ground of an antenna, the problems of suburban backyards and much more food for thought.

He recommended members avail themselves of some of these books in the club library and in the bookstalls, perhaps so as to appreciate these topics when they come up in discussions.

### Lower Murray Amateur Radio Club

Christine Taylor VK5CTY

The LMRC is planning to have a display station at the Mannum Show this year, so if you are planning to go there make sure you look for them and give them some encouragement. Alternatively listen out for them at the time.

They are also planning to start up a regular 2-metre net on the RMB repeater to accompany their regular 80-metre net.

These sorts of activities are encouraging for the continued growth of amateur radio.

### Harry Angel Memorial Contest

*April '22*



Presentation of the Dennis Greig Award to Jim VK5JST by Jim VK5NB

## Fleurieu Peninsula Group

Christine Taylor VK5CTY

This group met again for a luncheon at the end of February and later repaired to the home of Garry VK5ZK for coffee.

A new couple attended, Harry VK5HR and his XYL Clare. Harry is a commuter like you wouldn't believe, travelling between Goolwa and Nhulunbuy, spending a little less than half his time up north and the rest down south.

As usual the range of topics of conversation was very wide, but something overheard suggests that Garry ALMOST made a 2-metre contact with a ZL station using, what they decided afterwards, was a combination of meteor scatter and tropospheric propagation. Maybe next time Garry.

It is usual for the amateurs to migrate to Garry's shack. The photo is all of us gathered in the shack. The radio gear is hidden behind the bodies!



## VK3

## Amateur Radio Victoria News

Website: [www.amateurradio.com.au](http://www.amateurradio.com.au)

Email: [arv@amateurradio.com.au](mailto:arv@amateurradio.com.au)

Jim Linton VK3PC

### Commonwealth Games Stations

At the time of writing these notes, the two Commonwealth Games special event call signs, AX3GAMES and AX3MCG, were in their final week of operation. By any measure it has been possibly the most successful such activity for many years.

Although the contact and country tally of the 17 rostered members of Amateur

Radio Victoria won't be known until all logs are in, there are thousands of QSOs and as well a long list of countries worked.

The next big task now under way is to collect suitable images. Perhaps a few members who attended the Commonwealth Games might like to send a few of their photographs - particularly of competitors.

### Catch-Up Post-Games

An enormous drain on resources and other dislocations occurred in Victoria for many months prior to and during the Commonwealth Games. Lots of people, both professionals and volunteers alike, had commitments to this major sporting event and associated cultural activities.

For example, the long overdue replacement of an antenna for the North-East Victoria repeater VK3RNE faced further delay because riggers were fully committed with the Games and also at a correctional centre installing various lighting, surveillance, communications and other services.

It also put back planned work at Amateur Radio Victoria rooms, 40G Victory Boulevard, including cabling for an upgraded computer system and installation of a 'club' radio station.

The ARV Council at its March meeting approved the necessary expenditure for the installation of antenna cabling and masts. The station will be useful in terms of instruction and licence assessments for prospective radio amateurs, and be available for WICEN (Vic).

### Membership grows

Currently we have 670 financial members (including Life Members) and fairly soon the first major renewal notices will be issued as part of the new two-year membership cycle.

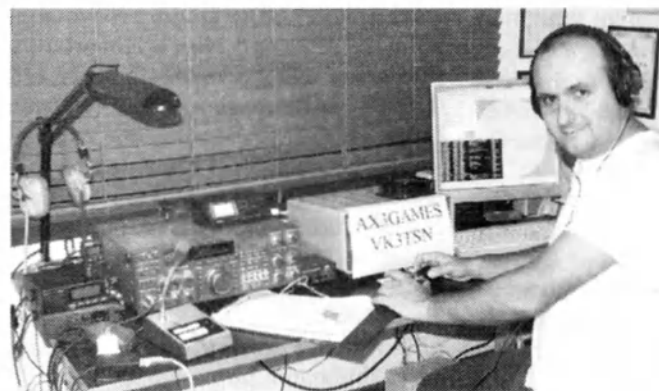

One of the 17 operators to activate AX3GAMES is Stjepan Nikolic VK3TSN

---

# News from...

---

## VK3 continued

As new computer and software updates have not been able to be installed, it has been decided that renewal dates for members falling due before 1 July, 2006, will be extended.

Currently 520 registered members have access to the member's website and also receive monthly e-news bulletins, occasional other news and special offers. If you have an email address please register for this extra stream of membership services.

## AGM next month

Those registered for the members' website will be receiving their notification of the annual general meeting and annual reports electronically. Copies will be mailed to those without email and are also available in hard copy on request.

The AGM date is Wednesday 24 May 2006 at 8.00 pm – St Michael's Hall, Victory Boulevard, near the corner with High Street, Ashburton.

As only five nominations for the 2006-09 Council were received, there will be no need to conduct an election. The nominations are Barry Robinson VK3JBR, Keith Proctor VK3FT, Peter Mill VK3APO, Ross Pittard VK3FCE and myself.

Jim VK3PC

## VK2

Tim Mills VK2ZTM.

Members of AR-NSW should by now have received the posting of Notice, reports and agenda for the AGM which will be held on Saturday, 22nd April.

Over Easter, the annual Urunga Convention will be held at the Mid North Coast village of Urunga. It commences Saturday morning and concludes Sunday afternoon. It has several fox hunts, both vehicle and on foot. The hall is the centre of the social side of the Convention. Visitors should make their own arrangements for accommodation.

It is still a couple of months away, but mark up the calendar for the Oxley

Region Field Day over the June long weekend in Port Macquarie.

Several clubs and groups are now providing Foundation training and assessments. So that as many likely candidates as possible are informed, would you let VK2WI NEWS know of the dates, location and contact point so that it can be included in the news sessions. At the same time, you should approach your local electronic parts sources, local media - print and radio, and the community notice boards in shopping centres.

The benefit of surge suppressors came

to the fore with another storm passing over VK2WI, mid February. On the FAX machine was a combined telephone - power version you plug into a power outlet. The FAX survived intact but the unit was toasted on both sides of the protection circuits. Other damage was mainly to switching chips. All continuous running power circuits have had their surge suppressors replaced to give them all a new start in protection. At less than \$10 for a power only, and up to \$20 for a combined power and telephone unit, they are a good investment.

73 VK2ZTM.

## VK7

Justin Giles-Clark, VK7TW  
Email: vk7tw@wia.org.au  
Regional Web Site: reast.asn.au

## Athol Johnson Memorial VHF Contest

Remember this contest? It was run from 1960 to 1982 and was a VHF contest in memory of Athol Johnson, VK7AJ who became silent key in 1959. Following the NTARC AGM in February, the perpetual trophy was found. The names that appear on the trophy are a who's who of VK7 VHF amateur radio. In Athol's short time as an amateur (1947-1959), he was acknowledged as one of Tasmania's most progressive VHF amateurs with outstanding skill and technical knowledge. We are currently locating the rules with a view to possibly resurrecting the contest. Watch this space!

## Winston Churchill Fellowship Report released

Mike Harris, VK7ACQ, has completed and released the report of his 2005 Winston Churchill Fellowship project entitled, *A study of new opportunities for Australian Radio Amateurs made possible by changes in the Amateur Radio Licence conditions*. Mike travelled throughout the US and UK gathering information about amateur radio and modes that are not prominent within Australia. The report is available at: [www.pangolin.co.nz/downloads/churchill\\_project.pdf](http://www.pangolin.co.nz/downloads/churchill_project.pdf)

## BPL Interference Watch

Hobart BPL trial emission measurements have been published. Measurements were taken on 20 m in Mt Nelson, Tolmans Hill and North Hobart BPL trial areas using a mobile station and the FSM software developed by Owen Duffy, VK1OD. The conclusion reached is that measurements clearly show that there is a degradation of the noise floor in the trial areas. This is caused by emission levels ranging from 19dB to 45dB above the measured ambient noise floor. The chart is available from VK7 BPL Watch Pages at: <http://reast.asn.au/vk7bplwatch.php>



## Northern Tasmanian Amateur Radio Club

At the NTARC AGM in February Life Membership was bestowed upon Allen, VK7AN, for his tireless work in the club and Brian, VK7RR, for his repeater contributions. A big thank you to Joe, VK7JG, for not once, not twice, but three times climbing Mt Arthur to fix the repeater and thanks also to Brian, VK7RR, who has generously donated a new 6dB collinear antenna for VK7RAB.

## North West Tasmania Amateur Radio Interest Group

Planning for the Marconi Centenary Celebrations is progressing. It will be a four day event commencing on Wednesday 12 July to Sunday 16 July 2006. A reminder of Spectrum Tasmania broadcasts on Monday and Thursday nights at 19:30 local. Spectrum receives reports from all states of Australia as well as New Zealand. There are two new NW APRS digipeaters on VK7RAE (Don Heads) and VK7RAC (Table Cape). Both are on the National APRS Frequency of 145.175 MHz.

## Radio and Electronics Association of Southern Tasmania Inc.

The Domain clubrooms are open every Friday evening from 18:30 local onwards, and the radio gear is just screaming out for new Foundation licensees to come up and use it! There is a fully licensed operator available to assist and Friday

nights are also the computer and network users group meeting, so you can also learn a thing or two about computers. We now have a fast broadband connection available on all our PCs at the Domain clubrooms for members.

REAST now offers a five dollar subscription to full time students who are the second or subsequent REAST member in a household. So - if you've been holding back paying out another twenty five dollars, here's a way to enjoy all the benefits of REAST membership. Talking of membership we reached our 100th member in Tom, VK7FTAA, at the AGM: congratulations Tom.

February saw another three Foundation licensees, congratulation to Chris, Bruce and Megan. Angela and Andrew also passed their practical assessments for their standard licences. We also welcome Ian Ellings, VK7QF, as REAST's second FL assessor. A reminder that Foundation Licence Manuals and CDs are now available for purchase from McCann's Model World in Elizabeth St, Hobart.

The linking of VK7RAD (Queens Domain) with VK7RHT (Snug Tiers) is now fully operational thanks to Dave, VK7DM, and his band of repeater experimenters.

At our March meeting Phil Tompson, VK7SS, from Novaris gave us a detailed illustrated talk on all aspects of lightning, its effects, analysis of strikes on structures, relevant standards and models used to simulate a strike. Phil also covered the research, current protection standards, methods and devices. Thanks to Phil for giving up his time and it was great to see over 30 amateurs along.

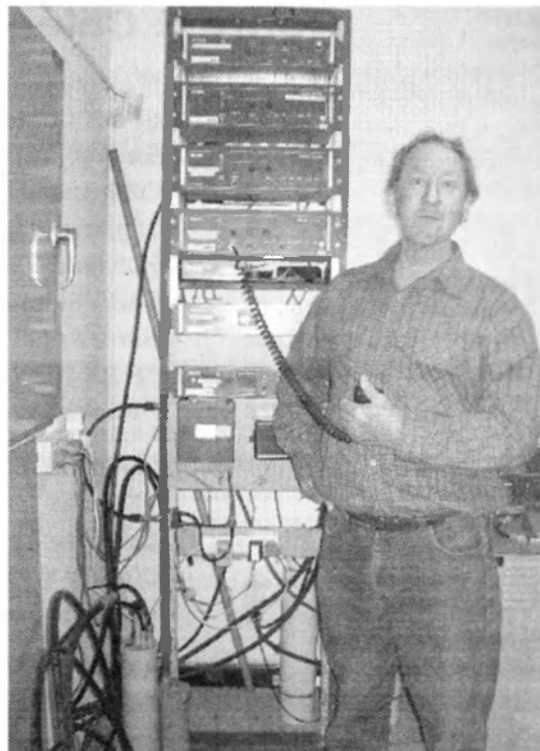

Dave VK7DM, REAST's Repeater Officer (& guru) standing next to VK7RAD!

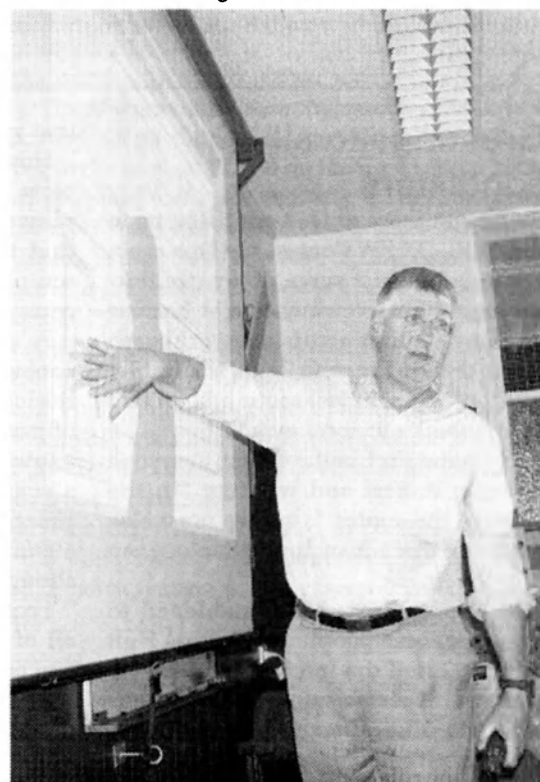

Phil, VK7SS explaining the finer details of lightning protection.

Moorabbin and District Radio Club

## VK3APC HAMFEST 2006

Saturday 13th May 2006

at BRENTWOOD SECONDARY  
COLLEGE

Watsons Road, Glen Waverley.

Melways Reference 71 D7  
(Enter via Heath Street)

Webpage

[www.mdrc.org.au](http://www.mdrc.org.au)

# Contests

Ian Godsil VK3JS  
WIA National Contest Co-ordinator

## Contest Calendar April 2006 – June 2006

April	1/2	Marconi Contest	(CW/SSB/RTTY)
	1/2	SP DX Contest	(CW/SSB)
	1/2	EA WW RTTY Contest	
	8	QRP Hours	(CW/PSK31/SSB)
	8/9	Japan Intl. DX Contest	(CW)
	16	Holyland DX Contest	(CW/SSB)
	15	TARA Skirmish Digital Prefix Contest	(PSK)
	22	Harry Angel Sprint	(CW/SSB)
	22/23	SP DX RTTY Contest	
	22/23	Helvetia Contest	(CW/SSB)
May	6/7	CQ-M Intl. DX Contest	(CW/SSB/RTTY)
	13	VK/trans-Tasman 80 Metres Phone Contest	
	20/21	Baltic Contest	(CW/SSB)
	27/28	CQ WW WPX Contest	(CW)
	27	VK/trans-Tasman 80 m CW Contest	
June	10	ANARTS WW RTTY Contest	(Digi)
	10	Portugal Day DX Contest	(SSB)
	10/11	South America CW Contest	
	10	Asia-Pacific Sprint Contest	(SSB)
	17/18	All Asian DX Contest	(CW)
	24/25	Marconi Memorial HF Contest	(CW)

## Greetings to all contesters

As I begin these notes I am listening to the ARRL DX CW Contest and I am again reminded what a surge of joy can flow through the nervous system at hearing so many stations across the world each doing their bit to contribute. I hope that many of you will feel something of that as you work our local events.

We hope and believe that everyone is being honest and working "in the spirit of the contest"; but we must also recognise that advancing technology can blur the lines.

In this context, I was saddened to hear that some people in the Ross Hull Contest "used the Internet to complete contacts". This is a quote from someone who had himself taken part, then saw the Internet exchanges and decided that he could not submit an entry knowing

that such practices had taken place.

How sad from an idealistic point of view – how typical from an everyday viewpoint. Nevertheless, it shows that there are those who still have scruples about using modern technology correctly.

A more difficult area is the WW contests. CW QSOs are done entirely by the logging programme (with the option of manual sending usually available). I know people who regard this as not in a contest's spirit; but it is now widely practised, like automatically giving 599/59 reports irrespective of real signal strengths.

I conclude this section by hoping that all of us in VK and ZL will be honest and at least discreet if we should be on the borderline between older and newer practices.

## Short and Sweet – QRP Again

You have seen me refer previously to the challenge presented by using low power on the HF bands. Within Australia this can be either hard or easy – easy if you are happy to work within your State and hard if the east coast is trying to work the west.

To put these ideas to the contest, the CW Operators' QRP Club will run a brief contest called "QRP Hours" (see details below).

Because the Club supports all forms of QRP work, it invites all licensed HF operators to join in on this occasion. Please note date and times in your diary now – you will be very welcome.

A check of the dates above will show that there will be several local contests in April. Now is the time to check that your station is working at good efficiency and that you, the operator, are comfortable in your operating position.

Only the other day I learnt that the 10th March was apparently the 30th anniversary of the founding of the Radio Amateurs Old Timers' Club Inc. To mark this occasion the Club will hold a QSO Party later in the year. Please keep watching for details, especially if you are a member of RAOTC.

### Finally

My thanks to John Spooner, VK4AJS, for the Jack Files 2005 results below. This year's event will be on 15th July and even though this is in memory of a VK4 amateur (as is the Harry Angel Sprint), it is still open to us all as a recognition of

the contribution of such people. Please give these contests your full support.

Also thanks to John Martin VK3KWA for the VHF results.

Good contesting and 73,  
Ian Godsil VK3JS

## Results of the 2005 Jack Files Memorial Contest.

A good response was shown to the revised Contest format in 2005. Changes were made to try to encourage more people to participate and to bring the contest to more of a national level and not just a VK4 based contest. All feedback received was positive so hopefully word will spread and we will see even more stations joining in 2006.

I must also apologise for the delay in releasing the results. I have shifted QTH, changed email address and had an almighty computer crash in the last 12 months and all 3 events factored towards the delay.

The results for the Jack Files 2005 are as follows.

### Overall Winner

VK4TAA Peter Richardson with 1656 points

### State winners

VK2 – VK2LCD Chris Meagher with 1425 points  
VK3 – VK3JS Ian Godsil with 1365 points  
VK4 – VK4TAA Peter Richardson with 1656 points  
VK7 – VK7VH Vince Henderson with 1368 points.

### Club Station Winner

VK4BAR with a massive 3060 points.

Congratulations to the winners and a big thankyou to all who participated and submitted logs for the 2005 contest. Certificates will be sent to the winners promptly.

I am hoping to see a big increase in numbers this year boosted by the new Foundation Licence introduction.

73s

John Spooner VK4AJS  
Contest Manager

## Results of the 2005 Wadda Cup

### And the winner of the old mug is VK2BPL

The Central Highlands Amateur Radio Club of Tasmania (CHARCT) 2005 80m Dash for the Wadda Cup Contest has been won by Paul Linsley, VK2BPL. Paul is no stranger to contesting and now will add the Wadda Cup to the growing list of contests that he has conquered. Paul came 7th last year and has improved that to first place with 21 points this year. Congratulations Paul on a fine win and we look forward to hearing you next year as the on-air coordinator and operator of VK7CHT/2.

Second place with a score of 19 points was Vince Henderson, Vince was 10th last year and improved his place to second. Great effort with only 2 points separating first and second. Vince will receive the Wadda Cup second place certificate. Well done Vince.

Third place was a three-way tie between Dale Whatley VK3YR, Frank Clark VK7CK and John Laan VK3MGZ. Well done Dale, Frank and John.

The contest was held on Saturday evening, 24th September 2005. Conditions during the contest were generally very good. Most operators were receiving strong signals. There were some steady static crashes during the event and this made contact between distant stations a little difficult. The event is meant to be friendly and fun. It turned out to be just that as many people commented that the Wadda Cup Contest is their favorite event, full of friendly people and heaps of fun. It was also good to see Chris VK3TCC and his sister Rachael VK3HRC who are 12 and 13 yrs old respectively in the contest. Well done Chris

and Rachael with only half an hour operating time each on their father's station. Should be more of it.

The contest Call-back was held on 3.585 MHz immediately after the contest concluded. It was very well supported, considering the number of stations that participated in the score roll call. There were many stations, making just a few contacts, which did not participate in the call-back. We thank them for joining in the contest. If you do have a go at the 2006 contest, even if you make just a few contacts, we encourage all stations to give their score during the on-air score call-back. The score call-back is unique to the Wadda Cup Contest and as far as we know, it is the only contest in the world that has this type of format.

VK7CHT/3 (CHARCT club call sign) was operated by Rob Ashlin, VK3EK, the winner of the 2004 event.

We also thank Vince Henderson, VK7VH and Paul Linsley, VK2BPL, for their relay assistance during the contest call back. This ensured that we had reasonable coverage, for gathering contest scores, around Australia.

Unfortunately the cup will not be run in 2006. To all that took part in the 2005 Wadda Cup Contest, CHARCT says thank you. Your participation is the reason that the event was so popular.

Bob Geeves,  
President,  
Central Highlands Amateur Radio Club of Tasmania.

# Harry Angel Memorial Sprint

Saturday 22 April, 2006 1000z – 1146 UTC

This is an annual Contest to remember VK's oldest licensed operator, Harry Angel. Please note the time length of the Contest—106 minutes, Harry's age when he died in 1998. It is open to all HF operators.

Object is to make as many contacts as possible on 80 metres, using modes CW and SSB. Categories: Single Operator (CW, Phone, Mixed) and SWL. Frequencies: CW: 3500 - 3535 kHz, Phone: 3535 - 3700 kHz. Contacts in DX window not permitted. Exchange RS(T) and serial number starting at 001.

Score two points per CW QSO and one point per Phone QSO.

Stations may be worked once only per mode. Logs must show time UTC, callsign worked (both callsigns for SWLs), mode, RS(T), serial numbers sent and received for each QSO. Send summary sheet showing name and date of Contest, name and callsign of entrant, category entered, address, points claimed and a signed declaration that the rules and spirit of the Contest were observed. Send logs to Harry Angel Sprint, 363 Nepean Highway, Chelsea, 3196, by Friday, 12 May, 2006. Logs may be sent via email to: vk3js@bigpond.com

## 2006 VK/trans-Tasman Contests - Rules

**Helpful Hint ( Particularly regarding "Scoring"):** These Rules cover a variety of operator circumstances, so use a marker pen to highlight those parts that are only applicable to you.

### Contest Dates

80 m Phone	(Cat 1, 2, 3 and 6)	Saturday 13th MAY
80 m CW	(Cat 4 and 5)	Saturday 27th MAY
160 m Phone	(Cat 7 and 8)	Saturday 8th JULY
160 m CW	(Cat 9)	Saturday 22nd JULY

Time: 0800 UTC to 1400 UTC, ( in 6 one-hour stages ).

Note: Best 5 hours to count ( refer "Scoring" ).

### Aims of Contest

- to provide a reasonably short event that doesn't impose too much on family life or sleep time, while giving 6 hours of constant on-air activity.
- to have a format suitable for both the serious and the novice Contester, with a friendly and relaxing atmosphere.

b). to have a fair scoring system that:

- compensates for geographical location, usable band time and the difference in participation numbers between VKs and ZLs to provide a level playing field for all, so far as is possible.
- places the main emphasis on VK/ZL contacts, by awarding bonus points for "trans-Tasman" contacts.
- provides incentive for the clever Operator, by awarding additional bonus points for working groups of "call-prefixes", in any hourly segment.

c). to promote/give encouragement to QRP operators, Foundation Licence holders, and SWLs.

### General

- The Contest is open only to all VK and ZL call-signs.
- The Contest shall be in 6 X 1 hour stages, and stations can only be reworked after the commencement of each hour. However, stations worked during the 5 minutes

# WANTED

*Suitable cover  
photo for the*

## 2007 WIA Call Book

Post to Box 2175  
Caulfield Junction 3161  
or email to: [callbook@wia.org.au](mailto:callbook@wia.org.au)

Eastern and Mountain District Radio Club Inc

# WHITE ELEPHANT SALE

Sunday 9 April 2006  
10.30am

Great Ryrie Primary School  
Great Ryrie Street  
Heathmont  
(Melways 49 K11)

before the hour cannot be reworked until 5 minutes after the hour.

- c). Sequential numbers commencing at 001 shall be given and received for all contacts made during the Contest. (Use of RST numerals is NOT required).

Note: Contest detail, Rules, a suitable log sheet, and auto-scoring logging programs are available on the Contest web-site:

<http://home.iprimus.com.au/vktasman>

Any queries or constructive criticism should be attached to the Log or emailed to: [vktasman@hotmail.com](mailto:vktasman@hotmail.com)

## Bands

*80 metre band, (May, Phone/CW).*

*160 metre band, (July, Phone/CW).*

## Frequencies

80 m Phone:	3.535 to 3.625 MHz
80 m CW:	3.500 to 3.550 MHz
160 m Phone:	1.835 to 1.875 MHz
160 m CW:	1.810 to 1.840 MHz

## Notes:

- It is not in the spirit of the Contest to "park" on a frequency. While this will not be policed, 20 minutes is considered to be the maximum time between QSYs.
- It is not in the spirit of the Contest to make contacts with another station at the same QTH, or in the immediate vicinity thereof.

Modes	LSB (DSB optional for QRP), CW.
Max. TX Power	LSB: 100 watts pep. (QRP 5 watts pep, LSB or DSB / Foundation Licence 10W pep LSB). CW: 100 watts pz. (QRP 5 watts pz / Foundation Licence 4W pz).

## Categories

Cat 1. Single Operator	80 m Phone (Not incl Foundation Licence holders)
Cat 2. Single Operator	80 m QRP Phone (Also eligible to enter Cat 1)
Cat 3. Single Operator	80 m Phone (for Foundation Licence holders - also eligible to enter Cat 2).
Cat 4. Single Operator	80 m CW
Cat 5. Single Operator	80 m QRP/CW (Also eligible to enter Cat 4)
Cat 6. Shortwave Listener	80 m SWL
Cat 7. Single Operator	160 m Phone
Cat 8. Single Operator	160 m QRP Phone (Also eligible to enter Cat 6)
Cat 9. Single Operator	160 m CW

Note: no separate Category for 160 m QRP CW.

## Multi-Operator

- a). Club/Group stations shall be permitted to enter any Category, on the proviso that only ONE Operator is used during each 1-hour segment, to perform ALL functions without assistance. (ie: TX/RX; log and time-keeping). - 2 to 6 Operators may be used.
- b). Club/Group stations must score at least 100 points more than a Single-Operator station, to have outright claim to

any prize (including a VK/ trans-Tasman Trophy). If the leading margin is less than 100, a Certificate(s) will be shared equally with the Single-Operator station, but the Trophy will be awarded to the Single-Operator station only.

## Call-signs

- a). VK4s north of the Tropic of Capricorn shall add "Central" after the suffix of their callsign for all contacts.
- b). QRP/Phone stations shall add "Quebec" after the suffix of their callsigns for all contacts.
- c). QRP/CW stations shall add "/Q" after the suffix of their call-sign, for all contacts.

## Scoring

- a). The final score shall be the sum of the five (5) highest scoring hourly segments, with the lowest scoring hourly segment not counted.

Note: This gives the ZLs the option of working only 5 hours, if they choose not to stay up until 2am to try and improve their score. It gives VK6s (who have only 3 hours competition after 7pm), 5 hrs to complete a full Log, if they choose not to start until 5pm to avoid poor propagation at the start of the Contest.

- b). VK shall be divided into 3 zones (for scoring purposes):

"East"	VK1, VK2, VK3, VK4 (south of Tropic of Capricorn) VK7 and VK9
"Central"	VK4 (north of Tropic of Capricorn); VK5 and VK8
"West"	VK6 and VK0

c).

VK to VK - except VK (East) to VK (West)		= 3 pts
VK (East) to VK (West)	= 3pts + 3 (distance)	= 6 pts
VK (East) to ZL	= 5 (distance) + 1 (band time) + 5 (bonus)	= 11 pts
VK (Central) to ZL	= 7 (distance) + 2 (band time) + 5 (bonus)	= 14 pts
VK (West) to ZL	= 10 (distance) + 3 (band time) + 5 (bonus)	= 18 pts
d).		
ZL to ZL		= 3 pts
ZL to VK (East)	= 5 (distance) + 5 (bonus)	= 10 pts
ZL to VK (Central)	= 7 (distance) + 5 (bonus)	= 12 pts
ZL to VK (West)	= 10 (distance) + 5 (bonus)	= 15 pts

(ie: 5 bonus points awarded for each trans-Tasman contact)

- e). During each 1 hour segment, additional bonus points shall be awarded as follows:

VK	working	4 X VK call prefixes - each group	= 20 bonus pts
VK (East)	working	3 X ZL call prefixes - each group	= 30 bonus pts
VK (Central)	working	3 X ZL call prefixes - each group	= 40 bonus pts
VK (West)	working	2 X ZL call prefixes - each group	= 35 bonus pts
ZL	working	3 X ZL call prefixes - each group	= 18 bonus pts

ZL	working	3 X VK (East) call prefixes - each group	= 30 bonus pts
ZL	working	2 X VK call prefixes from VK (Central and/or West) - each group.	= 30 bonus pts

**Notes:** "Call Prefixes" are identified by the numeral in the call-sign prefix, (except when over-ridden by a "portable" or "mobile" addendum to the suffix, that indicates operation outside the "home" call area). eg: VK3RX port5, and VK4TZ mob5, would both be regarded as VK5s.

"Groups" - each prefix numeral can be used only once in each "group" - each call-sign can be used only once in a group, per hourly segment. Typical examples:

(VK2 + VK3 + VK7)	= a "3 X VK (East) group".
(ZL1 + ZL3 + ZL4)	= a "3 X ZL group".
(VK4/Central + VK6) or (VK6 + VK8) or (VK5 + VK6), etc.	= a "2 X VK (Central and/or West) group" (applies only to ZLs).

If more than one required "group" of call prefixes is worked in any hourly segment, bonus points are awarded for each "group". (eg: VK/East working two groups of "3 X ZL" call prefixes, in one hourly segment, = 2 X 30 = 60 pts). VK working three groups of "4 X VK" call prefixes in one hourly segment, = 3 X 20 = 60pts).

**Help?** Download sample scored log sheet from Contest web-site, or use the auto-scoring computer Logger (ref Home-page menu).

f).	
Base station to QRP	= 2 bonus points to each station.
QRP to Base Station	= 2 bonus points to each station.
QRP to QRP Station	= 4 bonus points to each station.
QRP using personally home-brewed RX & TX equipment, (including kits)	= 1 bonus point per contact.

g). SWLs: To score, the callsigns and contact numbers of both stations in a QSO must be received and logged. SWL stations shall score as for Amateur stations, except that scores shall be calculated for both stations in each QSO. Notwithstanding that, as with Amateur stations, each call-sign shall be scored once only, in each hourly segment (this also applies when calculating scores for "call-prefix groups").

h). **Note:** "Participation Factor"- (to be applied by Contest Manager): The number of participants on either side of the Tasman has a direct effect on the ability to score points from "across the Tasman", - a compensating factor shall therefore be applied in each mode Category, to all "trans-Tasman" contact points (not call prefix groups bonus points), scored by the Country with the lowest number of participants. The factor is the "lowest number of participants" divided by the "highest number of participants" - ("participants" being the total number of stations that participated, from all Logs received, in any one mode Category). eg: 50 ZLs divided by 150 VKs = compensating factor 0.33. - All ZLs "trans-Tasman" points X 0.33.

## Logs Note:

- Log sheets can be downloaded from the Contest web-site.
  - Written Logs can posted, or be scanned and emailed.
  - Computer logging systems (providing information as below), can be emailed.
- a). A separate Log shall be submitted for each Category entered, except that QRP Logs may be used for other eligible Categories.
  - b). A new log sheet shall be used at the commencement of each hourly segment. Number each Log sheet (eg: 2 of 6).
  - c). For each contact, logs shall record call-sign of station worked; numbers given and received, and UTC time (10 hrs behind EAST). To the right, leave columns for "contact" points. At the bottom provide space to record hourly "contact" sub-total; bonus point sub-total, and "hourly" total. (calculate scores after the Contest).
  - d). If six (6) hours are contested, the Log sheet for the lowest-scoring hourly segment shall still be submitted for cross-checking, but shall be indicated as "not included in final score", by writing "LOWEST SCORING HOUR" on top of the relevant page(s).
  - e). Logs, or log entries that are not clearly legible, in the opinion of the Contest Manager, or which are lacking the required information (including scoring and a Log Summary), may be included in the Results, at the discretion of the Contest Manager, but will be ineligible for prizes.
- Note:** Entrants are requested to take the time to submit a proper Log, rather than a "Check-log", which serves little or no purpose, and does not support the viability of the Contest.

## Log Summary

a). Logs shall include a Log Summary, showing:

Name	Phone number (optional)
Address	Category(s) entered
Email address (if available)	Total points score claimed

- b). VK4s in "Central" zone shall identify as such at the top of their Log Summary sheet, by writing "Central" after their call-sign suffix.
  - c). QRP stations claiming points for "personally home-brewed" TX and RX equipment (incl. kits), shall indicate accordingly on their Log Summary, to qualify for "home-brew" bonus points.
  - d). Multi-operator entries shall identify as such, in their Log Summary, after their call-sign. eg: VK7DF (Multi)
- It will be assumed that all entrants submitting a log will have contested in compliance with the Rules, - including operation at the appropriate power output, - and in the "spirit of the Contest", (unless determined otherwise by the Contest Manager). No written declaration is required.

## Lodgement of Logs

- a). Logs must be received either by post, to: VK/ trans-Tasman Contest, 28 Crampton Crescent, Rosanna, VIC. 3084 AUSTRALIA. or by email to: vktasman@hotmail.com in either "Word doc", Excel", or scanned hand-written (if

legible). Use "text file/Notepad" only if above formats are not available.

- b). Closing Dates for receipt of Logs shall be at 0700 UTC on
- |                   |                  |
|-------------------|------------------|
| 7th June, 2006    | (80 m Phone/SWL) |
| 22nd June, 2006   | (80 m CW)        |
| 2nd August, 2006  | (160 m Phone)    |
| 16th August, 2006 | (160 m CW)       |

**Note:** Operators are requested to submit their logs (even if you have a low score, and don't think you will win). This will justify the effort and expense involved by the Contest Manager, and ensure the on-going success of the Contest.

### Awards

<b>VK/trans-Tasman 80 m Trophy:</b>	Highest Log score submitted in any one 80 m Category - (ref Multi-operator Rule)	
Certificate 80 metres	1*	Phone
Certificate 80 metres	2nd	Phone
Certificate 80 metres	3rd	Phone
Certificate 80 metres	1st	QRP Phone
Certificate 80 metres	1* home - Foundation Licence holder	
Certificate 80 metres	1st	CW
Certificate 80 metres	2nd	CW
Certificate 80 metres	3rd	CW
Certificate 80 metres	1st	QRP/CW
Certificate 80 metres	1st	VK
Certificate 80 metres	1st	ZL
Certificate 80 metres	1st	SWL
Certificate 80 metres	Night-owl's award - (Top Phone score in 6th hour)	
Certificate 80 metres	Paddle-pumper's award - (Top CW score in 6th hour)	
Certificate 80 metres	Wooden Spoon award - (Lowest Log score)	
<b>VK/trans-Tasman 160 m Trophy:</b>	Highest Log score submitted in any one 160 m Category - (ref Multi-operator Rule)	
Certificate 160 metres	1st	Phone
Certificate 160 metres	2nd	Phone
Certificate 160 metres	3rd	Phone
Certificate 160 metres	1st	QRP/Phone
Certificate 160 metres	1st	CW
Certificate 160 metres	2nd	CW
Certificate 160 metres	3rd	CW

Certificate 160 1st metres

VK or ZL (if not the Trophy winner)

### Publication of Rules and Results

- a). Rules will be published on the Contest web-site: <http://home.iprimus.com.au/vktasman>. There are links to this site on the: [www.vkham.com](http://www.vkham.com) (under "Radio-related links > DX Contest Information"), <http://www.wia.org.au/WIA> Federal web-site, and most VK State web-sites, [www.nzart.org.nz](http://www.nzart.org.nz) NZART web-site, <http://www.vk4dx.com/> Contest web-site. Rules may be published in "AR" and "Break-in" magazines.
- b). Results will be published on the Contest web-site and links there-to, by the following dates:

80 m Phone and SWL	10th June 2006
80 m CW	25th June 2006
80 m overall results/prize-winners	28th June 2006
160 m Phone phone	5th August 2006
160 m CW	19th August 2006
160 m overall results/prize-winners	22nd August 2006

Results will also be published in "AR" and "Break-in" magazines.



**Become a radio amateur**  
Check out the courses on offer from Australia's premier training institution for radio amateurs and hobbyists.

**Already licenced?**  
Upgrade to the Standard licence using our self paced multi-media CD ROM course. The easiest way to become a licensed radio experimenter.

Discover digital communications, get more power and more bands

**Still want more?**  
Be guided by one of our experienced facilitators using our proven on-line study methods and get your Advanced licence.

**Visit**  
<http://www.radioelectronicschool.com>  
for more information,  
or email the course manager at  
[info@radioelectronicschool.net](mailto:info@radioelectronicschool.net)  
Telephone 07-5573-2795 12-5PM AEST

Amateur radio – a bridge to careers in radio communications technology

ar

## AMSAT-VK Echolink Net welcomes the OZSAT Group

On Sunday 12th Feb 2006, the AMSAT-VK group net on Echolink welcomed members of the OZSAT group.

The OZSAT group (Australian Satellite Enthusiasts Group) is a YAHOO! group and they have a site in the YAHOO! Groups area of the internet. They can be reached at <www.ozsatgroup.info> and you can join the group or read the messages at that site.

Several members were welcomed to

### The AMSAT group in Australia

The National Co-ordinator of AMSAT-VK is Graham Ratcliff VK5AGR. No formal application is necessary for membership and no membership fees apply. Graham maintains an e-mail mailing list for important breaking news and such things as software releases and sched reminders. Contact Graham if you wish to be placed on the mailing list. As a forum for members AMSAT-VK operates two monthly nets.

### AMSAT-Australia Echolink Net

The "Echolink" net meets formally on the second Sunday of each month. Anyone with an interest in Amateur Radio Satellites is welcome to join in and take part. Graham VK5AGR acts as net controller. The net starts at 0500UTC during summer time periods and 0600UTC during winter (standard) time periods. You can join in by connecting to the AMSAT conference server a few minutes before these times.

### AMSAT-Australia HF net

The HF net meets formally on the second Sunday of each month. In winter (end of March until the end of October) the net meets on 3.685 MHz at 1000UTC with early check-ins at 0945UTC. In summer (end of October until end of March) the net meets on 7.068 MHz at 0900UTC with early check-ins at 0845UTC.

- All communication regarding AMSAT-Australia matters can be addressed to:

AMSAT-VK,  
9 Homer Rd,  
Clarence Park, SA. 5034  
Graham's e-mail address is:  
vk5agr@amsat.org

the AMSAT-VK net during the Echolink session and later in the evening on the 40 m HF net. The two groups have much in common and a spirited discussion of OSCAR matters resulted. It's hoped that quite a bit of overlap will occur between the two groups and they will become mutually supportive, perhaps with many shared members.

The re-activation of the HF net that evening resulted in some good discussion. It was thought that despite the vagaries of HF propagation disrupting any HF Australia-wide net, that it might be worthwhile going back to a weekly net meeting time rather than monthly as it is at present. Participation dropped off markedly when we went from weekly to monthly nets, perhaps a return to weekly nets may reverse this trend. What do you

think? Please contact Graham or myself if you have any firm ideas on the subject. We'd like to make a decision on this as soon as possible and advertise any new arrangements.

Many of the OZSAT group are keen HF operators and this may be a good opportunity to breathe some new life into the HF nets which were the lifeblood of AMSAT-VK in the days before the Internet and WWW. (Yes – believe it or not, just 10-12 years ago there was a time before the Internet and the WWW). Out here in the sticks where the only access to the Internet and WWW is via a 28k dial-up line, a lot of the finer points of on-line comms pass us by. I'm sure I'm not alone in this matter. HF scheds form a great part of my own satellite information gathering.

## Exciting news from AMSAT-UK

Graham G3VZV has reported the initial stages of an exciting new satellite project involving AMSAT-UK, the SSETI Association and ESEO, the European Student Earth Orbiter.

ESEO is a satellite planned for launch in late 2008 into a Geo-stationary transfer orbit similar to the initial orbit of AO40 and to those planned for Eagle and P3E.

Graham reported that in December 2005, two AMSAT-UK members were invited to attend a SSETI meeting/workshop at the European Space Agencies ESTEC facility in the Netherlands. The meeting lasted a week and over eighty students from more than twenty European universities attended.

At the meeting the involvement of the AMSAT-UK team with the project was officially confirmed and recognised. The entire team were elected as "Honorary Members" of the SSETI Association in appreciation of their work supporting the previous SSETI Express project. This is a welcome and fitting outcome for the effort put in by the AMSAT-UK SSETI team. We will all owe them a great deal if this project comes on line as planned in 2008.

The ESEO comms system will

initially use commercial "S" band space frequencies but it has need of a redundant communications system, one that can operate in the event of a primary system failure but can also function satisfactorily if/when the spacecraft is not in its intended earth-pointing mode.

This is where AMSAT are planning to assist. The current project calls for a unit that can receive telecommands from earth on UHF (435 MHz) and transfer those to the OBC. Additionally, it must transmit telemetry and mission data to the ground on S-BAND (2.4 GHz). The team plans to use omni-directional antenna systems and a power output of 9 watts.

Now here's the interesting part as far as we are concerned. When in orbit, it is likely that the student experiments will be completed within a few weeks or maybe months from launch, after which time the spacecraft and its electronics will become available to amateurs as a linear mode U/S transponder. Power should be no problem. The solar panels will be deployable and steerable, while the propulsion system will use Nitrogen gas.

It's not without some newer technology



either. The 50 kHz wide mode U/S transponder will be switchable from a conventional linear design to a fully digital design based on DSP techniques using the G6LVB STELLA firmware. Two UHF canted monopoles on opposite ends of the spacecraft will be used to receive signals on U band. The S Band output of 9 watts will feed two turnstiles or quadrilifar helixes. As well as the transponder, the unit will also provide 400 bps BPSK telemetry in AO-40 format. So don't let the dust settle too

thickly on your old 400 bps decoders and keep the software in working order. Signals won't be quite as strong as AO-40 in its hey-day but it should compare favourably with AO-13 and that was a very workable satellite. You'll most likely need to have a reasonably high gain tracking system on both U and S band.

The AMSAT-UK team includes G4DDK, G7OCD, G6LVB, G0MRF, & G3VZV who were responsible for the S-Band transmitter on SSETI Express.

## Space Golf!

The Russians are at it again. There is a rather unusual commercial enterprise planned to take place on and from the ISS in the near future. It involves an international golf equipment manufacturing company.

A crew member will hit a "golf ball" out into space during a spacewalk. That's if NASA approves the safety aspects of the "experiment". So what's that got to do with amateur radio satellites? Maybe nothing, maybe everything.

## Nano-satellites come and go

The current series of nano-satellites is the latest in another possibly worrying trend. They are really tiny palm-of-the-hand sized devices with a lot of electronics packed inside. They are put together as part of a course of study in space engineering science at various universities.

I don't know how others feel about this but it is somewhat controversial. I have no problem with the idea of hands-on education of this kind, it's laudible, it's not new and it must be invaluable to students in the field, but where does amateur radio fit in? They are certainly an exercise in miniaturisation but it's difficult to see how many of these projects advance the state of the art in amateur radio satellites in any way.

Many people I speak to on this subject are of the opinion that the amateur radio component is just a cheap way of obtaining an otherwise quite expensive communications system for the controllers.

The projects are almost invariably short lived, sometimes lasting only days or weeks and there seems to be no long-term planned objectives in any amateur radio sense, the projects sometimes being switched off after the

It's a bit reminiscent of the ill-fated Swatch episode of many years ago. According to the spin doctors the "ball" (no-one's quite sure how big it's going to be) is somehow going to carry a transmitter of some kind and be trackable by GPS from stations on the ground. There is no indication at present of how this is going to be achieved and the whole thing is a bit

initial telemetry collection.

Contrast this trend with the AMSAT-UK involvement detailed above with the SSETI Association and its latest project ESEO. This is a co-operative effort of potentially enormous value to both SSETI and AMSAT. These and similar projects like the Surrey digital satellites of the 1980s and 90s had a planned amateur radio function inbuilt and ongoing. They fulfilled their primary aim of high level technology transfer from Surrey to various other countries and when that mission was complete they went on to be of immense value to the advancement of the state of the art of amateur radio satellites. Systems developed during those projects are finding a place in the current series of flagship AMSAT birds.

Perhaps some of the later examples could take a leaf out of Surrey's book and include some valuable, well planned and ongoing amateur radio functions, or apply for and pay for commercial frequency access for their private projects.

They all deserve our accolades. Due to their willingness to provide SSETI's initial project with real, live, "S" band hardware and vital advice at very short notice, we may well have another high orbiter on which to "work the world". Watch the SSETI web site for breaking news as it happens.

Thanks to Graham G3VZV for this exciting news. I don't know about you but I can't wait to hear the sweet sound of the 400 baud AMSAT telemetry again.

hush-hush. The Swatch episode was similarly quite secret until it suddenly began transmitting in the 2m amateur satellite band. It was ultimately shut down being deemed quite inappropriate. BADR-1 was another example of this type of piracy.

It's to be hoped that this golf advertising effort isn't going to be a repeat. With a bit of luck NASA won't allow it.

**"Hey, Old  
Timer..."**

**If you have  
been licensed  
for more  
than 25 years you are  
invited to join the  
Radio Amateurs  
Old Timers Club  
Australia**



or if you have been licensed for less than 25 but more than ten years, you are invited to become an Associate Member of the RAOTC.

In either case a \$5.00 joining fee plus \$8.00 for one year or \$15.00 for two years gets you two interesting OTN Journals a year plus good fellowship.

Write to  
RAOTC,  
PO Box 107  
Mentone VIC 3194  
or call Arthur VK3VQ on 03 9598 4262 or  
Bill VK3BR on 03 9584 9512,  
or email to raotc@raotc.org.au  
for an application form.

ar

# VHF/UHF - an expanding world

David Smith VK3HZ - vk3hz@wia.org.au  
Leigh Rainbird VK2KRR - vk2krr@wia.org.au

## Weak Signal

David Smith - VK3HZ

Most of the good propagation during February has been across the Bight with numerous tropo enhancement openings between VK6 and VK5/VK3/VK2. Unfortunately, for many hours, the VK6 beacons could be heard bleating away at good strength, but not a VK6 station to be heard. If anyone is thinking of retiring to the southern WA coast, then please take your VHF/UHF station with you, as you'll have a busy time during the summer season.

Brian VK5UBC reports: *The last week of February has provided some excellent conditions to West Australia from both VK5 and VK3. I first heard the Albany beacons last Sunday 26/2. They were then audible morning and evening until Wednesday morning 1/3. During this period many contacts were made with Wally VK6WG in Albany on both 2 m and 70 cm. Stations to work Wally included VK3II, 3AXH, 3HZ, 3XPD, 3WN, 5UBC, 5NY, 5ZBK & 5DK. Signals from Wally in VK5 were often S9. Roger VK5NY also worked Wally on 23 cm.*

*During this period I also worked Frank VK6DM (Albany) simplex on 146.5 FM as well as via the Albany 2 m repeater VK6RAL.*

*Things were then quiet for a couple of days until Saturday evening when again the Albany 2 m and 70 cm beacon were into VK5 up to S9. First contacts were made on Sunday morning (5/3) when I again worked Frank VK6DM via the Albany repeater and FM simplex 5/7. Bob VK6BE (Albany) was worked on SSB 5/5. Later in the morning Roger VK5NY worked Wally 6WG on 2 m, 70 cm and 23 cm.*

*Sunday evening again provided strong signals into VK5 from the Albany beacons but unfortunately there were no operators available in the Albany area. The Katanning VK6 repeater was also heard.*

*On Monday 6/3, things really hotted up. I was able to hear the Mt Saddleback VK6RMS repeater at 6 am and was fortunate enough to catch Max VK6ZER passing his radio at 4.30 am WA time. Wally VK6KZ in Perth was sent a text*

*message and he next came up on the repeater. We then tried the Mandurah repeater 6RMW and this was better still. Wally got Don VK6HK out of bed and he came up on the repeaters. Conditions were also exceptional between VK3 and VK5 and, although I had the beam west, I was also accessing the Mt Macedon repeater and had VK3s calling me. Brian VK5UBC found he could hear the Bunbury and Perth 2 m beacons but despite several attempts with Don VK6HK, contact wasn't made. Don did hear Roger VK5NY but unfortunately Roger couldn't hear Don due to his noise level. Finally, after several hours of calling Cec VK6AO in Perth came back to me on 144.1 SSB. Contact was completed with signals 5/2 over a distance of 2150 km.*

*Several other VK6s were worked on the Mt Saddleback VK6RMS repeater. They included VK6IQ, ZER, HRC & TFL.*

*Conditions to the west finally faded at about 10.30 am SA time.*

Thanks to Brian for that comprehensive report. As demonstrated, it is often handy to have a good FM setup when the 2 m band opens up. Repeaters can act as useful (triggerable) beacons and are much more widespread than beacons, although the re-use of frequencies in different areas can cause some confusion as to which repeater is being triggered. A vertically-polarised Yagi (in addition to the weak-signal horizontal one) is desirable to both reduce repeater interference and eliminate cross polarisation losses that occur if a horizontally-polarised Yagi is used with a vertically-polarised repeater. Although contacts via repeaters do not qualify for distance records, they can, of course, be used to set up direct SSB contacts.

Ian VK3AXH reports that on 28/2, he worked Wally VK6WG on 2 m and 70 cm. Wally was stronger on 70 cm (S9) than 2 m. They attempted a contact on 23 cm but, although Wally reports hearing something, no contact was made. At the time, there was no sign of Wally in Melbourne, only 150 km further on. As an indication of how localised

conditions can be, Kevin VK3WN, only 4 km from Ian, could barely hear Wally on 70 cm, although he did work Wally later in the day. Colin VK5DK who is virtually under the path between Ian and Wally, reports not hearing much at all. Half an hour later, Wally was worked in Melbourne on 70 cm by VK3XPD and VK3HZ.

## Beacons

Ed VK3BG reports that there are two new beacons active in the Cobram area.

VK3RTC on 432.534 MHz is on test, running 12 watts into a vertical omni antenna at 15 m AGL. Keying is a repeated one-minute sequence - carrier for 1 second, CW ID twice at 10 wpm, carrier until 30 seconds then key off until 60 seconds.

The 1296.534 MHz beacon is within 2 kHz of nominal freq, but will need trimming until the crystal ages. The keying sequence is the same as the 70 cm beacon. It is running with 5 watts out to an Alford Slot at 7 m AGL.

Reception reports would be appreciated to Ed at vk3bg@bigpond.com.

## TEP Contacts

Finally, a report on contacts using a propagation mode only available to those in the very north of this country - Trans Equatorial Propagation.

On 26/2, Phil FJ5DX on St Barthelemy Island in the French West Indies worked PP5XX, PU5YFT, PY5EW and PY5HOT in southern Brazil on 2 m. The contact with PP5XX was over a distance of more than 5100 km.

The remarkable thing is that the equipment at Phil's end consists of an IC706MKIIG (50 W) into a 5/8 vertical at 3 m above the ground. One can only think that a TEP opening must provide very strong conditions.

The current VK 2 m distance record was set in 1991 with a TEP contact between VK4BFO and JI7DMB over a distance of 6763 km.

Please send any Weak Signal reports to David VK3HZ at vk3hz@wia.org.au.

# Digital DX Modes

Rex Moncur - VK7MO

Congratulations to Guy VK2KU on working the Peter 1 Island DXpedition 3Y0X on two metres with JT65. Rod ZL3NW and Joel F6FHP achieved a new 6 m EME World record on 3rd March 2006 using JT65A over approx 19,440 km path.

Dave VK2AWD and Rex VK7MO have been seeing the video carriers of the Channel 5a TV stations at Mawson WA on 138.250210 MHz and Newcastle NSW on 138.276025 MHz via EME. Signals are best copied when the moon elevation at the TV station is on the horizon but can be detected up to around 8 degrees.

The stations are seen on a waterfall program such as Spectran or Spectrum Lab with a resolution of around 0.1 Hz. It should be possible to see these stations with a single 10 element 2 metre Yagi although elevation might be required. The Newcastle station is extremely stable and provides a useful calibration reference if your 2 metre receiver will tune down to 138 MHz. Its frequency has been compared to a GPS locked reference and has been within 10 milli-Hz over several weeks with the actual frequency being measured at

138.276025 MHz to an accuracy of better than 0.1 Hz. The signal is almost always available by tropo-scatter in Hobart at a distance of 1162 km by using a very narrow bandwidth of 2 milli-Hz, as is available on Spectrum Lab. It should also be detected via meteors at distances up to 2300 km and by averaging one can establish a frequency comparison via meteors with an accuracy of within a few Hz.

Please send any Digital DX Modes reports to Rex VK7MO at rmoncur@bigpond.net.au.

# The Magic Band - 6 m DX

Brian Cleland - VK5UBC

After the good openings to VK6 in early February reported in last month's notes there has been very few openings reported. Beacons have been heard for short periods occasionally but there have been only a few contacts reported. The only contacts in my log since early February are on 28th February with Neville VK2YO near the Queensland border and Daryl VK4ADM at Maroochydore.

Norm VK3DUT reports despite hearing the ZL TV on many days in February the only contact was with Bob ZL3NW on 7th Feb. Norm also worked Neville VK2YO, Harvey VK4AHW and VK4YRP on the 2nd March.

John VK4FNQ in Charters Towers reports similar lack of openings only working VK5UBC on the 2nd February and John VK2BHO on the 10th. Gary VK4ABW in Townsville also has reported little activity working only one VK2 in February but reports the MUF is reaching the high 40 MHz region with

signals from the North/North West being heard.

Jack VK2XQ advises activity into the Sydney area during February has also been poor with only the odd beacon and ZL TV being heard. Mick VK2BZE did work ZL3NW on 7th February.

Norm VK7AC (ex VK2ZXC) near Launceston worked VK4AHW, ARS & TWR on the 2nd March.

In summary a very quiet February/early March on 6 m.

Bob W6BYA well known Californian 6 m op spent some time with Peter VK4APG in early January and had a get



Left to right: Tom VK4DDG; Bob W6BYA, Alan VK4WR, Scott VK4CZ and Peter VK4APG.

together at Scott's VK4CZ QTH with a few of the local 6 m operators who've worked Bob over the years.

Please remember to send any 6 m information to Brian VK5UBC at bcleland@picknowl.com.au.

# 2 m & 70 cm FM DX

Leigh Rainbird - VK2KRR

Well folks, I think I'll make this my last FM DX column. While it's been fantastic reporting all the rare FM DX openings from around Australia over the past few years, I feel it's now time to move on.

I got handed the reins of the VHF column directly from David VK5KK, and kept the column running with the introduction of the initially controversial 2 & 70 FM DX Report. Fortunately, not long after this was able to team up

with David VK3HZ, who provided the Weak Signal segment, then Rex VK7MO for Digital Modes and recently Brian VK5UBC for Six Metres.

When the FM DX segment started, the Novice licensees were limited to the use of FM only on the 2 m and 70 cm bands. Now with the licence changes which have recently been implemented, these Novice operators are now free to use weak signal modes as well.

The purpose of the FM DX column was primarily to help promote VHF DX to those operators, who at the time were not licensed to use SSB, or who only had FM radios. It also served to dispel a few 'myths' about FM that some believed, such as, 'you can't make DX contacts on FM' and 'vertically polarized antennas are no good for DX'. Well, I think I have raised awareness and helped create a lot more activity in the process.

If anyone is interested in compiling the FM DX column, please contact David VK3HZ or myself VK2KRR via email.

DX openings during February 2006, were mostly found in southern Australia.

On 3rd February there was a massive tropo opening in the south east. Mount Gambier repeater was 5/9+40 here at 633 km. Mt Gambier IRLP repeater was 5/9. Most 2 m repeaters in the Adelaide area and surrounds peaked out at full scale. The Port Lincoln repeater was 5/9 at 1019 km.

2 m FM simplex contacts were completed with VK5MM, VK5UBC, VK5PO, VK5HS, VK5ZCB. Signals were so strong on the 144 MHz band, that I was able to copy pictures sent using MMSSTV from Garry VK5ZK 754 km from Goolwa and from Brian VK5UBC 764 km from Gawler.

On 20th February another good opening occurred in the south, this time extending into Western Australia, though no FM contacts were made that far.

I had quite a few VK5 repeaters coming in - Crafers, Central North (833 km), Cowell (961 km), Port Lincoln (1019 km), Murray Bridge, Barossa Valley, Houghton, Lobethal and Mt Gambier.

In the evening of 27th February, some VK5UBC magic was about. Brian was able to access the Albany repeater VK6RAL at 1900 km on 146.725 MHz. Here, Brian worked Frank VK6DM. The two went to FM simplex on 146.500 MHz and made a weak 4/2 contact at around 1900 km.

Then on Sunday morning 5th March,



Picture sent using MMSSTV on the 144 MHz band

Brian VK5UBC again made the 1900 km trip to the Albany repeater and again worked Frank VK6DM. They then went to 146.500 simplex, where signals were much better at 5/7. In the evening, Brian was able to hear the Katanning VK6RAW repeater at 1950 km.

On the morning of Monday 6th March, Brian was easily able to work into the Boddington VK6RMS repeater on 147.250 at 2062 km. Early on, Brian was lucky to catch Max VK6ZER on the repeater. Later, Brian was also able to work VK6HK, VK6KZ, VK6IQ, VK6HRC and VK6TFL. During the same

opening, Brian VK5UBC also worked to the Mandurah VK6RMW repeater at 2102 km where he again worked VK6KZ and VK6HK. At the same time Leigh VK2KRR was also able to hear the Boddington repeater at 2817 km up to only 4/1. The signal did not get strong enough to work the repeater, which was quite unfortunate.

Thank you to all of you who have sent in FM DX reports during my stay, and those who have made nice comments in regard to the content of the column. Much appreciated. 73 and good DX.

ar

## Over to you

### Are we accepting lower standards?

I'm currently listening to 7.070 MHz. The time is 19:20 EDT. I find the operations by some licensed amateurs and perhaps a pirate station is appalling. Operators, and I use the word loosely, making threats at each other, whistling over each other and discussing tracking operators down to sort them out!

It sounded like the 27 MHz CB band back in the mid-seventies.

I can remember when amateurs took pride in their operating practices and gentlemanly behaviour. If this is what

it is to become why anyone would be attracted to the hobby unless perhaps they are an ignorant thugs. It appears to me and I know I will be condemned for this, but we seem to have been accepting lower standards in more ways than we expected.

I believe that simply ignoring these operating practices and these operators will allow segments of the bands to become no-go ghettos. A completely unacceptable and un-Australian

outcome.

I also believe that the looming threat to this great hobby come from within as much as from outside forces, and therefore suggest that something akin to Intruder Watch be applied to monitoring amateur operations as I think the authorities response will be that we need to self regulate.

I am offering this observation for discussion and will be keen to see what others think!

Peter VK3YSF

**The views expressed in the *Over to you* column are those of the authors, and do not necessarily reflect the official policy of the Wireless Institute of Australia.**

## It's official ...

We are at the minimum of the current Sunspot cycle and propagation can only increase now. I have read some indications that the next peak should be 30 to 50% higher than the last peak. Only time will tell.

I know I have been really praising the [www.dxtuners.com](http://www.dxtuners.com) website in recent columns, but it is so good. Now I have come across a new station from a country I have only heard once before. It is Ethiopia and the only time prior to this was in the 60's when I heard a very weak religious station in English in the 19 metre band. It said it was a Gospel station in Addis Ababa, presumably when the Sudan Inland Mission ran a station. After the 1977 revolution, a pro-Marxist dictatorship ruled the country and Ethiopia eventually drifted into anarchy and civil war.

Recently I came on a signal on 6940 via the Johannesburg Dxtuners site at 0330 and initially I thought the station was identifying itself as Radio Farda, the American clandestine station targeting Iran. News items frequently mentioned Iran and Pakistan. I even enlisted a friend within the Indian Ocean region and he too thought it was Radio Farda. However Glenn Hauser pointed out to us it was Radio Fana and indeed on the 7th of March, I caught the station signing on at 0300 on 6940 as Radio Fana. So I did what comes naturally these days and looked up Google. Sure enough, it directed me to [www.radiofana.com](http://www.radiofana.com) which is indeed in Addis Ababa in Ethiopia. The website was very useful and confirmed the frequency and stated that the station has been operational for ten years. What surprised me is that Radio Fana is also on 6210 and it also came through the dxtuners sites. Sadly there is no propagation from Ethiopia at 0300 here in northern Tasmania. Perhaps in midwinter I will be able to hear it direct.

After more than 70 years of continuous operations, the

northern Tasmanian ABC regional radio station, 7NT, in northern Tasmania on 711 kHz, ceased broadcasting on AM. It is now on 91.7 MHz FM. A three-week period of grace saw the MW signal simulcast with the FM output but officially 7NT closed down at 0006 UTC on March 7th. I believe other MW stations in Launceston will also be converting to FM later in the year or early 2007.

Have you noticed that the BBC World Service has adopted a rolling news format? This means many favourite programs have been axed, including "Calling the Falklands", a special program that became prominent after the Argentine invasion in April 1982.

The escalation of broadcasters leaving shortwave has continued. The program makers seem to think that streaming via the Internet is the way to go. However one station discovered that their audience actually plummeted after opting for Internet streaming. Radio Tashkent in Uzbekistan was heard lamenting their audience had disappeared since they went on the Net in December. I wonder if they will now reappear on shortwave?

Well that is all for now. You can reach me at [vk7rh@wia.org.au](mailto:vk7rh@wia.org.au) or snail mail at 20/177 Penquite Road, Norwood Tasmania 7250.

ar

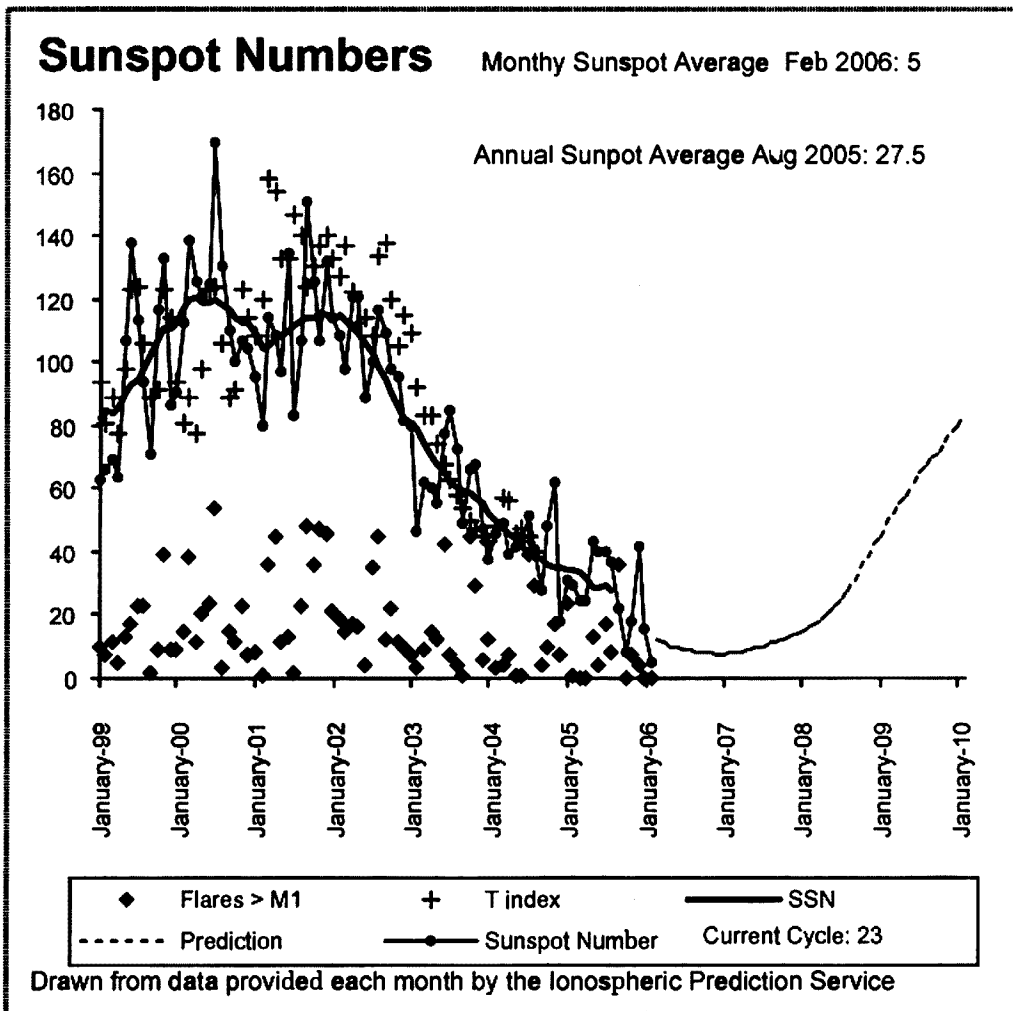

**Adelaide-Ottawa**

**58 Brisbane-Auckland 123**

First F 0-5 Short 16901 km

Second 2F20-35 2E Short 2291 km

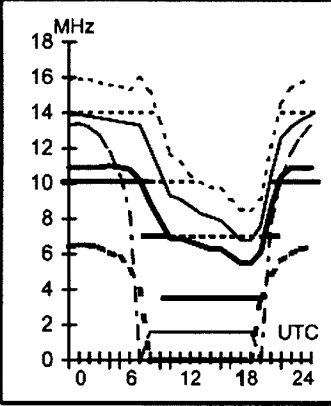
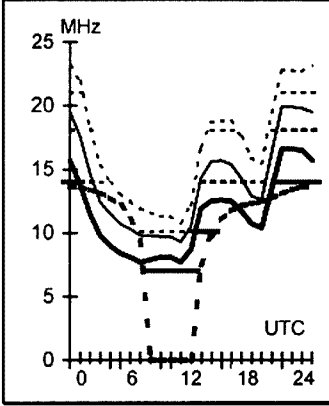

**April 2006**

T index: 15

**Legend**

- UD
- F-MUF
- OWF
- E-MUF
- ALF
- >10%
- >50%
- >90%
- Time Scale

**HF Predictions**

by **Evan Jarman VK3ANI**  
34 Alandale Court Blackburn Vic 3130

These graphs show the predicted diurnal variation of key frequencies for the nominated circuits.

These frequencies as identified in the legend are:-

- Upper Decile (F-layer)
- F-layer Maximum Usable Frequency
- E-layer Maximum Usable Frequency
- Optimum Working Frequency (F-layer)
- Absorption Limiting Frequency (D region)

Shown hourly are the highest frequency amateur bands in ranges between these key frequencies, when usable. The path, propagation mode and Australian terminal bearing are also given for each circuit.

These predictions were made with the Ionospheric Prediction Service program: ASAPS Version 4

**Adelaide-Singapore 311**

**59 Brisbane-Los Angeles**

**Canberra-London**

**136 Darwin-Honolulu**

**65**

Second 3F11-15 3E Short 5414 km

Second 4F3-6 4E0 Short 11564 km

First F 0-5 Long 23042 km

Second 4F7-14 4E0 Short 8635 km

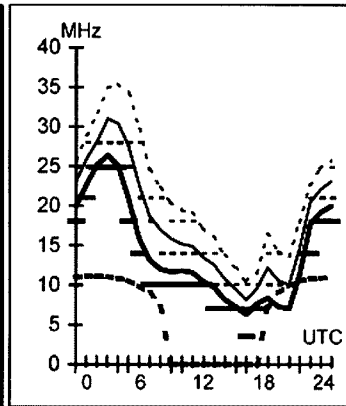
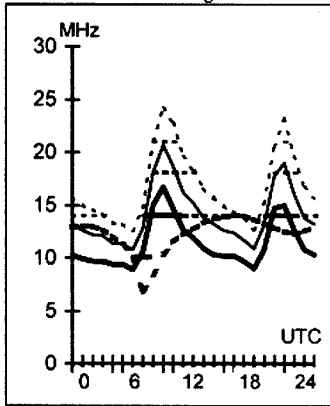
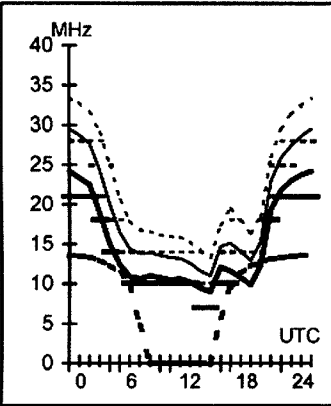
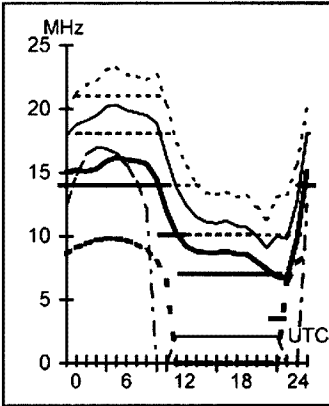

**Adelaide-Tel Aviv 291**

**320 Brisbane-Manila**

**Canberra-London 316**

**Darwin-Johannesburg 241**

First F 0-5 Short 13125 km

Second 3F9-16 3E1 Short 5811 km

First F 0-5 Short 16982 km

Second 4F4-9 4E0 Short 10639 km

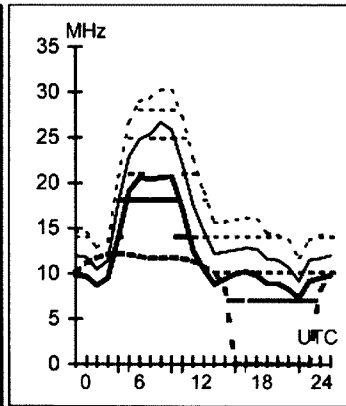
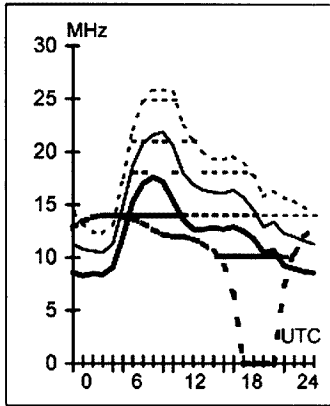
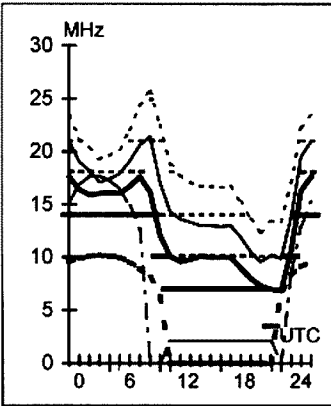
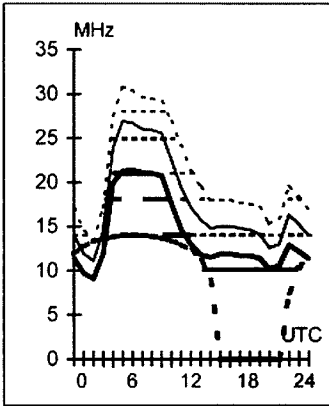

**Adelaide-Wellington 114**

**305 Brisbane-Rome**

**Canberra-Pretoria 231**

**Darwin-Riyadh 295**

Second 2F13-17 2E Short 3214 km

First F 0-5 Short 16107 km

Second 4F4-7 4E0 Short 10824 km

Second 4F5-10 4E0 Short 10000 km

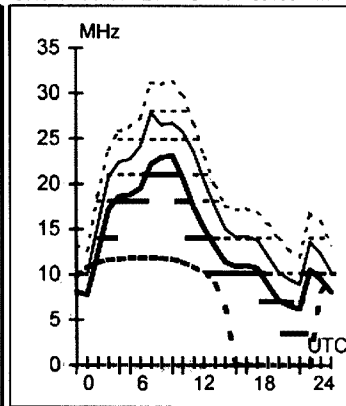
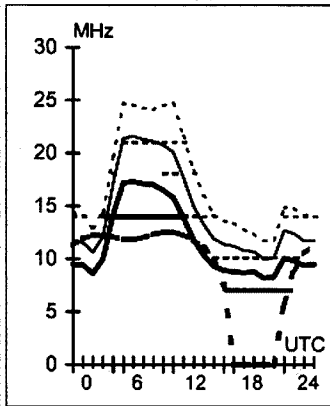
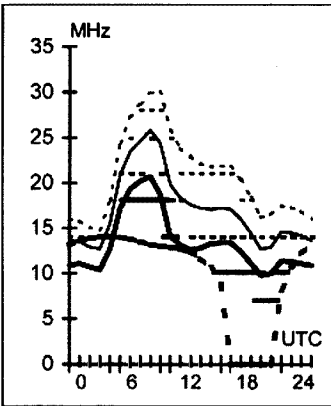
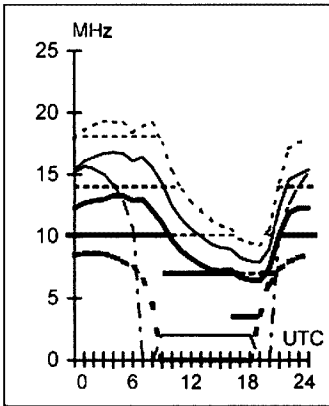

**Hobart-Dakar****209****Melbourne-Bangkok****312****Perth-Harare****267****Sydney-Miami****86**

First F 0-5 Short 16556 km

Second 3F5-9 3E0 Short 7372 km

Second 4F8-9 4E0 Short 8496 km

First F 0-5 Short 150226 km

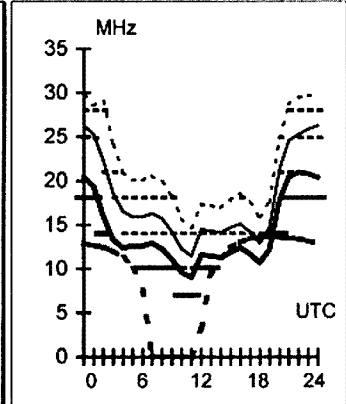
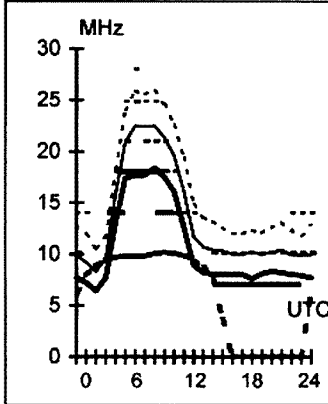
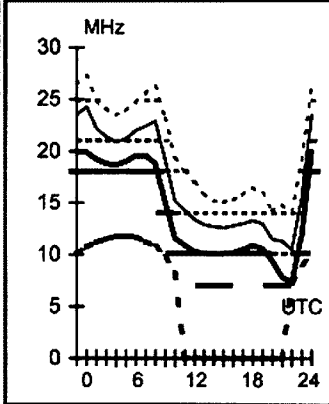
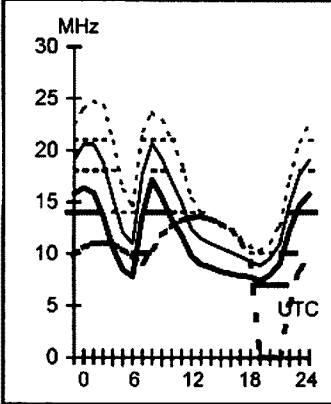
**Hobart-Lima****133****Melbourne-London****131****Perth-Port Moresby****69****Sydney-New Delhi****302**

First F 0-5 Short 12421 km

First F 0-5 Long 23118 km

First 2F8-10 2E0 Short 4073 km

Second 4F4-8 4E0 Short 10418 km

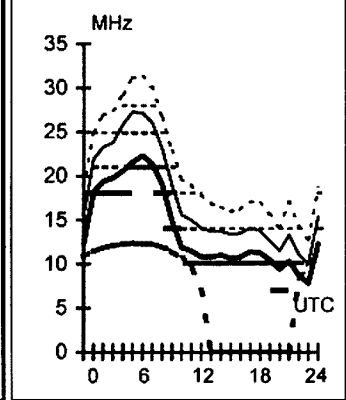
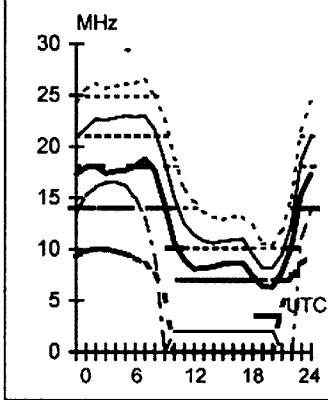
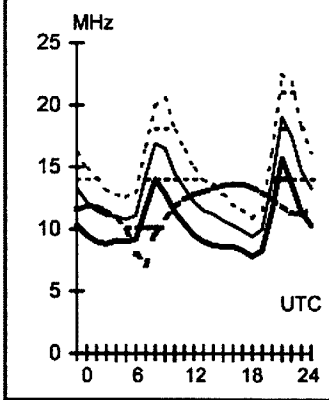
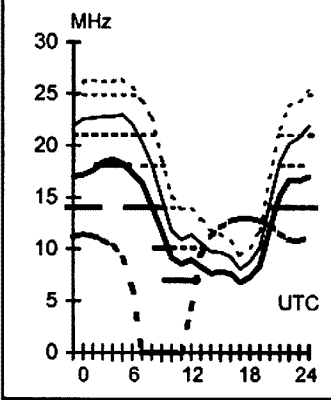
**Hobart-New York****80****Melbourne-London****311****Perth-Rome****123****Sydney-Rio de Janeiro****164**

Short Long 16609 km

First F 0-5 Short 16906 km

First F 0-5 Long 26684 km

First F 0-5 Short 13519 km

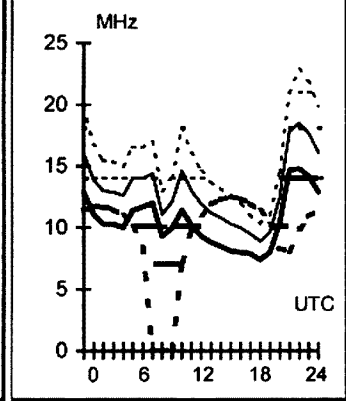
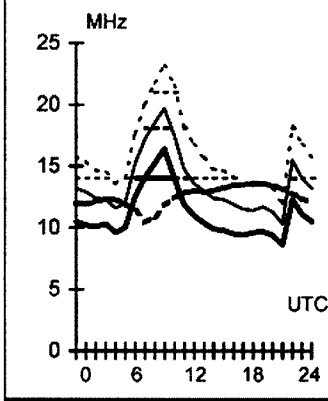
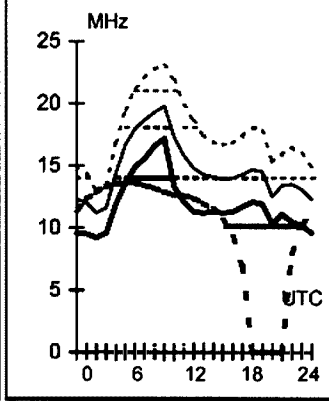
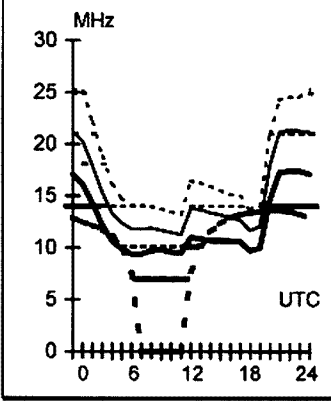
**Hobart-Seoul****344****Melbourne-Lusaka****241****Perth-Vancouver****60****Sydney-Tokyo****350**

Second 4F6-10 4E0 Short 9175 km

Second 4F3-4 4E0 Short 11153 km

First F 0-5 Short 14823 km

Second 3F4-8 3E0 Short 7825 km

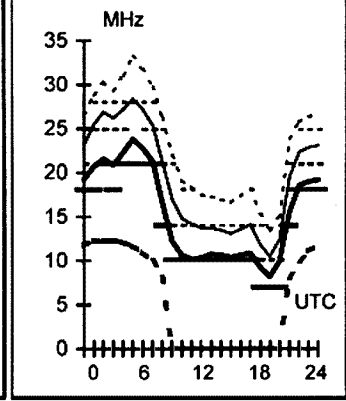
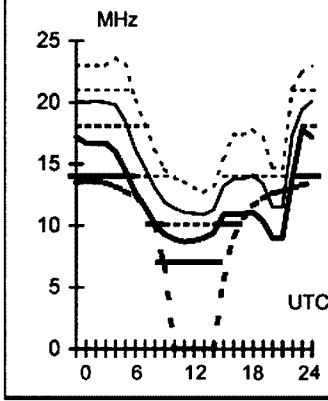
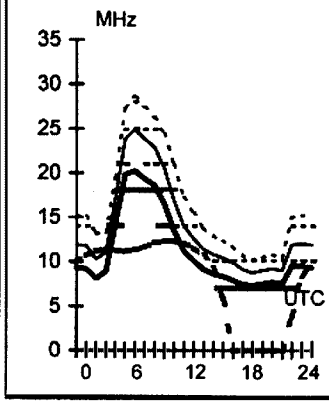
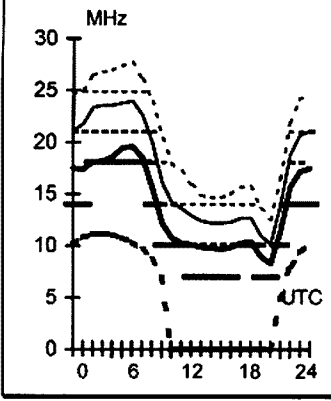

# Hamads classifieds **FREE**

## WANTED ACT

• TONO 9000E or telereader CWR-685E with CW KB-685E keyboard in good condition. Fred VK1RY QTHR or phone 02 6249 7823.

## FOR SALE NSW

• MARCONI signal generator TF-2015 AM/FM/ CW S/N 116945/027 Freq. coverage 10-520 MHz, v/g condition, original handbook, \$350. VK2BJU QTHR, phone 02 4841 0272, email demerland@goulburn.net.au.

• Brand new magnet winding wire 2.0 mm diameter, polyfin insulation, 3.4 kg tare weight on sturdy 60 wooden reel. Use to wind high amperage secondaries or high Q RF coils. \$20 plus P & P (Australia only). G. Moore 0409 027 835 (M), 02 6292 1631 (B)

• Aluminium Dish 1.25m, white in colour, no damage. Good for microwave experiments. Pick up only. \$50 Pennant Hills, NSW VK2JCC 98752191 (has voiceMail)

## WANTED NSW

• 2 X 2SC2166 or 2 X 2SC1969 RF power transistors Top 66 case. N Chivers VK2YO QTHR, phone 02 6674 2095.

## WANTED VIC

• I am trying to restore/complete my AN/TRC24 radio system and I am looking for the following parts/units: Transmitter, T-302/TRC; Power Supply, PP-685/TRC; Receiver, R-417/TRC; A band plug-in AM-1180/GRC; Amplifier/converter, AM-2537/TRA-25, and

any other bits and pieces for this radio. Thanks for reading this. John Eggington VK3EGG, johne@telpacific.com.au, mobile 0409 234 672.

## FOR SALE QLD

• ICOM IC-707 HF trans, and IC-AT500 auto tuner, both in GC. No manuals. SK. Offers to Colin VK4ACH at 07 3356 9816, email chinxman@bigpond.net.au.

## WANTED QLD

• Battery pack case for ICOM IC-M7 handheld VHF marine tx, preferably BP-90 (takes six AA batteries) but BP-81, BP-82, BP-83, BP-84, BP85 or CM-89 fit.

• Also matching chargers and cables BC-72A, BC-74A, BM-76A, CP-12 or OPC-254, LC-67 waterproof bag, or any other optional extras. Don VK4AMA 07 3366 5166 email marshad@optusnet.com.au

## WANTED SA

• Output transformer 60 watt type A & R OT2842 2.6kohms, plate to plate, secondary taps @ 3.75, 8 & 15 ohm. No screen taps. Phone 08 8520 2988.

## CONTACT WANTED SA

• Appreciate it if the former amateur who phoned me about an AWA type TR80 transceiver could contact me again. M Haskard VK5BA QTHR, Ph/Fax 08 8280 7192, email mhaskard@chariot.net.au

## VKHAM.COM AUSTRALIAN AMATEUR RADIO

Hundreds of pages and links related to Amateur Radio and radio in general

Home of:

- VK Classifieds
- VK Auctions
- VK's on the Internet

Repeater Maps, Software, Prefix Maps and more ...

## THE WIA QSL COLLECTION REQUIRES QSLs

All types welcome, especially rare DX pictorial cards, special issue. Please contact the Hon Curator, Ken Matchett VK3TL, 4 Sunrise Hill Road, Montrose Vic 3765, tel. (03) 9728 5350

## Need a 'rare spare'

Or perhaps a manual for a piece of gear from a long departed manufacturer.

Maybe you need a valve, or perhaps a back copy of a radio magazine.

Let Hamads help you find it, our WANTED ads are read by the people most likely to have what you need.

Email:

[newunltd@bigpond.net.au](mailto:newunltd@bigpond.net.au)

# \*HAMADS are FREE\*

## About hamads....

- Hamads may be submitted by email (preferred) or on the form on the reverse of your current Amateur Radio address flysheet. Please print carefully and clearly, use upper AND lower case.
- Separate forms for For Sale and Wanted Items. Please include name, address STD telephone number and WIA membership number if you do not use the flysheet.
- Deceased estates Hamads will be published in full, even if the ad is not fully radio equipment.
- WIA policy recommends that the serial number of all equipment for sale should be included.
- QTHR means the address is correct in the current

WIA Call Book.

- Ordinary Hamads from those who are deemed to be in general electronics retail and wholesale distributive trades should be certified as referring only to private articles not being re-sold for merchandising purposes.
- Commercial advertising (Trade Hamads) are pre-payable at \$25.00 for four lines (twenty words), plus \$2.25 per line (or part thereof), Forty word maximum, minimum charge of \$25.00. Cheques are to be made out to: WIA Hamads.
- Copy typed or printed clearly please, and received by the deadlines shown on page 1 of each issue of Amateur Radio.

Email: [newunltd@bigpond.net.au](mailto:newunltd@bigpond.net.au)

Postal: Newsletters Unlimited, PO Box 431, Monbulk Vic 3793. Fax: 03 9756 7031

### TRADE PRACTICES ACT

It is impossible for us to ensure that the advertisements submitted for publication comply with the Trade Practices Act 1974. Therefore, advertisers and advertising agents will appreciate the absolute need for themselves to ensure that the provisions of the Act are strictly complied with.

### VICTORIAN CONSUMER AFFAIRS ACT

All advertisers are advised that advertisements containing only a PO Box number as the address cannot be accepted without the addition of the business address of the box-holder or seller of the goods.

## ADVERTISERS INDEX

AEI.....	29
Andrews.....	17
Benelec.....	IFC
Com-an-tena.....	8
TET-Emtron.....	35
G & C.....	28
Icom.....	0BC
Ozgear.....	16
Rippletech.....	55
TTS.....	9
Small ads.....	55
ARI.....	29
KVK Books.....	34
Winlink.....	28
www.vk3ajl.com.....	55



## HF, VHF, UHF ANTENNAS & ACCESSORIES

Aluminium towers, guys etc  
Diamond VSWR/PWR motors.

HD copper antenna wire & insulators,  
TX tubes & pwr transistors,  
full range Create Rotators

Quality coax cables & connectors.  
Free advice & catalogue.

### ATN Antennas

Ph 03 5492 2224 Fax 03 5492 2666,

email [atnant@iinet.net.au](mailto:atnant@iinet.net.au)  
PO Box 80, Birchip Vic 3483

## Rippletech Electronics

New to radio or perhaps need a new challenge? Want to earn the WIA's new 5BDXCC award? With a Nally tower, an 80m sloper and a 40m rotary dipole you can get low band DXCC, even from your city lot! Want DXCC on the WARC bands? The WARC band dipole on placed above your traditional tribander will get you there.

Like to travel with your new micro radio? Grab a TZ-V-3 which packs down to only 1m long, fits in the boot or on a plane & assembles in minutes. Outperforms lossy super wideband designs.

TZ-1840	1:1 1kW 160-10m Balun (1.8- 40 MHz)	\$ 59.00
TZ-330-4	4:1 1 KW HF Balun (3 - 30 MHz)	\$ 59.00
TZ-SL8	80m Sloper (use tuner for 17 & 30m)	\$ 99.00
TZ-SL16	160m Sloper (fits in a suburban lot!)	\$ 110.00
TZ-D-4080	40m/80m Trapped Wire Dipole	\$ 176.00
TZ-V-3	10/15/20m Trapped Vertical.	\$ 189.00
TZ-V-4	10/15/20/40m Trapped Vertical	\$ 289.00
TZ-RD-3	10/15/20m Trapped Rotary Dipole	\$ 199.00
	Vertical Radial kits (1 rad. per band)	\$ 33.00
TZ-V-3w	12/17/30m Trapped Vertical	\$ 279.00
TZ-RD-3w	12/17/30m Trapped Rotary Dipole	\$ 289.00
TZ-RD-40	17/40m or 20/40m Rotary Dipole	\$ 279.00
TZ-1000RC	FT-1000mp remote controller acc	\$ 33.00
	5th Order HPF TVI Filter (coming)	\$ 39.00
	Mobile whip base & Z bracket combo	\$ 11.00

Our trapped antennas use high Q, high isolation coaxial traps which are fully sealed and exhibit 40 dB of isolation at the resonance.

Need something special?

Give me a call and we'll see if we can meet your needs.

[www.rippletech.com.au](http://www.rippletech.com.au)



Contact Tony - VK3TZ

0402 622 562 or email

[sales@rippletech.com.au](mailto:sales@rippletech.com.au)

Master card, Visa and Bankcard accepted

## WWW.RADIOSPECIALISTS.COM.AU

Yaesu authorized Dealership in Adelaide

**Shopfront sales and not a  
backyard shed**

243 Seacombe Road South Brighton SA  
**The Radio Specialists serving  
Adelaide.**

## AMIDON FERROMAGNETIC CORES

For all RF/electronic applications.

See our website for complete data on all cores  
including prices.

[www.catchnet.com.au/~rjandasinports](http://www.catchnet.com.au/~rjandasinports)

**RJ & US Imports**

PO Box 431, Kiama NSW 2533.

A 3.5" PC disk containing all data is  
available for \$5.00 incl. post.

### Agencies

Active Electronics, Tas  
TTS Systems, Tyabb ( VIC)  
Tower Communications, Perth  
Ozhel Services, Brisbane

## RM Products Italy

are now available in Australia after the  
appointment of

**Hamak Electrical Industries Pty Ltd**

as distributor for RM products

Visit the Hamak website at

**Hamak.com.au** for

**Linear amplifiers,  
Power supplies  
and accessories**



## JACKSON BROS JACKSON OF THE UK IS BACK

Highest quality products made by UK craftsmen

[www.jacksonbrothers.com.au](http://www.jacksonbrothers.com.au)

Full range now off-the-shelf in Australia.

Variable and trimmer capacitors, reduction

drives, dials, ceramic standoffs

**CATALOGUES, PRICE LISTS AVAILABLE**

**CHARLES I COOKSON PTY LTD**

11-13 Port Rd

Queenstown SA 5014

Tel: (08) 8240 3200

Fax: (08) 8240 3233

FreeFax 1800 673355 within Australia

Email: [sales@jacksonbrothers.com.au](mailto:sales@jacksonbrothers.com.au)

**ALL MAJOR CREDIT CARDS ACCEPTED  
SOLE AGENTS AUSTRALIA AND NEW ZEALAND**



## Tunable Loop Antenna

enhances AM

### Reception

AM radio reception (530 to 1900KHz)

enhanced. Reception where none

existed before; works indoors,

even in interference-polluted areas

High value — low cost.

Simple, no connections or batteries

Ideal for touring, caravan, boat and

fringe areas. Use anywhere.

[www.amradioantennas.com](http://www.amradioantennas.com)

[pkloops@bigpond.net.au](mailto:pkloops@bigpond.net.au)

Paul 0412 302 939

**PK's Loop Antennas**

## RADIOS:

	<i>Unused</i>	<i>Used</i>
Icom 706MK2G	Ring/email	\$1199
Icom 208H	\$ 550	\$ 499
Icom 910H	\$2199	\$1799
Icom 756PRO2	N/A	\$2799
Icom 756PRO3	\$4399	N/A
Icom 718	N/A	\$799
Kenwood TS2000	\$2699	\$2299
Kenwood TS2000X	N/A	\$2999
Kenwood TS480SAT	\$1699	\$1499
Kenwood TS480HX	\$1899	\$1699
Kenwood TS570DG	N/A	\$1249
Kenwood TMD700A	\$ 849	\$ 799
Kenwood THD7A	\$ 599	\$ 549
Yaesu FT8900R	\$ 649	N/A
Yaesu VX7R	\$ 529	N/A
Yaesu FT1000MP MKV	\$3599	\$2999
Yaesu FT847	N/A	\$1899
Yaesu FT857D	\$1249	\$1149
Yaesu FT897D	\$1299	N/A
Yaesu FT100D	N/A	\$1099

## ACCESSORIES:

Doss 40 AMP PSU	\$ 235	N/A
Icom AH4 ATU	\$ 499	\$ 449
Icom AT180	N/A	\$ 549
Tokyo HL700B HF Amp	\$1899	
Tokyo HL200V50 2M Amp	\$ 549	
MFJ 993 ATU	\$449	
Tokyo 2M 200W Amp	\$49	

Call / email re Heil and MFJ products

**DOA warranty applicable on all items (ie if it is not 100% and in condx as described, a full money back g'tee applies)**

**OTHER CURRENT MODELS AVAILABLE**

**ALL USED GEAR IN EXC CONDX WITH ORIGINAL BOX AND ACCESSORIES**

**PRICES SUBJECT TO CHANGE - CHECK WEBSITE FOR LATEST (OR RING)**

**WILL CONSIDER TRADE-INS - BUT MUST BE CURRENT MODEL GEAR (IE LAST 5 YEARS)**

**Ship anywhere in VK/ZL (freight extra)  
ORDER ONLINE AT**

**WWW.VK3AJJ.COM**

**OR TELEPHONE PAUL ~**

**(03) 9018 9757**

**Mob. 0410 093 759**

**[vk3ajj@iinet.net.au](mailto:vk3ajj@iinet.net.au)**

**NB - I am not an authorised dealer for the radio companies listed above. These companies may refuse service on equipment sold by me - but other servicing options are available in the VK market.**

Licensed Second Hand Dealer NO 10229 (Vic) (E&OE)

**WWW.VK3AJJ.COM - giving  
Aussie Hams a FAIR GO!**



# Directory

## The Amateur Service:

a radio communications service for the purpose of self training, intercommunication and technical investigation carried out by amateurs, that is, by duly authorised persons interested in radio technique with a personal aim and without any pecuniary interest. 1.56 ITU Radio Regulations.

The Wireless Institute of Australia represents the interests of all amateurs throughout Australia.

WIA membership fees are: ★ \$ 75 for full members ( F grade ), ★ \$ 70 for pensioners and students ( G and S grade ), and ★ \$ 50 for membership without 'Amateur Radio' ( X grade ). Payment direct to National office.

National Office	Contact	News Bulletin Schedule
10/229 Balaclava Road, Caulfield North VIC 3161, PO Box 2175 Caulfield Junction Vic 3162 Australia	Phone 03 9528 5962, Fax 03 9523 8191, 10am to 4pm daily, nationaloffice@wia.org.au http://www.wia.org.au	Subject to change. See <a href="http://www.wia.org.au">www.wia.org.au</a> follow National News prompts. Contact <a href="mailto:nationalnews@wia.org.au">nationalnews@wia.org.au</a> National VK1WIA news is distributed to all states.

Advisory Committees	Contact	News Bulletin Schedule
<b>VK1 Australian Capital Territory</b> VK1WX Alan Hawes VK1ZPL Phil Longworth VK1ET John Woolner VK1GH Gil Hughes	<a href="mailto:vk1advisory@wia.org.au">vk1advisory@wia.org.au</a>	Sundays at 11.00 am VK1WIA 7.128, 146.950, 438.050 Canberra Region Amateur Radio Club Email newsletter will be sent on request to <a href="mailto:president@vk1.ampr.org">president@vk1.ampr.org</a>
<b>VK2 New South Wales</b> VK2QV Chris Flak VK2XCD Chris Devery VK2BFN Adrian Clout	Phone 02 9689 2417 <a href="mailto:vk2wi@ozemail.com.au">vk2wi@ozemail.com.au</a> <a href="mailto:vk2advisory@wia.org.au">vk2advisory@wia.org.au</a>	VK2WI - Sunday 1000 and 1930 hours local. 1.845; 3.595; 7.146; 10.125; 14.170; 28.320, 52.525; 145.600; 147.000; 438.525; 1273.500 megahertz. Plus regional relays. VK1WIA news included in the morning
<b>VK3 Victoria</b> VK3JJB John Brown VK3PC Jim Linton VK3APO Peter Mill	Phone 03 9885 9261 <a href="mailto:arv@amateurradio.com.au">arv@amateurradio.com.au</a>	VK1WIA, Sunday 11am and 8pm, 3.615 and 7.085 (LSB), 10.130 (USB), VK3RML 146.700, VK3RMM 147.250, VK3RMU 438.075.
<b>VK4 Queensland</b> VK4BY Don Wilchelski VK4ZZ Gavin Reibelt VK4KF Ken Fuller	Phone 07 3221 9377 <a href="mailto:vk4advisory@wia.org.au">vk4advisory@wia.org.au</a>	VK1WIA, Sunday 9.0am via HF and major VHF/UHF rpters
<b>VK5 South Australia and Northern Territory</b> VK5OV David Box VK5APR Peter Reichelt VK5ATQ Trevor Quick	Phone 08 8294 2992 <a href="mailto:boxesdnm@lm.net.au">boxesdnm@lm.net.au</a> <a href="mailto:peter.reichelt@bigpond.com">peter.reichelt@bigpond.com</a> <a href="mailto:vk5advisory@wia.org.au">vk5advisory@wia.org.au</a>	VK5WI: 1843 kHz AM, 3.550 MHz LSB, 7.095 AM, 14.175 USB, 28.470 USB, 53.100 FM, 147.000 FM Adelaide, 146.800 FM Mildura, 146.900 FM South East, 146.925 FM Central North, 438.475 FM Adelaide North, ATV Ch 35 579.250 Adelaide. (NT) 3.555 LSB, 7.065 LSB, 10.125 USB, 146.700 FM, 0900 hrs Sunday. The repeat of the broadcast occurs Monday Nights at 1930hrs on 3585kHz and 146.675 MHz FM. The broadcast is available in 'Realaudio' format from the website at <a href="http://www.sant.wia.org.au">www.sant.wia.org.au</a> Broadcast Page area.
<b>VK6 Western Australia</b> VK6NE Neil Penfold VK6XV Roy Watkins VK6OO Bruce Hedland-Thomas	Phone 08 9351 8873 <a href="http://www.vk6.net/">http://www.vk6.net/</a> <a href="mailto:vk6advisory@wia.org.au">vk6advisory@wia.org.au</a> <a href="mailto:vk6ne@upnaway.com">vk6ne@upnaway.com</a> <a href="mailto:vk6xv@bigpond.net.au">vk6xv@bigpond.net.au</a>	VK6WIA: 146.700 FM(R) Perth at 0930hrs Sunday relayed on 1.865, 3.564, 7.075, 10.125, 14.116, 14.175, 21.185, 29.120 FM, 50.150 and 438.525 MHz, Country relays 3.582, 147.200 (R) Cataby, 147.350 (R) Busselton, 146.900 (R) Mt William (Bunbury). 147.000 (R) Katanning and 147.250 (R) Mt Saddleback. Broadcast repeated on 146.700 at 1900 hrs Sunday relayed on 1.865, 3.564 and 438.525 MHz : country relays on 146.900, 147.000, 147.200, 147.250 and 147.350 MHz..Also in "Realaudio" format from the VK6 WIA website
<b>VK7 Tasmania</b> VK7ZAX Phil Corby VK7DG Dale Barnes VK7KK Reg Emmett	Phone 03 6234 3553 <a href="mailto:vk7advisory@wia.org.au">vk7advisory@wia.org.au</a> <a href="mailto:phil.corby@tassie.net.au">phil.corby@tassie.net.au</a> <a href="mailto:vk7dg@wia.org.au">vk7dg@wia.org.au</a> <a href="mailto:regemm@ozemail.com.au">regemm@ozemail.com.au</a>	VK1WIA Sunday 9am on VK7WI network: 3.570MHz LSB, 146.700 MHz FM (VK7RHT South), 53.825MHz FM (VK7RAD South), 147.000MHz FM (VK7RAA North), 146.750 FM & 53.825MHz (VK7RNW North West), 146.625 MHz FM (VK7RMD North West), UHF CB Channel 15 (Hobart) and 27MHz CB - 27.225MHz LSB (Hobart). Followed at 9:30am with VK7 Regional News Broadcast also on 7.090MHz LSB & 14.130MHz USB

### Notes

1. Only three members of the state advisory committees are listed.
2. All listings are preliminary. They will be updated each month as required.
3. Membership application forms are available from the WIA web site [www.wia.org.au](http://www.wia.org.au) or the national office address above.

# The man and his shack

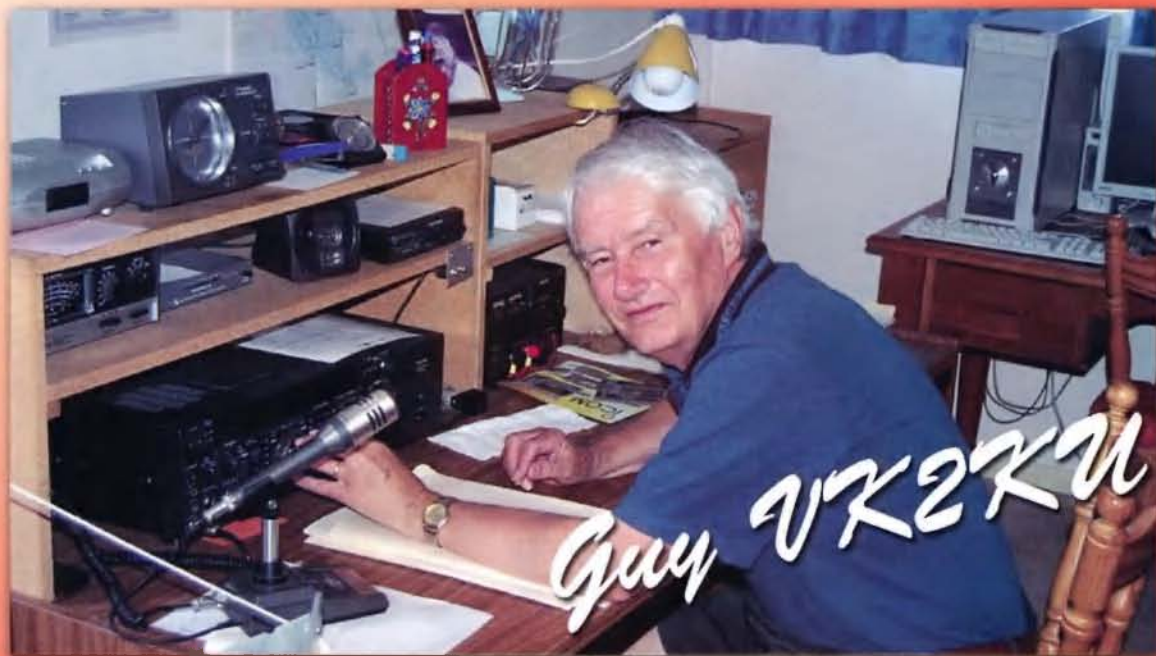

**Guy Fletcher VK2KU moved to the Southern Tablelands in April 2004, to find an RF-quiet location with no neighbours (the nearest is 1.5 km away), and no significant council problems. He chose this location with EME activities in mind and the possibility of applying for a high-power permit, and it was a reasonable site for tropospheric weak signal communications.**

**In early February 2005, a severe thunderstorm moved through the area. Guy suffered a near miss – a strike “landed” an estimated 150 m from the house and shack, damaging many items of electrical equipment, including gear in the shack – a “near total wipe-out” in Guy’s own words.**

**Guy took the opportunity to rethink his approach to VHF.**

***Read Guy’s story on page 25***



# ICOM's price break through

## most affordable prices ever



### IC-7000

HF/VHF/UHF All mode Transceiver • 100W HF/50MHz, 50W/2m, 35W/70cm • I.F DSP for improved noise rejection • Digital IF filter for Dial selectivity • 2.5" TFT colour display for bright easy reading • Remote control DTMF Mic for fingertip control & IRLP access PLUS • digital voice storage • 2 mode band scope • Multi function meter 7 SWR display • Built in RTTY modulator



### IC-756PRO III

HF\*6m • Sharp & soft IF filter shape • New receiver gives +30dBm third-order intercept point • One-touch record/play • Digital voice memory • Extended 1/4 Tuning step & BPF functions for SSB-D mode • 32-bit floating-point DSP and 24-bit AD/DA converter • SSB/CW synchronous tuning • 5-inch color TFT LCD • Built-in antenna tuner • Customisable filter shape • No optional filters to buy



### IC-7800

HF\*6m • Four 32-bit floating point DSP units • +40dBm ultra high intercept point • Automatic tracking pre-selector • Two completely independent receiver circuits • 200W output power at full duty • Ultra high frequency stability • 7-inch wide color TFT LCD • Multi function spectrum scope • RTTY / PSK31 operation without PC connection • Professional 6m receiver • Digital Voice Recorder • CF memory card.



### IC-2200H

FM Dual Band Transceiver • VHigh (65W) Power Output • DTCS & CTCSS Tone Squelch • DTMF Encode & Decode (with optional UT108) • Digital Voice & Data Communication (with optional UT118) • 207 Alphanumeric Memories

### IC-P7A

VHF/UHF (2m/70cm) Dual-band FM Handheld Transceiver • Ultra compact body, light weight 47x81x28mm, 160g • Mini-power VHF/UHF dual bander with wideband receiver 0.495-999.990MHz • 1800mAh large capacity Li-Ion battery allows 20hours operating time (Tx:Rx:Standby=5:5:90) • 1.5W output power on 2m & 1W output power on 70cm • Simple operation • 1000 memory channels with flexible memory bank system • Oversize LCD for clear display of function information



### IC-T90A

A new 5W Triband handheld • VHF/UHF FM 2M, 6M, & 70CM Wideband receive 495KHz - 1GHz 555 Alphanumeric memories • 13 Scan modes DTCS & CTCSS encode & decode DTMF encoder (10 memories) Wide/narrow transmit capability.

Amateur

NEW

ICOM

ICOM 84

Call your local ICOM dealer [www.icom.net.au](http://www.icom.net.au) or (03) 9549 7500

Volume 74 No 5

May 2006

# Amateur Radio



The magazine for **AUSTRALIAN** radio amateurs

**\$6.50**

**incl GST**



**AX3MCG**

*Melbourne*

*Commonwealth*

*Games*

**John Moyle  
Memorial  
Field Day**

Full colour  
centre spread



# BENELEC

# YAESU

**Special Offer**

## Ideal Foundation Licence Radio Options.....

### FT-817



**Now includes FNB72 Internal Battery**

- Ultra Compact 135 x 38 x 165mm
- All Mode Portable Transceiver
- 160 - 10m / 6m / 2m / 70cm
- 0.5-5 Watts Selectable

**Price \$ 1,167.00**

**UHV-4 Free with FT-817**

**Value \$194.00**

### FT-857D



**Now includes DSP2 unit built-in**

- Ultra Compact + All Mode Transceiver
- 160-10m / 6m / 2m / 70cm
- 100W, 100W, 50W, 20W

**Price \$ 1,423.90**

### FT-897D



**Now includes TCX0-9 Built-in**

- Portable / Mobile / Base All Mode Txr
- 160-10m / 6m / 2m / 70cm
- 100W, 100W, 50W, 20W

**Price \$ 1,600.00**

## .....All Bands in One Box!

### CHA250B

## Vertical HF Broad Band Antenna

**Specifications**

**Price \$ 742.50**

Amateur Bands Covers	6,10,12,15,17,20,30,40 & 75/80 metres
Transmit Frequency Range	3.5 to 57 MHz
Receive Frequency Range	2.0 to 90 MHz
VSWR	<1.5:1 (Typical)
Maximum Height	7.13m
Weight	3.20Kg
Wind Survival	108 Kmph
Transmit Power Rating	250 Watts SSB & 125 Watts FM
Impedance	50Ω

## New PC Programming Kits in Stock

### ADMS-VX6 Programming Software Kit

-Including Software & Serial to USB Cable

**Price \$ 138.60**

### ADMS-VX170 Programming Software Kit

-Including Software & Serial to USB Cable

**Price \$ 138.60**

### ADMS-4A Suitable for FT817ND

-Including Software, Serial to USB Cable & CT62 Lead

**Price \$ 197.10**

### ADMS-4B Suitable for FT857D/FT897D

-Including Software, Serial to USB Cable & CT62 Lead

**Price \$ 197.10**



## Benelec Approved Amateur Transceiver Dealers

**All Price includes GST**

**NSW**

**Andrews Communications Systems**

Tel: 02 9636 9060 lee.andrews1@bigpond.com

**Newcastle Pro Sound & Communications**

Tel: 02 4965 6899 sales@newcastleprosund.com.au

**Action Communications**

Tel: 02 4732 2788 action@pnc.com.au

**VIC**

**Strictly Ham P/L**

Tel: 03 9729 7656

vk3my@bigpond.net.au

**G & C Communications**

Tel: 03 5996 3298

gccomm@bigpond.net.au

**Qld**

**Kyle Communications**

Tel: 07 3857 4400

mark@kyle.com.au

**Ozhelph Services**

Tel: 07 3273 7263

sales@ozgear.com.au

**SA/NT**

**POSNAV Systems P/L**

Tel: 08 8342 4700

brenton@posnav.com.au

**WA**

**Bushcomm Pty Ltd**

Tel: 08 9296 0496

bushcomm@bigpond.com

# www.benelec.com.au



# Amateur Radio

Volume 74, Number 5  
May 2006

The Journal of the Wireless  
Institute of Australia  
ISSN 0002-6859

## Editorial

Editor: Peter Freeman VK3KAI  
editor-armag@wia.org.au

Technical Editor: Peter Gibson VK3AZL

### Publications Committee Members

Brenda Edmonds VK3KT  
Ron Fisher VK3OM  
Evan Jarman VK3ANI  
Tom Potter VK3UBS  
Bill Roper VK3BR  
Ernie Walls VK3FM

Circulation enquiries: wia@wia.org.au

### Submission of material to Amateur Radio Magazine

General and Technical articles to Secretary  
AR Publications Committee  
3 Tamar Court  
Mentone VIC 3194  
or armag@wia.org.au

Columns and Letters to the Editor to Editor  
AR Magazine  
PO Box 273  
Churchill, Vic 3842  
or editor-armag@wia.org.au

Hamads to  
"Hamads" Newsletters Unlimited  
PO Box 431  
Monbulk VIC 3793  
Fax 03 9756 7031  
newunltd@bigpond.net.au

Advertising  
All enquiries to  
Newsletters Unlimited  
PO Box 431  
Monbulk Vic 3793  
Phone: 03 9756 7797  
Fax: 03 9756 7031  
newunltd@bigpond.net.au

Registered Office  
10/229 Balaclava Road,  
Caulfield North VIC 3161  
Australia  
Phone: 03 9528 5962  
Fax: 03 9523 8191

## Production Deadlines

Advertising booking and articles for publication 10th of preceding month.

Hamads and advertising material deadline 18th day of preceding month

The contents of Amateur Radio are Copyright  
Wireless Institute of Australia © 2006

## GENERAL

- WIA BPL Interference Advisory Service.....4  
*Phil Walt VK2DKN*
- It's radio Jim, but not as we know it .....7  
*Bill Isdale VK4TWI*
- Celebrating the Commonwealth Games on the amateur bands .....17  
*Barry Robinson VK3JBR*
- John Moyle Memorial Field Day Contest.....23, 24, 27, 28, 29
- Packet radio – yesterday, today ... and tomorrow? .....36  
*Ray Wells VK2TV*
- Secret Radio Communications .....47  
*Dr Hank Prunckun, VK5JAZ*

## TECHNICAL

- A simple computer-to-radio PTT interface.....6  
*Vince Henderson VK7VH*
- CW Central – a versatile keyer unit .....10  
*Dale Hughes VK2DSH*
- Antenna Analyser revisited .....13  
*David Milne VK3DPM*
- Drilling holes in round tube (Technical abstracts).....16  
*Peter Gibson VK3AZL*
- How I solved mobile station installation problems of my own making! .....19  
*Neville Chivers VK2YO*

## COLUMNS

- |                          |                                     |
|--------------------------|-------------------------------------|
| ALARA.....25             | VK3.....32                          |
| AMSAT.....38             | VK4.....34                          |
| Awards.....40            | VK5.....34                          |
| Beyond our shores.....43 | VK7.....35                          |
| Contests.....41          | Over to you.....15, 51              |
| Directory.....56         | Silent key.....26, 46, 51           |
| DX News & Views.....44   | Spotlight on SWLing.....37          |
| Editorial comment.....2  | Technical Abstracts.....16          |
| Hamads.....54            | VHF/UHF – an expanding world.....45 |
| HF predictions.....52    | WIA comment.....3                   |
| News from...VK2.....30   | WIA news.....4                      |

## Our Cover this month

David McAulay VK3EW operating Commonwealth Games special event station AX3MCG, which he shared with Peter Forbes VK3QI. They were part of the month-long Amateur Radio Victoria activity that also involved AX3GAMES being activated by a roster of 17 operators across the state. Story on page 17 and IBC. Photo by Peter Forbes VK3QI.

### Contributions to Amateur Radio

Amateur Radio is a forum for WIA members' amateur radio experiments, experiences opinions and news. Manuscripts with drawings and/or photos are always welcome and will be considered for publication. Articles on disc or email are especially welcome. The WIA cannot be responsible for loss or damage to any material. A pamphlet, 'How to write for Amateur Radio' is available from the National Office on receipt of a stamped self-addressed envelope.

### Back Issues

Back issues are available directly from the WIA National

Office (until stocks are exhausted), at \$4.00 each (including postage within Australia) to members.

### Photostat copies

When back issues are no longer available, photocopies of articles are available to members at \$2.50 each (plus an additional \$2 for each additional issue in which the article appears).

### Disclaimer

The opinions expressed in this publication do not necessarily reflect the official view of the WIA and the WIA cannot be held responsible for incorrect information published.

## Amateur Radio Service

A radiocommunication service for the purpose of self-training, intercommunication and technical investigation carried out by amateurs; that is, by duly authorised persons interested in radio technique solely with a personal aim and without pecuniary interest.

## Wireless Institute of Australia

The world's first and oldest National Radio Society  
Founded 1910

Representing

The Australian Amateur Radio Service

Member of the  
International Amateur Radio Union

Registered Office of the WIA

10/229 Balaclava Road, Caulfield North Vic 3161

Tel: (03) 9528 5962 Fax (03) 9523 8191

email: [nationaloffice@wia.org.au](mailto:nationaloffice@wia.org.au)

<http://www.wia.org.au>

All mail to

PO Box 2175 Caulfield Junction VIC 3161

Business hours: 10am – 4pm weekdays

### National Office staff

Marfaret Webb	Office Administrator
Emma Trebilco	Examinations Officer
Brenda Edmonds	Office Volunteer

### Board of Directors

President	Michael Owen	VK3KI
Vice-President	Ewan Mcleod	VK4ERM
	Robert Broomhead	VK3KRB
	Glenn Dunstan	VK4DU
	Trevor Quick	VK5ATQ
	Ted Thrift	VK2ARA
	Phil Wait	VK2DKN
Secretary	Chris Jones	VK2ZDD
Treasurer	David Pilley	VK2AYD
Assistant Treasurer	Bruce Bathols	VK3UV

### Coordinators

AMSAT	Graham Ratcliff	VK5AGR
ARDF	Jack Bramham	VK3WWW
Australian ARISS	Tony Hutchison	VK5ZAI
Awards	Mai Johnson	VK6LC
Contests	Ian Godsil	VK3JS
John Moyle Memorial		
FD Manager	Denis Johnstone	VK3ZUX
Editor "AR"	Peter Freeman	VK3KAI
EMC/EMR	Gilbert Hughes	VK1GH
	Keith Malcolm	VK1ZKM
Standards	Gilbert Hughes	VK1GH
	David Wardlaw	VK3ADW
	John Bishop	VK2ZOI
	John Martin	VK3KWA
	t.b.a.	
NTAC		
Historian		
IARU Region 3		
Liaison Officer	Neil Penfold	VK6NE
Intruder Watch	Glenn Dunstan	VK4DU
International		
Travel Host	John Miller	VK3DJM
ITU Conference and study group		
	Gilbert Hughes	VK1GH
	David Wardlaw	VK3ADW
	Keith Malcolm	VK1ZKM
QSL Curator	Ken Matchett	VK3TL
QSL Manager (VK9/0)	Neil Penfold	VK6NE
Videotapes Curator	VK2 Division	
Webpage co-ordinator	Colin Thompson	VK2TRC
WICEN	John Weir	VK3ZRV

### ACA Liaison Team

Gilbert Hughes VK1GH  
Keith Malcolm VK1ZKM  
Peter Mill VK3APO  
Glenn Dunstan VK4DU

# Editorial comment

Peter Freeman VK3KAI

## Milestones

By the time this issue reaches readers, the Annual General Meeting will be about to occur in Sydney. This marks the passing of another milestone in the organisation, with an election of Directors occurring for the first time since the founding of the organisation as a national (as opposed to federal) body two years ago. It is clear that the Board and many other members are working hard to advance the organisation and our hobby. I encourage those of you able to attend the AGM to do so.

Interest in the Foundation Licence as an entry point to the hobby continues to grow. More of those 4-letter suffix calls are appearing on the bands and the rest of us are becoming used to the different rhythm of these call signs. Like any newly licensed operator, some will occasionally make errors. I trust that we all offer helpful advice to all new licensees when it is needed. Remember that whatever you say on air is a very public statement, so please take a second to consider not only what you will say, but how you SAY it as well.

## Ethics considerations for authors and publishers

One item that has been discussed at several meetings of the Publications Committee revolves around issues of copyright and permission to publish. These issues are ones that the author of an article should always consider and that a publisher must consider at all times. As editor, I must be mindful of the issues as I act on behalf of the WIA in selecting the articles to be published.

Under Australian law, copyright rests with the author unless it is formally assigned to another party. It has been the past practice of this journal to publish articles on the understanding that submission of an article for consideration for publication indicates that the author consents to the article being published in AR, if/when the article is approved and accepted for publication. That is, submission of the article has been taken to indicate permission to publish.

There have been some cases in recent

months where essentially the same article has been submitted to more than one magazine at the same time. We appreciate that one component of our hobby involves the sharing of information with our fellow amateurs. However, actions such as this (submission to more than one journal at the same time) are not reflecting ethical behaviour. The usual standard is that an article should not be submitted in essentially the same form to another journal/magazine whilst it is being considered for publication by a journal. If the article is rejected, then the author is free to submit the work to another journal for consideration. If it is accepted and then published, this does not prevent the author from using the substance of the work to create the work in a new form for submission to another publication (although, in scientific circles, writing a second article based on exactly the same data would be considered to be a form of scientific misbehaviour).

A further issue that we must consider as amateurs relates to agreements amongst IARU member societies. These agreements mean that an article published in, say, AR, can be re-published by the sister society in their journal (for example, in Break In, the journal of NZART), with appropriate recognition of the prior publication.

In an attempt to raise awareness of these considerations, a formal statement of expectations has been drafted and approved by the Publications Committee. That statement is printed below for your information. Authors are also reminded that a document is available on the WIA website giving them guidance in the preparation of their material.

## Basic rules for submissions to AR

Articles submitted for publication in *Amateur Radio* are accepted on the understanding that:

- the article is not currently on offer to any other publication;
- the article is an original work written and created by the Author;

*continued on page 12*



# On-air behaviour

I have received a number of letters and e-mails from members complaining about on-air behaviour.

I was listening on a country repeater some weeks ago, and I heard a Foundation licensee describing how badly he was treated when he attempted to operate on 40 metres for the first time.

Recently my wife heard my handheld tuned to a repeater, and she was concerned at the foul language being used.

I am told that some people have been threatened on air.

I have heard what appeared to be deliberate interference caused to an amateur station by another unidentified station.

I have been given a recording of an amateur station transmitting what can be charitably described as vitriolic political comment.

Some have suggested that the WIA should take action against amateurs guilty of such behaviour.

This is a topic that I have tried to avoid, as I realise that it is just too easy to sound self righteous and smug and appear to be preaching, all of which the WIA should not do. But it is not a topic that can be avoided, and I would like to put a position and invite comment.

Of course the WIA Board deplores such behaviour. That goes without saying.

That is not just some sort of value judgement in a vacuum. Our reasons go well beyond that.

We are committed to promoting the amateur service to the community generally. How easy is that when the privilege we seek is used in ways I have described?

We are committed to attracting new amateurs. How are we going to do that when the Foundation licensees have the experiences that I refer to?

We are committed to representing the amateur service nationally and internationally to ensure that the service has and retains the facilities it needs. But the amateur service is in competition with every other user and potential user of the radio spectrum for the right to use that spectrum, which is a limited resource. Is such behaviour a justification

for the allocation of spectrum to the amateur service in preference to our competitors?

Recently I came across a copy of the old Amateur Operators Handbook, which was marked as Revised December 1978 and published by the then Postal and Telecommunications Department.

At that time, the basic subordinate legislation were the regulations made under the Wireless Telegraphy Act 1905. In Chapter 6, General Provisions, it said the following:

## *Prohibited Traffic*

*6.6 The operator of an amateur station is not permitted to transmit or receive:*

- (a) messages or visual images on behalf of third parties (however it is permissible for an amateur to arrange a schedule with another amateur station on behalf of a third amateur station);*
- (b) 'phone-patch' traffic;*
- (c) matter which is profane, obscene, indecent or otherwise objectionable;*
- (d) any message in consideration of payment in cash or kind;*
- (e) music (except for single or dual audio tones for tests of short duration) or other form of entertainment;*
- (f) news of or on behalf of, or for the benefit or information of, any industrial, commercial, political, social or religious organisation or any-one other than the operator or the person with whom he is in communication.*

Whether that accurately expressed the Wireless Telegraphy Regulations or not, and the extent to which it was enforceable is not the point. It represented a much more restrictive environment for the amateur.

Today there are no truly equivalent provisions to (c) and (f).

Even if there were such provisions today, I think that we would have to accept that what a quarter of a century ago was "profane, obscene, indecent or otherwise objectionable" will not

necessarily be found to be so today. Community standards change and have changed. What is acceptable on television today may well have been unacceptable 25 years ago.

We must be careful not to judge today's conduct by yesterday's standards, no matter how much we prefer the past.

But what are the offences and licence conditions that govern what may be loosely described as behaviour today?

There are provisions dealing with interference in the Radiocommunications Act 1992, see Part 4.2 of Chapter 4.

The closest is probably in section 108 of the Radiocommunications Act, which sets out certain additional conditions for a transmitter licence, including the condition that the licensee (d) *must not operate, or permit operation of, the transmitter: (i) in a way that would be likely to cause reasonable persons, justifiably in all the circumstances, to be seriously alarmed or seriously affronted; or (ii) for the purpose of harassing a person.*

Of course, behaviour that amounts to racial vilification or other conduct that is proscribed by other legislation can give rise to a breach of the relevant racial vilification or other legislation.

On the other hand I have no doubt that some of the behaviour that most would regard as inappropriate is also in breach of the law as it stands today

What should the WIA do?

We do not think that the WIA should attempt to act as a law enforcement agency.

If the RACV in Victoria or the NRMA in New South Wales, both motorists' organisations, both advocating that their members always drive lawfully and safely, started handing out traffic infringement notices to their members, we suspect they would rapidly lose support.

We do not consider that it is the role of the WIA to become involved in law enforcement activities, which can so quickly be seen as provocative, and quite inconsistent with our primary role of representing our members and the amateur service generally.

---

*continued on page 12*

## WIA Releases New Assessment Packs and New Assessment Instructions

The WIA has released Assessment Packs for the Practical Assessment taken alone and not part of a Foundation Assessment, Standard Theory Assessment Packs, Standard/Advanced Regulations Assessment Packs and will release shortly the Advanced Theory Assessment Pack.

This means that WIA Assessors can conduct all levels of the amateur operator certificate of proficiency examinations, the qualifications for each of the three grades of amateur licence, with the candidates being given their results on the spot by the WIA Assessor.

With arrangements almost finalised to train more WIA Assessors in North Queensland, South Queensland, Sydney and Melbourne in the very near future, it is anticipated that the assessment system will continue to be very busy.

All of these changes have made a further and quite extensive revision of the WIA Exam Service's Assessment Instructions necessary. In addition, new and hopefully simpler forms have been introduced. The

revised Instructions have been sent today to each WIA Assessor, and will be placed on the WIA website shortly.

The continued development of the WIA Assessment system has involved a great deal of work by a number of people, said WIA President Michael Owen, VK3KI.

*But what is important is that the clubs and the trainers encourage the new Foundation licensees to aspire to the Standard licence and then to the Advanced licence. Hopefully, this will encourage that progression.*

## Amateur licence fees increase

From 3 April 2006 the tax component of all radiocommunication licence fees was increased by the CPI and accordingly the yearly fee for all amateur licences increased by \$1 from \$58 to \$59.

## VK Foundation licences continue to grow

Last month AR reported that just four months after its introduction ACMA issued the 250th Foundation Licence.

In the week before the Easter break, the number of Foundation licences issued by ACMA passed 430.

## Foundation licensees prominent in the Subaru Rally of Canberra

Alan Hawes VK1WX reports that five new Foundation licensees participated in the rally on the weekend of March 11 and 12. They were Darren VK1FDZS, Brad VK1FRST, Shane VK1FSRB, Sam VK1FLYA (who is 14) and Phil VK1FPWH.

Alan quotes Bob VK1HBH, one of the operators in headquarters, "I would like to comment on the great performance of our recently licensed "F" calls during the rally. I think our F calls acquitted themselves very well indeed with all of them holding their own with the more experienced operators. I think, too, that their operating technique improved markedly over the course of the weekend as they became more comfortable and confident in the WICEN operation. Some were under a lot of pressure for first timers in such an important event and they did well ... a real credit to their training and enthusiasm. The old hands obviously helped a lot but that is the spirit of amateur radio "around here now!"

ar

# WIA BPL Interference Advisory Service

Phil Wait VK2DKN  
Director

Early in April the WIA Board of Directors moved to introduce a new BPL Interference Advisory Service for Australian amateurs.

## Why a BPL Interference Advisory Service?

BPL trials currently operating in Australia cover small geographic areas. Very high levels of spurious emissions occur within the trial area and significant spurious emission levels are detectable up to about 2 km distant.

Due to the small size of the trials undertaken to date, only a few amateurs have been affected by interference from these BPL trials. Some of those amateurs have lodged interference reports.

More and larger BPL trials are now planned and it is expected greater numbers of radio amateurs may be adversely

affected by BPL interference. It is also expected that those radio amateurs will wish to lodge interference complaints with ACMA and the BPL trial operator.

ACMA advise they have investigated a number of complaints from radio amateurs of BPL interference which were found to be from non-BPL related sources.

The WIA believes that the responsiveness to, and efficiency in handling of, BPL interference complaints lodged by radio amateurs will be improved if complaints undergo a technical and administrative review process prior to being lodged with ACMA and the BPL trial operator.

## Avoiding incorrect interference complaints

Wrongly based interference complaints will damage our entire effort against BPL interference. Wrongly based interference complaints must be avoided.

All BPL interference complaints should be correctly identified as actual BPL interference prior to lodgment with ACMA or the BPL operator.

The WIA has been an active participant in ACMA's (formerly the ACA) previous work to provide a framework for trials of BPL systems. ACMA has recently notified the WIA of a forthcoming

review of the BPL trial guidelines and has invited the WIA's participation in this process. The WIA Board considers that complaints based on incorrectly identified interference may be used by others to discredit the amateur service, and to question all interference complaints by amateurs.

## Building a case of harmful interference

Lodging an effective interference complaint is not an easy task, and the WIA Board believes the WIA has an important role to play assisting radio amateurs to ensure that their interference complaints have maximum effectiveness.

An amateur lodging a BPL interference complaint should demonstrate that they have suffered "substantial interference".

Section 197 of the Radiocommunications Act (1992) creates an offence of recklessly causing "substantial interference" to radiocommunications. The amateur service is a radiocommunications service.

One way of showing "substantial interference" may be to show that where you were able to regularly communicate before the BPL system is enabled, and are now no longer able to communicate in exactly the same set of circumstances (time of day, frequency, other station etc.) when the BPL system was enabled. It would also be necessary to show that the interference continued after the person or entity responsible was notified of their causing the interference, the interference was verified as being caused by them, and they had sufficient time to rectify the situation.

## The WIA Service

A BPL Interference Advisory Service provided and funded by the WIA, available to all Australian radio amateurs, provides the following services:

### 1. Validation of interference as likely coming from a BPL source

#### *Interference signature*

All amateurs who suspect that they are experiencing BPL interference are encouraged to send an audio file of the interference to the Interference Advisory Service. The audio file should be recorded while very slowly tuning across the BPL signal in the SSB, AM, and FM modes,

or at least as many of those modes as possible.

Other useful information that should be included is the date and time (UTC), the make and model of receiver/transceiver, signal strength and the antenna type, eg dipole, Yagi, vertical or open wire.

#### *Interference frequency Band*

BPL interference will likely be confined to one or more bands of spectrum several megahertz wide. The frequency bands where BPL interference is noticeable should be recorded and submitted with the audio recording.

#### *Location of BPL trials*

The BPL Interference Advisory Service will check the licensee's location against locations of known BPL trials.

The BPL Interference Advisory Service will advise the amateur if the interference recordings submitted have a high probability of coming from a BPL source and, if so, make a recommendation to proceed to lodging a formal interference complaint.

### 2. Assistance in preparing and lodging an effective interference complaint

#### *Showing "substantial interference"*

Obviously it is helpful if amateurs keep a log of regular activity, especially where particular stations are contacted on a regular basis.

After suspected BPL interference is experienced, amateurs should make repeated attempts to contact the same stations at exactly the same time and same frequency and should log when the suspected BPL interference substantially disrupts or substantially disturbs (repeatedly and for long periods of time) communications.

If an amateur is no longer able to contact these stations after experiencing BPL interference then a case of 'substantial interference' can be made, though it is essential that it can also be shown to continue after the person responsible for the interference has knowledge of the particular interference, which is why the BPL operator must also be notified.

### 3. The FSM software package

Owen Duffy VKIOD, in association with Ed Hare WIRFI of the ARRL, has developed a technique for accurately measuring the field strength of a signal

or noise using a standard amateur transceiver/receiver and a computer with sound card.

It assists an interference complaint if the background noise level was accurately measured prior to any local BPL activity, and again after BPL activation. Failing that, background noise level may be measured outside the BPL affected area.

The FSM software with operating instructions is available at <http://www.vk1od.net/fsm>. The WIA encourages its use and the BPL Interference Advisory Service will provide assistance should it be required.

The equipment to enable FSM measurements is commonly available, but not necessarily in every ham shack: a computer with Win98SE or later, sound card, FSM (free software), email and web browser; a receiver or transceiver; a known step attenuator (for example MFJ-762 or similar) are needed and an antenna of known gain (mobile whip preferably roof mounted or a half wave dipole) is also desirable.

#### *How to access the service*

Access to the service will be via the BPL webpage on the WIA website. The webpage includes information about the service, links to sound files of actual BPL interference, and downloadable forms.

Those wishing to use the service are asked to download their interference recordings and complete the appropriate forms. After analysis of the material a WIA BPL Interference Advisory Service representative will contact you by phone to discuss the best course of action.

ar

## *Plan ahead*

### **The Gippsland Gate Radio & Electronics Club Hamfest**

On 22 July they will be conducting their Hamfest Sale at the Cranbourne Community Hall, Cranbourne.

## **Stall holders**

should book early as demand will be very high. contact

Dianne Jackson VK3JDI

on (03) 5625 2545

# A simple computer-to-radio PTT interface

Vince Henderson VK7VH

The age of digital modes is certainly upon us. Connecting a computer to a transceiver opens up a whole new world of communications.

Unfortunately, some older radios require a little work to overcome a few inherent problems. Anyone who has connected their computer to a transceiver will tell you that, in many cases, it is important to isolate the computer audio and comport PTT connections. This minimises the chance of unwanted ground loops. Other problems include radio PTT lines that carry large currents, and the need to disconnect or mute the microphone line.

Although it is possible to use the microphone input line to accomplish most connections, the constant need to manually switch between microphone input and computer sound card input can become a chore. Another problem is the need to make a separate connection to the speaker jack for audio input to the computer soundcard, when no audio output is available at the microphone connection. This is the case that I had with some of my older VHF and HF radios.

The diagram details a circuit that will overcome some of the problems. Whilst this is not the answer for all situations, if you have an accessory socket on the rear of the radio, or can adapt a way to insert a cable, the circuit may be a solution. A single rear entry point makes for a tidy set up. The circuit is used to switch a relay that will provide PTT and automatic isolation of the microphone input. If you use an interface that only needs an opto-coupler to switch the PTT for one of your radios, but require an alternative to switch PTT for other radios, then this circuit may be one solution. This can be achieved by inserting a separate switch immediately after the output of the opto-coupler and diverting the signal to T1 and on to the second radio PTT.

## Circuit description

U1 (IC1 on circuit) provides PTT isolation between the radio and the computer. The input to the opto-coupler is via pins 1 and 2. Pin 1 of U1 (a 6 pin DIL package) is marked by a dot on the top of the plastic case. U1 senses the voltage change state

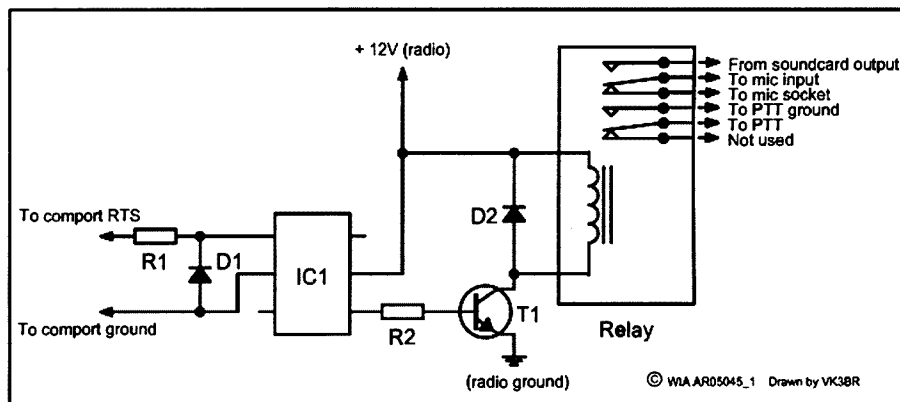

Fig 1 - Diagram 1

from the computer comport. R1 limits the input to U1 and D1 provides protection from reverse voltage. When U1 senses the input from the comport, this turns on the internal transistor output stage. Pins 4 and 5 of U1 are used to drive the base of T1. This in turn provides a current flow through the collector and emitter of T1. When T1 conducts, voltage is supplied across the relay coil. T1 could be any general purpose NPN transistor. The addition of D2 avoids back EMF from the coil.

## Mounting the bits

All the components may be mounted inside the radio. In my case I have an interface box that can switch outputs/inputs to multiple radios. U1, D1, R1, R2 and T1 are mounted inside the interface. The relay and D2 are mounted inside the radio. D2 is soldered directly across the coil pins. The important consideration is to mount the relay inside the radio as close to the internal microphone connections as possible. Use shielded cable for the microphone connections. However, do not connect the braid! Connecting the braid could induce ground loops. The +12 volts is obtained from within the radio at any convenient point. You should adapt the circuit and make the connections to suit your situation.

The PTT switching suits a wide range of radios. I use the circuit on a Kenwood TS-520S, an oldie but a goodie, an Icom IC-290 2 m multi-mode, and a Yaesu FT-212RH 2 m FM. All work without problems.

Most parts should be readily available from your local electronics parts supplier.

## Parts list

- R1 - 1 k (quarter watt)
- R2 - 4k7 (quarter watt)
- D1 - 1N4148
- D2 - 1N4001
- T1 - 2N2222A (NPN)
- U1 - 4N25 opto-coupler
- Relay - 12 volt DPDT miniature relay

## Plan ahead

July 15 2006  
Jack Files  
Memorial  
Contest

# It's radio Jim, but not as we know it

Bill Isdale VK4TWI

**A visitor to a museum of early radio technology may be rewarded with the sight of a spark-gap generator. Unfortunately, it won't be possible to see a demonstration of this early transmitter; it won't be operated, but not because the curators are afraid it would not work; the problem is rather that the simple and robust device would work perfectly well, just as it used to, in fact.**

It is now impossible to obtain a licence to operate one of these transmitters as they are the very thing that resulted in the establishment of radio spectrum regulators the world over. They have been driven from the spectrum because they occupied too much of it.

The spark, like its big brother, the lighting bolt, which does well without government regulation in the approximately 600 thunderstorms that are active somewhere in the world at any time, generates radio energy across the whole radio frequency spectrum.

Those parts of that energy that are in what we call the high frequency spectrum can be heard around the world, reflected by the ionosphere and contributing to the background radio noise of natural origin, like that which comes from the Sun and Jupiter, for instance. Jupiter, by the way, takes 11.86 of our years to orbit the Sun, a period that corresponds rather well to the solar cycle that has a major influence on the Earth's ionosphere.

Unlike lightning, the orbits of planets and the behaviour of our local star, it is possible for governments to regulate spark generators and other types of manufactured radio transmitters.

There are many other sources of radio frequency energy, such as the sparks from electric welders, and the noise from electric motors which humans are responsible for making, but are not subjected to much, if any, regulation as radio emitters since they are not connected to antennas and so do not get their signals out over great distances.

As radio became more widely adopted, it was necessary to find ways to keep the energy within narrow frequency limits so that users would not "interfere" with each other.

The development of radio communications has been carried on within the boundaries of the idea that the less spectrum space occupied the

better, since this made it easy to minimise interference, given the equipment available when that idea was adopted nearly a century ago. The application of this thinking has, in recent years, seen telecommunication companies buying the use of spectrum from governments which have declared that they own it, and paying hundreds of millions of dollars for the exclusive right to use a narrow piece of it.

In order to make some money out of their shareholders' investments, they have employed creative schemes such as time division and code division so that the available spectrum can be sliced and diced to allow the maximum amount of revenue-earning traffic to be carried over their networks, which are designed to use the frequencies for which they have paid a mint.

Recent communication devices of amazing capability exploit these technologies so that people can be encouraged to use them to send pictures to each other in order to show that they really are as happy as the sellers of these products suggest that they will be if they buy and use them.

You may notice that governments worldwide have claimed ownership of radio spectrum as that was thought, about a hundred years ago, to be the way to allow it to be most effectively used. It stopped many users all unintentionally jamming each other's transmissions as they could be allocated some space that they could occupy.

This does sound more than a little like the land title system, which starts with the government passing a law which it will enforce and which says that it

owns all the land. The land is then cut up into pieces and sold. The pieces have become progressively smaller and more expensive, especially if in a good location. The parallels with the radio spectrum are obvious.

That is all well and good for land; after all, humans want their own land and sharing it has not been vastly popular. The means of "owning" radio spectrum may have been all that suggested itself a century ago, but does it remain a good idea? If there is a better idea, don't expect those who have spent large amounts of money on buying spectrum to be keen to abandon a concept that maintains the value of their invisible asset. Perhaps, however, it is invisible because it isn't really suitable to be regarded as a private asset.

We can look out into space and feel that of its very nature no individual owns it. It has not been thought, at least yet, to be capable of being owned. Perhaps that is because there isn't any money to be made from owning it.

If radio spectrum space could be used in such a way that anyone could use any part without interfering with someone else, then the rationale for owning and selling little chunks of it would disappear. Also to disappear, of course, would be the book value of what has been bought for enormous sums of money. Such a change would inevitably be resisted, just like land reform has historically been all over the world.

An electrical welder may be transmitting a bit of radio energy, as a side effect of welding, on a frequency where communications carriers are sending important data; important not necessarily of itself but important because they are

**Look forward to some startling results in the use of ultra-wideband by experimenters who will demonstrate its effectiveness over ranges far beyond what those who are manufacturing the equipment would have envisaged.**

## South East Radio Group (SERG) Convention

Queen's Birthday Weekend  
(10,11 June 2006).

The Australian Fox Hunting Championship will be conducted and we are expecting a number of stalls with both new and used equipment.

This year there will be a partner's trip on the Sunday. The trip will include the Nangula Market, Penola and possibly Coonawarra. There will be a small charge to cover costs.

Check the club website <http://serg.mountgambier.org/conv2006.html> for the convention program.

Enquiries to Wayne Kilpatrick  
VK5ZX Phone 08-87254335  
or 0407718908 email:  
vk5zx@internode.on.net

charging to provide the service. The welder will not be stopped unless and until it "interferes" with the service that has paid to use the frequency. If there were no interference then there would be no need to exclude another use on the same frequency. Like space, it would assume its real character as something that is there for everyone. If people can use it without interfering with other uses, then why should anyone be denied the opportunity?

Enter, or re-enter, the spark generator. The very thing that led to locking up chunks of spectrum as if it was land might have the potential to free it again. Free it in our minds, that is; perhaps the lightning bolt and the welder illustrate that radio spectrum has always been free of the limitations which people have thought necessary to impose upon one another.

The restrictions on using spectrum space may be seen as a product of the infant technology that existed when they were imposed. Maybe they are now outdated ideas that are holding back progress, as vested interests tend to do.

Progress, of course, will occur, and is about to bring onto the market radio

communications devices which will use what is called ultra-wideband. It is based on the insights of Gerald Ross, a communications engineer whose watershed paper on the subject was written in 1978. The rest of the world is only now finding just how useful are his ideas. The emission of very short pulses of energy, instead of sine waves, replaces frequency regulation with timing. Fourier analysis shows that a nanosecond pulse of radio energy is the same as a thin smear of energy across a wide band. A pulse lasting a nanosecond, for instance, has an effective bandwidth of a gigahertz. Cutting the duration of the pulse increases the bandwidth in direct proportion. The greater the bandwidth, the more information can be carried. The immediate application of this technology will be by the microchip maker Intel that will exploit it for wide bandwidth networks carrying data between computers in an office or home.

The United States Federal Communications Commission, asked to license this, looked at it and saw their old enemy, the spark-gap generator. A public call for comments led to a flood

# Andrews Communications Systems

### ICOM DISCOUNTED

IC-756 Pro III HF+6m	\$4,999
IC-V8000 2m 75W	\$399
IC-746 Pro HF+6m+2m	\$2,699
IC-706 Mk 2G HF-70cm	\$1,399
IC-718 HF SSB	\$999
IC-910H 2m+70cm SSB	\$2,199
IC-208H 2m+70cm	\$579
IC-2200h 2m 60W	\$399
IC-T90A Triband h/h	\$449

4 YEAR WARRANTY

### ALINCO

Factory Direct Importer

NEW DR-635T Twinbander	\$699
DR-605E Duplex dualband	\$499
DR-135T Mk2 2m 50W	\$349
DJ-V5E Dualband handheld	\$499
DJ-X2000E Hi-tech scanner	\$699
DJ-X10E All-mode scanner	\$499
DJ-596T Dual band handheld	\$349
DJ-C7 Tiny dualband h/h	\$299

\*3 YEAR WARRANTY\*

Spectrum Analysers from	\$1499
Oscilloscopes from 20MHz to 100MHz	

### ICOM IC-7000 \$2199



HF-70cm COLOUR TFT DISPLAY  
IF DSP, Twin PBT, 508 channel  
memory and much more!

bhi DSP NES10-2  
Amazing DSP speaker

Hundreds  
sold!  
\$249



### KENWOOD DISCOUNTED

TS-570SG HF+6m+ ATU	\$1,999	TM-271A K 2m mobile	\$349
TS-480HX HF 200W+6m	\$1,999	TM-D700A Dualband Mob	\$899
TS-2000 HF-70cm + ATU	\$2,799	TS-480SAT HF+6m+ ATU	\$1,799
TS-570DG HF + ATU	\$1699	TM-G707A 2m/70cm mob.	\$499

### YAESU DISCOUNTED

FT-1802M 2m 50W Mob.	\$289	FT-60R Dualband h/h	\$349
FT-7800R Dualband	\$449	FT-817ND HF-70cm Port.	\$1099
FT-8900R Quadband	\$799	VX-1R H/held 2 batts	\$249
FT-8800R Dualband	\$699	VX-2R Tiny Dualband	\$319
FT-897D HF-70cm	\$1,399	VX-170 2m H/held	\$269
FT-857D HF-70cm	\$1,299	VX-6R Dual H/H	\$469
FT-2800M 2m 65W	\$299	VX-7R Deluxe H/H	\$549

\*YAESU ROTATORS DISCOUNTED\*

\*3 YEAR WARRANTY\*

Australia's Biggest Amateur Radio Stockist

### NEW!

ANDREWS DUALBAND WHIPS frm \$49  
(similar Diamond). Factory Direct Importer!  
ANDREWS BATTERIES New fr. \$29!  
DIAMOND, MALDOL, COMET, HUSTLER,  
and HIGH SIERRA antennas all in stock.  
THP, LDG, MFJ, ALINCO, ICOM, YAESU  
Automatic antenna tuners in stock  
TET-EMTRON HF Antennas in stock  
AVAIR POWER METERS, "T" LEADS, ETC.  
MFJ Antennas, Tuners, Analysers, etc.  
ANDREWS AMPS .160m-10m 500W+  
w/protect. \$999, 2m 120W \$329,  
200W \$449, 300W \$999.  
ANDREWS YAESU, PALOMAR, TE SYS-  
TEMS, AMERITRON, ICOM linears

### ANDREWS AMATEUR BASE ANTENNAS

BF-2M2 Fibreglass 2m 6.7dB \$99  
BF-2M3 Fibreglass 2m 7.8dB \$129  
UVS-200 Fibreglass 6dB/8dB \$149  
UVS-300 Fiberglass 8.3dB/11.7dB \$199  
CBS18 Fiberglass 5.7dB 10m \$149  
Disconses from \$129, Coax switch \$29  
We export worldwide. We also hold  
some stock in New Zealand!

CALL (02) 9636-9060 or (02) 9688-4301 or FAX (02) 9688-1995

Shop 8, 41 Bathurst St., Greystanes, NSW 2145

WHY PAY MORE?

MAIL ORDER to PO Box 240 PENDLE HILL NSW, 2145

<http://www.andrewscom.com.au>

email: [lee.andrews1@bigpond.com](mailto:lee.andrews1@bigpond.com)

Some items  
indent.  
Prices subject to  
change without  
notice.  
Limited stock  
some items  
E&OE 4/06

of objections from those who feared the resultant jamming of aircraft anti-collision and instrument landing systems, GPS satellite navigation and more.

A compromise has allowed ultra-wideband to operate, not across the spectrum but between 3.1 and 10.6 gigahertz, with severe power limitations. The frequencies and power allowed will, it is said, reduce the effective range to some tens of metres but the system, like broadband internet over power lines, is a potential money-maker and will undoubtedly appear in Australia almost as soon as it does in the United States.

As for transmissions over a few tens of metres, the present standard for "Wi-Fi" networks was the subject of similar range limitation claims and at the 2004 "Defcon" conference in the USA a range record of 55.1 miles was set for that system, with an amplifier. The amplifier was then turned off and a record was set for distance with this system "barefoot" of, yes, 55.1 miles.

The practitioners of low power radio communication will be quick to point out that a few watts works just fine if there is a path open for the signal. Recent personal observation of a single side-band contact between Queensland and Victoria using 100 watts on 20 metres illustrates the point. My friend, ably assisted by me looking over his shoulder, was making the contact. Pointing the antenna towards VK3 brought no result, but pointing it the opposite way worked fine. Assuming that the front to back ratio of the beam antenna was as advertised, then the long path was producing the goods. Imagine the complexity of that path, VK4 to VK3 via the North and then South Polar regions. It happened to work. Significant path loss was inevitable, and a whole world of natural and man-made noise lay between the two stations.

Imagine a future where the lessons that communications engineers have learned in the half century since single side-band was invented are put to use. Our transceiver listens automatically around the bands available to amateur radio operators; sending some packets of data to any transceivers that are in operation and waiting for a response. It uses the whole of the available spectrum and negotiates minimum power with whatever other stations that it can reach. Like a modem, it tries out the options and can present us with an on-screen list of our potential contacts.

This has eliminated the manual search

for openings and the selection of band, power and mode. Our radio will check out the spectrum and put at our disposal what will actually work. We could proceed to communicate while the radio keeps updating the necessary tuning to maintain the link.

Look forward to some startling results in the use of ultra-wideband by experimenters who will demonstrate its effectiveness over ranges far beyond what those who are manufacturing the equipment would have envisaged. The extension of the same technology onto the HF bands on a "not to interfere with other uses" basis has the potential to open up world wide amateur radio links at quite low power levels, reducing enormously the likelihood of interference with other electronic equipment operated by people living nearby.

There will be no need to try to force a path by increasing radiated power when an available path can be found by using brain instead of brawn and where we can communicate without people who don't want our signals being inconvenienced by them. We will find that the emerging technology will satisfy our urge to experiment and innovate and that we can do so in ways that allow working the world without working up the neighbours.

What do you think you would see if you looked at a conventional signal on a spectrum analyser? A nice spike sticking up above the noise floor? Of course, that's what the machine was designed to show, so as to allow a radio signal to be seen. On the other hand, an ultra-wideband signal will be an undetectable smear of energy, which can be below the local noise floor; it can only be used because the receiver listens for it in the time domain and builds up the data a little at a time. Ultra-wideband will be very unobtrusive, perhaps providing a clue to its likely use over the last 30 years. This advance is about to trickle down from being of use to Generals to being of general use.

Enjoy the flow of information.

## Select Bibliography

"Radio freedom" by Danny O'Brien. New Scientist, 24 April 2004, pages 28 to 31.

"Radio sans frontières" by Bennett Daviss. New Scientist, 10 July 2004, pages 24 to 27.

ar

# OzGear

www.OzGear.com.au

Radio Communications & Electronics  
Uznep Services Pty Ltd 1/88 OzGear

Suppliers of radiocommunications,  
electronics and computer products and  
electronic test equipment.

Ph 07 3114 2506

sales@ozgear.com.au

Brisbane, Q'ld

Manager : Doug Hunter VK4ADC

## WE HAVE MOVED !

Unit 2 ,  
139 Beenleigh Rd,  
Acacia Ridge 4110.

OzGear yagi antennas  
for 6m, 2m & 70cm  
now available



**Australian-sourced radios with  
Australian-based manufacturer  
warranties.**

Authorised Aust Icom and Yaesu Dealer

Antenna, cable, interface, tuner and  
general accessory products from...

Amidon, Andrews USA, Autek,  
Benelec, Bushcomm, Comet, Daiwa,  
Diamond, Garland, GeoSensory, GME,  
Icom, Kingray, LDG, Lutron, Mobile  
One, RFI, Sangean, SGC, TET-Emtron,  
Tigertronics, Yaesu, ZCG Scalar plus  
ARRL and RSGB publications....

# ALTRONICS

Many products stocked

**Product & pricing info ?**

Phone, email or visit us on the web at

**www.OzGear.com.au**

for the latest product info plus on-line  
ordering. Our latest price list can be  
downloaded at any time.

Payment ?



# CW Central – a versatile keyer unit

Dale Hughes VK2DSH  
PO Box 7430  
Sutton NSW 2620

Having recently discovered the joys of QRP CW operation, I decided to adapt some hardware and firmware from a previously described CW transceiver (See reference 1) to build a stand-alone keyer for other transmitters.

The result of this is a device that can:

- Generate precisely timed strings of dots or dashes from a paddle type key.
- Transmit a pre-programmed message string. eg CQ CQ CQ DE VK.... This message can be loaded into the unit via the serial port. The operator can change the stored message at any time.
- Be used as code practice oscillator, producing five letter groups of random letters and figures.
- Generate CW directly from an ASCII serial input such as that generated by a personal computer or terminal.
- Provide automatic control of the press-to-talk line of a transmitter.

The unit is very easy to use and can generate high quality Morse code at word rates of approximately five to thirty words per minute. This word rate can be changed at any time by means of a rotary switch.

## Circuit description and construction

The device is built around an Atmel AT90S8535 micro-controller. This device contains 8 kbytes of program memory, 512 bytes of SRAM and 512 bytes of EEPROM. It is easy to use and readily programmed. Whilst not strictly necessary, and with the exception of the RS232 serial circuit, all inputs and outputs are optically isolated and well filtered to prevent the unit from generating radio frequency interference. Control signals to the attached transmitter are via 'dry' relay contacts, although the open collector outputs from the opto-couplers can be used to control an attached transmitter if relays are unsuitable for any reason. I used SFH615 opto-couplers because I had a supply of them - other devices could be used if required. In this case the current limiting resistors (R14 through R21) might need to be changed.

A 16-way BCD switch selects the word rate of the Morse transmission and speed changes are implemented by the firmware when the unit is not generating any code.

Serial data into and out of the device is converted to RS232 levels using the well-known and easy to use MAX232 (or similar) interface. A simple three-wire circuit is used, and no hand shaking has been implemented, as the data rate is quite low – limited by the transmission time of the Morse code.

Power to the unit is regulated down to 5 V DC using a 7805 regulator. The supply is well filtered to prevent any RF from nearby transmitters affecting operation of the micro-controller. Inductor L1 consists of 10 turns of wire, wound on to a 12 mm toroidal core salvaged from an old computer power supply. The unit consumes approximately 30 mA of current when no relays are energised.

Resistor R13 can be adjusted to vary the volume of the side-tone heard on the loudspeaker. I found that 100 ohms produced a satisfactory volume when using a small 8 ohm loudspeaker.

A small diecast box (Jaycar HB5067) houses the circuit board and switches. The unit can be built on 'Vero-board' if required as the circuit is straight forward; or a printed circuit board can be manufactured if desired.

## Operation

There are two operating modes for the unit and these are selected by the position of the PTT switch. If the PTT switch is not actuated, ie open circuit, the keyer is in the 'practice' mode and the user hears a tone from the unit when any sending function is activated. The PTT and keying relays do not operate in this case.

Activating the PTT switch puts the keyer into 'live' mode and the PTT and keyer relays are activated when transmission of any Morse characters is

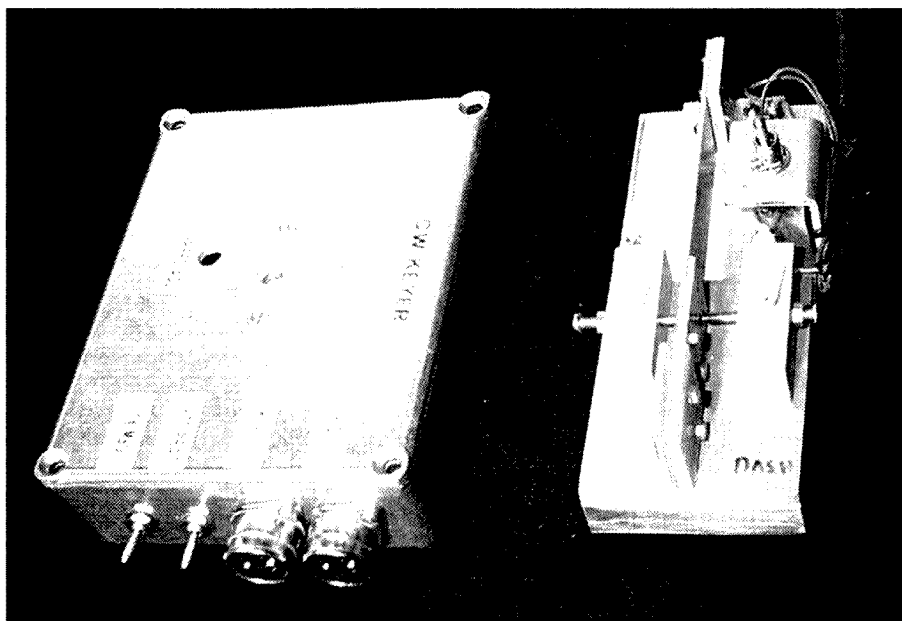

Photo 1 - The keyer and associated paddle. Connections to the paddle and the transceiver are made by means of the 5-pin DIN connectors on the front of the keyer box.



Components inside this box are mounted on the printed circuit board.

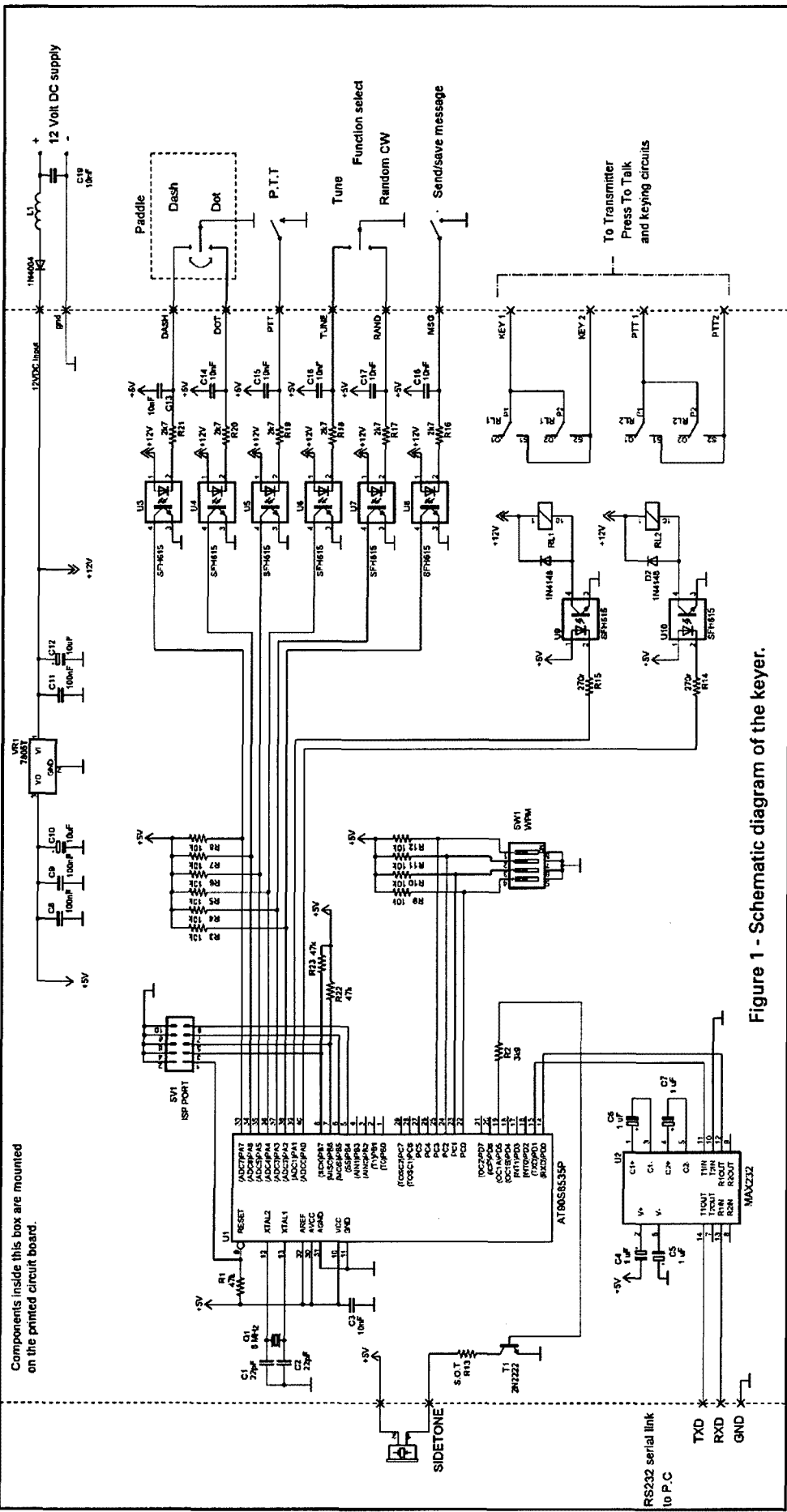

Figure 1 - Schematic diagram of the keyer.

required. In this mode it is expected that side-tone is generated by the attached transmitter. Note that the PTT relay switches approximately 30 milliseconds before the keying relay switches and that the PTT relay stays closed for approximately 1 second after the last dot or dash is sent. The delay in switching prevents transmit/receive switching when the transmitter is generating a signal. It is not necessary to operate the PTT switch between 'overs' as the PTT relay is switched when any transmission mode is selected.

The exception to the above is the 'tune' switch. If this switch is operated, the PTT and keying relays operate - separated by a short delay - and a local side-tone is generated. This allows an associated transmitter or antenna-matching unit to be tuned if required.

Selection of the random CW mode, or transmission of the stored message, occurs when the appropriate toggle switch is operated. Manual transmission occurs any time the paddle is operated. Characters received by the serial port are saved in a type-ahead buffer and are transmitted as Morse code at the selected word rate. The characters in the buffer may be copied into CPU non-volatile memory (EEPROM) by depressing the 'stored message' switch any time before the message transmission ends. When this is done, and at the conclusion of the current message transmission, a message is sent from the keyer to the attached computer or terminal to indicate that the memory has been updated.

Random characters are generated using a 15 stage shift register with feedback (see reference 2). This produces a long sequence of random characters and such systems are called 'pseudo-random number' (PRN) generators. Such a system can be implemented in hardware using a shift register with feedback derived from various points along the register which is then combined using exclusive or gates. In this keyer the same sort of system was created using software inside the micro-controller. An example of a typical sequence generated by the

## Ozspid Rotators

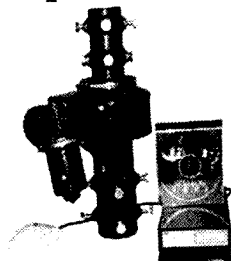

Oceania - New Zealand - Australian  
Distributors.

Australian Enterprise Industrial

P.O. Box 1013

Browns Plains. QLD. 4118.

Ph. 0414 254 080.

Fax. 07 3800 8003.

aeitower@spin.net.au

<http://www.spin.net.au/~aeitower>

unit is YRD2E P,9RE OJZTH  
XQB3F RD02D MUK6L 1B+6L  
4H1CV XQC,9 etc.

Over time, all possible Morse characters and numbers are generated and character sequences will repeat after approximately 4000 cycles. The random character groups are also transmitted out of the RS232 port so a terminal or computer can capture them. The captured text can then be compared to what was copied from the Morse code.

Generation of the random characters was probably the most interesting part of the software development and a number of different methods were tried before settling on the PRN approach. Readers interested in random number generation, codes and ciphers are directed to chapter 8 of reference 3.

## Conclusion

The keyer described here has proven itself to be exceptionally pleasant to use and easy to build. I am happy to provide the firmware (AVR Studio4 assembler) and printed circuit board layout (EAGLE CAD format) to anyone who is interested; please write to me at the address given at the beginning of this article.

## References

Hughes, D. A dual band CW transceiver. Amateur Radio magazine, August and September 2005.

Kesteloot, A and Hutchinson, C. The ARRL Spread Spectrum Sourcebook, ARRL, 1997. P 4-8, table 1.

Churchhouse, R. Codes and ciphers. Julius Caesar, the Enigma and the internet. Cambridge University Press, 2002.

ar

## KVK Antenna Systems

Best value books in VK.

The VK Antenna Handbook  
for Restricted Spaces

Best value antennas in VK.

The NuBeam

The Vertical-LR-dipole  
multiband vertical

As seen at Wyong

Check out the latest revision to the web  
site - more info, more antennas, more  
value.

For direct purchases

[www.grimshaw.net.au](http://www.grimshaw.net.au)

For credit card purchases:

[www.kvkantennas.com.au](http://www.kvkantennas.com.au)

or ph 07-3216 8060 or

fx 07-3216 8075

## WIA Comment *continued*

We believe that we can appeal to amateurs to ensure that their conduct is appropriate, suggest that amateurs avoid provocative statements which incite aggressive responses, suggest amateurs choose frequencies that accord with band-plans and the general pattern of amateur usage, urge amateurs not to respond to provocative behaviour and deplore inappropriate conduct generally.

In the end, if the regulator is failing to act when presented with clear and unambiguous evidence of wrong doing, the WIA will request the regulator to act against those clearly in breach of the law.

I doubt if further regulation is the solution. It shouldn't be. We argue for our

privileges on the basis that the amateur service is basically self-regulating. Surely we can behave in an acceptable way without an enforcement officer standing over us?

I appreciate that only a small minority of amateurs behave in the way I describe, and indeed some conduct, while annoying, is harmless and is the sad evidence of ageing, alcohol or some other cause.

I hope that we never get to the position that some countries find themselves, where the repeaters exist but are not used because of the behaviour of a few.

But for whatever reason, when an amateur behaves badly on air, it is behaviour in a very public place. We all suffer.

ar

## Editorial *continued*

- the article is subject to editing for length, style, grammar, spelling and taste,

and, if published, the Author grants to The Wireless Institute of Australia (WIA) for the term of the copyright therein an irrevocable, royalty-free, non-exclusive licence throughout the world to:

- reproduce, publish, republish, transmit and distribute the article in *Amateur Radio* and thereafter in any other WIA publication or compilation in any manner and in

any medium whether now existing or developed in the future including in print, electronic and on-line formats, and

- to permit any other IARU national radio society to publish the article in its national magazine.

provided always the article is fully and clearly attributed to the author and, where appropriate, to the WIA and Amateur Radio.

ar

# Antenna Analyser revisited

David Milne VK3DPM

Turn your Antenna Analyser into a multifunction instrument with the ability to measure LCR (R for resonance); plus upgrade modifications, measurement ideas, and more.

In May 2005, Jim VK5JST published *An experimental HF aerial analyser* in *Amateur Radio* magazine. To date, a large number of analysers have been built and I must say I'm very happy with the performance from mine.

I have written this article primarily to demonstrate just how versatile the Analyser can become and how some simple modifications can further enhance it. If you missed the boat it's not too late to build one. You can go to Jim's website at <http://www.users.on.net/~endsodds/analr.htm> or contact the Elizabeth Amateur Radio Club at PO Box 8, Elizabeth, SA 5112, or email Keith Gooley at [keith.gooley@dsto.defence.gov.au](mailto:keith.gooley@dsto.defence.gov.au). The cost of the Analyser kit is a mere \$AUS117 which includes postage within Australia. This information is given in a link from the above website, but is included here for those without Internet or email access.

And before I go any further, I must congratulate Jim, Keith and all those involved from the Elizabeth Amateur Radio Club on the design, and for the effort in putting together such a great kit (see photo). This kit would have to be one of the best I have come across.

## My experience

Probably, like most others who purchased the kit, I just assembled it according to the instructions and turned it on. Well, it didn't work! But, after a couple of minutes measuring voltages, I discovered I had missed a solder pad on one of the ICs. With this fixed, away it went.

Being curious about using a PIC, in particular this series that provides such a simple computer interface, I thought I'd look at the program listing. To my surprise it was coded in Basic which would have to be the easiest programming language to use. I was soon making my own changes. I encourage anyone who is computer-literate to have a go. What you will find is that the maths is rather tricky as the PIC doesn't provide functions like square root, nor does it allow for floating point numbers like pi (3.14159), just to point out a couple of its limitations. However,

working through the program listing will show how the various constraints have been overcome and give you a chance to test your ideas. Working around these issues is part of the fun.

## Software update

I was initially interested in tidying up the display by removing unnecessary zeros but realised that, if we know the reactance and the frequency, it's possible to calculate capacitance and inductance. What followed was a software update to allow component measurement without any hardware modifications. My software update, and other modifications and information, are available from my website <http://members.optusnet.com.au/dpmilne/>. The software is also available from Jim's website mentioned above, which provides additional information related to programming the Analyser. For those frightened by updating your software, don't be – it's really easy for anyone that plays with computers. Hint – I put a 3.5 mm stereo socket in the side of my Analyser so I could easily program it without opening the case. An old mouse provides a great serial interface cable.

## How it now works

The Analyser has two modes: either a 4 or a 5 digit frequency display (the 4 digit mode provides a much quicker display update). By turning on the Analyser in 4 digit mode you start it in component function; switch to 5 digit mode and it's in analyser function; switch back to 4 digit mode and it remains in (4 digit) analyser function. Turn it on in 5 digit mode and it's in analyser function. The component measurement function is only available as a switch-on option in 4 digit mode. This allows both the operational functions without hardware changes.

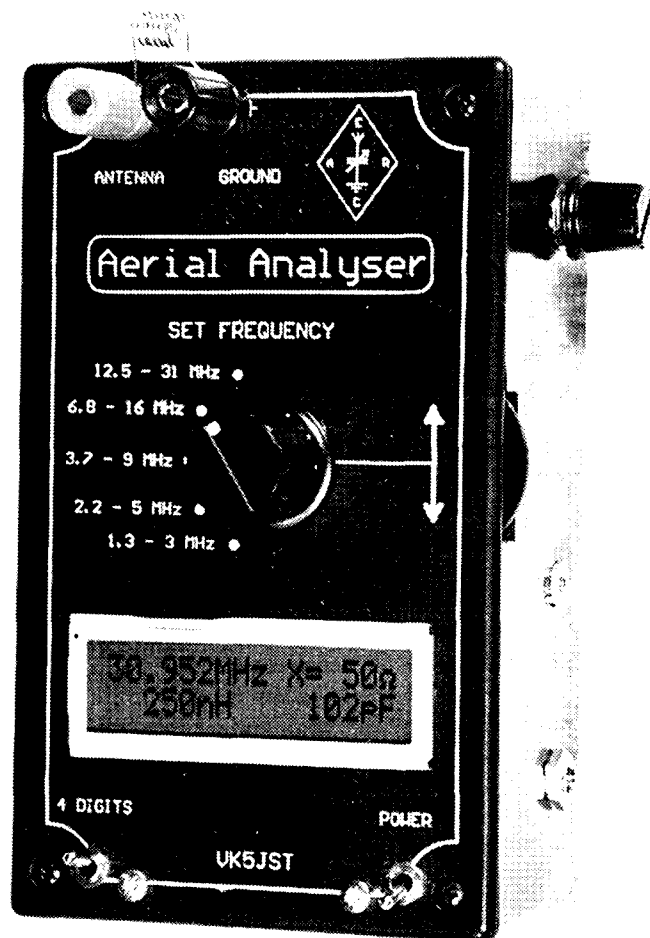

## Modifications

When setting up the Analyser, I was measuring the DC voltages on TP2, TP3 and TP4 and discovered, purely by accident, that they would change at the touch of my measuring device, even a high-impedance multimeter. These are the voltages read by the PIC – the internal processor that does all the hard work – and are clearly very sensitive. This can be fixed by bypassing each of the three test-points with a good quality 10 nF capacitor. Simply solder the capacitors directly from the test-points to the ground-plane using the shortest lead lengths possible.

When I constructed my Analyser, I allowed for an extra switch position in case I ever wanted to try to extend the frequency, which I have now done. Checking its value with the Analyser in component function, I wound a 330 nH inductor (10 turns, 0.5 mm wire, 5 mm diameter) and soldered it into the extra switch position. (Jim had already anticipated that somebody might want to do this, and allowed for it with the switch and circuit-board design – well done!). Remarkably, my Analyser now runs to just over 60 MHz. However, a warning! This modification is really pushing the limits of the design and components, and it may not work correctly for you or there may be significant errors. Paying particular care during construction to ensure you have minimum component lead lengths, as per the construction guide, is very important and will maximise your success. Having said that, mine seems to behave well in the 6 metre band, at least up to 2:1 SWR measurements, and I know of others that perform OK as well.

There are other modifications, details of which can be found on my website. If anyone has any modifications, and would like them published on my site, then I'm happy to make them available with relevant acknowledgements.

## Operation

With the software update you should now be able to measure capacitance from about 10 pF to 25,000 pF, and inductance from about 25 nH to 60,000 nH. The units displayed always remain as pF and nH although my next software revision will include auto-ranging to nF and  $\mu$ H. However, it cannot differentiate between L and C so that has been left to you. A side benefit is that, when you measure an inductor, the displayed capacitance

will resonate with the inductor at the frequency shown. As the Analyser can measure inductance down to short lengths of wire it is quite a useful tool.

Be aware that there may be errors up to 20%, or possibly more, due to quite a few different reasons which I don't intend to expand on here. For best results it's generally optimal to have the X value between 50 and 100 ohms although I have set the calculation limits at 5 and 500 ohms. Long capacitor pigtailed will also add to errors. You may get unpredictable results measuring capacitors that are not designed for RF applications.

## A couple of interesting applications

For the following examples you can use the Analyser in either function unless you specifically want to measure component values.

You can determine the impedance of transmission lines by connecting a length of transmission line and measuring the X values when it's unterminated (open), then shorted. The impedance is calculated as  $\sqrt{X_{open} \times X_{short}}$ .

With an unterminated length of coax, when its length is a quarter wavelength at the applied frequency (or an odd multiple, ie  $\lambda/4$ ,  $3\lambda/4$ ,  $5\lambda/4$ , etc) it will behave as a series tuned circuit, ie a "short circuit" with a very low impedance. So if you adjust the Analyser for a minimum X then you have the frequency corresponding to a quarter wavelength or odd-multiple quarter wavelengths. The other piece of information you need to calculate the length is the velocity factor of the cable concerned; due to distributed L and C within the cable the signal slows down and this slow-down is known as the velocity factor. For example, most RG58, RG8 and RG213 coax cables have a velocity factor of 0.66, whereas for open wire feeders this will be 1.0, or slightly less. That means that whilst a quarter wavelength in free space at 15 MHz would be 5 metres, through RG58 it would only be 3.3 metres (refer to the maths section below). Therefore, the Analyser can measure a quarter wavelength of RG58 cable from 1.65 metres (30 MHz) to 33 metres (1.5 MHz).

The converse also applies: it's possible to measure (indirectly) the velocity factor. If you know the length and the frequency at zero (minimum) impedance then you can calculate the velocity factor.

I suggest that you test the Analyser

with known coax types and lengths, as the internal Analyser circuitry and termination will alter the measurement. You can always use a reference length of cable. Connect the cable to be measured to the end of the reference cable using a suitable connector, then calculate the total length and subtract your reference length.

## Maths

For those who don't know or have forgotten:

$$X_c \text{ (capacitive reactance)} = 1/(2\pi fC)$$

$$X_L \text{ (inductive reactance)} = 2\pi fL$$

(where C, L and f are in Farad, Henry and Hz respectively).

Resonance occurs at the frequency where  $X_L = X_C$ .

$$\text{Wavelength } (\lambda) = 300/\text{frequency}$$

(where wavelength is in metres and frequency in MHz – a convenient shortcut)

Velocity factor = (physical length of  $\lambda/4$  transmission line) / ( $\lambda/4$  in free space); or conversely,

$$\text{Physical length of } \lambda/4 \text{ transmission line} = (\lambda/4 \text{ in free space}) \times (\text{velocity factor}).$$

It doesn't matter if you physically measure a quarter wavelength. You can use the calculated quarter wavelength in the above formulas, but make sure measurements and calculations use the same wavelength fraction.

Tuned circuits can be connected to the Analyser but I suggest they are only connected in series, then adjust the frequency for a minimum X. The unit can be used in normal analyser function for this measurement.

## More theory

Remember, an open quarter wavelength transmission line presents a very low impedance (short) at the opposite end (series tuned circuit). A shorted quarter wavelength transmission line presents a very high impedance (open) at the opposite end (parallel tuned circuit).

As we move back from the far end of a relatively long transmission line, an open circuit line will present a short at a distance of  $\lambda/4$ , then open at  $\lambda/2$ , then short at  $3\lambda/4$  and open at  $\lambda$ , or one wavelength, and so on. The reverse is the case for a shorted transmission line. If you are constructing traps or matching networks, always make the transmission line longer and trim until you are happy with the result.

ar

## Let's understand efficiency

There are three matters to consider:

- What do we mean;
- What is the theoretical maximum; and
- Practical consideration.

### Definition

Efficiency in engineering is always measured as Power output /power input. With direct current [DC] we can separately measure voltage and current. But with alternating current [AC], we need to be clear that we are measuring the product of the in-phase components of voltage and current.

Other aspects of efficiency can also be considered, viz:

- Do we just measure the final PA?
- What overheads need to be operating for the final RF amplifier to be working, eg, oscillator, driver, modulator, monitoring and control circuits?
- Over what period of time is the amplifier to be ON compared with the total operating time?

### Theoretical maximum

In AC amplifiers, the maximum efficiency of Classes A, B and C depends on three factors:

- (a) That the active device is always run to just cut-off the plate/collector/drain;
- (b) That the output waveform is symmetrical, ie, there is no distortion; and
- (c) That the underlying waveforms are products of sine waves.

And because we are dealing with AC, the product of the voltage sine wave and the current sine wave will be a  $\sin^2$  wave.

Under these conditions, the maximum efficiency that can be obtained with both Classes B and C is  $\pi/4 = 78.5\%$ .

There is no point in disagreeing with this theoretical maximum unless you have a better theory. Data from experiments that arrive at different results have not met one or more of the three required conditions.

Classes D and E [and further] do not use the sine wave assumption – they use switching techniques and can get higher efficiencies, at the expense of more waveform distortion and, at RF, consequent splatter. Attenuating these splatter products is helped by using a single frequency and a very high Q antenna system.

### Practical considerations

If the grid/base/gate is not driven hard enough to cause plate/collector/drain cut off, efficiency falls in direct proportion to the square of  $([V_{cc}-V_b]/V_{cc})$ , where  $V_{cc}$  is the supply rail and  $V_b$  is the lowest achieved plate/collector/drain voltage.

In some cases, designers are too timid to run to maximum efficiency because the resultant plate/collector/drain dissipation will exceed the Safe Operating Area [SOA] of the active device. Designers may be timid because:

- they want their active devices to last forever, perhaps because they want a good image in the market place; or
- the cost of an outage, eg, to a broadcaster, in terms of lost advertising revenue and audience is too high; or
- the cost of retrieving the device to replace a failed active device is too high, eg, as in submarine cable amplifiers; or
- the skills to carry out repairs are not always available, as in an active battlefield; or
- the manufacturer's requirements for cooling to carry away the wasted heat cannot be met, eg, the finished product needs to be buttoned up so prying fingers cannot do damage or be damaged.

I suspect that some of these reasons may explain why Rodney Champness achieved such low efficiencies with his 33, 3A4 and 807. Unfortunately, Rodney doesn't tell us what the waveform was or how he measured it at what point in the PA circuit.

How did the 4CV100,000E get over the

theoretical maximum of 78.5%? Such a valve is typically used in broadcasting stations. While the condition for running to plate cut off can be achieved reliably, what many broadcasters do is to provide a disproportionate positive kick to the other end of the plate voltage excursion, resulting in what is called 'Carrier Shift'. Most people receiving a signal that has carrier shift cannot tell that the waveform is distorted – even less so with FM, where the waveform is less important than the timing of the zero-crossing points. To the accountant in the 100 kW broadcasting station that is on 168 hours per week, the difference in electricity cost is nearly \$6000 per annum.

My earlier comment about directly-heated valves having a higher efficiency than indirectly heated was based on normal radio operation, such as by mariners, travellers and radio amateurs, where typically we only talk for about 20% of the time, at most, and we cannot wait 30 seconds for the cathode to reach operating temperature – so, it was a time-based measure of efficiency that I was using. This kind of thinking was also used in the design of military radios, where the cost of having a PA tube on for a long time could not be borne by troops carrying batteries. In such designs, the final PA's filament was turned on and off by the PTT circuitry, and the speed of the directly-heated valve reaching full availability fitted the design bill. Having a carrier warming up gives an enemy time to find you and put a round through your spout.

Brian, VK2GCE

## Plan ahead

### WA HAMFEST 2006

### 6TH AUGUST 2006 ASHFIELD

detail

from

[vk6ne@upnaway.com](mailto:vk6ne@upnaway.com)

**The views expressed in the *Over to you* column are those of the authors, and do not necessarily reflect the official policy of the Wireless Institute of Australia.**

**Australian made**

## ANTENNAS

Setting a new standard

### COM-AN-TENA

(formerly a j and j coman)

115 John Street  
GLENROY 3046

23 cm 36 ele slot fed yagi beam	\$190
2 ele delta loop 10/11 metre	\$249
2 ele quad 10/11 metre	\$249
10/11 beams comp opt 5 ele	\$327
10/11 5/8 vert 4 rad 1/4 wave	\$185
Tri band IIB 35 C 10/15/20 m	\$745
3 ele 20 m comp opt	\$460
log periodic 9 ele 13 30 8.4 boom	\$990
MBV 6-12-15-17-20-40-80	\$390
40 m linear loaded 2 ele beam	\$595
M B Vert auto switch 10/80 m	\$330
6 m 7 ele yagi beam 60 mm boom	\$387
6 m 5 ele comptr opt beam	\$275
Top loaded 160 m vert	\$430
10 ele high gain 2 m 3.9 m boom	\$149
17 ele high gain 70 cm 3m boom	\$129
Rotable dipole 40 m	\$250
80 m top loaded vertical	\$239
dual band 2 m & 70 vert	\$140

### Guyed Masts

21 metres

13 metres

Winch-up & tilt-over. Aluminium and stainless steel  
three-sided construction. Auto-brake winches.

### Free Standing Masts

9.5 metres

### New Baluns

1-1 to 16-1 to 3kW



03 9773 3271

Mob: 0419 542 437

## Technical abstracts

Peter Gibson VK3AZL

### Drilling holes in round tube

In RadCom for November 2005, Ian White, GM3SEK, in his "In Practice" column, answers a question on how to accurately drill holes in the round tube as used for Yagi booms.

His first suggestion is to use square tubing as it is much easier. However, round booms do offer slightly lower wind resistance and may be a little cheaper.

The simplest kind of drilling jig is a channel to locate the tubing, with a guide block on top that both clamps the tube as well as locates and supports the drill bit. The whole thing can be made from wood.

Figure 1 shows the construction of the jig. A strong flat piece of wood is needed for the base plate. Two strips of planed wood are used for the two sides. The thickness should be the same as the diameter of the tubing. A substantial piece of hardwood is needed for the top guide block. The method of assembly should be self evident.

Figure 2 shows the method used to enable a number of holes to be drilled in line. In this case, a spirit level is clamped to one end of the tube and the level is

checked for horizontal before each hole is drilled in line.

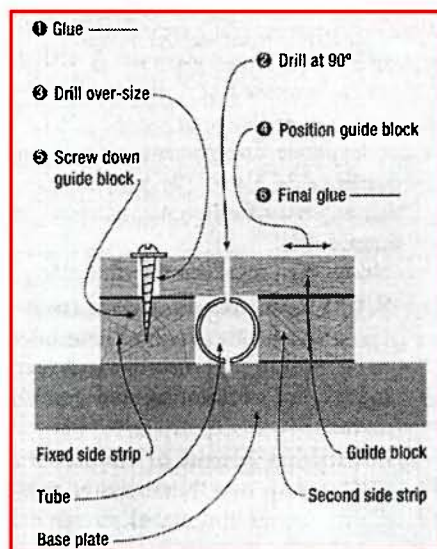

Figure 1 – Home made drilling jig for round tubing

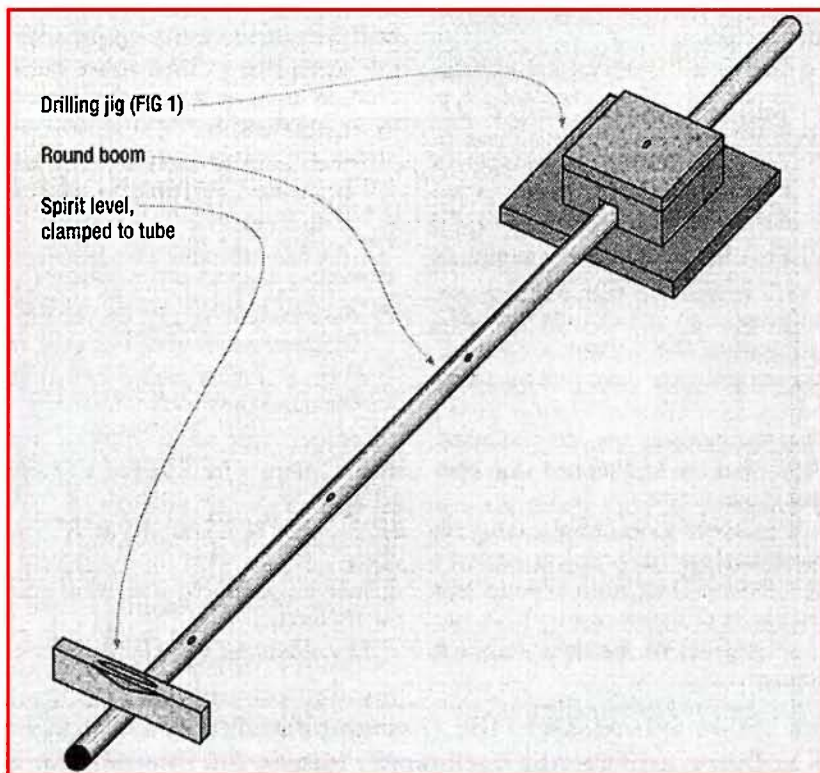

Figure 2 – Use spirit level to help drill all the holes in line

# Celebrating the Commonwealth Games on the amateur bands

Barry Robinson VK3JBR

A month-long activation of two special event callsigns issued by ACMA for the XVIII Commonwealth Games Melbourne saw them in great demand during March this year, resulting in 10,000 contacts logged.

Planning for this activity began 12 months earlier when Amateur Radio Victoria decided that it was essential to have a special event callsign for this highly significant event with 71 nations involved. Initial thoughts were for two callsigns, one for the Queen's Baton Relay and another for the Commonwealth Games itself.

The plan was to try and top the success of the AX3OLY special event callsign activated during the Olympic Torch Relay for the Sydney 2000 Olympic Games. David McAulay VK3EW, on behalf of WIA Victoria, put that station on air working 103 countries and receiving the ARRL Millennium DXCC Certificate.

However, for various reasons the dream of having AX3BATON on air for the 50 days of the relay throughout Australia was just not possible.

Plan 'B' kicked in with two callsigns allocated for 1-31 March. A roster of 17 members of Amateur Radio Victoria kept the callsign AX3GAMES on air most of the 30 days, while leading DXers, Peter Forbes VK3QI (CW) and David McAulay VK3EW (mostly phone) worked up a storm by sharing AX3MCG.

This turned out to be one of the most successful special event callsign activations in Australia for many years. Up to 160 countries were worked and a claim for a DXCC will be made.

Awareness of AX3GAMES and AX3MCG was high after they were mentioned in all top DX bulletins, ham radio news services including the RSGB, ARRL and WIA, with many radio societies, particularly in Commonwealth nations, alerting their members to the activity. A series of packet bulletins was also issued.

The callsigns were regularly spotted on DX Clusters and generated 4,000 look-ups on QRZ.COM as the world's

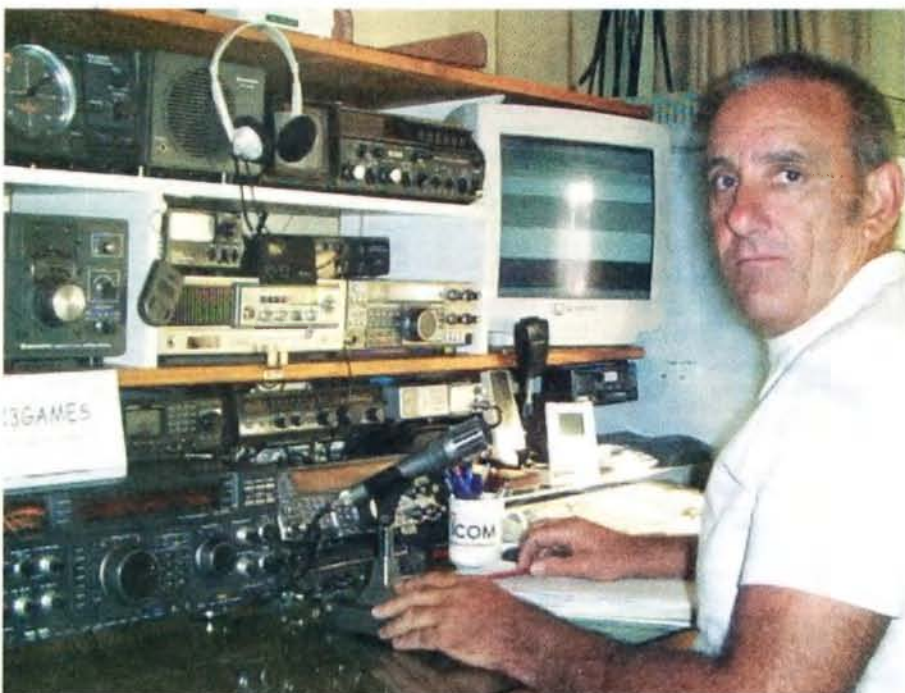

Peter VK3OJ (top) and Terry VK3UP (bottom) were amongst the team of operators who activated the AX3GAMES callsign.

radio amateurs checked out the recorded QSL details.

To help VK operators have a good opportunity of making contact with the special event stations, an alert was posted on the WIA website and mentioned on the VK1WIA broadcast. It detailed the expected times and frequencies of operation.

This worked extremely well with many expressions of appreciation being received from those who were able to use that information to score a contact.

Getting into the swing of things and working their very first special event callsign were a number of Australia's new Foundation licensees. You could hear in the tone of their voices that they were more than pleased at their achievement.

Stjepan Nikolic VK3TSN was able on one of his rostered days to operate portable at the Commonwealth tGames shooting venue in Lilydale on a competition day. Stjepan concentrated on CW on that occasion and from his home QTH.

In another portable operation, Peter Forbes VK3QI and David McAulay

VK3EW went to Arthurs Seat on the Mornington Peninsula and gave many during the John Moyle Memorial Field Day Contest a surprise contact with AX3MCG.

On a number of occasions it was possible to work both AX3GAMES and AX3MCG on the same band and time, much to the delight of many who were able to score both in their logs.

The exercise involved nearly all bands from 1.8 MHz through to 1296 MHz. Various modes were also catered for with AX3GAMES appearing on the Melbourne ATV repeater VK3RTV on a week day/night courtesy David Park VK3JDA, plus some PSK31 and plenty of CW involving a number of operators. A little activity also occurred on IRLP.

In East Gippsland, Rob Ashlin VK3EK in his two day AX3GAMES log included eight different bands. Highlights were a contact with Ron ZL4RMF on 160 m, Chris Davis VK2DO mobile on 2 m using aircraft enhancement propagation, and tropospheric propagation across Bass

Strait with Joe Gelston VK7JG on both 2 m and 70 cm.

With each operator having at least an entire day it was possible for them to find a band that gave them contacts. At times when propagation was good, there were many chasing the special event stations. On one occasion, Gwen Tilson VK3DYL faced a dogpile into Europe on 20 m long-path.

Commemorative QSL cards are now being designed for both AX3GAMES and AX3MCG using Commonwealth Games images. At least two different cards for each of the callsigns are likely.

We now look forward to the prospect of another special event station on air in four years time to mark the 19th Commonwealth Games to be held in Delhi, India in 2010.

Amateur Radio Victoria thanks its members who volunteered to activate the callsigns and sincerely acknowledges the assistance from ACMA in issuing the two commemorative callsigns.

ar

# Australian Radio Industries Pty Ltd

Service to Industry, Commercial, Amateur & CB Radio Applications

## SPECIALISTS

- Rg Series Coax
- Ultraflexible Coax
- Helix Corrugated Hardlines
- Waveguides & Semi-rigid
- Hi-temp Teflon Coax
- 450 & 300 Ohm Twinfeeders
- Multi-core Control Cables
- All Coax / Hardline Connectors
- All Coaxial Adaptors
- Hard & Soft Drawn, Copper Wires

- Enamelled Copper Wires
- Coax Sealing Products
- Installation Accessories & Equipment
- Ceramic And Pvc Insulators
- Flat Earth Braids
- Dacron Uv Ropes
- Mobile & Fixed Antennas - Cb & Amateur
- Dipole & Wire Antennas
- Lightning Protection & Earthing
- Cable Assemblies



Prices inclusive of G.S.T.

The RF Specialists

ABN 67 117 379 218

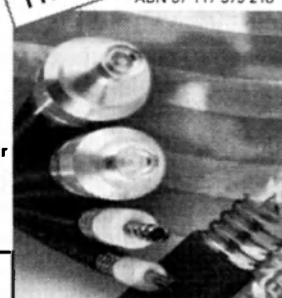

SUPPLIERS, IMPORTERS, & MANUFACTURERS

PAY BY - MASTERCARD, VISA, BANKCARD

Disclaimer: Prices subject to change without notice.

Prices inclusive of G.S.T.

*Make us your last call, as we will be your first choice on Quality, Service, Technical advice and the best possible price!*

### ARI QUALITY CABLES & PRODUCTS

- RG-213 MIL-C-17D - \$160.00 per 100m
- RG-58CU MIL-C-17D - \$50.00 per 100m
- TIMES LMR400 - \$4.20/m
- TIMES LMR600 - \$8.95/m
- 1/2 inch HELIAX - \$4.95/m
- 7/8 inch HELIAX - \$9.95/m
- 300 ohm Ladderline - \$1.20/m
- 450 ohm Ladderline from - \$2.00/m
- 1.6mm HD Copper wire - \$30.00/Kg
- 3mm Dacron UV/Rol proof rope - \$1/m
- 5mm Dacron UV/Rol proof rope - \$1.50/m
- Hi quality Patch Leads from - \$4
- 20m x RG213 terminated - \$55
- 50m x RG213 terminated - \$120
- 20m x LMR400 terminated - \$129
- Scotch 23 Self Amalgamating tape - \$20/roll
- Hi Power Antenna Baluns from - \$50
- 477Mhz 12dB Fiberglass Vertical - \$245

### MFJ OVER SHIPMENT CLEARANCE

- MFJ-986 1.5Kw Roller - \$510
- MFJ-982D 800W Roller - \$399
- MFJ-969 300W Deluxe - \$299
- MFJ-949E 300W Tapped - \$269
- MFJ-945E 300W HF+6 mobile - \$180
- MFJ-941E 300W Versa Tuner - \$199
- MFJ-902 150W Travel Tuner - \$125
- MFJ-904H Deluxe Travel Tuner - \$240
- MFJ-994B 600W Auto/Remote Tuner - \$549
- MFJ-974B HF+6M Balanced line Tuner - \$299
- MFJ-974HB 300W Balanced line tuner - \$345
- MFJ-264 1.5Kw HF/VHF/UHF Dummy - \$125
- MFJ-267 HF+6 Deluxe Dummy - \$245
- MFJ-269PRO Extended UHF Analyser - \$679
- MFJ-4225MV 25A Power Supply - \$245
- MFJ-4245 45A Power Supply - \$329
- MFJ-1910 33F1 telescopic mast - \$149
- MFJ-702B 200W Low pass filter - \$69
- MFJ-1706 Balanced line antenna switch - \$185.00

AVAILABLE AT THESE PRICES ONLY WHILE STOCKS LAST

### HEIL MICROPHONES & ACCESSORIES

- PROSET HC4 / HCS - \$269
- PROSET IC - \$279
- PROSET PLUS - \$369
- GOLDLINE GM4 & GM5 - \$269
- HM10 DUAL - \$249
- HM10/5 - \$169
- HM10/4 - \$169
- FS2 PTT FOOTSWITCH - \$85
- HS2 PTT HANDSWITCH - \$65
- TRAVELLER HEADSETS - \$169

### AMERITRON LINEARS & RCS UNITS

- AL-811AX 600W - \$1629
- AL-811HX 800W - \$1999
- RCS4 4 Position Remote switch - \$249
- RCS-8VX 5 Position Remote switch - \$299
- RCS-10VX 8 Position Remote switch - \$329

### ALPHA DELTA Coax Switches

- AD2 2 Position with protection - \$119
  - AD4 4 Position with protection - \$169
- Available with N Type as well!

Trading Hrs: Mon - Fri 8am - 530pm, Sat - 8am - 12 noon

Office: (02) 4862 2110 BH

FAX (02) 4869 4424

EMAIL: sales@arindustries.com.au

WEBSITE: www.arindustries.com.au



# How I solved mobile station installation problems of my own making!

Neville Chivers VK2YO

**How did the problems come about? Well, the first problem came about when I decided that my present vehicle, like myself, was becoming a bit elderly. It was time to trade it in on a new car. But which brand?**

After doing the rounds of the dealers, and reading the literature supplied, I decided to buy a VW Golf 2 L diesel.

A test vehicle was delivered to my home QTH for a radio compatibility test. This mystified the salesman who decided to humour me. After all, a potential sale was at stake, along with his commission.

I backed up my present vehicle with HF helical attached, placed the trusty TS-680S on the front seat of the Golf, connected it to the Golf's 12 V battery and with coax cable back to the HF whip at the rear of my present vehicle, and called CQ on 40 m. More mystified looks from the salesman as he consulted his watch at odd intervals.

I explained that I needed a car with electronics that would not unduly interfere with reception and, if the test vehicle passed the test, I would order one, subject to his trade-in offer on my present vehicle which, incidentally, was a 1989 Nissan Skyline with very little interference evident on receive.

He need not have worried. The VW Golf was very quiet on receive with the motor running, the lights full on and the hazard blinkers and wipers going all at once. An order and a handshake restored his happy countenance. What about the trade-in? Yes, he agreed to what I was asking for there, too.

The car type problem was now solved. However, it was obvious there was not enough room to fit into the new vehicle the TS-680S and a separate 2 m transceiver, as there was in the old car.

Well, there was only one decision to make. Buy a new transceiver, one of those miniature marvels that cover from 'DC to daylight' in the one package, smaller than my present IC-290 2 m rig, but about the same price I paid for the Kenwood TS-680S 16 years ago!

Please don't think that I bought a



Photo 1 – FT-857D in homemade mounting bracket

new car as an excuse to buy a new transceiver. Perish the thought. It was purely circumstances!

So, which one? It came down to Icom or Yaesu, as Kenwood did not have one in this size range. After considering the IC-706MKIIG and the Yaesu FT-857D literature supplied by dealers advertising in AR, I decided on Yaesu mainly because I have had good, trouble free use from Yaesu gear over the years, right back to my first commercial HF rig, the FT-200.

The FT-857D duly arrived, along with its 128 page operating manual. A sharp learning curve here!

As the car delivery was at least three months after ordering, I had time enough to familiarise myself with the new rig in the shack. And what a 'little beauty' it is! For further details I refer you to the

excellent review of the FT-857D in the July 2005 issue of Amateur Radio.

In due course the VW Golf was delivered to the dealership where money changed hands and I drove it home. Habit being what it is, I indicated a turn right or left signal a few times by turning on the wipers. Being a European designed car, the indicator switch is on the opposite side of the steering column to what I am used to.

Back home I was confronted with another 100 page book on what was essential to operate the new vehicle. An even steeper learning curve was required as I had to explain all this to my co-driver wife (which I didn't have to do with the FT-857D transceiver).

Now that the two items of interest were at last at the home QTH, the next problems



Photo 2 – VHF/UHF 2 m and 70 cm J pole antenna.

inside of the console but with good clearance from the movable automatic T-bar. A small link-swaged chain passes from one side of the bracket underneath through the hand hold cut-out in the centre console and attaches to the other side of the bracket by a small padlock over the bail rest to secure the radio from opportunistic theft.

The FT-857D snug in its mount, the next problem was how to power it. It is recommended to have a dedicated pair of cables run right back to the battery terminals. That's all very well in theory. But car makers don't seem to factor the needs of radio amateurs into body design. At least VW didn't, as the motor compartment is so full right up the firewall that I could not find any grommets holes, or a place where I could drill through the firewall without drilling into something!

Normally a 'no no', the only alternative was to use the 12 V accessory socket located in the console under the dash. There is also another 12 V socket in the boot. The handbook describes their use as for charging mobile phones, laptops and a car 'fridge', so it looked like they are meant to carry a fair current.

I traced the connections of these 12 V sockets to the fuse box and found thick cable terminated in a 30 amp fuse, and heavy duty cable down to the battery adjacent to the fuse box and firewall. The distance from the battery to the fuse box to the 12 V socket inside the cabin was about half a metre. I figured that the line voltage drop should not be much and, in use, it came down to 0.3 V between receive and transmit at 100 W output from the transceiver on HF.

On to the next problem. What to do for mobile aerials? For many years I had used a home-made HF helical whip tapped for multi-band operation, along with a spring mobile mount which was offset to the left of the tow bar on a plate fixed to the tow bar by the tow ball. This allowed a

trailer to be towed without removing the spring mount.

So, this is what I used on the VW Golf. The coax runs along the cabin floor underneath the carpet between the seats and out the hatchback door. This solved the HF mobile antenna problem. Now, what about 2 m and/or 70 cm repeater operation?

On my former vehicle, for 2 m operation I had a quarter wavelength vertical on a magnetic base in the centre of the roof with the coax across the roof, through the back door and across loose to the 2 m rig. Not the ideal installation when carrying passengers! Besides, the trailing coax tended to mark the roof over a period of use.

So, I figured that, ideally, it would be nice to be able to remove the HF whip and replace it with a 2 m antenna when needed. It would use the same coax as the HF antenna so I would need to remember to change the coax from the HF socket on the FT-857D to the separate VHF/UHF socket.

But, what type of aerial to use?

After practical considerations, I

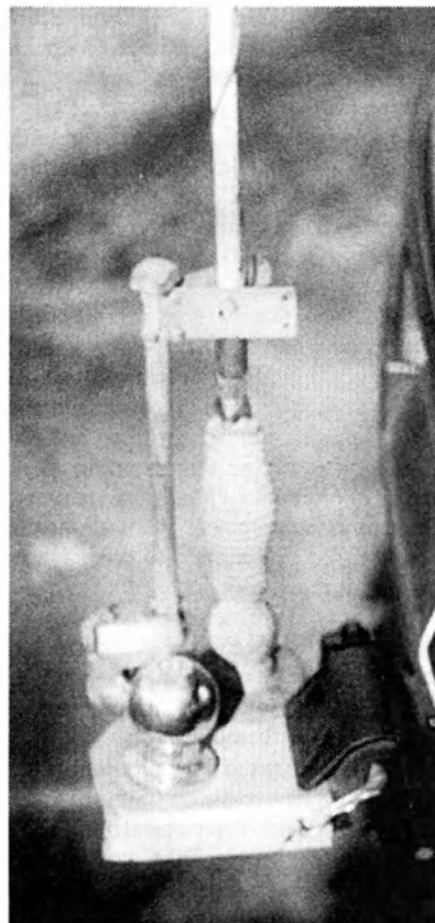
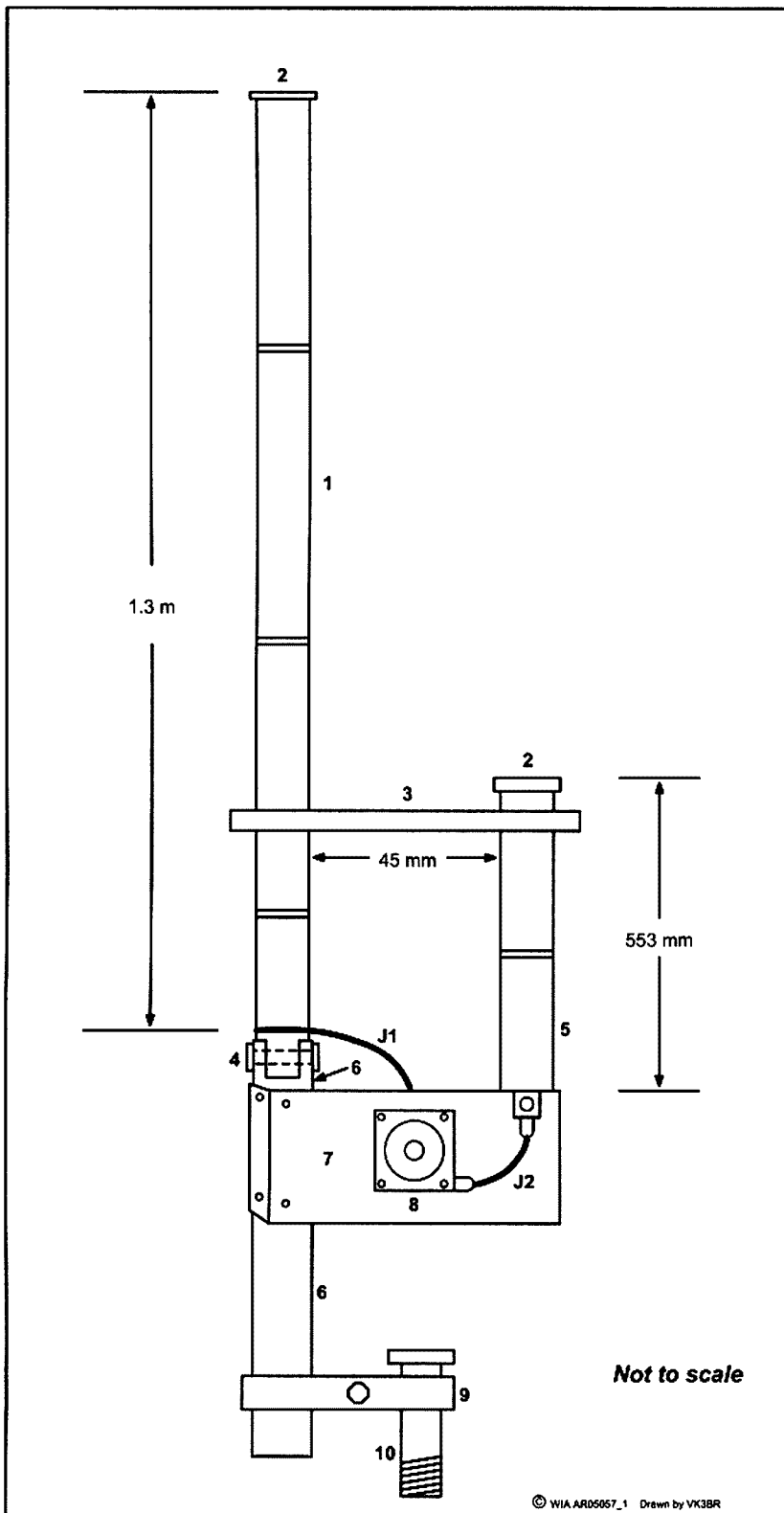

Photo 3 – HF whip with mobile mount and back stay.

to solve were how to conveniently locate the radio in the car, and to power it.

The FT-875D has a separation kit available which allows you to place the body of the radio almost anywhere in the vehicle and just have the front panel up on the dash of the car. In fact, my friend Paul VK2EX has done just that. However, as I only want to use the radio on long trips, I wanted easy but secure installation and removal. The FT-857D spends most of its time on the bench tuned to the 6 m band where its 100 W transmitter is useful, and the old faithful TS-680S is then used exclusively on HF.

The most convenient spot to mount the radio in the Golf is vertically on the passenger's side of the centre console by suspending the rig from its elevating bail rest. So, off to the metal recyclers for a rummage through their off-cuts bin. I was in luck. I found a piece of 8 mm deep aluminium U channel and a piece of 250 x 250 mm right angle extrusion which, when bolted together, forms a bracket. The bail rest of the radio slides into the U channel on top of the console, the right angle vertical face down the



when telescoped, 0.8 m. The dimensions are relevant to my installation and should only be taken as a guide, if duplicating. For me these dimensions give full power out from the Tx at 50 W in to the J-pole fed with 50 ohm coax with negligible VSWR at 146.400 MHz.

This 2 m J-pole performed very well on a recent trip to Sydney. From Kingscliff, near the Queensland border, and down the Pacific Highway I accessed every repeater area I passed through and it physically stood up to prolonged air pressure at highway speeds.

Stationary at Gladesville, Sydney, I accessed several repeaters on both 2 m and 70 cm. Yes, the J-pole works quite well on 438 MHz.

But you really want to know how the 2 L diesel VW Golf went, don't you? How about 830 km in 10 hours road time, fully loaded and using only 49 L of fuel. Not bad, eh?

## Diagram legend

1. Driven element, made from two TV telescopic rabbit ears soldered together and extended to 1.3 m for operation in the centre of the 2 m FM band, ie 146.400 MHz transmit and 147.000 MHz receive.
2. Top caps.
3. Two plastic separators placed each side of 1 and 5 and bolted together to maintain separation at 45 mm.
4. Bolt locating existing tongue at the bottom of 1 in tight fitting groove cut unto the top of 6.
5. Quarter wavelength stub extending to 553 mm and tongue checked into 7. In use, the stub should be closest to the car boot.
6. Piece of insulating workable material, ie wooden dowel or fibreglass rod, etc.
7. Thick aluminium plate bolted to 6.
8. Coax socket.
9. Single bolt parallel groove clamp. If difficult to source, try your local electricity supply depot as they are used on power lines.
10. Threaded but screwed into mobile spring mount.
- J1. Wire jumper from centre pin of 8 soldered to the bottom of 1 just above the top of 6.
- J2. Wire jumper between soldering lugs under bolts of 5 and 8.

ar

decided on the J-pole as the most likely candidate. The VHF aerial had to be quickly interchangeable with the HF helical whip. As it would be about 1.3 m long for the driven element and a bit over 0.5 m for the parallel stub, the elements should be telescopic for storing in the

back of the car when not in use.

I made the J-pole out of two sets of telescopic TV rabbit ear aerals which retail at under \$5.00. I disassembled and reconstructed them as shown in the accompanying diagram. The overall length when fully extended is 1.6 m and,



# Antenna Tuner Special



## We Have Australia's Best Range in Antenna Tuners

### LDG Electronics

#### AT200pro Auto Tuner + Switch



160 through 6 meters, 5 to 250 watts, 16000 3D memories, 2 position antenna switch, power and VSWR LED bargraph.

#### AT100pro Auto Tuner + Switch

160 through 6 meters, 1 to 125 watts, 4200 memories, 2 position antenna switch, power and VSWR LED bargraph.



#### Z11pro Auto Tuner



160 through 6 meters, 0.1 to 125 watts, 8000 3D memories, LED display for VSWR and status and User installable battery holder (not supplied).

#### Z100 Auto Tuner

160 through 6 meters, 0.1 to 125 watts, 200 memories, LED indicators for VSWR and status.



#### AT1000 High Power Auto Tuner

160 through 6 meters, 20 to 1000 watts, 200 memories, cross needle power/VSWR meter, protection against high power tuning.



#### AT897 Auto Tuner



160 through 6 meters, 0.1 to 100 watts, 200 memories, mounts right on the side of the Yaesu FT-897

### SGC

#### SGC 235 High Power Auto Tuner

160 through 10 meters, 3 to 500 watts, 170 memories, waterproof ABS enclosure.



#### SGC 230 Auto Tuner

160 through 10 meters, 3 to 200 watts, 170 memories, waterproof ABS enclosure.



#### SGC 237 Auto Tuner

160 through 5 meters, 3 to 100 watts, 170 memories, waterproof ABS plastic covers on an anodised aluminium base.



#### SGC 239 Auto Tuner

160 through 10 meters, 3 to 200 watts, 170 memories, aluminium case with exposed PCB\*

#### MAC 200. Auto Tuner plus Switch

160 through 5 meters, 1.5 to 200 watts, 168 memories, 5 position antenna switch (3 coaxial, 1 end fed, 1 balanced), VSWR/Power meters, extruded aluminium case.



### Ten Tec

#### Model 238B High Power Manual Tuner plus Switch



160 through 10 meters, 2000 watts, wide matching range, internal VSWR/Power meter.

### Tuner Accessories

LDG RBA-1:1 200W 1:1 BALUN

LDG RBA-4:1 200W 4:1 BALUN

TTS CUSTOM HIGH POWER BALUN

TTS PATCH CABLES

WM1 VSWR/POWER METER



# TTS Systems Communications Equipment

[www.ttssystems.com.au](http://www.ttssystems.com.au)

**FREE CATALOGUE**

## HF and VHF Transceivers, Autotuners and Kits

Phone 03 5977 4808. Fax 03 5977 4801 [info@ttssystems.com.au](mailto:info@ttssystems.com.au)

# Redcliffe's big day out at the John Moyle Contest

Compiled by Peter Richardson (VK4TAA), with contributions by Peter (VK4TGV) and James (VK4TJF)

The John Moyle Memorial Field Day is a big event in the Redcliffe Radio Club's calendar, with planning starting immediately after the previous year's contest.

Redcliffe is roughly 20km north of Brisbane. Every year we try to think of ways to make the next year's event better. From last year's experience, we liked the location (a nearby scout camp, Murrenbong), and that we had our radio combinations, antennas and the power supply arrangements pretty right.

We had also previously learned that we needed HF filters for each band, help with calling CQ for long periods of time, easier setup and increased manning of the bands to maximise our opportunities for contacts; and we liked the idea of spotting ourselves on "clusters" to improve our contacts.

As with previous years, Andy VK4KY was the project leader for this year's John Moyle, ably assisted by Noel VK4HR, Peter VK4TGV and Glenn VK4FZ. We used our newly purchased HF filters, which worked superbly, by filtering out splatter from other bands. This allowed us to operate from just 2 tents for the 5 bands.

The weekend was supported by WiFi Laptop Interface which worked well, and



Redcliffe setting up at Murrenbong

lastly, the biggest thing that worked as planned was the voice recorders which Andy built for each station. These took the voice stress of long sessions "calling CQ" out of the weekend.

This year we were again generously supported by a local equipment hire firm (Coates Hire), to which our club is deeply grateful, with the provision of a 20 kVA generator and toilet.

Lots of preparation work occurred prior to the start, with the main staging point being at Andy's residence. People and material started assembling at the Murrenbong camp site from 10 am Friday morning and then the setting up for the contest began in earnest. We ran a 4 element mono band



(L-R) Dave VK4ZMG and Charlie VK4YZ

[www.pca.cc](http://www.pca.cc)  
Email from anywhere  
via **Winlink**  
2000  
Use **PACTOR-3**  
on HF to send  
Mail, Grib Weather,  
Weatherfax & Images  
Contact [marc@pca.cc](mailto:marc@pca.cc)  
Sydney 02 8902 0107

# Redcliffe's big day out continued

Yagi on 20 metres, a 3 element mono band Yagi on 15 metres and 10 metres. 40 and 80 metres were supported by 2 element wire Yagis that were switchable in reverse and at 90 degrees.

This year members George VK4XY & Bevan VK4BCM, ran a small CW setup, entered separately and gave members an insight into the world of CW. (The club only entered in the phone HF part.)

The weekend was a huge success. Over 30 club members attended during the contest. We made over 700 contacts on all the bands, a little down on expectations, due to the unhelpful propagation situation. It can be said with confidence that "if the contact was possible, it was worked!" A couple of our new Foundation licence operators excelled on the weekend and were hard at it working different bands

## Antenna set up

Peter VK4TGV continues with a description of the 40/80 metre beam antenna setup, which was designed and modelled by Andy.

Noel (VK4HR) and myself went 'fishing in the bush'. Noel was obviously experienced with erecting wire antennas at field days. His equipment is very simple, a surf rod with Alvey reel, fitted with heavy line and a large sinker.

The objective was to string 8 pieces of wire, 4 for the 40, and 4 for the 80 m wire beams. To get the wires to height, trees were selected, with consideration given to wire orientation and spacing.

It was quite incongruous to hear the Alvey go off in the middle of the bush and brought back memories of chasing tailor on Fraser Is. With the heavy sinker having made it over the target limb, gravity brought it back to earth. a heavier line was attached and drawn back from a hand reel over the limb. Poly-filament washing line was attached to this and drawn back over the limb using the hand-reel.

Attached to each piece of poly-filament, the dipoles were hauled up to height. Each dipole was connected to the magic switch box via a calibrated length of RG58. The length of the feedline, in conjunction with the tuning stub governed the length of each element, thereby the directivity of the wire beam. A MFJ-269 analyser was used to check the impedance at the target frequency, and also to check that the

switch box worked as expected.

The 40 m beam took about 3-4 hours to get up, which occupied most of Friday afternoon. Once up it did not take long for Andy to be set up and operating on 40.

The directivity of the beam was astonishing. By flicking a couple of switches we were able to work Europe long and short path, then swing the beam 90 degrees towards the US, again both long and short path. You couldn't wipe the smile off Andy's face, the model worked, and worked very well. The 40m array gave the club the most number of points over the 24 hours.

The 80m array was erected some distance away, considering it has to be twice as big as the 40 m array. Saturday morning Noel and I again traipsed into the bush to do some more "tree fishing".

I think I walked the 80 m dipole length 50 or so times trying to get this array high enough. After 4 hours we had the poly-filament up and ready to haul the dipoles up. But first we had to make them!

Andy's ingenuity comes to the fore with a couple of neat gadgets to manufacture the dipoles. 4 x baluns fabricated with blank PCB material, a toroid and SO-239 socket, plus some simple strain reliefs and a quantity of building wire saw us have 4 x 80 dipoles made up in an hour.

With the 4 x RG58 feedlines cut and terminated we were ready to haul this big sucker up. After some more testing and trimming Andy fired up the amplifier and Icom IC-746Pro2. The model suggested

excellent directivity as per the 40m array, but it needed to be higher to meet the model's predictions, but it worked well. Once the contest started the points began to accumulate, while we worked most of the evening into Europe and the US.

## How it all felt

Some words from James (VK4TJF).

"I like the 20 metre band because I think of it as the ham radio operator's all season, versatile DX band. Even during the current bottom of the 11 year solar cycle one can still manage to squeeze in a few hours of good DX work.

I find that the 20 metre band is also very quiet compared to other bands. 20 metres is very popular among the international amateur radio community. On my 20 metre dipole I was working many stations in Europe from Brisbane, from around 1600 to 2100 and then again at 2230 to around 0100 in the morning.

The W6EL propagation program is useful. The best way to check the band conditions is to go on air and listen. During the John Moyle Memorial Field Day contest I operated on 20 metres using a beam pointed towards Europe.

Luckily the Russian DX contest operated during the same weekend. Normally the thing to do is to call CQ on one frequency. But just by moving up and down the band I was able to contact stations calling CQ for the Russian contest. The beam and the 400 watts helped to bust through any pile-ups."



John VK4WX operating for the Redcliffe club

## John Moyle Memorial Field Day Contest

AS our members are Australia-wide, ALARA does not compete in this Contest as a club but some of us do take part. The ALARA members of AHARS were a significant proportion of the voices heard on VK5BAR, the club station.

This year three YLs picked up a microphone (my efforts did not result in any contacts, unfortunately). Tina and Leslie worked as a team over the 24 hours. Lisa, a visitor, was indoctrinated into all the activities and even made a complete contact on her own, a step towards a Foundation licence perhaps? The weather was kind, a good time was had by all and lots of contacts were made.

## Foundation Licensees.

The two daughters of Jenny Z, who often appears in these notes, have their F licences. There are several YLs with F licences in the Mount Gambier area, one being Paula with 5FOXX, and some in the North Eastern suburbs of Adelaide.

Norma's daughters are now Lorraine VK2FICQ, Michelle VK2FMYL, and Christine VK2FIZI. This makes five hams in the one house!! There are three or so associated with the Mildura Club, (I heard that on the Monday Night Net). I am sure there are many more in the other states but if they don't tell me I can't tell you.

Congratulations all, especially the YLs.

## The CLARA and WARO Contests

Conditions defeated most of us this year for these two contests. The CLARA Contest was over the same weekend as the John Moyle Memorial Field Day. I know all the YLs up there tried very hard to make contacts but didn't even hear a Canadian station.

There were a few more successes for the WARO Contest on 1st and 2nd April and at least three stations contacted the Special ZL6YL for extra points, but mostly we were disappointed. And shamefully, a few of us forgot the date.

One YL who wasn't completely disappointed was Pat VK3OZ. After trying to get through on SSB, Pat switched



Leslie recording and Tina's turn on microphone at JMMFD

to CW (her favourite mode) and managed a good contact with her sponsored YL, Sharon, ZL3AE. Pat and Sharon met on CW and have been sponsors to each other ever since. To make a Contest contact was especially satisfactory.

## The Wyong Field Day

You saw the pictures last month, now hear what really happened. The ALARA table was in front of the bar (closed). Whenever anyone cheekily asked what the girls were offering, they were given all the ALARA advertising literature and all the information about the Foundation Licence. That will teach them to be cheeky!

The day was a great success, including the Crafty Ladies Show. A lass who has a craft/material shop in Wollongong ran some craft classes. These were a roaring success by all accounts. The OMs who didn't tell their XYL about the craft classes will have to make sure they do next year or suffer the consequences.

Dot had many YL visitors, including Rosa VK2HOP, Kirsty VK2HKJ, Beryl VK2BBM, Karen VK2AKB and Sue VK2FDAY.

Dot also had a long IRLP contact with

Iris G0FIW recently. They used to hear each other frequently, so Dot can say she sounds just the same and sends her greetings to everyone. Listen out for her. You may hear her, too.

## Looking ahead

ALARA will have a new committee after the AGM. Remember you can contact any committee member with any problems, or any matters you would like the committee to consider.

Warm up for the end of August ALARA Contest by participating in the RD Contest in the middle of August. That way your gear has had a trial run first: hi! hi!

Something to look forward to if you are travelling through the Red Centre for Heritage Week in the Alice: the Morsecodians will be there. I expect they will be sending messages by code to the local mobile telephones where the messages will appear as SMS messages.

A clever idea and one guaranteed to "get every one in".

I am sure if there is a speed competition, the Morsecodians will win, too. They are amazing to watch and to hear.

# Silent Keys

## John Edward Baylis VK2JB

John's key fell silent on Tuesday morning 21st March 2006 at home in Lake Cathie. He was aged 86. John had a long and fruitful life. Born in the UK in 1919, he saw distinguished military service as a young adult in the 1st British Commando Unit both in Burma and India. John was awarded the Military Cross and was mentioned in dispatches, something he never spoke about. During the Second World War he met Joan his first wife and was married. They were together for 32 years until her tragic death. John later met Mary an Australian Nurse studying in the UK, and was again married for 32 years. John is survived by Mary and his 10 children from two marriages.

John's Army service gave him the confidence and the ability to succeed in business over many years both in the UK and Australia.

John had many interests in life and soccer and Amateur radio were just two, his favourite team was "South Hampton" and he was affectionately dubbed the original Soccer Hooligan by his friends. Amateur radio was also high on his list. John's UK callsign was G3UXX. He described his station to me in the New Forest and told me what he had achieved

on VHF and UHF with many DX contacts. On one occasion John was able to talk to astronauts in space. John was also active on HF and boasted about his antennas and copper mine, as he called it. His station was the envy of his fellow amateurs.

When John came to Australia he stayed active on radio and physically, and ran the city to surf in Sydney with some of his children, even after heart bypass surgery. John spent many of his later years in Lake Cathie, south of Port Macquarie. John was a valued member of the Oxley Region Amateur Club. His last outing with the Club was with the John Moyle Field Day on North Brother Mountain just three days before his passing.

John was a valued friend and we met on air as most of us do. I actually met John when I told him that I was making apple pie, his favourite and he had to come and sample it. John became a frequent visitor to our home and always called in on Saturday mornings for coffee and a yarn. We talked about all sorts of things. I never tired of his morning call on 2 metres to tell me the weather, and where the sun was on the tree outside his window. John had a generous nature and he gave back to life and the hobby when he could in return for

the pleasure it had given him. I felt privileged, and was one of the few to have seen this side of John.

John's health in later years declined but his zest for life continued and saw him take on some daunting challenges late in life when most would have given up.

John was very proud that his son Sam took up the Foundation Licence some weeks before he passed on, as it was always his greatest wish that one of his children would be interested enough to take up the hobby. Sam's callsign is VK2FSLB.

John's funeral was at the Port Macquarie Crematorium and was well represented by family and friends as well as the representation from the Armed Services and Amateur Radio colleagues.

John will be sadly missed by his family and valued friends.

VALE John VK2JB.

John Marriott VK2CIF



## Alan Maxwell James (McCaskill) VK4SKL/p

Alan was born in Carlton, Melbourne on 24th May 1938 to Stanley and Hilda James. After WW2 Alan's parents separated and Hilda, Alan and Alan's sister Irene moved to Tasmania. Hilda remarried and remains happily married to Bruce McCaskill. Alan was extremely fond of his stepfather and was proud to carry his stepfather's name throughout his adult and professional life.

Alan grew up and attended school in Burnie, Tasmania. On leaving school, Alan had various jobs working for the PMG and the Tasmanian railways.

In 1957, Alan met and married his only wife Jean. Together they had 3 children; Wendy, Vicki and Darren. Their marriage lasted 12 years. After the breakdown of his marriage Alan met Colleen Crout when he was working as a taxi driver. Alan moved in with Colleen and her 2 children Tania and Clint and they remained together as a family until 1978.

Between 1973 and 1978 Alan owned and operated A McCaskill Car and Caravan Transport. His first truck was a 1967 International Harvester tray back which he configured to carry 3 cars or 5 caravans with 1 caravan in tow.

Later, while working for Stowe transport, Alan bought, restored and converted a 15 year old school bus into a self contained camper van.

Alan finally left Ballarat in 1985 and began a 21 year journey of travelling and working along the east coast of Australia.

Alan's second love after his family was of course amateur radio. No matter what time of day or night Alan would be there on frequency to have a chat to anyone who would call him as well as helping out with the running of some radio nets.

In 1999 Alan was awarded the National Service Medal 1951-1972.

Alan served in the National Service

from 1956 to 1957 full time and remained enlisted part time until 1960.

Alan was diagnosed with cancer in December 2005 and passed away in Numurkah Hospital at 2.30 am, Monday 27th February 2006.

Alan is survived by his mother Hilda, stepfather Bruce, sister Irene, half brothers Edwin, Clifford, David and Kevin and his half sister Jennifer, his children Wendy, Vicki and Darren and his foster children Tania and Clint.

Vale Alan McCaskill VK4SKL/p, A NEW JOURNEY BEGINS.

Submitted on behalf of Alan's family by Warren Fritz VK4FJ





# Getting into (new) gear for the John Moyle Memorial Field Day

Some years ago members of the EMDRC decided it was about time to retire the old contest Yagis and build some stacked arrays on VHF/UHF.

Early in 2006 Jack VK3WWW put together two antennas and tested them in the VHF Summer Field Day. Both prototypes performed well and between January and March Jack along with Max VK3WT commenced a very involved antenna construction project. Guidelines for the system were: A pair of antennas for each mode on 2 m and 70 cm. Single coax run with masthead switching, 2 m and 70 cm to be on separate rotators.

The whole set up was to be easily transportable and assembled.

With the JMMFD rapidly approaching Max and Jack devoted most of their spare time to achieving the goal. With very little time left, Jack was able to tune up the last set of antennas and finish off the masthead relay box.

With assistance from Lionel VK3NM he was also able to test the 70 cm array and noticed that a previous SWR of 1.1-1 had risen quite considerably when the individual antennas were assembled as an array. This meant they needed to be re-tuned, this was not a real problem and only took a short time.

Friday 17th was departure day and team members departed for the contest site:

Mount Buangor QF12oq located about 50 km west of Ballarat. VK3WWW arrived around 16:30 just after Victor VK3CKD and Wally VK3WDC. We erected the contest tent and managed to get on air using a VHF/UHF vertical and HF dipole. It was an early night and plenty of rest before having to assemble the station.

Saturday 18th the antennas went together well but I was concerned that we had not tested the 2 m antennas in the array configuration. This was not easy as the SWR on the FM pair was through the roof. With some fiddling we managed to get the SWR down to a reasonable 1.05:1 and got them up into the air. 70 cm went up easily but 2 m was a little trickier, as I had bought a long pole to go from the rotator to the first antenna. This pole was made from aluminium scaffolding and not easy to cut, so down came the 70 cm antenna and we cut the pipe on that one in half. Once both antennas were up in the air again Victor and Wally concentrated on 6m while I assembled the shack.

Upon connecting the antennas, I was not really impressed with the performance of the antennas for each time I peaked the Melbourne 2 m CW beacon and came out to see where the antennas were pointing they were nowhere near where they should be, it took me about one hour of working stations to realize that the 2

rotators were swapped around.

Once that was sorted out we were able to concentrate on contesting. Our troubles were not over, as about 1 km away is Lookout Hill: this is the transmitting site for Ballarat TV and the front end of the IC-271 was taking a real hammering. Most of the time it was strength 5 but quite often it would hit +60 dB making it impossible to work anyone.

We persevered with the interference and worked into the night. As there were only 3 of us, VK3WWW spent most of the time on 2 m and 70 cm and VK3CKD on 6 m and HF. By early Sunday morning, VK3WWW was pretty worn out and there were no complaints when shortly after the 09:00 re-work block change, he started to dismantle the station.

The antennas did perform OK but there is a lot of room for improvement especially with matching and assembly. Over winter, with the help of VK3WT, we will rework the arrays and be ready for the VHF/UHF Spring Field Day.

Our log was way down on last year but one bonus was the use of the VK3AVV logging software. By using this to log the score most of the calculation was already done. It is the easiest JMMFD log I have transposed yet. Photos were by VK3CKD and VK3WWW.

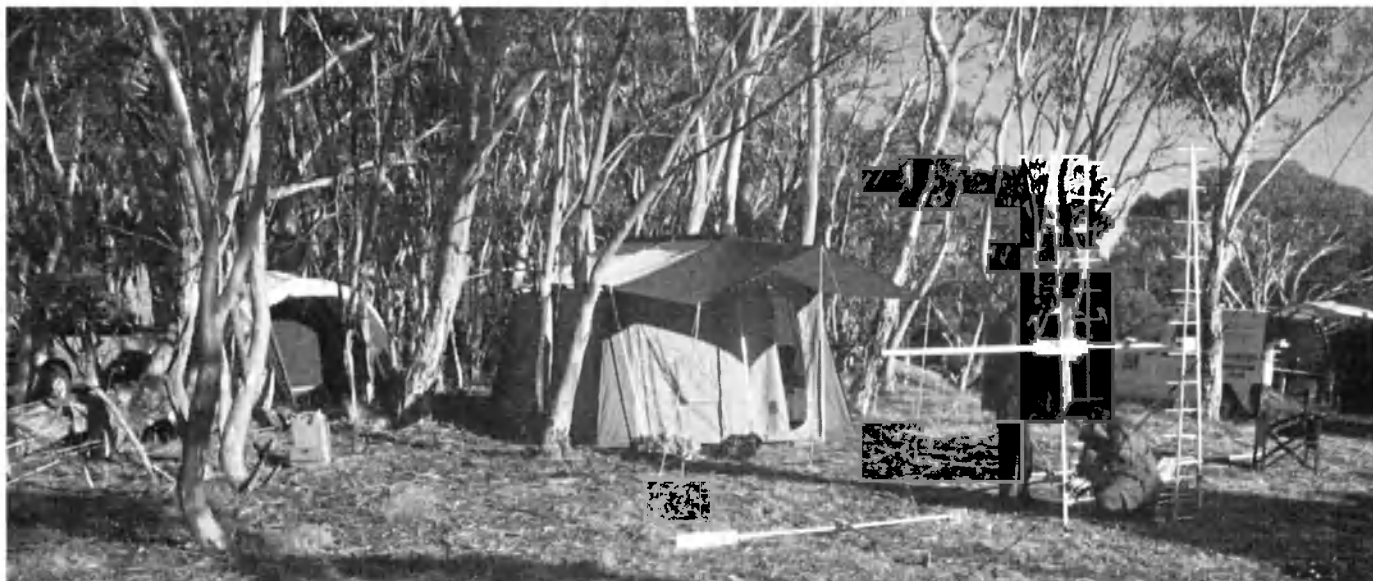

Assembling the 2 m & 70 m antenna arrays

# John Moyle Memorial Field Day EMDRC continued



A home among the gum trees.

Eastern and Mountain Districts Amateur Radio Club's VHF/UHF tent and antennae working the John Moyle Field Day.

EMDRC operated from Mount Buangor, about 50km west of Ballarat.



EMDRC's 2 m / 70 cm station for the John Moyle Memorial Field Day.

The HF & 6 m station operated by EMDRC at JMMFD. Note the most essential piece of gear for all such days: the bug spray.



# John Moyle Memorial Field Day notes from VK5

Four amateurs operated three stations for company. We gathered at St Kilda on the coast about 30 km north of Adelaide. The location is PF95gg, 34 deg 44.74'S 138 deg 34.74'E.



Steve Mahony VK5AIM operating the Elizabeth ARC VK5LZ call sign.

The set up at St Kilda SA. Plenty of outdoors here.



Brenton Zerbe VK5BZ and his son Dave VK5FDBZ operated an HF station (the white car). Steve Mahony VK5AIM, who activated the Elizabeth ARC call VK5LZ, operated HF and VHF with the blue car. Colwyn Low VK5UE operated VHF from the green car. VK5LZ made 51 contacts in the 6 hours and these included a VK8 and a VK0 at Davis Base.

Aerials were a collection of dipoles and trapped dipoles and a variety of Yagis for 50, 144, 436 and 1296 MHz.

The weather was great, propagation good and we all had a good time.

Pictures from Brenton VK5BZ.

Colwyn VK5UE

## Summerland Amateur Radio Club

## (Lismore) NSW)

*JMMFD CONTEST, 17-19 March.*

An excellent time was enjoyed by attendees. The site was great, we'll use it again. We could have done much better with help. Operators do not win contests, those contacting them do, the operators can only chase and find contacts offered. More club members offering contacts would have seen a better result. Thanks to those members who did so, especially on the successive three hour time blocks. They did a magnificent job.

We did well, but probably won't win. Results will take some time to be calculated.

The VK3 clubs are better organised with greater member participation. We'll try for more member call ins next time. Thanks to those who called in, thanks to those who attended to make it work.



SARC's set up for JMFDC. Foreground 6 m, 23 cm, 2 m vert, behind 2 m, 70 cm.

## VK2

Tim Mills VK2ZTM

E-mail to vk2wi@ozemail.com.au

The 2005/2006 AGM of the WIA (NSW Division), now trading as Amateur Radio – New South Wales was held on Saturday the 22nd April. Much has already been reported by VK2WI news. There will be a follow up report in a later issue of these notes.

The AR-NSW property, Amateur Radio House, in Wigram Street, Parramatta, was sold during March 2006. Operation of AR-NSW will transfer to the VK2WI Dural site once the planned shed complex is completed, later this year. In the meantime, an office has been established in Parramatta at Suite 4, 8 Melville Street. The previous telephone 02 9689 2417, FAX 9633 1525, postal address P. O. Box 9432 Harris Park 2150 and e-mail vk2wi@ozemail.com.au have been retained. It is a small office, intended only to serve as an administration point. The former library, historic display and other member services have been packed away and placed in storage until their new home is established. Arrangements have been made to obtain accommodation for some of the former groups who met at Wigram

Street, as well as the monthly exams. VK2WI news will advise these various arrangements.

The May Trash and Treasure will be on Sunday the 28th. It will be held at VK2WI Dural and most likely followed by the Sunday Home Brew meeting. If there are any items for the next tender, it will depend upon the various moves, it will close on Friday, 12th May. The evening Home Brew meetings, on the first Tuesday of the month, will be held in Parramatta.

Next month is the regular Port Macquarie Field Day over the June long weekend and they invite you to plan ahead with the notification on page 4 of the April issue of Amateur Radio Magazine.

With so much on the go, VK2 Amateurs are encouraged to listen to the weekly VK2WI Sunday news or check out the text on the web for the current position of AR-NSW services. We could still be requiring the services of someone to assist with compiling the VK2WI news. Currently the news compiling task has fallen on Station Engineer Mark

VK2XOF who has had to curtail some of his other activities to fit it in. That is why we are asking for someone to take on the task and share the load. Generally it is an easy task where the various news sources, most of which now come via e-mail, are compiled into a printout which is either FAXed or delivered to VK2WI. This is the current practical delivery method as on site email reception remains difficult. As you will have noticed from the format there is a morning and evening version, mainly a matter of a simple edit. A copy of the complete text goes to the Web Master. It is a task which can be performed anywhere in VK2, you need computer and fax access. If you can assist, a message to the office is all you need to do. We are also still in need of an additional person for both the morning and evening transmissions as either an announcer, engineer or both. Contact the roster coordinator, John VK2JJV, if you can assist. 73 – Tim VK2ZTM.

## PORT MACQUARIE FIELD DAY WEEKEND Saturday and Sunday 10/11th June 2006

THE OXLEY REGION AMATEUR RADIO CLUB Inc.

Members of the amateur radio fraternity and anyone interested in Radio communication are invited to attend Port Macquarie's annual field day weekend, to be held on the Queen's Birthday weekend.

The venue will be the Sea Scout Hall, Buller Street, Port Macquarie, on the western side of Kooloonbung Creek, next door to the Country Comfort Motor Inn.

Saturday afternoon will be devoted to setting up the venue for the various displays, but early arrivals may wish to drop in to register early, socialize and later join us for a snack comprising a sausage or steak sandwich, can of soft drink or tea or coffee. There will be a charge of \$5 for the snack. There will be practice Fox Hunts during the afternoon

and a 2-metre talk-in Fox Hunt before the evening snack.

On Sunday there will be the remainder of the Fox Hunts, displays by leading suppliers of amateur radio equipment and of course, the usual tables of disposal equipment. There will be displays of Home Brew equipment and Computer Programs for amateur radio use.

**A BBQ lunch will be provided for all registered attendees.**

**Tea, coffee and biscuits will be provided free throughout the day and soft drinks will be available on sale at sensible prices.**

### Registration Fees

(Includes Sunday's BBQ Lunch)

OMs	\$15.00
XYLs, YLs & children 12 years and over	\$10.00

Further information from:

Club email:

Club Web Page:

Bruce Walker VK2HOT, 02 6583 8360

Bill Sinclair VK2ZCV, 02 6583 9302

vk2bor@tsn.cc

www.mypage.tsn.cc/orarc

## Tamworth Radio Club

The Tamworth Radio Club has just given donations to 2 charities. The first one was to Angel Flight and the second one was to Kootingal Rural Fire Service.

Donations to Angel Flight are used for the following:-

- 50% of pilots' fuel used while conducting Angel flights;
- specially discounted commercial flights in the event of long haul missions;
- Capital City transfers where a commercial flight is a much more economical option;
- short notice missions; or when poor weather conditions prevent light aircraft from flying;
- and the Angel Flight Australian Support Centre that runs on a very small infrastructure, with five full time Co-ordinators and a general manager as paid staff.

Angel Flight's most significant donors are the pilots, all of whom donate their skill and the bulk of their aircraft operating costs to help people in need.

The donation to the Kootingal Rural Fire Service, was in the form of a number of UHF hand held CB radios. These are used between members on the fire ground, directing traffic at motor vehicle accidents and to the helicopters and fixed wing aircraft used in water bombing of fires.

The three people in the photograph are from left: John Hams, President of the Tamworth Radio Club, Kath Pratt, Co-ordinator of Tamworth Radio Club Home Hosting, used during the Tamworth Country Music Festival and Jamie Thompson, Captain of the Kootingal Rural Fire Service.

I hope that the above donations are of interest to members.

John Fagan, VK2HUP  
Publicity Officer

**Do you have an  
event coming up?  
Let us know and we'll let  
others know**

# Angel Flight

Our sincere thanks

## Tamworth Radio Club Inc.

Your generous contribution will help fly financially and medically needy people and their compassionate carers to or from medical facilities.

Thanks to you these people will receive vital medical treatment, treatment that without Angel Flight's help they may not have received. You are now part of a humanitarian group that brings hope and saves or extends the lives of people in need. Welcome to our team.

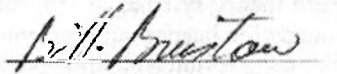

Bill Bristow  
Chairman

March, 2006

Date



# News from...

## VK2 continued

### Waverley Amateur Radio Society

Simon, VK2UA

It is now 87 years since this small but very active Sydney club was founded. Its permanent clubhouse is located on the waterfront at Vickery Avenue, Rose Bay and serves amateur radio and electronics enthusiasts living in the inner city area and southern and eastern suburbs.

The club station, VK2BV, has been rebuilt over the past year and improvements by the landlord to the premises and clubroom are continuing.

Meetings are held on the 3rd Wednesday

evening of each month. The clubhouse is also open in the afternoon of the 1st Saturday of every month, when work may be carried out to improve the club's amenities and to fix members' radio gear. Some just go along for a rag chew or to operate the club station.

This year the club's major event, the annual auction, will be held on the morning of Saturday, June 24th. All are welcome to buy or sell.

The club has held two training weekends

for Foundation Licences this year and all 15 candidates were successful. The next course is planned for early June and anyone interested should contact the co-ordinator Eric, VK2VE, via email to [exams@vk2bv.org](mailto:exams@vk2bv.org)

The Paddington repeaters on 2 m and 70 cms are managed by the club.

Anyone interested can find further information on all aspects of the club on its regularly updated web site at [www.vk2bv.org](http://www.vk2bv.org) or call Simon, VK2UA, on 02 9328 7141.

## VK3

### Amateur Radio Victoria News

Jim Linton VK3PC

Website: [www.amateurradio.com.au](http://www.amateurradio.com.au) Email: [arv@amateurradio.com.au](mailto:arv@amateurradio.com.au)

#### Education activity update

With the first six months of the new three-tier licence structure now behind us, we can clearly envisage a bright future in terms of growth and increased activity for amateur radio in Australia.

With the first 500 Foundation Licences issued nationally and now more than 140 in VK3 it's not hard to notice more on-air activity on the HF bands and voice repeaters.

Another positive sign is the eagerness of some Foundation Licensees to upgrade to the Standard Licence. Congratulations to Brian Sutton VK3FIMT and Damian Ayres VK3FDFA who are the first to qualify for the newly introduced Standard Licence under the assessment system.

They were keen to upgrade after getting their Foundation Licences and joined a four-week bridging course conducted by Amateur Radio Victoria. Others who attended the bridging course will do their Standard licence assessments soon.

In response to the changes that have occurred with the new licence structure, the contents and format of the Education On-line Service (Get your licence) section on the Amateur Radio Victoria website have been updated.

In addition to the popular Foundation webpage that began in October 2005, material aimed at assisting candidates for the new Standard Licence has been now included.

There are two trial Standard theory assessments and two Standard/Advanced

trial Regulations assessments. These can be attempted on-line to provide an instant result.

Those thinking of upgrading from the Foundation Licence will find it interesting to read an analysis of the new Standard theory syllabus as it relates to the Foundation licence requirements and makes a comparison with the superseded Novice theory exam.

To help those studying for the new Standard/Advanced Regulations written assessment is a set of regulations sample questions with answers, and useful links including to the ACMA's Amateur Information Paper.

#### Reminder about the AGM

The Annual General Meeting of Amateur Radio Victoria (Wireless Institute of Australia, Victorian Division) will be held on Wednesday 24 May 2006 at 8.00pm - St Michael's Hall, Victory Boulevard near the corner of High Street, Ashburton.

Members should have received the notice of meeting and annual reports. Those registered for the Members Only section of the website were sent this material via email, while others get it through the post.

#### Highlights for the year ended

##### 31 December 2005:

- Good financial management resulted in a surplus of \$7,384
- Membership stood at 642 (and grew in the first quarter of 2006)

- Our state-wide organisation responded to the opportunities presented through the licence restructure
- A new education and assessment team is having lots of success in introducing new people to the hobby as well as providing upgrade courses
- A team of volunteers continues to deliver member services
- Activation of special call AX3ITU on ITU Day and VK3WI from the Time Ball Tower in Williamstown for the International Lighthouse/Lightships weekend

#### Repeater restorations and improvements

The Mt Big Ben 2 m repeater VK3RNE has been restored to full service. In last month's column it was explained how the Commonwealth Games had put a big demand on available rigging services, further delaying the overdue replacement of the repeater's antenna.

The new Foundation Licensees and others in the Albury-Wodonga and north-east Victoria region are now able to have a reliable repeater giving a wide coverage area.

The Mt Macedon VK3RMM UHF repeater has also been upgraded and from all reports is providing a superior service and coverage area.

## Geelong Radio And Electronics Society (GRES)

The first three months of this year again saw a diversified mix of interesting topics on our syllabus. Due to the summer holiday season, all January meetings were informal. But in February formal meetings started.

Keith VK3AFI gave members a talk on meters. This talk covered both moving coil and moving vane meters. Keith outlined the advantages and disadvantages of each type.

Barry VK3SY and Calvin VK3ZPK informed our members about the forthcoming Marconi anniversary to be celebrated in July. A special event station will operate from Queenscliff and re-enact the radio contact between mainland Australia and Tasmania 100 years ago.

Robert VK3TAL gave a presentation on digital satellite television. This was

an in-depth talk and covered such topics as equipment needed for reception, the transmission mode, and the method of demodulation of the signal. He also gave us an insight into how music is recorded digitally for MP3 players.

One evening was devoted to preparation for the John Moyle Memorial Field Day. Following this evening a number of members participated in the field day for a 6-hour period. Some of our members who had never operated in a contest before took advantage of this opportunity to gain valuable operating experience. It can certainly be said that fine weather in a rural setting while operating a radio station is a very pleasant pastime.

Our Wednesday group has been active this year, and the groups numbers have grown. The group has decided that in the

near future an audit of all our museum pieces will be undertaken. We have four cells at the Old Geelong Gaol that are packed full to overflowing with old radio and telephone equipment. Since we have many "duplicates", we will endeavour to find new homes for our surplus items. It is hoped that we can find them homes in other museums where they will be on permanent public display.

Our final formal function for March was a visit to the Ballarat Amateur Radio Group. The BARG members gave us a most enjoyable evening. We were treated to a most informative talk by Chris Long on light modulation. This was followed by supper and time to spend talking with our friends in Ballarat.

Rod Green VK3AYQ

## Western and Northern Suburbs Amateur Radio Club (WANSARC)

### Michelle Ampt, VK3FAME – youngest amateur in VK

Mick Ampt VK3CH

Hot on the heels of her sister Janice VK3FIRE, younger sister Michelle, at the time only 7 years and 5 months passed the Foundation Licence exam recently and received her licence in early April.

Michelle's callsign is quite appropriately VK3FAME. She is one of WANSARC's newest members.

She is without question now Australia's youngest licensed operator, probably one of the youngest in the world, taking great delight in having displaced sister Janice, nine years then, from the spot she held for a while as VK's youngest ham.

WANSARC already has quite a few young members and given the size of our club, probably one of the highest percentages of young Foundation members in a radio club in VK. Michelle and Janice are also members of ALARA.

Both Janice and Michelle are already studying for the Standard Licence Regulations Exam.

To say their OM is pleased and proud is an understatement.

Both girls would like to thank John Weir (NERG) and Jim Linton (ARV) for tuition and examinations held.

Thanks to WANSARC members that had QSOs with Michelle as she was 'learning the ropes', Bob VK3EL in particular.

This proves beyond a doubt that any person with an interest and who puts in some time and study is able to obtain the Foundation Licence qualification, although living in an amateur radio household probably helps a bit!



On air at last, putting out a call on 146.450

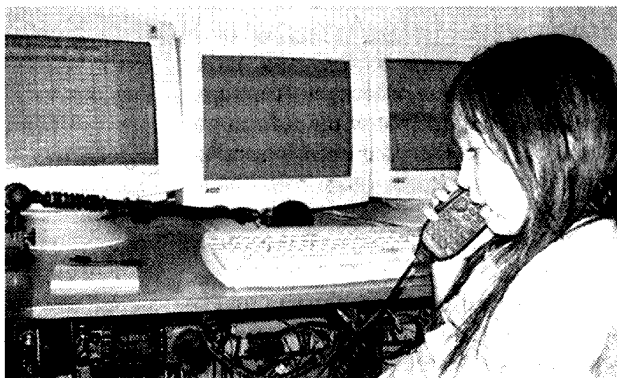

It's hard to have a QSO when your Dad is pointing a camera at you! Michelle on the IC-7000

## VK4

### QSL Bureau changes

From 13 April 2006, the new VK4 Inwards QSL Bureau address is:

PO Box 1335

Maryborough QLD 4650

AUSTRALIA

Email: VK4-QSL-in@westnet.com.au

Cards and funds from the old address will be delivered to the new address, and should be processed by the end of April. Incoming cards will be processed within 30 days (usually within 7 days). For email notification of inward QSLs, just let me know your call and email address.

If you have not yet sent SASE's or postage-funds to cover the direct posting of QSLs to you, then you should do so immediately. No cheques accepted. Send

SASE's, stamps, cash, or postal money order made out to "Eddie DeYoung". All will be receipted. Receipt will be enclosed with each QSL posting.

There will be no processing charge for WIA members, only postage (and envelope if necessary) costs.

Non-WIA members may also use the VK4 inwards QSL bureau for a processing charge of \$0.05 per card, plus postage/envelope. Non-members should send AU\$10-\$20 to open a processing account. Each mailout will include a funds-balance receipt. Cards will not be sent until fee and postage is paid.

QSLs from previous personal call signs (anywhere) will also be processed if your

**Eddie DeYoung VK4AN**  
VK4 Inwards QSL Bureau

present VK4 call sign is on the back of the card or in the VIA box.

If you are a QSL manager for non-VK4 stations, and you wish the bureau to process them, a \$0.05 per card processing fee applies to members and non-members. The bureau is for the direct benefit of VK4 personal QSLs, so it is only fair that a small processing fee be imposed for non-VK4 cards, even those destined to a VK4 QSL manager.

Non-WIA members sending-receiving a lot of QSLs via the bureau, should seriously consider becoming a WIA member, and save the QSL processing fees! See the WIA website: <http://www.wia.org.au/> for more information.

### Redcliffe and Districts Radio Club Inc.

The very active, 70 member strong, Redcliffe Radio Club meets regularly in its own clubrooms at Macfarlane Road, Kippa Ring, 20 km north of Brisbane. With a Nominated Assessor, Assessor and certified Invigilators as members, the club regularly conduct s amateur licence exams at all levels. All licence level courses and exams have been run for a number of years. We recently saw six new Foundation Licences granted.

The clubrooms are open every Monday night from 7.30 pm, with a general meeting every second Monday, technical presentations every third Monday, and foxhunts on the fourth Monday night. The club holds "activity mornings" every second Wednesday, for those wanting to

use club facilities, or just get together.

The club's AGM for 2006 will be held on Monday 19th June. Visitors are welcome to any of these meetings. Club nets are held on Sunday evenings (7pm, 146.925 club repeater, and 3.618, 7.45 pm). All are welcome to join in. Also, we run a "trivia night" on Wednesday evenings at 7.15 pm on our 70 cm repeater, 438.325 - again, all welcome to participate, although a 50c donation to the club is requested.

The club publishes and distributes a bimonthly magazine called "QRM" to all members and interested libraries and clubs. This magazine and other information can be downloaded from: [www.qsl.com/vk4iz](http://www.qsl.com/vk4iz).

On the website is a 'movie' of the club's activities in the recent JM event. For more information about everything, contact the Secretary, Peter Richardson VK4TAA, email [rdc4@hotmail.com](mailto:rdc4@hotmail.com).



Peter calling for Redcliffe at the 2006 JMMFD

## VK5

### Adelaide Hills Amateur Radio Society

AHARS had a very successful Buy and Sell just before the John Moyle Memorial Field Day. As well as the usual individual sellers, there were a large number of auction lots from the estate of Denis Grieg. His widow, Ros, donated all the proceeds to the club, so at the end of the night the club had a healthy amount to add to their bank balance.

As they have done for the last seven or so years, a group of AHARS people drove to Womberoo near Swan Reach where

they erected antennas and set up battery or generator operated radio gear to simulate emergency conditions, in preparation for the Contest. John Moyle, who was instrumental in VK-land keeping 40 metres so many years ago, was very keen that all amateurs should be able to operate under emergency conditions, hence the way we all operate during the JMMFD Contest. Propagation was not very good this year as we are at the low point of the 11-year cycle, but some satisfactory

scores were obtained nevertheless. What is nearly as important is that we all had fun and were adequately fed.

All the operators on VK5BAR commented on the number of "F" calls involved in the Contest (a good sign) and remarked on the very good on-air protocol they used. It would seem to be a move in the right direction to teach new amateurs how to conduct QSOs correctly! Well done and welcome to all the new amateurs. Keep up the good work!

**Christine Taylor VK5CTY**



## VK7

Justin Giles-Clark, VK7TW

Email: vk7tw@wia.org.au Regional Web Site: reast.asn.au

### BPL Interference Watch

A second round of BPL emission measurements has been taken at the same locations and frequencies as the first round along with a number of new locations. These reports show a continuing degradation of the noise floor in the trial areas from between 15 dB (32 times greater) to 41 dB (12,600 times greater) above the measured ambient noise floor. Take a look at the REAST BPL Watch page (<http://reast.asn.au/vk7bplwatch.php>) for more information.

### Targa Tasmania

By the time you read this, Targa Tasmania, the premier Tasmanian tarmac rally will be complete for 2006. It runs state-wide from 25-30 April and this year there is a total of 43 communications operators, 20 are amateurs including eight Foundation licensees.

### Central Highlands Amateur Radio Club of Tasmania

Saturday December 2nd, 2006, has been set as the date for the VK7 Hamfest at Mienna in the Central Highlands. The event will again be hosted by the CHARCT and if the last one was any indication it will be another fantastic event. Same venue and many suppliers have already shown interest. So mark this one in your diary!

### Northern Tasmanian Amateur Radio Club

March 9th was a mixed BBQ night at the Mt Barrow Visitors Centre with about 15 attendees. Tony VK7YBG, the NTARC repeater officer, reinstalled the digipeater on Mt Barrow VK7RAA and all appears to be working fine. The new antenna on Mt Arthur VK7RAB has also been installed thanks to Tony, Dick VK7DIK and Paul VK7KPG. Congratulations to Gareth Watson, Ross Broomhill, Stephen Barrett, Lyn Barnard and Bryn Warwick who all passed their Foundation Licence and are keenly awaiting their callsigns.

### North West Tasmania Amateur Radio Interest Group

The organisation for the Marconi Celebrations event from 12 - 16 July 2006 is coming together. The committee has received confirmation of an ARISS contact with Expedition 13 crew member Jeff Williams and Devonport High School during the event. The organising committee is also seeking any appropriate radio equipment and documentation during the event. Contact Tony VK7AX on telephone: (03) 6425 2923 or email: nwtarig@spamex.com.

David VK7DC, Dion VK7YBI, Ivan VK7XL, Tony VK7AX and Ryan Bramich made a trip to Table Cape repeater site VK7RAC and installed a new antenna and feed line for the AX25 Packet Digi on 147.575 MHz and installed the new APRS Packet Digi on 145.175.

### Radio and Electronics Association of Southern Tasmania Inc.

The weekend of the 3rd and 4th June 2006, REAST will be holding its winter field weekend at The Lea scout camp. Log fires are the order, bring your camper, caravan, tent or stay in the comfortable bunk house accommodation. The program so far includes - portable HF working, portable HF antennas, ARDF, APRS, Coax and power connectors, Rig tune ups and much more. Also included is an educative tour of the adjacent BPL trial area. The IRLP node 6710 is now located and operating from the Domain Clubrooms from

VK7RAD. APRS digipeaters are now operational on VK7RAD and VK7RHT which can hear VK7RAA in the North. The next Foundation Licence course and examination is scheduled for 20 - 21 May. Applications can be obtained from the REAST Web Site. Contact Reg



Ben Tucker VK7FSNP: our Antarctic Adventurer!

VK7KK on 0417 391 607 for further information.

We had 23 people along on the 5th April including visitors Jim N9GFT/VK4GFT and XYL Anne and Diane VK7ACW. The illustrated presentation was given by Ben Tucker VK7FSNP about his trip down to Antarctica in the 34 foot vessel Snow Petrel. Ben took us through the trip, the preparation, the safety aspects, the joys and the frustrations with excellent pictures and a movie. The distance is 1500 nautical miles one way in freezing conditions. Marine and amateur frequencies were employed for weather faxes and phone contacts. This was a very inspirational and fascinating presentation by a young guy with a goal and is a classic example of an ordinary person doing extraordinary things. Thanks Ben.

ar

# Packet radio – yesterday, today ... and tomorrow?

Ray Wells VK2TV  
vk2tv@dodo.com.au

From its infancy in about 1983, the packet mode took off on a meteoric rise in popularity to reach a peak in about 1996. Since then, packet activity has slowly declined and, along with that decline, we have witnessed the demise of much of the network in VK2 (and other places) and the nation's most popular packet interest group, the Australian Amateur Packet Radio Association (AAPRA).

**What caused the decline, where is packet at now, and what lies ahead?**

Packet radio was promoted as the best thing since sliced bread, with the promise of keyboard-to-keyboard chats over hundreds of kilometres, simply by using a string of digipeaters. Up to eight, in fact, are provided for in the protocol. We were also told about the ability to easily transfer files from one computer to another over radio links.

We were probably quite naïve in believing all the hype, and went out in droves to purchase Terminal Node Controllers (TNCs) so that we could use this new mode.

The ability to successfully digipeat through more than one digipeater, let alone eight, on shared channels, falls in the same league as the possibility of finding a Leprechaun in your back garden.

The advent of hilltop nodes using networking protocols provided a glimmer of hope, in that packets were acknowledged on a per hop basis rather than from end to end, as is the case with simple digipeating. Sadly, the implementation of early network nodes left much to be desired, and they soon bogged down, mostly because of the hidden transmitter syndrome. Early network nodes were often on the same VHF frequency as end-users so, simultaneously, they were hearing both local users and adjoining nodes.

As traffic continued to increase it was realised that inter-node traffic should not be on the users' frequency, and inter-node linking was moved to UHF. This proved to be a successful next step, but it wasn't long, due to the ever increasing amounts of packet traffic, before the dreaded hidden transmitter syndrome again reared its ugly head as node A could not only hear nodes B and C on each side of it, but probably also nodes D, E, F, etc, as well, depending on node locations.

The ever-increasing amount of BBS

traffic that the nodes and network were called upon to handle only served to exacerbate the situation, to the frustration of everyone.

In fairness to those involved in those early days, TNCs were expensive, and UHF radios for inter-node links were scarce and expensive, causing "the lowest dollar value" option to be implemented in many cases.

Had UHF radios been more readily available, had duplex links (at higher speeds) been used for inter-node traffic, had users embraced higher speeds than 1200 bps to connect to their local node or BBS, things might have been different – or would they? Overseas, where those things were implemented, packet radio is probably no more popular now, as a percentage of licensed operators, than it is in Australia.

Packet radio has undergone a natural (and probably inevitable) decline as a result of many operators taking the plunge, only to find out that "it wasn't for them".

The growth of the Internet, with its ability to deliver high-speed information transfers, that has taken place over the last ten years has only served to hasten packet radio's decline in popularity, yet the internet has also helped to maintain much of the service that users expect.

Just as there were (still are?) those amateurs who refused to accept that packet radio was a bona fide radio

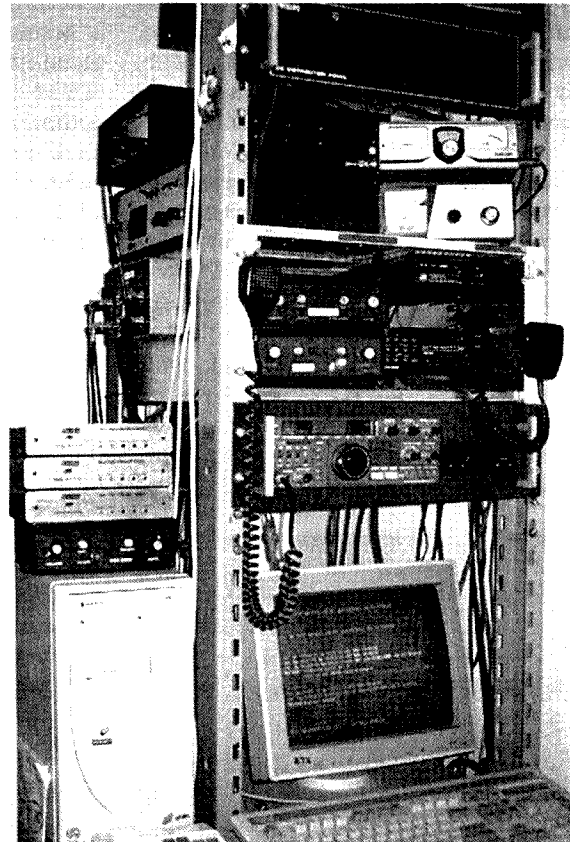

Photo 1 - in the rack, from top, DC distribution panel, 40 m then 30m SWR meters, Philips FM828s for 70 cm and 144.700 MHz, Philips FM91 for 2 m voice, TS430 for 20 m packet, then the packet monitor and keyboard. At the rear of the rack are the Tracker Lynx and Codan 6801 radios for 30 m and 40 m packet, respectively, and the 144.700/147.550 dual power meter. To the left of the rack are the MFJ1270BT TNCs for the 20 m, 40 m and 147.550 packet ports. They are sitting on the Philips FM828 for 147.550 MHz. Finally, it's the packet PC, a 300 MHz Pentium running Debian v3.0 Linux. Radio ports not served by TNCs use a Baycom USCC-4 internal four port ISA card. The station power supply is a 40 A switchmode unit from Jaycar.

activity, calling it amateur computing, or other derogatory terms, so there are those now who firmly believe that using the internet to forward packet traffic is

## The Winter of Our Discontent!

Winter is back with a vengeance and I got the dreaded influenza in mid-March, before I had taken my annual flu vaccinations. I have been indoors and naturally have been tuning via the Dxtuners website, although I have not neglected listening from my own receivers. Propagation on the higher frequencies quickly drops off as soon as it gets dark. We are still at the Sunspot minimum and it is going to be a long haul back to normality.

The German shortwave transmitting station in Jülich has been sold to Christian Voice International, which presently has senders in Chile, Zambia and Darwin. Jülich, in northwest Germany, is one of the leading transmission sites in Europe, equipped with 100 kW analogue and digital (DRM) transmitters and numerous antennas with global reach.

Under the terms of the sale, the present operators will transmit programs on behalf of clients until the end of 2007, when CVC International will take over the site for their broadcasts.

And talking of frequency switches,



Radio 3AW in Melbourne went from 1278 kHz to 693 kHz, while their music station switched to 1278. This has made it easier for me to hear 3AW in daytime as 1278 was covered in noise. Pity that Magic 693 has disappeared as it played music from my genre. 693

kHz at night is a horrible mix of the racing station in Brisbane and 3AW.

The BBC World Service is now a rolling news format, similar to that on BBC World TV. Also another major area was taken off stream with transmissions to the Caribbean and South America finishing on 26th March. There have also been reports that the BBC may be going to charge people living overseas to access Internet streaming of their programming output. UK listeners get their BBC fix as part of their receiving licence. One wonders if the dreaded licence inspectors will make sure people within Britain and Northern Ireland have paid their wireless licence to listen to BBC programs off Internet streaming.

Australia apparently has decided to permanently commence digital

audio broadcasts in 2007. The DAB or Eureka 147 system has been chosen and presumably will be in L band. I believe this will firstly start out from the capital cities and regional areas will wait longer. It is interesting that some European nations have postponed, or dropped altogether, digital broadcasts, particularly DAB. However this mode has really taken off in the UK.

The Americans have an incompatible system known as HD Radio. This uses the existing AM or FM bands with digital information being contained in the sidebands. These sidebands apparently splatter onto adjacent channels, especially with AM signals at night. This system is only operating in the US and on some Mexican stations, located close to the US border. The Canadians have opted for DAB. All of this has left the average consumer bewildered with the inevitable result that very few manufacturers have made sufficient quantities.

Recently I mentioned Radio Tashkent in Uzbekistan leaving shortwave. Apparently they have also stopped Internet streaming.

Well that is all for this month. Until next time, the very best in monitoring.

ar

## Packet radio - yesterday, today ... and tomorrow *continued*

also not amateur radio. For amateurs like myself who live on a rural property, erecting towers and antennas, presents little difficulty, but our city based cousins usually aren't as lucky. Often, applying for permission to erect a tower is simply not worth the cost and time it will take, and they choose to give radio away. A goodly number of BBSs around the world now offer Telnet access via internet, thus enabling antenna-deprived amateurs the chance to still stay in touch.

And what about those nodes that were forced to close because of an unjust user-pays system? The closure of a major node in Newcastle, for this reason, had a terrible impact on the northern NSW packet network and, to this day, there is no VHF/UHF packet link between the two largest cities in NSW.

To circumvent this problem, packet has gone "full circle" with the establishment of a HF link between Sydney and

Kempsey. The link, on 40 m, is used for mail forwarding, but is also part of the dwindling Rose network that once flourished in this state.

Not only have mail links reverted to HF, increasingly end-users have also migrated to HF following the demise of local VHF/UHF systems. HF packet also provides a means of staying in touch for portable stations that might find themselves too far away from a VHF node.

Although the number of BBS stations using HF for mail forwarding is small, those stations still handle a respectable amount of mail.

A recent bulletin sent to VKNET asked who was still on packet. This drew replies from callsigns that are not normally seen, those stations that are content to read mail but never, or rarely, send it. And how many other stations didn't respond at all? Are you one of them?

I'm determined to provide a service to

packet operators around the country. To this end my station has ports at 300 bps in the 20 m, 30 m and 40 m bands as well as 2 m local access at 1200 bps. All ports are available 24/7, subject to the vagaries of propagation for the HF ports.

The BBS system operates under Linux and supports the FBB BBS, FPAC (Rose), Netrom, TCP/IP (over radio only) and 'garden' variety AX25. Mail forwarding is with the following BBSs - VK5HB (Murray Bridge - 20 m), VK8DA (Darwin - 20 m), VK2PYU (Coffs Harbour - 70 cm), VK2VY (Port Macquarie - 2 m), VK2BLR (Parkes - 40 m), and VK2WI (Sydney - 40 m).

Is packet dead? Will it disappear completely? I say no to both questions. Packet radio is alive and well, and is just waiting for you to dust off that TNC and get it back into service once more.

ar

## To Compromise or not to Compromise – that is the question

Some questions come up again and again on the AMSAT bulletin board and in other forums.

Why should I go to the trouble of mounting my pre-amplifier up at the antenna?

Is it necessary to have a non-metallic cross boom to separate circularly polarised yagis?

Is an elevation rotator really necessary if most satellite passes are less than 30 degrees elevation?

Do I really need to be able to switch from right to left if I'm using circular polarity?

Can I work the Oscars with my hand held TRX?

How far apart do I need to stack the Yagis? The book says 10 feet, would 5 feet be enough?

The list goes on and the same questions keep on coming. They are nearly all

concerned with taking short cuts. By and large people are patient and the questions generally receive polite and considered replies even though it seems like only days or weeks since the same question was posed before.

I'm often reminded of the old maritime adage, "to spoil the ship for a pen'th of tar". Or in military terms, "For want of a nail the shoe was lost, for want of the shoe the horse was lost, for want of the horse the rider was lost, for want of the rider the battle was lost".

Now it may not be that serious in the case of an amateur radio satellite station but the principle is the same. What is the sense of outlaying a lot of money on expensive antennas and "spoil the ship" for want of a little effort? Recently the last question listed above was posted on the BB and, as is often the case, one of the gurus came up with a very detailed answer.

In this case it was Franklin Antonio. Old time satellite users will remember Franklin as the original author of the ubiquitous Instant track program. He used an analogy to illustrate his points.

The question was to do with the spacing of Yagi antennas and of the effects of large lumps of metal like rotators in their fields.

Many people have trouble with the concept of the "aperture" in relation to the way that an antenna "uses" the space around it. All antennas make use of an area of space around them to couple the RF energy into the 'ether'.

Franklin urged the questioner to think of a dish of the size required to give the same gain as the Yagi on the band in question. This is a reasonable way of visualising a Yagi's aperture. No-one, he suggested would consider overlapping dishes or mounting one in front of the other or mounting a rotator in front of a dish. Everyone would agree that it's common sense to keep the 'front' of a dish clear of all obstacles.

Yet people are quite happy it seems, to overlap Yagis and put rotators, and even towers right alongside them - inside their effective apertures. He went on to give some numbers illustrating dramatically how the idea of mounting 2 m and 70 cm Yagis on a 5 foot boom with a large rotator in the middle amounted to overlapping just about everything.

His point being that you may get away with one compromise in your system, maybe even two if they aren't too blatant. But sooner or later the performance will begin to drop off noticeably if it becomes a habit.

Judging by the frequency with which these and other similar questions come up, many people are more than willing to forego the pen'th of tar and spoil the ship.

It would be interesting to compare results from two stations, one with all compromises built in and one constructed with no compromises at all?

My advice is always the same – give it your best shot.

### The AMSAT group in Australia

The National Co-ordinator of AMSAT-VK is Graham Ratcliff VK5AGR. No formal application is necessary for membership and no membership fees apply. Graham maintains an e-mail mailing list for breaking news and such things as software releases. Contact Graham if you wish to be placed on the mailing list. As a forum for members AMSAT-VK operates two monthly nets.

### AMSAT-Australia Echolink Net

The "Echolink" net meets formally on the second Sunday of each month. Anyone with an interest in Amateur Radio Satellites is welcome to join in and take part. Graham VK5AGR acts as net controller. The net starts at 0500UTC and you can join in by connecting to the AMSAT conference server.

### AMSAT-Australia HF net

The HF net meets formally on the second Sunday of each month. In winter (end of March until the end of October) the net meets on 3.685 MHz at 1000UTC with early check-ins at 0945UTC. In summer (end of October until end of March) the net meets on 7.068 MHz at 0900UTC with early check-ins at 0845UTC.

All communication regarding AMSAT-Australia matters can be addressed to:

AMSAT-VK,  
9 Homer Rd,  
Clarence Park, SA. 5034

Graham's e-mail address is:  
vk5agr@amsat.org

## Set the course for Mars, Mr Sulu!

This is amazing. A little background information first.

The team at AMSAT-DL and Marburg University have two very ambitious projects on the drawing board and well underway.

One is the P3E satellite. It will fill the HEO gap left by the untimely demise of Oscar-40. The second is a more long term but nonetheless unfolding project to send an amateur spacecraft to Mars (P5A).

The P3E project will in many ways be a test bed for new ideas that will be included in P5A. The commissioning and control of a project like P5A will need something a little more capable than your average backyard amateur satellite earth-station.

IUZ Bochum are providing the facility which will be used by the Marburg and AMSAT-DL team once P5A becomes a reality. The Bochum installation features

a 20 metre dish with Cassegrain feed. A formidable antenna you'll agree and one in use already in the field of radio astronomy. Recently the team set themselves an ambitious goal and as a result the following announcement was made on the AMSAT bulletin board:

*On March 31st, 2006 an AMSAT-DL/IUZ team received the American space probe VOYAGER 1 with the 20 metre antenna in Bochum. The distance was 14.7 billion km. This is a new record for AMSAT-DL and IUZ Bochum. The received signal was clearly identified through means of Doppler shift and position in the sky. The receive frequency was exactly measured and compared with the information provided by NASA. This distance equals approximately 98 times the distance between Earth and Sun. VOYAGER 1 is the most distant object ever built by mankind. This again proves the superior performance of the Bochum antenna. Most probably this is the first time Voyager 1 has been received by radio amateurs. VOYAGER 1 was launched on 5 September 1977 by NASA. It transmitted the first close-up*

*pictures of Jupiter and Saturn. In 2004 VOYAGER 1 passed the Termination Shock Region, where the solar wind mixes with interstellar gas. VOYAGER 1 today is still active, measuring the interstellar magnetic field. The following radio amateurs were involved: Freddy de Guchteneire, ON6UG, James Miller, G3RUH, Hartmut Paesler, DL1YDD and Achim Vollhardt, DH2VA/HB9DUN. Special thanks to Thilo Elsner, DJ5YM of the IUZ Bochum, Roger Ludwig of Jet Propulsion Laboratory (JPL), Pasadena USA and the Deep Space Network Tracking Station in Madrid, Spain for their cooperation.*

I'm still quite blown away by this effort having recently been involved in largely unsuccessful moon-bounce experiments. I think you'll agree that the P3E/P5A team has made a remarkable achievement and it certainly proves that the Bochum facility will be up to the job of controlling the Mars probe when it comes to fruition

More information is available on the following web sites: <http://voyager.jpl.nasa.gov> <http://www.amsat-dl.org/cms>

## Useful historical archive now available

The website of Clive G3CWV now contains an archive of Richard, G3RWL's monthly satellite news bulletins.

For twenty years, Richard prepared monthly bulletins of Amateur Radio Satellite news. They were broadcast each month in UK as part of the AMSAT-UK 80 metre net and distributed via packet radio. Many VKs will be familiar with them through that medium. Many of the early bulletins were produced prior to the internet. Clive has now obtained a complete set of these bulletins which were

originally broadcast from May 1985 to July 2004. They represent a very detailed and useful archive, especially for research and preparation of lectures.

The archive comprises 239 monthly text files, which are zipped into four packages, for convenience. Also included are some reports of the AMSAT-UK Colloquium, and reports about individual satellites. The archive may be downloaded from Clive's website at, [www.users.zetnet.co.uk/clivew/satnews.htm](http://www.users.zetnet.co.uk/clivew/satnews.htm)

## Moon Bounce and Oscars

This is an on-going story but I'd like to just take a little space to introduce it. Every now and then you hear claims that EME (moon-bounce) can be done with an "Oscar-class" station.

My friend Peter, VK3SO, and I decided to put this to the test some time ago. So far we've given it a pretty good go but the results are thin on the ground. We have a few more tricks up our sleeves and these will happen in the fullness of time.

We've already learned that EME cannot be hurried! I'm hoping to devote a whole

column to a report of our success or failure or maybe a separate article, depending on the size and scope of the report.

This is a way off yet so in the meantime I'd love to hear from any other Oscar operators who have given EME a good go using just their normal Oscar-class stations.

It would be nice to do a "Myth-Busters" test on this one. So please let me know of any success or failures. I'd very much like to include others' experiences in the report too.

ar

# Amateur Radio Bookshop

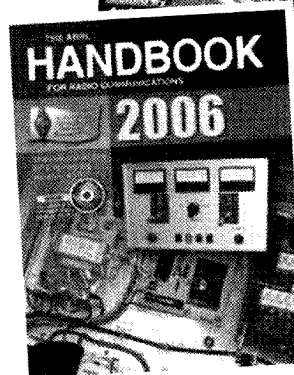
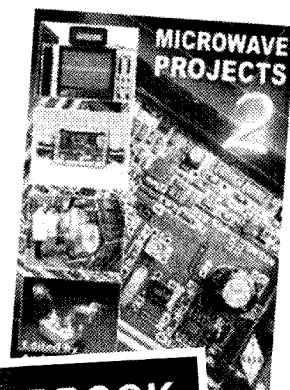

Download our catalogue at  
<http://www.wia.org.au>

Amateur Radio Bookshop  
PO BOX 3084  
EAST BLAXLAND  
NSW 2774  
Office: WIA National Office  
Tel 03 9528-5962  
Fax 03 9523-8191  
[bookshop@wia.org.au](mailto:bookshop@wia.org.au)

**ARRL - RSGB  
publications  
- books  
- magazines -  
CDROMs - DVDs**

# Awards

Mai Johnson VK6LC

## World Amateur Radio Day 2006 Award

**Amateur Radio: A gateway to information and communication technologies for today's youth.**

1. The WARD Award is designed to commemorate the World Amateur Radio Day celebrated by IARU on 18 April each year.
2. It is issued by the MK QTC, Polish Radio Amateurs' Journal, with support of PZK, Polish Amateur Radio Union.
3. WARD will be granted for at least the following numbers of contacts: either 10 QSOs on HF bands, or 5 QSOs on VHF bands. All contacts must be made between 00:00 and 24:00 UTC on 18 April 2006.
4. Send a standard application form (log extract), including the list of QSOs, to:  
The Radio Amateurs' Journal MK QTC  
Suchacz-Zamek - Wielmozy 5b  
82-340 Tolkmicko, Poland
5. on or before 31 May.
6. The price of the WARD Award is USD 6 or 5 euros.
7. Full-colour Award, size: 210 x 297 mm.
8. The WARD Award is also available to SWLs for the same numbers of reports.  
<http://ward-award.prv.pl/>

ar

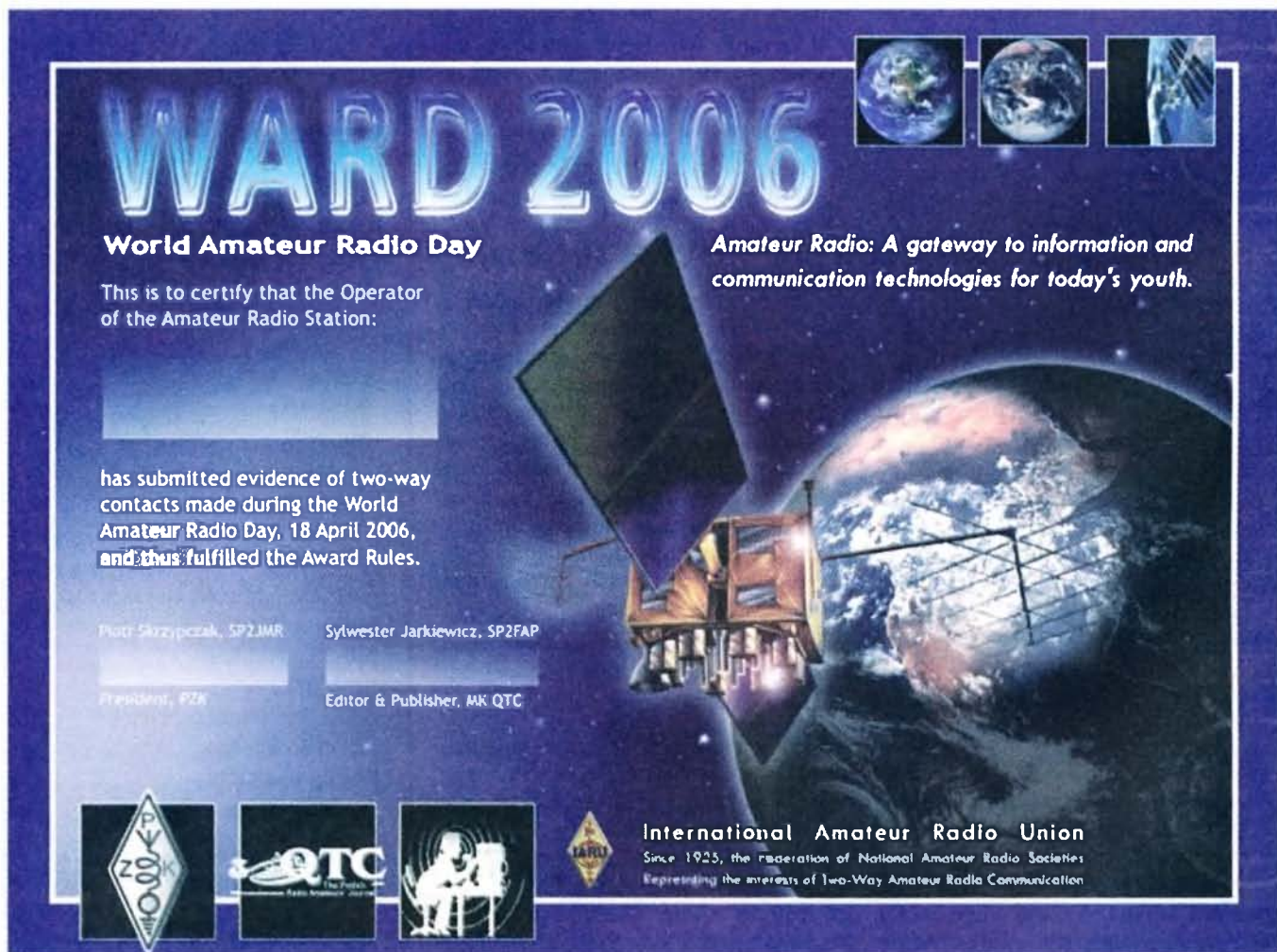

The image shows a certificate template for the WARD 2006 Award. The background is a dark blue space scene with a satellite in orbit over Earth. At the top, the text "WARD 2006" is written in large, glowing blue letters. Below it, the text "World Amateur Radio Day" is displayed. The main body of the certificate contains the following text: "This is to certify that the Operator of the Amateur Radio Station: [Redacted] has submitted evidence of two-way contacts made during the World Amateur Radio Day, 18 April 2006, and thus fulfilled the Award Rules." Below this, two names are listed: "Piotr Skrzypczak, SP2JMR, President, PZR" and "Sylwester Jarkiewicz, SP2FAP, Editor & Publisher, MK QTC". At the bottom, there are logos for PZR, MK QTC, and IARU, along with the text "International Amateur Radio Union Since 1925, the federation of National Amateur Radio Societies Representing the interests of Two-Way Amateur Radio Communication".

<http://ward-award.prv.pl/>

## Contest Calendar May - July 2006

May	6/7	ARI Intl. DX Contest	(CW/SSB/RTTY)
	13/14	CQ-M Intl. DX Contest	(CW/SSB)
	13	VK/trans-Tasman 80m Phone Contest	
	20/21	Baltic Contest	(CW/SSB)
	20/21	King of Spain Contest	(CW)
	27/28	CQ WW WPX Contest	(CW)
	27	VK/trans-Tasman 80 Metres CW Contest	
June	10	ANARTS WW RTTY Contest	(Digi)
	10	Portugal Day DX Contest	(SSB)
	10/11	South America CW Contest	
	10	Asia-Pacific Sprint Contest	(SSB)
	17/18	All Asian DX Contest	(CW)
	24/25	Marconi Memorial HF Contest	(CW)
July	1	Canada day Contest	(CW/SSB)
	8	VK/trans-Tasman 160 Metres Phone Contest	
	8/9	IARU HF World Championship	(CW/SSB)
	15/16	CQ WW VHF Contest	(All modes)
	15	Jack Files Memorial Contest	(CW/SSB)
	22	VK/trans-Tasman 160 Metres CW Contest	

Greetings to all Readers...

## The Quest for the Ideal

### Part One: Basics

We would all be aware of the new Callsigns that have appeared on our bands, so over the next few months I would like to direct my ideas primarily to these people, in the hope that they will try a contest and find some of the joy that can come from "giving numbers".

Regular readers of this column will know that I constantly urge you to keep your station at peak efficiency – for the obvious reason that you hope not to find yourself brought to an abrupt halt by a breakdown. So, having gone to the trouble of erecting antennas, it is wise to keep them in good condition.

### Basics

1. Just as much effort needs to go into setting up your operating position as goes into your station efficiency. Comfort is most important – not to the point of going to sleep when the

scoring rate slows down, but for ease of reach of everything that you need. The Quest for the Ideal Layout is never-ending in theory, but must be so in practice, and that for most of us means compromise in one way or another.

It is essential that the equipment that you need for that contest is within comfortable reach. No use if you have to reach across things to pick up your two metres or seventy centimetres microphones and run the risk of grabbing the wrong one or knocking over something else. So know what you need and arrange it within easy hand's reach.

2. Your chair must be comfortable and not put strain on your back or thigh muscles. In general I would suggest that it not be on castors in case it

should "take off" during times of busy activity (and there will be those, as well as slack times).

3. Read the rules of the contest carefully long before the event. This may seem obvious, but there are many chaps on the air who admit that they do not know what the rules require. More anon.
4. Whilst all of the above is important, yet I suggest that they are the second step in the chain of preparing for a contest (or even general shack operation).

Firstly you must decide what your interests are and which contests will best meet those needs. Traditionally contests are on the HF bands, so CW and SSB are the normal modes; but these days PSK31 and RTTY events can be found, as well as contests for



Figure 1



Figure 2

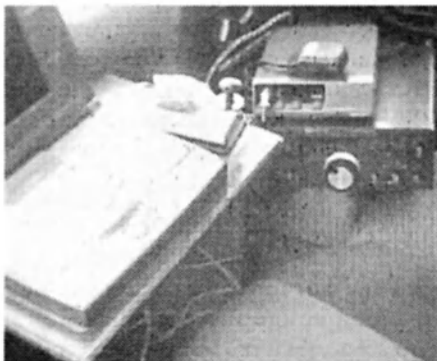

Figure 3

the VHF/UHF enthusiast.

Many of us, especially when we start out in the hobby, think that we must be equipped for EVERYTHING! If you are rich that's fine – if you are not, then that attitude can be a recipe for disaster and disillusionment. Better to start with HF or VHF and work outwards into modes that may become interesting to you. This will also mean that you won't have to erect a vast antenna farm – and that alone could save arguments with members of your family and neighbours.

If you will permit me a personal comment at this point -- my area of interest is HF and within that the CW mode has always attracted me. (At this point please don't think "Oh the silly ... is living in the past and expects us to do likewise".) I am not specially interested in SSB, preferring the better audio quality of FM. However, this does not stop me from working SSB when I have decided to do so.

Against this background I usually make an effort to submit a VHF log in contests like the John Moyle Field Day and Remembrance Day, but right from the start my attention goes to the CW bands, so the lesson is to concentrate on having as good an HF setup as I can get. I'm not rich so it has to be simple – but simple systems can still achieve much when joined with competent operating techniques.

5. Having decided your area of interest, then plan what gear is needed for maximum participation in that interest, select an appropriate contest, then make yourself comfortable, enter the contest and enjoy it!
6. Part of your deciding has to be whether you will use computer or paper logging (more on this next month).

If you look at Fig. 1 you will see a shot of my own shack as it is currently set up.

It is not ideal and never will be because of limited space and the need to have Office and Shack in the same situation. Notice the use of laptops, simply because CRT screens cause severe hash at points across the HF bands, rendering those frequencies useless to me. Again you may think "Hell, he doesn't even know how to suppress noise". You may be right, but no matter what I do I cannot kill the hash from the colour guns in the VDU.

If you do use screens and keyboards, then they become part of the comfortable arrangement talked about earlier.

### Portable Operation

Some contests are Field Day types where we are encouraged to take our rigs and set up in an outdoor venue. Figs. 2 and 3 below are ideas for such a setting.

If and when you try this type of contest, the same principles discussed above apply – necessary gear and comfort. Sitting in a car is not especially comfortable, but good results can be achieved if you get out and walk every half hour or so.

### Finally

If all goes well you will have a good contest, enjoy it as you go and feel tired but happy at the end. And yet is it the end? Not quite. There is still one thing to do – send in your log! You would be amazed at how many operators here in Australia can be heard saying "I'm not in the contest, but I'll give you a number". This is self-defeating – but more on that anon.

The Manager's contact details are always in the rules of the contest, so when everything is compiled, send it off. Most contests these days have an email address for submission of logs, so if you really wanted to get it all finished at the end of the contest, you could spend an extra ten minutes preparing your entry and send it there and then. Many regular contesters do that, so that it would not be unusual for a Manager to have 20 entries half an hour after the event closed.

Next month we shall look at more practicalities as well as thoughts on modern trends.

Good contesting and 73,

Ian Godsil VK3JS

## Results CQ WPX CW Contest 2005

Call	Band	Score
VK7GN	All	653,260
VK6AA	"	1,371,832 (Op. VK2IA)
VK8AV	"	484,610
VK4TT	"	270,068
VK3KE	"	43,384
VK2BAA	"	12,932
VK4BUI	14	329,085
VK6HZ	"	2,378
VK3JS/QRPP	All	1,134

ar



# Beyond our shores

David A. Pilley VK2AYD  
vk2ayd@wia.org.net

## Radio technology: a new way to forecast the solar max

Researchers have announced a major break-through research into forecasting solar activity and its effect on radio communications: One that could have a definite impact on ham radio and especially DXing.

The next sunspot cycle will be 30-50 per cent stronger than its predecessor and will begin as much as a year later than previous forecasts, according to scientists from the US-based National Center for Atmospheric Research. If the prediction is correct, the next solar maximum could be the most intense since the historic solar maximum of 1958.

The National Center for Atmospheric Research scientists believe they have mastered the art of accurately forecasting solar cycles. They have developed a computer model that they claim has simulated the strength of the past eight solar cycles with an accuracy of more than 98%. This amazing precision is achieved by using the subsurface movements of sunspot remnants of the previous two solar cycles to calculate the strength of the next cycle.

The Sun undergoes 11-year cycles of activity, from peak storm activity to quiet and back again, but until now there was no precise method of predicting their timing and strength. Being able to accurately predict the sun's cycles years ahead could help society prepare for periods of intense solar storms, which can disrupt communications, slow down satellite orbits and crash power systems.

Solar storms are thought to be caused by twisted magnetic fields in the Sun that suddenly snap, releasing huge amounts of energy. They usually occur near dark regions of concentrated magnetic fields known as sunspots.

Thanks to Jeramy Boot G4NJH via ARNewsline

## Canada: RAC may seek Canadian Entry Level Licence

Canada could be the next nation to go for an entry level license to entice more

young people to enter the hobby. This as Radio Amateur of Canada's Board of Directors authorises the formation of an Advisory Committee to examine whether telecommunications regulator Industry Canada should be asked to institute a new Entry Level Certificate for the Canadian Amateur Service.

The committee is under the leadership of Midwest Director BJ Madsen, VE5FX. It is evaluating the very successful Foundation Licence that has been implemented in the UK and Australia. That certificate encourages young people to take an interest in science and radio to promote growth in amateur radio. The committee will also seek input from Canadian radio amateurs as to what should be done.

(RAC)

## Monaco: new allocations in Monaco

Hams in Monaco have some new ham radio allocations. According to the GB2RS News Service, effective from January 2006, the principality has allocated 1.810 to 2.000 MHz on 160 meters with 1.810 to 1.850 MHz primary exclusive and 1.850 to 2.000 MHz as secondary shared. Also now available is 6 meters from 50 to 52 MHz with 50.0 to 51.2 MHz primary exclusive to amateur radio and 51.2 to 52.0 MHz as a secondary shared allocation.

## Poland: first 10 metre beacon in Poland

The first ever 10 metre beacon in Poland is on the air. SR4TEN, was activated at 10.15 UTC on March 6th. It's located at

the office of the MK QTC Magazine in Suchacz and operates with 3 watts out on 28.203 MHz. If you receive SR4TEN, please e-mail your report to qtc@post.pl.

(VHF Reflector)

## U.S.A.: Logbook Of The World now supports Worked All States Award

Users of the ARRL's *Logbook of the World* (LoTW) <http://www.arrl.org/lotw/> now may apply their LoTW credits to applications for the League's Worked All States (WAS) award. Once registered and logged in, users may set up a WAS account on the Logbook Awards page, configuring the account to automatically select QSLs to use or selecting them manually via the Your QSOs page.

LoTW is a repository of logbook records submitted by users from around the world. When both participants in a contact submit matching QSO records to LoTW, the result is an electronic "QSL" that can be used for award credit.

As part of this addition, administration and maintenance of all WAS awards is now performed using a LoTW module. US Amateur Radio licensees must be ARRL members to apply for the WAS award. In addition to WAS, LoTW supports the ARRL DX Century Club (DXCC) award.

Since its inauguration in September 2005, LoTW has more than 95 million QSO records on file, with nearly 5.15 million QSL records resulting. The system boasts just over 12,000 registered users, and there are more than 18,100 certificates - each representing a particular user call sign - on file.

(ARRL Newsletter)

## Callbook 2007

Work will be starting soon.

Now is the time to check that ACMA has your CORRECT info.

We have to print the lists as they come from ACMA.  
Any other comments welcome.

# DX - News & Views

VK4OQ,

P.O. Box 7665, Toowoomba Mail Centre, QLD 4352.

Email [john.bazley@bigpond.com](mailto:john.bazley@bigpond.com)

Well, I wonder how you fared with the recent DXpeditions to The Andaman Islands. It should have been relatively easy to work with the amount of activity planned and notified well in advance. There were probably quite a number of RF interaction problems that had to be solved with such activity. It will be interesting to read reports from the various groups that were there and particularly to see if this will now become an annual event.

A number of awards will be available for contacting the various operators who were active during the Hamfest at the Andaman Islands. The basic award will be issued to any station who works at least four different VU4 stations. Contacts can be made on any band/mode, starting from 18.30 UTC on 17 April until the DXpeditions are over. Full information is available at <http://www.niar.org/hamfest/awards.html>. At the time of writing 155 licensed amateurs plan to visit the Andaman Islands for the Hamfest including VK2JNA, VK8FR & VK9NS.

It is interesting to note changes in operating modes by DXpeditions. There is no doubt that RTTY is becoming more popular as DXpeditions now make a point of using that mode. The recently released QSO statistics for the 3Y0X operation show that nearly 5% of the total QSO's were on RTTY. Undoubtedly this has been facilitated by the various computer programmes available and the comparative ease to get them up and running. I see that a recent DXpedition has declared that RTTY will be the primary mode used and the main reason for going!

Are you still looking for a challenge? Then perhaps the new CQ DX Marathon, a year-long DX hunt, is what you have been looking for! Participants will compete to see who can work the greatest number of countries ("entities") and CQ zones over the course of a full year, then starting again at zero at the beginning of the next year. This year's Marathon began at 00.00 UTC on the 1st January and will end at 23.59 UTC on 31st December. A new dedicated web site has been established at [www.dxmarathon.com](http://www.dxmarathon.com) from which you can download a complete set of rules. I am sure that a lot of QSL Managers will

be pleased to see that QSLs will not be required.

Referring to QSL Managers, I do not normally give their details but since W3HMK handles so many cards I felt I should record his change of address. Effective from the 1st March, his new address will be, W3HMK - Joseph Arcure Jr, 115 Buck Run Road, Lincoln University, PA 19352, USA.

For those interested in reading accounts of DX operations the first account of the 3Y0X operation written by co-leader Ralph Fedor K0IR, appeared in a recently released edition of the TCDXA Gray Line which can be downloaded <http://www.tcdxa.org/March2006GrayLine.pdf>. This edition also reveals plans by W0GJ for his upcoming VU4 operation. For those old timers going back to the 1960's an article by K0IEA on FO8M by W9WNV will revive memories, hard to believe that that was 50 years ago!

DXCC have announced accreditation of the following operations:-

3Y0X - Peter 1 Island Operation from February 8 through February 19, 2006

6O0N - Somalia Operation from January 18 through February 18, 2006

YI/OM2DX - Iraq Operation from July 27 through September 21, 2003

YI3SRA - Iraq Operation commencing October 3, 2003

So what have we to look forward to in May and beyond?

**PA3EXX (VK4WWI), Johan Willemsen**, is heading back to the Pacific. He plans to be QRV as P29VV from Witu Islands (OC-181) on June 16th through the 19th. Look for activity on 10, 15, 20, 30 and 40 meters on both CW and SSB. QSL info and additional information will be published on <http://home.quicknet.nl/mw/prive/willemsen/>. Johan also plans to be active from New Britain (OC-008) a few days before and after the expedition to OC-181.

**9Q - Luc ON7KEC** will be working in the Democratic Republic of Congo from early April until the end of July. He plans to operate on the amateur radio bands as 9Q/ON7KEC in his spare time. QSL via home call.

**V25V, Antigua**, will be G0VJF, Nobby, June 23-July 6. We don't yet know what bands and modes he plans to concentrate on. QSL via G4DFI direct or bureau.

**N6NO, Merv**, will be celebrating 55 years of hamming and his 70th birthday from Lord Howe Island. Look for him to be QRV as VK9LNO from May 5th to 13th. He'll be 10 through 80 meters mostly CW running 100 watts and wire antennas. QSL via N6NO.

**Jersey Islands** : Look for Chris, M0DOL who will be active from Jersey (EU-013) as MJ0DOL/p - April 26th to May 4th.

**FP/DJ2VO (Juergen)**, plans to activate St Pierre from May 5th to May 20th operating on all bands from 80 to 10 metres using 100 watts and a vertical antenna. Further information is available at [www.qsl.net/ts7n/dj2vo](http://www.qsl.net/ts7n/dj2vo)

**KP2/N2IFA (Steve), KP2/KB2ENF (Steve) and KP2/KF2TI (Steve)**, will be active from 19th May until 22nd May on all bands from 160 to 10 metres. They are offering a certificate to amateurs who work all three stations (Worked all Steves!).

**AH8/W9EYE (Gavin)**, states "I will be in American Samoa in May (15th to 21st) working as a medical missionary, so this will be more of a "spare time" operation. I plan to work all HF bands on SSB as allowed by propagation. QSL please via my home call".

**6W2/F6ELE (Fidier)**, will be operational occasionally during 9th June to 19th QSL via his home call.

**VP8/Falklands**. For readers needing a QSO with the Falkland Islands, Richard VP8DIZ, who operates on all bands is willing to make skeds via e-mail. His e-mail address is [richard.paul@interserve.co.uk](mailto:richard.paul@interserve.co.uk)

Special thanks to the authors of *The Daily DX (W3UR)* and *425 Dx News (IIJQJ)* and *QTC DX PY2AA* for information appearing in this month's *DX News & Views*.

For interested readers you can obtain from W3UR a free two week trial from [www.dailydx.com/order.ht](http://www.dailydx.com/order.ht).

ar

## Weak Signal

David Smith - VK3HZ

We're now well into autumn and, as could be expected, good propagation conditions are few and far between. However, that's not to say there are no periods of enhancement - they're just a little more difficult to find. So, it's probably a good time to go through a list of web resources that are a good source of information about band conditions. Note that this discussion applies mostly to the bands from 2 m upwards.

For general real-time information, the VK/ZL VHF-UHF Propagation Logger is proving to be very valuable - [www.vklogger.com](http://www.vklogger.com) When the bands are jumping, many people report their success (or otherwise) and many more monitor this page. At times, the list of call signs viewing the page becomes quite long - like a flock of hungry seagulls perched on the powerlines waiting to pounce on the DX.

For those who can't continually monitor the VK/ZL Logger, then the VK-VHF mail list often has news of good band conditions - [mail.une.edu.au/lists/cgi-bin/listinfo/vk-vhf](mailto:mail.une.edu.au/lists/cgi-bin/listinfo/vk-vhf). Just don't mention trees.

For tropospheric enhancement, the number one site would be William Hepburn's VHF/UHF Tropospheric Ducting Forecast - [home.cogeco.ca/~dxinfo/tropo\\_au.html](http://home.cogeco.ca/~dxinfo/tropo_au.html) Originally developed for DX TV enthusiasts, it is quite a reliable indicator of good tropo conditions.

To verify that Hepburn's is giving the right information, the Bureau of Meteorology weather radars sometimes show evidence of tropo propagation enhancement - [www.bom.gov.au/weather/radar/](http://www.bom.gov.au/weather/radar/). Look for indications of rain at long range where no clouds are shown on the satellite images. These phantom indications are often caused by reflections from mountains way beyond the normal range of the radar - received because of enhanced propagation conditions.

Even though we're near the sunspot activity minimum, there are still solar outbursts causing enhanced auroral propagation conditions. The Costello Geomagnetic Activity Index - [www](http://www.sec.noaa.gov/rpc/costello/).

[www.sec.noaa.gov/rpc/costello/](http://www.sec.noaa.gov/rpc/costello/) - provides a short-term prediction of auroral activity. Another NOAA page - [www.sec.noaa.gov/pmap/pmapS.html](http://www.sec.noaa.gov/pmap/pmapS.html) - shows the current extent and position of the auroral oval in the southern hemisphere from satellite measurements.

So, bookmark these site addresses in your web browser and start looking for good conditions. They're still happening!

## UIOLI

No that's not a new digital mode, but stands for "Use It Or Lose It". Ever so slowly, our band allocations are being nibbled away and we need to be more vigilant and reactive to prevent further losses. Several recent events have affected some of our VHF/UHF/Microwave bands.

The new European competitor to the US GPS system has commenced launching satellites. Galileo will eventually have 30 satellites operational using a wide range of frequencies, including a chunk in the 23 cm band (1260 MHz to 1300 MHz). Signals from the satellites will be quite weak and spread over a wide band, so interference to amateur stations is unlikely to be significant, except perhaps for large EME setups. However, it is thought that amateurs could interfere significantly with Galileo users and considering that the 23 cm band carries the Commercial and Public Regulated services (both subscription services), then there could be some issues. More information about Galileo can be found at [www.southgatearc.org/articles/galileo.htm](http://www.southgatearc.org/articles/galileo.htm).

Working up the bands, ACMA has recently issued a proposal to vary the LIPD Class Licence to allow RLAN (radio local area network) access in the 5 GHz band. The variation allows RLAN operation at a maximum level of 1 watt in the frequency band from 5.650 - 5.725 GHz. During a recent outing to a hilltop with Alan VK3XPD, we noticed digital-type interference on 5.7601 GHz that had not been heard before. Looks like the

WiFi scourge is also going to make weak signal operation on 5.7 GHz difficult, as it has for 2.4 GHz.

The ACMA proposal for varying the LIPD Class Licence also will authorise the operation of ultra-wideband short-range vehicle radar in the frequency band 22 - 26.5 GHz - right over the top of our exclusive allocation at 24 - 24.05 GHz. It is unlikely that 24 GHz operators will suffer much interference, due to the extremely low power level and wide bandwidth being used. However, I hope the opposite is also true. These vehicle radars are used for intelligent cruise control, keeping vehicles a set distance apart at varying speeds. A failure caused by interference could have dire consequences.

Finally, ACMA has called for comments on a draft proposal to amend the Radiocommunications Act to allow the authorisation of devices under class licences in spectrum designated for spectrum licensing. They claim that this is needed due to the emergence of new technologies, which have low interference potential but use a wide band of frequencies, and the consequent need for these devices to be licensed across whole radiofrequency bands. This, of course, has the potential to impact all of our amateur bands and weak signal devotees will be hit hardest. Understandably, there has been a significant negative response from the telecommunications business community. Many of these companies have paid many millions of dollars for licences for their chunks of spectrum, and would be very unhappy for their frequencies to be degraded with wideband noise.

So, it pays to keep an eye on the ACMA web site - [www.acma.gov.au](http://www.acma.gov.au) - for any changes that may affect the amateur service. We should be vocal in opposing all changes that may adversely impact our hobby.

And above all, UIOLI.

Please send any Weak Signal reports to David VK3HZ at [vk3hz@wia.org.au](mailto:vk3hz@wia.org.au).

*continued next page*

# Digital DX Modes

Rax Moncur - VK7MO

The group involved in the weekend FSK441 Activity Sessions on 144.230 MHz has decided to adopt a slightly different format for the time being to accommodate interest in VK4 and VK5. The format with times in NSW/Vic local time is as follows:

## Saturdays

0600 to 0700 VK1/2/3/4/7 TX first period to VK5 second period

0700 to 0800 VK3/5/7 TX first period to VK1/2/4 second period

## Sundays

0600 to 0700 VK1/2/3/4/7 TX first period to VK5 second period

0700 to 0800 VK1/2/3/5/7 TX first period to VK4 second period

VK4 is currently represented by VK4WS, VK4CDI and VK4EME and VK5ZGP is representing VK5. All activity is on FSK441a now that FSK441b and FSK441c have been dropped from the latest versions of WSJT. New stations are always welcome to join the group

on 144.230 and the 40 metre callback on 7085, or nearby, after each activity session.

Congratulations to Ian VK3AXH, on getting his four x 5 λ Yagi 2 meter array operational. He is making many EME contacts on JT65, including one with a single Yagi station in the UK.

Please send any Digital DX Modes reports to Rex VK7MO at [rmoncur@bigpond.net.au](mailto:rmoncur@bigpond.net.au).

# The Magic Band - 6 m DX

Brian Cleland - VK5UBC

The bottom of the sunspot cycle certainly appears to have taken its toll on the 6 m band with there being very few TEP openings to the north. Looking at the 6 m loggers, there have only been a few reports of beacons heard or stations worked, only the occasional logging from JA stations reporting VK4TV and the northern beacons VK4RTL (Townsville), VK6RSX (Dampier) and occasionally VK8RAS (Alice Springs). Also there were only a couple of sporadic E openings in March.

On the 22nd March Trevor VK3VG Kyabram worked John VK4FNQ Charters Towers and early morning on the 23rd March there was an opening from VK5

to the Brisbane area of VK4. Wayne VK4WS worked VK5's UBC, ZK, NY & DX with Brian VK5UBC also working Allan VK4ID. Later in the morning the Townsville beacon was up to S9 in VK5. The evening of March 23rd Joe VK7JG Launceston also worked VK4ID.

Received a note from Colin VK3BE who reports that this was his first year on 6 m after 27 years and he managed to work VK1, 2, 3, 4 and ZL4LV on 16/3/06. In Colin's words "I had a ball". Well done Colin, I hope to hear you shortly.

From the 6 m loggers: on the 5th April, JA1VOK reports hearing the northern beacons and working John VK4FNQ. On the same day there was reported JA

activity into Darwin and Alice Springs. Then on the April 10, Hiro JG3LEB reports working Gary VK4ABW and Ray VK4BLK.

Noticed on the VHF-UHF propagation logger that there was mention of the Darwin 6 m beacon being reactivated shortly. This would certainly be welcome and if you have any information in regard to this please forward it to me.

With very few openings at this time of the year it is very difficult to produce 6 m notes so if you have any 6 m items of interest please remember to send them to Brian VK5UBC at [bcleland@picknowl.com.au](mailto:bcleland@picknowl.com.au).

ar

---

## Silent key

### Ronald Albert Hodges VK3HO

Ron passed away peacefully in his sleep on 17 January 2006 at his home in Point Lonsdale, Victoria. Ron was 94.

He was born in Merlynston, Vic, and lived there until married to Grace, when he shifted to Pascoe Vale South. Ron was an electrician at CIG during the war and after; I met him through his amateur radio activities. He built the first 40 foot self supporting tower and full size beam that I had seen, and certainly the first in the area. A good CW operator, we enjoyed lots of DX using the beam.

Ron spent a lot of time with me whilst I learnt Morse and got operating skills.

He wound all his own transformers in the rig and then a high level modulation transformer. With his home brew 10 tube Super he enjoyed the CW and phone contacts until SSB came in. By this time he had retired and moved to Point Lonsdale where he remained for the rest of his life.

Here he purchased an FT101 and vertical, which we installed on the apex of his tin roofed garage, using 100 lb nylon fishing line as the guys. This antenna was still there with the same guys when he passed away.

His love of Morse can be seen, as each

morning he would go out to the shack and listen to the shipping reports, I don't know how he got on when they stopped. At 94, he still played bowls and walked without a stick until the last couple of weeks. He suffered a heart attack in December and had a pacemaker installed. This was the final act before his daughter found him in bed on the morning of 17 January.

Ron is survived by a son, daughter and daughter in law, 4 grandchildren and 2 great grandchildren. He is sadly missed.

Allen VK3SM

# Secret Radio Communications

Dr Hank Prunckun, VK5JAZ

Spying and covert operations aren't new and neither are the methods operatives use to communicate in this shadowy world. In this article, Hank speculates on the use of wireless transmissions by terrorist agents who may be in Australia.

## Illicit Transmissions

International spying did not end when the Berlin Wall fell. Spy craft is still alive and well and flourishing in areas that have spun out of radical religious briefs as opposed to geo-political alliances. Terrorists who trained with al-Qaida and its affiliated groups have to a large extent replaced the Communist agent notorious in the spy novel. Sleeper cells awaiting word to activate or deep cover agents passing messages back to "Command" have used secret communication systems as standard operating procedure — this is well documented in the scholarly literature on espionage.

In the main, field agents have communicated using high frequency (HF) radio transmissions. Miles Copeland (1913–1991; ex-CIA officer and previously Counter-Intelligence Corps during World War II) describes this practice in some detail in his book *The Real Spy World*.

In the days before the Internet and the World Wide Web, HF radio was arguably the most, if not the only, reliable method of worldwide communication and the method least likely to be subject to interception — unlike telephone, telex or facsimile. Again, Copeland discusses why:

"Clandestine radio is also safer than is commonly supposed. Even with the most modern detection equipment, frequencies used for espionage transmissions are hard to catch — and still harder to identify for what they are because the transmissions sound like ordinary coded messages used legitimately by diplomatic and commercial concerns. Even if they come under active suspicion, by the time direction finders ("DF-ing equipment") are in place to seek the point of origin, the message is over. Naturally, the "DF-ers" listen for the next transmission, but it may be from a different place. Modern security agencies claim that they have sophisticated equipment which will

overcome these difficulties, but it simply isn't so. The airwaves are full of illicit transmissions — from China, from various parts of Russia, and from the Third World. When senders are caught it is usually as the result of tip-offs from suspicious neighbours rather than from successful DF-ing. DF-ing gets the security agents to the right general area, but that is about all." (Copeland, 1974: p.143)

## Command, this is al-Qaida/VK calling ...

In early 2005, Mr Dennis Richardson, the head of Australia's domestic counter-espionage agency — Australia Security Intelligence Organisation — announced at a legal conference that there were a number (not disclosed) of people trained as terrorists living in Australia. But because they have not committed any breach of law, there was nothing his agency or the law enforcement community could do to remove this threat from the community, he said (but later

that same year, police arrested several people on alleged terrorism charges).

Have the remaining people simply abandoned their zeal for radical religious/political change and gone about their lives? Or, are these people merely lying low, planning an attack or awaiting word from Command (in whatever form Command might be) to be part of an attack? If the latter were the case, clearly these agents would need some form of secret communication; simply picking up the telephone and dialling their "controller" would not be a wise move (the DG of ASIO did not discuss whether, or how, these terrorist-trained people were being monitored, but it would be reasonable to speculate that telephone intercepts would be high on the list of collection methods).

During the Cold War, an agent might be sent into 'enemy' territory to observe and report on activities or facilities of strategic interest. While in that country, s/he would use a portable HF transceiver to send and receive messages (1). Recently declassified al-Qaida documents, which

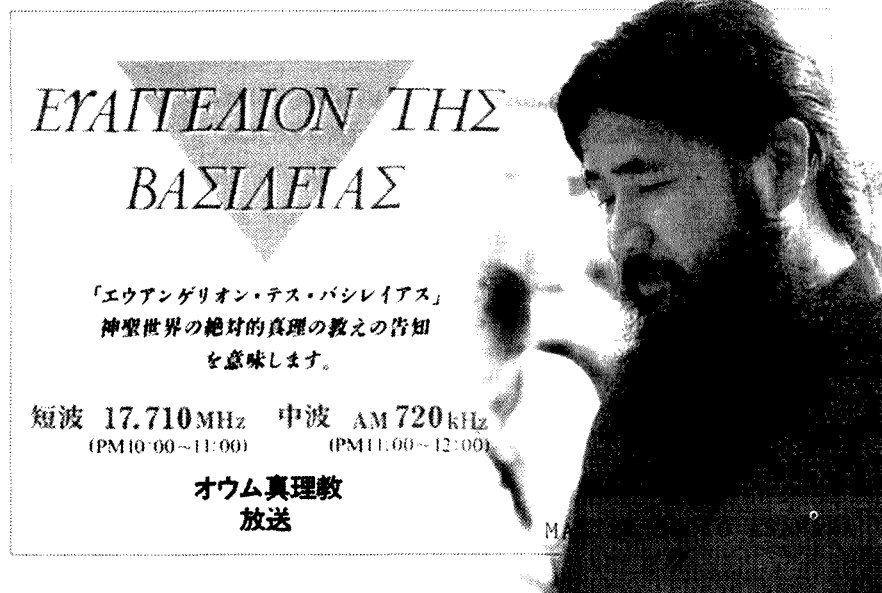

Figure 1

were seized by security agencies, confirm this situation still holds true. What is commonly called the Al-Qaida Training Manual (the formal title is: Military Studies in the Jihad Against the Tyrants) sets out the counter-measures that its covert operatives should adhere to while conducting their surveillance (Command, this is al-Qaida calling...):

...firm security measures should be taken to secure communications between the members in the country and the command outside. These measures are:

1. The duration of the transmission should not exceed five minutes in order to prevent the enemy from pinpointing the device location.
2. The device should be placed in a location with high wireless frequency, such as close to a TV station, embassies, and consulates in order to prevent the enemy from identifying its location.
3. The brother [i.e. the al-Qaida operative], using the wireless device to contact his command outside the country, should disguise his voice.

4. The time of the communication should be carefully specified.
5. The frequency should be changed from time to time.
6. The device should be moved from one location to another.
7. Do not reveal your location to the entity for which you report.
8. The conversation should be in general terms so as not to raise suspicion. (p.39)

## Shortwave Frequencies

In the case of sleeper cells, take the French Resistance in World War II. Allied forces transmitted radio messages over the shortwave frequencies (one-way night broadcasts) into Nazi occupied Europe with coded messages that were meaningful to particular Resistance cells. Coded message such as "dice are on the table," meant railway lines should be sabotaged, and "it's hot in Suez," meant telephone lines should be attacked. (see editor note) These were one-way transmissions — a French agent sitting behind a simple "crystal set" listening to

a BBC broadcast. No direction finding equipment could locate his/her presence. If, on the other hand, they were to transmit a signal, it would be possible for radio direction finding to get a fairly good fix on the area so that troops conduct a "door-knock" of the vicinity looking for the agent and his supporters.

Would terrorists use such systems now when there is ubiquitous access to the Internet? Certainly shortwave broadcasting is still popular. Many governments still sponsor stations promoting friendly propaganda about their country. There are numerous religious organisations that fund broadcasts as part of their outreach programs. There are also terrorist groups who have operated openly on the shortwave bands — for instance, the Aum Shinrikyo (Supreme Truth) which once operated from Japan (see Figure 1 — the station's QSL card which was sent to listeners). Aum Shinrikyo was responsible for the notorious poison gas attack on the Japanese subway system in 1995.

There are also the much speculated about "numbered stations" that have operated

# TET-EMTRON NEW!

## TE-33M THREE ELEMENT TRI-BAND MINI BEAM

If you haven't got the room for a full size three element beam, but you want more gain than the two element TE-23M, then this is for you.

### SPECIFICATIONS

FREQUENCY	14, 21, 28 MHZ BAND
MAX.ELEMENT LENGTH	5520 MM
BOOM LENGTH	4.0 M
GAIN	6 / 6 / 7 DBI
FRONT TO BACK RATIO	20/ 15/ 14 DB
FEED IMPEDANCE	50 OHM
TURNING RADIUS	3.74 M
WEIGHT	12 KG
POWER RATING	2 KW PEP

## RAWMAR ENTERPRISES

40 Blackburn Street,  
STRATFORD,  
Victoria, Australia. 3862

Ph: 61 3 5145 6179  
Fax: 61 3 5145 6821  
Email: rawmar@hotmail.net.au  
ABN: 87404541761

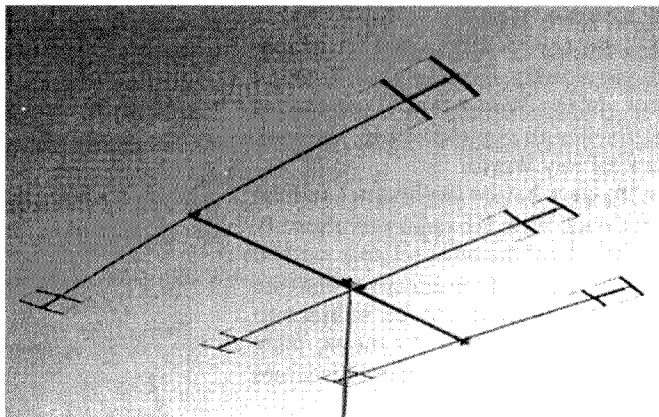

- \*ALL 6000 SERIES ALUMINIUM CONSTRUCTION.
- \*ALL STAINLESS STEEL HARDWARE.
- \*2 KW PEP POWER RATING.
- \*3.74 METER TURNING RADIUS.

### RECOMMENDED RETAIL PRICE

ONLY **\$858** INCL. GST

If you already have a TE-23M, you can purchase the extension kit containing extra boom, director element, and everything you need to upgrade to this antenna.

Complete kit: \$255 incl. GST.

See Website [www.tet-emtron.com](http://www.tet-emtron.com)  
for dealer list.

for decades. These are the stations that suddenly appear on a frequency and in a mono-tone voice, slowly reciting what appears to be random numbers, usually in groups of five digits. There is no station identification and they vanish as suddenly as they appear. These broadcasts can be in languages other than English; Spanish is a recurrent tongue. Anyone schooled in even basic cryptography will immediately recognise five-character groups as a pattern for sending coded messages, whether simple substitution or transposition ciphers or ciphers based on complex mathematical algorithms.

## The Internet

In the age of the email, could people who have trained as terrorists still use converted radio equipment as a realistic method of communication? What is the likelihood that this mode of communication might have in relation to others?

There are many ways to communicate: by telephone, facsimile, telex, and the

Internet (e.g. email, IRC, websites, FTP, etc.). Telephony can take the form of several modes including landline, mobile, and satellite. However, interception of any of these forms of communication is relatively easy for law enforcement agencies, and when a listening device is installed, it is impossible for any counter-surveillance "sweep" to detect it. Therefore secret radio communications is an option.

## Radio Spy Craft

What would be required to communicate via radio between Australia and a terrorist's base of operations overseas as outlined in the Al-Qaida Training Manual?

The initial response is an HF signal. Frequencies above 30 MHz would not be able to communicate beyond a few hundred kilometres (though communication has been established over several thousand kilometres — for instance, stations in Adelaide and Hawaii have made contact, a distance of some

9,000km — but this is an extraordinary occurrence). If the criterion "reliable" is added to the descriptor "worldwide," then frequencies between the 40 m and 15 m bands are the obvious choices.

In fact, frequencies in the various sub-bands within this range would be essential depending on solar activity and the condition of the D, E and F layers of the ionosphere, amongst other factors. For example, the optimum frequency to different parts of the world varies not only season-by-season, but hour-by-hour at different points on the earth. An operator here in Australia would have to consult propagation charts to assess which frequency is best for that time of day.

Accessing this range of frequencies is not difficult, nor is calculating the lowest and maximum usable frequencies a complicated task. Most HF transceivers come standard with transmit and receive functions between 160 m (1.8 MHz) and 10 m (29 MHz). Commercial radios can operate in AM, FM and single sideband

VX-150 2m H/Held

Special Buy

Only \$249.00!

Visit us at

[www.gccomm.com.au](http://www.gccomm.com.au)  
for new product updates!

# G&C

# COMMUNICATIONS

Authorised dealer for • Icom • YAESU • Kenwood • Barrett RFDS • GME Electrophone • Uniden

See us for CAR Stereo too! ~ 'Cranbourne Car Sound'

## ICOM (Australia) TRANSCEIVERS

IC-756 Prof III HF + 6M	\$4,999
IC-7400 HF +6M +2M	\$2,699
IC-7000 NEW! HF-70cm Mob	\$2,299
IC-706MKIIG HF-70cm	\$1,449
IC-718 HF SSB	\$999
IC-910H 2M/70cm Multimode	\$2,499
IC-2720H 2M + 70cm D/Band	\$699
IC-208H 2M + 70cm	\$579
IC-2200H 2M H/Power 'NEW'	\$449
IC-T90A Tri-Band H/Held	\$479
IC-V82 2M @7W H/Held	\$349
IC-P7A New Mini D/Band	\$395

2 YEAR ICOM (Aust.) Warranty!

★ Full Product Range Available! ★

Full range of Communications/Scanner Receivers available from Icom, Uniden, Yaesu \$ POA

## 3.5 ~ 5.7 MHz Base Antennas

Comet CHA 250B HF Vertical	\$699
Diamond CP-6 HF Vertical	\$499

## Antenna Tuners

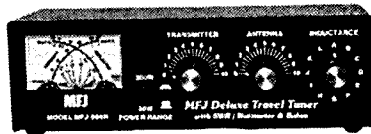

MFJ-902	MFJ-902H
MFJ-904H	MFJ-945E
MFJ-949E	MFJ-929

More Details on Website



## Antenna Rotators

G450A (shown)

G-2800DXC
G-1000DXC
G-800DXA
G-650C
G-450C
G-5500
G-550

## TE series EMTRON HF ANTENNAS

Australia wide orders welcome  
Credit card Cheque Money order

## YAESU Transceivers

FTDX-9000DA Elite HF Base	\$16,499
FT-897D HF - 70cm	\$1,399
FT-857D HF - 70cm	\$1,299
FT-817ND HF - 70cm	\$1,049
FT-8900R Quadband	\$ 799
FT-8800R Dualband	\$ 699
FT-7800R Dualband	\$ 469
FT-1802M 2MT 50Watt	\$ 295
FT-60R Dualband H/H	\$ 369
VX1R w/2 batt Dualband	\$ 249
VX2R Dualband H/H	\$ 329
VX-6R Dual/Band H/Held	\$499
VX-7R Tri-Band H/Held	\$599
VX-170 2M Rugged H/Held	\$279
VR-5000 Receiver	\$1,199
VR-500 H/H Receiver	\$499
VR-120D H/H Receiver	\$ 279

3 YEAR AUSTRALIAN WARRANTY

Call in and see our range of power supplies, cables and connectors

**Comet & Diamond**  
Antennas & Accessories

Proudly Supporting  
Australian Business

207 High St. Cranbourne VIC 3977  
Ph: 03 5996 3298 Fax: 03 5995 0184

Email: [gccomm@bigpond.net.au](mailto:gccomm@bigpond.net.au)  
[www.gccomm.com.au](http://www.gccomm.com.au)

(LSB and USB) modes as well as the classic Morse code (CW). They can also be used in digital modes such as RTTY and PSK. Power output can be from a few watts to a few hundred watts, with worldwide coverage obtainable (reliably) with as little as 100 watts. (In fact, the current system of globally positioned HF beacons on 14.100 MHz enables a terrorist to determine the best frequency to transmit their low-powered signal.)

These radios are about the size of a notebook computer, but require an antenna that is much larger than the home television antenna. If reliable worldwide communication is required, then a simple strand of wire antenna is needed, and probably, a directional antenna with some gain (e.g. two or three element Yagi).

Big antennas are a serious drawback. Many Australian radio operators have made overseas contacts using a random length of wire strung around the radio room, but these are aberrations and could never be considered reliable for worldwide communications.

A random wire or loaded dipole configuration could be installed in the roof space of a suburban home, or disguised amongst trees on a rural homestead, and then used for interstate communications on, say, the 80 m band (but only at night due to the limits imposed by the physics of electro-magnetic propagation characteristic of this frequency). It is safe to say a hidden antenna system like this couldn't be used reliably for communications overseas.

So, could terrorists still use radio equipment as a realistic method of communication?

HF would appear not to be the medium of first choice. The image of WWII secret agents operating from Nazi Occupied Europe, although intriguing, can be discounted — they were operating from distances of several hundred miles, not tens of thousands of kilometres.

Does that mean that radio is out as a system of covert communications? No, not at all — it is always possible to rig-up a system that can be disguised (Many amateurs in retirement villages and apartments do (note 2). And there is still radio communications via satellite!

Even though line of sight VHF and UHF communications can be ruled out, they can be used reliably to make contacts via low earth orbit satellites (As opposed to satellites operating beyond a few hundred kilometres above the earth that require high gain antennas, high power

transceivers and the like. These high gain antennas would call immediate attention to the user.). For instance, I once had a 145 MHz contact with Astronaut Dr Andy Thomas while he was aboard the Russian Mir Space Station and worked Mir's on-board packet radio station in digital mode. Although short, my voice contact was a true "five-by-nine" and the packet contact went perfectly and was long enough to pass a message entered directly from my computer keyboard. Certainly the overpass of a low earth orbit satellite is long enough for two hypothetical terrorist agents to exchange instructions and make reports as to progress (recall that the Al-Qaida Training Manual says voice transmissions should be limited to five minutes). It only takes a garden-variety VHF radio and a UHF radio combination (or a combination of a VHF radio and a UHF scanner, or some such arrangement) and a vertical antenna smaller than a TV antenna.(note 3)

The only limitation with this is the footprint of the satellite — several hundred to a thousand kilometres — far enough to reach Indonesia from the Northern Territory or some other northern part of the country (but unlikely in places like Tasmania/VK7).

But then again, if it was only Indonesia that needed to be reached, an HF radio and a wire antenna is all that might be required, not VHF/UHF satellite. Having said that, it is possible for a relay station to be located in a nearby country, such as Indonesia, and handle the radio traffic for terrorist agents in Australia. But this scenario then presents the problems of increased likelihood of interception with all the dangers that the Allied clandestine radio operators faced during the Second World War, as well as throughout the Cold War.

## Conclusion

So, what is the likelihood that terrorist operatives might be using radio as a means of communication? Well, it is certainly possible. The Al-Qaida Training Manual specifically discusses secret radio communications as a method approved for use by its operatives.

As for the threat posed by these operatives — it too is real. There are international groups in addition to al-Qaida (e.g. Jemaah Islamiyah) that have publicly expressed their desire to cause great harm to Australia — this forms intent. We also know from information

in the public domain that these groups have access to resources and knowledge which would facilitate them carrying out an attack — this forms capability.

Together, intent and capability establishes a threat. How great is this threat to Australia? Well, that is no doubt a classified secret to which only a few government intelligence and enforcement agencies would be privy. Regardless, recent news stories give use some sense of the risk posed by this threat.

Is there a role for amateur radio operators and short wave listeners in the War-on-Terror? I think so. Recall the Australian Government's national security campaign to "Help Protect Australia from Terrorism." This campaign has a website ([www.nationalsecurity.gov.au](http://www.nationalsecurity.gov.au)) and toll free telephone number (1800 123 400) for members of the public who have "small pieces of information..." to pass on ("Be alert, not alarmed").

Radio traffic between stations that bear the hallmarks of a covert terrorist operation could help police and security agencies foil a plot, or help them track down those who have been involved in previous attacks. Remember what Copeland said: "When senders are caught it is usually as the result of tip-offs from suspicious neighbours rather than from successful DF-ing" (p.143). Copeland also stated that "ham radio messages" are a known means of disguising these illicit communications (p.144).

Clearly spy craft is as alive today as it has always been, and terrorist operatives are no doubt using these techniques to threaten Australia's sovereignty. Every piece of information helps secure Australia against foreign threats and amateur radio operators, as well as shortwave listeners, can play a role in helping to protect Australia from terrorism.

## References

- Al-Qa'ida (ND). *Military Studies in the Jihad Against the Tyrants* (informally known as the Al-Qaida Training Manual). London.
- Miles Copland (1974). *The Real Spy World*. London: Weidenfeld and Nicolson.
- Dr Hank Prunckun is a research criminologist specialising in the study of transnational crime — including terrorism. In addition, he holds an Advanced amateur radio operator's licence (VK5JAZ) and a marine VHF radio operator's



licence. He has been awarded the DXCC by the Wireless Institute of Australia for his work in the HF part of the spectrum.

### Notes

1. Morse code was most likely the mode of modulation as this type of transceiver can be much smaller than one that operates by way of radiotelephony. Transporting and concealing a radio transceiver would be highly desirable to avoid attention of the authorities. Also, Morse code insured that no voice recording could be made by the intercepting station that could be later used as evidence. These counter-measures are well noted in the Al-Qaida Training Manual.
2. I once worked a VK amateur station in New South Wales on 80 m HF who had loaded-up his galvanised roof guttering which became his antenna. He claimed to get an SWR of 1:1 through his ATU and my log shows he was a five-by-nine signal at my QTH in VK5. His antenna would have been completely "invisible" to his neighbours — there would have been no obvious sign of him operating a radio station at all. Nevertheless, this type of system would be very difficult to explain to police if the operator was a suspected terrorist operative and it is not an easy system to disassemble in a hurry if a police raid is imminent.
3. With satellite communications, a covert operative could hypothetically operate from a car using a dual-band — 2 m and 70 cm — antenna mounted on the roof and drive from location to location. This set-up would not attract suspicion as mobile radios are omnipresent, especially amongst the 4-wheel drive community. No one would know that the operator was communicating through a satellite would simply take him/her for a CBer chatting with their "buddy."

ar

### Editor's Note

Probably the most famous of the one way coded messages was "*Blessent mon cœur d'une langueur monotone*" (wound my heart with a monotonous langour). This indicated that D-Day had arrived. The Resistance immediately undertook major sabotage of German communications and transport.

## Over to you

### Broadband over Power Lines

I have held my licence and call sign continuously since 1947. During that time I have observed threats to the very existence of Amateur Radio, but none has worried me more than that of BPL.

Having worked in radio broadcasting in the Post Master General's department for many years, I and most radio amateurs are well aware that BPL is a very bad technology. Big corporations want to make it a reality regardless of what other forms of communications will be disrupted.

Once established, they will not just draw the line at 90 MHz of the spectrum. When that section is saturated they will simply apply for more. They see only profit - nothing else matters. Amateur Radio, essential services and the military will all be affected eventually, once it is allowed to be established. Then it will be too late to change it.

Where BPL is being trialled it is

being demonstrated that interference is widespread. That will surely engender complaints by BPL users and their providers into the media and to the attention of ACMA to hopefully bring about a debate and inform the general public just what a poor technology BPL is.

If it gets a toe hold, it will spread like wild fire and ACMA will come under political pressure to look the other way and allow licensing of BPL. The potential to make profits is reason enough to drown all else in its path regardless of all its undesirable consequences.

My belief is the WIA should urge ACMA and members of parliament to object to the introduction of BPL.

We should inform the general public, politicians and other officials as to just what havoc it will bring to all radio communication.

Peter VK4PO

### CW on VHF/UHF Repeaters?

It seems odd that some VHF and UHF repeater IDs are still transmitted using Morse Code rather than using a pre-recorded or synthesized voice. Recent developments in Australian amateur licensing have seen the Morse requirement abandoned all together.

Therefore, as there is now a growing number of amateur operators who do not have Morse as a skill, it seems pointless that such an ID system still operates. It could be argued that a large number of repeater users (perhaps the majority?)

have no idea what these dits-and-dahs mean and therefore a Morse ID serves little utility. One could even say that it was always odd that Morse was used for repeater IDs because there was no requirement for Morse proficiency testing above 30 MHz.

So, is the time right for repeater owners and operators to change over to voice IDs? The answer seems clear to me...

Hank VK5JAZ

## Silent key

### Tim Chen, BV2A, founder of CTARL

Our Charter President Tim Chen, BV2A, passed away at the Taipei Veterans General Hospital on 22nd February 2006, aged 92 years. Tim founded the first amateur station of BV.

Tim was admitted to the intensive care unit on the eve of Chinese New Year, 28th January, due to the deterioration of his condition (colon cancer). He was due to be transferred to a hospice for further care but passed away before this occurred.

His family members were present at the time.

The funeral took place on 28th February at the Hwai-Yuan Hall, Taipei Veterans General Hospital in Shihpai, Taipei.

You may send messages to [bv2a@ctarl.org.tw](mailto:bv2a@ctarl.org.tw). The HQ of CTARL (Chinese Taipei Amateur Radio League) will forward the messages to Tim's family.

CTARL 25th February 2006  
Bolton Lin, M.D., BV5AF

**Adelaide-Auckland****104****Brisbane-London****327**

second 2F12-15 2E Short 3241 km

First F 0-5 Long 23498 km

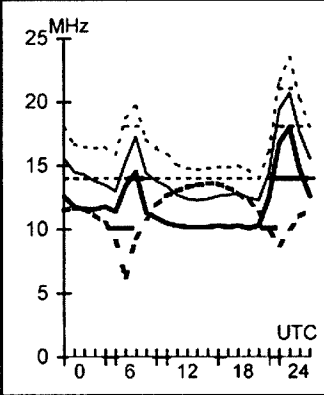
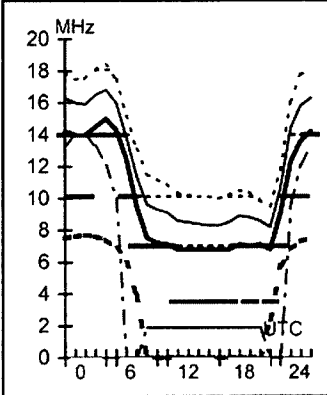
**May 2006**

T index: 15

**Legend**

Frequency scale

UD

F-MUF

OMF

E-MUF

ALF

-&gt;10%

-&gt;50%

-&gt;90%

Time Scale

**HF Predictions**by **Evan Jarman VK3ANI**  
34 Alandale Court Blackburn Vic 3130

These graphs show the predicted diurnal variation of key frequencies for the nominated circuits.

These frequencies as identified in the legend are:-

- Upper Decile (F-layer)
- F-layer Maximum Usable Frequency
- E-layer Maximum Usable Frequency
- Optimum Working Frequency (F-layer)
- Absorption Limiting Frequency (D region)

Shown hourly are the highest frequency amateur bands in ranges between these key frequencies, when usable. The path, propagation mode and Australian terminal bearing are also given for each circuit.

These predictions were made with the Ionospheric Prediction Service program: ASAPS Version 4

**Adelaide-Cairo****288****Brisbane-London****327****Canberra-Moscow****317****Darwin-Manila****340**

First F 0-5 Short 13332 km

First F 0-5 Short 16526 km

First F 0-5 Short 14481 km

Second 4F7-14 4E0 Short 3196 km

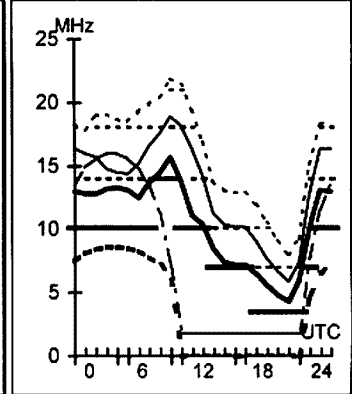
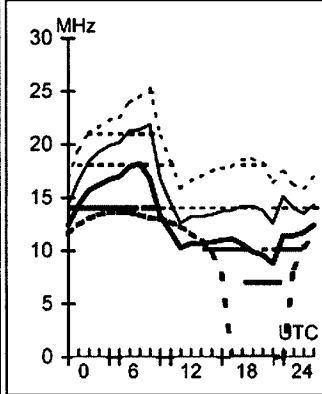
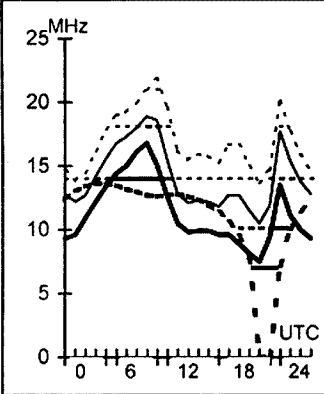
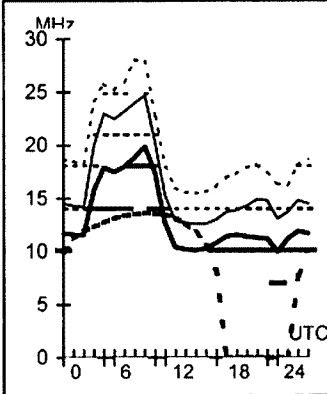
**Adelaide-Honolulu****57****Brisbane-Ottawa****52****Canberra-New Delhi****303****Darwin-Santiago****157**

Second 4F6-10 4E0 Short 9160 km

First F 0-5 Short 15308 km

Second 4F4-8 4E0 Short 10347 km

First F 0-5 Short 14422 km

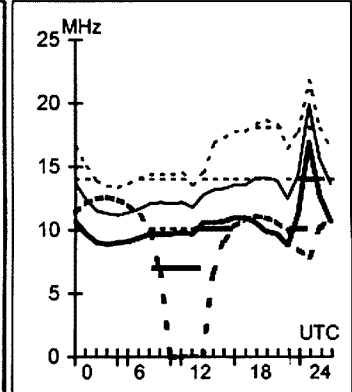
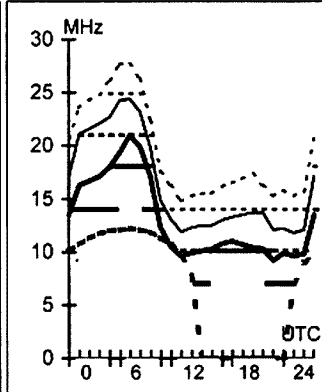
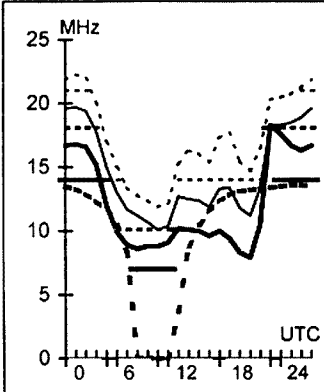
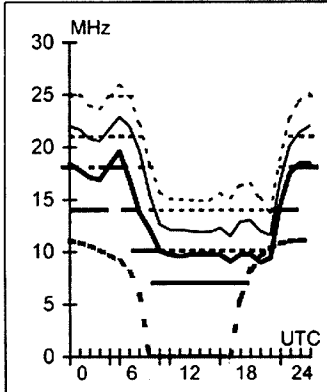
**Adelaide-New York****67****Brisbane-Tokyo****348****Canberra-Seattle****48****Darwin-Seoul****355**

First F 0-5 Short 17092 km

Second 3F6-10 3E0 Short 7159 km

First F 0-5 Short 12709 km

Second 3F10-16 3E Short 9575 km

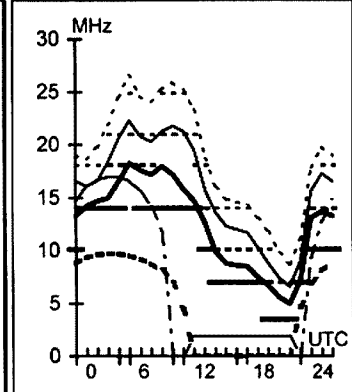
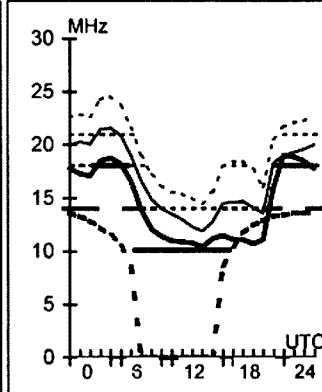
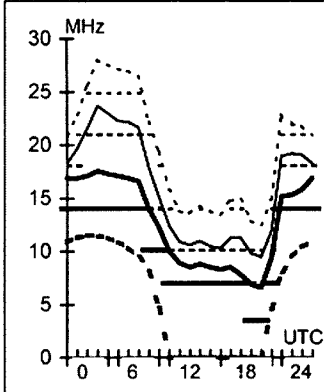
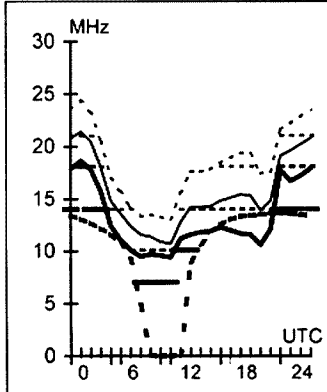

**Hobart-Barbados**

First F 0-5 Short 15825 km

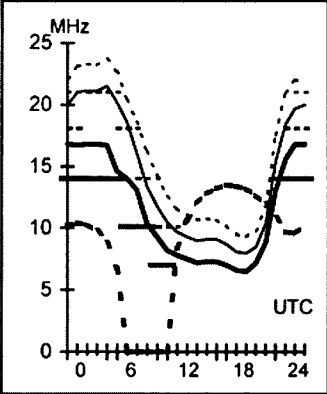
**134 Melbourne-Capetown**

Second 4F4-5 4E0 Short 10318 km

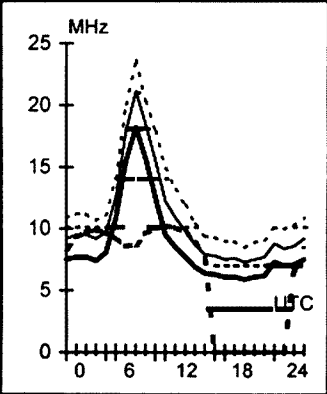
**222 Perth-Buenos Aires**

First F 0-5 Short 12591 km

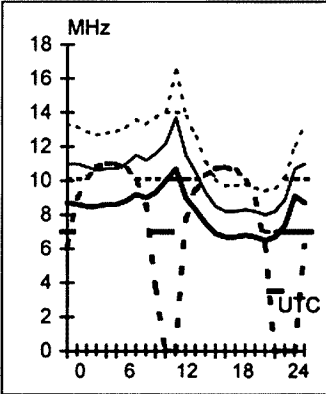
**185 Sydney-Budapest**

First F 0-5 Short 15779 km

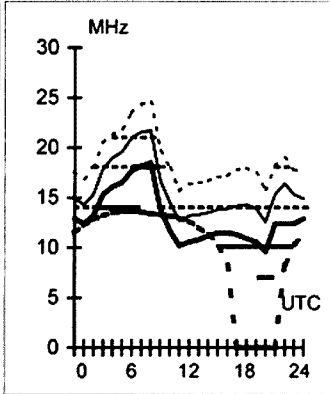
**Hobart-Lima**

First F 0-5 Short 12421 km

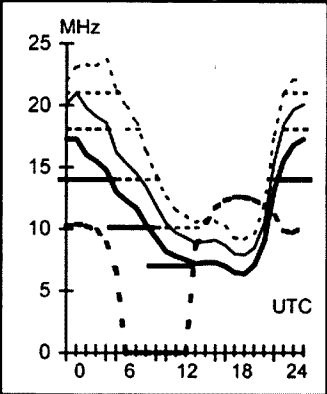
**133 Melbourne-Miami**

First F 0-5 Short 15584 km

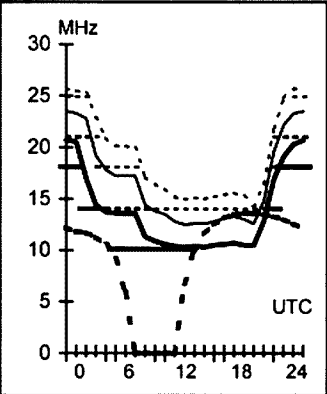
**94 Perth-Colombo**

Second 3F9-13 3E1 Short 5768 km

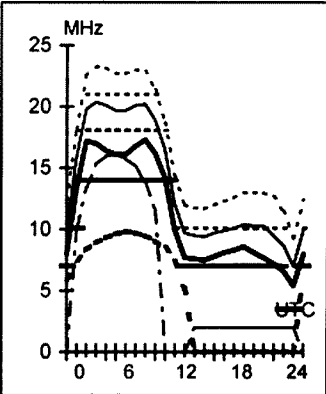
**312 Sydney-Chicago**

First F 0-5 Short 14875 km

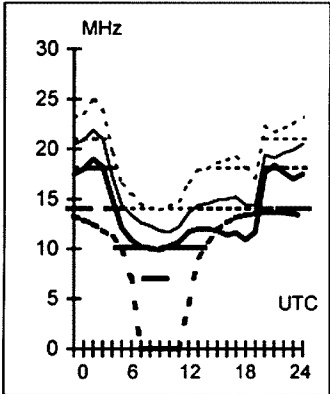
**Hobart-London**

Short Long 22620 km

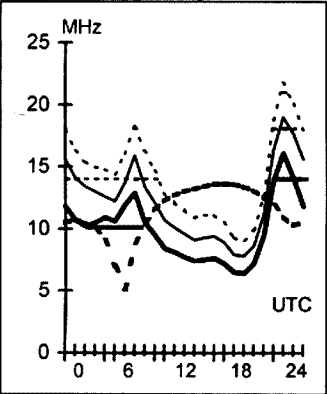
**123 Melbourne-Senegal**

First F 0-5 Short 16910 km

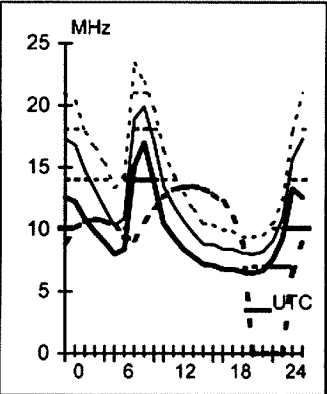
**219 Perth-Osaka**

Second 3F4-8 3E0 Short 7684 km

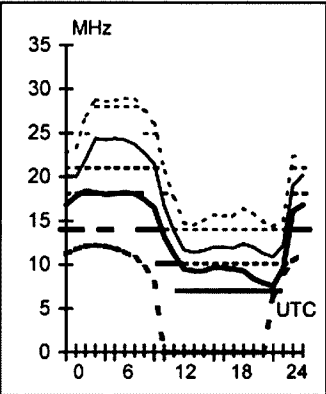
**17 Sydney-Jakarta**

First F 0-5 Short 5498 km

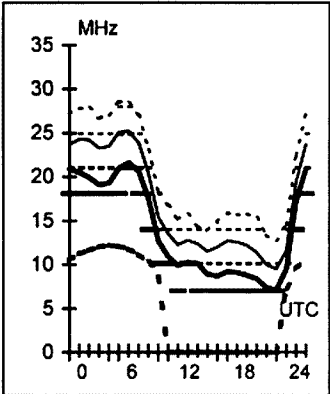
**Hobart-London**

First F 0-5 Short 17404 km

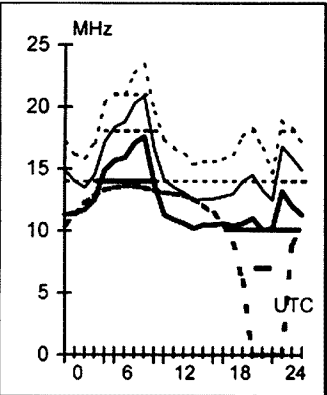
**303 Melbourne-Suva**

Second 2F9-11 2E0 Short 39144 km

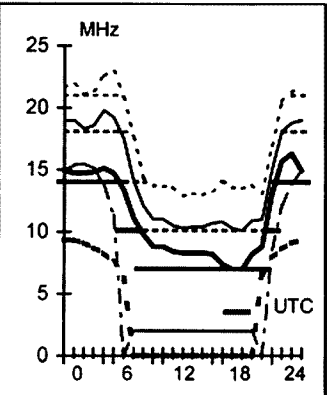
**65 Perth-Wellington**

Second 3F11-12 3E Short 5255 km

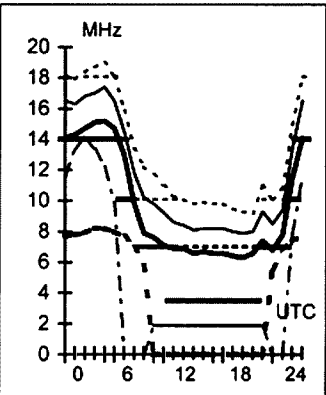
**119 Sydney-Pretoria**

Second 4F3-4 4E0 Short 11063 km

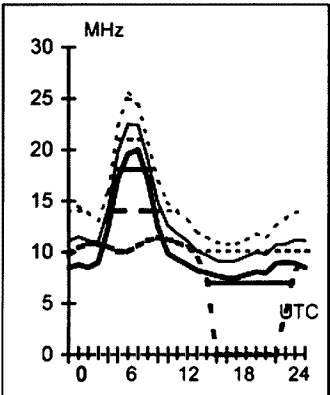

# Hamads classifieds **FREE**

## FOR SALE NSW

• 70 cm 32 el antenna, 2 m 16 el antenna, 6 m 5 el antenna, all with double driven dipoles high quality build. Get them down, take them away, free. VK2QP 02 9451 0818

• AMF 122 set in near original condition plus 1945 handbook in near new condition, \$350 ono. VK2ARF QTHR 02 94401212, 0417 443 414.

• Aluminium Dish 1.25 m, white in colour, no damage. Good for microwave experiments. Pick up only. \$50 Pennant Hills, NSW VK2JCC 98752191 (has voiceMail).

• KENWOOD TS-520S HF transceiver, KENWOOD TS-120V, SM-220 station monitor, KENWOOD TR-2000. 2m transceiver, KENWOOD VFO-3G external VFO, EA digital capacitance meter, BELCO audio signal generator MG-10D sine/squarewave 0 to 2000 kHz, LEADER TR dip meter LDM-815, MICRONTA 3 range SWR/ power meter 10, 100, 1000 watt, and telereader. All items in good working order and look great. All offers invited to Jim 02 9576 5237 or email to vk2gps@hotmail.com.

• ICOM IC-706 MKII HF/VHF transceiver, excellent cond, with 240 volt KENWOOD p/ supply, EAT-300 manual ant tuner, all options, portable cables etc \$1350 ono. Doug VK2DDR. Contact Greg 0419 243 927

## WANTED NSW

• DICK SMITH'S CB Radio Handbook. Good to excellent condition preferred. Any reasonable price. Contact VK2WN (Ross). QTHR. Phone: (02) 6889 4436 or rossfra@bigpond.com.au.

• FT-530 Bottom Cover (BC-1) and FT-530 Battery Case for 6 AA Size Dry Cells (FBA-12)

and copy of FT530 Operator's Quick Reference Card. Errol Trimmingham VK2BET. email errol.trimmingham@bigpond.com, phone 02 9476 2933

## WANTED VIC

• A complete probe or diode to suit HEWLETT PACKARD 410 c voltmeter, probe type 11036A, diode type EA53. Ray VK3RD 03 9726 9222, email deanray@alphalink.com.au.

• Tuning heads for RDO receiver, labelled TN-2B serial number #190. TN-3B serial number #224. I am looking for these tuning heads because I have the calibration charts for them. Phone Brad 03 9873 7127

## WANTED QLD

• Service manual (or copy) for KENWOOD station monitor model SM-220. All costs refunded. Gwen VK4CB QTHR 07 3202 7137

• 2 metre 6 Cavity Duplexer for the South Coast Amateur Radio Group, frequency used 147.8 MHZ RX 147.2 TX Must be in good condition. Please make contact if you can help us find the above. Email dimples1@qldnet.com.au

• DAIWA CNA-2002 HF auto antenna tuner manual. Contact John vk4jkl@wia.org.au ph 07 4053 3137 QTHR

## THE WIA QSL COLLECTION REQUIRES QSLs

All types welcome, especially rare DX pictorial cards, special issue. Please contact the Hon Curator, Ken Matchett VK3TL, 4 Sunrise Hill Road, Montrose Vic 3765, tel. (03) 9728 5350

## About hamads....

- Hamads may be submitted by email (preferred) or on the form on the reverse of your current Amateur Radio address flysheet. Please print carefully and clearly, use upper AND lower case.
- Separate forms for For Sale and Wanted Items. Please include name, address STD telephone number and WIA membership number if you do not use the flysheet.
- Deceased estates Hamads will be published in full, even if the ad is not fully radio equipment.
- WIA policy recommends that the serial number of all equipment for sale should be included.
- QTHR means the address is correct in the current

WIA Call Book.

- Ordinary Hamads from those who are deemed to be in general electronics retail and wholesale distributive trades should be certified as referring only to private articles not being re-sold for merchandising purposes.
- Commercial advertising (Trade Hamads) are pre-payable at \$25.00 for four lines (twenty words), plus \$2.25 per line (or part thereof), Forty word maximum, minimum charge of \$25.00. Cheques are to be made out to: WIA Hamads.
- Copy typed or printed clearly please, and received by the deadlines shown on page 1 of each issue of Amateur Radio.

Email: [newunltd@bigpond.net.au](mailto:newunltd@bigpond.net.au)

Postal: Newsletters Unlimited, PO Box 431, Monbulk Vic 3793. Fax: 03 9756 7031

### TRADE PRACTICES ACT

It is impossible for us to ensure that the advertisements submitted for publication comply with the Trade Practices Act 1974. Therefore, advertisers and advertising agents will appreciate the absolute need for themselves to ensure that the provisions of the Act are strictly complied with.

### VICTORIAN CONSUMER AFFAIRS ACT

All advertisers are advised that advertisements containing only a PO Box number as the address cannot be accepted without the addition of the business address of the box-holder or seller of the goods.

## VKHAM.COM AUSTRALIAN AMATEUR RADIO

Hundreds of pages and links related to Amateur Radio and radio in general

Home of:

- VK Classifieds
- VK Auctions
- VK's on the Internet

Repeater Maps, Software, Prefix Maps and more ...

*"Hey, Old Timer..."*



If you have been licensed for more than 25 years you are invited to join the **Radio Amateurs Old Timers Club Australia**

or if you have been licensed for less than 25 but more than ten years, you are invited to become an Associate Member of the RAOTC.

In either case a \$5.00 joining fee plus \$8.00 for one year or \$15.00 for two years gets you two interesting OTN Journals a year plus good fellowship.

Write to

RAOTC,  
PO Box 107  
Mentone VIC 3194

or call Arthur VK3VQ on 03 9598 4262 or Bill VK3BR on 03 9584 9512, or email to raotc@raotc.org.au for an application form.

## ADVERTISERS INDEX

AEI.....	12
Amateur Radio Bookshop.....	39
Andrews.....	8
Benelec.....	IFC
Com-an-tena.....	16
TET-Emtron.....	48
G & C.....	49
Icom.....	OBC
Ozgear.....	9
Rippletech.....	55
TTS.....	22
Small ads.....	55
ARI.....	18
KVK Books.....	12
Winlink.....	23
www.vk3ajj.com.....	55

## Need a 'rare spare'

Or perhaps a manual for a piece of gear from a long departed manufacturer.

Maybe you need a valve, or perhaps a back copy of a radio magazine.

Let Hamads help you find it, our **WANTED** ads are read by the people most likely to have what you need.

Email:

[newunltd@bigpond.net.au](mailto:newunltd@bigpond.net.au)

## Rippletech Electronics

New to radio or perhaps need a new challenge? Want to earn the WIA's new 5BDXCC award? With a Nally tower, an 80m sloper and a 40m rotary dipole you can get low band DXCC, even from your city lot! Want DXCC on the WARC bands? The WARC band dipole on placed above your traditional tribander will get you there.

Like to travel with your new micro radio? Grab a TZ-V-3 which packs down to only 1m long, fits in the boot or on a plane & assembles in minutes. Outperforms lossy super wideband designs.

TZ-1840	1:1 1kW 160-10m Balun (1.8- 40 MHz)	\$ 59.00
TZ-330-4	4:1 1 kW HF Balun (3 - 30 MHz)	\$ 59.00
TZ-SL8	80m Sloper (use tuner for 17 & 30m)	\$ 99.00
TZ-SL16	160m Sloper (fits in a suburban lot!)	\$ 110.00
TZ-D-4080	40m/80m Trapped Wire Dipole	\$ 176.00
TZ-V-3	10/15/20m Trapped Vertical	\$ 189.00
TZ-V-4	10/15/20/40m Trapped Vertical	\$ 289.00
TZ-RD-3	10/15/20m Trapped Rotary Dipole	\$ 199.00
	Vertical Radial kits (1 rad. per band)	\$ 33.00
TZ-V-3w	12/17/30m Trapped Vertical	\$ 279.00
TZ-RD-3w	12/17/30m Trapped Rotary Dipole	\$ 289.00
TZ-RD-40	17/40m or 20/40m Rotary Dipole	\$ 279.00
TZ-1000RC	FT-1000mp remote controller acc	\$ 33.00
	5th Order HPF TVI Filter (coming)	\$ 39.00
	Mobile whip base & Z bracket combo	\$ 11.00

Our trapped antennas use high Q, high isolation coaxial traps which are fully sealed and exhibit 40 dB of isolation at the resonance.

Need something special?

Give me a call and we'll see if we can meet your needs.

[www.rippletech.com.au](http://www.rippletech.com.au)

Contact Tony - VK3TZ  
0402 622 562 or email  
[sales@rippletech.com.au](mailto:sales@rippletech.com.au)

Mastercard, Visa and Bankcard accepted

## WWW.RADIOSPECIALISTS.COM.AU

Yaesu authorized Dealership in Adelaide

**Shopfront sales and not a backyard shed**

243 Seacombe Road South Brighton SA  
**The Radio Specialists serving Adelaide.**

## AMIDON FERROMAGNETIC CORES

For all RF/electronic applications

See our website for complete data on all cores including prices.

[www.catchnet.com.au/~rjandusimports](http://www.catchnet.com.au/~rjandusimports)

**RJ & US Imports**

PO Box 431, Kiama NSW 2533.

A 3.5" PC disk containing all data is available for \$5.00 incl. post.

### Agencies

Active Electronics, Tas  
TTS Systems, Tyabb (VIC)  
Tower Communications, Perth  
Ozhelp Services, Brisbane

## RM Products Italy

are now available in Australia after the appointment of

**Hamak Electrical Industries Pty Ltd**

as distributor for RM products

Visit the Hamak website at

[Hamak.com.au](http://Hamak.com.au) for

**Linear amplifiers,  
Power supplies  
and accessories**



## JACKSON BROS JACKSOO OF THE UK IS SACK

Highest quality products made by UK craftsmen

[www.jacksonbrothers.com.au](http://www.jacksonbrothers.com.au)

Full range now off-the-shelf in Australia.

Variable and trimmer capacitors, reduction drives, dials, ceramic standoffs

**CATALOGUES, PRICE LISTS AVAILABLE**

**CHARLES I COOKSON PTY LTD**

11-13 Port Rd  
Queenstown SA 5014

Tel: (08) 8240 3200

Fax: (08) 8240 3233

FreeFax 1800 673355 within Australia

Email: [sales@jacksonbrothers.com.au](mailto:sales@jacksonbrothers.com.au)

**ALL MAJOR CREDIT CARDS ACCEPTED  
SOLE AGENTS AUSTRALIA AND NEW ZEALAND**



## Tunable Loop Antenna enhances AM Reception

AM radio reception (530 to 1900KHz) enhanced. Reception where none existed before; works indoors, even in interference-polluted areas

High value — low cost.

Simple, no connections or batteries

Ideal for touring, caravan, boat and fringe areas. Use anywhere.

[www.amradioantennas.com](http://www.amradioantennas.com)

[pkloops@bigpond.net.au](mailto:pkloops@bigpond.net.au)

Paul 0412 302 939

**PK's Loop Antennas**

## RADIOS:

	Unused	Used
Icom 706MK2G	Ring/email	\$1199
Icom 208H	\$ 550	\$ 499
Icom 910H	\$2199	\$1799
Icom 746PRO	N/A	\$1899
Icom 756PRO2	N/A	\$2799
Icom 756PRO3	\$4399	\$4099
Icom 775DSP	\$N/A	\$3599
Icom 718	N/A	\$799
Icom V82/U82 H/H	\$899	\$799
Kenwood TS2000	\$N/A	\$2199
Kenwood TS2000X	N/A	\$2799
Kenwood TS480SAT	\$1699	\$1499
Kenwood TS480HX	\$1899	\$1699
Kenwood TS570DG	N/A	\$1249
Kenwood TMD700A	\$ 849	\$ 799
Kenwood THD7A	\$ 599	\$ 549
Yaesu FT8900R	\$ 649	N/A
Yaesu FT847	N/A	\$1899
Yaesu FT857D	\$1249	\$1149
Yaesu FT100D	N/A	\$1099

Plus plenty more radios in stock

## ACCESSORIES:

Doss 40 AMP PSU	\$ 235	N/A
Icom AH4 ATU	\$ 499	\$ 449
Icom AT180	N/A	\$ 549
Tokyo HL700B HF Amp	\$1599	
MFJ 993 ATU	\$449	
Icom UX910 23cm Board	\$699	

Call / email re Heil and MFJ products

**DOA warranty applicable on all items (ie if it is not 100% and in condx as described, a full money back g'tee applies)**

**OTHER CURRENT MODELS AVAILABLE**

**ALL USED GEAR IN EXC CONDX WITH ORIGINAL BOX AND ACCESSORIES**

**PRICES SUBJECT TO CHANGE - CHECK WEBSITE FOR LATEST (OR RING)**

**WILL CONSIDER TRADE-INS - BUT MUST BE CURRENT MODEL GEAR (IE LAST 10 YEARS)**

Ship anywhere in VK/ZL (freight extra)

**ORDER ONLINE AT**

**WWW.VK3AJJ.COM**

**OR TELEPHONE PAUL ~**

**(03) 9018 9757**

**Mob. 0410 093 759**

**vk3ajj@iinet.net.au**

**NB - I am not an authorised dealer for the radio companies listed above.**

**These companies may refuse service on equipment sold by me - but other servicing options are available in the VK market.**

Licensed Second Hand Dealer NO 10229 (Vic) (E&OE)

**WWW.VK3AJJ.COM - giving Aussie Hams a FAIR GO!**



# Directory

## The Amateur Service:

a radio communications service for the purpose of self training, intercommunication and technical investigation carried out by amateurs, that is, by duly authorised persons interested in radio technique with a personal aim and without any pecuniary interest. 1.56 ITU Radio Regulations.

The Wireless Institute of Australia represents the interests of all amateurs throughout Australia.

WIA membership fees are: ★ \$ 75 for full members ( F grade ), ★ \$ 70 for pensioners and students ( G and S grade ), and ★ \$ 50 for membership without 'Amateur Radio' ( X grade ). Payment direct to National office.

National Office	Contact	News Bulletin Schedule
10/229 Balaclava Road, Caulfield North VIC 3161, PO Box 2175 Caulfield Junction Vic 3161 Australia	Phone 03 9528 5962, Fax 03 9523 8191, 10am to 4pm daily, nationaloffice@wia.org.au http://www.wia.org.au	Subject to change. See <a href="http://www.wia.org.au">www.wia.org.au</a> follow National News prompts. Contact <a href="mailto:nationalnews@wia.org.au">nationalnews@wia.org.au</a> National VK1WIA news is distributed to all states.

Advisory Committees	Contact	News Bulletin Schedule
<b>VK1 Australian Capital Territory</b> VK1WX Alan Hawes VK1ZPL Phil Longworth VK1ET John Woolner VK1GH Gil Hughes	<a href="mailto:vk1advisory@wia.org.au">vk1advisory@wia.org.au</a>	Sundays at 11.00 am VK1WIA 7.128, 146.950, 438.050 Canberra Region Amateur Radio Club Email newsletter will be sent on request to <a href="mailto:president@vk1.ampr.org">president@vk1.ampr.org</a>
<b>VK2 New South Wales</b> VK2QV Chris Flak VK2XCD Chris Devery VK2BFN Adrian Clout	Phone 02 9689 2417 <a href="mailto:vk2wi@ozemail.com.au">vk2wi@ozemail.com.au</a> <a href="mailto:vk2advisory@wia.org.au">vk2advisory@wia.org.au</a>	VK2WI - Sunday 1000 and 1930 hours local. 1.845; 3.595; 7.146; 10.125; 14.170; 28.320, 52.525; 145.600; 147.000; 438.525; 1273.500 megahertz. Plus regional relays. VK1WIA news included in the morning
<b>VK3 Victoria</b> VK3JJB John Brown VK3PC Jim Linton VK3APO Peter Mill	Phone 03 9885 9261 <a href="mailto:arv@amateurradio.com.au">arv@amateurradio.com.au</a>	VK1WIA, Sunday 11am and 8pm, 3.615 and 7.085 (LSB), 10.130 (USB), VK3RML 146.700, VK3RMM 147.250, VK3RMU 438.075.
<b>VK4 Queensland</b> VK4BY Don Wilchefski VK4ZZ Gavin Reibelt VK4KF Ken Fuller	Phone 07 3221 9377 <a href="mailto:vk4advisory@wia.org.au">vk4advisory@wia.org.au</a>	VK1WIA, Sunday 9.0am via HF and major VHF/UHF rpters
<b>VK5 South Australia and Northern Territory</b> VK5OV David Box VK5APR Peter Reichelt VK5ATQ Trevor Quick	Phone 08 8294 2992 <a href="mailto:boxesdnm@lm.net.au">boxesdnm@lm.net.au</a> <a href="mailto:peter.reichelt@bigpond.com">peter.reichelt@bigpond.com</a> <a href="mailto:vk5advisory@wia.org.au">vk5advisory@wia.org.au</a>	VK5WI: 1843 kHz AM, 3.550 MHz LSB, 7.095 AM, 14.175 USB, 28.470 USB, 53.100 FM, 147.000 FM Adelaide, 146.800 FM Mildura, 146.900 FM South East, 146.925 FM Central North, 438.475 FM Adelaide North, ATV Ch 35 579.250 Adelaide. (NT) 3.555 LSB, 7.065 LSB, 10.125 USB, 146.700 FM, 0900 hrs Sunday. The repeat of the broadcast occurs Monday Nights at 1930hrs on 3585kHz and 146.675 MHz FM. The broadcast is available in 'Realaudio' format from the website at <a href="http://www.sant.wia.org.au">www.sant.wia.org.au</a> Broadcast Page area.
<b>VK6 Western Australia</b> VK6NE Neil Penfold VK6XV Roy Watkins VK6QO Bruce Hedland-Thomas	Phone 08 9351 8873 <a href="http://www.vk6.net/">http://www.vk6.net/</a> <a href="mailto:vk6advisory@wia.org.au">vk6advisory@wia.org.au</a> <a href="mailto:vk6ne@upnaway.com">vk6ne@upnaway.com</a> <a href="mailto:vk6xv@bigpond.net.au">vk6xv@bigpond.net.au</a>	VK6WIA: 146.700 FM(R) Perth at 0930hrs Sunday relayed on 1.865, 3.564, 7.075, 10.125, 14.116, 14.175, 21.185, 29.120 FM, 50.150 and 438.525 MHz, Country relays 3.582, 147.200 (R) Cataby, 147.350 (R) Busselton, 146.900 (R) Mt William (Bunbury). 147.000 (R) Katanning and 147.250 (R) Mt Saddleback. Broadcast repeated on 146.700 at 1900 hrs Sunday relayed on 1.865, 3.564 and 438.525 MHz : oountry relays on 146.900, 147.000, 147.200, 147.250 and 147.350 MHz..Also in "Realaudio" format from the VK6 WIA website
<b>VK7 Tasmania</b> VK7ZAX Phil Corby VK7DG Dale Barnes VK7KK Reg Emmett	Phone 03 6234 3553 <a href="mailto:vk7advisory@wia.org.au">vk7advisory@wia.org.au</a> <a href="mailto:phil.corby@tassie.net.au">phil.corby@tassie.net.au</a> <a href="mailto:vk7dg@wia.org.au">vk7dg@wia.org.au</a> <a href="mailto:regemm@ozemail.com.au">regemm@ozemail.com.au</a>	VK1WIA Sunday 9am on VK7WI network: 3.570MHz LSB, 146.700 MHz FM (VK7RHT South), 53.825MHz FM (VK7RAD South), 147.000MHz FM (VK7RAA North), 146.750 FM & 53.825MHz (VK7RNW North West), 146.625 MHz FM (VK7RMD North West), UHF CB Channel 15 (Hobart) and 27MHz CB - 27.225MHz LSB (Hobart). Followed at 9:30am with VK7 Regional News Broadcast also on 7.090MHz LSB & 14.130MHz USB

### Notes

1. Only three members of the state advisory committees are listed.
2. All listings are preliminary. They will be updated each month as required.
3. Membership application forms are available from the WIA web site [www.wia.org.au](http://www.wia.org.au) or the national office address above.

# GAMES QSLs



## Commonwealth Games QSL cards.

These cards are drafts showing the style to be used for the QSL cards for the commemorative callsigns. The cards will be doubled sided with full colour images adorning the front, the back will explain the special event callsigns and space for the contact details.

At least two and possibly four different cards will be printed for each callsign



see more  
pictures  
and story  
on page 23

# ICOM's price break through

## most affordable prices ever



### IC-7000

HF/VHF/UHF All mode Transceiver • 100W HF/50MHz, 50W/2m, 35W/70cm • I.F DSP for improved noise rejection • Digital IF filter for Dial up selectivity • 2.5" TFT colour display for bright easy reading • Remote control DTMF Mic for fingertip control & IRLP access PLUS • digital voice storage • 2 mode band scope • Multi function meter 7 SWR display • Built in RTTY modulator

**NEW**



### IC-756PRO III

HF\*6m • Sharp & soft IF filter shape • New receiver gives +30dBm third-order intercept point • One-touch record/play • Digital voice memory • Extended 1/4 Tuning step & BPF functions for SSB-D mode • 32-bit floating-point DSP and 24-bit AD/DA converter • SSB/CW synchronous tuning • 5-inch colour TFT LCD • Built-in antenna tuner • Customisable filter shape • No optional filters to buy



### IC-7800

HF\*6m • Four 32-bit floating point DSP units • +40dBm ultra high intercept point • Automatic tracking pre-selector • Two completely independent receiver circuits • 200W output power at full duty • Ultra high frequency stability • 7-inch wide color TFT LCD • Multi function spectrum scope • RTTY / PSK31 operation without PC connection • Professional 6m receiver • Digital Voice Recorder • CF memory card.



### IC-2200H

• VHigh (65W) Power Output • DTCS & CTCSS Tone Squelch • DTMF Encode & Decode (with optional UT108) • Digital Voice & Data Communication (with optional UT118) • 207 Alphanumeric Memories

### IC-P7A

VHF/UHF (2m/70cm) Dual-band FM Handheld Transceiver • Ultra compact body, light weight 47x81x28mm, 160g • Mini-power VHF/UHF dual bander with wideband receiver 0.495-999.990MHz • 1800mAh large capacity Li-Ion battery allows 20hours operating time (Tx:Rx:Standby=5:5:90) • 1.5W output power on 2m & 1W output power on 70cm • Simple operation • 1000 memory channels with flexible memory bank system • Oversize LCD for clear display of function information



### IC-T90A

A new 5W Triband handheld • VHF/UHF FM 2M, 6M, & 70CM Wideband receive 495KHz - 1GHz 555 Alphanumeric memories • 13 Scan modes DTCS & CTCSS encode & decode DTMF encoder (10 memories) Wide/narrow transmit capability.

Amateur

**NEW**

**ICOM**

ICOM B4

Call your local ICOM dealer [www.icom.net.au](http://www.icom.net.au) or (03) 9549 7500



# Amateur Radio



Volume 74 no 6  
June 2006



The magazine for **AUSTRALIAN** radio amateurs

**\$6.50**  
incl GST

**Bill Roper**  
**VK3BR**

**WIA**  
**Life**  
**Member**

*plus*

**UHF aerial  
analysers, and  
Wheatstone's  
wonderful bridge**  
★  
**Portable operation  
on 160 m**



# BENELEC

# YAesu

## A Portable for All Situations.....

## ... with a BONUS!

**VX-2**



2m / 70cm  
**\$343.20**

**FT-60**



2m / 6m / 70cm  
**\$375.90**

**VX-7**



6m / 2m / 70cm  
**\$695.00**

**VX-6**



2m / 70cm  
**508.00**

**VX-170**



2m  
**\$290.80**

**FREE**  
Soft Hook Ear Plug  
with inline Mike & PTT



**Value \$68.00**

**FREE**  
Speaker Mike  
with CT91



**Value \$68.00**  
Speaker Mike  
with CT91



**Special Offer**

## Ideal Foundation Licence Radio Options

**FT-817**



**Now includes FNB72 Internal Battery**

- Ultra Compact 135 x 38 x 165mm
- All Mode Portable Transceiver
- 160 - 10m / 6m / 2m / 70cm
- 0.5-5 Watts Selectable

**Price \$ 1,167.00**

**UHV-4 Quad Band 1.39m 10/6m**

**Free with FT-817**

**Value \$194.00**

**ATAS25**

**Manual Tune Antenna**

**Frequency Range:**

7/14/21/28/50/144/430MHz  
Amateur Bands

**Maximum Input Power:**

HF/50 MHz band: 100 Watts  
(SSB/CW mode, 50% duty);  
50 Watts (AM/FM modes)  
144/430 MHz band: 50 Watts  
(all modes)

**Suitable for FT817ND**

**\$503.28**

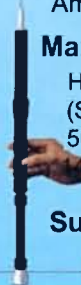

**ATAS120a**

**Auto Tune Antenna**

**Frequency Range:**

7/14/21/28/50/144/430MHz  
Amateur Bands

**Maximum Input Power:**

120 Watts (A3J)

**Suitable for FT897D & FT857D**

**\$701.69**



**Benelec Approved Amateur Transceiver Dealers**

**All Price includes GST**

**NSW**

**Andrews Communications Systems**

Tel: 02 9636 9060 lee.andrews1@bigpond.com

**Newcastle Pro Sound & Communications**

Tel: 02 4965 6899 sales@newcastleprosund.com.au

**Action Communications**

Tel: 02 4732 2788 action@pnc.com.au

**VIC**

**Strictly Ham P/L**

Tel: 03 9729 7656

vk3my@bigpond.net.au

**G & C Communications**

Tel: 03 5996 3298

gccomm@bigpond.net.au

**Qld**

**Kyle Communications**

Tel: 07 3857 4400

mark@kyle.com.au

**Ozhelp Services**

Tel: 07 3273 7263

sales@ozgear.com.au

**SA/NT**

**POSNAV Systems P/L**

Tel: 08 8342 4700

brenton@posnav.com.au

**WA**

**Bushcomm Pty Ltd**

Tel: 08 9296 0496

bushcomm@bigpond.com

**www.benelec.com.au**



# Amateur Radio

Volume 74, Number 6  
June 2006

The Journal of the Wireless  
Institute of Australia  
ISSN 0002-6859

## Editorial

Editor: Peter Freeman VK3KAI  
editor-armag@wia.org.au

Technical Editor: Peter Gibson VK3AZL

### Publications Committee Members

Brenda Edmonds VK3KT  
Ron Fisher VK3OM  
Evan Jarman VK3ANI  
Tom Potter VK3UBS  
Bill Roper VK3BR  
Ernie Walls VK3FM

Circulation enquiries: wia@wia.org.au

### Submission of material to Amateur Radio Magazine

General and Technical articles to  
Secretary  
AR Publications Committee  
3 Tamar Court  
Mentone VIC 3194  
or armag@wia.org.au

Columns and Letters to the Editor to  
Editor  
AR Magazine  
PO Box 273  
Churchill, Vic 3842  
or editor-armag@wia.org.au

Hamads to  
"Hamads" Newsletters Unlimited  
PO Box 431  
Monbulk VIC 3793  
Fax 03 9756 7031  
newunltd@bigpond.net.au

Advertising  
All enquiries to  
Newsletters Unlimited  
PO Box 431  
Monbulk Vic 3793  
Phone: 03 9756 7797  
Fax: 03 9756 7031  
newunltd@bigpond.net.au

Registered Office  
10/229 Balaclava Road,  
Caulfield North VIC 3161  
Australia  
Phone: 03 9528 5962  
Fax: 03 9523 8191

## Production Deadlines

General articles, columns and  
advertising booking 10th day of  
previous month.

Hamads and advertising material 15th  
day of previous month

The contents of Amateur Radio are Copyright  
Wireless Institute of Australia © 2006

## GENERAL

AGM and the report to the Open Forum..... 3

## TECHNICAL

Simple modification to TS-520S (Try this)..... 5  
*David Jackson VK5DWJ*

Portable operation on 160 metres ..... 6  
*Lionel Curling VK3NM/VK6DC*

UHF aerial analysers, and Wheatstone's wonderful bridge ..... 9  
*Jim Tregellas VK5JST*

Some different ideas on the EH antenna..... 24  
*Lloyd Butler VK5BR*

A simple direct reading Q meter ..... 31  
*Drew Diamond VK3XU*

## COLUMNS

ALARA..... 47      News from..... 35  
Awards..... 40      VK2..... 35  
Beyond our shores..... 51      VK3..... 36  
Contests ..... 41      VK5..... 37  
Directory..... 56      VK7..... 38  
DX News & Views ..... 46      Over to you..... 5  
Editorial comment ..... 2      Silent key..... 38,50  
Gridsquare Standings..... 40      Spotlight on SWLing ..... 39  
Hamads ..... 54      Try This..... 5  
HF predictions ..... 52      VHF/UHF – an expanding world ..... 48  
WIA comment..... 3  
WIA news..... 4

## Our Cover this month

Bill Roper VK3BR with his well-deserved Honorary Life Membership Certificate. An amateur for 45 years and one-time WIA Federal Manager, Bill is still heavily involved in the activity and its administration. He currently is the prime draftsman for all the technical articles published in this magazine and is the Secretary of the Publications Committee.

### Contributions to Amateur Radio

Amateur Radio is a forum for WIA members' amateur radio experiments, experiences opinions and news. Manuscripts with drawings and/or photos are always welcome and will be considered for publication. Articles on disc or email are especially welcome. The WIA cannot be responsible for loss or damage to any material. A pamphlet, 'How to write for Amateur Radio' is available from the National Office on receipt of a stamped self-addressed envelope.

### Back Issues

Back issues are available directly from the WIA National

Office (until stocks are exhausted), at \$4.00 each (including postage within Australia) to members.

### Photostat copies

When back issues are no longer available, photocopies of articles are available to members at \$2.50 each (plus an additional \$2 for each additional issue in which the article appears).

### Disclaimer

The opinions expressed in this publication do not necessarily reflect the official view of the WIA and the WIA cannot be held responsible for incorrect information published.

## Amateur Radio Service

A radiocommunication service for the purpose of self-training, intercommunication and technical investigation carried out by amateurs; that is, by duly authorised persons interested in radio technique solely with a personal aim and without pecuniary interest.

## Wireless Institute of Australia

The world's first and oldest National Radio Society  
Founded 1910

Representing

The Australian Amateur Radio Service

Member of the

International Amateur Radio Union

Registered Office of the WIA

10/229 Balaclava Road, Caulfield North Vic 3161

Tel: (03) 9528 5962 Fax (03) 9523 8191

email: nationaloffice@wia.org.au

http://www.wia.org.au

All mail to

PO Box 2175 Caulfield Junction VIC 3161

Business hours: 10am – 4pm weekdays

### National Office staff

Margaret Webb Office Administrator  
Emma Trebilco Examinations Officer  
Brenda Edmonds Office Volunteer

### Board of Directors

President	Michael Owen	VK3KI
Vice-President	Ewan McLeod	VK4ERM
	Robert Broomhead	VK3KRB
	Glenn Dunstan	VK4DU
	Trevor Quick	VK5ATQ
	Robyn Edwards	VK6XRE
	Phil Wait	VK2DKN
Secretary	Chris Jones	VK2ZDD
Treasurer	Bruce Bathols	VK3UV

### Coordinators

AMSAT	Graham Ratcliff	VK5AGR
ARDF	Jack Bramham	VK3WWW
Australian ARISS	Tony Hutchison	VK5ZAI
Awards	Mal Johnson	VK6LC
Club Coordinator	Ted Thrift	VK2ARA
Contests	Ian Godsil	VK3JS
John Moyle Memorial Field Day Manager	Denis Johnstone	VK3ZUX
Editor 'AR'	Peter Freeman	VK3KAI
EMC/EMR	Gilbert Hughes	VK1GH
	Keith Malcolm	VK1ZKM
Standards	Gilbert Hughes	VK1GH
	David Wardlaw	VK3ADW
	John Bishop	VK2ZOI
NTAC	John Martin	VK3KWA
Historian	Will McGhie	VK6UU
IARU Region 3 Liaison Officer	Neil Penfold	VK6NE
Intruder Watch International	Glenn Dunstan	VK4DU
Travel Host	John Miller	VK3DJM
ITU Conference & study group	Gilbert Hughes	VK1GH
	David Wardlaw	VK3ADW
	Keith Malcolm	VK1ZKM
QSL Curator	Ken Matchett	VK3TL
QSL Bureau Coordinator & VK9/0 QSL Manager	Neil Penfold	VK6NE
Repeater Coordinator	Peter Mill	VK3ZPP
Webpage co-ordinator	Colin Thompson	VK2TRC
WICEN	Ewan McLeod	VK4ERM

## Editorial Comment

Peter Freeman VK3KAI

### 6 months down already!

Our production system appears to be settling down, especially as I become used to the regular tasks. This issue represents 6 months as editor.

Importantly, there have been some changes in machinery at the printer, resulting in improvements in print quality. As you will have noticed, we included colour content inside the magazine last month. This was a trial and the Publications Committee has certainly heard many good comments.

No internal colour, other than the usual colour highlights, in this issue, primarily because of the content. We will publish colour body content in future issues, when we have appropriate material on hand.

### AGM outcomes & the www

A number of members attended the Annual General Meeting in early May. Some have commented that the numbers were low, about 30 members attending in person. What conclusion can we draw? Perhaps it indicates that members are generally happy with direction in which we are moving? It is hard to judge, without conducting a survey of members. It was pleasing to hear that almost 25% of members took the time to vote in the election of office bearers.

I have been reminded that some members still rely on the printed word, namely AR, for news of WIA activities. With this in mind this issue carries an extensive report by our President, Michael Owen VK3KI, as presented to the Open Forum following the formal part of the AGM. The formal reports have been published on the WIA website.

In these times of modern communication technologies, it is easy to presume that most have Internet access. Outside of the WIA activities, I am aware of many groups now running classes in computer use, including the Internet. Groups such as the local Neighbourhood House and University of the Third Age (U3A) run such courses at very modest cost. There are other options, often requiring the payment of higher fees. If you do not have a computer at home, check at your local library? You might be pleasantly surprised!

The Internet is impacting on traditional publishing in many ways – some enhancing efforts to publish, whilst some

are in competition with the printed word. There are large amounts of information residing on pages published on the "Web" by enthusiasts. Some of it is very useful; some requires careful consideration before using that information.

### Material for AR

Further to my comments about colour, I must remind those interested in forwarding material for publication that we do have a guide to authors available. It is on the WIA website on the AR Magazine page. Hard copies are available on request.

A comment regarding photographs submitted. With the modern digital camera (or even the mobile 'phone), it is easy to capture that quick photograph. Think about the composition of the photograph, especially the background. You might capture the subject, but will it be lost in the background, especially if it is printed in black & white?

Taking photos of group activities can also be challenging. It is easy to capture the scene, but will it be of interest to others when printed in AR? Side-on shots of people or a row of the backs of people's heads rarely pass muster.

I encourage you to write up reports of that latest project or the local club activity. Do not be disillusioned if it does not appear immediately – we have a review process that may take material some time to move through before it comes to me for publication. There are also other considerations – for example, I did receive some addition photos of Club stations' set-ups for the John Moyle Memorial National Field Day. As I had published several pages of reports in the May issue, I have not used these images. They will be kept on hand – one never knows when they might be useful.

I trust that you find the issue informative. We can read more about how the much-discussed E-H antennas really work, and there are two useful construction projects on offer – an antenna analyser for VHF/UHF and a Q-meter. I must thank Denis Johnstone for his rapid processing of the results from the John Moyle Memorial National Field Day. And no, I still have not received any additional material regarding the individual results from the Manager of the RD Contest.

73 Peter

# AGM and the President's report to the Open Forum

The WIA Annual General Meeting and Open Forum were conducted at Bankstown, Sydney on Saturday 6 May 2006. The Notice of Meeting, Accounts and Report on behalf of the Directors were included with March AR.

However, the Directors Report with the Notice of Meeting is a statutory document and so does not attempt to cover all aspects of what the WIA does. This year, as last year, I presented a more detailed report, covering a much wider range of the WIA's activities. While this report has been placed on the WIA website, we think it is worth including in AR, to ensure that it is available to almost every member. So, what follows is a slightly edited version of that report.

## 1. Introduction

This report is submitted to the Open Forum to be held immediately following the formal Annual General Meeting on 6 May 2006, and outlines the activities of the WIA since 1 January 2005 until today, covering the last full financial year which was the 2005 calendar year. It is submitted on behalf of and following consultation with all of the directors. It does not repeat the formal matters set out in the Directors' Report submitted with the Annual Accounts to the AGM.

It is a significant period because this report covers the first full financial year of the restructured WIA as a single national body.

It is also significant because it covers a period of momentous change, not only to the WIA but the introduction of the Foundation licence, and the WIA's new examination structure.

## 2. The Restructure of Australian amateur licensing

It was at the last Open Forum that the members present unanimously passed a resolution expressing their concern at the delay in the introduction of the so called "Outcomes" of the Review of the

Amateur Service, and requested the ACA (as it then was) to introduce the new Foundation Licence and the new licence privileges without further delay and in any event not later than 30 June 2005, and instructed me to convey these views to the Authority.

On 10 May 2005 I wrote to the Acting Chair of the ACA, and in part said:

"The WIA believes that the further delay is unacceptable, and would be counter-productive, and rather than promoting a licence structure appropriate to today's needs, will simply create frustration, loss of motivation and, unfortunately, ill will. .... Accordingly, and formally, on behalf of the WIA I request that the Authority proceed to introduce the amateur service licence structure contemplated in the Outcomes paper without further delay and in any event not later than 30 June 2005, with the WIA accepting that other changes to the regulation of the amateur service will be delayed."

On 26 May 2005 the WIA was advised that the Outcomes of the Review would be introduced in two phases, the first to introduce the licences, the second to introduce the other changes.

In fact, the changes to introduce the Foundation licence and the new licence structure came into effect on 19 October 2005.

The other matters are yet to be finalised.

I comment on the Foundation and other licence matters under the heading "The WIA Examination Service".

Of the further changes foreshadowed, the one that we are most often asked about is Australia participating in CEPT TR 61, usually by overseas licensees about to visit Australia.

We have been in constant communication with ACMA on the second phase of changes.

We have been able to demonstrate some aspects of the use of the Internet to

ACMA, one of the areas of change that raises complex issues.

One factor that complicates a number of issues is the Determination under SI19 of the Radiocommunications Act in respect of "qualified operators" of amateur stations. I am of the view that a Determination under that section creates more problems than it solves, simply because of the width of the word "operate" and that a better solution would be other subordinate legislation. The issues are technical, at best resulting in provisions that are undesirably complex.

The WIA's position is to seek minimum regulation, with no less privilege than at present. For example, at least for Standard and Advanced stations, and particularly for club stations, the right to allow others to "operate" under supervision has always been an important part of demonstrating amateur radio and training radio amateurs.

I do not know when the further amendments to the Amateur LCD will be released, and I hope that we will continue to be given the opportunity to comment, particularly on a final draft.

In the context of the general area of regulation, and particularly in relation to the whole examination process, I would like to pay tribute to Alan Jordan of ACMA.

He has always been willing to listen to the WIA's views, even if not always agreeing with them, always happy to exchange ideas and always open to listen to new information and always of very great assistance in relation to the examination area.

## 3. The WIA Examination Service

The introduction of the Foundation Licence and the requirement for a practical assessment for every first licence qualification (usually a Foundation Licence) foreshadowed in the "Outcomes"

---

*This report continues on page 16*

## Result of Postal Ballot for Directors

WIA President Michael Owen VK3KI formally announced the result of the postal ballot for the election of 3 directors for a 2-year term at the WIA Annual General Meeting held in Sydney on 6 May 2006.

The result of the ballot was:  
Trevor Quick VK5ATQ, 715 votes, elected  
Robyn Clare Edwards VK6XRE, 694 votes, elected  
Philip John Wait VK2DKN, 694 votes, elected, and  
Edward (Ted) Thrift VK2ARA, 477 votes.

It was also announced that the Board did not wish to lose retiring director Ted Thrift's special knowledge and enthusiasm and so had created the role of National Club Coordinator, and appointed Ted to that position.

Ted also continues as joint editor of the Callbook.

## Ron Wilkinson Award 2006 to VK3DAC and VK2DQ

The Ron Wilkinson Award is one of the oldest and most important of the awards made by the WIA and was made possible through the generosity of Mrs Mary Wilkinson, widow of the late Ron Wilkinson VK3AKC.

At the WIA Annual General Meeting, WIA President Michael Owen VK3KI announced that the WIA Board had decided to present the Ron Wilkinson Award jointly to two people who, in different ways, had contributed greatly to the WIA's role in the introduction of the new licence structure, and in particular, to the new WIA amateur qualification assessment system.

The Board had decided to present the Award to Fred Swainston VK3DAC, the principal of the WIA's nominated RTO, and to Ron Bertrand VK2DQ, who had contributed greatly to all aspects of the development of the syllabi and the new assessment system, as well as writing with Phil Wait the successful Foundation Licence Manual.

## WIA announces details of Club Grants Scheme

Immediately prior to the Annual General Meeting held in Bankstown on 6 May 2006, the Board of the WIA adopted Rules for the Club Grant Scheme.

The full Rules are on the WIA website, so that all can fully understand them.

The Board has decided the main time line, but is still to appoint the three members of the Grant Committee. It will finalise these appointments shortly and will announce the appointments as soon as possible.

The WIA Board has allocated \$5,000 for distribution to qualifying Affiliated Clubs. The object of the scheme is to promote and advance amateur radio, the WIA and its Affiliated Clubs by supporting useful and/or innovative projects undertaken or to be undertaken by Affiliated Clubs.

Affiliated Clubs with a membership including at least 50% WIA members (as defined in the Rules) qualify to participate, though in the first year the Board has discretion to allow a lesser percentage in special circumstance.

Clubs will need to lodge their application for a grant by Monday 10 July.

Full details can be found in the Rules, but Clubs should note that their application should include details of the

Affiliated Club, including the name and contact details (including a phone number and email address) of a contact person to represent the Club in relation to the Application, the names and callsigns (if any) of each person responsible for the management of the project proposed and the Membership Percentage claimed by the Club, details of the project proposed, the purposes to be achieved by the proposal, an explanation setting out how the proposal advances the purposes of the Scheme, a detailed costing of the proposal including the amount to be or already contributed by others, the amount of Grant requested, and such other information and material as the Affiliated Club considers will better explain and support its proposal.

**Clubs will need to lodge their application for a grant by Monday 10 July.**

The Grant Committee will recommend to the Board the projects that should be supported and the amount to allocate to each supported project.

All clubs are urged to carefully study the Rules and note the date for lodgement of submissions as well as the requirement that to qualify a club must have at least 50% WIA members among its members.

The Board will amend the Rules as necessary to clarify or remove any ambiguities that are identified.

## WIA AGM and Open Forum

The second Annual General Meeting of the national WIA took place on Saturday the 6<sup>th</sup> of May, at the Bankstown RSL Club, Sydney.

The WIA Treasurer, Bruce Bathols VK3UV, presented the audited Annual Financial Statement, confirming that the WIA had ended the 2005 year in a sound financial position.

The Annual General Meeting was the formal part, and immediately the formalities finished, the meeting continued as an Open Forum, where any WIA related matter could be discussed in the context of reports on virtually every WIA activity

Michael Owen presented the President's

Report, saying that although WIA membership was increasing, strengthening membership depends largely on individual clubs promoting WIA membership to their members. The President asked the clubs, in the interests of all radio amateurs, to be more proactive in supporting the WIA and promoting WIA membership.

The President thanked the very many people who have made the second year of the national WIA such a success. He said that the success would not have been possible without the strong support of a great number of people, but most of all the man with the permanent phone in his ear, WIA Secretary, Chris Jones VK2ZDD.

## WIA makes Bill Roper VK3BR Honorary Life Member

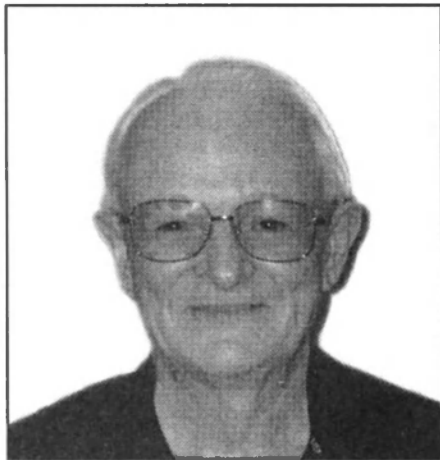

The WIA Constitution says that in consideration of special services to the Institute or amateur radio the Board may nominate a member as an Honorary Life Member to a General Meeting for its approval.

At the Annual General Meeting held at Bankstown, Sydney on 6 May 2006, the WIA Board nominated Bill Roper VK3BR as an Honorary Life Member.

Bill's contribution to the WIA and amateur radio extend over many years. He became an amateur over 45 years ago, was Treasurer of the old WIA Victorian Division, and when the WIA's magazine Amateur Radio was transferred from the Victorian Division to the then new federal company in 1972, Bill became its first editor and has continued to contribute over the years to the magazine.

For over 10 years, with Ron Fisher VK3OM, Bill prepared the Federal broadcast tapes.

After a period as WIA Federal Manager, Bill again became heavily involved with the Publications Committee, and for more than 10 years now he has been the prime draftsman for all the published technical articles in AR, as well as acting as Secretary of the Publications Committee.

The meeting unanimously approved the nomination of the Board, and so Bill Roper VK3BR has become an Honorary Life Member of the WIA.

So far as Bill was concerned, this was all completely unexpected and he was very surprised when Michael Owen VK3KI, WIA President, telephoned him immediately after the meeting to congratulate him.

## Try This

### Simple modification to TS-520S

David Jackson VK5DWJ

The attached diagram shows how to modify the cathode current metering circuit of the TS-520S to allow measuring either individual cathode currents of each output tube, or the combined current as normal.

This can be useful if you have doubts about the condition of each tube.

I used an available small three position slide switch, fitted conveniently in the lower left hand corner of the case.

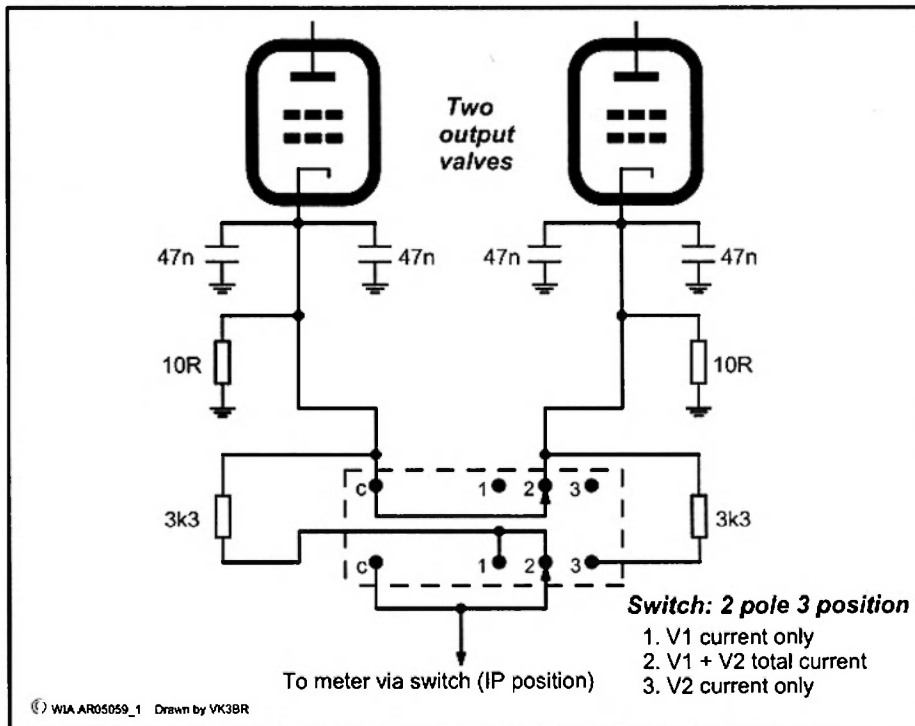

## Over to you

### An efficient response

In the September and October 2005 issues of *Amateur Radio* a two part article of mine was published on the development of radio in Outback Australia.

Brian VK2GCE believed I was quite wrong in my statements that some valves were not efficient in Class C operation and emailed the then editor in October 2005 putting me right. I had quoted around 40% efficiency for valves like the 1D4/1L5G battery valves. I also quoted that some other valves like the 4CV100,000E were over 80% efficient. Brian believed that the valves always complied with a particular formula that he quoted and that my statements were quite wrong.

I was emailed a copy of Brian's "over to you" as a right of reply and I replied

and this showed up in March 2006 issue. However, Brian obviously received a copy of my "right of reply" as his original submission was withdrawn and an amended full-page version has been published in the May issue. It is noticeably different from his original submission! I could pick points in Brian's submission that may not stand scrutiny, but I choose not to.

I don't know if Brian is trying to blind me with science or what but I would suggest that readers of AR re-read my original reply to Brian on page 49 of the March issue, to see what I had to say. I stand by all that I said in that submission.

Rodney Champness VK3UG

# Portable operation on 160 metres

Lionel Curling VK3NM/VK6DC

**Operating portable on 160 metres offers some challenges to get reasonable results due to fairly large antennas, or large number of windings on a short former.**

I use an IC-706MKIIG into a 14 ft (approx 4.3 m) helical with 1500 turns of wire which was a prototype wound over three weekends by the Members of the Frankston and Peninsula Amateur Radio Club.

I have used this antenna from various locations around Port Phillip Bay and other locations from Mt Dandenong, Lake Corangamite about 160 km west of Melbourne, Johns Hill lookout near Menzies Creek, and East Melbourne.

Most of the operations occur on the Melbourne 11.00 am 160 metre 1843 kHz AM coffee break net.

Very good results come from seaside locations with less ground wave absorption and from inland locations signals, although signals can vary depending on the QTH of the station being worked.

The morning I was on Phillip Island I could only hear one station, due to overwhelming power line interference all over the island, and could not do much better from East Melbourne with a lot of industrial noises coming from Melbourne's CBD.

Operating from Lake Corangamite, which is a fair way out from Melbourne, some of the signals were very weak and I had to change to SSB for reliable contacts. The IC706MKIIG only puts out 30 watts of AM into an aerial with an efficiency of perhaps 2 percent, whereas I get about 100 watts out on SSB. This made it a bit easier to be copied by other stations.

Some of the more notable contacts I have made from my helical antenna include working Grant VK2AXB from Portsea and the VI5PN IOTA station on St Peter Island, just off Ceduna, South Australia, on SSB with good signals from Wantirna.

I operated from the car park of the Science Works Museum in Spotswood during the Remembrance Day contest, working VK2, VK5, VK7 and country VK3s on SSB under the callsign of VK3WIA for the event.

While I was in Perth, I set up in the



David VK3ZLZ (left) and Jack VK3WWW operating portable from the breakwater at Brighton Beach pier.



The 160 m kit ready to use for portable operations.



car park at City Beach and heard some reasonable signals from VK3 and VK5, including Ken VK3YDK, but no contacts were made; there is always next time.

Sometimes I use a full size dipole fed with 300 ohm slotted ribbon via a tuner with excellent results.

By using a bait launcher to get the line over tall branches to hoist my dipole up high, I worked most of VK and ZL from my friend's property at Launching Place during the 2004 Trans-Tasman 160 metre contest.

On Melbourne Cup day, Jack VK3WWW and I set up for 160 metres on the very long Brighton Beach pier with the intention of using Jack's kite antenna. However, when there was not enough wind we used Jack's dipole with the apex up at 12 metres supported by a squid pole. Not much was heard for the early morning skeds to VK2, but the aerial was used for some 80 and 40 metre contacts leading up to the 11.00 am coffee break net on 1843 kHz, making a lot of contacts around Melbourne. David VK3ZLZ turned up fairly early in the morning to help out and later Peter VK3YE also turned up.

Peter has been portable on 160 metres from various locations using his magnetic loop antenna with good results. During the morning there were a lot of people fishing, some of the more curious looked at our set-up. A few questions were answered about amateur radio so it was a bit of PR

for our hobby as we let them know about the new Foundation Licence.

For my portable 160 metre dipole I made a kit for storage and transporting by using a small olive barrel (I made sure I cleaned out any leftover olives first!). As you can see from the photo, I can keep all the essentials such as a bait launcher, fishing line, nylon rope, PVC tape, lead sinker balls, wind up torch, safety glasses and of course the aerial stored in this easily transportable barrel.

The safety glasses are very important to protect your eyes while pulling back on the launcher in case the rubber breaks and flicks back towards you. A torch is useful if it is dark. I use a wind-up magneto type so as not to have to worry about batteries going flat.

Other items I take with me include a small knife in case I have to cut the cord or the fishing line, an ATU for tuning up the aerial, a small 12 volt soldering iron and solder in case I need to do any repairs on the aerial, a good car battery or a second one (when running 100 watts the peak current can be 20 amps from the battery), a squid pole in case there are no trees and, last but not least, drinking water if it is a hot day.

I hope to catch up with you on 160 metres soon. For more information on the 'Top Band', I have a web site dedicated to 160 m - the URL is <http://www.qsl.net/vk3nm/160mt.html>

ar



VK3NM's vehicle with the 160 m whip at Port Arlington.

## Plan ahead

### The Gippsland Gate Radio & Electronics Club Hamfest

On 22 July GGREC will be conducting their Hamfest Sale at the Cranbourne Community Hall, Cranbourne.

#### Stall holders

should book early as demand will be very high. contact  
Dianne Jackson VK3JDI  
on (03) 5625 2545

## July 15 2006 Jack Files Memorial Contest

### KVK Antenna Systems

Best value books in VK.

The VK Antenna Handbook  
for Restricted Spaces

Best value antennas in VK.

The NuBeam

The Vertical-LR-dipole  
multiband vertical

As seen at Wyong

Check out the latest revision to the web site - more info, more antennas, more value.

For direct purchases  
[www.grimshaw.net.au](http://www.grimshaw.net.au)

For credit card purchases:  
[www.kvkantennas.com.au](http://www.kvkantennas.com.au)  
or ph 07-3216 8060 or  
fx 07-3216 8075

# TTS Antenna Tuner Special TTS

We Have Australia's Best Range in Antenna Tuners

## LDG Electronics

### AT200pro Auto Tuner + Switch

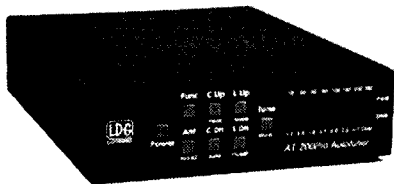

160 through 6 meters, 5 to 250 watts, 16000 3D memories, 2 position antenna switch, power and VSWR LED bargraph.

### AT100pro Auto Tuner + Switch

160 through 6 meters, 1 to 125 watts, 4200 memories, 2 position antenna switch, power and VSWR LED bargraph.

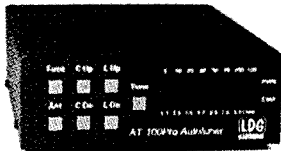

### Z11pro Auto Tuner

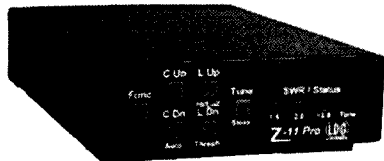

160 through 6 meters, 0.1 to 125 watts, 8000 3D memories, LED display for VSWR and status and User installable battery holder (not supplied).

### Z100 Auto Tuner

160 through 6 meters, 0.1 to 125 watts, 200 memories, LED indicators for VSWR and status.

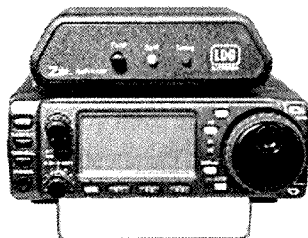

### AT1000 High Power Auto Tuner

160 through 6 meters, 20 to 1000 watts, 200 memories, cross needle power/VSWR meter, protection against high power tuning.

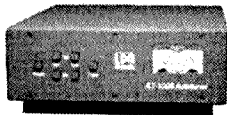

### AT897 Auto Tuner



160 through 6 meters, 0.1 to 100 watts, 200 memories, mounts right on the side of the Yaesu FT-897

## SGC

### SGC 235 High Power Auto Tuner

160 through 10 meters, 3 to 500 watts, 170 memories, waterproof ABS enclosure.

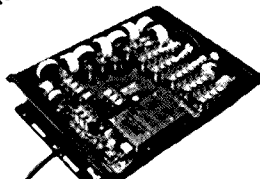

### SGC 230 Auto Tuner

160 through 10 meters, 3 to 200 watts, 170 memories, waterproof ABS enclosure.

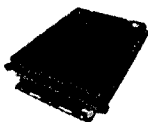

### SGC 237 Auto Tuner

160 through 5 meters, 3 to 100 watts, 170 memories, waterproof ABS plastic covers on an anodised aluminium base.



### SGC 239 Auto Tuner

160 through 10 meters, 3 to 200 watts, 170 memories, aluminium case with exposed PCB\*

### MAC 200. Auto Tuner plus Switch

160 through 5 meters, 1.5 to 200 watts, 168 memories, 5 position antenna switch (3 coaxial, 1 end fed, 1 balanced), VSWR/Power meters, extruded aluminium case.



## Ten Tec

### Model 238B High Power Manual Tuner plus Switch



160 through 10 meters, 2000 watts, wide matching range, internal VSWR/Power meter.

## Tuner Accessories

LDG RBA-1:1 200W 1:1 BALUN

LDG RBA-4:1 200W 4:1 BALUN

TTS CUSTOM HIGH POWER BALUN

TTS PATCH CABLES

WM1 VSWR/POWER METER



# TTS Systems Communications Equipment

www.ttssystems.com.au

FREE CATALOGUE

HF and VHF Transceivers, Autotuners and Kits

Phone 03 5977 4808. Fax 03 5977 4801 info@ttssystems.com.au

# UHF aerial analysers, and Wheatstone's wonderful bridge

Jim Tregellas VK5JST  
 endsodds@internode.on.net  
<http://www.users.on.net/~endsodds>

On the day *Amateur Radio* (May 2005) published my design for a HF aerial analyser, ham friends started asking me for construction details of a VHF/UHF unit. In trying to satisfy these requests, I've had some fun and learnt a lot, and a design has evolved that is startlingly simple and works well. If you have a reasonable junk box, you should have most of the bits already.

Anyone who has done formal electronics training will be familiar with the Wheatstone bridge. Somewhere, early in the course, a diagram is drawn complete with battery and sensitive galvanometer, and it is carefully explained how to measure resistance by "balancing" the bridge. Complex mathematics are used to demonstrate this, and then the whole subject is quickly dropped because "modern" electronics can be used to measure resistance far more conveniently. The quite clear implication which emerges is that, apart from the odd specialist application, this old DC measurement technique belongs in the 19<sup>th</sup> century and should be forgotten.

In fact, nothing could be further from the truth.

With AC applied to the bridge, and some more complex mathematical analysis (which the author has yet to see in any

text), the bridge can be used to measure SWR very accurately over an enormous frequency range; and without any of the problems of frequency and power sensitivity shown by almost any other SWR bridge design. Even better, only readily available components are used.

## The Theory

In the circuit shown in Figure 1, imagine that the load is a pure resistance of 50  $\Omega$ . The AC voltage appearing at both points A and B ( $V_A$  &  $V_B$ ) will be 0.5 V RMS. After half-wave rectification,  $V_A$  becomes  $V_1 = 707$  mV DC. Similarly,  $V_B$  becomes  $V_2 = 707$  mV DC, assuming perfect diodes (no turn-on voltage).  $V_3$  is the rectified version of the voltage difference between A and B, and because  $V_A$  and  $V_B$  are in phase and of equal magnitude,  $V_3 = 0$ .

Now make the load an open circuit.

$V_A$  will still be 0.5 V RMS and  $V_1$  still 707 mV DC.  $V_B$  will be 1 V RMS and so  $V_2$  will be 1.414 mV DC.  $V_3$  will be 707 mV DC because the difference between  $V_A$  and  $V_B$  is now 0.5 V RMS.

Finally, short the load terminals.  $V_1$  will remain at 707 mV DC.  $V_B$  will be zero as will  $V_2$ , and  $V_3$  will be 707 mV DC because the difference between  $V_A$  and  $V_B$  is again 0.5 V RMS.

Summarising, the voltage at A and therefore  $V_1$ , did not change with the load. The voltage at B, and therefore  $V_2$ , rose from 0 to 1.414 mV as the load was varied from zero to an open circuit. The voltage  $V_3$  dropped from 707 mV (load shorted - SWR infinite) to zero (50  $\Omega$  load - SWR=1) and then rose again to 707 mV with an open circuit load (SWR infinite).

What we have just described is how an SWR meter works.  $V_1$  represents forward power,  $V_2$  represents reflected power and  $V_3$  represents the difference between the two, or SWR.

Taking all this a little further it is easy to see that for a known value of input voltage,  $V_2$  can be used to produce a resistance scale on a meter while an SWR

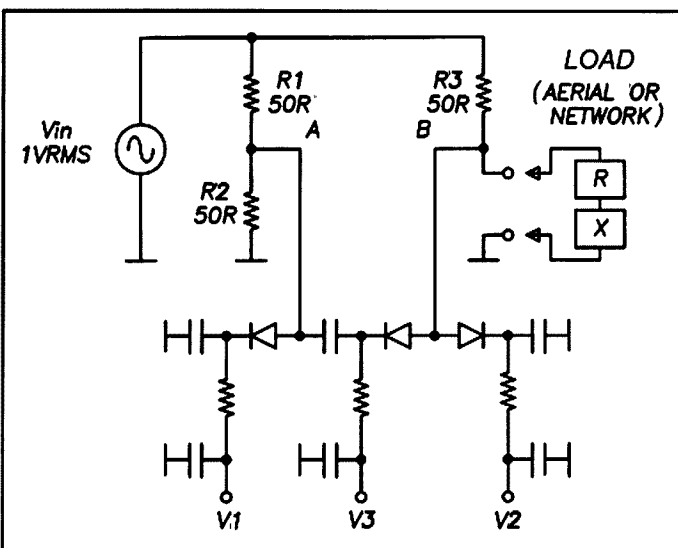
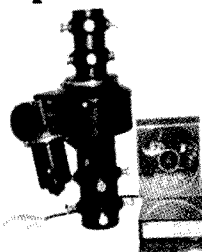

Fig 1 - The Wheatstone bridge for AC.

## OzSpid Rotators



Oceania - New Zealand - Australian  
 Distributors.

Australian Enterprise Industrial

P.O. Box 1013

Browns Plains. QLD. 4118.

Ph. 0414 254 080.

Fax. 07 3800 8003.

[aitower@spin.net.au](mailto:aitower@spin.net.au)

<http://www.spin.net.au/~aitower>

scale can be produced from V3.

But so far we have only talked about purely resistive loads. What happens when the load is a complex mixture of resistance and capacitance, resistance and inductance, or pure capacitance or inductance?

To answer these questions requires really heavy-duty mathematics and frankly is beyond the scope of this article.

Suffice to say that the maths clearly shows that, irrespective of whether the load is complex or purely resistive, the indicated SWR will be correct and the SWR scale can simply be produced by using purely resistive calculations.

For those who would like to personally demonstrate this for themselves, I have included two vector diagrams from which the appropriate mathematics can be derived. Figure 2 is for the general case of a complex load, whilst Figure 3 is for the special case of a purely capacitive or inductive load.

The diagrams are constructed as follows. Because  $V_{in}$  is always the hypotenuse and the voltage across the resistive and reactive components must always have a

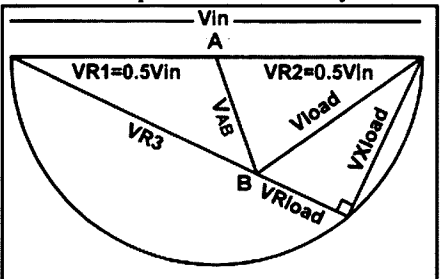

Fig 2 - Vector diagram - general case.

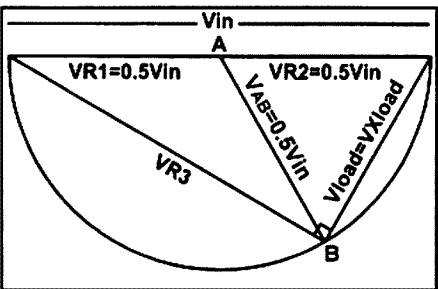

Fig 3 - Vector diagram - pure inductive or capacitive load.

90 degree phase relationship, from simple trigonometry the intersection of the resistive and reactive vectors must always be on a semicircle of a radius  $V_{in}/2$ . In the case of a purely reactive load this leads to the remarkable conclusion that the difference voltage  $V_{AB}$  is constant at  $V_{in}/2$  (irrespective of the size of capacitor or inductor). This is correct, as the SWR for a purely reactive load will always be infinite, which  $V_{in}/2$  represents.

Not surprisingly, the meter scale produced from  $V_2$  for resistance is not accurate for complex loads. But it is also clear that, for any complex load comprising a known value of resistance in series with a reactance, the voltage indicated for this load will always be higher than the voltage indicated for that value of resistance alone, because the overall load impedance is higher. Putting this another way, the indicated voltage will always be

minimum when an antenna is at resonance and therefore purely resistive, and the resistance scale then reads correctly. On either side of resonance the voltage will rise because of the reactive term which is introduced. We can use this observation very practically by noting what happens to the indicated resistance as we vary frequency and this idea is covered in greater depth later in this article.

Other conclusions which emerge from studying this circuit are:

(a) The generator never sees an SWR of greater than 2:1 (with an open circuit load) and so there is no chance of doing serious damage to a driving source due to high SWR.

(b) This is a measurement instrument not an SWR meter, because three quarters of the applied power is lost in the measurement network (instead of radiating from the aerial). Furthermore, because of the need to use non-inductive low power resistors, it is a low-power animal (2 watts maximum) and cannot be left permanently connected as a monitor in a transmission line.

(c) In order to make the forward voltage drop of the diodes negligible, fairly large

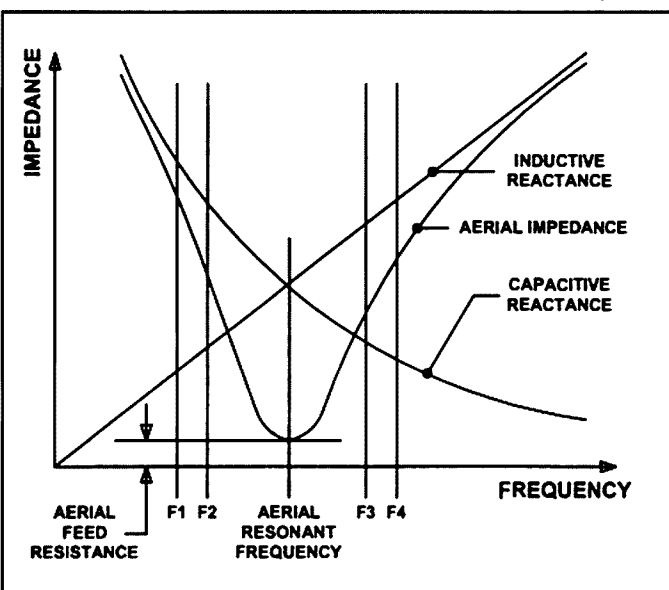

Fig 4 - Impedance, reactance, resonance chart.

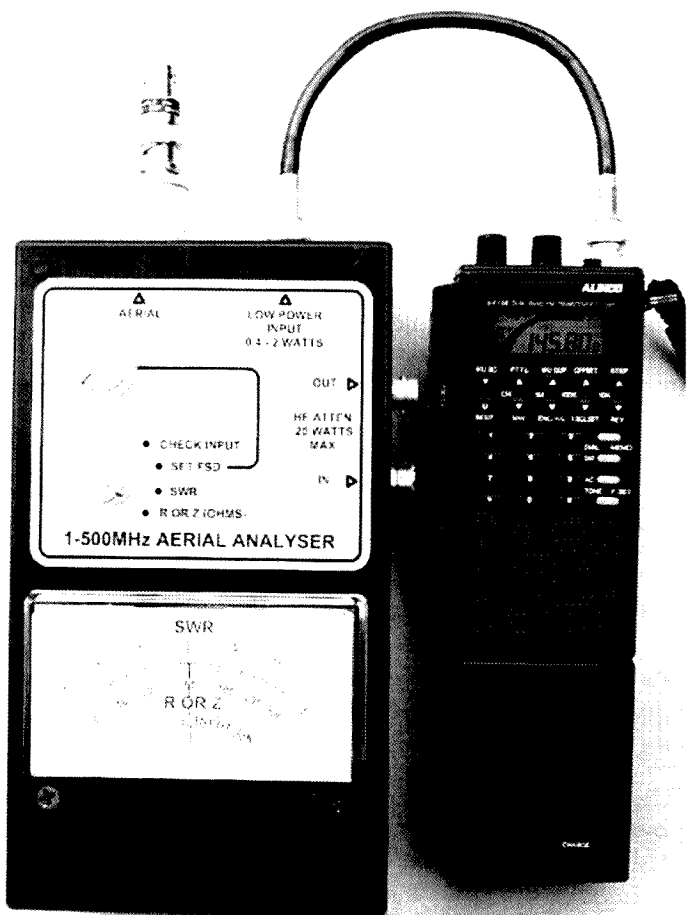

Photo 1 - The analyser with a handheld as signal source.

driving voltages must be used. Further, if the bridge is to function well at 70 cm, only Schottky barrier diodes can be used with their great speed and low forward voltage drop (approx. 200 mV). In fact, the meter scale (see Figure 6) includes the effects of diode forward voltage drop.

### The Practical Analyser

Constructors of the previous HF analyser were so happy with its performance that they soon began demanding an instrument that covered 6 and 2 metres, and also hopefully 70 cm. It also had to be cheap and easy to construct! This is a brutal design requirement. After a whole lot of research, two things emerged. First, frequency pre-scaling ICs which work to 500 MHz are not readily available unless you are prepared to order in quantities of at least 1000, and so an LCD frequency display derived via a microprocessor is just not on. Second, the design and construction of a "flat" high-power driving source (say 1 watt from 30-500 MHz) was going to be an expensive nightmare and also (third) very heavy on battery use.

How to overcome these three obstacles? Simple: use the amateur's hand-held radio (with its frequency display) as the driving source. The result is a cheap and basic instrument with no batteries which does all the things an amateur needs to design and tune a resonant aerial system.

The last part of the exercise is designing the test network to be purely resistive. This is not simple because all modern resistor types have built-in inductance due to the laser spiralling used to adjust their value to within tolerance.

Some careful measurements were made on standard 1/4 watt metal film resistors with zero lead lengths to establish whether their self-inductance was negligible at 70 cm. Sadly, this is not the case and even placing three units in parallel to reduce the effective inductance by a factor of three (and also increase the power rating), does not help much either. But the technique does work at 2 metres and so two versions of the Analyser have been created.

Version 1 works accurately to 150 MHz and uses standard 1/4 watt metal film resistors. It is for those constructors who don't feel confident about using surface mount components. Version 2 uses 1206 type 1/4 watt surface mount resistors in the bridge and works to 500 MHz accurately.

Use a type N connector for the aerial circuit if the unit is for UHF applications.

SO239/PL259 connectors have high dielectric losses, high capacitance, and poor impedance matching at 450 MHz, and will cause very significant errors on the resistance scale (around 15%) even with no load on the instrument. The much lower capacitance of the type N connector will still cause slight FSD

errors on the resistance scale at 70 cm, but this capacitance is swallowed in the 50 Ω line when a load is connected to the Analyser. The losses and mismatch of a SO239/PL259 connector are not! If a SO239 must be used, find one with clear plastic insulation, not light brown bakelite!

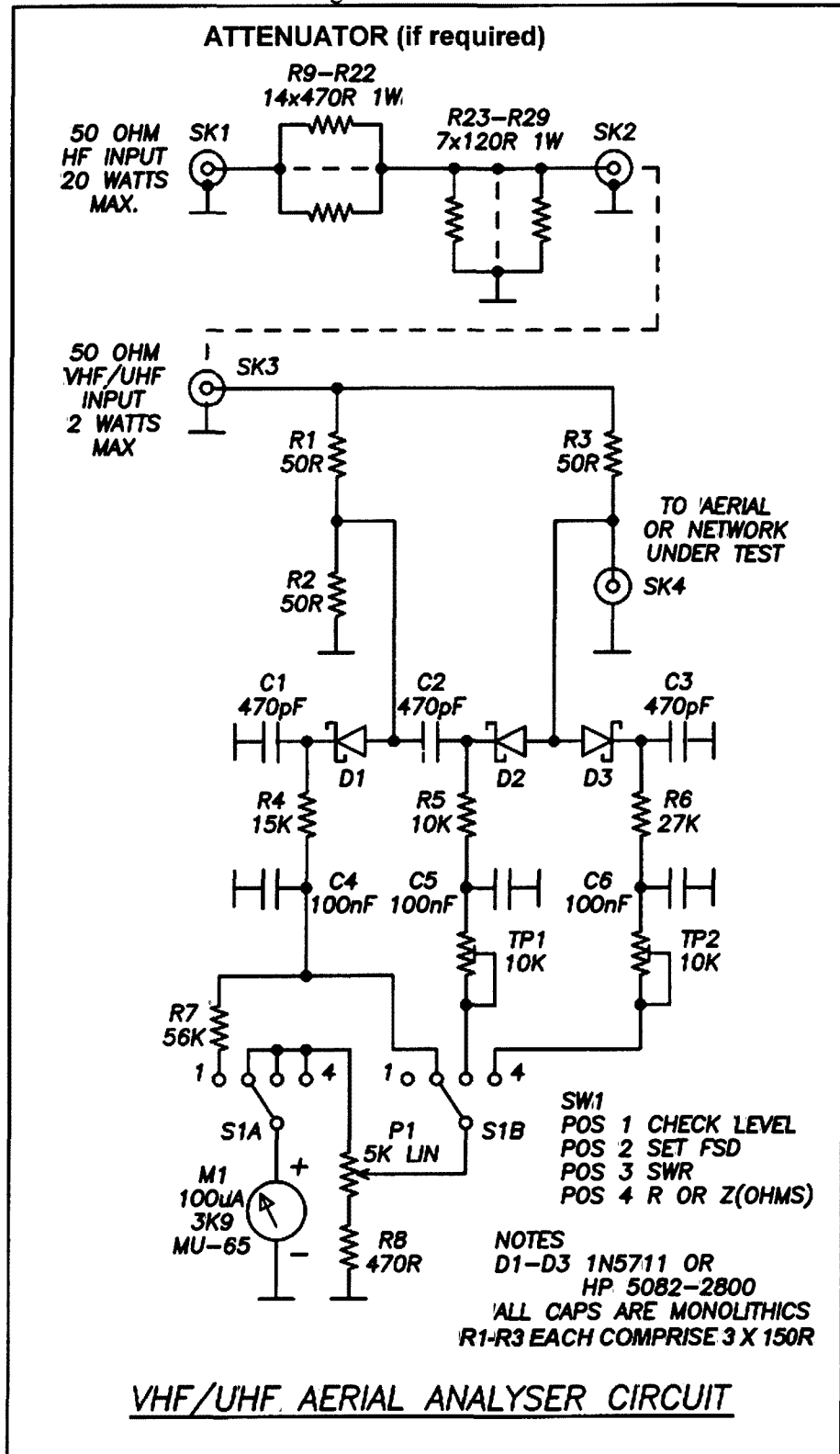

Fig 5 - Aerial analyser schematic.

The final part of the design is a power attenuator so that, for HF measurements, a standard HF transceiver at low power can be used as the signal source. Constructors may wish to omit this feature from the instrument if they have already built, or possess, an HF aerial analyser.

**Construction**

Make the PCBs first. The steam iron/clay paper method works well (see [www.users.on.net/~endsodds](http://www.users.on.net/~endsodds)). Artwork is included for the connector PCB (Figure 11), the Version 1 or 2 main PCB

(Figure 12 or 13), and if required, for the attenuator connectors (Figure 10). Drill all holes and lightly solder-coat the PCB copper surfaces using a neutral paste flux and your soldering iron. Clean all surfaces with methylated spirits.

Complete all mechanical work on the case. In order to mount the PCBs, some of the case reinforcing ribs must be completely removed (a wood chisel is good for this). The front panel drilling details are given in Figure 7. Use the PCB (Figure 11) as a template to mark out the connector holes in the top of the case, and

if the attenuator is included, mark out its connector holes in the side from the PCB defined in Figure 10.

Finish the

PCBs. If you are using surface mount resistors in the bridge, mount them first. Very lightly coat the area where the resistors will be mounted with a neutral paste flux, and then hold the first resistor across its width with tweezers. Place it in position and lightly tack one end to the PCB using minimum solder. Repeat for all nine resistors. Firmly solder the other ends, allow to cool, and then re-solder the tacked ends using fresh solder. Remove all flux with methylated spirits and blow the PCB dry with hot air (hair dryers are great). Then, following the schematic (Figure 5) and the layout diagram (Figure 9) mount all other components. See, it wasn't really painful.

Solder the brass nuts to the connector PCB using steel screws to temporarily hold the nuts in final position. Mount all connectors, and then solder the connector and component boards together at right

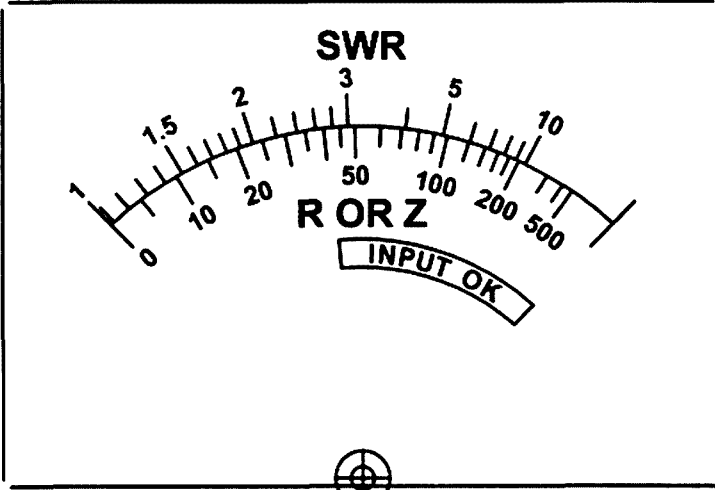

Fig 6 - Meter scale (exact size).

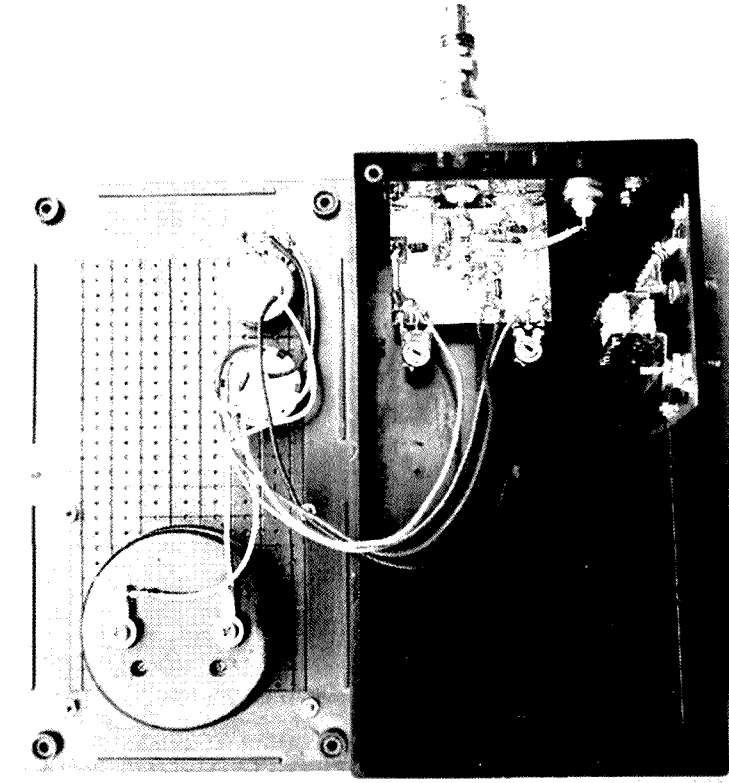

Photo 2 - Construction details with case open.

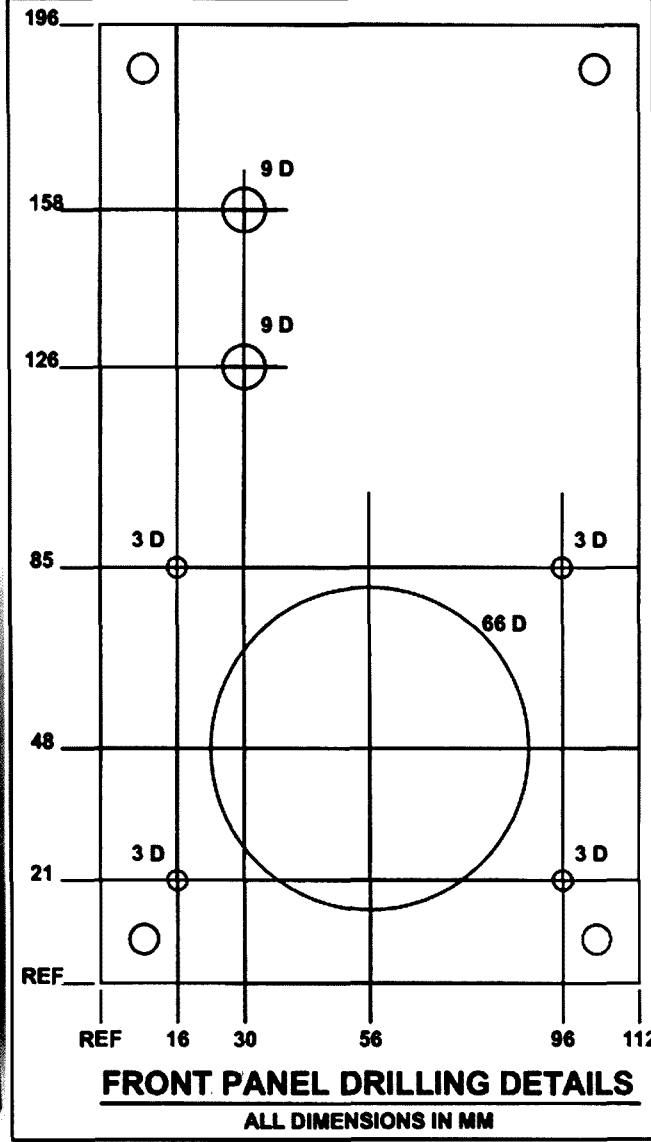

Fig 7 - Front panel drilling template.

angles. The completed assembly is shown in Figure 9. Use plenty of solder in the fillet. Make the final connection between the component board and input BNC connector using Teflon insulated miniature 50 Ω coaxial cable. If the HF attenuator is to be included in the instrument, assemble it as shown in Figure 10. Install everything in the case and complete all other wiring as per Figure 9 and Photo 2.

Then, modify the meter. In a very clean working environment remove the plastic faceplate and the screws which retain the metal scale. Turn the scale over and carefully cover the rear surface with thin double-sided adhesive tape. Photocopy the meter scale (Figure 6) onto heavy-weight glossy paper and carefully cut around its perimeter with a very sharp hobby knife. Stick this scale to the rear of the existing metal scale. Trim up with your hobby knife and reassemble the meter.

The final task is to install the front panel label which is provided in Figure 8. Follow the same procedures as for the meter scale.

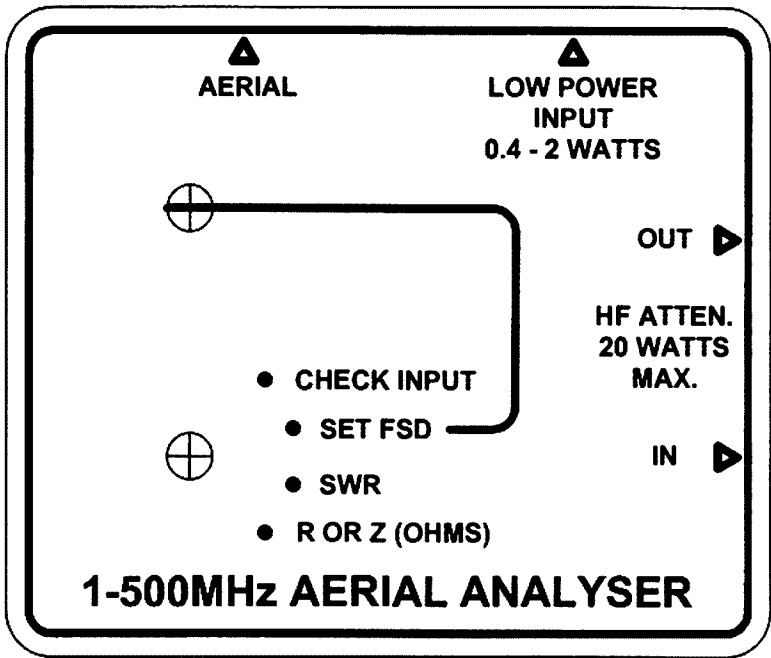
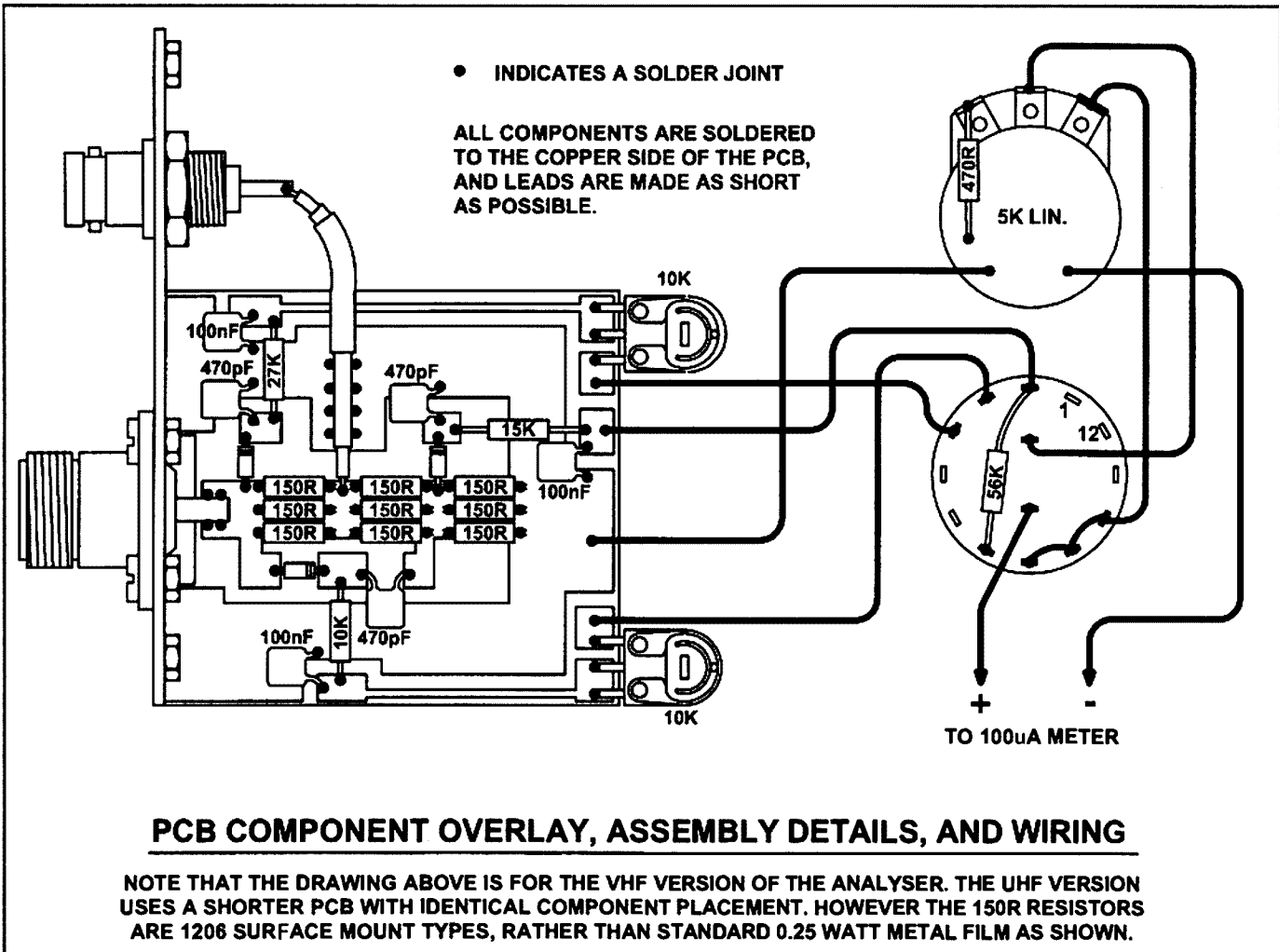

Fig 8 – Front panel label (exact size).



**PCB COMPONENT OVERLAY, ASSEMBLY DETAILS, AND WIRING**

NOTE THAT THE DRAWING ABOVE IS FOR THE VHF VERSION OF THE ANALYSER. THE UHF VERSION USES A SHORTER PCB WITH IDENTICAL COMPONENT PLACEMENT. HOWEVER THE 150R RESISTORS ARE 1206 SURFACE MOUNT TYPES, RATHER THAN STANDARD 0.25 WATT METAL FILM AS SHOWN.

Fig 9 – VHF version component layout and wiring.

### Setting up

Switch the Analyser to its "CHECK INPUT" setting. Using a frequency in the 5-30 MHz range, gradually increase input to the analyser bridge to around the 1 W level (middle of the "INPUT OK" scale).

Switch to "SET FSD" and, using the front panel potentiometer, carefully adjust for full-scale on the meter. Next, using the appropriate trimpot, adjust for full-scale deflection on both the "SWR" and "R or Z" switch positions. This completes all calibration. (The frequency of between 5

and 30 MHz is recommended simply so that the capacitive effects of the connector are negligible on the resistance scale - on the UHF version you can set up at 146 MHz).

If you have a really good 50 Ω dummy load, use it to check whether the instrument

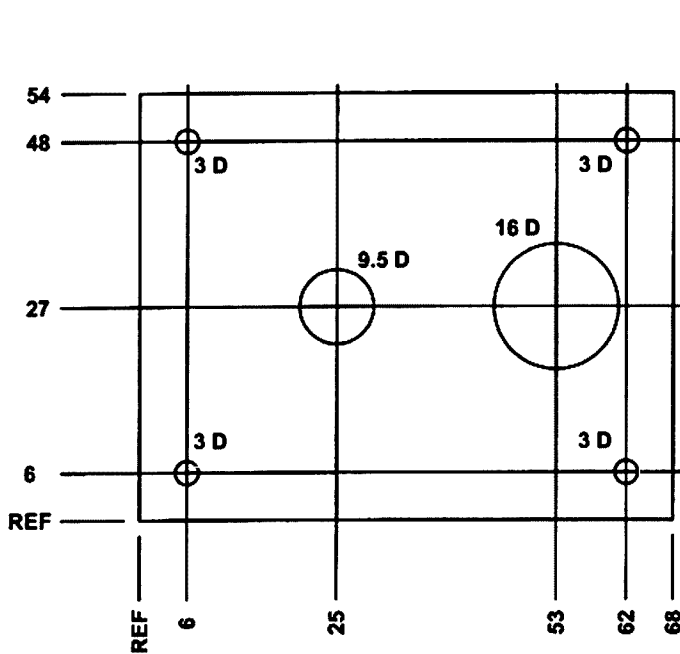

### PCB DETAILS

MATERIAL: 1.6MM FR4 SINGLE SIDED PCB  
COPPER SIDE SHOWN

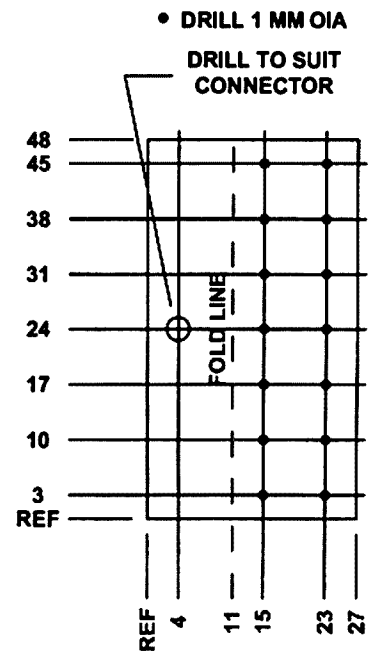

### MOUNTING BRACKET

MATERIAL: TINPLATE OR  
0.8MM BRASS SHEET  
2 REQUIRED

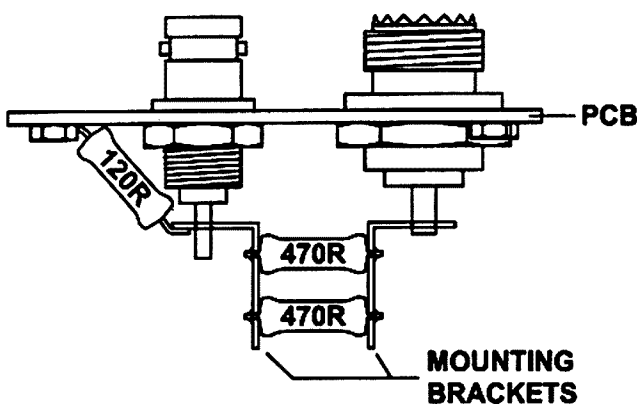

### SIDE VIEW

3MM BRASS NUTS  
SOLDERED TO PCB

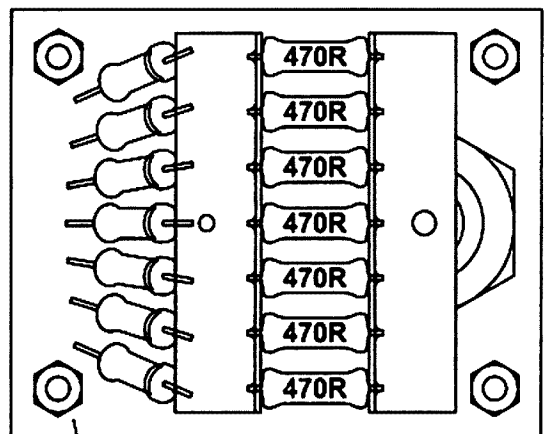

### PLAN VIEW

## POWER ATTENUATOR DETAILS

ALL DIMENSIONS IN MM  
COPYRIGHT VK5JST 2005

Fig 10 – Power attenuator details.



indicates an SWR of 1 and a resistance of 50 Ω over the frequency range quoted for your load. Unfortunately, many dummy loads fail this test miserably and a good dummy load which operates correctly at VHF or UHF (SWR less than 1.05) is very difficult to make. The Analyser design was carefully tested using a borrowed precision 50 Ω load at both 2 metres and 70 cm (thanks VK5ZBQ). With the surface-mount resistor bridge, an SWR of 1.05 was measured at 470 MHz. Version 1, using standard quarter watt metal film resistors in the bridge, gave an SWR reading of 1.3 at 470 MHz and 1.03 at 146 MHz. It also incorrectly indicated the resistance as 70 Ω at 470 MHz.

**Using the analyser**

Select a test frequency on your handheld (see Photo 1) and adjust the power output for around 1 W (or use the inbuilt attenuator to produce 0.4 - 2 W into the test circuit from your HF rig). Switch to "SET FSD", adjust for full scale, and then check "SWR". Check the apparent impedance (Z) on the R or Z scale. Now switch your radio to a slightly higher frequency, recalibrate the instrument and note changes to SWR and impedance. If the impedance fell on the second test the aerial is too short and needs extending. If the impedance rose then you are measuring above the aerial's resonant frequency and it needs to be shortened. Note that the frequency change should be kept relatively small (1 - 2%). It is very easy to completely miss the aerial resonance with a big frequency change (say from F2 to F3 in Figure 4) and fool yourself. This is particularly so on multi-element Yagis with small element diameters, as the bandwidth can be very narrow.

Once you know where you are relative to resonance, you can work out whether to lengthen or shorten, add inductance or capacitance, adjust the matching network for a better match, use a different feed line or balun, or take any one of thousands of possible actions including hurling the antenna over the nearest fence. And in the process you will end up really learning something about the mystical subject of aerials.

Enjoy!

**Parts List**

- 9 150 Ω 0.25 watt metal film OR
- 9 150 Ω 0.25 watt type 1206 SM
- 7 120 Ω 1 watt metal film
- 1 470 Ω 0.25 watt metal film
- 14 470 Ω 1 watt metal film
- 1 10 kΩ 0.25 watt metal film
- 1 15 kΩ 0.25 watt metal film
- 1 27 kΩ 0.25 watt metal film
- 1 56 kΩ 0.25 watt metal film
- 2 10 kΩ trimpots Jaycar RT4016
- 1 5 kΩ linear pot
- 3 470 pF 50 V NPO monolithic capacitors
- 3 100 nF 50 V monolithic capacitors
- 3 1N5711 (HP 5082-2800) Schottky diodes DSE Z3231
- 2 BNC connectors Altronics P0516
- 1 SO239 connector Altronics P0510
- 1 N type connector DSE P2410
- 3 printed circuit boards- see text
- 1 2 pole 6 position rotary switch Jaycar SR1212
- 2 knobs
- 1 100 μA meter type MU-65 Altronics Q0550
- 1 Jiffy box 197 x 113 x 63mm Jaycar HB6012
- 14 3 mm brass nuts
- 14 3 mm countersunk screws

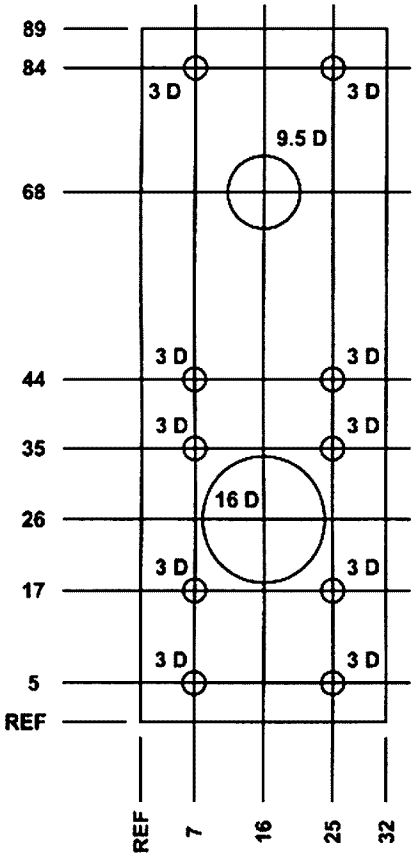

**CONNECTOR PCB DETAILS**

MATERIAL: 1.6MM FR4  
SINGLE SIDED PCB  
ALL DIMMENSIONS IN MM

Fig 11 – Connector PCB details.

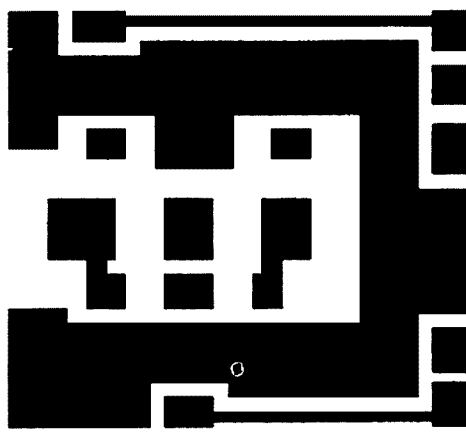

Fig 12 – VHF board template.

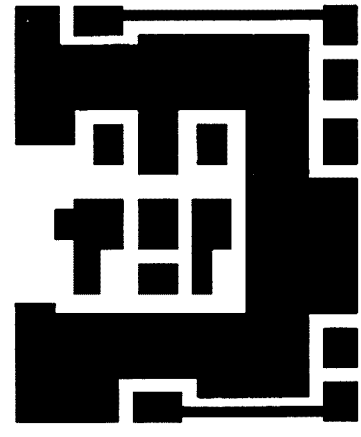

Fig 13 – UHF board template.

**Not QTHR in the 2006 Callbook? You need to check and amend your details with ACMA now.**

# President's Report — continued

paper, as well as the shortcomings of the existing examination system led the Board to a total revision of the WIA's approach to the assessment of amateur qualification.

Let me review the events that have led to the system we have now established.

In the December 2004 edition of 'Amateur Radio' I raised the idea of a new examination system based on the assessment competency by assessors holding a nationally recognised qualifications based on the Australian Qualifications Framework, with WIA Assessors formally trained by a Registered Training Organisation (RTO), and accredited and registered by the WIA.

By April 2005 I was able to report that from my meetings with many clubs I was satisfied there was real support for such a system, and so the planning continued. Ultimately, in June 2005 we were successful in finding a formula of words that satisfied us that ACMA would recognise the proposed qualification for

issuing certificates of proficiency and satisfied ACMA that they would not be embarrassed in the context of a possible tender for the further outsourcing of the amateur examination function. In August and September 2005 assessor training courses were conducted in Brisbane, Sydney, Melbourne and Adelaide by the WIA's RTO.

The WIA must be satisfied that a WIA Assessor is a fit and proper person to be accredited and registered and so a police clearance is required, mandatory in a number of states for persons responsible for young people. Because we take some responsibility for the Assessors, and because we wish them to be covered as WIA members by the WIA QBE Public Liability policy, we insist on Assessors being WIA members and because we believe the assessors should be supported by a club, ordinarily we insist that an Assessor be nominated by a club.

Today there are some 93 accredited and registered WIA Assessors, and some 15

Nominated Assessors, from right across Australia.

Currently, some 50 further potential assessors have just been trained or are awaiting training at assessor training courses to be conducted in Melbourne, Sydney, the Gold Coast and Townsville.

By the time the first assessor training course was conducted an Assessment Instructions manual had been prepared, and the training courses identified many of the deficiencies that could be corrected by the time the first Foundation courses were being conducted.

As well, the extremely well received Foundation Licence Manual written by Ron Bertrand and Phil Wait was being completed and printed. All the material needed by a Foundation licence candidate was available in one attractive package.

**3 year warranty now  
on the big 4 — ICOM,  
ALINCO, YAESU and  
KENWOOD**

## Andrews Communications Systems

### ICOM DISCOUNTED

IC-756 Pro III HF+6m	<b>\$4,999</b>
IC-V8000 2m 75W	<b>\$399</b>
IC-746 Pro HF+6m+2m	<b>\$2,699</b>
IC-706 Mk 2G HF-70cm	<b>\$1,399</b>
IC-718 HF SSB	<b>\$999</b>
IC-910H 2m+70cm SSB	<b>\$2,199</b>
IC-208H 2m+70cm	<b>\$579</b>
IC-2200h 2m 60W	<b>\$399</b>
IC-T90A Triband h/h	<b>\$449</b>

**\*3 YEAR WARRANTY\***

### ALINCO

#### Factory Direct Importer

NEW DR-635T Twinbander	<b>\$699</b>
DR-605E Duplex dualband	<b>\$499</b>
DR-135T Mk2 2m 50W	<b>\$349</b>
DJ-V5E Dualband handheld	<b>\$499</b>
DJ-X2000E Hi-tech scanner	<b>\$699</b>
DJ-X10E All-mode scanner	<b>\$499</b>
DJ-596T Dual band handheld	<b>\$349</b>
DJ-C7 Tiny dualband h/h	<b>\$299</b>

**\*3 YEAR WARRANTY\***

Spectrum Analysers from	<b>\$1499</b>
Oscilloscopes from 20MHz to 100MHz	

### ICOM IC-7000 \$2199

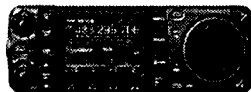

**HF-70cm COLOUR TFT DISPLAY**  
IF DSP, Twin PBT, 508 channel memory + more

### bhi DSP NES10-2

**Amazing DSP speaker**

**100's sold!**

**\$249**



### KENWOOD DISCOUNTED

TS-570SG HF+6m+ ATU	<b>\$1,999</b>	TM-271A K 2m mobile	<b>\$349</b>
TS-480HX HF 200W+6m	<b>\$1,999</b>	TM-D700A Dualband Mob	<b>\$899</b>
TS-2000 HF-70cm + ATU	<b>\$2,799</b>	TS-480SAT HF+6m+ ATU	<b>\$1,799</b>
TS-570DG HF + ATU	<b>\$1,699</b>	TM-G707A 2m/70cm mob.	<b>\$499</b>

**\*3 YEAR WARRANTY\***

### YAESU DISCOUNTED

FT-1802M 2m 50W Mob.	<b>\$289</b>	FT-60R Dualband h/h	<b>\$349</b>
FT-7800R Dualband	<b>\$449</b>	FT-817ND HF-70cm Port.	<b>\$1099</b>
FT-8900R Quadband	<b>\$799</b>	VX- 1R H/held 2 batts	<b>\$249</b>
FT-8800R Dualband	<b>\$699</b>	VX- 2R Tiny Dualband	<b>\$319</b>
FT-897D HF-70cm	<b>\$1,399</b>	VX- 170 2m H/held	<b>\$269</b>
FT-857D HF-70cm	<b>\$1,299</b>	VX- 6R Dual H/H	<b>\$469</b>
FT-2800M 2m 65W	<b>\$299</b>	VX- 7R Deluxe H/H	<b>\$549</b>

**\*YAESU ROTATORS DISCOUNTED\***

**\*3 YEAR WARRANTY\***

**Australia's Biggest Amateur Radio Stockist**

### NEW!

ANDREWS DUALBAND WHIPS frm \$49 (similar Diamond). Factory Direct Importer!  
ANDREWS BATTERIES New fr. \$29!  
DIAMOND, MALDOL, COMET, HUSTLER, and HIGH SIERRA antennas all in stock.  
THP, LDG, MFJ, ALINCO, ICOM, YAESU Automatic antenna tuners in stock  
TET-EMTRON HF Antennas in stock  
AVAIR POWER METERS, "T" LEADS, ETC.  
MFJ Antennas, Tuners, Analysers, etc.  
ANDREWS AMPS ..160m-10m 500W+ w/protect. \$999, 2m 120W \$329, 200W \$449, 300W \$999.  
ANDREWS YAESU, PALOMAR, TE SYSTEMS, AMERITRON, ICOM linears

### ANDREWS AMATEUR BASE ANTENNAS

BF-2M2 Fibreglass 2m 6.7dB	<b>\$99</b>
BF-2M3 Fibreglass 2m 7.8dB	<b>\$129</b>
UVS-200 Fibreglass 6dB/8dB	<b>\$149</b>
UVS-300 F/glass 8.3dB/11.7dB	<b>\$199</b>
CBS18 Fibreglass 5.7dB 10m	<b>\$149</b>

Discones from \$129, Coax switch \$29

We export worldwide. We also hold some stock in New Zealand!

**CALL (02) 9636-9060 or (02) 9688-4301 or FAX (02) 9688-1995**

**Shop 8, 41 Bathurst St., Greystanes, NSW 2145**

**MAIL ORDER to PO Box 240 PENDLE HILL NSW, 2145**

**http://www.andrewscom.com.au**

**email: lee.andrews1@bigpond.com**

**WHY PAY MORE?**

Some items indent.  
Prices subject to change without notice.  
Limited stock some items E&OE 4/06

On the weekend before the actual Amending Determination to create the Foundation, Standard and Advanced licences came into effect on 19 October 2005, the first Foundation training course and assessments took place at the Gold Coast Amateur Radio Society with 16 candidates determined to be competent. Their WIA qualification was recognised by ACMA and so a week later the first Foundation licences were issued.

Let us not underestimate the load this has imposed on the WIA.

Since the start of October 2005, the WIA office has prepared some 1,100 Foundation Assessment Packs.

Of those Packs, 589 have been returned.

In order to minimise the delay in the issue of a licence the WIA will process the candidates' applications for certificates of proficiency and apparatus licence applications if candidates wish and provide the necessary forms and payment. By 28 April 2006, 426 candidates had taken advantage of this service.

Certification of results has been sent direct to 163 Foundation candidates, for them to forward to ACMA.

As at 2 May 2006, in some 6 months since the category of licence was created, ACMA has now issued 502 Foundation licences.

So, we have in a few months celebrated the first Foundation licence, and now the 500<sup>th</sup> Foundation licence. By an extraordinary coincidence, both the first and the 500<sup>th</sup> come from southern Queensland.

And, by a further extraordinary coincidence, the 500<sup>th</sup> Foundation licensee is John William Owen VK4FRUM. What a great name!

The distribution by state/territory is interesting:

VK1 20	VK2 138
VK3 161	VK4 57
VK5 63	VK6 24
VK7 38	VK8 1

In the same period, 18 candidates have qualified for the Standard licence and 6 have qualified for the Advanced licence.

Standard/Advanced Regulations and Standard and Advanced Theory Packs are now available, and the 3<sup>rd</sup> Revision of the Assessment Instructions has been produced and circulated, to take into account the new packs, and to provide greater simplicity.

Now, some 37 clubs in all states offer Foundation licence training courses and assessments, and clubs from Hobart to Cairns and Darwin, and from Perth to Sydney and Melbourne have through their Assessors the ability to qualify all 3 grades of amateur licence.

As I look back over the past 12 months, I can say that a great deal has been achieved. We have a completely new assessment system, able to cope with the need for practical assessments, and we are able to provide immediate guidance and

feed back to candidates. We have shown the ability to attract and qualify new entrants to amateur radio.

And I suggest that the number of new amateurs in the last 6 months demonstrates the value of all this effort.

This has been achieved through the efforts of very many people, each working within their own area of skills, but working together to achieve a result.

I cannot mention everyone who has contributed to what has been achieved but let me mention some:

Fred Swainston VK3DAC, of Train Safe, the WIA's nominated RTO who has spent so many hours and days training and qualifying Assessors, keeping records, advising generally and in particular in relation to the Instructions, and helping define solutions to so many new issues;

Ron Bertrand, who not only wrote the Foundation Licence Manual with Phil Wait, but with others represented the WIA in the formulation of the new syllabi, (and did most of the work) and also prepared the basic question banks;

Robert Broomhead, who produced the photographs for the Foundation Licence

## Australian made ANTENNAS Setting a new standard COM-AN-TENA

(formerly a j and j coman)

115 John Street  
GLENROY 3046

23 cm 36 ele slot fed yagi beam	\$190
2 ele delta loop 10/11 metre	\$249
2 ele quad 10/11 metre	\$249
10/11 beams comp opt 5 ele	\$327
10/11 5/8 vert 4 rad 1/4 wave	\$185
Tri band IIB 35 C 10/15/20 m	\$745
3 ele 20 m comp opt	\$460
log periodic 9 ele 13 30 8.4 boom	\$990
MBV 6-12-15-17-20-40-80	\$390
40 m linear loaded 2 ele beam	\$595
M B Vert auto switch 10/80 m	\$330
6 m 7 ele yagi beam 60 mm boom	\$387
6 m 5 ele comptr opt beam	\$275
Top loaded 160 m vert	\$430
10 ele high gain 2 m 3.9 m boom	\$149
17 ele high gain 70 cm 3m boom	\$129
Rotable dipole 40 m	\$250
80 m top loaded vertical	\$239
dual band 2 m & 70 vert	\$140

### Guyed Masts

**21 metres**                      **13 metres**  
Winch-up & tilt-over. Aluminium and stainless steel  
three-sided construction. Auto-brake winches.

### Free Standing Masts 9.5 metres

**New Baluns**  
1-1 to 16-1 to 3kW



Our Masts  
meet Australian  
Standards.  
We supply all the  
computations and  
data you will need for  
a permit.

**03 9773 3271**  
**Mob: 0419 542 437**

# President's Report

Manual and managed its production, and also is developing the software to produce the Assessment Packs and manage the whole assessment process and create the records that we need;

Of course, the many people from so many clubs who have supported the change, and particularly all those who have given up a whole weekend for training, sometimes travelling quite some distances and who have, since then, given up further weekends to assist at Foundation courses;

Alan Jordan of ACMA for his invaluable advice and guidance, and Margaret Wattam of ACMA, who has helped us in streamlining the forwarding of certificate and licence applications;

Emma Trebilco, Brenda Edmonds and more recently Margaret Webb, who have provided the office support, the packs and the administration;

And finally, the man who has made it his mission to make it all work, and to organise the Assessor Training courses, the man who lives on the phone, our secretary Chris Jones VK2ZDD.

## 4. Board

In accordance with the Constitution adopted on 16 May 2004, 3 directors stood down and offered themselves for re-election.

Nominations were called for and as there were 4 candidates for 3 positions, an election was conducted in accordance with the regulations for the conduct of a postal ballot that had been adopted by the Board.

David Wardlaw, VK3ADW was appointed Returning Officer by the Board, and as announced formally at the Annual General Meeting, the result of the ballot was:

Trevor Quick VK5ATQ, 715 votes, elected

Robyn Clare Edwards VK6XRE, 694 votes, elected

Philip John Wait VK2DKN, 694 votes, elected, and

Edward (Ted) Thrift VK2ARA, 477 votes.

I think we can all be immensely proud that some 960 odd members voted. That is nearly one in 4 members, and says a great deal about how the WIA has changed to a single national entity, with all members having an equal say.

Ted Thrift has contributed much to the WIA during his term as a director. He has taken special responsibility for the WIA's publications, attending virtually all Publications Committee meetings by phone, and has been very much involved in the Call Book.

Ted took a special responsibility for the clubs, and elsewhere I report on the problems we have experienced in the office. When it became apparent that the office would not be able to cope with handling the club's insurance renewals, Ted took on that task – not merely a matter of sending a reminder, but chasing down all the clubs that did not respond, which meant finding the person who was responsible this year for that matter.

The Board is very grateful to Ted, and took the view that to lose his special knowledge and enthusiasm would be a terrible mistake, and so the Board has created the role of National Club Coordinator, and appointed Ted to that position. So, that way, we do not say farewell to Ted.

But we do say welcome to Robyn Edwards VK6XRE. The Board of the WIA succeeds simply because each of the directors contributes his or her special skills to look after particular areas or projects. I am sure that Robyn is going to work very hard for us, too.

As reported in our formal report submitted to the Annual General Meeting, during the calendar year one meeting of Directors was held, and since then a further meeting was held in February. Following the meetings today, a Board meeting will be held tomorrow, Sunday.

Also, as reported formally, the directors communicated regularly by email and phone and during the year all directors signed 98 Resolutions pursuant to clause 18.10 of the Constitution.

These Resolutions dealt with the admission of new members (46), the affiliation of clubs (36), and the balance (16 resolutions) dealt with banking, the approval of the reimbursement of directors' expenses, the adoption of a 5-year subscription, the appointment of an Assistant Treasurer, the transfer and subsequent sale of the property at Humpty Doo in the Northern Territory, the appointment of QSL and Repeater coordinators, the adoption of postal

election regulations, various matters relating to the adoption of a new amateur competency assessment system and the accreditation of assessors.

## 5. Office

At the last Open Forum I reported that June Fox would retire in a few weeks, and from 2 May 2005 Ms Judith Oliver worked with us to replace June.

Emma Trebilco continued to work on a part time basis for the WIA, providing a much needed continuity and knowledge. However, toward the end of last year she decreased her working hours, as she wished to increase her time with another employer who she believes offers her better opportunities than the WIA.

Emma has been extremely loyal to the WIA, working at weekends and at nights when our situation has been desperate, and she has continued to work 3 days a week when she can, training new staff and generally assisting us.

Except for about 3 days in January, Ms Oliver has been unable to work since 20 December 2005 because of a medical condition.

In this very difficult period, since about November last, we have taken a number of steps to overcome our problems.

John Weir, VK3ZRV has accepted the job of dealing with the orders for the Call Book and the Foundation Licence Manual, from recording payments to packing and dispatching the books.

Brenda Edmonds has worked in the office up to 3 days a week, rather than the one she ordinarily gives to assist us.

For many weeks we relied on the answering machine to record questions, so that they could be referred to someone out of the office to answer questions, usually Chris Jones.

A great many entries in the WIA's accounting software were wrong, and virtually none were made during the last 3 months of the 2005 financial year. Bruce Bathols spent very many hours putting the accounting records into order prior to the audit.

The result of all of this is, particularly from October last and the first 3 months of this year, the WIA has not delivered the services to its members and others at the standard to which we had aspired.

Membership applications were not processed as promptly as we had wished,

# President's Report

inquires were ignored, changes of address were not recorded, AR non-deliveries were not adequately followed up, and many inquiries were left unanswered.

All I can say is that the Board is very conscious of these problems, has been constrained in what it can do by reason of the legal obligations imposed on it in these circumstances, and can only apologise to our members and assure you that we are doing our best to overcome these problems as quickly as we can, subject to the constraints of a limited budget and our obligations set by law.

In recent weeks, Margaret Webb has joined the staff at the national office.

## 6. Office Equipment/ systems

During the period under review the accounting software was changed from QuickBooks to MYOB, the first 3 months of the last financial year being the old software, since then the MYOB.

During the year, Access based membership management software was developed, to replace the very old software.

A consultant was retained, and worked closely with the director responsible, Robert Broomhead.

While the transition caused a delay in the issuing of renewal notices last June, and has taken some time to debug, the new system is now working very well.

Currently Robert is creating yet another system, this time to manage the examinations, creating the various Assessment Packs, generating the various documents and maintaining records.

In May/June last year, new furniture was acquired for the office, and a new second hand photocopier, printer, fax was acquired. At the same time, WIA Vice President, Ewan McLeod spent time in the office sorting old documents, books and magazines, throwing out what should be thrown out, and removing to storage what was needed, all to give us some more space in what is essentially a very overcrowded office.

## 7. Clubs

Once again, I remind you of the importance the WIA and its Board has placed on clubs. Our whole approach to the training and assessment of amateurs relies on the support of the clubs. It can be no other

way. The number of WIA Assessors, and the number still seeking training, the number of clubs conducting courses, is the clearest evidence that this partnership is successful.

While Ted Thrift reports separately on clubs, in this report I record that there are now over 100 affiliated clubs of the WIA. That is heartening.

One of the concerns with the restructuring of the WIA was the possible effect on the availability of public liability insurance for the clubs. The WIA promised, in effect, to do its best to meet that need.

Ultimately the QBE Broadform policy was chosen, but with endorsements that made it clear that both the WIA and the insured clubs were insured, and also their members were insured as set out in the policy. Certain volunteers were also covered. And because the WIA premium is calculated on the number of members, the clubs do not pay premium on their members who are also WIA members.

I believe the insurance does represent a real service provided by the WIA for the clubs.

During the period I have continued to visit as many clubs as possible.

In October 2005 I attended a meeting of representatives of some 13 clubs in Brisbane, then in early November I visited clubs in Northern Tasmania and in Hobart. Later in November I attended a joint WIA/ARNSW club conference held in Sydney. At all of these meetings the role of the clubs in attracting new amateurs, training them and finding and then supporting the Assessors to qualify the new amateurs was the major matter for discussion.

I must say that I have found the support for the WIA's efforts to increase the number of amateurs through the Foundation licence very heartening.

The only thing that concerns me is that I wonder at times whether each club is really doing its best to promote membership of the WIA to its members. That is another and important aspect of our partnership with the clubs.

As I said last year, unashamedly, we are asking the clubs for their support and for them to work with us to encourage more members, and to make sure that their members are also members of the WIA.

## 8. Club Grant Scheme

The Board initially allocated \$1,500 to fund a small number of grants to qualifying Affiliated Clubs this year, and has now increased the amount to \$5,000.

The Clubs Grant Scheme is based on the previous Queensland model, where clubs were invited to make submissions for assistance for particular projects.

Details were on the WIA website a few days ago and will be also available at the Open Forum.

## 9. Gifts

Henry Andersson, VK8HA, who had become a member of the national body as soon as he could, and who died in Darwin in October 2004, left the WIA his house and land at Humpty Doo.

As announced last year, the Board decided to sell the property and I was able to visit Darwin, meet the Trustee's officers, appoint solicitors and estate agents and ultimately the WIA received \$252,722.42 after meeting all expenses.

The Board has yet to determine how best to establish a lasting memorial to Henry Andersson's memory and generosity.

In October 2005 I accepted on behalf of the WIA a cheque for \$10,000 from one of the 'greats' of Australian amateur radio, Al Shawsmith VK4SS who indicated his wish that the money would be used for educational purposes or in support of WIA educational activities.

## 10. Publications

Ted Thrift has continued to take special responsibility for publications and we have both continued to attend as many Publications Committee meetings as possible, Ted by telephone.

With the final edition of AR for 2005, Colwyn Low VK5UE finally got his wish and retired.

We acknowledge with gratitude Colwyn's great contribution to the WIA as Editor, and on a personal note, I thank him sincerely for staying on at my request for as long as he did.

We are delighted that Peter Freeman VK3KAI, of GippsTech fame, has become editor.

To our entire Publications group, on behalf of us all, I say a very sincere thank you for all you do.

# President's Report

## 11. *Broadcasts*

The Q-News team, led by Graham Kemp VK4BB, has continued their fantastic job of producing the VK1WIA weekly broadcasts.

To everyone who contributes, thank you.

## 12. *WIA Website*

The WIA website continues to be the primary location of new information, and with as much other information as possible being found there.

We continue to seek to make it a little more user friendly.

During the period since our last report, ownership of the ISP providing our server changed, and we acknowledge with gratitude the support that we have continued to receive from Vintek Pty Ltd of Adelaide.

Our thanks to Colin Thompson VK2TRC and director Robert Broomhead VK3KRB for their work with the website over the period.

## 13. *Intruder Watch*

In various roles over quite a few years I have been able to observe the Intruder Watch activity.

I happen to believe that it is very important, even though victories may be few and far between. It is one of those activities where we will never be able to measure accurately its worth, simply because we will never know how many potential intruders have been deterred by the knowledge that the amateur service, nationally and internationally, will complain.

Last year we reported that Glenn Dunstan was taking responsibility "for the time being". I believe that we should be very grateful that Glenn has continued his career as an Intruder Watcher!

## 14. *ITU Matters*

As David Wardlaw reports, WRC 07 is scheduled for October/November next year.

Two agenda items directly concern the amateur service. One is the review of the allocations to all services between 4 MHz and 10 MHz, excluding 7000 to 7200 kHz, and the other is the proposal to allocate 135.7 to 137.8 kHz to the amateur service on a secondary basis. Other items could also have an impact on us.

The WIA continues to participate in

Australia's WRC preparation and as a member of Study Group 8.

May I particularly thank Keith Malcolm VK1ZKM and David Wardlaw VK3ADW for their work in this area, and Keith, also, for his ever willing assistance on so many matters, particularly when we want yet another submission prepared.

## 15. *Marketing, Image*

Last year I referred to the adoption of new, more relevant and more appropriate imagery to promote amateur radio and the WIA.

The posters that had only just been produced last year have continued to be used around Australia at various club functions and continue to attract favourable comment.

The Foundation Licence Manual has also attracted much favourable comment in providing a younger more relevant image.

## 16. *Membership*

Under this heading I repeat some information from the statutory report accompanying the financial statements presented to the Annual General Meeting.

In the Open Forum Report last year I reported, after making adjustments that were intended to allow for the distortion caused by the Provisional Members, that the total membership was 3494, virtually the same number as the previous year. In the statutory Report we said there were 3851 members on 31 December 2005. As at today there are 3870 members.

While the true numbers were hard to measure last year, we can have confidence in the current numbers, so whilst last year we were able to say that at least the decline in membership had been stopped, we can now say that the membership is growing.

Last year I reported that in the period from 16 May 2004 to May 2005, 323 people joined or rejoined the WIA. In the period from 1 July 2005 to now, 361 people have either joined or rejoined the WIA.

As stated in the statutory report, the 5-year membership has been very successful, with today some 317 members having taken up that option.

In the period since 1 July 2005, we have been advised of (and recorded) the passing of 27 members. Obviously, the real number is much higher, as we are only advised of a certain number.

The challenge remains to attract new members. I advert to that in the context of the clubs. But in the present context I should tell you that ACMA has recently agreed to the WIA including WIA promotional material in letters confirming a successful outcome for examination/assessment candidates and we certainly now intend to do that, also including a copy of AR.

Our target must particularly be the Foundation licensees.

## 17. *IARU Region 3*

With the death of Peter Naish the WIA lost a valuable source of advice about Region 3. Peter was a director, and while as such he did not represent the WIA, rather was bound to act for all members

(in the same way as the WIA directors act for all members and do not represent any particular group of members), Peter was able to ensure that the Board did understand Region 3 matters.

The WIA is a founding member of IARU Region 3.

Region 3 is important to the WIA for a number of reasons:

One is that our representative and coordinator at the ITU, ultimately the body that allocates spectrum to the various services including the amateur service, is the IARU, and Region 3 is our means of input to the IARU, and our representative at a regional level, particularly to the APT.

Another reason is that nearly one dollar of every member's subscription goes to Region 3 as the WIA's subscription, and in addition the WIA must meet the cost of participating in the Regional Conference every three years.

The WIA must participate effectively and the regional organisation must also

**In the Open Forum Report last year I reported,... that the total membership was 3494, virtually the same number as the previous year. ...**

**As at today there are 3870 members.**

# President's Report

be effective to justify this significant expenditure.

The next Regional Conference is to be held in Bangalore, India from 7 to 11 August this year. The host society is The Amateur Radio Society of India (ARSI).

The Board reviewed the WIA's participation in Region 3 at its last meeting, and will further review our position at our meeting on the day following the AGM.

The WIA has considered the most constructive suggestions advanced by SARTS for improvement to the Region 3 Constitution, and tends to agree with their basic concerns, though we would be concerned if such issues ended up dominating the activities of the Region during this critical period immediately before a WRC that does have potential impact on the amateur service.

At the 2005 IARU Region 3 Directors meeting held in Bangalore in October 2005, Jim Linton VK3PC, nominated by the WIA was appointed temporary Chairman of the IARU Region 3 Disaster Communications Committee. Jim's term of office will be until the Bangalore Conference.

I believe that is an important position, for while Jim may face inertia from some member societies, as I say in a different context, with the changes to Article 25 made by WRC 03, the capacity of the amateur service to engage in effective international emergency communications is important.

## 18. Advisory Committees

The WIA Constitution requires Advisory Committees, initially the Divisional Councillors of the former Divisions, after 3 years elected, to advise the Board.

The fact that early next year is the first elections for members of the Advisory Committees will force the Board to formulate the regulations for that to occur.

That is our next task.

## 19. QSL Service

In July 2005 the Board appointed Neil Penfold VK6NE as National QSL Bureau Coordinator to manage and promote this important service for members.

Members and bureau managers are encouraged to contact Neil if they need

assistance in relation to any aspect of the QSL service.

## 20. QSL Curator

Once again I record that Ken Matchett VK3TL continues to collect the most interesting and most important QSL cards.

He has provided a separate report to the Open Forum, and you will see his concern as to where, in the future, the WIA will be able to store this valuable Collection.

## 21. History

The previous WIA Historian John Edmonds has continued to look after a significant volume of historical material.

To the delight of the Board, Will McGhie VK6UU has accepted the position of WIA Historian, and is currently engaged in scanning old ARs. This will preserve our history and hopefully provide CDs that members will be happy to purchase.

## 22. Contests

Trevor Quick is the director who takes primary responsibility for Contests and Awards.

The national Contests Co-ordinator is Ian Godsil VK3JS.

Contests are an important aspect of the WIA's activities, and it is pleasing to note that they continue to attract attention.

The Board relies heavily on the expertise of the dedicated team who manage the various contests and we thank them for their efforts.

## 23. Awards

Malcolm Johnson VK6LC is the national Awards Co-ordinator, and has spent much time updating the WIA awards to reflect the new structure, and enhance the WIA awards as described in his report.

We thank Malcolm for his enthusiastic support.

## 24. Emergency communications

There are separate WICEN organisations in each state, not necessarily associated with the WIA other than (usually) as an affiliated club.

The Board is very aware of the importance of international emergency communication since the changes to Article 25 at WRC 03, but is very unsure

# Amateur Radio Bookshop

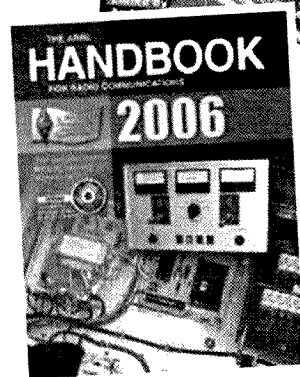

Download our catalogue at

<http://www.wia.org.au>

Amateur Radio Bookshop

PO BOX 3084

EAST BLAXLAND

NSW 2774

Office: WIA National Office

Tel 03 9528-5962

Fax 03 9523-8191

[bookshop@wia.org.au](mailto:bookshop@wia.org.au)

**ARRL - RSGB  
publications  
- books  
- magazines -  
CDROMs - DVDs**

# President's Report

of the role, if any, of the WIA.

Accordingly Ewan McLeod has been given the task of providing the Board with a report, setting out the current position and addressing all the associated issues, including, for example, general emergency capabilities by amateurs generally outside the WICEN structure.

The Board, when properly advised, will develop a policy in relation to this general area.

Following a request from the WIA, ACMA has allocated the WIA two 5 MHz HF land mobile channels for WICEN use.

The 5 MHz channels will provide significant enhancement of WICEN capabilities. They will bridge the frequency gap between the 80 and 40 meter bands, and allow the use of Near Vertical Incidence Skywave (NVIS) propagation to provide coverage into areas outside of VHF range.

Because these channels are part of the commercial land mobile service, the use of amateur transceivers and call signs is not allowed. Only ACMA type approved land mobile equipment may be used.

ACMA has also agreed to waive the licence fees for these channels on the basis of WICEN use.

## 25. *Some other matters*

There are some matters that should be included in this report for the sake of completeness, and I mention them very briefly as follows:

### ACMA matters

Apart from the matters already mentioned, the WIA has been in regular communication with ACMA on many matters, including the clarification of when a practical assessment is required. The WIA was able to advise its members that amateur qualifications obtained before the new licensing arrangements came into force in October 2005 would continue to be fully recognised, so that persons holding an AOC or AOLCP will be granted an Advanced Licence without having to undergo a practical assessment. Similarly, persons holding an NAOCP or NLAOC will be granted a Standard Licence without having to undergo a practical assessment. However, this is being applied very strictly, so it seems that being qualified without having the certificate of proficiency is not enough.

When the new Foundation licence came into effect on 19 October 2005, the WIA was surprised that a power limit of 3 watts for AM, FM and CW had been imposed, believing that limit to be unrealistic given the output power of commercially available equipment, particularly older equipment, and that the power limit should be 10 watts. Subsequently ACMA advised that the Foundation licence would be permitted a transmitter output power of 10 Watts pX on all permitted emission modes instead of the present 10 Watts pX for J3E emissions and 3 Watts pY for all other permitted emissions.

The WIA was consulted by ACMA on the possible use of handheld transceivers in the 70 cm band during the Commonwealth Games.

### Bookshop

The WIA Bookshop commenced operation last September.

As is reported in the Manager's separate report, AR advertising has been effective. The WIA will be seeking to make the online Bookshop much more user friendly and attractive.

### Callbook

The Callbook was the result, again, of the work of Brenda Edmonds and Ted Thrift, our editors.

Publication was delayed from late September until November so that the new licence conditions announced in mid October could be included.

The number printed was increased over last year, and despite the delayed publication, sales have been good and only 400 remain.

A number of people have complained about incorrect listings. The information comes from ACMA and the WIA is not permitted to change it. Any changes to call sign, name or address MUST be done by the Licensee advising ACMA, and in time for the change to be in the listings published by the WIA.

Once again, I acknowledge the contribution of John Martin as well as Brenda Edmonds and Ted Thrift.

## 26. *Conclusion*

As I look back on the period since 1 January last year, I believe that the WIA has faced a period of great change, great pressure and great opportunity.

We have had our bad times – the loss of June Fox, the illness over a long period of her replacement, the onerous obligations imposed on employers in Victoria under our Workers Compensation legislation, the incredible pressure placed on our administration by the coincidence of a totally new examination system, the management of training of the assessors, the development and introduction of new membership management software and the introduction of new methods in so many things that haven't worked as easily as we hoped the first time.

But I firmly believe that we have moved further and faster, in response to all the challenges we have faced than would have been even possible under our previous decision making structure.

But I also believe this: what we have achieved has been due to the incredible commitment of a group of people with synergistic skills and a determination to succeed, supported by the incredible

work of volunteers prepared to support us.

But this can only last for so long. For members in most states the national WIA has meant lower subscriptions. The time for confusion as to

what is the WIA, is it still a state body, or something else, has surely passed.

The WIA is an organisation having many complex obligations, and like amateur radio itself, covers many areas of interest.

No organisation like the WIA can ever just stand still. It will either move forward or go backwards.

To continue moving forward the WIA must, in the near future, put itself in the position where it can employ a qualified and competent manager. The hours that some of us put in are, frankly, silly, particularly those trying to earn a living or manage a business at the same time. That is why we need a manager, because

**No organisation like the WIA can ever just stand still. It will either move forward or go backwards.**



we can only ask so much for so long of volunteers.

How do we put ourselves in that position?

By either increasing membership fees or increasing the number of members, or some mixture of both.

That is the future.

We can look to the future because I believe that the year past has demonstrated what a truly national amateur representative and service organisation can do for our great common interest.

**27 A personal note**

Thus far, this report is written for all of the Board, all of whom have seen and agreed with it.

Let me add this personal note.

During the period I report to you I have visited many clubs and met many amateurs. I believe that the WIA must be open and honest, and so members

and potential members should see and hear those who represent them. I simply wish to thank so many of you for your hospitality and courtesy.

This report is a story that I believe is positive, a story of great change, and some real difficulty.

Under the previous heading I address the issue of time and commitment.

Let me now say how much I value the work of so many, and particularly our Board. The directors do not all agree on everything nor should they. But each makes their own contribution, and many give very many hours to the WIA undertaking tasks that are not the usual roles of directors.

To each of you, Ewan, Robert, Trevor, Glenn, Ted and Phil, I acknowledge your work, your commitment and your genuine value.

Bruce, I acknowledge your special contribution as Treasurer, and all you

have done to get our financial reporting and controls in place.

Finally, to our secretary, Chris Jones, and I am sure on behalf of all of us, what you have done to make this organisation, and particularly the assessment system and the new licences, particularly the Foundation licence work is breathtaking. Without you I suspect we would not have moved very far.

I have stressed how much all of us have devoted to our roles. For myself, this has meant that at times I have left unanswered the letter that I should have answered, the email I should have responded to not responded to, and things not done that should have been done. I simply apologise and seek your understanding.

ar

# TET-EMTRON

## Antenna Manufacturers

### New Tet-Emtron Vertical Range Features

- All Aluminium with Stainless steel hardware.
- No adjustment needed to main antenna.
- Light.
- Free standing-no guy wires.
- 1 kW PEP power rating.
- Can be ground mounted or elevated.

The new TET-Emtron Vertical range is designed with ease of use in mind. Tuning is done by the radials when the antenna is in its final position (where possible). The radials can either lay on the ground, be buried or hang from the elevated antenna. The antenna comes with a set of radials that has a resonate radial for each band. Further sets can be ordered from TET-Emtron if desired. See the web site for more info and a complete dealer list.

### New Tet-Emtron Vertical Range

TEV-4      TEV-3      TEV-3Warc

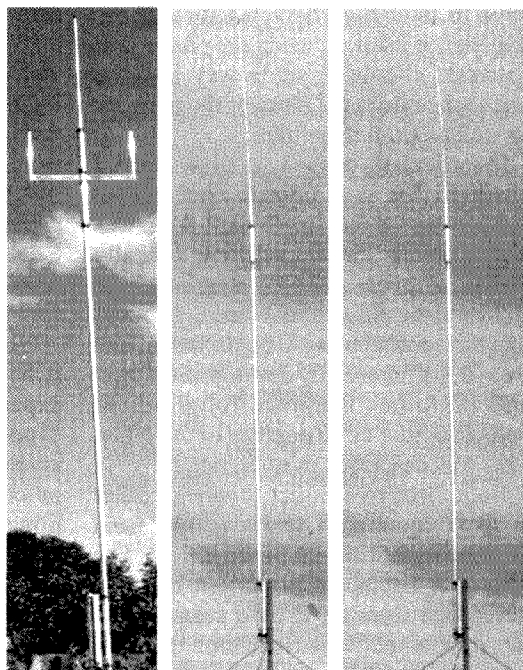

#### Specifications

Antenna	TEV-4	TEV-3	TEV-3 Warc
FREQUENCY	7, 14, 21, 28 MHz	14, 21, 28 MHz	10, 18, 24 MHz
ELEMENT HEIGHT	4090 mm	3800 mm	5025 mm
FEED IMPEDANCE	50 OHM	50 OHM	50 OHM
MAX. RADIAL LENGTH	10.7 Meters	5 Meters	7.5 Meters
SWR	1.5 or less	1.5 or less	1.5 or less

40 Blackburn Street  
STRATFORD  
Victoria 3862 AUSTRALIA

Ph: 61 3 5145 6179  
Fax: 61 3 5145 6821  
ABN: 87404541761

[www.tet-emtron.com](http://www.tet-emtron.com)

Email: [rawmar@hotmail.net.au](mailto:rawmar@hotmail.net.au)

# Some different ideas on the EH antenna

Lloyd Butler VK5BR

A lot of theory has been written about the EH Antenna and its operation in a Crossed Field mode. However, here are some measurements and test details which support some different ideas of how and why the antenna is able to perform.

## Introduction - Background of Theories Concerning the EH Antenna

The EH Antenna was introduced as a small dipole making use of the controversial Crossed Field Theory. One of the conditions for this mode of radiation is to arrange the magnetic (H) field in phase with the electric (E) field. The original theory provided by the inventor was based on feeding the antenna through a 90 degree phase shift network which, he claimed, shifted the current fed into the antenna by 90 degrees relative to the voltage across it. This didn't make any sense as you cannot alter the phase relationships within any load impedance from outside the impedance. You either have to alter the characteristics of the impedance itself or, using the phase shift network, couple in some way into the impedance from the input of the network as well as from its output.

In earlier tests on the L+L EH antenna, I observed that, in addition to a differential voltage across the dipole pair, there was also a voltage developed longitudinally and this appeared as 90 degree phase shifted to the differential voltage. I figured that there must be two E fields acting, one from the differentially developed voltage, and the other from the longitudinal voltage acting at 90 degrees to the other. This was described in reference 1.

Both these two earlier theories further evolved around an H field developed from Displacement Current of the E field. The idea of a displacement current in space developed from an E field seems to be more of a mathematical tool used by Maxwell to explain fields and radiation rather than a physical identity. The validity of that theory has been questioned by many.

Getting away from that theory, I moved towards using direct series current for the

H field as something easier to accept. I figured that using the H field developed from the series coils would put that field in phase with the E field across the dipoles, and this led to the construction of my X2/X3 antennas. To verify the theory, I set up a test to monitor the relative phases of the actual E and H fields and confirm that they were in phase. The test was described in one of my articles on the X2/X3 (Reference 2).

Antenna series resistance is easily measured using the X2 antenna circuit and this proved to be considerably higher than that of the coil loss resistance. I had always figured, for EH or any of these small antennas, that, if we could show considerable resistance rise above that of the coil resistance and much more than the calculated radiation resistance of a simple dipole, then the difference increase would surely be increased radiation resistance and improved radiation. Hence, there would be proof that the two fields were interacting to enhance the radiation. I was initially convinced that the rise in series resistance was the result of those interacting fields and that the crossed field enhancement was occurring. However, as I described in reference 3, I eventually discovered other reasons for that rise in resistance.

Getting back to the EH antennas, it became apparent quite early in the experiments that, due to the unbalanced dipole connection in all of the EH antennas, a large amount of longitudinal or common mode current component flowed in their coaxial feedlines. I was able to eliminate this by inserting a tuned balun or trap in the coaxial line, and this prevented interaction between the antenna tuning and the length or location of the line.

What also became apparent was the need for a short length of line feeding the EH antenna to make it work the best. If the trap was placed right at the antenna input, or the antenna was properly balanced,

about two S points in signal level was lost. All the EH amateur antennas are unbalanced and it has become clear that they need a longitudinal or common mode current component operating over at least a short section of the transmission line to achieve performance. The main theme of this article deals with the measurement of that current component and some theories on how the antennas work without the crossed fields.

It is interesting that the VK5BR -X2/X3 antennas started off as balanced crossed field antennas. Similar to the EH antenna, their signal level improved by about two S points when the antenna was connected up in an unbalanced mode to become the X3U. This was discussed in my last article on the X3 (Reference 3).

Because of these observations, I set out to measure in more detail the currents running in the two legs of the coax feeding the EH antenna, and also the currents running in the individual dipole legs. What follows is detail of the test gear used, the measurements carried out, and conclusions drawn from the measurements.

All in all, it does appear that the successful performance of the EH antenna is more to do with the longitudinal conduction path down the cable extending the effective antenna length, rather than due to the Crossed Field theory. Evidence of the conduction path is shown by the common mode current which can be tracked down the full length of the coaxial transmission line.

The common mode currents can be blocked by a trap anywhere in the coax cable to limit the length of the longitudinal conduction path to the distance between the trap and the antenna input connection. Even if this distance is quite small, it can be quite effective in increasing radiation resistance to improve radiation efficiency.

## Specification of test gear

This section quantifies the calibration and performance characteristics of the test gear used in the common mode testing described in a later section. As the tests were carried out on a 14 MHz EH antenna, the specifications are confined to that frequency.

### Device for measuring common mode current on 50 ohms coax (Refer Fig 1)

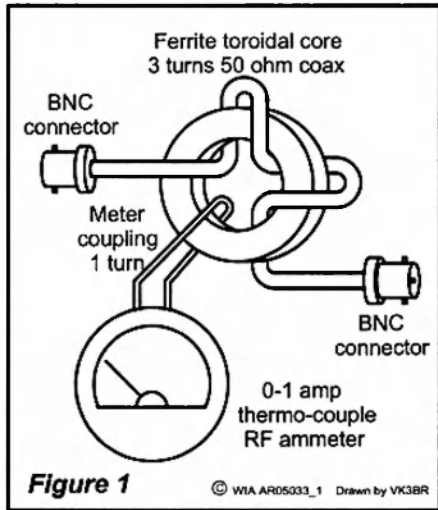

Figure 1 - Longitudinal current measuring device. Toroidal core OD = 41mm, ID = 21 mm, 11 mm thick. Detail of core material not known.

### Calibration

Tests were carried on 14 MHz to determine the effect on the signal passing down the coax when inserting the device in series with the coax. The coax cable was loaded into a Marconi Power Meter which has a precision 50 ohm termination load. Power fed to the meter was registered by the meter scale as 20 watts.

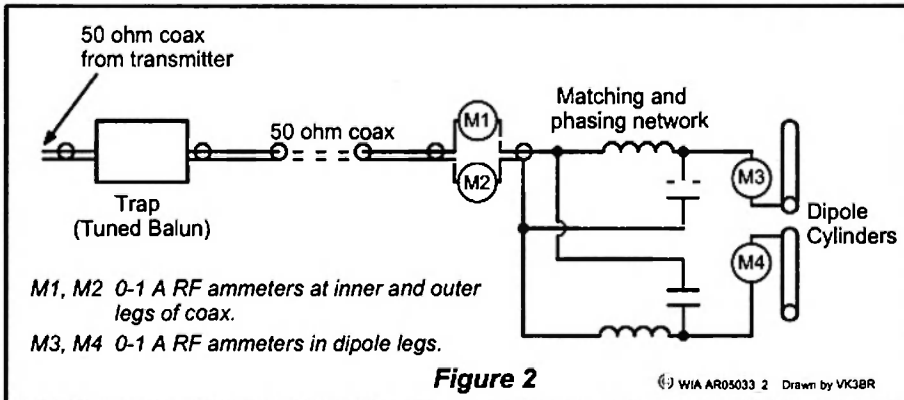

Figure 2 - Measurement of current in coax transmission line legs and legs of dipole cylinders of L+L EH antenna.

An SWR meter in series with the cable read a precise 1:1 ratio. With the device inserted and the SWR meter on the source side of the device, the SWR still read a precise 1:1. Registered power dropped by 1 watt - this calculates to an insertion loss in the device of 0.2dB.

Calibration of the meter current reading at 14 MHz was carried out by passing a current near 2/3 FSD through a wire run through the toroid centre opening. This was compared to the same current with the wire directly connected in series with the RF ammeter. From this, the calibration for the device was determined as 1.2 times the reference direct reading.

### Application

The measuring device is inserted in series with the coax line at any connector junction of the coax using BNC connectors so that the magnitude of common mode current can be derived. (See Photo 1).



Photo 1 Measuring of common mode current on the coax at the input to an EH antenna.

### Direct measurement of current in legs of coax line and legs of dipole cylinders using RF ammeters (Refer Fig 2)

### Accuracy of thermo ammeters

As a check on the accuracy of the thermocouple RF ammeters used in the device (Fig 1) and used as direct reading meters in other tests (refer Fig 2), the current readings were checked against the current calculated from the power indicated by the Marconi power meter scale using  $I = (P/50)^{0.5}$ . For the two RF ammeters used, one read 5% lower than the calculated figure and the other read 7% lower. This is about as good as one might expect from these thermo coupled instruments.

### Device to Measure Maximum & Minimum Common Mode Current points down Transmission Line (Coax or 1/2 inch 300 ohm open line) - refer Fig 3.

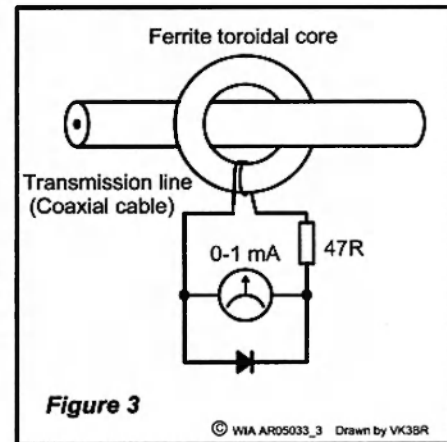

Figure 3 - Device to measure maximum and minimum points of common mode current. Inner diameter of toroid is large enough to slide over BNC connectors at cable ends and also the 300 ohm 1/2 inch TV open line cable used with the X3 Antenna. Toroidal Core - Amidon FC500 Mix 61, OD = 30 mm, ID = 18 mm, 6 mm thick.

### Calibration

Tests were carried on 14 MHz to determine the effect on the signal passing down the coax when inserting the device in series with the coax. The coax cable was loaded into a Marconi Power Meter which has a precision 50 ohm termination. Power fed to the meter was registered as 20 watts.

An SWR meter in series with the cable

read a precise 1:1 ratio. With the device inserted and the SWR meter on the source side of the device, the SWR still read a precise 1:1. Negligible power loss is assumed as there was no discernible change in the power reading.

With 20 watts fed down the cable to the load, the 0-1 mA meter in the device read 0.1 mA. This device is quite sensitive and it has to be used with currents down the line more appropriate to powers around 1 or 2 watts. As such, 0.1 mA represents a very low degree of common mode current relative to the differential currents running for the 20 watts into the load. The device has essentially been used to determine comparative values of common mode current measured at different locations down a transmission line. However, I did determine that 0.22 amp of RF current at 14 MHz corresponded to 1 mA, the full scale deflection of the meter. A reading of 0.1 mA on the meter is therefore 22 mA and 29 dB down on the differential current for 20 watts into 50 ohms.



**Photo 2**  
Measuring of common mode current on open wire line to the X3 antenna.

### Application

The toroidal core is slid down the whole length of the transmission line to record the relative change in common mode current over the length of the line. Points of maximum and minimum common mode current can easily be determined. As a calibration was carried out on the meter relative to actual RF current, it could also be used to determine the magnitude of the current in real terms. Photo 2 shows measurements being taken on the line pair of the X3 antenna.

### Tuned Longitudinal Current Trap for 14 MHz (Photo 3)

The winding is arranged with sufficient turns to resonate at 14 MHz with a 10 pf capacitor fitted inside the PVC tube and connected between the coax outer conductor two ends.

Details of the trap formed are as follows:

- Former - 55 mm PVC Tube
- Cable - RG174
- Winding - 13 turns
- Length of coil - 36 mm
- Inductance - near 11  $\mu$ H
- Q - near 50
- Measured differential through loss at 14 MHz - 0.2
- Estimated longitudinal rejection impedance - 48 kohms

### Measurements of out of balance currents in coax legs and resultant common mode current component.

This section records measurements taken which show the extent to which currents in the coax legs and the dipole legs are out of balance, and measurements of the common mode current component which is developed. The figures show that current in one leg can be as high as twice the current in the other.

### Some initial measurements of Out of Balance Current on the 20 metre L+L EH antenna

The following is one set of measurements recorded to demonstrate the unbalance which occurs between the inner and outer legs of the coax cable feeding the L+L EH antenna. (Refer Figure 2).

**Test series A1.** No Trap fitted. With about 35-40 watts of power and five metres of 50 ohms coax between the transmitter and antenna terminal, the line currents measured as follows:

- 0.5 metres down from antenna:
  - inner coax conductor - 1 amp
  - outer coax conductor - 0.4 amp
- At transmitter end:
  - inner coax conductor - 1 amp
  - outer coax conductor - 0.5 amp

**Test series A2.** Trap fitted at two metres down from the antenna input. With about 20 watts fed from the transmitter, the line currents measured as follows:

- 0.5 metres down from the antenna:
  - inner coax conductor - 1 amp
  - outer coax conductor - 0.5 amp
- Near the output of the trap:
  - inner coax conductor - 0.7 amp
  - outer coax conductor - 0.6 amp
- On cold transmitter side of trap
  - inner coax conductor - 0.58 amp
  - outer coax conductor - 0.58 amp
- At transmitter end of coax:
  - inner coax conductor - 0.58 amp
  - outer coax conductor - 0.58 amp

This demonstrates the extent of the unbalance of currents between the inner and outer legs of the coax, the difference being the common mode current. Without the trap fitted, this out of balance current condition extends right from the antenna to the transmitter output.

It also demonstrates that the trap is effective in restoring balance in the currents on coax connection between transmitter and trap.

People have been talking about induced current running down the coax shield, but observe that the higher current is in the inner conductor, not the outer.

Note also that, even with the trap, there is probably about three metres of considerable longitudinal conduction component flowing between the trap output point and probably near the top of the antenna.

### More measurements of Out of Balance Current on the 20 metre L+L EH antenna (Refer Fig 2)

**Test series B1** - 50 ohm coax cable - nine metres long - trap fitted at transmitter end of this coax length.

Power used about 30 watts to get adequate reading on 1 amp FSD RF ammeters.

- RF Ammeters inserted directly in the wire connected at each dipole leg:
  - Top cylinder - 0.35 amp
  - Bottom cylinder - 0.1 amp (Note 1)
- RF ammeters connected in coax legs 1.5 metres down cable from antenna:

Inner conductor - 0.5 amp  
Outer conductor - 0.2 amp  
Current difference -  
(0.5 - 0.2) = 0.3 amp

Check with toroid coupled instrument (fig 1) around whole coax - 0.3 amp (common mode).

Measurement with toroid coupled instrument (fig 1) right at antenna. - 0.45 amp (common mode).

Test Series B2 - trap moved to 1.5 metres down cable from antenna.

RF Ammeters inserted directly in the wire connected at each dipole leg:  
Top cylinder - 0.3 amp  
Bottom cylinder - barely readable (note 1)

Measurement with toroid coupled instrument (fig 1) right at antenna - 0.4 amp (common mode)

Test Series B3 - trap moved to antenna input point.

RF Ammeters inserted directly in the wire connected at each dipole leg,  
Top cylinder - 0.1 amp (note 1)  
Bottom cylinder - almost no deflection (note 1)

Measurement with toroid coupled instrument (fig 1) right at antenna - no meter deflection (little common mode).

I noticed that one of the two matching inductors was getting quite warm.

*Note 1* - with the cramped scale for low readings on the RF ammeters, it is almost impossible to interpret a reliable figure below 0.2 amp.

The tests clearly show the unbalance of currents extends beyond the transmission line legs to the dipole itself.

### Tests to determine where best to locate the Isolation Trap

The best place to have maximum common mode current seems to be right at the antenna where it can be most effective for radiation. The test was carried out on the 20 metre L+L EH Antenna to determine what length of common mode active cable provided maximum unbalanced current near the antenna input. The active length is set by the location of the trap in the cable. To check this out, the detector (Fig 3) is run down the selected length of the active coax cable section.

Putting the trap (Photo 3) at 4.5 metres down from the antenna input connector seemed to work out well. That provided maximum unbalanced current at the top end of the cable, whilst still maintaining a high value right down to 2.5 metres from the top. Beyond that it tapered down to

almost nothing at the output connection of the trap.

Experimentation with placement of the trap showed that the trap could be put at less than 4.5 metres but, if it was put at a greater length, the maximum unbalanced current point moved down the cable away from the top. So it appears that for the 20 metre antenna, 4.5 metres down from the top, is a desirable place to put the trap. With the addition of the antenna itself, that represents a length of about  $\frac{1}{4}$  wave.

### Explanation of Longitudinal or Common Mode Current

Let us consider any two wire transmission line. Each leg of the line develops a magnetic field. The currents in the two legs run in opposite directions and, if these currents are equal, the fields cancel and there is no resultant field. If the currents are not equal, then there is a resultant field equivalent to that being generated by a current equal to the difference between the two individual currents in the two legs. This equivalent current difference is called the longitudinal mode current or common mode current. Note that its vector direction is that of the leg which has the highest individual current of the two.

The concept might be easier if you think of the two legs in a balanced line pair such as open wire line or twisted cable pair. Of course, there are also the electric fields around each leg of the pair and, for balance, each leg must also have equal capacitance to ground or other adjacent objects.

The coaxial cable is different in that the electric fields are confined to within the dielectric space between the inner and outer conductors, and are shielded from venturing into outer space by the concentric nature of the outer conductor.

In trying to understand something like this, one has to first consider the case where frequencies are lower. Hence, the line lengths are short enough compared to a wavelength such that standing waves are practically non-existent.

In fact, you can take the balanced line pair which feeds your home telephone.

Any competent telecommunication technician could tell you that if you get an unbalance to ground due to resistive leakage or capacitive unbalance, some of the current in one line leg can return via the ground path instead of via the other leg. So we get an imbalance of current

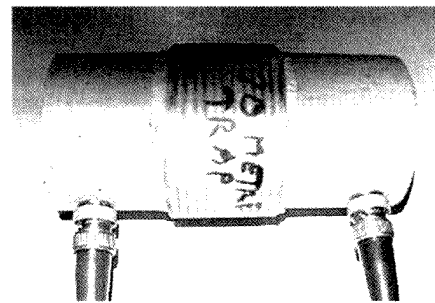

Photo 3 20 metre tuned trap.

flowing in the two line legs. Because the individual fields around the line legs no longer cancel, the line can induce crosstalk into other circuits and, vice versa, the line can pick up noise from other fields in the vicinity.

Of course, for the EH antenna, we are concerned with coaxial lines but the process I have described is the same. If there is an unbalance of resistance or reactance to earth by the antenna at the coax end, then some current from one leg returns via earth. The vector sum of the current in the two legs, plus the current in earth, must be zero. Hence, there has to be more current in one leg than the other.

The effect of unbalanced capacitance to ground, and how longitudinal or common mode current component is generated, was described in reference 1. However, I did not explain how the effect is multiplied by the Q factor of the antenna tuned circuit. This is demonstrated in more detail by Fig 4 (page 28).

The diagram is typical of circuit conditions for a tuned 14 MHz small antenna such as the EH with an antenna resistance of 30 ohms. If we first imagine the antenna with a 30 ohm load, but without any resonant circuit, we see that 1 amp of differential current develops 30 volts across the 30 ohm load. Return current via a 4 pF capacitance to ground merely accounts for 10 mA of current (the 4 pF is an arbitrary figure and will depend on closeness of the antenna to earth or nearby objects).

But bring it to resonance by loading with a typical 1200 ohms reactance and we get the voltage multiplied by  $Q = (30 \times 1200)/30 = 1200$ . Since the bottom dipole half is connected to the coax shield it is essentially at earth potential (this might change due to the effects of the common mode current itself but let's leave that for the purposes of the argument). So we can consider the potential applied from the top dipole element to ground is also 1200 volts and this will now pass a Q multiplied current

of 0.43 amp through the 4 pF to ground to return via the earth loop.

Because there is 0.43 amp returned via the ground loop, there is 0.43 amp less returning to the source via the coax outer conductor. So the two currents are out of balance and we have a magnetic field developed around the coax cable from the difference current (or common mode current).

Some have argued that there is not enough capacitance to ground for what I have described. However, I know from my experience with the X3 antenna that there is considerable coupling to ground which shows up in the measured antenna series resistance and which alters value with change in height. Whether that coupling is capacitive, inductive, or due to radiation absorption, I cannot be certain. However, whatever that form of coupling takes, if there is a different degree of coupling from one leg than from the other, the result is the same as I have described for capacitance coupling.

The common mode component will run as far as you let it, either over the whole of the coax length, or to a point where it is stopped by the trap. If you make the length between the trap and the antenna too great, you get standing waves on the

common mode component. Keep it less than ¼ wave and you get a fairly constant value of current over the common mode active length.

With a longitudinal current component fairly constant over nearly ¼ wave length of the coax cable, this section of the cable provides additional antenna length to aid radiation.

One can be misled by the strong electrical field developed across the dipole due to the high voltage and which will light up a fluoro lamp so brilliantly. If you balance the dipoles against ground, voltages from each dipole leg to ground are in opposition, no current returns via ground, and there is no common mode component in the coax. As we know from our tests, it then doesn't radiate as well even though there is still brilliant illumination of the fluoro lamp.

### Earth Currents

I have been questioned whether induction into ground really takes place in the EH antenna causing current to return via ground. Here are some more interesting facts concerning current measurements taken at the transmitter output connector:

1. If I run a bypass jumper via an RF

ammeter from the shield side of the connector, or the coax shield, direct to ground, I measure high current. The jumper provides a path for some of the current returning via earth.

2. If I break the coax lead and insert ammeters in each leg of the coax I get about twice the current in the inner conductor as in the outer conductor. Quite clearly there has to be a balance of current returned and the only path is via the transceiver earth connection or via its mains earth.

These facts prove conclusively that much of the return current is via earth and as the antenna and the other end of the feeder coax are all floating, the only way it can get into earth is by some form of induction or radiation from the antenna.

In effect there is a longitudinal current loop which includes the coax feeder. The loop can be broken by inserting the tuned trap anywhere in the coax line and this presents high impedance to any longitudinal or common mode current component running in the line. However, when the loop is broken, a standing wave of the longitudinal component is set up between the point where the trap breaks the loop and the top end of the antenna.

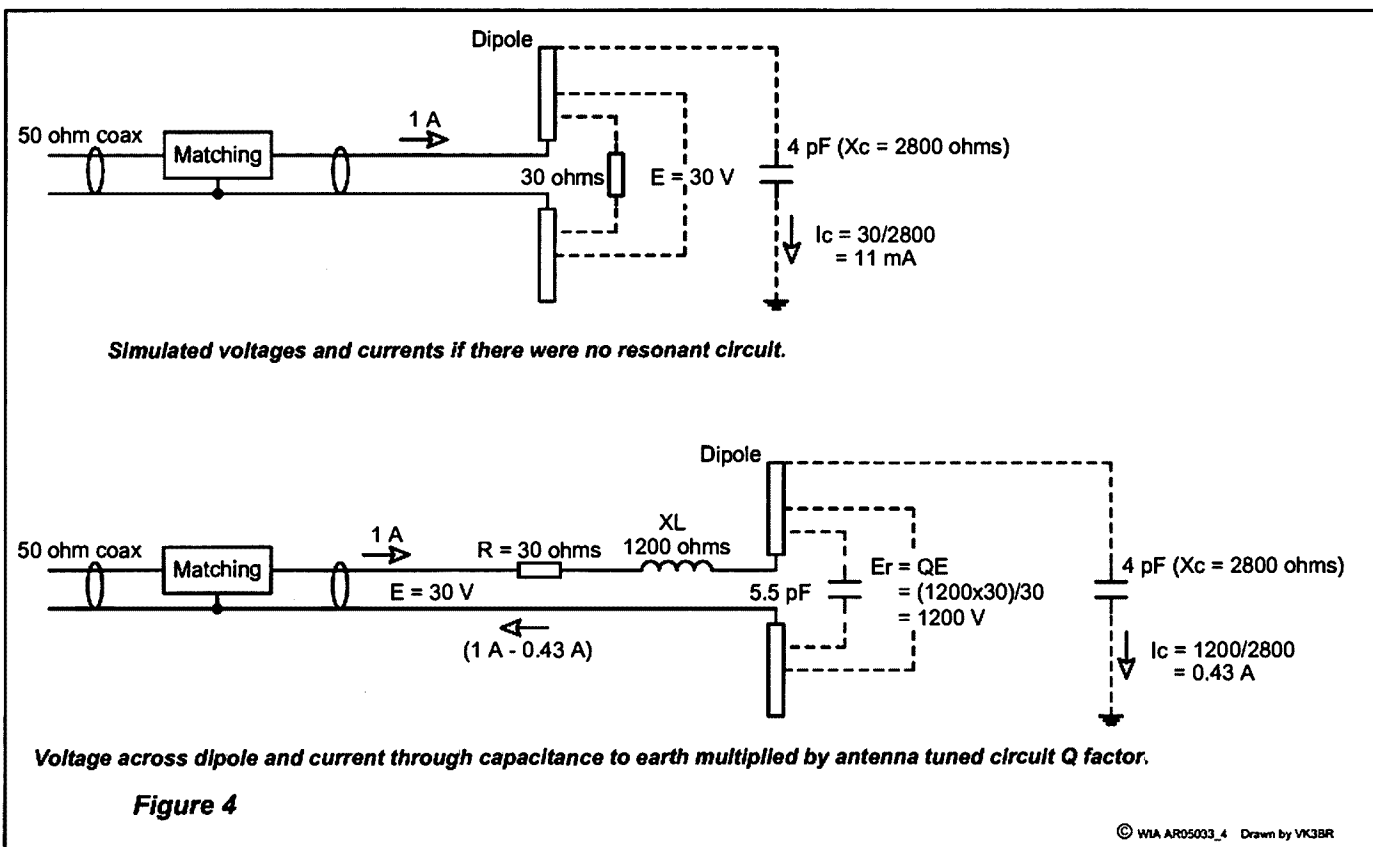

Figure 4 - Shows how antenna Q multiplies common mode component on the coax line.

## Theory on Short Coax Tail

In the introduction I pointed out that the EH antenna radiates about two S points better with a short length of coax tail as part of the unbalanced antenna circuit. The following is an explanation of why this occurs.

Suppose we fit the trap several metres down from the antenna input. If we monitor the longitudinal current component anywhere on the transmitter side of the trap, or immediately on the other side, we see negligible common mode current component. However, if we monitor along the coax closer to the antenna we again see a longitudinal component. There can be a very good explanation for this using basic antenna principles:

Unless the antenna is balanced, there is a longitudinal conduction path between the top tip of the dipole to the connection point at the trap, and this conduction path forms a radiating element. As with any

radiating element, current distribution is such that maximum current is at the centre of the element and there is zero current at the ends. So, as you move away from the trap towards the centre of that element, up goes the current. Clearly, the coupling of signal into the radiating element must be off-centre. But anyone familiar with the Windom antenna knows that this is a valid method of feed.

Fig 5 (over page) shows the 20 metre EH antenna with a dipole 0.5 metre long and trapped to block longitudinal current in the coax cable beyond two metres below the top of the dipole. On its own, the radiation resistance of the dipole calculates to a mere 0.2 ohm. However, with unbalanced connection to the coax providing a longitudinal path extending to the trap output connection, there is an effective radiator length of two metres. The calculated radiation resistance at the centre of the two metres is 3 ohms but it is even higher at the off-centre point

where it is fed. Hence, its value is high compared to the series loss resistance and the efficiency is very much higher than that achievable for the simple 0.5 metre dipole operating when the antenna circuit is balanced.

The antenna works better in its unbalanced connection because radiation resistance increases with the square of the radiating element length and the radiation resistance of the longer radiation element formed is greater than that of the shorter dipole on its own. As the efficiency is related to the ratio of radiation resistance to loss resistance, radiation is improved.

## Conclusions

I have reported on a lot of measurement details relating to the longitudinal or common mode current component reflected to the EH antenna transmission line.

Much as I did with my own VK5BR-X2/X3 short antennas operating in

SEE US AT THE  
GGREC HAMFEST

22nd of July 2006

Visit us at

[www.gccomm.com.au](http://www.gccomm.com.au)  
for new product updates!

G&C

COMMUNICATIONS

Authorised dealer for Icom YAESU Kenwood Barrett RFDS GME Electrophone Uniden

See us for CAR Stereo too! ~ 'Cranbourne Car Sound'

### ICOM (Australia) TRANSCEIVERS

IC-756 Prof III HF + 6M	\$4,999
IC-7400 HF +6M +2M	\$2,699
IC-7000 NEW! HF~70cm Mob	\$2,299
IC-706MKIIG HF-70cm	\$1,449
IC-718 HF SSB	\$999
IC-910H 2M/70cm Multimode	\$2,499
IC-2720H 2M + 70cm D/Band	\$699
IC-208H 2M + 70cm	\$579
IC-2200H 2M H/Power 'NEW'	\$449
IC-T90A Tri-Band H/Held	\$479
IC-V82 2M @7W H/Held	\$349
IC-P7A New Mini D/band	\$395

2 YEAR ICOM (Aust.) Warranty!

Full Product Range Available!

Full range of Communications/Scanner  
Receivers available from Icom, Uniden,  
Yaesu \$ POA

### 3.5 ~ 5.7 MHz Base Antennas

Comet CHA 250B HF Vertical	\$699
Diamond CP-6 HF Vertical	\$499

### Antenna Tuners



MFJ-902	MFJ-902H
MFJ-904H	MFJ-945E
MFJ-949E	MFJ-929

More Details on Website

### Antenna Rotators

G450A (shown)



G-2800DXC  
G-1000DXC  
G-800DXA  
G-650C  
G-450C  
G-5500  
G-550

### TE series EMTRON HF ANTENNAS

Australia wide orders welcome  
Credit card Cheque Money order

### YAESU Transceivers

FTDX-9000DA Elite HF Base	\$16,499
FT - 897D HF - 70cm	\$1,399
FT - 857D HF - 70cm	\$1,299
FT - 817ND HF - 70cm	\$1,049
FT - 8900R Quadband	\$ 799
FT - 8800R Dualband	\$ 699
FT - 7800R Dualband	\$ 469
FT - 1802M 2MT 50Watt	\$ 295
FT - 60R Dualband H/H	\$ 369
VX1R w/2 batt Dualband	\$ 249
VX2R Dualband H/H	\$ 329
VX-6R Dual/Band H/Held	\$499
VX -17R Tri-Band H/Held	\$599
VX -70R 2M Rugged H/Held	\$279
VR-5000 Receiver	\$1,199
VR-500 H/H Receiver	\$499
VR-120D H/H Receiver	\$ 279

3 YEAR AUSTRALIAN WARRANTY

Call in and see our range of power  
supplies, cables and connectors

Comet & Diamond  
Antennas & Accessories

Proudly Supporting  
Australian Business

207 High St. Cranbourne VIC 3977  
Ph: 03 5996 3298 Fax: 03 5995 0184

Email: [gccomm@bigpond.net.au](mailto:gccomm@bigpond.net.au)  
[www.gccomm.com.au](http://www.gccomm.com.au)

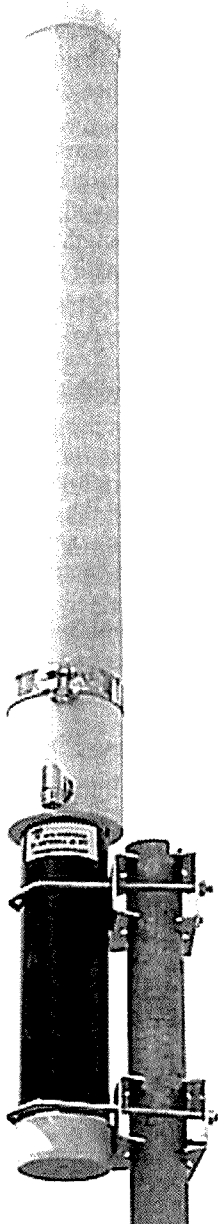

Photo 4 A 20 metre Star EH antenna made by Arno Electronica.

an unbalanced mode, I have eventually reached the conclusion that the successful performance of the EH antenna is more to do with its unbalance causing an extension of effective antenna length down part of the feeder than due to the controversial crossed field theory.

A tuned balun or trap can be placed somewhere in the coax line to prevent RF getting back into the radio shack, to inhibit earth loop current and to set the length of line which operates actively in a longitudinal mode. The trap should be placed down the

cable where current is kept high over a considerable length of the cable. A point a bit less than  $\frac{1}{4}$  wave down the cable from the dipole works fine but, if made much longer than  $\frac{1}{4}$  wave, the current maximum will move down the cable away from the dipole.

Even with longitudinal current blocked with a trap only a short distance down the cable from the antenna, the antenna operates efficiently because the effective length of the radiating element is increased by the short unbalanced length of cable.

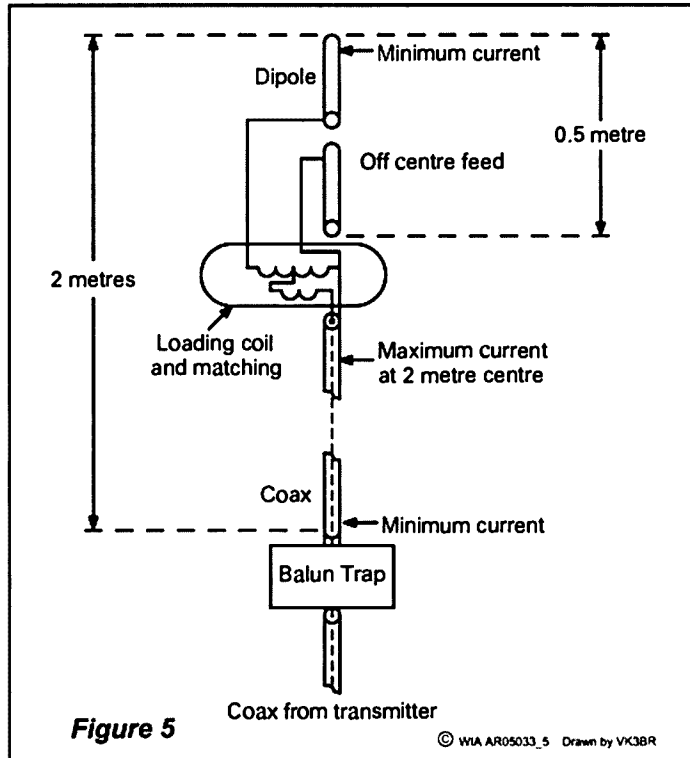

Figure 5 - The 20 metre EH antenna with a short coax tail.

#### References

1. More Information on the EH Antenna & how it has performed - Lloyd Butler VK5BR - *Amateur Radio*, November 2003
  2. The VK5BR-X Antennas - Some modified ideas on how they perform - Lloyd Butler VK5BR - *Amateur Radio*, (to be published).
  3. The VK5BR-X2/X3 Antennas - Operation when Unbalanced. - Also see *Amateur Radio*, (Reference 2).
  4. Other articles by VK5BR in *Amateur Radio* - April 2003, May 2004, July 2004, Sept 2004.
- Also refer to VK5BR Web Site <http://www4.tpgi.com.au/users/ldbutler> or link from <http://www.qsl.net/vk5br>

**Got something to say about Amateur Radio? Send a letter to the editor and share your thoughts with our readers.**

**TWIN CITIES RADIO AND ELECTRONICS CLUB Inc.**

## The Riverina Field Day Sunday 20th August 2006

Held at Murray High School in the Assembly Hall,  
Corner of Kaitlers Road and Kemp Street Lavington.

Opening 10 am - Shutdown 2 pm

Food will be supplied by caterers on site at reasonable prices

Tea and coffee will be free to everyone

There are a number of reasonable motels located nearby and in Albury/Wodonga

On Saturday evening some club members will be having an informal evening meal at the Commercial Club Bistro, come along and enjoy a relaxed evening.

Contacts	Greg VK2EXA 02 6021 5438	<a href="mailto:sarge@iinet.net.au">sarge@iinet.net.au</a>
	Peter VK2CIM 02 6040 3210	<a href="mailto:vk2cim@wia.org.au">vk2cim@wia.org.au</a>
	Stafford VK2AST 02 6040 6987	<a href="mailto:staffordsimpson@westnet.com.au">staffordsimpson@westnet.com.au</a>



# A simple direct-reading Q meter

Drew Diamond VK3XU  
45 Gatters Road Wonga Park VIC 3115

**Amateurs everywhere have a keen interest in building antenna couplers/tuners, impedance matching networks, filters, antenna loading coils, RF power amplifiers, receivers and transmitters. All these devices rely heavily upon the use of inductance coils for their efficient operation. Yet the difficulty remains, for some workers, of adequately testing their coils.**

Unfortunately, the inductance function provided by low-cost digital multimeters is generally found to be of limited use in measuring microhenry coils employed at radio frequencies. Something much better is needed. The most respected instrument for accurate inductance measurements at high frequencies is traditionally the "Q" meter, where the coil is generally tested at, or near, the intended operating frequency, and a more meaningful reading is thereby obtained.

Because of their great utility, good Q meters seldom appear on the second-hand market, although some of the venerable models (Reference 1) occasionally turn up at local hamfests. They are very much in the "boat-anchor" class, however, and do rather take up a lot of precious bench space.

Various patterns have been described in overseas and local journals but, to this writer, they seem to fall just short of the sort of thing required by the amateur experimenter. Nevertheless, Lloyd Butler's inspirational efforts, described in References 2 and 3, come very close to the mark. However, the need for a signal generator that can provide a large output power level may be problematic for the typical amateur. The power level difficulty is neatly tackled by Lindsay Lawless' bright idea (Reference 4), where an existing HF QRP transmitter may be used to provide the necessarily large test signal.

The simpler Q meters employ the "3 dB bandwidth" method (References 5 and 6), where the worker must do a new (albeit simple)

calculation for each new measurement. A direct-reading Q meter along the lines of References 2, 3 and 4 would be much more "user friendly". The Butler and Lawless patterns may be combined and simplified by employing an existing QRP transmitter as a signal source, and a VTVM or DMM as our indicating device.

## Theory

Q, or Quality factor, is a figure of merit and may be defined as "the ratio of energy stored to energy dissipated in a circuit". For lumped resonant circuits, Q is equal to the ratio of the purely inductive or capacitive reactance (X) to the losses, expressed as series resistance (R).

The ratio  $X/R$  is also equal to  $E/e$ , E being the voltage across either reactance in a series circuit at resonance, and e the voltage injected in series. For circuits with a Q of greater than about five, this ratio may also be expressed as circuit magnification factor (m) (see Reference 7 for a more lucid explanation).

Laboratory Q meters generally employ a configuration similar to that shown in Figure 1.

Non inductive resistance r, where the test signal voltage e is inserted, is usually made as small a value as is practically possible, typically 0.05 ohms, consistent with measurable results being obtainable. The unknown inductance L, resonating variable capacitor C, and resistance r are all effectively in series. At resonance, a voltage E will be established across the reactive components L and C. Since the frame of the capacitor is usually at ground potential, it is convenient to measure the voltage across C with respect to chassis ground.

This measuring arrangement involves a few sensible cautions:

1. Resistance r shall be much lower in value than any reasonably expected loss resistance (R), thus causing little effect upon the accuracy of the measurement.

2. The input impedance of the voltmeter (VTVM or DMM) must be high, typically 10 M $\Omega$  so as to impose the least additional loss upon the test circuit.

3. The inserted voltage e is effectively in series with the circuit only if the inductance coil has no distributed capacitance (the existence of significant coil capacity causes the true Q to be higher than observed Q).

4. The variable capacitor shall be a well-made component with air as the dielectric and low-resistance wiping contacts (Reference 8). Reference 9 provides workable equations for the curious to reduce the above approximations.

What the last paragraph boils down to is that coil Q is reckoned to be close to circuit Q, all losses being bundled with the coil's losses. Notwithstanding these approximations, the amateur may obtain quite useful and meaningful inductance and Q measurements with relatively simple equipment.

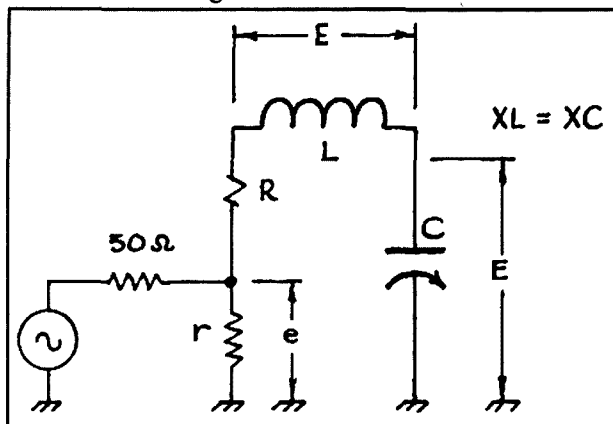

Figure 1

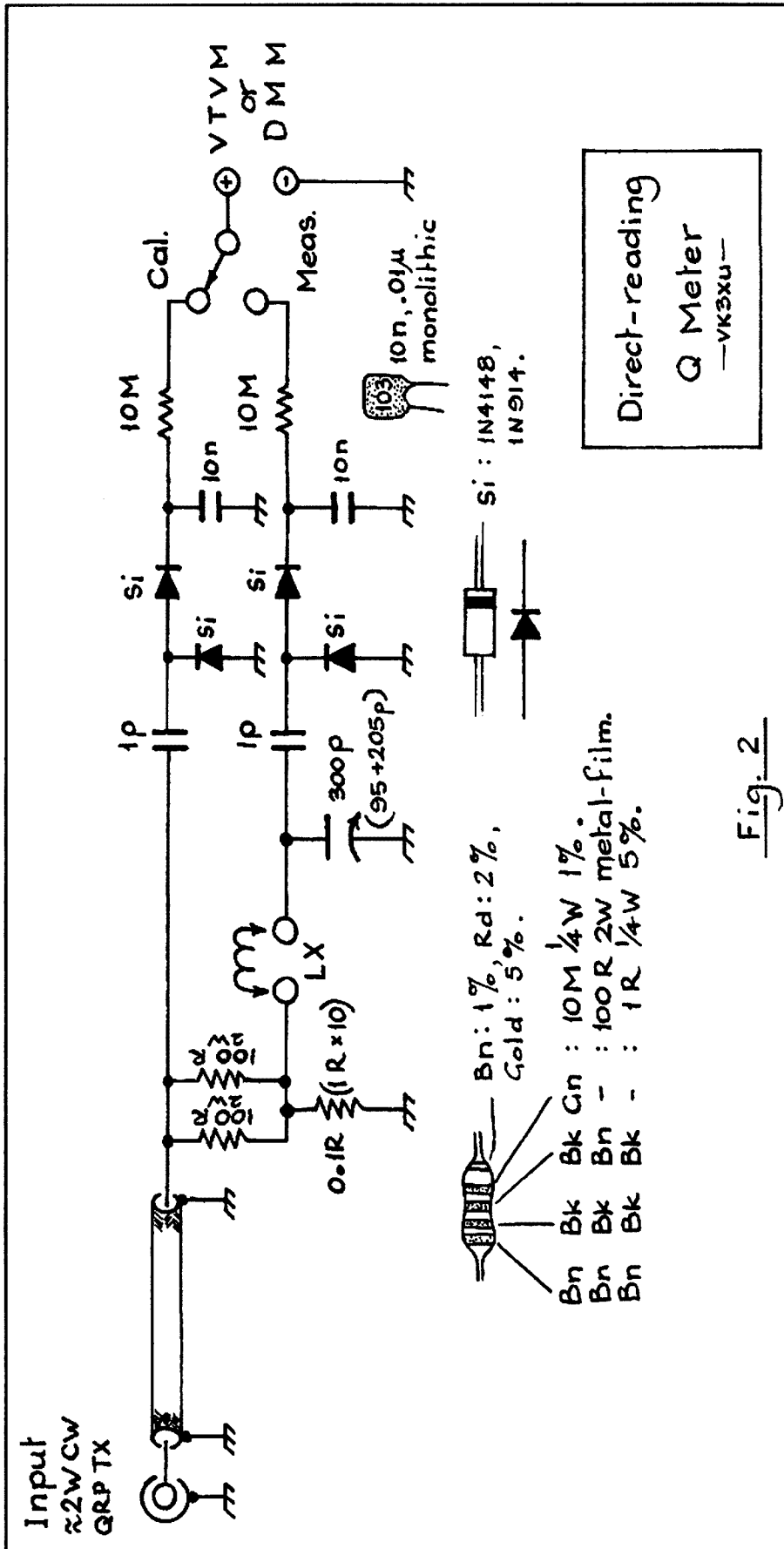

Figure 2 – Circuit of the simple direct reading Q meter.

### Circuit

See Figure 2. Signal voltage is injected by the conventional use of a low value non-inductive resistor, in this case 0.1 ohm comprising 10 x 1 ohm resistors in parallel. The inductance coil to be tested, its resonating variable capacitor, and the 0.1 ohm resistor are all effectively connected in series, as illustrated in Figure 1.

A QRP transmitter supplies a test signal of appropriate frequency at a power level of about 2 W CW. Two paralleled 100 ohm metal-film 2 W resistors provide a low SWR 50.1 ohm termination where close to 1/500<sup>th</sup> of the input signal voltage appears across the 0.1 ohm to become the circuit injection voltage.

Input signal voltage is sampled through a 1 pF capacitor with an ordinary two-diode detector where the 10 nF capacitor will charge to a value very close to the rms of the input signal (Reference 10). For a 2 W signal, the voltage obtained will be about 10 V dc. By using a relatively large test signal level we are better assured that the detector diodes shall effectively operate more as "ideal" diodes.

A second identical detector is coupled to the hot side of the resonating capacitor. When the circuit is in resonance, the voltage obtained will be close to Q times the voltage across the 0.1 ohm. Since the voltage across the 0.1 ohm is 1/500<sup>th</sup> the input voltage, a circuit magnification (Q) of 500 will therefore give the same voltage as obtained for the input.

With such a large test signal, any loading effect of the measurement may be further reduced by including a series 10 megohm resistor in each detector circuit. For the conventional DMM or VTVM input impedance of 10 megohm, an input signal of about 2 W will cause a 5 V drop across the 10 megohm, and 5 V at the meter's input.

In use, a reading of 5 V is first obtained in the (Cal)ibrate switch position by manual adjustment of the transmitter's power, then a second resonated reading is obtained in the (Meas)ure position, whose value x 100 equals circuit Q. Hence, a reading in the Meas position of 3.50 V directly shows a Q of 350, and so on.

The 300 pF variable capacitor's dial is calibrated in pF. Knowing the test frequency and the value of the resonating capacitance, inductance may be calculated using the well-known formula cited in "Operation" below.

Direct-reading  
Q Meter  
—VK3XU—

Fig. 2

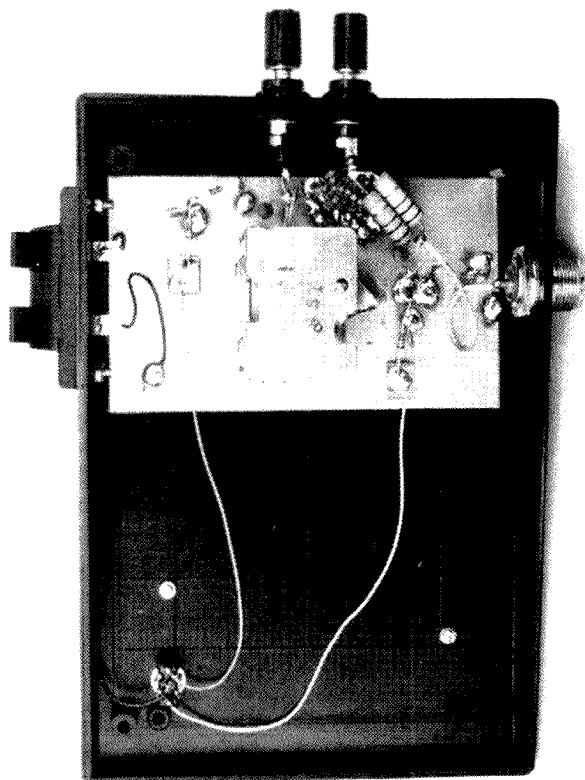

Photo 2 - Internal view of the Q meter.

## Construction

To keep stray capacitance and inductance to a minimum, a sloping panel style plastic case measuring 134 W x 189 D x 32-55 H mm was chosen to house the prototype, pictured in Photo 1. However, any plastic or metal case that you prefer should serve.

A common MSP 95 + 205 pF (300 pF total) variable capacitor is suggested for the resonating element, although any well-made air dielectric component of similar or greater range will do.

A suggested method of construction is illustrated in Photo 2. The plain circuit board measures 65 x 115 mm. The binding post terminals for connection of LX should be positioned such that the tag(s) of the variable capacitor may be connected with a short wire. The ten 1 ohm resistors should be soldered between the left-hand terminal's tag and circuit board foil in a splayed manner using minimal lead lengths.

The schematic shows how a short length of miniature 50 ohm coax is necessary for connection between the test signal input connector and the top of the two 100 ohm resistors. Note that the braid is connected to foil at both ends.

Stray capacitance is kept to a minimum by using 'ugly' style for the 1 pF capacitors

and detector diodes. Small circuit board pads may accommodate the 10 nF bypass capacitors and 10 megohm resistors. Ordinary hook-up wire is used for connection of the Cal/Meas switch.

The cursor shown in Photo 1 was cut from 3 mm Perspex sheet using a rod-saw, then cleaned up in a poor man's lathe. Drill a 1/4" hole dead centre, insert a 1/4" Whitworth bolt and nut, fix in the chuck of an ordinary electric drill which in turn is held in a vice. Gently apply a smooth file to the rotating disc and thus smooth up the disc's perimeter.

Using a sharp scribe and steel rule, carefully scribe a line across half the diameter for your pointer line, which may be filled with black crayon then polished to improve contrast. The disc may now be attached, with epoxy or hot-melt glue, to the skirt of a suitable knob. Temporarily insert a scrap of 1/4" rod (potentiometer shaft off-cut) through the disc and into the knob to assure correct alignment.

A dial of corresponding diameter may be made in a similar manner from sheet aluminium, and given two coats of white undercoat to receive calibrations as described next.

## Calibrating the Capacitance Dial

You will need a capacitance bridge, or a digital capacitance meter that can measure accurately down to less than 20 pF.

Using very short leads, connect the capacitance meter across the LX terminals. The left-hand terminal is the "cold" or "earthy" lead, which should connect to the corresponding terminal of the C-meter.

Mark the 20, 30, 40, 50, 60, 70, 80, 90 and 100 pF points, then the 150, 200, 250 and 300 pF points.

## Operation

A typical measuring set-up is shown in Photo 3.

It is a pity that so many VTVMs have apparently been displaced by digital multimeters (DMM), because the most ideal instrument as a peaking indicator (as in this instance) is an analogue meter. Nevertheless, a DMM will serve.

The trick, when adjusting for a peak reading at resonance on a typical 3 1/2 digit meter, is to use a low resolution first - say the 200 V dc range - then fine peak on the 20 V dc range.

The table below shows the approximate inductance measuring range for test frequencies of 1.8, 3.6, 7.2 and 14.4 MHz.

### Capacitance

Test Freq	300 pF	50 pF	20 pF
1.8 MHz	26 µH	156 µH	
3.6 MHz	6.5 µH	39 µH	
7.2 MHz	1.6 µH	9.8 µH	24.4 µH
14.4 MHz	0.41 µH	2.4 µH	6.1 µH

### To measure inductance:

Apply ~2W CW signal of appropriate frequency from a QRP transmitter.

Adjust variable capacitor to obtain peak reading on DMM/VTVM in MEASure.

Inductance µH = 25330/f<sup>2</sup>C where f is in MHz and C is in pF.

### To measure Q:

Adjust transmitter power for 5 V dc on DMM/VTVM in CAL.

Switch to MEASure.

Resonate with variable capacitor at appropriate frequency.

Q = DMM/VTVM voltage reading x 100.

*continues over*

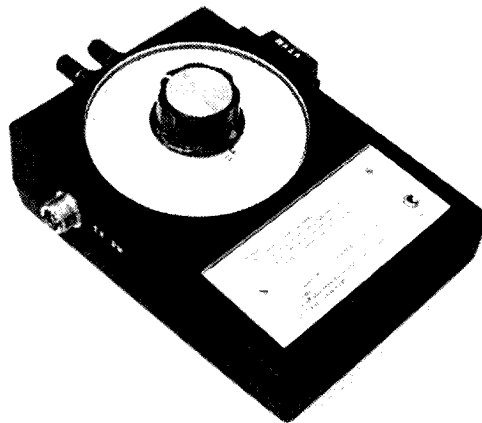

Photo 1 - The simple direct reading Q meter.

# OzGear

www.OzGear.com.au

RadioCommunications & Electronics

Ozhelph Services Pty Ltd T/as Ozgear

Suppliers of radiocommunications,  
electronics and computer products  
and electronic test equipment

Ph 07 3114 2506

sales@ozgear.com.au

Brisbane QLD

Manager: Doug Hunter VK4ADC

**WE HAVE MOVED!**

**Unit 2**

**139 Beenleigh Rd  
Acacia Ridge 4110**

**Ozgear yagi antennas  
for 6m, 2m and 70cm  
now available**

## ICOM &

## YAESU

**Australian-sourced radios with  
Australian-based manufacturer  
warranties**

Authorised Aust Icom and Yaesu dealer

Antenna, cable, interface, tuner and  
general accessory products from...

Amidon, Andrews USA, Austek,  
Benelec, Bushcomm, Comet, Dalwa,  
Diamond, Garland, GeoSensory, GME,  
Icom, Kingray, LDG, Lutron, Mobile  
One, RFI, Sangean SSGC, TET-Emtron,  
Tigertronics, Yaesu, ZCG Scalar plus  
ARRL and RSGB publications

## ALTRONICS

Many products stocked

**Product & pricing info?**

Phone, email or visit us on the web at

**www.OzGear.com.au**

for the latest info plus on-line ordering. Our latest  
price list can be downloaded at any time

**Payment?**

Direct  
Deposit

BPAY

e  
eflips

MasterCard  
VISA

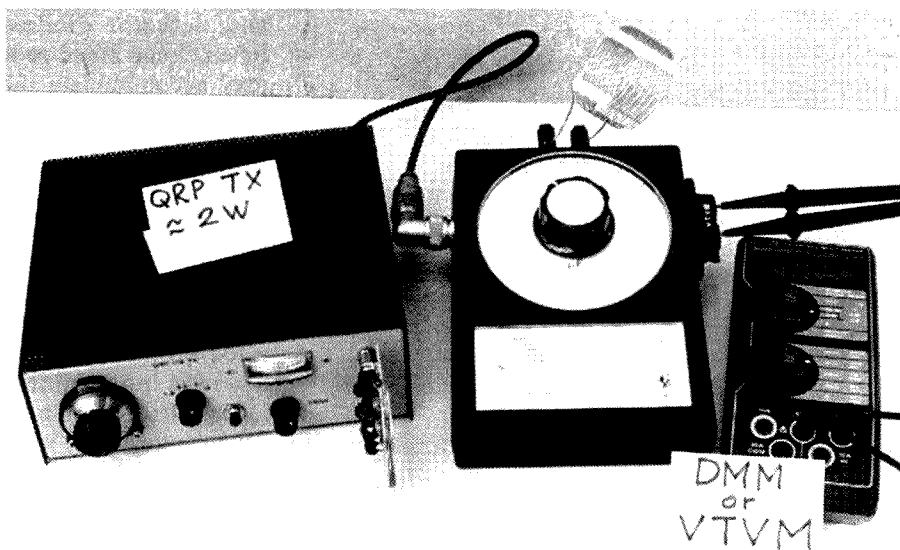

Photo 3 – Measuring set-up.

## Parts

The ordinary components are collectively available from our usual electronics suppliers, including Altronics, Electronics World, DSE and Jaycar. The MSP 300 pF (95 + 205 pF) variable capacitor is a type often seen at swap-meets.

To assure low contact resistance, the binding post terminals must be of good quality, such as Jaycar PT-0460 (red), PT-0461 (black). A "2-way push connection" terminal set, PT-3000, allows our usual multimeter probes to be conveniently connected to the meter.

The black sloping plastic case may be a Jaycar HB-6096 or similar. 2 W metal-film resistors are available from Electronics World, phone 03 9723 3860, or from TV service trade suppliers

## Summary

Inductance coils are used in almost every item of radio equipment where efficient operation depends largely upon the use of low loss (high Q) coils. The keen amateur experimenter who is seriously interested in coil measurements therefore requires a simple means of determining inductance and Q to acceptable accuracy.

A practicable method, based on the proven voltage injection principle, has been outlined, where an existing low-power CW transmitter provides the test signal, and an ordinary DMM or VTVM serves as a metering device for the direct measurement of Q. Knowing the test frequency and the value of resonating capacitance, inductance in  $\mu\text{H}$  may be calculated using a simple formula.

## References, Further Reading

1. "Q Meters"; K Pullen W3QOM; *Ham Radio* (USA), December 1989.
2. "An Experimental Q Meter"; L Butler VK5BR; *Amateur Radio*, November 1988.
3. "An Experimental Q Meter - Revised"; L Butler VK5BR; *Lo-Key*, June 2004.
4. "A Simple Q Meter"; L Lawless VK3ANJ; *Amateur Radio*, February 2001.
5. "An Inductance Meter for Radio Coils" Diamond, *Amateur Radio*, August 2004.
6. "A Poor Man's Q Meter"; M Findlay; *Silicon Chip*, July 2004.
7. "Q"; M Scroggie (Cathode Ray); *Wireless World*, January 1953 (see also *Second Thoughts on Radio Theory*; M G Scroggie; Iliffe Books).
8. *Radio Engineers' Handbook*; F Terman; 1943 edition p916.
9. *Instruments and Measurements for Electronics*; C Herrick; 1972, McGraw-Hill pp 217-221.
10. "In Circuit RF Measurement"; Tuck Choy M0TCC/VK3CCA, *Electronics World*, July 2003, pp 44-46.

**TWIN CITIES RADIO AND  
ELECTRONICS CLUB Inc.**

**The Riverina  
Field Day Sunday  
20th August 2006**

Held at Murray High School  
Lavington.

10 am - 2 pm

Catering onsite Tea and coffee  
will be free to everyone  
Full details page 30 this issue  
and in next months AR,

Stall holders see page 30

ar

## VK2

Tim Mills VK2ZTM.

E-mail to vk2wi@ozemail.com.au

### AGM — New Council

The 2005/2006 AGM of AR-NSW was held on Saturday the 22nd April. There were 42 members in attendance and the meeting was chaired by outgoing President, Chris VK2XCD. 73 apologies were received.

Once again, this year there was an election, with 11 candidates for the 9 positions. 208 votes were cast.

The new Council consists of Barry White VK2AAB President, Owen Holmwood VK2AEJ Secretary, Noel May VK2YXM Treasurer, Norm Partridge Vice President with membership and clubs, Terry Ryeland VK2UX as junior Vice President and education, Brian Keegan VK2TOX is web master and publicity, Peter Tolmie VK2ZPT is assistant to Terry with education and Mark Blackmore VK2XOF looks after Dural, trash and treasure and deceased estates.

### Life Membership

Pat Leeper VK2JPA received Life Membership of AR-NSW. A report on the various resolutions and motions before the meeting has been given both from VK2WI and the web site. The majority of the resolutions and motions were either withdrawn or not passed, in some cases to further clarify their intent. Retiring from Council at this year's meeting were Chris Devery VK2XCD and Chris Flak VK2QV who were thanked for their work for AR-NSW.

### Trash and Treasure

The next Trash & Treasure will be held at VK2WI, Dural on the last Sunday of July, the 30th. Check the web site - [www.arnsw.org.au](http://www.arnsw.org.au) - for tender details. The third quarter VK2WI roster is currently being prepared and as always, we need more operators on the team. Contact John VK2JJV or the office with your offers. Brian VK2TOX has taken over as the AR-NSW web master from Chris VK2QV.

### Moving

As reported in last month's notes, AR-NSW has sold Amateur Radio House and has leased a short term office at 8 Melville Street Parramatta, until a transfer of operations to Dural in a few months.

The contact methods remain the same with the telephone 02 9689 2417, Fax 02 9633 1525 and postal at Box 9432 Harris Park 2150. Office days are currently Thursday and Friday but it is advisable to telephone ahead to ensure the office will be attended. Currently, there is no availability of the library.

Foundation courses and exams will be held at Melville Street on the last weekend of the month, booking inquiries via the office. Some groups who previously met at Amateur Radio House have arranged alternate meeting locations. The Tuesday evening Home Brew meeting on the first Tuesday is in the party room of the Parramatta McDonalds, party hats do not have to be worn.

### Callbook

It is time to check out your details for the next callbook. Callsign details for callbook entries only come from ACMA, so ensure they have them correctly, you can check your details via the internet.

Your club details should go to Ted VK2ARA and repeater, beacon and packet listings, many of which are currently in error or no longer operating, should go to John VK3KWA. Alternatively, send them to the WIA Secretary via e-mail.

### Submitting News

To submit news to VK2WI. Send an E-mail to [vk2wi@ozemail.com.au](mailto:vk2wi@ozemail.com.au) by noon Friday.

Many club and group activities, have the bare details as listed in the callbook. If you require publicity, you have to submit it.

The same applies to club conducted exams, let the office know the dates, both so they can answer inquiries and for inclusion in VK2WI news.

### WICEN

WICEN [NSW] Inc has a new postal address. It is P.O. Box 126, Gosford, 2250. The former St. Leonards box will be cleared for the next few months. This box was first used by the NSW Division when they were at Atchison Street and was taken over by WICEN when the move to Parramatta took place in 1982. Next year, AR-NSW will have a Dural post box in operation.

### Out and About

This month has the Oxley Region Field Day on the long weekend. There has been extensive notification in recent issues of AR. The Oxley Region recently re-established their VK2RCN repeater on 7000 as well as working on their other repeaters.

On Saturday the 24th June, the Waverley ARS will be holding their annual auction, see page 32 in May AR for details about Waverley.

In late May, Ian VK2ZIO officially opened his Kurrajong Radio Museum. Ian's extensive collection was the Castle Hill Military Museum until his relocation a couple of years ago to a former mushroom factory in the Blue Mountains foothills. It is well worth a visit; look for the details on his web site.

### Repeaters and beacons

For VK2 repeater or beacon applications or changes, you should first check with Brian VK2WBK, who provides the VK2 NTAC support, either direct or via the AR-NSW office.

Submission of the application to ACMA is done by Peter VK3PP who is the National Repeater Co-ordinator. Some recent applications have been short on site and other details. Remember, that in order for your application to proceed quickly, it must have as much supporting documentation as possible. Assessment of an application has to take into consideration many other factors besides just your desired service.

73 - Tim VK2ZTM.

www.pca.cc  
Email from anywhere  
via Winlink  
2000  
Use PACTOR-3  
on HF to send  
Mail, Grib Weather,  
Weatherfax & Images  
Contact [marc@pca.cc](mailto:marc@pca.cc)  
Sydney 02 8902 0107

## VK3

### GARC and NWTARIG to re enact first radio between Mainland and Tasmania

On July 12 2006, the Geelong Amateur Radio Club, in co-operation with the Borough of Queenscliff and the North West Tasmanian Amateur Radio Interest Group with the Devonport City Council, will be staging a re-enactment of the Marconi Company's historic transmission between Devonport, Tasmania and Queenscliff, Victoria using a mix of old and modern radio modes and techniques.

Although the event will be run over 5 days, the actual re-enactment will be held at 1:30 pm on Wednesday July 12, approximately the same time as the original Official exchange of greetings between the Governors and Peoples of Victoria and Tasmania were sent 100 years before.

For the event, a replica of the operating section of the original Radio Telegraph Shack is being constructed, and will be in place at the original site near Queenscliff, Victoria. Both the GARC and NWTARIG are busy organising the celebration and are gathering Antique Radio Artefacts and Memorabilia from museums and private collections all over the world to exhibit during the 5 day event.

After the re-enactment which will be witnessed by politicians and public alike, the replica Shack and a caravan will remain at the Queenscliff site until Sunday July 19, allowing the Amateur Station to

operate more or less continuously under a yet to be announced special call sign. All stations interested in the event and Amateur Radio in general are invited to make use of this unique opportunity.

As well as the re-enactment ceremony many 100 year old artefacts, vintage cars etc. will be exhibited in Queenscliff and Devonport and at the local museums. The Maritime Museum at Queenscliff will have items from Museum Victoria on display including what is believed to be the original Morse Key.

As the original site in Devonport is now a commercial Caravan Park, the Tasmanian celebrations and station will be at the Devonport Maritime Museum where all cross-Strait greetings ceremonies will originate and the radio museum pieces will be on display. Exhibited there will be an original complete Marconi spark transmitter/receiver, which we would love to use but wouldn't dare. No prizes awarded for guessing the reason!

Following the Wednesday event, the Devonport City Council will hold a Civic reception. An ARISS space station contact is scheduled for between the 12<sup>th</sup> and 15<sup>th</sup>, with Devonport High School and Reece High School senior science pupils. The exact time will be announced by NASA closer to the event.

A 20-page commemorative booklet is in production, including a reprint of the

original booklet published by Marconi at the time.

All persons interested in History, Broadcasting, Amateur Radio, Radio Techniques and Radio in general are most welcome to attend the Sites for the re-enactment or on the days following up until Sunday the 19<sup>th</sup> at Noon when the Stations will close. Both the Queenscliff and Devonport sites are marked: Devonport with a Post and Plaque, while the Site at Pt. Lonsdale near Queenscliff (Melway map 499 K2) is marked with a Cairn and Bronze Plaque.

Everyone is welcome.

Expect more on the re-enactment and the technical side from the GARC in a future issue of AR.

Cal VK3ZPK and Ron VK7RN

#### Correction:

### VK5JST Antenna Analyser

Distribution of kits for this project is now handled by the South Coast Amateur radio Club (SAJ)(SCARC).

Contact details for Kits now are:

**kits@scarc.org.au**

or alternatively

**SCARC PO Box 333**

**Morphett Vale SA 5162**

### The Gippsland Gate Radio & Electronics Club members are at it again.

On July the 22nd GGREC will conduct their Hamfest Sale at the Cranbourne Community Hall on the corner of Clarendon and High streets, Cranbourne. Melway 133 K4.

Some 40 tables of goods will be present at this large venue, but stall holders should book early as demand will be very high.

Reservations for stall holders may be made by contacting Dianne Jackson VK3JDI on (03) 5625 2545. Doors open at 8:30am for stall holders and at 10:00 am for buyers.

The admittance fee of \$5 for buyers will go towards the upgrading of facilities at our Club Shack & meeting room in

Cranbourne. Take away food, plus free tea and coffee will be available.

The entry fee includes a ticket in the Door Prize which will be drawn around 1:30pm for all who register upon entry. Great prizes to be won. Additional tickets can be purchased on the day.

#### GGREC Meetings

Visitors are welcome to attend Club meetings which are conducted on the first and third Fridays of each month at the Guide Hall in Grant Street Cranbourne. Check out our comprehensive web site at: [www.ggrec.org.au](http://www.ggrec.org.au) for more information on the Club and its events.

### Plan ahead

GGREC

## Hamfest Sale 22 July

**Cranbourne Community Hall**

Cnr of Clarendon and High streets,  
Cranbourne.

High Street is part of the South Gippsland Highway.  
Melway 133 K4.

Stall holders should book early as demand will be very high.

Reservations for stall holders may be made by contacting Dianne Jackson VK3JDI on (03) 5625 2545.

Doors open at 8:30 AM. for stall holders and at 10:00 AM for buyers \$5 entry.

## VK5

### Adelaide Hills Amateur Radio Society

About 60 members attended the last meeting of AHARS, which is approaching the comfortable size of the current meeting hall. The society may be looking for larger premises during the year. Watch this space for further information. It was a particularly interesting meeting. There were two parts to the evening.

#### Food for dark matter thoughts

The first part was addressed by Alan VK5TC who presented the meeting with some food for thought about atoms, molecules and such deeper subjects as dark matter.

This dark matter, that has not yet been found, is thought must fill the universe to explain some anomalies in the universe that conflict with the inviolable speed of light and gravitational bending of light. Alan suggested that there might be other possibilities beside the dark matter capable of satisfying the observations.

#### Food for more thought.

The second part of the evening was given over to a very professional demonstration by Hans VK5YX, of how he went about building up a transceiver from a kit.

All amateurs who have been involved with the hobby for a number of years will be familiar with the Heathkit name. Many have possibly built or tried to build

or, maybe, bought a Heathkit item, but it is some years since Heathkit disappeared from the market.

Most of the kits that have filled the intervening years have been for small converters or antenna tuners or such like. There has not been anything as ambitious as a transceiver for us to build until the Elecraft K2 and K2/100 came into the market.

The Elecraft K2/100 (the extra takes the power up to the full 100 watts and all modes) claims to be easy to build (with which Hans will agree as long as you take great care and have a good magnifying lamp to hand).

Hans agrees very strongly with the claim that the kits are very well supported. Any queries are quickly attended to and any faulty parts immediately replaced. The kit comes with very clear instructions and illustrations. It should be built EXACTLY the way and in the order in which the instructions suggest.

Hans used a series of photographs of the construction as he went along

which he showed as a "Photostory 3" presentation. He is a very neat worker. Few would be able to distinguish between Hans' construction and a factory made transceiver.

Apparently, the company which produces the Elecraft kits does have a number of authorised builders who will put your kit together if you decide on mature consideration that you have bitten off more than you can chew, but Hans says the satisfaction of your own work is worth the effort.

The transceiver works beautifully on all bands and in all modes. It took about two months to complete. The kits are not cheap but a factory unit with the same capabilities would be much more expensive, and, without the personal satisfaction.

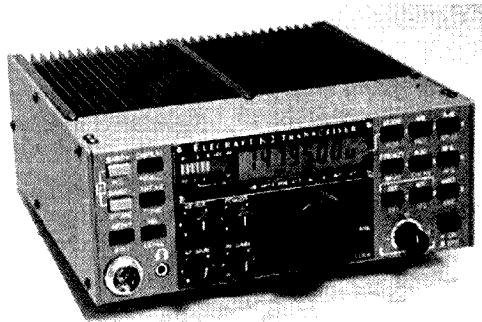

#### Meetings

AHARS meetings are held on the third Thursday of the month. If you are visiting Adelaide, contact the President, Jim VK5NB, QTHR, the callbook for more information.

### WANTED- OLD HI-FI

We buy old stereo equipment 1950 - 1980 working or not! Turntables, speakers & amplifiers by QUAD LEAK RADFORD TANNOY KEF LUXMAN ORTOFON LINN NAIM THORENS SPENDOR & more.

Camera Exchange (03) 9808-8811



WE BUY TURNTABLES  
PAYING UP TO \$1000+  
FOR SOME MODELS

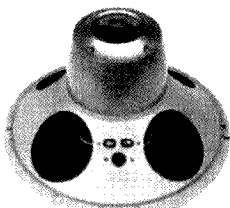

PAYING \$500-\$1000  
FOR 1950s TANNOY  
SPEAKERS

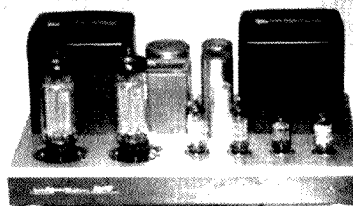

PAYING \$300-\$1000 FOR  
LEAK & QUAD VALVE AMPS

We buy single items  
or whole collections!  
Instant CASH paid.  
We even pickup!

Radio valves wanted-  
new & used. Call John  
0418-313181

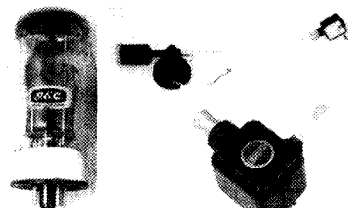

2A3 KT66 KT88 EL34 300B  
ECC33 845 GZ32 45 VALVE  
...WE PAY \$20-\$100 EACH

## Foundation Licencees Abound in VK7

A quick search of the ACMA radcomm database has revealed that VK7 now has at least 40 Foundation Licensees (FL). The radcomm database suggests there are 540 licensed VK7 amateurs once you remove the repeaters and beacons therefore FL account for 7.4% of VK7 amateurs. This is a fantastic result and all assessors and course helpers are to be congratulated!

## Radio and Electronics Association of Southern Tasmania Inc.

The ATV experimenters group has been showing a series of radio related archival films from the 1930s & 40s on ATV from the Domain ATV Studio at the Wednesday ATV night at 7:30pm. We now have a club fox, thanks to a donation of a handheld by John VK7JK. This fox will be put to good use at the field weekend at the Lea scout camp on the 3-4 June 2006. The field weekend will focus is on portable and mobile operation of any mode of amateur radio and many excellent speakers are lined-up for the weekend. See you there.

Brian VK7RR and partner Sue VK7KSU were the first VK7s to attend the International DX Conference held in Visalia, California at the end of April and reported that over 700 amateurs attended this annual conference. Some of the impressive presentations included the Peter One and the Kure Island DXpeditions. Brian even got to operate the new Yaesu FTDX 9000, Icom IC7800 and FlexRadio black box transceivers.

The yes/no fox hunts are being run fortnightly again (from the 5<sup>th</sup> May) at 7:00pm VK7RAD, 146.700 MHz. The fox can only give yes/no answers to questions and the first to find the fox becomes the fox next time. The wintry months have seen coffee, cake or a meal after the hunt finishes. It's great fun, why not come along and try it!

## Targa Tasmania 2006

Targa ran from 25 to 30 April and this year's communications team was probably the biggest ever. In total there were 65 radio operators, 18 were licensed amateurs, including 8 Foundation licensees, with help from many others. They covered 160 locations and deployed 30 repeaters over the event.

The age and gender balance changed with more younger people and an increasing number of females. The roll call of the Targa Comms class of 2006 is: VK7s - ARN, DG, DY, FABS, FAJM, FBCS, FRED, FRNJ, FTAA, FTML, FWJS, HAW, HSB, JGD, NXX, TRF, ZCR, ZRO and ZZ together with Damien, Terry, John, Lawrie, Victoria, Paul, Tanya, Marcia, Garry and Jeanette, Keith and Neville, Steve and Rhonda, Kerry and Helen, Andrew and Shelly, Robert, Paul, Anne, Scott and Darren and apologies to anyone I have missed.

## BPL Interference Watch

Measurements have been taken within the BPL trial site in Burnie on the North West coast of Tasmania. This report shows a degradation of the noise floor in the trial areas from between 16dB (40 times higher) to 46dB (39,800 times higher) above the measured ambient noise floor (level). Take a look at the REAST BPL Watch page (<http://reast.asn.au/vk7bplwatch.php>) for more information.

## Silent key

### Eddy (Ted) Burne VK7GB

Eddy or Ted Burne, late VK7GB, died in Hobart on 29th April, aged 93.

His first job was as assistant cinema projectionist in 1929 in Launceston. Eddy moved to Hobart and became projectionist at the Avalon cinema in Hobart in 1936.

During World War Two, he was in New Guinea with the army in the First Australian Broadcast Maintenance Section.

He returned to Avalon, and in the late 1950s moved into management.

## Northern Tasmanian Amateur Radio Club

April 12 saw NTARC addressed by Phil VK7JJ and Jason VK7ZJA. Phil gave a great report on the Yaesu FT857D and Jason gave a great presentation on not 1 but 3 of his radios, a TS2000, the \$20 special TS-430s and a Kenwood/Trio receiver. The lucky winner of the portable DVD player was Wayne VK7XGW. The 10<sup>th</sup> of May was a dinner meeting at Twigg's Restaurant, Riverside and the guest speaker was Mr Anthony Coote from Australian Customs. Anthony's talk was wonderful and gave us further insight into our hard working Customs Service.

## North West Tasmania Amateur Radio Interest Group

Reminder of the Marconi Centenary Celebrations event from 12 - 16 July 2006 in Devonport. The committee has located the original spark transmitter and the Devonport Maritime Museum is being readied for the event. There will be an ARISS contact with Expedition 13 crew and Reece & Devonport High Schools. There will be displays, ATV, special event stations and much more.

The organising committee is also seeking any appropriate radio equipment and documentation for the event.

Contact Tony VK7AX on telephone: (03) 6425 2923 or email: [nwtarig@spamex.com](mailto:nwtarig@spamex.com).

After 47 years in the motion picture industry he retired in 1976.

Eddy used to attend the WIA meetings just around the corner in Liverpool St between spools in his theatre manager's dinner suit to donate theatre tickets to be raffled to aid club funds. Eddy obtained his amateur licence in 1947 and after constructing the equipment, first came on air in 1948. His main interest was in Morse operating. A true gentleman.

Vale Eddy.

(Charles VK7PP, Richard VK7RO and Phil VK7ZAX)



## Of continents and islands

Sad news. An old friend departed English language broadcasting last month.

Radio HCJB in Quito, Ecuador ceased broadcasting in English on May 6<sup>th</sup> after 75 years of broadcasting. This station was one of the first shortwave signals I came across, some 50 years ago. It was also the first station that sent me a QSL card and it took a year for the round trip.

Spanish and indigenous language broadcasts are still aired on shortwave but the huge antennas at Pifo are being dismantled to make way for the new Quito Airport. English language broadcasts, of course, continue from sister station, HCJB-Australia in Kununurra WA.

The VOA transmitters in Kavala and Rhodes in Greece were also recently significantly downgraded and may have been taken over by the Greeks. I also note that Greek relays via VOA sites in the US also ceased around the same time. VOA

News Now will also cease in October.

There has been recent trouble in the Solomon Islands, just near the eastern tip of Papua-Nuigini. Australian and NZ troops went there in late April to restore order after post election violence threatened to become all-out civil war. Law and order is now restored but tensions still remain volatile. You can easily hear the SIBC from Honiara on 5020 and between 1100 and 1900 this station relays the BBC World Service.

The nearby island nation of Vanuatu is heard on 3945 and 7260, the latter best heard before 0900 as this frequency is popular with other broadcasters. Programming is in English, French and a local language known as Bislama, which is almost identical to Tok Pisan in PNG.

As you are aware, the small Tasmanian town of Beaconsfield catapulted to the World Spotlight in late April - early

May when three miners were trapped underground after a small earthquake. Sadly one of the three was killed in the rockfall and it was 5 days before they discovered that two of the surviving miners were still alive. Gladly they are now free.

It has been interesting to hear news reports of the Beaconsfield tragedy and rescue over many shortwave stations, in a variety of languages and dialects. My grandfather along with his father and uncle were employed in the original Beaconsfield Mine and their photos are in the Museum which adjoins today's Mine Complex. I still have many relatives within the area.

Well that is all for this month. Don't forget you can email me at vk7rh@wia.org.au or snail mail at 20/177 Penquite Road Norwood Tas 7250.

ar

# Australian Radio Industries Pty Ltd

Service to Industry, Commercial, Amateur & CB Radio Applications

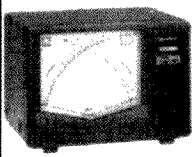

Prices inclusive of G.S.T.

## SPECIALISTS IN



- Rg Series Coax
- Ultraflexible Coax
- Heliax Corrugated Hardlines
- Waveguides & Semi-rigid
- Hi-temp Teflon Coax
- 450 & 300 Ohm Twinfeeders
- Multi-core Control Cables
- All Coax / Hardline Connectors
- All Coaxial Adaptors
- Hard & Soft Drawn, Copper Wires

- Enamelled Copper Wires
- Coax Sealing Products
- Installation Accessories & Equipment
- Ceramic and PVC Insulators
- Flat Earth Braids
- Dacron Uv Ropes
- Mobile & Fixed Antennas - Cb & Amateur
- Dipole & Wire Antennas
- Lightning Protection & Earthing
- Cable Assemblies

The RF Specialists  
ABN 67 117 379 218



SUPPLIERS, IMPORTERS, & MANUFACTURERS

PAY BY - MASTERCARD, VISA, BANKCARD

Disclaimer: Prices subject to change without notice.

Prices inclusive of G.S.T.

Make us your last call, as we will be your first choice on Quality, Service, Technical advice and the best possible price!

### END OF FINANCIAL YEAR SALE !

TIMES LMR400	\$4.00/m
TIMES LMR600	\$8.95/m
ARI RG59B/U	\$0.80/m
300 ohm Ladderline	\$1.00/m
450 ohm Ladderline from	\$2.00/m
8 Core Control/Rotator cable	\$2.50/m
3mm Dacron UV/Rot proof rope	\$0.80/m
5mm Dacron UV/Rot proof rope	\$1.00/m
Scotch 23 Self Amalgamating tape	\$20/roll
W2AU Hi Power Antenna Baluns from	\$45

**ALL COAX CONNECTORS & ADAPTORS 10 TO 20 % OFF**

**YAESU ROTATOR SPECIALS**  
G450A - \$599.00 G-800DXA - \$950  
G-5500 AZ/EL - \$1195

**20% OFF ALL MFJ STOCK**

### END OF FINANCIAL YEAR SALE !

ARI RG213/U MIL-C-17D	\$145.00/100m
ARI RG58C/U MIL-C-17D	\$42.00/100m
LDF5-50 7/8" HELIAX	\$8.50/m
LDF4-50 1/2" HELIAX	\$4.50/m
2.00mm HD COPPER WIRE	\$25/kg
1.60mm HD COPPER WIRE	\$25/kg
CRIMP KIT with coax cutter & stripper	\$145.00
ALL CRIMP TOOLS	\$40.00
COAX SEAL PUTTY	\$6.50/roll
Fiberglass 5/8W 146Mhz Mobile Ant.	\$18.00
Stainless 5/8W 146Mhz Mobile Antenna	\$40.00
Fiberglass 4.5db 70cm Mobile Antenna	\$12.00
Stainless 4.5db 70cm Mobile Antenna	\$15.00

**All ANTENNA INSULATORS - 10% OFF**

**All FIXING ACCESSORIES - 10% OFF**

**All Cable Off Cuts - 50% OFF**

Limited stocks on some items.  
These prices valid until JUNE 30 or while available !

### HEIL MICROPHONES SALE

PROSET HC4 / HC5 - \$269	NOW - \$250.00
PROSET IC - \$279	NOW - \$260.00
PROSET PLUS - \$369	NOW - \$350.00
GOLDLINE GM4 & GM5 \$269	NOW - \$250.00
HM10 DUAL - \$249	NOW - \$230.00
HM10/5 - \$169	NOW - \$150.00
HM10/4 - \$169	NOW - \$150.00
FS2 PTT FOOTSWITCH \$85	NOW - \$80.00
HS2 PTT HANDSWITCH - \$65	NOW - \$60.00
TRAVELLER HEADSETS - \$169	NOW - \$160.00

ALL Adaptor Cables and Accessories Available.

### AMERITRON LINEARS & RCS UNITS SALE

AL-811AX 600W -	\$1529
AL-811HX 800W -	\$1899
All Ameritron & Mirage Amplifiers to ORDER !	
RCS4 4 Position Remote sw -	\$249 NOW \$220
RCS-8VX 5 Position Remote sw	\$299 NOW \$270
RCS-10VX 8 Position Remote sw	\$329 NOW \$290

### DAIWA SWR METERS - "SALE"

CN-101L HF/VHF - \$209	NOW \$185.00
CN-103L VHF/UHF - \$209	NOW \$185.00
CN-801H HF/VHF DELUXE - \$279	NOW \$250.00
CN-801V VHF/UHF DELUXE - \$329	NOW \$290.00

Office: (02) 4862 2110 BH FAX (02) 4869 4424  
EMAIL: sales@arindustries.com.au WEBSITE: www.arindustries.com.au

**Trading Hrs:**  
Mon - Fri 8am - 530pm  
Sat - 8am - 12 noon



## Contest Calendar June - August 2006

June	10	ANARTS WW RTTY Contest (Digi)	
	10	Portugal Day DX Contest	(SSB)
	10/11	South America CW Contest	
	10	Asia-Pacific Sprint Contest	(SSB)
	17/18	All Asian DX Contest	(CW)
	24/25	Marconi Memorial HF Contest	(CW)
July	1	NZART Memorial Contest	(CW/SSB)
	1	Canada Day Contest	
	8	VK/trans-Tasman 160 Metres Phone Contest	
	8/9	IARU HF World Championship	(CW/SSB)
	15/16	CQ WW VHF Contest	(All modes)
	15/16	Seanet Contest	(All Modes)
	15	Jack Files Memorial Contest	(CW/SSB)
	22	VK/trans-Tasman 160 Metres CW Contest	
	29	Waitakere (NZART) Sprint	(SSB)
Aug	5	QRP Day Contest	(CW/SSB/FM/PSK31)
	9	TARA Grid Dip (PSK/RTTY)	
	5	Waitakere (NZART) Sprint	(CW)
	5/6	10-10 Inti QSO Party (SSB)	
	12/13	Remembrance Day Contest	(CW/SSB/FM)
	19/20	Keymen's Club of Japan Contest	(CW)
	19/20	SEANET Contest	(CW/SSB)
	26	ALARA Contest	(CW/SSB)
	26/27	TOEC WW Grid Contest	(CW)
	26/27	YO DX HF Contest	(CW/SSB)

## Greetings to All Readers

### Thanks All

Before I continue with my series aimed at newer contesters, please let me say a most sincere thank you to all of you who have supported our contests so far this year. At time of writing we have had the John Moyle, QRP Hours and Harry Angel Sprint.

All of these were well supported, including several F-calls who did very well for themselves.

The comments were most positive, especially on the idea of sprint-style events. This may need careful thought amongst the planners of contests. Anyway, thank you all very much indeed.

### A Question

It has been traditional to exchange an RS(T) report and Serial Number in a contest exchange. With the emergence of contest loggers it has become the norm to give 59(9) automatically irrespective of received conditions. Whilst some of us do not actually like this, it has become the norm and I suggest it will not now change unless the rules require it – even then most would not take any notice!

I pose the question—is it time to remove the RS(T) requirement from VK contests? It was been done in the QRP Hours contest in April. I propose that it be done in the RD this year. Any comments welcome.

Now my thoughts to encourage contest participation. Hope you find them useful.

### The Quest for Idealism

#### *Part Two: Ethics – Working In the Spirit of the Contest*

In Part One last month, I touched on some of the things we need to do in order to set up for taking part in contests. Whilst I admit that much of what I wrote would be obvious, nevertheless I hope that some of you had some fresh ideas about shack layout. This month I want to look at the ethics of some modern contesting practices.

What does ethics or morality have to do with Amateur Radio contests you ask? Well, there is a certain degree of trust involved in entering a contest – and when trust enters ink, so do honesty and dishonesty. Fortunately, I believe that the level of dishonesty is very, very small; but

it can be there. An example – there have been times when operators have taken part in world-wide contests and claimed to be operating from rare DX locations; but subsequent investigations have shown that no DXpedition was authorised or in place at the time (the ARRL keeps track of who goes where in the DX stakes).

This means that someone operated, probably with a very strong signal and using a callsign illegal to that operator, but was possibly a legal callsign being used without the owner's knowledge or permission. Subsequently the logs of everyone who worked that station have to be found, rescored and the results list recalculated – a big job, but fortunately one made easier today by computerised log-checking abilities.

As I said, this is rare, but it can happen.

### Portable Operation

We all know that "portable" means being carried about, therefore in AR slang we take it to mean that we have taken our rigs, antennas and necessary gear to a place other than home, set it up and operated it for a special purpose – contest, DXpedition, holiday, etc.

Figs 2 and 3 in last month's column were suggestions how to do this. Yet Fig.2, "The Backyard Operator", is considered unethical by some people. Why?

The grounds for dispute are not that the gear has been carried and set up, but that it has been done close enough to the home shack to be able to use the home antenna system, especially if you are fortunate enough to have beams.

We all know that the better our antennas the better our signals and therefore chances of making higher numbers of QSOs and points.

But purists say that this method of antenna connection is not "in the spirit of the contest", therefore you have acted unethically.

### "In the Spirit of the Contest"

This phrase is one that is usually on the Summary Sheet of your entry and by signing your log you agree that you have operated sensibly and correctly and observed the rules and radio regulations.

Like so many things today it is easy to blur the lines of what is strictly "in the spirit of the contest" or outside it -- what is ethical or unethical. Modern technology is causing this, rather than deliberate operator practices.

### Loggers

An example of the above – most contesters now use a computer logging program. In fact the big world-wide (WW) events require that this be so.

Most people probably don't see the use of an electronic recording medium as a great issue – it is fast, can maintain any number of QSOs, calculate score, keep track of dupes and finally print your log for posting or email presentation.

Very neat, very useful, very compact (more next month).

All you need to be able to do is to type as fast as possible. Shouldn't we all be taking advantage of increasing technology as interested and progressive amateurs? Yes indeed, so where's the problem?

The problem for the purist seems to lie in the program's ability to send CW calls and exchanges on behalf of the operator. For these CW operators it is possible to make and log a complete contact by pressing just three buttons on your keyboard (apart from typing in the other operator's callsign).

Automated systems like this make for much faster speeds and therefore more QSOs per hour. Certainly you need to be able to read callsigns and numbers at speeds between 35 – 45 wpm: this seems fast, but please believe me that it is easily achievable with regular, serious practice. No, you could not carry on a chat at those speeds, but recognizing a few specific characters is not so hard.

Leaving all that aside, the purists argue that this is not Amateur Radio – there has been no personal involvement in controlling that exchange beyond typing in the callsign. The machine has done the work, therefore "not in the spirit of the contest".

This means we have a situation where you may agree with the argument, but if you want to do well in a CW contest you will ignore it. If everyone ignores the argument and uses modern technology, then it becomes acceptable at large. However, even if something becomes acceptable, the actual basis, if wrong, has not gone away, so the argument remains. This same idea applies to licensing reforms as well as to a range of social issues in our Australian community.

### Scoring Systems

Methods of scoring can be a ground for complaints of biased practices – certain areas or types of operators feel discriminated against. Often these are grounds for criticism and the wise Contest Manager will work to overcome such difficulties.

### Massaging the Log

Some operators go over their logs after a contest and make changes in the hope of gaining a few extra points. Known as "massaging", this is universally held not to be in the spirit of the contest. What you have done is what you submit.

I feel that to look over a log in search of callsign typing errors is not unreasonable. How easy it is to mis-stroke a key, eg the absence of the "V" in VK3JS could tell the program that you worked an American station when you only worked a local.

The points would be different, so fixing this genuine mistake and rescored the log may be unethical, but could save loss of points imposed by the Contest Manager as a penalty.

### Summary

All through life there would be none of us who has lived by the letter of the law at all times. If we had, there would have been little technical progress over the years.

So whilst I do not advocate blatant disregard of the rules of the contest, I do have to agree that the majority of contesters accept certain ways of operating, therefore there is little point in beating our heads against them. We join them and do the best that we can.

Next month: Thoughts on a Range of Contesting Practices.

73 and good contesting,

Ian Godsil VK3JS

ar

## Results CQ WW RTTY Contest 2005

Sect	Call	Score
SOAB Low Pwr	VK3KE	138,600
	VK3FM	47,376
	VK2GR	28,296
	VK6HZ	12,844
SOAB High Pwr	VK2NU	62,640
SO 20M	VK6APW	3,952

# Jack Files Contest 2006

John Spooner VK4AJS  
Contest Manager

15th July, 2006 0800 – 1400 UTC

This contest is in honour of the late Jack Files, a long-serving VK4 WIA councillor. It is coordinated by the Queensland Advisory Committee and is sponsored by the WIA.

Since the dissolution of the WIA Divisions and a national body now existing, it has been decided to make this contest a national remembrance of an amateur who gave long service not only to benefit Queensland amateurs, but who was an asset to all amateurs within Australia.

A slight change of the rules to this year's contest has been implemented to open this event up to all VK Amateurs. The object is still to work as many different stations in different Queensland shires and towns for the purpose of multipliers, but in addition, all participants will be able to count the first contact of each VK state or territory worked in each one hour block of the contest as a multiplier.

Provision will also be made for the working of the same station within the same one hour block if either of the stations is mobile and is passing through different shires, towns, states or territories. It is very important that VK4 stations give their shire codes with the report and number given -- eg an amateur in Livingstone Shire would give out 59001LV. Shire Codes will be published and are available from the Contest Manager.

**Object** is to work as many other amateur stations, particularly as many different VK4 shires and towns, and as many different states and territories as possible within each one hour block of the contest.

**Date:** Saturday, 15th of July, 2006

**Time:** 0800UTC - 1400UTC in six one-hour blocks for the purpose of duplicate contacts.

**Band:** 80 metres only. Use 3.5MHz - 3.7MHz to put all licence grades on an equal footing.

**Modes:** Either CW; SSB; PSK31, or All Modes

**Categories:** Single Operator; Club Station (each category can be a mobile station)

**Exchange:** Non-VK4 stations will send RS(T) plus serial number starting at 001 and incrementing by one for each contact. VK4 stations will send RS(T), serial

number and two-letter shire code for purposes of multipliers.

**Score:** One point per contact

**Multipliers:** Each VK4 Shire counts as a multiplier only once over the entire duration of the contest. All participants may also count the first contact in each state or territory as a multiplier and these may be counted within each one-hour block of the contest.

**Final Score** is total QSO points X total number of multipliers.

**Repeat Contacts:** In order to make best use of the band, stations may be contacted once in each hour on each mode. Repeat contacts with stations may be counted within the same one-hour block only if the station is mobile and crosses from different shires, towns, states or territories to another. All repeat contacts must not be consecutive.

**Logs** must show full details of all QSOs and must be accompanied by a Summary Sheet showing operator's name; address; call sign; category and mode entered; claimed score and a declaration that the rules and spirit of the contest were observed.

**Send logs by mail:** to Jack Files Contest Manager, 26 Kerr St. Park Avenue Nth. Rockhampton QLD., 4701.

**Send Logs by email:** in text format to: vk4ajs@wia.org.au

**Closing date** for all entries is 12th August, 2006

**Certificates** will be awarded to the top scorers in each mode in each VK State, ZL, P29 and any DX country (i.e. country outside VK, ZL or P29). As well there will be a certificate awarded to the overall highest scorer who will be declared overall contest winner. The only stipulation is that the overall winning operator must be a VK amateur.

## VK4 City/Town/Shire Codes

AC Aramac; AN Arakun (R); AT Atherton;  
BA Banana; BB Badu Island; BC Barcardine; BD Bendemere; BE Burnett; BF Boigu Island; BG Biggenden; BH Bauhinia; BI Bungil; BJ Bamaga; BK Burdekin; BL Balonne; BN Brisbane; BO Barcoo; BP Bulloo; BQ Booringa; BR Burke; BS Broadsound; BT Beaudesert; BU Bundaberg; BV Boonah; BW Bowen; BX Blackall; BY Belyando; BZ Boulia.  
CA Caloundra; CB Caboolture; CD Cardwell; CF Clifton; CG Cherbourg; CH Chinchilla; CK Cook; CL Calliope; CM Cambooya; CN Crows Nest; CO Cooloola; CP Carpentaria; CR Croyden; CS Cairns; CT Charters Towers; CY Cloncurry;  
DA Dauan Island; DG Douglas; DI Diamantina; DL Dalrymple; DO Doomadgee; DU Duringa; DY Dalby;  
EA Eacham; ED Eidsvold; EK Esk; EM Emerald; ER Erub Island; ET Etheridge.  
FL Flinders; FZ Fitzroy.  
GA Gatton; GC Gold Coast; GD Gladstone  
GH Gayndah; GI Goondiwindi  
HA Hammond Island; HB Hervey Bay; HK Hinchinbrook; HT Herberton; HV Hope Vale.  
IA Iama; IC Infracombe; IF Isisford; IJ Injinoo; IN Inglewood; IP Ipswich; IS Isis  
JE Jericho; JO Johnstone; JY Jondaryan.  
KC Kilcoy; KG Kingaroy; KK Kilkivan; KO Kolan; KU Kubin Island; KY Kowanyama Island.  
LA Laidley; LC Logan; LH Lockhart River; LO Longreach; LV Livingstone.  
MA Mareeba; MB Maryborough; MC Mackay; MD Mabuiag Island; ME Mer Island; MG Mornington; MH Murweh; MI Mt. Isa; MK McKinlay; ML Milmerran; MM Mt. Morgan; MN Mirani; MO Mapoon; MR Maroochy; MT Monto; MU Mundubbera; MV Miriam Vale; MX Murrumbidgee; MY Murgon.  
NA Napranum; NE Nebo; NN Nanango; NO Noosa; NP New Mapoon.  
PA Paroo; PD Peak Downs; PL Palm Island; PO Pormpuraaw; PR Pine River; PT Pittsworth; PU Poruma; PY Perry.  
QL Quilpie.  
RC Redcliffe; RD Redland; RH Rockhampton; RI Richmond; RM Roma; RO Rosalie.  
SA Sarina; SB Saibai Island; SE Seisia Island; SP St. Pauls Island; ST Stanhope.  
TA Tara; TB Tambo; TE Torres; TG Thuringowa; TI Tiaro; TM Taroom; TY Townsville; TW Toowoomba.  
UG Ugar Island; UM Umagico.  
WA Warwick; WB Warraber; WC Woocoo; WD Wondai; WG Waggamba; WH Whitsunday; WI Winton; WO Wambo; WR Warroo; WU Wujal Wujal.  
YA Yarrabah; YO Yolke Island.

*Contests continues over page*

# John Moyle Memorial National Field Day 2006 – Results

## 24 hour Portable Operation Multiple Operators

Call Sign	Operators	Mode	Band	Score	Contacts	Award
VK3CNE	Multi	All	All	6186	762	*
VK2SRC	Multi	PHONE	ALL	4282	331	*
VK3ER	Multi	ALL	ALL	3570	151	*
VK3TDV	Multi	PHONE	VHF	3250	198	*
VK5SR	Multi	PHONE	ALL	3022	235	*
VK5BP	Multi	PHONE	ALL	2772	276	*
VK2HZ	Multi	PHONE	ALL	2368	268	
VK3FRC	Multi	PHONE	VHF	2238	113	*
VK2EH	Multi	PHONE	ALL	1630	80	
VK4YZ	Multi	PHONE	HF	1516	758	*
VK4BAR	Multi	PHONE	ALL	1408	329	
VK4WID	Multi	PHONE	ALL	1400	246	
VK4WIL	Multi	PHONE	ALL	1272	342	
VK4WAT	Multi	PHONE	ALL	1211	383	
VK5ARC	Multi	PHONE	ALL	1026	167	
VK4QD	Multi	PHONE	ALL	984	480	
VK2ATZ	Multi	ALL	HF	854	427	*
VK5CTY	Multi	PHONE	HF	614	307	*
VK2ADX	Multi	PHONE	HF	572	294	*
VK3BI	Multi	PHONE	ALL	340	65	
VK4KKN	Multi	PHONE	ALL	326	119	
VK3III	Multi	PHONE	ALL	274	137	
VK8DA	Multi	ALL	ALL	212	106	*
VK3FPJ	Multi	ALL	HF	170	84	
VK7OTC	Multi	PHONE	ALL	160	80	
VK1YBQ	Multi	PHONE	HF	124	62	

## 24 hour Portable Operation Single Operator

Call Sign	Operators	Mode	Band	Score	Contacts	Award
VK40E	Single	Phone	All	2512	100	*
VK2KWM	Single	Phone	All	1276	85	*
VK2TLG	Single	Phone	HF	414	212	*
VK2WG	Single	Phone	All	354	177	*
VK5NJ	Single	CW	All	312	37	***
VK2FOZI	Single	Phone	HF	228	114	*
VK6SCS	Single	Phone	HF	196	98	*
VK2UQ	Single	CW	HF	136	68	*
VK3JS	Single	CW	All	102	51	*
VK4RC	Single	CW	HF	90	45	*
VK2FLKN	Single	Phone	HF	42	21	*
VK4EY	Single	Phone	HF	30	15	
VK2KXN	Single	Phone	HF	26	13	

\* Certificate Awarded

## 6 hour Portable Operation Multiple Operators

Call Sign	Operators	Mode	Band	Score	Contacts	Award
VK3AXH	Multi	Phone	VHF	1400	74	*
VK2BOR	Multi	Phone	ALL	664	98	*
VK2FFG	Multi	Phone	ALL	512	177	*
VK8AR	Multi	Phone	HF	254	127	*

## 6 hour Portable Operation Single Operators

Call Sign	Operators	Mode	Band	Score	Contacts	Award
VK3ZPF	Single	Phone	VHF	1620	152	*
VK4TGL	Single	Phone	ALL	434	38	*
VK5HJH	Single	Phone	VHF	296	38	*
VK5ZKT	Single	Phone	HF	212	106	*
VK5LZ	Single	Phone	ALL	188	51	*
VK2IO	Single	Phone	ALL	134	63	*
VK5OQ	Single	Phone	ALL	122	49	
VK5MH	Single	Phone	HF	114	57	*
VK4FVC	Single	Phone	HF	112	56	*
VK2AKB	Single	Phone	ALL	102	51	
AX8AA	Single	Phone	HF	80	40	
VK2IRP	Single	Phone	HF	78	39	
VK5UE	Single	Phone	VHF	26	13	
VK2EHQ	Single	Phone	ALL	20	10	

## Home Station 24 hours

Call Sign	Operators	Mode	Band	Score	Contacts	Award
VK2HBG	Home			395	256	*
VK3HAG	Home			144	86	*
VK4HTM	Home			104	59	*
VK4KLM	Home			100	50	
VK3BGH	Home			83	51	
VK2ZQX	Home			64	36	
VK5ZKT	Home			44	26	
VK6WB	Home			37	23	
VK5ATQ	Home			34	20	
VK5NY	Home			30	22	

## Home Station 6 hours

Call Sign	Operators	Mode	Band	Score	Contacts	Award
VK3UDX	Home			214	143	*
VK3BNC	Home			139	87	*
VK7HAY	Home			101	73	*
VK2ZEN	Home			80	57	
VK2JAM	Home			66	37	
VK3EOD	Home			65	42	
VK2ZNF	Home			44	22	
VK4DFG	Home			38	22	

\*\* President's Cup

# Comments on John Moyle Memorial National Field Day 2006

Denis Johnstone (VK3ZUX)  
Contest Manager

Entries came from every Australian mainland call area and Tasmania but none from ZL. If any are missing they are completely lost and I can only offer my apologies. I believe that all logs submitted are included in the scoring.

There were 10,447 contacts amounting to 58,164 points claimed. This heavy contesting only resulted in 75 logs being submitted. Stations bothering to go out and set up as portable and then submitting no log is a disappointment. A little extra effort next year perhaps? Some multiple operators got very big scores and perhaps a revision of the rules for large club stations is worth considering.

More than half of the portable stations that sent in a log got a certificate. People who 'went portable' should be acknowledged. Perhaps the rules need a revision to reward such effort?

Only two Foundation Licence operators submitted a log, despite many more logged during the contest. Perhaps they can be better advised next year? Both were awarded a certificate.

Activity occurred on all bands permitted by the rules. There was increased activity on HF, with frequencies following the declining sunspot cycle. The cycle is

very close to the bottom, conditions should improve substantially next year. In the higher Microwave bands there was very limited activity, maybe it follows a weather cycle, rather than the solar cycle? VHF and UHF activity hardly altered, with the higher scoring reflecting the higher points allowed for increased numbers of longer distance contacts.

Participation across the various Call Areas was patchy. Perhaps the weather was an explanation of the poor turn out of portable stations in VK3 and the much improved turn out in VK2 & VK4.

The scoring on VHF may need further revision as the scores produced on VHF exceed the scores on HF, where the effort required to get a high score far out-weighs the comparative effort on VHF. However, this is not the nature of contesting where HF takes time and effort to work the number of stations required, while VHF and UHF requires the vagaries of weak signals to guarantee a contact.

Many more electronic logs were submitted this year, due largely to the excellent work by Mike Subocz (VK3AVV) and his program VKCL (VK Contest Log). Logs in the VKCL export format were extremely easy to work with.

Those who simply forwarded the text output of VKCL were also rather simpler to work with than a paper log by hand.

There were still some who submitted their log in PDF, while this can be treated as text, it cannot be manipulated electronically and was as hard as hand written text to use. Finally there were a few who sent a log submission in an electronically unreadable form and they were asked to resubmit their logs.

Next year, the rules will have EXCEL as the preferred submission format. A sample linked EXCEL logging report was prepared and sent to those who requested this file. Many logs used this easy-to-use sample as the basis of their submission. (Contact me at vk3zux@hotmail.com if you would like a copy of my linked spreadsheet in EXCEL for next year.) Other suitable file submission formats are WORD or the ADI output file from VK Contest Log. Text files or paper files can also be used.

Well done to all participants and very well done those who bothered to submit a log. It is hoped that the number of logs to be submitted next year will continue the current trend of increased log numbers.

ar

## N.Z.A.R.T. Memorial Contest

Saturday, 1st July 0800 – 1400 UTC

To commemorate those from our ranks who lost their lives in World War 2.

**When:** First Saturday evening in July. Six operating periods of one hour each from 0800 – 1400 UTC (8.00 pm to 2 am Sunday NZT).

1. Usual contest rules apply.
2. Single operator stations on 80 metre band.
3. A station may be contacted twice during each operating period – once on phone and once on CW provided that such contacts are not consecutive.
4. Mobile operation is permitted.
5. **Cypher System:**  
Cyphers must be exchanged and acknowledged before points may be claimed for a contact. The cypher will consist of the RS(T) followed by a serial number starting at any number between 001 and 300 for the first contact and incrementing by one for each successive contact. eg if the first number is 599007, the next contact will be 599008 etc.

### 6. Scoring

**Phone.** One point per phone QSO

**CW.** Two points per CW QSO

**Multiplier.** The multiplier is one for each new prefix worked on phone and one for each new prefix on CW.

**Total Score**

Multiply the total of phone and CW contact points by the multiplier. EG. for 100 phone

QSOs with ZL1,2,3 and 4, the score is  $100 \times 4 = 400$ . For 100 phone QSOs with ZL1-4 and 50 CW QSOs with ZL1-4, VK1-3, W7, the score is  $(100 + 100) \times 8 = 1600$ .

### 7. Logs.

The official log sheets available from the NZART Business Manager are the preferred log sheets. Logs must show contacts in correct order of time. Do not group all ZL1, ZL2, ZL3 etc. contacts together.

### 8. Summary.

A separate summary sheet must be completed and attached to the log sheets. This must show the following:-

(a) Callsign of station and NZART Branch of which a member.

(b) Name and full address of operator.

(c) Section in which competing:

(i) Open phone & CW (Memorial Trophy).

(ii) Open CW only (Auckland CW Cup).

(iii) 'Beginners' CW only (Laing-Smith Cup). Competitors in this section must state the number of their operator certificate and the date of issue.

(iv) Low power phone and CW (Mannell Trophy).

(v) Home made SSB equipment (Brother John Rodgers Plaque).

(vi) Phone only (Phil Armstrong Plaque).

(vii) Listeners section. Rules as for the transmitting sections except that only the cypher sent by that station heard should be given. The callsign of station heard and station 'worked' to be stated.

(viii) Australian section. Rules as for the Open section.

(d) Brief description of equipment used and power output.

(e) Points summary (insert 0 where mode not used).

### Contacts Points

Phone X 1 =

CW X 2 =

Total Phone + Cw

Number Of Prefixes Attach List Of Prefixes

Contact Points Prefixes Total

Total Score X

(f) Signed declaration that the contest rules and Radio Regulations have been observed.

### 9. Submission:

All logs to be sent to 'Memorial Contest Log', Win Gilbert ZL2GI, 146 Liverton Road, Lower Hutt 6009 New Zealand, to arrive no later than four weeks after the contest date. All email enquiries and electronic submission — Win Gilbert at wgiibert@actrix.gen.nz

John Bazley VK40Q,  
P.O. Box 7665, Toowoomba Mail Centre, QLD 4352.  
E-Mail — john.bazley@bigpond.com

## Andaman amazingly active, Aves also

The last few weeks have been amazing from a rare DX point of view. I can never remember so many stations on the air at the same time from a country that has been high on the overall wanted list for so long. The country of course – The Andaman Islands. Bernie, of The Daily DX, has set up a web page covering log search facilities for a number of the stations that were active from VU4 <http://www.dailydx.com/vu4.htm>. Looking to the future it will be interesting to see if NIAR can arrange a similar type of operation for VU7 some time in the near future.

We have also had operations from Aves Island, S0IR and J5. As most DXers know YV5LIX, Jose “Joe” Manuel Valdes Rodriguez, died during the Aves Island Dxpediton of a heart attack on April 21. He was 57. A ham since 1987, YV5LIX was well known around the world as a DXer and contester on HF and VHF. After about 16 hours off the air, the operation restarted using the callsign YX0LIX in memory of Jose. Our sympathies go to his family.

The special call VI9NI will be activated from Norfolk Island on the 25<sup>th</sup> May until the 24<sup>th</sup> June to coincide with the 150<sup>th</sup> anniversary of the landing of the Bounty Mutineers.

The operation is organised by the Oceania DX Group and will include the following operators; VE7NS, ZL2IFB, VK2BAA, VK4AN, VK4DV, VK5PO and VK4FW. The group plan to be active on SSB – CW – and RTTY. Look for them on CW (1822, 3523, 7023, 10103, 14023, 18073, 21023, 24893, 28023 and 50125 kHz). On SSB (1822, 3785, 7093, 14195, 18140, 21 24940, 28475 and 50125 kHz) and on RTTY (10103, 14084, 21084 and 28084 kHz) QSL via VK4FW.

For those readers who still would like to join a Dxpediton the following may be of interest. ZS6WB, Hal, reports:-

“A C9 DXpediton will be operating from the beach resort town of Bilene, north of Maputo, from 29<sup>th</sup> June to 13<sup>th</sup> July. Antennas will be available for all HF bands from 160 to 10 meters with

Yagis for the higher bands. It is planned to operate all modes on HF. During the weekend of the 8-9 July the team will operate in the IARU HF Contest. There are still openings for additional operators who are invited to contact K5LBU for additional information. Additional information is available at <http://www.tdxs.net/C9.html>.

The following operations have been approved for DXCC credit: Iraq, YI9AQ, current operation effective September 21, 2004; Comoros, D6/WB4MBU, operation from May 24, 2001 to October 27, 2001; Comoros, D68JC, operation from October 23, 2001 to November 8, 2001; and Timor-Leste, 4W2AQ, operation from June 18, 2003 to December 17, 2003.

The following are some of the operations planned for the current period.

**JW4GHA (Roger-LA4GHA)**, will be active until 1 July on all bands, CW, digital and SSB. QSL via home call or via the bureau.

**VQ9LA (Larry-N0QM)** continues to be active on 160 to 10 and will be there until July 2006. QSL either via the bureau or his home call.

**6W2/F6ELE (Fidier)** plans to operate on the HF bands occasionally during his stay between 9 and 19 June. QSL via his home call.

**V73CS (Steve-N4TKP)** will be active until 1 August 2006 QSL via N3SL.

**P29VV (Willemsen-PA3EXX - VK4WWI)**, will be active from 16 – 19 June 40 to 10m, on SSB and CW.

**9Q/ON7KEC (Luc)**, plans to be active in spots on the HF bands from 1 April until 31 July QSL via his home call

**JA3EGZ, Mega, and JA3DFM, Yoko**, from the Himeji Amateur Radio Club and the JARL Kobe Club respectively, expect to be on the air from Kota Kinabaru, East Malaysia, between July 7<sup>th</sup> and 10<sup>th</sup>. They will sign 9M6/JA3EGZ and 9M6/JA3DFM. They hope to operate on 80-6M SSB and CW, but no digital modes. They will be active in the IARU HF World Championship event signing 9M6/JA3EGZ, all band, mixed mode, multioperator. Target frequencies, 3510,

7010, 14015, 21015 and 28015 on CW; 7088, 14170, 14250, 21270 and 28515 phone. QSL via JA3EGZ, P.O. Box 6, Himeji, Japan or via the bureau.

**VK4VB, Ralph**, says, “Looks like I’ll be returning to 5H for a few years.” Ralph holds the Tanzanian callsign 5H3RK and is now starting to put his gear together. The last time he was there he was very active on several of the HF bands.

Prince Edward Island (NA-029) **VY2/VE3ZZ (Gregg)**, is planning a trip there from 26<sup>th</sup> July until 31<sup>st</sup> July and will be participating in the IOTA Contest. QSL to his home call please.

Several operations are planned to Haiti in the coming months.

**HH/PS7EB (Glauber)** will be using an IC 746 and vertical antennas between the 19<sup>th</sup> May and 25<sup>th</sup> November. The emphasis will be on the HF bands using CW, digital and SSB. QSL via his home call -- Glauber Fernandes, PO Box 251, 59010-970 – Natal-RN, Brazil.

**Ned, N4LS** reports he will be active as HH4/N4LS from northern Haiti from the 1<sup>st</sup> June until the 8<sup>th</sup> June. He plans to operate SSB and CW on 80-10 metres during his spare time.

**HH/PY1ZV** will be active from Port-au-Prince, Haiti (NA-096) from 31 May to 8 June. He plans to operate on 80-10 metres in his spare time. Fabio works for the Brazilian Army and has joined the Brazilian military forces involved in MINUSTAH, the United Nations Stabilization Mission in Haiti.

After that, Fabio will most likely be going to Curacao (SA-006) and using the callsign PJ2/PY1ZV from the 10<sup>th</sup> June until 14<sup>th</sup> June. For both operations please QSL via PY4KL.

Good luck in the pile-ups until next month.

Special thanks to the authors of *The Daily DX (W3UR)*, *425 Dx News (1JQJ)* and *QTC DX PY2AA* for information appearing in this month’s DX News & Views.

For interested readers you can obtain from W3UR a free two week trial from [www.dailydx.com/order.htm](http://www.dailydx.com/order.htm)



## ALARA AGM

ALARA held the AGM on the air on Monday 1<sup>st</sup> May. There were 13 stations heard (and possibly as many listening on the side). We are always pleased to have more stations on the air for our AGM than for a normal Monday night Net. No-one is afraid of being 'dobbed in' at our AGM; all names are submitted well in advance. Perhaps that is why we are not afraid to be heard!

Marilyn VK3DMS is our new President, standing in for just one year to give Bev VK6DE time to have her aerials up and going at her new location. We look forward to a good year and to having Bev in the chair next year. Bev is currently our 1<sup>st</sup> Vice-President.

We have two 2<sup>nd</sup> Vice Presidents to cover the possibility that one of them may not be able to take the position because of family commitments, Shirley VK5JSH and Susan VK7LUV.

Our new Secretary will be Susan VK7LUV, Margaret VK4AOE will continue as Treasurer and Souvenir Custodian, and Bron VK3DYF will continue as Minute Secretary.

Most of the other positions will be filled as they were last year. The full list is in the ALARA Newsletter.

We wish them all well and thank them for their service to our association.

If, at any time, you would like to help out in any capacity but you don't have anyone near you to nominate you, please let us know. Like all organisations, we like to have new blood to mix with the 'old timers'. This is what keeps us on our toes and will help us to go forward.

ALARA, with members scattered across this vast continent, is unique, but the situation does have its problems. So please, offer to help. We need you all.

## YLs Participate in a DX Station

Evelyne F5RPB, whom many of us met in Murray Bridge, was invited by the Council of Europe to activate a special event station as part of the International Day of the YL, on March 10<sup>th</sup> and 11<sup>th</sup>.

To assist her she called on Anne Marie DJ0FR and Olga DJ0MCL, and a team of OM helpers.

The station was housed on the top of the building of the Council of Europe Radio



Olga DJ0MCL, Anne Marie DJ0FR, and Evelyne F5RPB sitting at the rigs

Club, and used two Kenwood TS-850 radios. Anne Marie and Olga operated on 40 and 80 metres, SSB and Evelyne used CW on 20 metres.

Although conditions were not very good (on the Sunday morning they had to compete against a contest) they made 600 contacts and had a good time in the process. A photo of the three YLs illustrates the set-up.

## Sudden SK in VK5

We were saddened to be informed of the sudden death of Janet VK5NEI, recently. There was no warning at all of ill health, in fact the family was about to gather for a get-together not associated with illness, a wedding or a death, when it happened.

Three ALARA representatives attended the funeral, Jean VK5TSX, our State Representative, Lorraine VK5LM, one of the earliest members of ALARA and Christine VK5CTY.

In recognition of the long and dedicated service Janet had given to the Country Fire Service, her coffin was covered with her uniform and her hard hat. In memory of the beautiful Dalmatians who accompanied Janet wherever she went, a photo of Janet with the latest two young ones graced

the other end of the coffin.

To recognize her membership of ALARA, Jean wrote on one of our yellow scarves and placed it on the coffin.

Janet will be missed by us all but there will always be many happy memories of her, too.

ar



## HAMFEST 2006

SUNDAY 6<sup>th</sup> AUGUST  
CYRIL JACKSON CENTRE  
FISHER ST BASSENDEAN 9am START  
WESTERN AUSTRALIA'S PREMIERE  
EVENT IS ONCE AGAIN UPON US.  
IN THIS, OUR 20th YEAR, WE ARE PROUD TO  
WELCOME INTERSTATE TRADERS AND  
EXHIBITORS.

AS USUAL WE WILL HAVE EXCELLENT FOOD AND DRINKS  
AVAILABLE AT REASONABLE PRICES AND GREAT RAFFLE  
PRIZES TO BE WON ON THE DAY.

PLENTY OF TABLES AND PARKING AVAILABLE  
CONTACT KEITH VK6XG FOR FURTHER DETAILS ON  
Mobile 0419 901 539 OR vk6xg@amsat.org

**PLEASE NOTE THE NEW DATE !!!**  
SUNDAY 6<sup>th</sup> AUGUST 2006

# VHF/UHF - An expanding world

David Smith VK3HZ  
vk3hz@wia.org.au

## Weak Signal

**With not a lot happening on the terrestrial propagation side of things, it's probably a good time to have a look at the local EME scene where there has been a bit of recent activity.**

EME operation on the 23 cm band has had a recent surge of interest with a number of new stations becoming active. Doug VK3UM has installed a new dual band feed (70 cm / 23 cm) for his monster 10 m dish and reports "satisfactory" results. Over the weekend of 4/5 March he reports working 26 stations on 23 cm. On the following weekend, during the DUBUS contest weekend, he reports working 35 stations on 70 cm.

As is often the case, these contests are run when the moon is in a northerly declination, favouring the European and US operators, but giving us poor southerners only a limited window in which to work them.

Trevor VK4AFL has also recently commenced operations

on 23 cm using a 3.7 m satellite TV dish. While he is finding the dish size a little on the skinny side for EME operations, he has nevertheless detected his own echoes running as little as 35 watts – not a bad feat.

Rex VK7MO has also recently erected a satellite TV dish and become QRV on 23 cm EME. His dish is only 2.3 m in diameter, but he has had some good results, able to work similar size stations. Of course, most of Rex's contacts are using JT65 digital mode. He lives in an area with a good view over Hobart so his neighbours tend to be, somewhat understandably, sensitive to any sort of intrusion in their view.

While radio antennas might be a visual feast for amateurs, they don't have quite the same appeal to the layman. Therefore,

Rex has devised a "balcony portable" type setup that can be rolled out of sight when not in use. Nevertheless, it has been spotted by the neighbours, with comments that it looks like he's setting up for a moon landing.

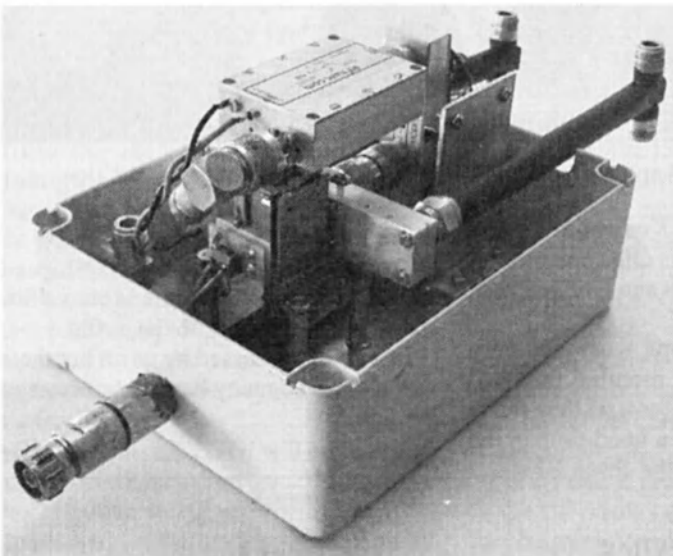

VK3UM New 23cm Dish Feed Switching & Preamp

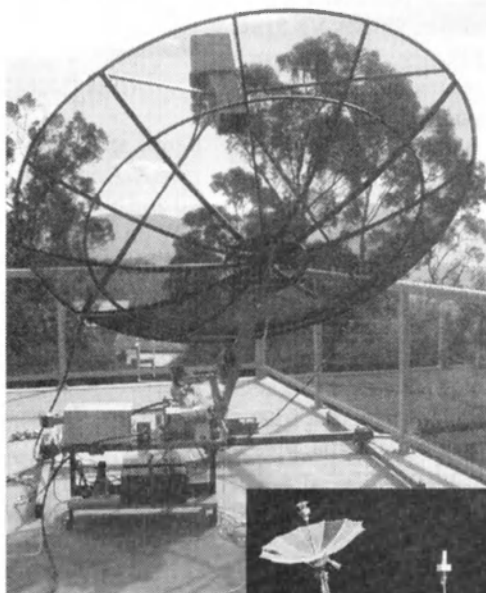

Both of these are used for Earth/Moon communications. Which one lives on Rex VK7MO's balcony?

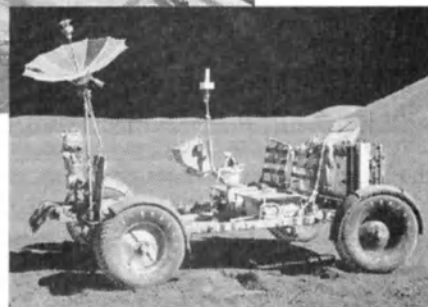

While we're on antenna photos, Kev VK4KKD (of "One Man Tower" fame) sent in some photos of his portable antenna setup on its first trial. With the help of Wayne VK4WS and John VK4ZXS, Kev erected the system on a mountaintop near Laidley S.E. Qld for final adjustments.

The system consists of 4 x 12 el DL6WU on 144 MHz and 8 x 28 el DL6WU on 432 MHz. The array is 6 m x 6.4 m x 4.5 m with the top antennae at 10 m above ground, all mounted on a trailer.



VK4AFL Dish and 23 cm Feed

## Microwaves

Russell VK3ZQB, Colin VK5DK and Trevor VK5NC have been enjoying their annual microwave operations in Queensland. Despite appalling weather, they achieved some new VK4 record distances. Russell reports:

We have just returned from VK4 where, as well as holidaying and visiting family, we had a go on 5 GHz and 10 GHz from Cairns to Airlie Beach and later from the Bunya Mountains to south of Millmerran on 24 GHz.

On 17 April, I set up on a hill near Malanda and Colin and Trevor were on a hill near Cape Gloucester – just over 417 km away. On 5.7 GHz, we made contact at 0403Z, exchanging signal reports of 5-7 and 5-9. My transmitter power was 20 watts and Colin's was 16 watts. This considerably exceeded the previous best VK4 distance.

We tried to make a contact on 10 GHz and Colin heard my signal at about 4-1 but I could not hear him at all. Conditions at my location were extremely poor with heavy rain and low cloud. I returned to Cairns to check my transverter and found a problem with the oscillator.

We returned the next day to make another attempt on 10 GHz but could not make contact. We tried 5.7 GHz again and found the signals were weaker than the previous day. Severe rain scatter distortion was experienced and once again, I was in low cloud and heavy rain.

We abandoned further attempts to make contact from these locations.

On return to the Brisbane area we decided to try to extend the 24 GHz record.

On 23 April, I went to the Bunya Ranges and Colin and Trevor were at Mt Domville, 128.8 km away. We established contact with VK5DK/VK5NC on 24048.1 at 0353Z exchanging signal reports of 5-5 each way.

At 0409Z, after optimising the dishes, we again contacted and exchanged reports of 5-9. This is an increase of 10 kilometres on the previous VK4 record.

Thanks to Russell VK3ZQB for that report.

*VHF Continues overleaf*

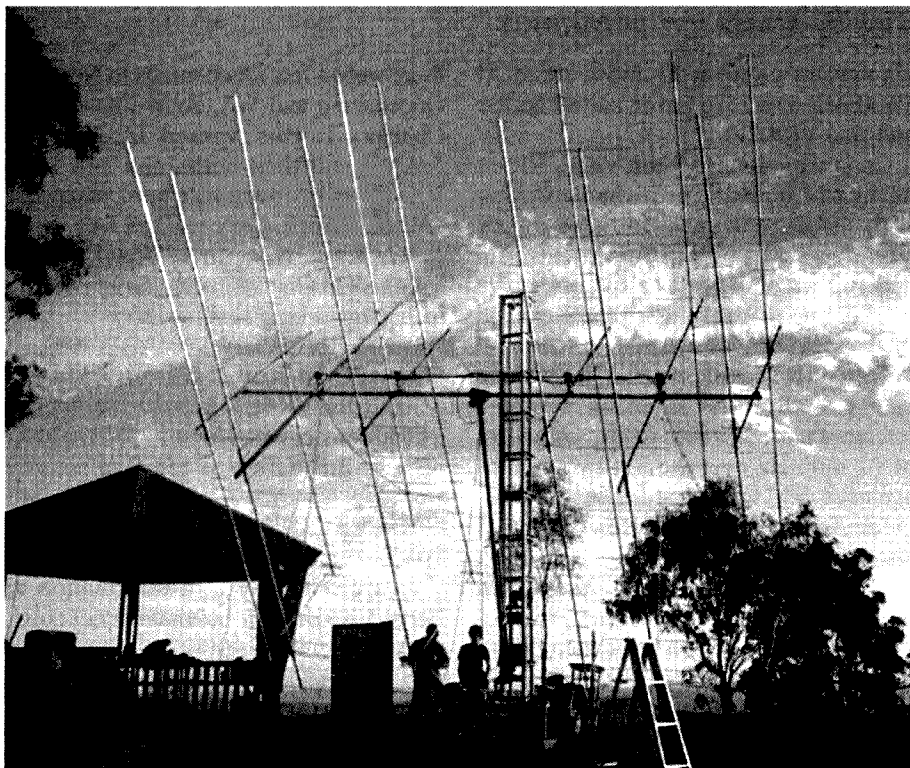

VK4KKD's (Kev) Monster Portable Antenna Array mounted on what else but a One Man Tower

The antennas can be pointed upwards for possible EME use. Kev intends to visit many grid squares and should put out a decent signal with this setup.

## Aircraft Enhanced Propagation

The morning aircraft-enhancement sessions continue on 144.2 MHz between 8 am and 9 am.

There has been much discussion about the mechanism by which the presence of an aircraft enhances VHF propagation, and I continue to be amazed at the level of that enhancement. Chris VK2DO puts in a mighty S9+ signal at this QTH at times, and at other times is barely audible. While the "S" (guess) meter is rarely an accurate gauge of signal strength, I would estimate the variation in signal level from normal conditions to "aircraft enhanced" to be of the order of 30 to 40 dB.

What aircraft / aircraft types are causing this? Where are they located relative to each of our stations? Which way are they flying? It's been very difficult to find this information in the past.

However, now it is possible, in real time, to see the aircraft flight paths on a virtual radar screen on your own PC. This is possible due to the introduction of an aircraft position-reporting system known as ADS-B.

Suitably-equipped aircraft (mandatory for all aircraft by 2009) "squitter" (transmit) their position information

to anybody in the vicinity with an appropriate receiver. The system was originally intended for collision-avoidance between aircraft, but is being extended for future possible use by air traffic control and others. An overview of the system can be found here: [www.auf.asn.au/navigation/adsb.html](http://www.auf.asn.au/navigation/adsb.html)

A UK company has developed an ADS-B receiver and PC software to allow anyone to receive and display current aircraft information: [www.kinetic-avionics.co.uk/sbs-1.php](http://www.kinetic-avionics.co.uk/sbs-1.php). The range of the system is dependent on your line-of-sight (ADS-B downlink is on 1090 MHz) but can be up to 400 km.

A system has been set up in the Sydney area showing local flights: [yssyradar.inside.net](http://yssyradar.inside.net). You will need to register to get real-time data, otherwise a 10 minute delay is added.

So, a network of these receivers along flight paths between Melbourne, Canberra, Sydney and Brisbane could provide valuable information for the aircraft enhancement operators.

## VHF/UHF – An Expanding World — continues

### UK Microwave Group — Scatterpoint

The UK Microwave Group (UKuG) publishes a monthly magazine – *Scatterpoint* – that contains some quite interesting microwave projects and information. UKuG reserves the current year's issues for members only, but the 2004 Scatterpoints are now in the public domain at: [www.scatterpoint.org](http://www.scatterpoint.org)

At the end of 2006, all ten 2005 issues will join the free archive and the process will be repeated each ensuing year. UKuG hopes that this archive will be a source of useful amateur microwave information for all. Material published in *Scatterpoint* is available for other non-profit amateur radio organisations to use in their publications. Just mention UKuG *Scatterpoint* when you use it.

If you would like to receive the latest magazines, become one of the many international members of UKuG.

Please send any Weak Signal reports to David VK3HZ at [vk3hz@wia.org.au](mailto:vk3hz@wia.org.au).

### Digital DX Modes

Rex Moncur – VK7MO

Welcome to Gary VK4ABW, near Townsville and Peter VK2IT, in Sydney who are both operational on 2 metres meteor scatter on FSK441. Gary has worked VK4AFL and VK2EAH on Meteor Scatter and is also operational on EME using JT65. Peter VK5ZPG has

his system going well and worked AI VK4EME over 1585 km on meteor scatter and also VK4AFL.

Congratulations to Rhett VK3VHF, on his first EME contact with W5UN using JT65. Rhett achieved this after many attempts using only a 7-element Yagi and 100 watts. Rhett is also very active working up to VK4 during the weekend meteor scatter activity sessions.

Tests on Newcastle channel 5a TV video carrier confirm it as an extremely stable reference on 138.276025 MHz, with a drift of <1 milli-Hz over the last two months against a GPS locked reference.

Joe Taylor K1JT, advises that he is testing a new mode that uses only 5 Hz bandwidth and can decode at -28 dB, with reference to an SSB passband, without the need for the station to be included in the call.txt file.

Please send any Digital DX Modes reports to Rex VK7MO at [rmoncur@bigpond.net.au](mailto:rmoncur@bigpond.net.au).

### The Magic Band – 6 m DX

Brian Cleland – VK5UBC

April was another very quiet month on 6m with very few reports of propagation

Norm VK3DUT reports a bit of AU on 14 April (K index 7) with the VK7RST beacon up to 529 AU and on the 15 April he worked Ray VK4BLK at Yeppoon 5x9+. He also reports strong ZLTV on 25 April and weak ZLTV on 4-5 May.

No sign of JA activity down south but

there were a few JA openings to Northern Queensland and WA. John VK4FNQ in Charters Towers worked JA1VOK on 5 April and then both John and Gary VK4ABW in Townsville worked several JA's on 7 April. Gary worked JA's on 17 & 27 April. Also on 17 April, Wayne VK4ZRT at Gladstone reports an opening to Japan working several JA's.

On 11 April, Gary VK4ABW worked DS1MFC in Korea and on 15 April worked Jon VK4CY in Brisbane. He had a good contact with Norm P29NB in PNG on 16 April. Great to see 6 m activity from P29.

The VK6RSX beacon in North West WA is regularly heard in Japan.

Please send any 6 m information to Brian VK5UBC at [bcleland@picknowl.com.au](mailto:bcleland@picknowl.com.au).

#### \*GippsTech 2006\*

It's that time again. GippsTech 2006 is to be held at Churchill in southeast Victoria over the weekend of July 8th and 9th.

**This event should not be missed by the serious weak signal operator.**

Details of the programme for the weekend are still being finalised, but a number of interesting presentations are already on the list.

If you have something to present to the VHF/UHF/Microwave community, get in touch with the organisers.

**Details may be found at**

**[www.qsl.net/vk3bez/](http://www.qsl.net/vk3bez/)**

## Silent key

### Richard (Dick) Andrew VK2UH

It is with deep regret that the Taree & District Amateur Radio Club advise of the passing of Richard Andrew, best known as Dick, VK2UH, on the 26 April 2006.

Dick gained his Novice Amateur Radio Licence in 1979 with the callsign VK2VEX, while living in Sydney. He had been involved with Marine Radio for a number of years previously.

In 1981 Dick upgraded his licence to Limited, with the callsign VK2KRA, which he held for the next 12 years. He moved to Cundletown and joined the Taree & District Amateur Radio Club.

In 1988 he became the club's Broadcast Officer and custodian of the club's callsign, VK2FRE. He ran the club nets on the 2 metre bands and the 80 metre net

until it was discontinued in 1990.

Dick upgraded further to an Unrestricted Licence, with the callsign VK2GRA. Later, at the request of the widow of a long time amateur friend who had become SK, he took up callsign VK2UH, which he cherished and used until his death.

Dick was elected Vice President of the Radio Club in 1988 and then as President in 1989. He held that position until 1993, when his health forced him to relinquish the position.

Dick served on the club's repeater committee. He also became an Examiner, appointed by the WIA, enabling him to conduct licence examinations on their behalf. He saw many gain their Amateur Licence or upgrade their current one.

His technical expertise and practical, easy to follow advice, was often sought and very highly regarded by all.

In 1999, Dick was awarded Life Membership of Taree & District Amateur Radio Club, in recognition of his long and devoted contribution to the club.

Dick was a great friend and mentor to all and his dulcet tones will be sadly missed on the Amateur Bands.

Dick's funeral service was held at Cundletown on Saturday 29<sup>th</sup> April, prior to burial at the Dawson River Lawn Cemetery. Amateurs formed a Guard of Honour, to show their respect for Dick. Sympathy is extended to his family.

VALE Dick, VK2UH

Ross Barlin VK2DVZ, President,  
Taree & District AR Club Inc.

## Emerging technology: spray on solar cells

The following was spotted in April 7<sup>th</sup> ARNewline. Not amateur radio but something that could change our portable operation in years to come!

National Geographic reports on significantly more efficient solar cells. These cells, made from a new plastic material, convert infrared as well as visible light into electric power and can turn the sun's power into electrical energy, even on a cloudy day.

The plastic material uses nanotechnology. Like paint, the composite can be sprayed onto other materials and used as a portable source of electricity. A sweater coated in the material could power a cell phone or other wireless device such as a 2 meter H-T. A hydrogen powered car painted with the film could potentially convert enough energy into electricity to continually recharge its own battery.

One scientist goes even further, claiming the new units are so powerful that covering 1/10th of the Earth's surface with such large-area solar cells could, in principle, replace all of our energy habits with clean and renewable power.

More information is on line at [http://news.nationalgeographic.com/news/2005/01/0114\\_050114\\_solarplastic.html](http://news.nationalgeographic.com/news/2005/01/0114_050114_solarplastic.html) -URL courtesy of Marv Collins. (CGC).

## New Zealand: news from across the Tasman.

The big event of the year is the NZART Convention 2006 held over the weekend of June 2-4 at the Riccarton Park Convention Centre at Christchurch.

NZART report a membership increase of 5%, most of which were transmitting members. The financial statement in their annual report indicates they had a healthy financial year.

Unlike our A-R journal, the NZART journal 'Break-In' is only produced 6 times a year. According to editor John Walker ZL3IB, over the past year there has been an increase in articles dealing with antennas and propagation topics.

Their articles are excellent and they have an agreement with the Canadian magazine to reproduce topical articles which adds to their technical presentation.

For those interested in collecting certificates, NZART will have a special station, ZL6CAN, on air during the conference. Details can be obtained from the NZART web site [www.nzart.org](http://www.nzart.org)

## U.K.: Farewell S.W.M.

For some of us 'Old Timers', the U.K. "Short Wave Magazine" was a great manual of information. In the late 40's and early 50's under editor Austin Forsyth G6FO, it was a very strong competitor to the RSGB 'Rad-Com' and 'Practical Wireless'.

Regretfully this long standing publication ceased in January 2006 and has been merged with another PW Publishing publication called 'RadioActive' and will reappear as 'RadioUser'.

At the time of writing this column your scribe has not seen this publication on the news stands in Australia.

## U.K.: Museums weekend special event

Now here's a way to promote Amateur Radio.

The sixth International Museums Weekend special event will take place on the weekend of 17-18 June. Hams around the world are being encouraged to participate in this event by setting up stations in their local museums.

Harry Bloomfield M1BYT, in Leeds England, is the organizer of this year's Museums event. He is asking that all those intending to join in should register their museum via the International Museums Weekend website.

It's in cyberspace at [\(GB2RS\)](http://www.ukradioamateur.co.uk/imw)

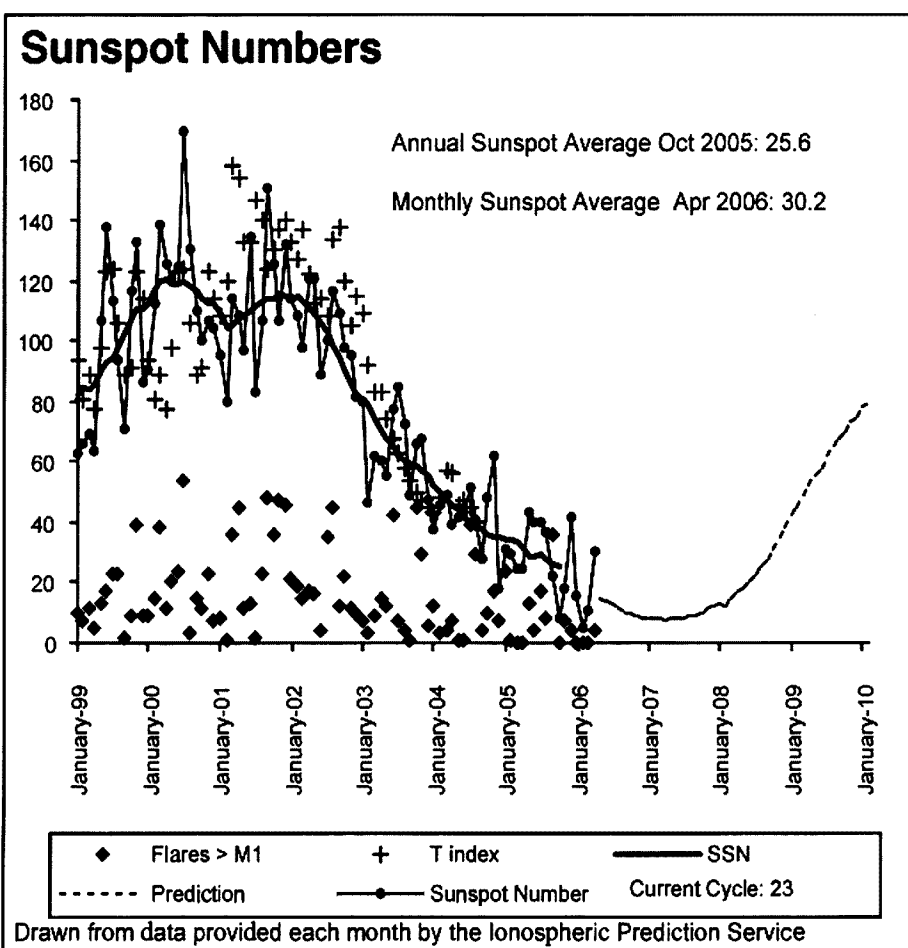

**Adelaide-Anchorage**

**30**

**Brisbane-Rome**

**315**

First F 0-5 Short 12466 km

First F 0-5 Short 16321 km

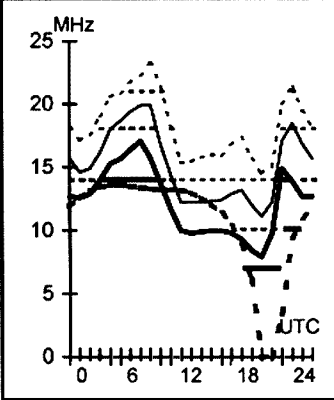
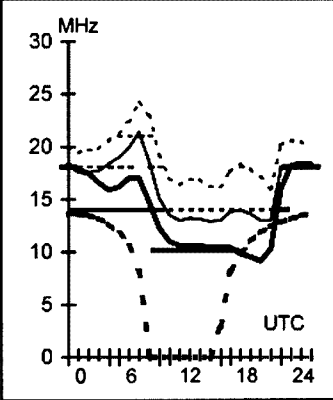

**June 2006**

T index: 14

**Legend**

- UD
  - F-MUF
  - OWF
  - E-MUF
  - ALF
  - >10%
  - >50%
  - >90%
- Frequency scale
- Time Scale

**HF Predictions**

by **Evan Jarman VK3ANI**  
34 Alandale Court Blackburn Vic 3130

These graphs show the predicted diurnal variation of key frequencies for the nominated circuits.

These frequencies as identified in the legend are:-

- Upper Decile (F-layer)
- F-layer Maximum Usable Frequency
- E-layer Maximum Usable Frequency
- Optimum Working Frequency (F-layer)
- Absorption Limiting Frequency (D region)

Shown hourly are the highest frequency amateur bands in ranges between these key frequencies, when usable.

The path, propagation mode and Australian terminal bearing are also given for each circuit.

These predictions were made with the Ionospheric Prediction Service program: ASAPS Version 4

**Adelaide-Dakar**

**233**

**Brisbane-Los Angeles**

**59**

**Canberra-London**

**136**

**Darwin-Capetown**

**231**

First F 0-5 Short 16724 km

Second 4F3-6 4E0 Short 11564 km

First F 0-5 Long 23042 km

Second 4F3-4 4E0 Short 11221 km

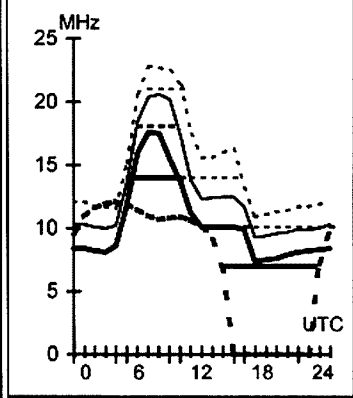
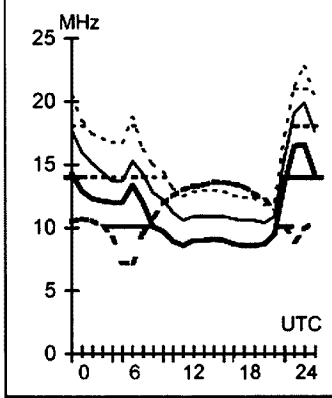
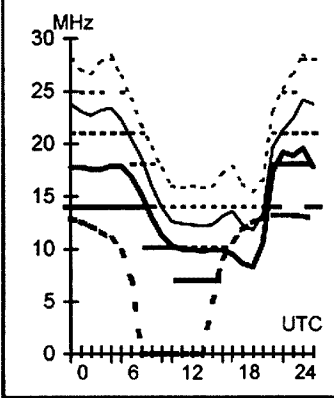
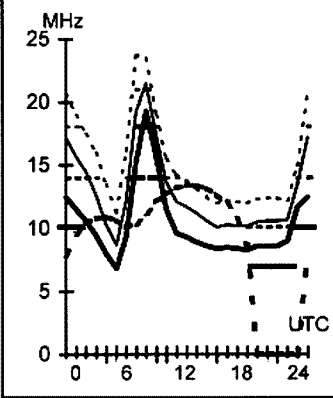

**Adelaide-Ottawa**

**58**

**Brisbane-Osaka**

**344**

**Canberra-London**

**316**

**Darwin-Tokyo**

**10**

First F 0-5 Short 16901 km

Second 3F6-11 3E0 Short 7148 km

First F 0-5 Short 16982 km

Second 3F10-18 3E Short 5436 km

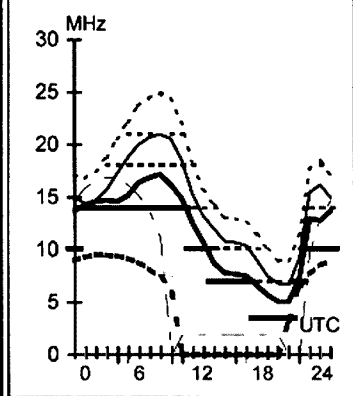
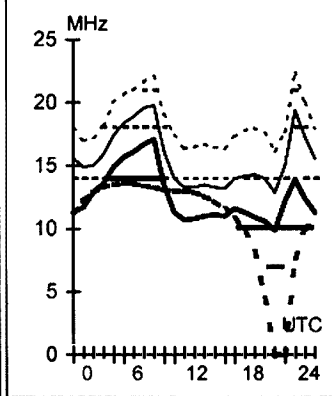
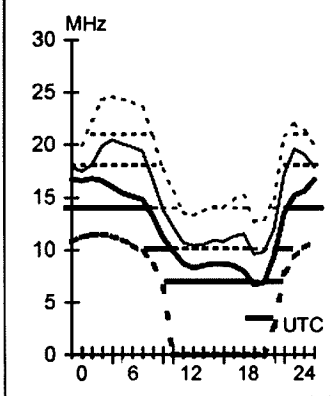
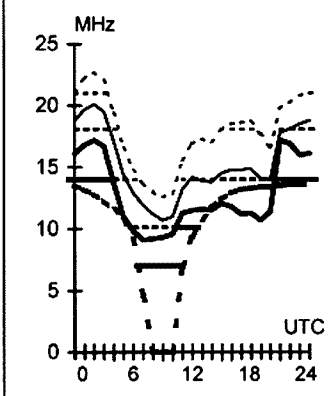

**Adelaide-Stockholm**

**142**

**Brisbane-Singapore**

**293**

**Canberra-Moscow**

**317**

**Darwin-Vancouver**

**42**

First F 0-5 Long 25029 km

Second 3F8-11 3E0 Short 6146 km

First F 0-5 Short 14481 km

First F 0-5 Short 12212 km

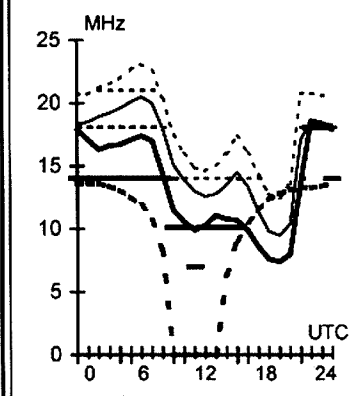
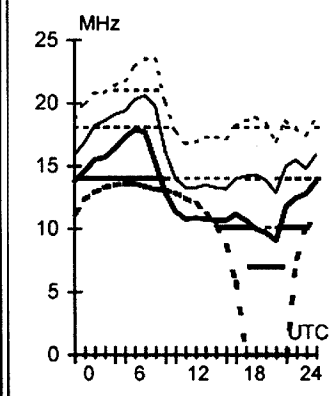
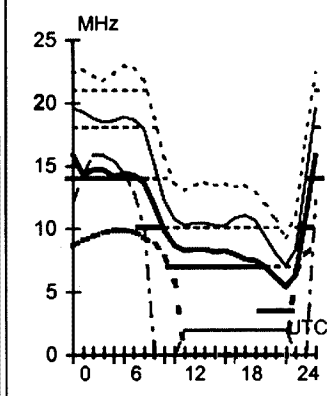
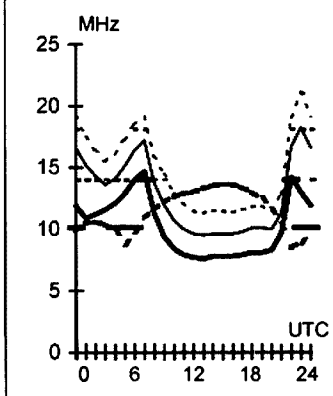

**Hobart-Dakar** 78 **Melbourne-Auckland** 97 **Perth-Honolulu** 70 **Sydney-Miami** 86

First F 0-5 Short 16895 km

Second 2F16-19 2E Short 2623 km

Second 4F3-6 4E0 Short 10905 km

First F 0-5 Short 150226 km

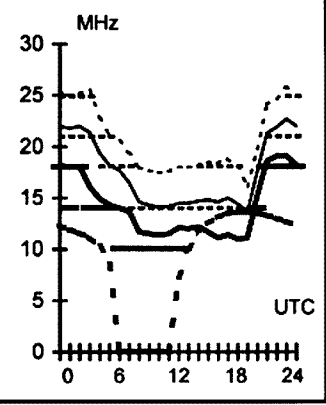
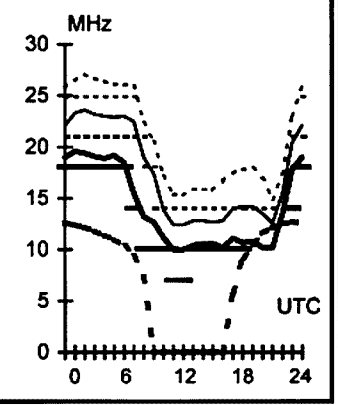
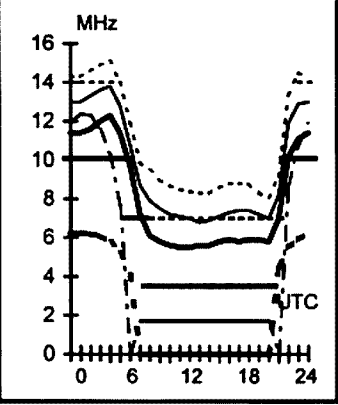
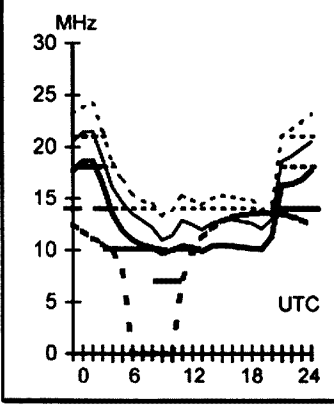

**Hobart-Christchurch** 101 **Melbourne-Lima** 131 **Perth-Johannesburg** 248 **Sydney-Pretoria** 230

First F 0-5 Short 2040 km

First F 0-5 Short 12950 km

Second 4F8-10 4E0 Short 8315 km

Second 4F3-4 4E0 Short 11063 km

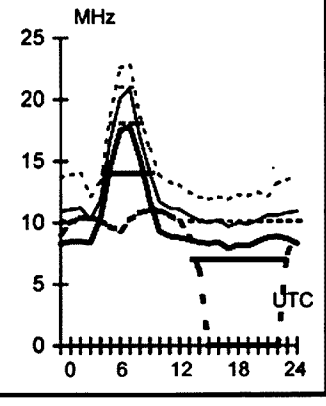
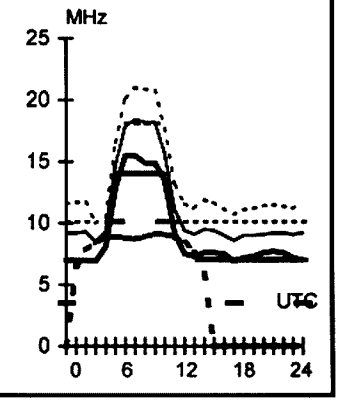
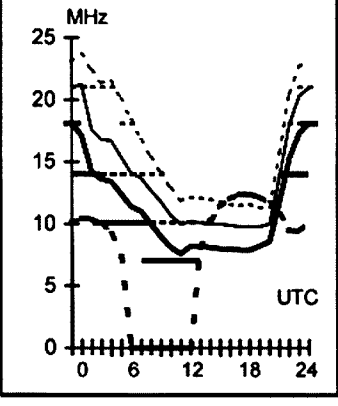
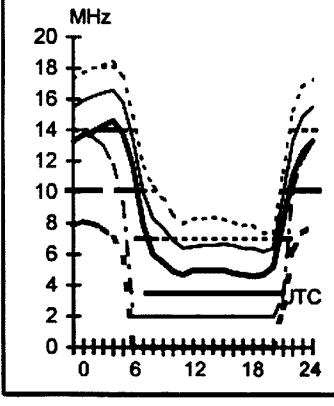

**Hobart-Lusaka** 239 **Melbourne-Montreal** 62 **Perth-London** 133 **Sydney-Seattle** 47

Second 4F3-4 4E0 Short 11045 km

First F 0-5 Short 16731 km

First F 0-5 Long 25543 km

First F 0-5 Short 12470 km

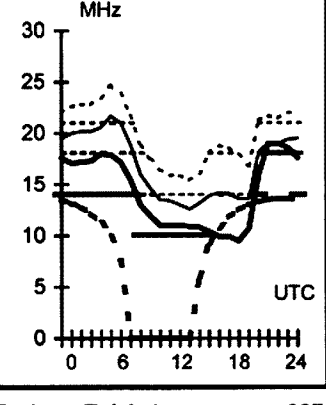
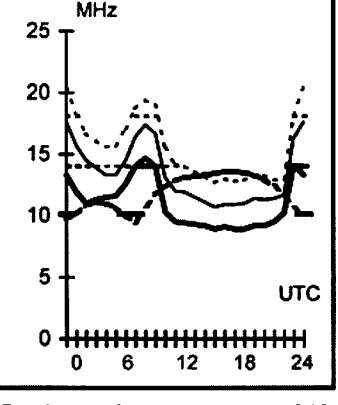
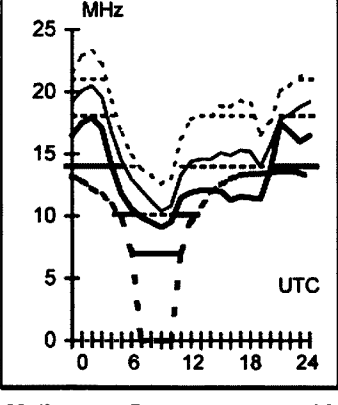
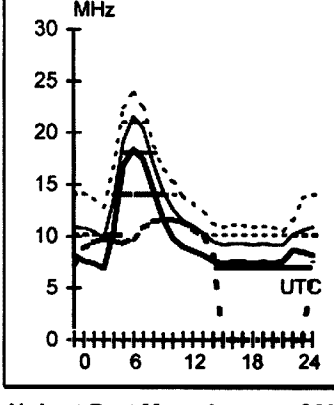

**Hobart-Port Moresby** 360 **Melbourne-Papeete** 90 **Perth-London** 313 **Sydney-Tel Aviv** 287

Second 2F10-12 2E Short 3710 km

Second 4F6-8 3E0 Short 5587 km

First F 0-5 Short 14481 km

First F 0-5 Short 14173 km

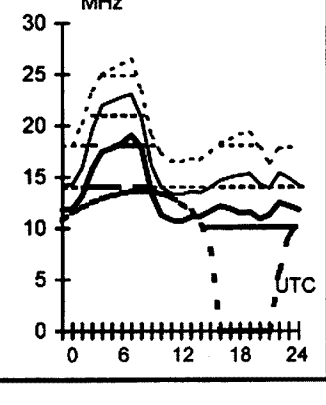
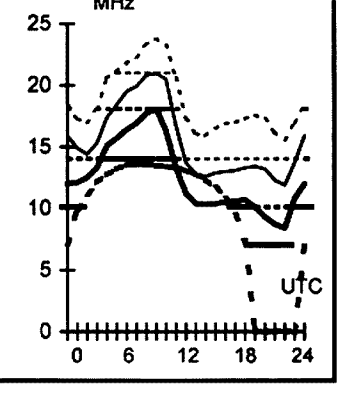
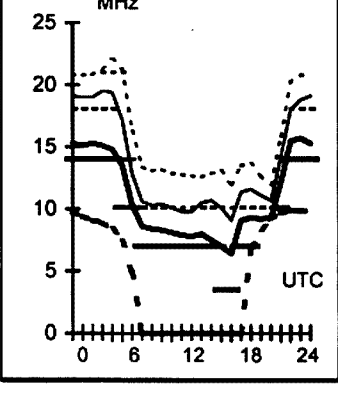
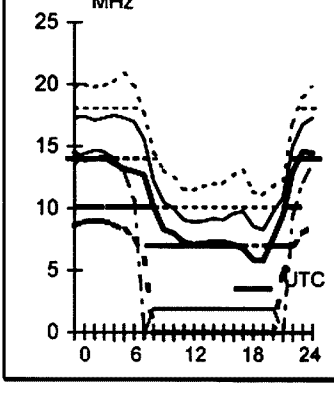

# Hamads classifieds **FREE**

## FOR SALE NSW

• IC735 HF 100W Good Cond. Mic, Man, Cable S/N 42475 \$500 + P/P. Stan VK2EL QTHR (02) 4233 2783 sbourke@shoal.net.au

• Shack clearance of useful components and other items for amateur constructors. Illawarra area enthusiasts please call. Ron VK2WB 02 4232 1794

• Pakratt Multi-Mode Data Controller. Model PK-323MBX 1992. Serial Number M02685. Brand new condition. Not used. \$100 or near offer. Call or email David Scott-Smith VK2QJ QTHR on: 02 9630 3404, 0411 505 311 Email: davidss@ozemail.com.au

## WANTED NSW

• Information on Dick Smith Direction Finding receiver model F1000. Am/FM CB/LW VHF Ant data would be appreciated thanks. Malcolm Sinclair VK2MBS QTHR 02 9958 1114

## FOR SALE VIC.

• Codan 8528 transceiver - Front Control - Has Option A (Amateur Bands) - SelCall - RFDS Emergency Call button - Interface for Codan Auto Tuner 9103 - SWL capable plus more. Codan Auto Tuner 9103 suitable for Long Wire. Codan 8558D Mobile Auto Tuning antenna with cables, heavy duty spring and spare transceiver power lead. Comes with Instruction Manuals plus Service manual for the transceiver. Originally bought new for \$4215.00, will sell the lot for \$1950.00 ONO Charlie VK3 FCJW Ph: 0407-535-477 Email chazza52@bigpond.net.au

• AWA AT5/AR8 station equipment. (2) AT5 transmitters, (2) AR8 receivers, (2) Aerial Tuning Units, (1) Type S power Supply, (2) 12 volt genemotors (one for spares), some connecting cables, and handbook. No mounting rack or DF loop. Some work required. Inspection by arrangement. Serious offers as a complete system (preferably), or as individual items. Contacted after mid July. Purchaser to arrange carriage as equipment is heavy and awkward. Rodney Champness VK3UG QTHR, Tel: 03 5825 1354, Email: rodlynn@dodo.com.au

## WANTED VIC

• Seeking parts to restore and complete my AN/TRC24 radio system. Seeking following: Transmitter, T-302/TRC. Power Supply, PP-685/TRC. Receiver, R-417/TRC. "A" Band tuner, AM-1180/GRC. Amplifier/Converter, AM-2537/TRA-25. And any other bits and pieces or books/manuals for this radio. John Eggington, VK3EGG 0409 234 672 03 9819 9065 Email johne@telpacific.com.au

• (1) JR Radio Service Handbook, VR series, issued 1964. (2) Johnson Vikin 500 amateur radio transmitter (circa 1957) with handbook. (3) No 128 2 to 4.5 MHz army back pack transceiver, preferably unmodified. Rodney Champness VK3UG QTHR 03 5825 1354, email: rodlynn@dodo.com.au

## WANTED SA

Old valve Commercial AM transmitter like Geloso, Hallicrafters etc. Working or not. Gary: 08 85363126 or vk5dxham@bigpond.net.au

## WANTED WA

• Circuit and small component values for MFJ Antenna tuner model MFJ 949B Happy to pay costs VK6ABS QTHR 08 9075 4136

• HF amplifier model Emtron dx-1d. With the led displays. Must be in vgc and not been abused. e-mail vk6wb@wia.org.au or phone/sms on 0407 030 592

## VIDEOEMAIL.

Also Live Video Messenger and Conferencing for Teaching, Talks and Tutorials. Do away with websites. Brand your Videoemail and watch your business skyrocket. Put video on your eBay ads. FREE 30 day trial Email to: arecibo@bigpond.com

## About hamads....

- Submit by email (preferred) or on the form on the reverse of your current Amateur Radio address flysheet. Please print carefully and clearly, use upper AND lower case.
- Separate forms for For Sale and Wanted Items. Please include name, address STD telephone number and WIA membership number if you do not use the flysheet.
- Deceased estates Hamads will be published in full, even if the ad is not fully radio equipment.
- WIA policy recommends that the serial number of all equipment for sale should be included.

- QTHR means the address is correct in the current WIA Call Book.
- Ordinary Hamads from those who are deemed to be in general electronics retail and wholesale distributive trades should be certified as referring only to private articles not being re-sold for merchandising purposes.
- Commercial advertising on these pages Contact Newsletters Unlimited.
- Copy typed or printed clearly please, and received by the deadlines shown on page 1 of each issue of Amateur Radio.

Email: [newunltd@bigpond.net.au](mailto:newunltd@bigpond.net.au)

Postal: Newsletters Unlimited, PO Box 431, Monbulk Vic 3793. Fax: 03 9756 7031

### TRADE PRACTICES ACT

It is impossible for us to ensure that the advertisements submitted for publication comply with the Trade Practices Act 1974. Therefore, advertisers and advertising agents will appreciate the absolute need for themselves to ensure that the provisions of the Act are strictly complied with.

### VICTORIAN CONSUMER AFFAIRS ACT

All advertisers are advised that advertisements containing only a PO Box number as the address cannot be accepted without the addition of the business address of the box-holder or seller of the goods.

## VKHAM.COM

AUSTRALIAN AMATEUR RADIO

Hundreds of pages and links related to Amateur Radio and radio in general

Home of:

- VK Classifieds
- VK Auctions
- VK's on the Internet

Repeater Maps, Software, Prefix Maps and more ...

*"Hey, Old Timer..."*



If you have been licensed for more than 25 years you are invited to join the **Radio Amateurs Old Timers Club Australia**

or if you have been licensed for less than 25 but more than ten years, you are invited to become an Associate Member of the RAOTC.

In either case a \$5.00 joining fee plus \$8.00 for one year or \$15.00 for two years gets you two interesting OTN Journals a year plus good fellowship.

Write to

RAOTC,  
PO Box 107  
Mentone VIC 3194

or call Arthur VK3VQ on 03 9598 4262 or Bill VK3BR on 03 9584 9512, or email to [raotc@raotc.org.au](mailto:raotc@raotc.org.au) for an application form.

## ADVERTISERS INDEX

AEI.....	12
Amateur Radio Bookshop.....	39
Andrews.....	8
Banalec.....	IFC
Com-an-tena.....	16
TET-Emtron.....	48
G & C.....	49
Icom.....	OBC
Ozgear.....	9
Rippletech.....	55
TTS.....	22



## HF, VHF, UHF ANTENNAS & ACCESSORIES

Aluminium towers, guys etc  
Diamond VSWR/PWR meters.

HD copper antenna wire & insulators,  
TX tubes & pwr transistors,  
full range Create Rotators

Quality coax cables & connectors.  
Free advice & catalogue.

### ATN Antennas

Ph 03 5492 2224 Fax 03 5492 2666,  
email atnant@iinet.net.au  
PO Box 80, Birchip Vic 3483

## Rippletech Electronics

**NOW AVAILABLE!**  
HIGH PASS FILTERS FOR TVI PROBLEMS.

Most TVI problems are due to the inability of the TV set to reject strong out-of-band signals - i.e. those from a local HF transmitter. Rippletech High Pass Filters are designed to reject all HF signals, and are not merely optimised to reject CB frequencies. The HPPF-50/55 has a cut-off frequency of 50 MHz and better than 55dB of attenuation on 10m and 80dB of attenuation on 80m.



TZ-1840	1:1, 1kW 160-10m Balun (1.8-40MHz)	\$ 59.00
TZ-330-4	4:1 1 kW HF Balun (3 - 30 MHz)	\$ 59.00
TZ-SL8	80m Sloper (use tuner on 17 - 30m)	\$ 99.00
TZ-SL16	160m Sloper (fits a suburban lot!)	\$ 110.00
TZ-D-4080	40m/80m Trapped Wire Dipole	\$ 176.00
TZ-V-3	10/15/20m Trapped Vertical	\$ 189.00
TZ-V-4	10/15/20/40m Trapped Vertical	\$ 289.00
TZ-V-3w	12/17/30m Trapped Vertical	\$ 199.00
	Radial kits (1 rad. per band)	\$ 33.00
TZ-RD-3	10/15/20m Trapped Rotary Dipole	\$ 279.00
TZ-RD-3w	12/17/30m Trapped Rotary Dipole	\$ 289.00
TZ-RD-40	17/40m or 20/40m Rotary Dipole	\$ 289.00
TZ-1000RC	FT-1000mp remote controller acc	\$ 33.00
HPF-55/50	High Pass TVI Filter (available now)	\$ 39.00
	Mobile base & Z bracket combo	\$ 11.00

Our trapped antennas use high Q, high isolation coaxial traps which are fully sealed and exhibit 40 dB of isolation at the resonance.

Need something special?

Give me a call and we'll see if we can meet your needs.

[www.rippletech.com.au](http://www.rippletech.com.au)

Contact Tony - VK3TZ  
0402 622 562 or 03 9887 4936  
email: sales@rippletech.com.au  
Mastercard, Visa and Bankcard accepted

## WWW.RADIOSPECIALISTS.COM.AU

Yaesu authorized Dealership in Adelaide

**Shopfront sales and not a  
backyard shed**

243 Seacombe Road South Brighton SA  
The Radio Specialists serving  
Adelaide.

## AMIDON FERROMAGNETIC CORES

For all RF/electronic applications.

See our website for complete data on all cores  
including prices.

[www.catchnet.com.au/~rjandusimports](http://www.catchnet.com.au/~rjandusimports)

### RJ & US Imports

PO Box 431, Kiama NSW 2533.  
A 3.5" PC disk containing all data is  
available for \$5.00 incl. post.

#### Agencies

Active Electronics, Tas  
TTS Systems, Tyabb (VIC)  
Tower Communications, Perth  
Ozhelp Services, Brisbane

## RM Products Italy

are now available in Australia after the  
appointment of

Hamak Electrical Industries Pty Ltd

as distributor for RM products

Visit the Hamak website at

[Hamak.com.au](http://Hamak.com.au) for

**Linear amplifiers,  
Power supplies  
and accessories**

## THE WIA QSL COLLECTION REQUIRES QSLs

All types welcome, especially rare DX pictorial  
cards, special issue. Please contact the Hon  
Curator, Ken Matchett VK3TLL, 4 Sunrise Hill  
Road, Montrose Vic 3765, tel. (03) 9728 5350



## JACKSON BROS JACKSON OF THE UK IS BACK

Highest quality products made by UK craftsmen

[www.jacksonbrothers.com.au](http://www.jacksonbrothers.com.au)

Full range now off-the-shelf in Australia.  
Variable and trimmer capacitors, reduction  
drives, dials, ceramic standoffs

### CATALOGUES, PRICE LISTS AVAILABLE

CHARLES I COOKSON PTY LTD

11-13 Port Rd

Queenstown SA 5014

Tel: (08) 8240 3200

Fax: (08) 8240 3233

FreeFax 1800 673355 within Australia

Email: sales@jacksonbrothers.com.au

ALL MAJOR CREDIT CARDS ACCEPTED  
SOLE AGENTS AUSTRALIA AND NEW ZEALAND



## Tunable Loop Antenna

enhances AM

Reception

AM radio reception (530 to 1900KHz)  
enhanced. Reception where none  
existed before; works indoors,  
even in interference-polluted areas  
High value - low cost.

Simple, no connections or batteries  
Ideal for touring, caravan, boat and fringe areas. Use  
anywhere.

[www.amradioantennas.com](http://www.amradioantennas.com)

pkloops@bigpond.net.au

Paul 0412 302 939

**PK's Loop Antennas**

## RADIOS:

	Unused	Used
Icom 706MK2G	Ring/email	\$1199
Icom 208H	\$ 550	\$ 499
Icom 910H	\$2199	\$1799
Icom 746PRO	N/A	\$1899
Icom 756PRO2	N/A	\$2799
Icom 756PRO3	\$4399	\$4099
Icom 775DSP	\$N/A	\$3599
Icom 718	N/A	\$799
Icom V82/U82 H/H	\$899	\$799
Kenwood TS2000	\$N/A	\$2199
Kenwood TS2000X	N/A	\$2799
Kenwood TS480SAT	\$1699	\$1499
Kenwood TS480HX	\$1899	\$1699
Kenwood TS570DG	N/A	\$1249
Kenwood TMD700A	\$ 849	\$ 799
Kenwood THD7A	\$ 599	\$ 549
Yaesu FT850R	\$ 649	N/A
Yaesu FT847	N/A	\$1899
Yaesu FT857D	\$1249	\$1149
Yaesu FT100D	N/A	\$1099

Plus plenty more radios in stock

## ACCESSORIES:

Doss 40 AMP PSU	\$ 235	N/A
Icom AH4 ATU	\$ 499	\$ 449
Icom AT180	N/A	\$ 549
Tokyo HL700B HF Amp	\$1599	
MFJ 993 ATU	\$449	
Icom UX910 23cm Board	\$699	

Call / email re Heil and MFJ products

DOA warranty applicable on all items (ie if  
it is not 100% and in condx as described, a  
full money back g'tee applies)

OTHER CURRENT MODELS AVAILABLE

ALL USED GEAR IN EXC CONDX WITH  
ORIGINAL BOX AND ACCESSORIES

PRICES SUBJECT TO CHANGE - CHECK  
WEBSITE FOR LATEST (OR RING)

WILL CONSIDER TRADE-INS - BUT MUST  
BE CURRENT MODEL GEAR  
(IE LAST 10 YEARS)

Ship anywhere in VK/ZL (freight extra)

ORDER ONLINE AT

**WWW.VK3AJJ.COM**

OR TELEPHONE PAUL ~

(03) 9018 9757

Mob. 0410 093 759

vk3ajj@iinet.net.au

NB - I am not an authorised dealer for  
the radio companies listed above.

These companies may refuse service on  
equipment sold by me - but other  
servicing options are available in the VK  
market.

Licensed Second Hand Dealer NO 10229 (Vic) (E&OE)

**WWW.VK3AJJ.COM - giving  
Aussie Hams a FAIR GO!**



# Directory

## The Amateur Service:

a radio communications service for the purpose of self training, intercommunication and technical investigation carried out by amateurs, that is, by duly authorised persons interested in radio technique with a personal aim and without any pecuniary interest. 1.56 ITU Radio Regulations.

*The Wireless Institute of Australia represents the interests of all amateurs throughout Australia.*

The WIA offers one year and 5 year membership for all categories except Concession Student. The fees for each category are: Full members \$75 (\$365), Overseas members \$85 (\$403), Concession members (pensioner) \$70 (\$332), Concession members (student) \$70, Full members no magazine \$50 (\$237), Family members \$40 (\$190)

### National Office

10/229 Balaclava Road,  
Caulfield North VIC 3161,  
PO Box 2175  
Caulfield Junction Vic 3161  
Australia

### Contact

Phone 03 9528 5962,  
Fax 03 9523 8191,  
10am to 4pm daily,  
nationaloffice@wia.org.au  
http://www.wia.org.au

### News Bulletin Schedule

Subject to change. See [www.wia.org.au](http://www.wia.org.au) follow National News prompts.  
Contact [nationalnews@wia.org.au](mailto:nationalnews@wia.org.au)  
National VK1WIA news is distributed to all states.

### Advisory Committees

#### VK1 Australian Capital Territory

VK1WX Alan Hawes  
VK1ZPL Phil Longworth  
VK1ET John Woolner  
VK1GH Gil Hughes

### Contact

[vk1advisory@wia.org.au](mailto:vk1advisory@wia.org.au)

### News Bulletin Schedule

Sundays at 11.00 am  
VK1WIA 7.128, 146.950,438.050  
Canberra Region Amateur Radio Club Email newsletter will be sent on request to [president@vk1.ampr.org](mailto:president@vk1.ampr.org)

#### VK2 New South Wales

VK2QV Chris Flak  
VK2XCD Chris Devery  
VK2BFN Adrian Clout

Phone 02 9689 2417  
[vk2wi@ozemail.com.au](mailto:vk2wi@ozemail.com.au)  
[vk2advisory@wia.org.au](mailto:vk2advisory@wia.org.au)

VK2WI - Sunday 1000 and 1930 hours local.1.845; 3.595; 7.146; 10.125; 14.170; 28.320, 52.525; 145.600; 147.000; 438.525; 1273.500 megahertz. Plus regional relays.  
VK1WIA news included in the morning

#### VK3 Victoria

VK3JJB John Brown  
VK3PC Jim Linton  
VK3APO Peter Mill

Phone 03 9885 9261  
[arv@amateurradio.com.au](mailto:arv@amateurradio.com.au)

VK1WIA, Sunday 11am and 8pm, 3.615 and 7.085 (LSB), 10.130 (USB),  
VK3RML 146.700, VK3RMM 147.250, VK3RMU 438.075.

#### VK4 Queensland

VK4BY Don Wilchefski  
VK4ZZ Gavin Reibelt  
VK4KF Ken Fuller

Phone 07 3221 9377  
[vk4advisory@wia.org.au](mailto:vk4advisory@wia.org.au)

VK1WIA, Sunday 9.0am via HF and major VHF/UHF rpters

#### VK5 South Australia and Northern Territory

VK5OV David Box  
VK5APR Peter Reichelt  
VK5ATQ Trevor Quick

Phone 08 8294 2992  
[boxesdnm@lm.net.au](mailto:boxesdnm@lm.net.au)  
[peter.reichelt@bigpond.com](mailto:peter.reichelt@bigpond.com)  
[vk5advisory@wia.org.au](mailto:vk5advisory@wia.org.au)

VK5WI: 1843 kHz AM, 3.550 MHz LSB, 7.095 AM, 14.175 USB, 28.470 USB, 53.100 FM, 147.000 FM Adelaide, 146.800 FM Mildura, 146.900 FM South East, 146.925 FM Central North, 438.475 FM Adelaide North, ATV Ch 35 579.250 Adelaide. (NT) 3.555 LSB, 7.065 LSB, 10.125 USB, 146.700 FM, 0900 hrs Sunday. The repeat of the broadcast occurs Monday Nights at 1930hrs on 3585kHz and 146.675 MHz FM. The broadcast is available in 'Realaudio' format from the website at [www.sant.wia.org.au](http://www.sant.wia.org.au) Broadcast Page area.

#### VK6 Western Australia

VK6NE Neil Penfold  
VK6XV Roy Watkins  
VK6QO Bruce Hedland-Thomas

Phone 08 9351 8873  
<http://www.vk6.net/>  
[vk6advisory@wia.org.au](mailto:vk6advisory@wia.org.au)  
[vk6ne@upnaway.com](mailto:vk6ne@upnaway.com)  
[vk6xv@bigpond.net.au](mailto:vk6xv@bigpond.net.au)

VK6WIA: 146.700 FM(R) Perth at 0930hrs Sunday relayed on 1.865, 3.564, 7.075, 10.125, 14.116, 14.175, 21.185, 29.120 FM, 50.150 and 438.525 MHz, Country relays 3.582, 147.200 (R) Cataby, 147.350 (R) Busselton, 146.900 (R) Mt William (Bunbury), 147.000 (R) Katanning and 147.250 (R) Mt Saddleback. Broadcast repeated on 146.700 at 1900 hrs Sunday relayed on 1.865, 3.564 and 438.525 MHz : country relays on 146.900,147.000, 147.200, 147.250 and 147.350 MHz..Also in "Realaudio" format from the VK6 WIA website

#### VK7 Tasmania

VK7ZAX Phil Corby  
VK7DG Dale Barnes  
VK7KK Reg Emmett

Phone 03 6234 3553  
[vk7advisory@wia.org.au](mailto:vk7advisory@wia.org.au)  
[phil.corby@tassie.net.au](mailto:phil.corby@tassie.net.au)  
[vk7dg@wia.org.au](mailto:vk7dg@wia.org.au)  
[regemm@ozemail.com.au](mailto:regemm@ozemail.com.au)

VK1WIA Sunday 9am on VK7WI network: 3.570MHz LSB, 146.700 MHz FM (VK7RHT South), 53.825MHz FM (VK7RAD South), 147.000MHz FM (VK7RAA North), 146.750 FM & 53.825MHz (VK7RNW North West), 146.625 MHz FM (VK7RMD North West), UHF CB Channel 15 (Hobart) and 27MHz CB - 27.225MHz LSB (Hobart). Followed at 9:30am with VK7 Regional News Broadcast also on 7.090MHz LSB & 14.130MHz USB

### Notes

1. Only three members of the state advisory committees are listed.
2. All listings are preliminary. They will be updated each month as required.
3. Membership application forms are available from the WIA web site [www.wia.org.au](http://www.wia.org.au) or the national office address above.

# WIA AGM 2006

As reported elsewhere in this issue, the 2006 Annual General Meeting of the WIA was held on May 6 in Bankstown. The event marked the first election since the (re)formation of the WIA as a National body.

By all reports, the formal proceedings were kept as brief as possible. Most reports submitted to the meeting were tabled, rather than being formally presented.

An Honorary Life Membership under the new structure was proposed by the Board and confirmed by those present. The recipient, **Bill Roper VK3BR**, was pleasantly surprised when advised of the award. Bill is shown on the cover of this issue, shortly after the formal presentation of his certificate and green membership badge at the last Publications Committee meeting.



*Some of the Board members during proceedings at the AGM.  
L-R: Vice President Ewan Mcleod VK4ERM, Treasurer Bruce Bathols VK3UV,  
President Michael Owen VK3KI, Directors Phil Wait VK2DKN and Glen Dunstan VK4DU*

The Board also announced the joint recipients of the Ron Wilkinson Achievement Award for 2006 - **Fred Swainston VK3DAC** and **Ron Bertrand VK2DQ**.

Further details of these awards and other aspects of the AGM can be found in the report on the AGM in the WIA Comment section. The detailed reports can all be found on the WIA website.



*President Michael Owen VK3KI presents the certificate for the Ron Wilkinson Achievement Award to Fred Swainston VK3DAC, joint winner for 2006 together with Ron Bertrand VK2DQ, for their work on the establishment of the education and assessment systems for the new three tier licence structure.*

# ICOM's price break through

## most affordable prices ever



### IC-7000

- HF/VHF/UHF All mode Transceiver • 100W HF/50MHz, 50W/2m, 35W/70cm • I.F DSP for improved noise rejection • Digital IF filter for Dial up selectivity • 2.5" TFT colour display for bright easy reading • Remote control DTMF Mic for fingertip control & IRLP access PLUS • digital voice storage • 2 mode band scope • Multi function meter 7 SWR display • Built in RTTY modulator



### IC-756PRO III

- HF\*6m • Sharp & soft IF filter shape • New receiver gives +30dBm third-order intercept point • One-touch record/play • Digital voice memory • Extended 1/4 Tuning step & BPF functions for SSB-D mode • 32-bit floating-point DSP and 24-bit AD/DA converter • SSB/CW synchronous tuning • 5-inch color TFT LCD • Built-in antenna tuner • Customisable filter shape • No optional filters to buy

Amateur



### IC-7800

- HF\*6m • Four 32-bit floating point DSP units • +40dBm ultra high intercept point • Automatic tracking pre-selector • Two completely independent receiver circuits • 200W output power at full duty • Ultra high frequency stability • 7-inch wide color TFT LCD • Multi function spectrum scope • RTTY / PSK31 operation without PC connection • Professional 6m receiver • Digital Voice Recorder • CF memory card.



### IC-2200H

- VHigh (65W) Power Output • DTCS & CTCSS Tone Squelch • DTMF Encode & Decode (with optional UT108) • Digital Voice & Data Communication (with optional UT118) • 207 Alphanumeric Memories

### IC-P7A

- VHF/UHF (2m/70cm) Dual-band FM Handheld Transceiver • Ultra compact body, light weight 47x81x28mm, 160g • Mini-power VHF/UHF dual bander with wideband receiver 0.495-999.990MHz • 1800mAh large capacity Li-Ion battery allows 20hours operating time (Tx:Rx:Standby=5:5:90) • 1.5W output power on 2m & 1W output power on 70cm • Simple operation • 1000 memory channels with flexible memory bank system • Oversize LCD for clear display of function information

### IC-T90A

- A new 5W Triband handheld • VHF/UHF FM 2M, 6M, & 70CM Wideband receive 495KHz - 1GHz 555 Alphanumeric memories • 13 Scan modes DTCS & CTCSS encode & decode DTMF encoder (10 memories) Wide/narrow transmit capability.



ICOM

ICOM 84

Call your local ICOM dealer [www.icom.net.au](http://www.icom.net.au) or (03) 9549 7500

Volume 74 No 7

July 2006

The magazine for AUSTRALIAN radio amateurs

# Amateur Radio



\$6.50 incl GST

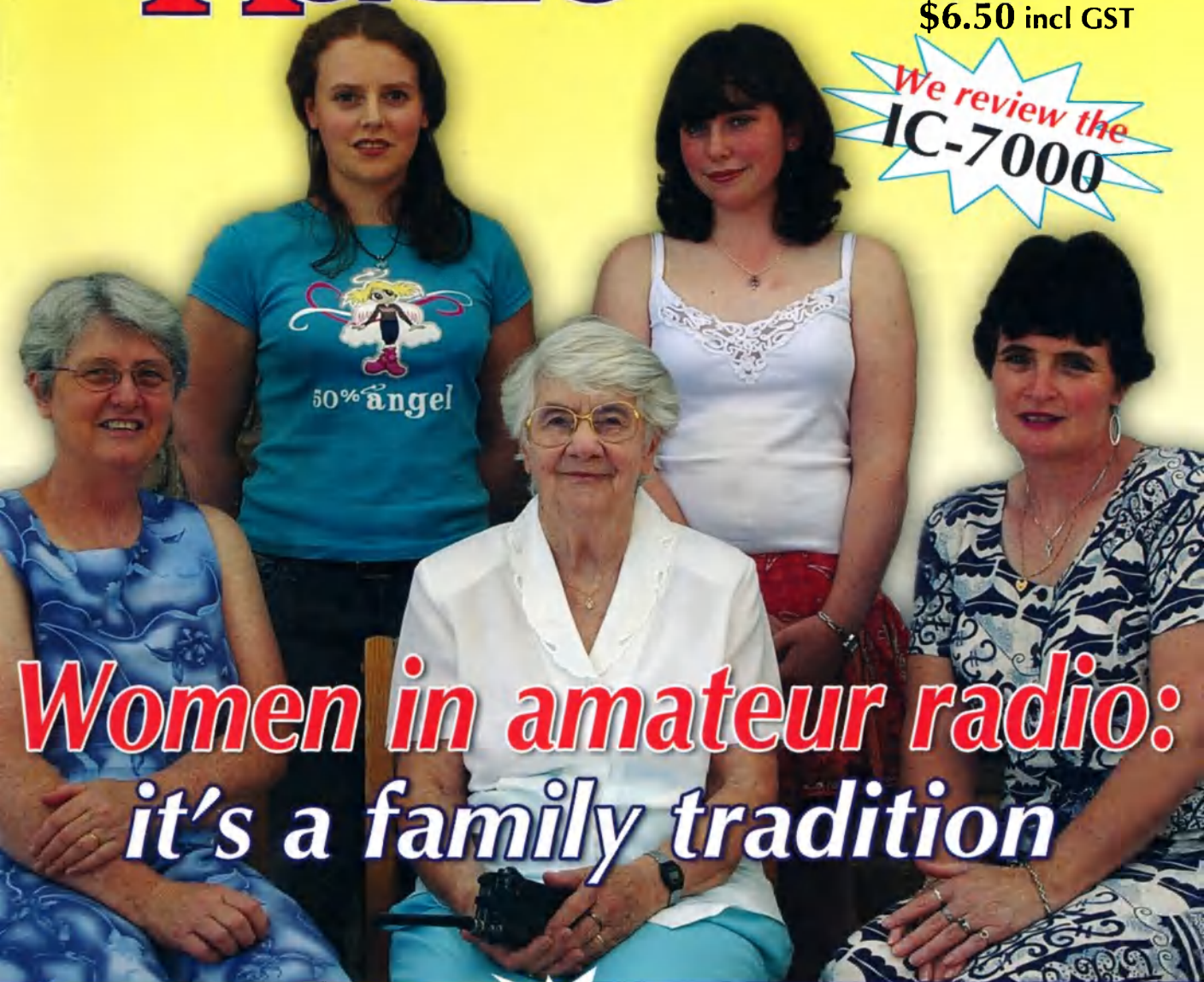

## Women in amateur radio: it's a family tradition

featuring

**Dynamic Power**

Bill Isdale VK4TWI

**Compact 160 metre vertical**

Mick Hort VK2BZE



**Hamshack**

— A software collection to please all radio amateurs



# BENELEC

# YAESU

Special Offer

## Ideal Foundation Licence Radio Options.....

### FT-817



Now includes FNB72 Internal Battery

- Ultra Compact 135 x 38 x 165mm
- All Mode Portable Transceiver
- 160 - 10m / 6m / 2m / 70cm
- 0.5-5 Watts Selectable

Price \$ 1,167.00

**UHV-4 Free with FT-817**

**Value \$194.00**

### FT-857D



Now includes DSP2 unit built-in

- Ultra Compact + All Mode Transceiver
- 160-10m / 6m / 2m / 70cm
- 100W, 100W, 50W, 20W

Price \$ 1,423.90

### FT-897D



Now includes TCX0-9 Built-in

- Portable / Mobile / Base All Mode Txr
- 160-10m / 6m / 2m / 70cm
- 100W, 100W, 50W, 20W

Price \$ 1,600.00

## .....All Bands in One Box!

### CHA250B

## Vertical HF Broad Band Antenna

Specifications

Price \$ 742.50

Amateur Bands Covers	6,10,12,15,17,20,30,40 & 75/80 metres
Transmit Frequency Range	3.5 to 57 MHz
Receive Frequency Range	2.0 to 90 MHz
VSWR	<1.5:1 (Typical)
Maximum Height	7.13m
Weight	3.20Kg
Wind Survival	108 Kmph
Transmit Power Rating	250 Watts SSB & 125 Watts FM
Impedance	50Ω

## New PC Programming Kits in Stock

### ADMS-VX6 Programming Software Kit

-Including Software & Serial to USB Cable

Price \$ 138.60

### ADMS-VX170 Programming Software Kit

-Including Software & Serial to USB Cable

Price \$ 138.60

### ADMS-4A Suitable for FT817ND

-Including Software, Serial to USB Cable & CT62 Lead

Price \$ 197.10

### ADMS-4B Suitable for FT857D/FT897D

-Including Software, Serial to USB Cable & CT62 Lead

Price \$ 197.10



### Benelec Approved Amateur Transceiver Dealers

All Price includes GST

NSW

Andrews Communications Systems

Tel: 02 9636 9060 lee.andrews1@bigpond.com

Newcastle Pro Sound & Communications

Tel: 02 4965 6899 sales@newcastleprosund.com.au

Action Communications

Tel: 02 4732 2788 action@pnc.com.au

VIC

Strictly Ham P/L

Tel: 03 9729 7656

vk3my@bigpond.net.au

G & C Communications

Tel: 03 5996 3298

gccomm@bigpond.net.au

QLD

Kyle Communications

Tel: 07 3857 4400

mark@kyle.com.au

Ozhelp Services

Tel: 07 3273 7263

sales@ozgear.com.au

SA/NT

POSNAV Systems P/L

Tel: 08 8342 4700

brenton@posnav.com.au

WA

Bushcomm Pty Ltd

Tel: 08 9296 0496

bushcomm@bigpond.com

# www.benelec.com.au



# Amateur Radio

Volume 74, Number 7  
July 2006

The Journal of the Wireless  
Institute of Australia  
ISSN 0002-6859

## Editorial

Editor: Peter Freeman VK3KAI  
editor-armag@wia.org.au

Technical Editor: Peter Gibson VK3AZL

### Publications Committee Members

Brenda Edmonds VK3KT  
Ron Fisher VK3OM  
Evan Jarman VK3ANI  
Tom Potter VK3UBS  
Bill Roper VK3BR  
Ernie Walls VK3FM

Circulation enquiries: wia@wia.org.au

### Submission of material to Amateur Radio Magazine

#### General and Technical articles to

Secretary  
AR Publications Committee  
3 Tamar Court  
Mentone VIC 3194  
or armag@wia.org.au

#### Columns and Letters to the Editor to

Editor  
AR Magazine  
PO Box 273  
Churchill, Vic 3842  
or editor-armag@wia.org.au

#### Hamads to

"Hamads" Newsletters Unlimited  
PO Box 431  
Monbulk VIC 3793  
Fax 03 9756 7031  
newunltd@bigpond.net.au

#### Advertising

All enquiries to  
Newsletters Unlimited  
PO Box 431  
Monbulk Vic 3793  
Phone: 03 9756 7797  
Fax: 03 9756 7031  
newunltd@bigpond.net.au

#### Registered Office

10/229 Balaclava Road,  
Caulfield North VIC 3161  
Australia  
Phone: 03 9528 5962  
Fax: 03 9523 8191

## Production Deadlines

General articles, columns and  
advertising booking 10th day of  
previous month.

Hamads and advertising material 15th  
day of previous month

The contents of Amateur Radio are Copyright  
Wireless Institute of Australia © 2006

## GENERAL

- Three generations of women on the air. Is this a record? ..... 13  
*Brenda Edmonds VK3KT*
- Benin 2006 ..... 14  
*Tom Wylie GM4FDM*
- An early radio amateur reminisces..... 18  
*Alan Gurr (SK)*
- Women in Radio: Joan VK3BJB..... 37  
*Christine Taylor VK5CTY*
- Preparing for the Subaru Rally in Canberra: A WICEN event..... 49  
*A VK1 correspondent*

## TECHNICAL

- Compact 160 metre vertical..... 5  
*Mick Hort VK2BZE*
- Dynamic Power ..... 7  
*Bill Isdale VK4TWI*
- Hamshack – a software collection to please all radio amateurs ..... 10  
*Morrison Hoyle VK3BCY*
- Equipment Review: The Icom IC-7000 HF, VHF, UHF all mode transceiver ..... 24  
*Ron Fisher VK3OM and Eric Buggee VK3AX*

## COLUMNS

- |                           |                                      |
|---------------------------|--------------------------------------|
| ALARA..... 35             | News from..... 30                    |
| AMSAT..... 38             | VK1..... 31                          |
| Beyond our shores..... 53 | VK2..... 30                          |
| Contests..... 41          | VK3..... 32                          |
| Directory..... 56         | VK5..... 33                          |
| Editorial comment..... 2  | VK7..... 34                          |
| Equipment review..... 24  | Over to you..... 6, 22, 29, 40       |
| Hamads..... 54            | Spotlight on SWLing..... 36          |
|                           | VHF/UHF – an expanding world..... 51 |
|                           | WIA comment..... 3                   |
|                           | WIA news..... 4                      |

## Our Cover this month

Three generations of the Edmonds family women on the air. Is this a record? See  
Brenda VK3KT's story on page 13

### Contributions to Amateur Radio

Amateur Radio is a forum for WIA members' amateur radio experiments, experiences opinions and news. Manuscripts with drawings and/or photos are always welcome and will be considered for publication. Articles on disc or email are especially welcome. The WIA cannot be responsible for loss or damage to any material. A pamphlet, 'How to write for Amateur Radio' is available from the National Office on receipt of a stamped self-addressed envelope.

### Back Issues

Back issues are available directly from the WIA National

Office (until stocks are exhausted), at \$4.00 each (including postage within Australia) to members.

### Photostat copies

When back issues are no longer available, photocopies of articles are available to members at \$2.50 each (plus an additional \$2 for each additional issue in which the article appears).

### Disclaimer

The opinions expressed in this publication do not necessarily reflect the official view of the WIA and the WIA cannot be held responsible for incorrect information published.

## Amateur Radio Service

A radiocommunication service for the purpose of self-training, intercommunication and technical investigation carried out by amateurs; that is, by duly authorised persons interested in radio technique solely with a personal aim and without pecuniary interest.

## Wireless Institute of Australia

The world's first and oldest National Radio Society  
Founded 1910

Representing

The Australian Amateur Radio Service

Member of the

International Amateur Radio Union

Registered Office of the WIA

10/229 Balaclava Road, Caulfield North Vic 3161

Tel: (03) 9528 5962 Fax (03) 9523 8191

email: nationaloffice@wia.org.au

http://www.wia.org.au

All mail to

PO Box 2175 Caulfield Junction VIC 3161

Business hours: 10am – 4pm weekdays

### National Office staff

Margaret Webb Office Administrator  
Brenda Edmonds Office Volunteer

### Board of Directors

President	Michael Owen	VK3KI
Vice-President	Ewan McLeod	VK4ERM
	Robert Broomhead	VK3KRB
	Glenn Dunstan	VK4DU
	Trevor Quick	VK5ATQ
	Robyn Edwards	VK6XRE
	Phil Wait	VK2DKN
Secretary	Chris Jones	VK2ZDD
Treasurer	Bruce Bathols	VK3UV

### Coordinators

AMSAT	Graham Ratcliff	VK5AGR
ARDF	Jack Bramham	VK3WWW
Australian ARISS	Tony Hutchison	VK5ZAI
Awards	Mai Johnson	VK6LC
Club Coordinator	Ted Thrift	VK2ARA
Contests	Ian Godsil	VK3JS
John Moyle Memorial Field Day Manager	Denis Johnstone	VK3ZUX
Editor 'AR'	Peter Freeman	VK3KAI
EMC/EMR	Gilbert Hughes	VK1GH
	Keith Malcolm	VK1ZKM
Standards	Gilbert Hughes	VK1GH
	David Wardlaw	VK3ADW
	John Bishop	VK2ZOI
NTAC	John Martin	VK3KWA
Historian	Will McGhie	VK6UU
IARU Region 3 Liaison Officer	Michael Owen	VK3KI
Intruder Watch International	Glenn Dunstan	VK4DU
Travel Host	John Miller	VK3DJM
ITU Conference & study group	Gilbert Hughes	VK1GH
	David Wardlaw	VK3ADW
	Keith Malcolm	VK1ZKM
QSL Curator	Ken Matchett	VK3TL
QSL Bureau Coordinator & VK9/0 QSL Manager	Neil Penfold	VK6NE
Repeater Coordinator	Peter Mill	VK3ZPP
Webpage co-ordinator	Colin Thompson	VK2TRC
WICEN	Ewan McLeod	VK4ERM

## Editorial Comment

### No HF predictions?

You will notice (or perhaps already have noticed) that there are no HF propagation predictions included in this issue. The Publications Committee has been discussing the provision of these for several months. We have considered several possible formats and parameters that might be used.

Why were we having these discussions? To start with, there is the space that was used – 2 pages each month for the graphs. Many readers have expressed the opinion that this space could be better used. Also mentioned was the availability of more current predictions via the internet. The printed information was helpful but not as fresh.

Another issue was the considerable time and effort spent in preparing the graphs each month. There is also the significant time delay between the preparation of the material and its publication. If the solar activity changes, then the predictions may be useless!

Part of the problem is the vast distances between locations of amateurs across Australia. With a continent the size of ours, different locations are at very different geomagnetic latitudes as we move across the country. As a result, it is difficult to provide comprehensive predictions. On the other hand, the Internet gives those interested access to the latest information on solar activity and quick tools that will readily deliver predictions for the path/s of interest.

Therefore, the Publications Committee has decided to remove the HF predictions from the magazine, initially for a period of 3 months. If you rely on our printed predictions, then you had best write in quickly to voice your opinion so that the committee can consider the impacts. Of course, we are also happy to hear from those that think that this is a good move.

### Club grants

Note that the closing date for applications for the first round of the WIA Club Grants is almost upon us. Applications close 10 July! If your club did not make the deadline, remind your committee members to consider making an application next year.

### GippsTech 2006

The annual "GippsTech" event is about to happen. GippsTech is the short name for the Gippsland Technical Conference, a semi-formal gathering and sharing of information between amateurs on issues, techniques and technologies that relate to VHF, UHF and microwave operations, especially for the so-called weak signal modes. The conference is hosted by the Eastern Zone Amateur Radio Club at the Gippsland Campus of Monash University, located in Churchill, about 170 km east of Melbourne. Further details on the conference can be found on the web at <http://www.qsl.net/vk3bez/> - just follow the links to GippsTech.

In addition to the technical sessions, there are social gatherings on Friday and Saturday nights. One part of the conference that contributes to its success is the Partner's Tour. Pauline Corrigan takes charge of the partners and leads them around some of the interesting venues within easy reach of Churchill. Highlights in the past have included many of the outlets that make up the Gourmet Deli Trail, antique stores, Walhalla township and much more.

We have a 24-seat bus and a knowledgeable "chauffeur" who usually contributes to the entertainment as well. In the past, many of the partners have insisted that they are coming back next year, regardless of whether the amateur comes or not!

As I am the Chair of the Organising Committee, I have to be there – after all, it was my idea to start the conference back in 1998. I look forward to catching up with all who attend.

### RD Contest

The Rules for this year's RD Contest are published in this issue. Make sure that you study them well before the Contest, as there are several changes this year.

I convey my thanks to the new RD Contest Manager, Peter VK4OD, for undertaking this task. We must all thank Peter for his efforts in collating the results from last year, following a series of incidences impacting upon the previous manager. Yes, the Results are finally available and will be published in August.

73

Peter VK3KAI



## The IARU

The WIA, like most national amateur radio societies, proclaims its membership of the IARU and the IARU regional organisation.

Yet many of us are confused about what the IARU is, what it does and why it is so important.

The formation of the International Amateur Radio Union, the IARU, is described in "Two Hundred Meters and Down, the Story of Amateur Radio" by Clinton B. DeSoto, Assistant Secretary of the ARRL, published in 1936.

DeSoto describes how the years 1923, 1924 and 1925 saw the exploration of the short waves by radio amateurs and the accomplishment of international communication.

Preliminary negotiations commenced in Paris in March 1924 for the creation of an international amateur organisation. This led to the First International Amateur Congress in April 1925, when a constitution was adopted, creating an organisation of individual members until strong national societies were formed in the major nations. Headquarters were located in the USA.

In 1928 the IARU constitution was amended to create the IARU as an international federation of national societies. No provision was made for subscriptions and one society was to act as the headquarters society, which was the ARRL.

DeSoto tells how by the end of 1929 there were 14 national member societies of the IARU. These were the national societies from the USA (the ARRL), Canada, Italy, Denmark, Germany, the Netherlands, New Zealand, Norway, the United Kingdom (RSGB), Spain, Belgium, France, South Africa and the Wireless Institute of Australia.

The ARRL, the national society of the USA, remained Headquarters Society until the adoption of the current Constitution in 1984.

By 1971, when IARU Region 3 was formalised on the adoption of its constitution in Tokyo, each ITU region had its own regional organisation. The regional organisations varied from the embryonic Region 3 to the powerful Region 1 organisation, leading some to

suggest that the parts were greater than the whole.

The World Administrative Radio Conference in 1979 was the turning point for the ITU and the IARU. WARC79 reviewed, over an 11-week conference, the whole of the Radio Regulations. After that, the treaties underpinning the ITU were revised, so that the ITU could meet the needs created by rapidly changing technology and new requirements with a conference every 2 to 4 years.

After 1979, the Regional organisations and the Headquarters society wrote a new IARU Constitution. What was different was that the Regional organisations formed with the Officers of the IARU, the President, the Vice President and the Secretary, what was called the Administrative Council, mimicking the then language of the ITU, and with the Administrative Council having say in the nomination of the Officers.

While the member societies pay subscriptions to their regional organisations, there is still no provision for dues in the IARU Constitution.

No longer was there a Headquarters Society, but a society providing the International Secretariat, with that society meeting the costs of the Secretariat, including the costs of the officers.

So, the ARRL was no longer the Headquarters society, but still meeting the basics costs of the IARU as the International Secretariat.

The Regional organisations provide the Regional members of the Administrative Council, conduct Conferences every three years, are responsible for representing the amateur service to their regional organisations, the APT in Region 3, and to an extent are the link between the member societies and the IARU.

But what does all that matter?

International Telecommunications Union, the ITU, is the specialised agency of the United Nations responsible, among other things, for the international coordination of the use of the radio spectrum. In the end, it is the ITU that determines the spectrum allocated to the different services, including the amateur service and the amateur satellite service.

These decisions are made at World Radiocommunications Conferences,

WRC, held every 2 to 4 years, dealing with agendas fixed by previous WRCs.

Of course, matters directly affecting the amateur service do not appear on every agenda, rather the reverse. However, in 2003, the last WRC, significant matters that directly affected the amateur service were on the agenda, and in 2007, the next WRC, significant matters of importance to the amateur service are again on the agenda.

It is through the IARU that the international strategies and policies to protect and advance the amateur service are developed. Without that, the world's national amateur societies could well be seeking conflicting positions from their administrations, making failure the likely result.

Only countries can vote at WRCs. The IARU can only participate as an observer, where it may be invited to speak, may provide information papers but cannot vote.

The IARU team can act as a coordinator and provide guidance and information, particularly for amateurs who are members of a national delegation.

Many administrations allow, even encourage, membership of their delegations by non-government service representatives, bound by their countries brief, but none the less representing their service. Australia is such a country, and the WIA has been able to nominate a member in the past and is budgeting to meet the costs of a member of the Australian delegation in 2007 representing the amateur service.

The ITU has, over its long history, developed its own way of working. It is not really the home of lawyers and diplomats, rather the communications engineer, the radio or satellite specialist. And many of the several thousand attending a WRC for their respective administrations have been attending the ITU for many years, and so know each other. "Working the corridors" has a real and special meaning in the ITU. The IARU can exert influence because it is part of the ITU, with its leaders well known and recognised, again simply because they attend so many ITU meetings, whether in the Radiocommunications Sector, or even the Development Sector.

*continues on page 6*

## Club Grants Scheme

The WIA reminds all Affiliated Clubs that Monday 10 July 2006 is the closing date for applications for Club Grants.

The WIA Board has allocated \$5,000 for distribution to qualifying Affiliated Clubs. The object of the scheme is to promote and advance amateur radio, the WIA and its Affiliated Clubs by supporting useful and/or innovative projects undertaken or to be undertaken by Affiliated Clubs.

Affiliated Clubs with a membership including at least 50% WIA members (as defined in the Rules) qualify to participate, though in the first year the Board has a discretion to allow a lesser percentage in special circumstance.

Each Affiliated Club wishing to participate in the Scheme must on or before 10 July lodge three copies of its Application at the WIA's national office addressed as follows:

Grant Committee

Wireless Institute of Australia

PO Box 2175

Caulfield Junction VIC 3161

Late applications will be disregarded.

Chair of the Grant Committee is Ken Fuller VK4KF, a member of the WIA Queensland Advisory Committee who has had extensive experience of the scheme in Queensland. Ken's professional experience includes responsibility for the administration of a number of international science and technology agreements involving the assessment of merit over a wide range of disciplines.

With him is Dr Dean Blackman VK3TX, who retired as Associate Professor from the Faculty of Engineering at Monash University in 2003. As an academic, he supported his research by winning competitive grants and so knows about the begging side of the business.

The third member is Dr Wally Howse VK6KZ, who has played a key role in considering and choosing proposals in a wide variety of fields, as Director of Technical Education Tasmania, a member of the Australian Committee (and later Commission) on TAFE, Secretary of the WA Post Secondary Commission and Director of the WA Distance Education Consortium of Universities.

The Grant Committee will recommend to the Board the projects that should be supported and the amount to be allocated to each supported project.

The full Rules can be found on the WIA website, [www.wia.org.au](http://www.wia.org.au), and Clubs are urged to check the Rules carefully to ensure that all the required information is provided.

## ACMA refuses WIA request to allow power limits as proposed in "Outcomes"

In the ACA's Outcomes of the Review of Amateur Service Regulation, published in May 2004, the proposed permitted power was specified as 10 W PEP all permitted modes for Foundation licensees, 100 W PEP for all permitted modes for Standard licensees and 400 W PEP all modes for Advanced licensees.

Subsequently, in May 2005, the ACA advised the WIA that the proposal to specify transmitter output power only in terms of Peak Envelope Power (pX) would not go ahead. The WIA was told that this change was due to concerns about the potential for increased human exposure to electromagnetic radiation and increased interference resulting from what would be an effective increase in transmitter power output for some emission modes.

The WIA requested reconsideration be given to allowing 100 Watts pX for all emission modes permitted under the Standard licence and 400 Watts pX for all emission modes permitted under the Advanced licence.

ACMA has indicated it will permit a transmitter output power of 10 Watts pX for all emission modes permitted under the Foundation licence.

ACMA has advised the WIA that it has reconsidered the matter, but retains the position that the increased risk of interference to other radiocommunications services and the potential for instances of exposure to electromagnetic radiation to increase from allowing an increase in power for some emission modes from 120 Watts pY to 400 watts pX are unacceptable.

Accordingly, and to retain the relative positions of the Standard and Advanced licences, ACMA will not change the power limits either Standard or Advanced advised in May 2005.

Arising out of this matter the President has discussed with ACMA the way high power may be permitted for Advanced Licensees for earth-moon-earth transmissions, as set out

in the Amateur Licence Information paper on the ACMA website.

In particular, attention was drawn to the requirement that the applicant for such a high power limit must obtain a written report from a laboratory accredited by the National Association of Testing Authorities, which seemed inconsistent with some assertions in ACMA's correspondence, and that self assessment was more appropriate and less restrictive and more appropriate for Advanced licensees.

## Introducing F-Troop - an on-air get together in Victoria

For some time there have been various suggestions that a weekly net on 2-metres be arranged as a meeting place for Foundation licensees.

Gary VK3FGAZ and Graeme VK3FTTG have gathered sufficient support for what is being to be called the 'F-Troop' net to discuss radio procedures and other areas of interest to new radio amateurs. The net was kicked off a couple of weeks ago with Ross Pittard VK3FCE as net control, on the Mt Macedon 2-metre repeater VK3RMM 147.250 MHz immediately after the VicLink mini-broadcast and callback.

The idea behind F-Troop is to get more experienced radio amateurs, such as WIA Assessors and course trainers, to provide advice and help in the spirit of amateur radio.

## Standard and Foundation Licensees and the 80 Metre DX window

A number of Standard and Foundation Licensees have been observed operating within the 80 m DX Window of 3.776 – 3.800 MHz. This is contrary to the Licence Condition Determinations for both the Standard and Foundation licences, which are only permitted to use 3.500 – 3.700 MHz.

Full details of frequencies available to each grade of licence can be found on pages 26, 27 and 28 of the Licence Condition Determination which can be found on the ACMA website.

ar

# Compact 160 metre vertical

Mick Hort VK2BZE

Mickh1@exemail.com.au

**This article describes a compact, easy to build, 160 metre vertical antenna for those with limited space. It uses readily available materials, and is very uncritical and easy to adjust.**

It is basically a helical with a top section of whip made from 2.4 metres of aluminium tube. The antenna is mounted about 1.5 metres above ground and fed near the base of the helical section. There is no grand design theory or masses of calculations, just a few basic principles: use heavy, wide, strip conductors at the low-impedance base of the helix, make the current portion as long as practicable, and feed it above ground so the input impedance is not next to zero.

Starting from the bottom up, my base was made from 100 x 50 x 1500 mm pine from old bed slats, two of which were nailed together and stood upright. Two other pieces of pine were fixed to the upright in a horizontal cross at the ground end. Then I nailed 45 mm flat galvanized steel strip down both sides of the upright and across the bottom of the cross, all of which was connected together for the earth. I used thin strip used by wall plasterers as it was lying around.

The helix was wound on about three metres of 100 mm ID plastic sewer pipe. From the bottom, the helix consists of 20 or so turns of heavy enamelled copper strip (or if strip is hard to get, trifilar wound enamelled copper wire 2 or 2.5 mm in diameter). This will reduce the losses in the very low impedance section near the base. The rest was wound using the nominated wire sizes, spaced out as shown on the diagram. Allow a few extra turns, as I used some plastic-covered wire which has a lower velocity factor and reduces the required turns. The close-wound turns were spaced with string as extremely high voltage can occur causing flashover between turns.

To mount the whip I used two 150 mm pieces of the same pine nailed together, drilled lengthways to take the whip, and then coated in Silastic to seal against water. This block was screwed inside the top of the sewer pipe, and a large self-

drilling screw through the wood and whip provides an electrical connection.

The pipe was then mounted to the base, with a neat-fitting overlap of 150 mm, and was secured with more self-drilling screws. To allow for easy connection and disconnection, I mounted an SO239 socket on the sewer pipe and connected the body of the socket, the bottom of the helix, and the galvanised strip together with multiple wires to keep the resistance losses down. The centre pin of the SO239 was connected to an impedance-matching tap wire which was tapped up the helix (as per a gamma match) for lowest SWR. Finally, a short strap was used to connect the top of the helix to the whip.

Once you have reached this point

you are ready for tune up. Place the antenna in an open area of lawn as far from surrounding objects as possible - objects don't tend to change the resonant frequency much but greatly affect the matching requirements. I used a ground spike about one metre down on each end of my base cross and connected them to the galvanised strip. The day I did mine Murphy was off duty, and the ad hoc, put-on-any-old-wire-I-had helix came up on 1840 kHz.

If the resonant frequency is not where you want it, you will find the wider-spaced turns change the frequency by about 10 kHz, and the close-wound

section by 20 kHz. Use this as a guide to the best way to get close to where you want it, the idea being to use as many wide-spaced turns as possible. You can close up, or space out, the turns on the close-wound section which may avoid having to cut out turns. Once tuned, tape the helix with ducting tape to hold the wire in place and also to stop water sitting between the turns, which detunes it.

Depending on the final antenna location you may need some inductance in series with the feed line to get the SWR down. Mine needed about 7 turns, 50 mm in diameter and 150 mm long of heavy copper wire as shown on the diagram,

*continues over page*

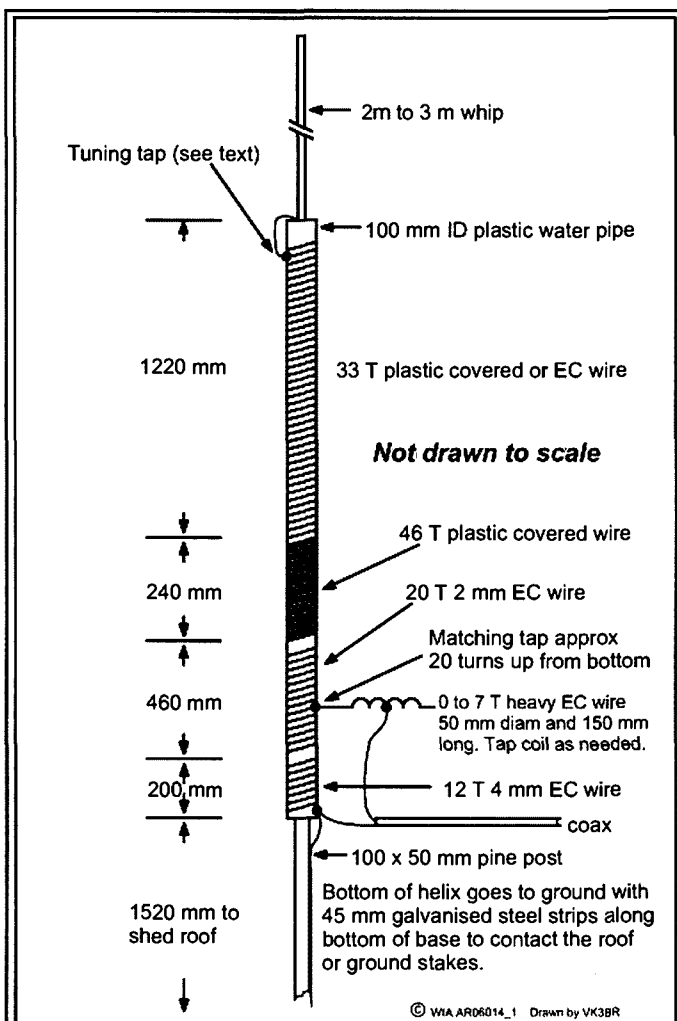

Fig 1 - The compact 160 m vertical.

# Over to you

## The selfish use of power

One of the hallmarks of a good radio operator in either the amateur or commercial services is what I would term "spectrum conservation" - using only the minimum amount of power to achieve reliable communication thus minimising interference to other users and allowing more stations to utilise the band space.

One recent Sunday afternoon 20 m opened up to Central Africa on the long path. Signals were weak but I, and a couple of other northern VK4 stations decided to give it a go. Our efforts were thwarted by horrendous interference from a VK1 and a VK2. From my "reading of the mail", both were running 400 watts and receiving 59+ reports from the USA. The VK1 was spluttering across over half of the band. The VK2 was not quite as bad but still broad as a barn door at this QTH (and before anyone says "get a decent receiver", I must point out that I have a very good one, with excellent filtration, and yes, after 42 years and 200+ countries worked, I do know how to set it up properly).

I make the following plea to all operators: If you don't need to use the linear to get a solid contact then turn it off. Running high power when it is not needed is simply being selfish and discourteous to others. 73

Wayne Melrose VK4WDM

## On-air behaviour

Re the article in May's magazine page 3: On-air behaviour.

In no way do I accept vulgar or foul language over the air. I was once told that vulgar language "is the lazy tool of people who have a limited vocabulary".

We have rules and regulations governing what can be said on air. We only have our governments to blame for the decline in decency on air.

Australia is a signatory to a document of the UN: 'The Universal Declaration of Human Rights', article 19 of which states: 'Everyone has the right to freedom of opinion and expression; This right includes freedom to hold opinions without interference and to seek, receive and impart information and ideas, through any media regardless of frontiers'.

The meaning of Signatory: "bound by the terms of a signed document, a nation so bound".

Now the question is: are we bound by the ACMA and the WIA rules or do we have freedom of expression and ideas as guaranteed to us by the signing of the Declaration of Human Rights, and take note of those last six words, 'through any media regardless of frontiers'?

We are told Australia must honour any treaty signed, so why not this one?

Check it out on the WWW.

Gordon VK4KGS

## Holes in round tube

Re: Technical Abstracts May AR.

Thanks for passing on a very good idea. Like any good idea, it can be improved.

If you make two identical guide blocks, and of course you drill the first hole in a drill press, you do not need the spirit level.

One is your drilling block and the other is the holding block. Once the first hole is drilled, replace the drilling block with the holding block and pin the boom with a spare drill of the same size.

With the drilling block it is best to cap it with some sheet metal and make sure that you know the offset from either side to centre.

All you need now is a flat surface. The workshop floor is preferred to the kitchen floor. After pinning the boom in the holding block, measure off including the offset and go for your life.

If the flat surface is not as long as the boom, you can always move the holding block after a few holes.

Ted VK2ARA.

**The total value of items for sale  
in the Hamads section of this  
issue of AR is  
\$2,807,450.25.  
See page 54 for details**

## 160 metre vertical continues

but Gerry VK2APG needed nothing - it all depends on surrounding objects. Once tuned, mine was mounted on a flat shed roof, about 5 m by 5 m, where final trimming for SWR was done. It was then guyed with nylon blind cord and has withstood some very strong winds. All screws and connectors were liberally coated with Vaseline which I have found

to give excellent protection for years.

In use I receive excellent signal reports and have worked from ZL to VK4 and VK5. Reports are generally on a par with most stations. The antenna handles 400 watts from the FL-2100Z with no problems, and reports with the linear are usually 9+ which, for an antenna of only 6.5 metres in height, is not bad. On the

down side, it has a very narrow bandwidth of 8 to 10 kHz, and rain will lower the resonant frequency by up to 5 kHz.

Three units have now been made with repeatable results so, as I said earlier, they are very uncritical and can be worked around available materials without major dramas. See you on 160!

ar

## WIA Comment Continued

The IARU is an ITU Sector Member, which means as of right it can contribute to the various technical study groups and other avenues for developing a position, including the CPM, the Conference Preparatory Meeting, which before a WRC formulates the possible changes to the Radio Regulations to give effect to the various proposals.

The IARU is able to seek to be at the centre in the development of international

policy affecting the amateur service at all amateur levels and at all ITU levels.

So, the IARU and the regional organisations are our most important focus for the long-term international protection of the amateur service and its privileges.

That is why the WIA believes that support of the IARU and the IARU Region 3 is so important.

That is why the WIA believes it is right

to insist on the effectiveness of the two organisations that are so important, the IARU and IARU Region 3.

That is why it is sensible to question whether organisations created so long ago can be further improved to meet the demands of today's world. It is not sensible to question the value of what has been done to date, or the dedication of those who have achieved so much or their skills.

ar

# Dynamic Power

Bill Isdale VK4TWI

**At about 2000 hours local time the pilot closed the throttles smoothly to flight idle, the airliner crossed the invisible line of the Queensland border and coasted down its three degree descent path towards Brisbane, the cabin full of tired people. Friday night, landing expected to be in about 20 minutes.**

The cabin floor dipped and the vacuum cleaner sound was replaced by airflow noise. After a few moments the engines spooled up again and the nose rose smoothly.

The word from the pointy end was that some big thunderstorm 'cells' were entering our planned track and we would vector around them, flying out towards Warwick to let them pass behind us.

As this elaborate ballet played out in four dimensions, the aircraft turned to the west, giving the thunderstorm line a 100 mile wide berth before curving back to descend from the north in smooth air onto a runway still heavy with the water dumped by the storm now seen flickering to the south. All in a day's work for the pilots.

An extra 15 minutes in the air and a change of plans avoided any turbulence; perhaps many passengers thought that the exercise was all about giving them a smooth ride. It did that, but there is a little more to it.

The thunderstorm is a product of cumulonimbus clouds, great mountains of water vapour with strong updrafts which carry water up to where it is cold enough to freeze. The friction of the water droplets and ice crystals moving in the air builds up static electricity with positive charges accumulating near the cloud base, negative charges towards the middle and positive again at the top.

An aircraft flying through this will move through the charged particles and accumulate its own charge, which ordinarily will be gradually equalised with its environment through the static discharge wicks on the trailing edges of the wingtips. It may be carrying a large charge of one polarity and move quickly into an area of opposite charge, producing an electrical potential great enough to cause the stored electrical energy to equalise itself directly from the airframe with a lightning bolt, not a big one, but one well able to scorch the skin of the aircraft at the point of contact and, if it is on a wing, interrupt the smooth airflow

and cause the wing to momentarily stop flying and drop, until the airflow re-establishes itself.

Well, none of us particularly want that to happen, so we don't begrudge the pilot the few extra minutes added to our journey. But what have we seen?

The huge cloud has an electrical potential between it and the ground of about 100,000,000 volts. Peak currents flowing to ground in a lightning strike are typically 20,000 amperes flowing through an ionised channel with a current density of 1,000 amperes per square centimetre. A downward discharge raises the potential beneath it and it is met with a return stroke from a high point, meeting the downward stroke at about 50 metres from the take-off point. At

that moment the cloud is short-circuited to the ground and the bright return stroke that we see propagates upwards at one tenth the speed of light within a channel a few centimetres wide and at a temperature of about 50,000 degrees Fahrenheit. The current rises to its peak at the ground

in about 10 microseconds. The ionised channel, once established, may conduct a second lightning bolt until the local electrical equilibrium between clouds and ground is restored.

The energy required to drive a thunderstorm has to come from somewhere, there is no free lunch in the Universe. Most of it comes from heat released as water vapour condenses into cloud droplets; a gram of water representing the release of about 600 calories of heat. When the water freezes, another 80 calories per gram of water is released. This warms up the air and expands it so that it rises more quickly. The total energy of a thunderstorm can be calculated from the quantity of

water condensed and then released as precipitation. An average thunderstorm releases about 10,000,000 kilowatt hours, the equivalent energy to that released by a 20 kiloton atomic bomb. The bomb dropped on Hiroshima had a 15 kiloton yield.

The energy is released over time and across a substantial area and in different forms so the destructive power is muted, but can concentrate locally and capriciously with devastating force.

We can hear some of this energy in the lower parts of the high frequency radio spectrum as pops and crackles. Indeed to detect and track a storm a simple AM radio tuned to an unoccupied part of the broadcast band will do quite well. Add a directional antenna system and you have the equivalent of the storm detection equipment flying in many aircraft.

The natural physical process of a thunderstorm is generating and releasing immense electrical energy as local instabilities in electrical charges seek equilibrium. Thunderstorms are big compared to us, but small on a global scale, where electrical energy is generated by our planet and moved around in bulk.

Perhaps the greatest electrical energy that people produce is that which we string through wires at 50 or 60 Hertz, which must produce the most powerful signal that our civilisation is sending out into space, a noisy beacon that is moving out in all directions uncontrolled and unintended, but regular. It doesn't carry any particular intelligence, and perhaps the same could still be said if it included broadband internet. The Earth is producing electrical energy which dwarfs what we produce.

The Earth is surrounded by a magnetic field. The English scientist William Gilbert concluded in 1600 from experiments with

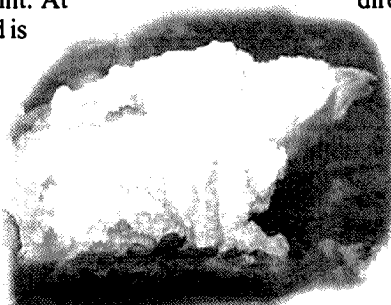

**An average thunderstorm releases about 10,000,000 kilowatt hours**

a spherical lodestone that the Earth is a magnet with its magnetic poles near its geographical poles. In 1838 the physicist Carl Gauss showed that nearly all of the Earth's magnetic field originates in the Earth's interior. It is generally accepted that this is due to the flow of electric currents in the planet's core where the molten metallic material is circulating. Some of the magnetic field is produced by external influence and accounts for the daily small variations in the field strength. Electric currents flowing in the upper atmosphere were suggested by Balfour Stewart, the Scottish physicist.

We now know that even in times when the sun is in a quiet part of its cycle, a solar wind containing charged particles flows out of the sun at speeds of 200 to 300 miles per second. This flow presses against the magnetic field of the Earth until the pressures are in equilibrium. The magnetic field is compressed on the side facing the sun and streams out in a long magnetic tail on the dark side of our planet. This tail tapers out for a distance equal to about 1000 times the diameter of the Earth. Charged particles are quarantined by the magnetic field and

concentrated in the Van Allen radiation belts. Without the magnetic field to protect us, the Earth would be sterilised by solar energy and cosmic rays and would be lifeless.

The magnetic field of the Earth is measured constantly at over 100 locations and its fluctuations recorded. The unit of measurement is the gauss, one definition is the field produced at 1 centimetre from a straight wire in which a 5 ampere current is flowing. The field strength at the poles is about 0.7 gauss. The total force varies by about 0.0005 gauss at the poles in the course of a day. The unit which is 0.00001 of a gauss is called a gamma and is used to describe that daily variation so 50 gammas is the amplitude of polar magnetic field strength variation.

This is occurring within the overall trend of the Earth's magnetism to wax and wane and for the poles to reverse over a cycle averaging about 230,000 years.

What we are going to focus on as scientifically minded radio amateurs is the daily variation. At any point on the surface it will be less than the concentration at the poles and in the region of 10 to 30 gammas. Observations have shown that the

intensity increases around midday in the Southern Hemisphere and is responding to the position of the sun relative to where the observation is being made. Sounding rockets have recorded measurements of the vertical profile of the field as it varies daily. It has been shown that the variation in field intensity is caused by electric currents flowing horizontally in the lower ionosphere, 105 to 130 kilometres in altitude. These currents are strong enough to be measurable when the sun is visible but are not significant during the hours of darkness.

Sounding rockets have recorded constant wind speeds of 50 to 100 metres a second at altitudes of 80 to 300 kilometres. This airflow, carrying along the charged particles present at those altitudes, is moving through the Earth's magnetic field and creating an electric field in the airflow, perpendicular to the direction of motion. An electric current

**3 year warranty now  
on the big 4 — ICOM,  
ALINCO, YAESU and  
KENWOOD**

# Andrews Communications Systems

## ICOM DISCOUNTED

IC-756 Pro III HF+6m	<b>\$4,999</b>
IC-V8000 2m 75W	<b>\$399</b>
IC-746 Pro or IC-7000	<b>\$2,699</b>
IC-706 Mk 2G HF-70cm	<b>\$1,399</b>
IC-718 HF SSB	<b>\$999</b>
IC-910H 2m+70cm SSB	<b>\$2,299</b>
IC-208H 2m+70cm	<b>\$579</b>
IC-2200h 2m 60W	<b>\$399</b>
IC-T90A Triband h/h	<b>\$479</b>
IC-2720H Deluxe D/bander	<b>\$699</b>
IC-P7A New tiny D/bander...	<b>\$389</b>

**\*3 YEAR WARRANTY\***

## ALINCO

### Factory Direct Importer

NEW DR-635T Twinbander	<b>\$699</b>
DR-135T Mk2 2m 50W	<b>\$349</b>
DJ-V5E Dualband handheld	<b>\$499</b>
DJ-X2000E Hi-tech scanner	<b>\$699</b>
DJ-X10E All-mode scanner	<b>\$499</b>

**\*3 YEAR WARRANTY\***

Spectrum Analysers from	<b>\$999</b>
Oscilloscopes from 20MHz to 100MHz	

## ICOM IC-7000 \$2199



### HF-70cm COLOUR TFT DISPLAY

IF DSP, Twin PBT, 508 channel memory + more

## bhi DSP NES10-2

Amazing DSP speaker

Hundreds sold!



**\$249**

## KENWOOD DISCOUNTED

TS-570SG HF+6m+ ATU	<b>\$1,999</b>	TM-271A K 2m mobile	<b>\$379</b>
TS-480HX HF 200W+6m	<b>\$1,999</b>	TM-D700A Dualband Mob	<b>\$899</b>
TS-2000 HF-70cm + ATU	<b>\$2,799</b>	TS-480SAT HF+6m+ ATU	<b>\$1,899</b>
TS-570DG HF + ATU	<b>\$1,699</b>	TM-G707A 2m/70cm mob.	<b>\$499</b>

**\*3 YEAR WARRANTY\***

## YAESU DISCOUNTED

FT-1802M 2m 50W Mob.	<b>\$279</b>	FT-60R Dualband h/h	<b>\$369</b>
FT-7800R Dualband	<b>\$449</b>	FT-817ND HF-70cm Port.	<b>\$999</b>
FT-8900R Quadband	<b>\$799</b>	VX-1R H/held 2 batts	<b>\$249</b>
FT-8800R Dualband	<b>\$699</b>	VX-2R Tiny Dualband	<b>\$319</b>
FT-897D HF-70cm	<b>\$1,399</b>	VX-170 2m H/held	<b>\$269</b>
FT-857D HF-70cm	<b>\$1,299</b>	VX-6R Dual H/H	<b>\$469</b>
FT-2800M 2m 65W	<b>\$299</b>	VX-7R Deluxe H/H	<b>\$549</b>

**\*YAESU ROTATORS DISCOUNTED\***

**\*3 YEAR WARRANTY\***

**Australia's Biggest Amateur Radio Stockist**

## HF VERTICAL ANTENNA SALE

DIAMOND CP-6, 80m-6m	<b>\$399!</b>
COMET CHA-250B B/band	<b>\$599</b>
CUSHCRAFT R8 40m-10m	<b>\$899!</b>
MALDOL HVU-8, 80m-2m...	<b>\$499!</b>
HY-GAIN DX-88, 80m-10m...	<b>\$799!</b>
THP, LDG, MFJ, ALINCO, ICOM, YAESU Automatic antenna tuners in stock TEV-EMTRON HF Antennas in stock AVAIR POWER METERS, T LEADS, ETC. MFJ Antennas, Tuners, Analysers, etc. ANDREWS AMPS...160m-10m 500W+ w/protect. \$999, 2m 120W \$329, 200W \$449, 300W \$999. ANDREWS YAESU, PALOMAR, TE SYS- TEMS, AMERITRON, ICOM linears	

## ANDREWS AMATEUR BASE ANTENNAS

BF-2M2 Fibreglass 2m 6.7dB	<b>\$99</b>
BF-2M3 Fibreglass 2m 7.8dB	<b>\$129</b>
UVS-200 Fibreglass 6dB/8dB	<b>\$149</b>
UVS-300 F/glass 8.3dB/11.7dB	<b>\$199</b>
CBS18 Fibreglass 5.7dB 10m	<b>\$179</b>
Discones from \$129, Coax switch \$29	

We export worldwide.

We also hold some stock in New Zealand!

**CALL (02) 9636-9060 or (02) 9688-4301 or FAX (02) 9688-1995**

Shop 8, 41 Bathurst St., Greystanes, NSW 2145

**MAIL ORDER to PO Box 240 PENDLE HILL NSW, 2145**

<http://www.andrewscom.com.au>

email: [lee.andrews1@bigpond.com](mailto:lee.andrews1@bigpond.com)

**WHY PAY MORE?**

Some items indnt.  
Prices subject to change without notice.  
Limited stock some items E&OE 4/06

will flow through the air that is conductive due to the presence of the charged particles. The electric field produces in turn a magnetic field; this is known as the ionospheric dynamo.

The wind moving in the ionosphere is caused mostly by the sun's tidal influence so its speed is much the same day and night. What varies is the conductivity of the ionosphere which, being much lower in the local night time, reduces the ability of electrical current to flow within it and so most of the daily variation of the Earth's magnetic field takes place in the day time.

The Moon's gravity also produces tidal flows in the ionosphere, as it does in the oceans and in the Earth's crust, which itself rises and falls about half a metre twice a day. Just as the sun powers the ionospheric dynamo, so does the Moon. Observations have confirmed this. There is a lunar tidal electric current system in the ionosphere caused by the lunar tidal influence. Since the electrical conductivity of the ionosphere needs to

be sufficiently high for electrical current to flow, the Moon's ability to pump up a flow of electricity will be significant only where the Moon is in the sunlit hemisphere. The sun has primed the ionosphere to be sufficiently conductive and the Moon's gravity will contribute its own influence to tidal ionospheric flow and hence current flow and an increase in the Earth's magnetic field. The power involved is much less than that achieved by the Sun but does contribute about 1 to 2 gammas to the Earth's magnetic field.

The reflectivity of the ionosphere is exploited for long range radio communication at high frequencies and that reflectivity is maximised when solar ultraviolet radiation is most intense and produces greatest ionisation, allowing electrical currents to flow when the tidal influence is producing them. The main tidal influence is the Sun but the Moon is also influential.

It can be concluded that the reflectivity of the ionosphere at high radio frequencies will be most enhanced when the Moon is

nearest to the Sun from the point of view of the observer on the Earth. At that conjunction the Moon's tidal influence on the ionosphere will be additional to that of the Sun and the ionospheric wind, caused mostly by the tidal force of the Sun, will be increased by the addition of the Moon's tidal force. Where the Sun and the Moon are closest together in the sky their forces will be cumulative.

From the perspective of the amateur on Earth, when the Sun is in a given position so that propagation at high frequencies to a certain location is occurring, that propagation will be enhanced when the Moon is closest in the sky to the Sun and lessened when it is not.

The relative increment provided to the Earth's magnetic field by the Moon is of the order of 1 gamma compared to 30 gammas contributed by the Sun. If this translates directly to the quality of high frequency radio reflectivity, and it seems that it should, then propagation should be about one-thirtieth better when the Moon is, so to speak, on our side.

SEE US AT THE  
GGREC HAMFEST  
22nd of July 2006

Visit us at  
[www.gccomm.com.au](http://www.gccomm.com.au)  
for new product updates!

# G&C COMMUNICATIONS

Authorised dealer for • Icom • YAESU • Kenwood • Barrett RFDS • GME Electrophone • Uniden

See us for CAR Stereo too! ~ 'Cranbourne Car Sound'

## ICOM (Australia) TRANSCEIVERS

IC-756 Prof III HF + 6M	\$4,999
IC-7400 HF +6M +2M	\$2,699
IC-7000 NEW! HF~70cm Mob	\$2,199
IC-706MKIIG HF~70 A/Mod	\$1,399
IC-718 HF SSB	\$999
IC-910H 2M/70cm Multimode	\$2,499
IC-2720H 2M + 70cm D/Band	\$699
IC-208H 2M + 70cm D/Band	\$579
IC-2200H 2M H/Power 'NEW'	\$449
IC-T90A Tri-Band H/Held	\$449
IC-V82 2M @7W H/Held	\$349
IC-P7A New Mini D/band	\$395

2 YEAR ICOM (Aust.) Warranty!

★ Full Product Range Available! ★

Full range of Communications/Scanner Receivers available from Icom, Uniden, Yaesu \$ POA

### HF Vertical Base Antennas

Comet CHA-250Bx 2.8~57MHz	\$699
Diamond BB7V 2~30MHz	\$499

## Antenna Tuners



MFJ-902	MFJ-902H
MFJ-904H	MFJ-945E
MFJ-949E	MFJ-929

## More Details on Website



### Antenna Rotators G450A (shown)

G-2800DXC
G-1000DXC
G-800DXA
G-650C
G-450C
G-5500
G-550

### TE series EMTRON HF ANTENNAS

Australia wide orders welcome  
Credit card Cheque Money order

## YAESU Transceivers

FTDX-9000DA Elite HF Base	\$16,499
FT-897D HF - 70cm	\$1,399
FT-857D HF - 70cm	\$1,299
FT-817ND HF - 70cm	\$1,049
FT-8900R Quadband	\$799
FT-8800R Dualband	\$699
FT-7800R Dualband	\$449
FT-1802M 2m 50W	\$289
FT-60R Dualband H/H	\$369
VX1R w/2 batt Dualband	\$249
VX2R 2/70 H/Held	\$329
VX-6R 2/70 H/Held	\$469
VX-7R Tri-Band H/Held	\$599
VX-170 2M Rugged H/Held	\$279
VR-5000 Receiver	\$1,199
VR-500 H/H Receiver	\$499
VR-120D H/H Receiver	\$279

3 YEAR AUSTRALIAN WARRANTY

Call in and see our range of power supplies, cables and connectors

**Comet & Diamond**  
Antennas & Accessories

Proudly Supporting  
Australian Business

207 High St. Cranbourne VIC 3977  
Ph: 03 5996 3298 Fax: 03 5995 0184

Email: [gccomm@bigpond.net.au](mailto:gccomm@bigpond.net.au)  
[www.gccomm.com.au](http://www.gccomm.com.au)

# Hamshack – a software collection to please all radio amateurs

Morrison Hoyle VK3BCY  
email mhoyle@aanet.com.au

Hamshack is a comprehensive collection of software for radio amateurs, in addition to many programs for general purposes, provided as a "live CD" which can be used on almost any PC without affecting the hard disk and existing systems.

Table 1 lists most of the amateur radio programs and Table 2 the others that almost everyone might wish to use. All these programs are absolutely free, are not shareware, demo or time-limited and are covered by the GNU General Public Licence, which is displayed on the opening screen. Descriptions can be found at <http://hamshack-hack.sourceforge.net/pgmnotes.html>

Figure 1 is a screenshot of the desktop that you might see when starting Hamshack – a little overwhelming in my case although I do really need 15 partitions on my two hard disks. As everything is accessible from the menus, the icons can be deleted according to taste. The icons on the right hand side show most of the amateur radio programs, but clicking on

the K symbol on the lower left corner opens menus to access the huge range of other programs for word processing, email, web browsing, and spreadsheets, etc.

Figure 2 is another screenshot showing the use of qtel, a Linux based program like Echolink, ibp to monitor the International Beacon project signals, and gsmc, a graphic tool for Smith Chart calculations. Just three examples of amateur radio programs included in the package.

Hamshack is a special purpose development of Knoppix (reference 1)

which is a Linux-based distribution also provided as a "Live CD". This means that the user must set the BIOS on the PC to boot first from the CD-ROM or DVD drive (many PCs are set up to do this normally but it is easy to change if your PC looks first for a bootable

Harv's Hamshack is an excellent and trouble-free way of discovering how easy it can be to use Linux ...

floppy disk and then the hard disk). With the Hamshack CD-ROM in the tray when the PC boots up, a ramdisk is automatically created, the Linux is loaded and all the programs become available for use. The hard disk is not affected and the user's normal operating system is not used. For those who later find Hamshack an invaluable tool, it is not difficult to install it to a partition on the user's hard disk or perhaps to a second hard disk. Hamshack includes the tools to create a new partition if necessary and format it for Linux. This procedure creates a boot-up menu allowing the user to select Hamshack or the other operating system.

Used as a Live CD, a disadvantage of Hamshack is that shutting down the PC means that you lose any special settings, email addresses and the like that you may have created. A way to overcome this is to create a "persistent directory" in a suitable device - a USB flash memory stick is ideal. A file called harvsnote.html on the CD-ROM explains how to do this as well as providing guidance on many things beyond the scope of this article.

Hamshack currently has about 1,900 MB of software even though the CD-ROM is only 627 MB. As the user selects

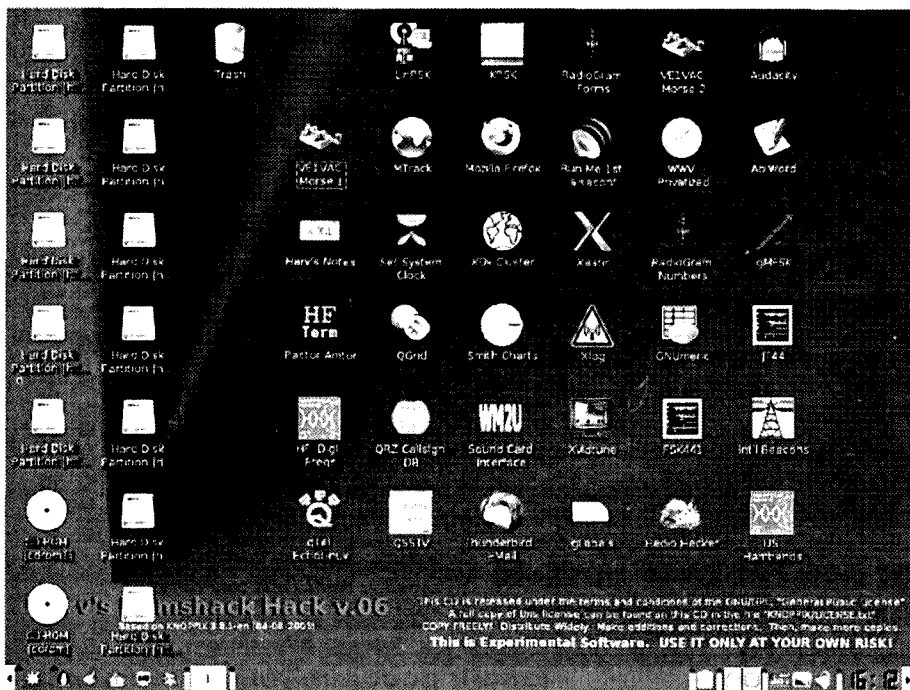

Figure 1 - The Hamshack opening screen



**Table 1 Harv's Hamshack Hack v.05 - Ham Radio Programs**  
 For descriptions of these programs see <http://hamshack-hack.sourceforge.net/pgmnotes.html>

Program Name	Remarks/Description
acfax	Receive faxes using your radio and sound card
aprsd	Internet Gateway for the Automatic Position Reporting System
aprsdigi	Digipeater for APRS
ax25-apps	AX25 ham radio applications
ax25spyd	AX.25 traffic analyzer, dumper and spy daemon
ax25-tools	AX-25 tool for configuring ports using AX.25 Net/ROM or ROSE
ax25-xtools	X versions for configuring ports using AX.25 Net/ROM or ROSE
baycomepp	Drivers for the HB9JNX packet radio epp mode
baycomusb	Drivers for the HB9JNX packet radio usb mode
cw	Command-line frontend to unixcw
cwdaemon	Morse daemon for the parallel or serial port
fbf	F6FBB Packet radio mailbox and utilities
gcb	Utility to calculate long and short path to a location
glabls	Label and business card creation program for GNOME
glfer	Program for reception and transmission of QRSS/DFCW signals
gmfsk	Multi-mode terminal for HF/amateur radio
gpsdrive	Car navigation system
gpsman	A GPS manager
gpsmanship	A Tcl interface to shapelib and GPS
gpsk31	A gtk based psk31
gsmc	Smith Chart calculator
hamfax	Rcv/xmit radio fax transmissions with Soundcard
hamlib-utils	Utilities to support the hamlib radio control library
hamlib3	Run-time library to control radio transceivers and receivers
hf	AMTOR and Pactor protocol using a soundcard as a modem
ibp	Int'l Beacon Project. Maps, bearings, xmit freqs and skeds
klog	KDE ham radio logging program
kpsk	PSK31 transmission mode Terminal for KDE3
libax25	ax25 library for hamradio applications
linkt	Packet Radio Terminal for KDE3
linpsk	Program for operating PSK31/RTTY modes with X GUI
linwsjt	Weak Signal modes for DX work on VHF/UHF and Microwave
monkt	Packet Radio channel traffic viewer for KDE3 (Hack v.05)
monktd	AX.25 channel traffic dump daemon (Hack v.05)
pileup	Morse code pileup trainer for SB compatible soundcards
multimon	Linux Radio Transmission Decoder
qgrid	Qt-based Maidenhead grid squares calculator
qsstv	Qt-based slow-scan TV and fax
qtel	SM0SVX Echolink for Linux
soundmodem	Sound Card Amateur Packet Radio Modems
xastir	X Amateur Station Tracking and Information Reporting
xcall	Packet radio program for X/GTK
xdx	DX-cluster tcp/ip client for amateur radio
xlog	GTK+ Logging program for Hamradio Operators

# Amateur Radio Bookshop

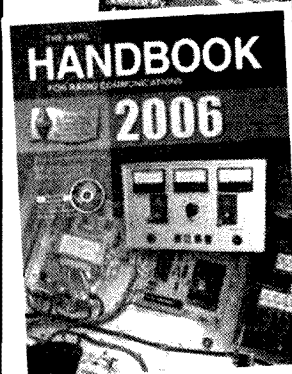
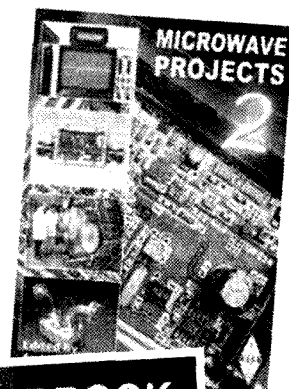

Download our catalogue at  
<http://www.wia.org.au>

Amateur Radio Bookshop  
 PO BOX 3084  
 EAST BLAXLAND  
 NSW 2774  
 Office: WIA National Office  
 Tel 03 9528-5962  
 Fax 03 9523-8191  
[bookshop@wia.org.au](mailto:bookshop@wia.org.au)

**ARRL - RSGB**  
**publications**  
**books**  
**magazines**  
**CDROMs - DVDs**

a program to be used, it is uncompressed from the CD-ROM and loaded into RAM where it can be used just as if it had been installed on the hard disk. This slows responses down a little but this is hardly noticeable even with a modest CPU. The system works quite well with only 128 MB of RAM but twice that is recommended.

Users who have an Ethernet linked broadband Internet connection will notice that Hamshack will find it and automatically configure it so that the Internet is immediately available for use. Hamshack automatically finds the peripheral devices of the computer and configures them without any driver disks. Almost all printers can be set up without drivers. External modems are no problem either but some internal modems can be problematic if they are the cut down "Winmodem" type made cheaper by using Windows to do some of the work that a standalone device does. Hamshack automatically adjusts the time on the desktop by connecting to a NTP timeserver on boot-up but this can be disabled.

Prospective users might like to explore the Hamshack homepage (see above) and explore what Harv calls the "Picky-Klicky Menu"

For amateurs who know no other operating system but Windows, Harv's Hamshack is an excellent and trouble-free way of discovering how easy it can be to use Linux instead. There is very little that cannot be done just as easily with Linux; it certainly is cheaper as it is virtually a no-cost system, it is incredibly robust and is immune to the viruses, Trojans and worms that cause havoc to many Windows users. The BSOD (blue screen of death) is history when you use Linux!

Hamshack has been created by Harv AI9NL and is a free 627 MB download from <http://hamshack-hack.sourceforge.net>. For those without broadband Internet, the writer is willing to provide a CD-ROM of Hamshack for the cost of materials, packing and postage. Contact by email is preferred.

**Reference**

1. Klaus Knopper's website is <http://www.knoppix.net>

ar

Figure 2 (at right) Using three popular amateur programs

**Table 2 Programs (just a few of them) for everyone**

Editors/Word Proc'rs	Description
AbiWord	A light weight but full featured Word Processor
KWrite	A text editor
Kate	An advanced text editor
Xedit	A simpler text editor
<b>Graphics</b>	
KFax	A fax viewer
Kghostview	PostScript and PDF viewer
KPaint	Paint program
Kview	Image viewer
Kuickshow	Image viewer
qccam	Digital Cameras
qtkam	Digital Cameras
Klconedit	Icon editor
KSnapshot	Screen capture program
ImageMagic	Image viewer
XPDF	PDF viewer
<b>Internet</b>	
ADSL/PPPoE	Configure your DSL or Cable modem
KPPP	Dial-up modem/connection tool
Konqueror	Web browser. Doubles as a file manager
Firefox	Full featured web browser from Mozilla.org
Thunderbird	Email client from Mozilla.org
Knode	News group reader
KGet	Download manager
<b>Multimedia</b>	
aumix	An audio Mixer
KMix	An audio mixer
Audacity	Multichannel sound editor
XMMMS	Versatile media player
AleTV	Video player
xawtv	Video player
xine	Media player
<b>Office</b>	
AbiWord	A light weight but full featured Word Processor
GNUmeric	Full featured spreadsheet
KAddress	Address manager
KOrganizer	Plan book/Date book
Kontakt	Personal information manager
qLabels	Label maker

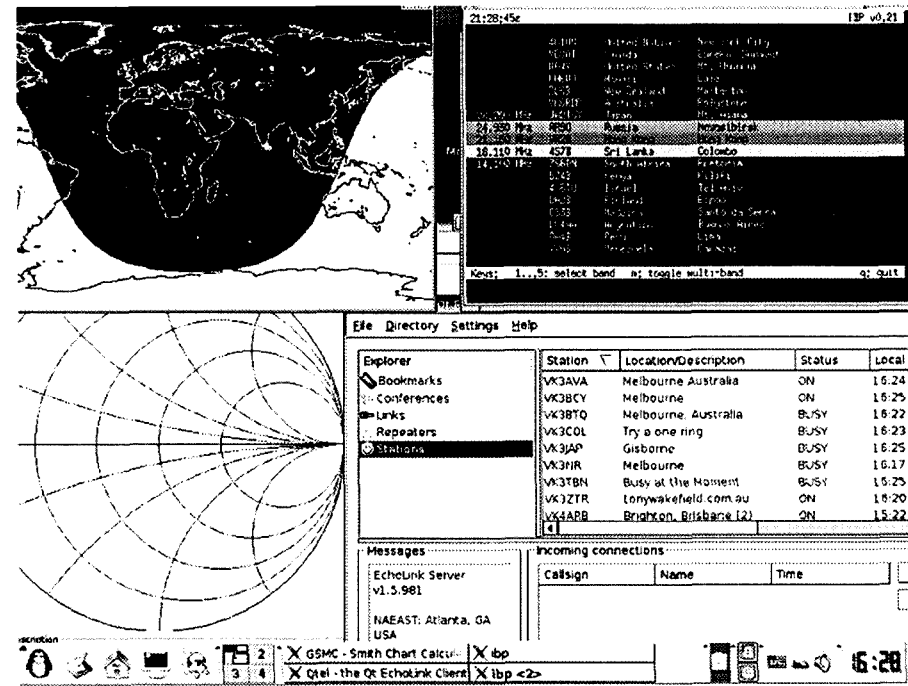

# Three generations of women on the air

## Is this a record?

Brenda Edmonds VK3KT

Brenda VK3KT is proud to announce that with the licensing of her two granddaughters Kim and Nicole, we now have three generations of licensed female amateur operators from the one family.

Brenda was first licensed in 1960. Her two daughters Brenda junior VK3QT and Vicki VK3LT were licensed in the 1970s and now Kim has VK3FHQT and Nicole has VK3FXYL.

In addition, the two grandsons have also attained their F calls; Matthew becoming VK3FMJG and Peter VK3FLIP. Peter is also a third generation amateur from both sides of his family.

Brenda and John became interested in amateur radio from the use of the fire brigade radios in the Wimmera in the 1950s. This was at the time when disposals equipment was becoming available. They were lucky enough to each score a 2 metre "carphone" from an allocation of equipment by the VK3 Division of the WIA. They proved of great use on the farm, with occasional contacts with Melbourne stations.

When they moved to Frankston in 1967, radio use dropped a bit, but in the 70s all four children gained their licences (boys Charles VK3AFV and Alex VK3BQN), and the family featured on the cover of AR in July 1976.

Time passed and the offspring proceeded to tertiary studies, where the girls met up with Paul VK3DIP and John VK3CU,

and participated in a number of Murray River Marathons. At about this time, Paul persuaded his father Phil to gain his licence (VK3CDU).

Brenda (Jr) and Paul produced Kimberly and Peter, Vicki and John produced Matthew and Nicole.



**Nine Family Callsigns:** L-R Paul McMahon VK3DIP, Brenda McMahon VK3QT, Kimberly McMahon VK3FHQT, Peter McMahon VK3FLIP, Brenda Edmonds VK3KT, Matthew Griffin VK3FMJG, Nicole Griffin VK3FXYL, Victoria Griffin VK3LT, John Griffin VK3CU.

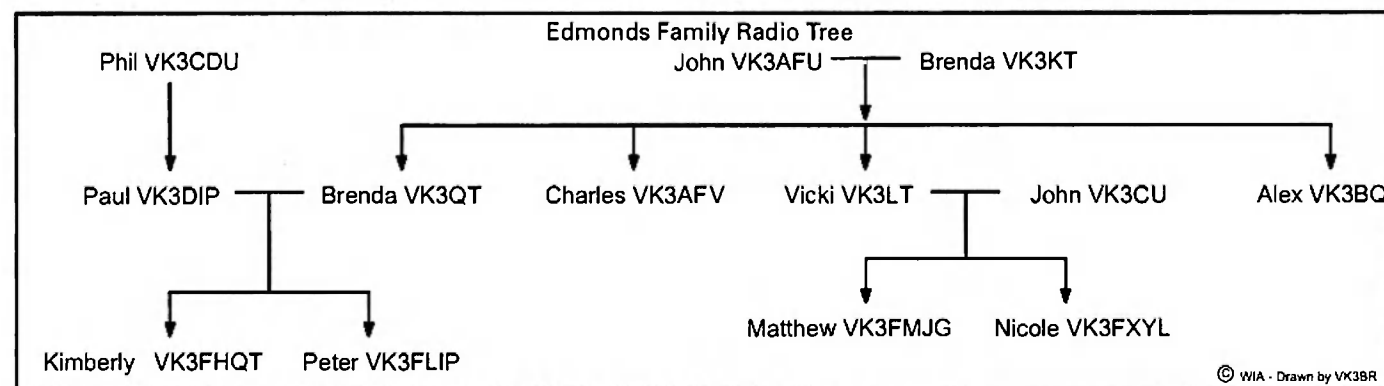

# Benin 2006

## DX-pedition to darkest (the generator went off at ten) Africa

Tom Wylie GM4FDM

After discussions with my friend Flo F5CWU, who had operated from Benin, I decided it would be both possible and viable to carry out an expedition there, my first trip to Africa.

I was joined by Ronald PA3EWP, Andrea IK1PMR and Claudia K2LEO. One problem was that none of us spoke French, and it soon became apparent that this was going to be a disadvantage.

First I trawled the Internet looking for a suitable Hotel. The Au Jardine Helvetia is a Swiss-owned motel on the beach road about 11km west of Cotonou. However, contacting the hotel proved more than a little difficult. The owners Heiner Schmitt and Moronike his African wife are not connected to the telephone network and Heiner only goes to the City twice a week to send and receive e-mails. With the language barrier, negotiations proved very difficult, until by chance, I discovered that Heiner is also TY1HS. Then everything began to fall into place. It was soon agreed that we could erect antennas as we wished. Then we learnt that the Motel was not connected to the electricity grid but relied on its own diesel generators. We were told that power was normally turned off between 10am and 5pm and also 10pm until 7am. We had to agree a price per litre for diesel with Heiner for us to run the generators longer each day, however, his wife insisted that they turn off the generators for 2 hours each day. This proved to be completely at random usually in the middle of a pileup, or sometimes the generator would just stop, and we would have to wait for somebody to turn it back on. We soon learned that everything happens in "African time"!

Antenna erection took longer than expected, mainly due to the high temperatures, at times over 90 degrees. Then in the afternoons and evenings, very high humidity and of course when darkness fell, the mosquitoes came out in force.

We had a Spider beam for 10-20 m including the WARC bands, a quarter wave for 30 m, the same for 40 m and 80 m. We had a minimum of 4 radials on each. We also erected a dipole for 17 m, which was about 40 feet in the palm trees and worked very well.

On day 3 we managed to cobble together enough wire to make an inverted L for 160 m, but whether conditions were very bad or what I don't know, but after calling CQ for 1.5 hours on 160 m we had made zero QSOs. Day 4 we spent some considerable time erecting a simple dipole for 160 m. Having to go into the adjacent forest to suspend one of the legs, I was bitten all over by all kinds of bugs whilst in the bushes. The red ants were extremely large and ferocious, and took exception to being disturbed. Night 5

Andrea went onto top band and first call snagged VE1ZZ and from then on, never looked back. Some nights propagation on 160 m was great and on others nil.

Living at the Au Jardine Helvetia became very easy. We had paid for bed, breakfast and evening meal so really all we had to pay was lunch and drinks. Our main expense was the hire of a third bungalow (low amenity) for a shack. In addition we had to pay for electricity by the hour. Our bill for the two weeks came to 250 Euros (about A\$430).

Heiner offered us a lift into the City on the Friday morning of the first week, which we gladly accepted; I didn't go in the end as I was suffering from Benin belly. I think really the weather was too hot and I followed the advice religiously by drinking 5 litres of water per day – well



The multi-national Benin team.

Left to right Tom GM4FDM, Claudia K2LEO, Andrea IK1PMR and Ronald PA3EWP



Benin location

I guess it had to go somewhere. Even after a few days, I still found physical activity difficult and extremely tiring and the others were commenting on how well I managed to sleep. I did manage a few visits to the beach when the generator was off after lunchtime, but it was at the heat of the day. I put some of the tiredness down to the anti malaria drugs we were taking.

Life soon developed into a routine of eating, sleeping and operating. A quick conference at dinner each evening allowed us to decide strategy for that night and the next morning's work. There was no conflict amongst the Group with everybody mucking in and mutually agreeing band, mode or operator changes. Ronald liked to work the night shift – no arguments there – problem solved. Andrea was our top band magician, which left Claudia and me to work the SSB and RTTY slots. However, looking back on my log, I was just over 50/50 SSB and CW. I think by the second week my CW had improved somewhat.

Taking each band: 160 m we used a simple dipole with the centre about 40 feet falling at each end. Rig was an Elecraft K2 and an ACOM 1000. During the trip Andrea made almost 600 QSOs. They were mainly North America (324) and Europe (248) but disappointingly only 10 with Asia and Africa.

On 80 m we used an Inverted L with a vertical section of 10 m. Sometimes were barefoot with the K2 and sometimes we used the ACOM if it was not on top band. Ronald worked 2,050 QSOs on 80 m with approximately 1000 in North America. Ronald also managed more than 157 JA's.

40 m is a difficult band. I don't know why, but everywhere I go, it always seems to get the least attention. In the end we made 1,282 QSOs on 40 m but again 50%

were North America and again over 100 JA's in the log. Inter station interference was a factor in the usage of 40 m. It was mainly used between 0400 local and daylight at the expense of 80 m.

30m is a great band and after 10 pm, Ws and JA's were very loud and I mean loud. We used a vertical quarter wave with 5 radials and even though all the antennas were grounded in sand, it worked fine. In total we made 1,671 QSOs with 50% in Europe and 20% North America and 30% JA's Again we used the K2 and ACOM when available but some of the time we ran barefoot.

As normal the main bands were 20 m and 17 m. 17 m especially had activity about 20 hours per day. On 20 m the QSO total was 6,256 and on 17 m 6,100.

On 15 m QSO totals were 2,600 on 12 m 200 and on 10 m 150. 15 m was hard work even with the spider beam. Openings were often intense, but short lived. 12 m was even more so and the best opening on 10 m was on the last day when I worked 100 stations in 1 hour.

On RTTY we made a total of 3,200 QSOs in total including about 900 in the BARTG RTTY Test. We really made an effort on RTTY and it's amazing how many people thanked us for a new one. There were a few old favourites in the log, including GM3YTS, G3SJJ, G3XTT and GU0SUP. It was nice to see Phil as I know he just uses low power and wire antennas.

In the main we were satisfied with our QSO count, just short of 24,000. Our target was 20,000. Working in the shack during the day was like working in a Sauna. Even with two fans, it just seemed to circulate the hot air. You drank copious

amounts of water and sweated it out. I should really make a comment on operating standards. It is often easy to criticise. When we went to the Internet Café we downloaded our cluster spots from DX Summit. I have seen comments made before of major expeditions – bad operators, poor operator, deaf etc.

Whilst it is easy to get frustrated at the time, these comments are not helpful to the expedition operators. However, it was pleasing to note that our spots contained no such comments, and there were even a couple of spots for FDM saying "good ears" on CW. Maybe my bumbling CW is slowly improving. Almost all of the comments were good and boosted our spirits.

Having said that, on the air operating practice leaves a lot to be desired. Again our thoughts immediately spring to the European zoo, but when on the DX end, you realise that a lot of the stations calling especially from Italy and Spain, are novice operators, who also have difficulty with the

language. It pays sometimes to speak clearly and slowly. Patience is said to be a virtue. Yes it can be trying at the DX end, but you have to learn to apply it.

In general American standards are better, but not perfect. I guess it depends on how much they really want the DX station. For me, the most trying are the Japanese. Their manners are impeccable and behaviour beyond reproach, but it can often be a most frustrating experience working a Japanese pileup. You struggle to make out a few letters of the call – get one dot wrong – and all you get is total silence. Repeat the few letters you received, including the dot error and still you get silence. They do not respond to anything other than a totally correct call. Thinking you have failed you send QRZ and the whole pileup starts again.

If I have to criticise anything it would be the predominantly southern European practise of using only 2 letters. Sometimes it is the first two letters of the suffix and sometimes the last two. Having to continually backspace is both time consuming and can lead to getting your fingers in a knot thus losing time in the pileups. You should always use your full call. Remember it's not important in the middle of a pileup that I know your name

**In the main we were satisfied with our QSO count, just short of 24,000. Our target was 20,000**

**QSO Percentage by Mode**

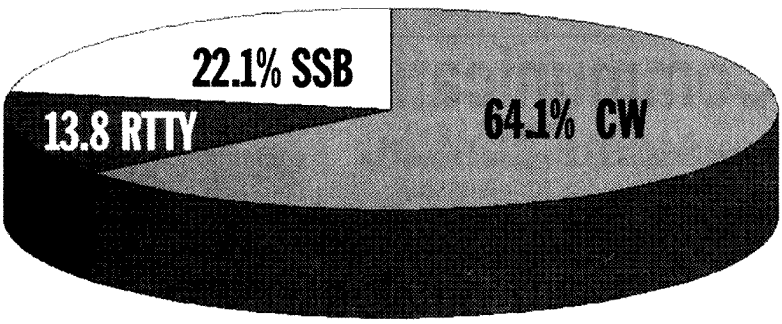



# Build It Yourself Kits

Put more satisfaction into your radio hobby, build some gear for yourself



## Some of the 'Build yourself kits' we offer

**TT 1001 DC to 1 GHz RF Preamp**  
An easily assembled wide band RF preamp. Up to 18.5dB gain at 100 MHz, typical gain at 500 MHz is 17dB. Supply voltage 8 to 14V DC.

### TT 1051 Transmatch Tuning Bridge

Just connect this kit between the receiver and antenna tuner, adjust the tuner for a null on the receiver's frequency. Full instructions included.

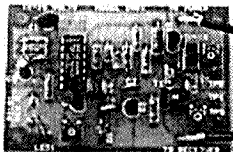

### TT 1054 4 Band Re-Gen SWL Receiver

Easy to build kit covering the 49 meter SWL band, 40 meter ham band, 31 meter SWL band plus 12 to 15MHz. Includes screen printed front panel.



### TT 1056 Single Band Direct Conversion Receiver

This kit is based on the popular NE612 mixer/oscillator IC. The kit is supplied with tuning components that allows the receiver to be built on any of the HF ham bands from 160 through 10 meters.

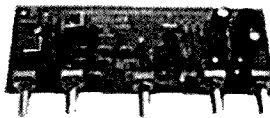

### TT 1253 9 Band Re-Gen Receiver

This kit is a good performer featuring push button band selection. Covers 1.8 to 22MHz.

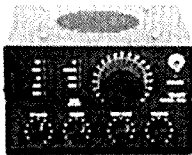

### Who can build a kit?

Essentially anyone. Basic soldering, use of hand tools, the ability to recognize components and follow instructions are important. Several of the kits are assembled in phases with progress tests on each phase before proceeding to the next.

No complex test equipment is needed for these kits, generally a multimeter is all that's required. Check our web site for more kits.

### TT 1254 Double Conversion Receiver Kit

A kit for the intermediate constructor!

This kit is a high performance multi-mode HF receiver covering 100KHz to 30MHz. Supplied with a professional grade enclosure.

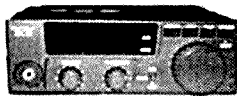

### TT 1210 2M to 10M Transverter

Add 2 meters to your HF transceiver. RF out 10W input 4 to 20W, solid state TR switch. Supplied with a professional grade enclosure.



### TT 13XX QRCW HF Transceivers

These kits are single band CW HF transceivers with an RF power around 3 watts. They are available in the 80, 40, 30, 20 and 15 meter bands. When ordering the 'XX' in the part number is replaced by the band - ie model TT 1380 is an 80 meter kit.



### TT 1064 Smart Squelch

This kit is a clever device that connects between a receiver and external speaker. I works on the principle of integrating audio (not noise) over time and closing a relay when the threshold reached. Ideal for detecting weak band openings.



### TT 1550 Utility Audio Amplifier

An ideal kit where you need an effective and low cost audio amp. 1.5 Watts with a supply voltage of 13.8VDC. Uses the same technology as many of Ten Tec rigs.

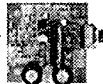

### TT 1203 RF 50 Ohm Dummy Load

A low cost dummy load for HF and up to the 2 meter band. Easy to assemble and capable of absorbing 300W.



## Coming Soon.

### LDG AT-7000

Specifically designed for the ICOM 7000



### LDG AT-200 PC Tuner.

An AT-200 controlled from your PC



We also supply

LDG DTS-4 and LDG DTS-6 Coax Switches

Amidon Iron Powder and Ferrite Coil Forms

AUTEK WM1 Computing Power/VSWR Meter

PC Based Vector Network Analyzer

Ten Tec HF Transceivers

Buddipole Antennas

Professional RF Cables and Connectors

Solar Panels, Regulators and Batteries



# TTS Systems Communications Equipment

[www.ttssystems.com.au](http://www.ttssystems.com.au)

## HF and VHF Transceivers, Autotuners and Kits

Phone 03 5977 4808. Fax 03 5977 4801 [info@ttssystems.com.au](mailto:info@ttssystems.com.au)

**DX in Africa continued**

is Algernon and your QTH is Merton in the marsh and it has been raining for 2 days. Sending this information is superfluous; it is not the same as a normal QSO and interrupts the concentration and the flow. When I come back with a QSL – TU QRZ TY4TW I don't intend to be rude, I just want to service the pileup of the other 200 stations still calling.

I only noticed deliberate QRM a couple of times during the two weeks. Sometimes it was on my TX frequency; sometimes they tried to follow me on my RX frequency. I developed the habit of not just moving 100 or 200 Hz each QSO, but tuning randomly between my listening extremities, and with short calls, was able to maintain a decent rate.

On our last evening, our gracious hosts Moronike and Heiner entertained us with a grand dinner Fondue. Cubes of beef, pork, goat and lamb, along with large shrimps were prepared and we chose and cooked our own in a bubbling basin of peanut oil. This accompanied a large plate of rice, potatoes, vegetables and chips!, all washed down with red wine,

rum and coke and grappa coffee. I don't know how I ever made the last hour and the final QSO. It was a fitting finale that our last QSO was with Carl Smith N4AA, the editor of the DX Magazine. It was also extremely gratifying when I released the PTT for the last time to hear a large number of comments such as "Good job guys" "thanks for a great expedition"

and other such comments. It really made our evening. Why did we have to stop at midnight, simply our licence expired at that time.

I would like to thank our sponsors for the trip and these were – Spiderbeam; BARTG; GDXF; GMDX; RSGB; EUDXF; CMAR; Mediterraneo DX Club; and of course the Chiltern DX Club.

ar

**QSO Count Per Band**

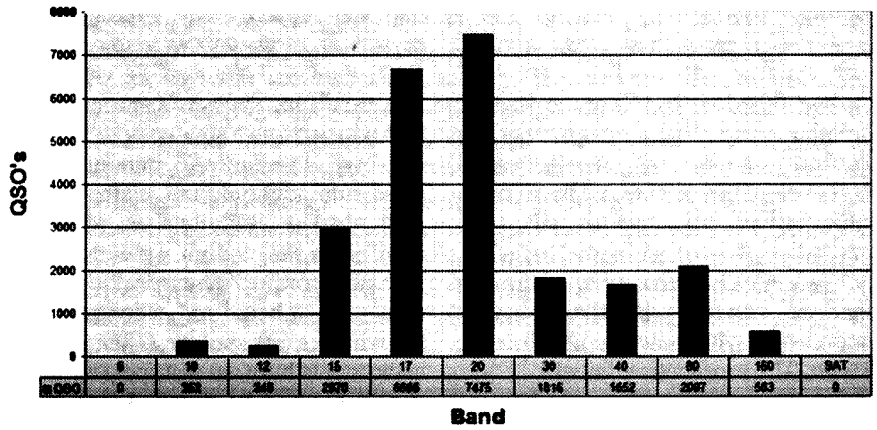

# TET-EMTRON

## Antenna Manufacturers

### New Tet-Emtron Vertical Range Features

- All Aluminium with Stainless steel hardware.
- No adjustment needed to main antenna.
- Light.
- Free standing-no guy wires.
- 1 kW PEP power rating.
- Can be ground mounted or elevated.

The new TET-Emtron Vertical range is designed with ease of use in mind. Tuning is done by the radials when the antenna is in its final position (where possible). The radials can either lay on the ground, be buried or hang from the elevated antenna. The antenna comes with a set of radials that has a resonate radial for each band. Further sets can be ordered from TET-Emtron if desired. See the web site for more info and a complete dealer list.

### New Tet-Emtron Vertical Range

TEV-4    TEV-3    TEV-3Warc

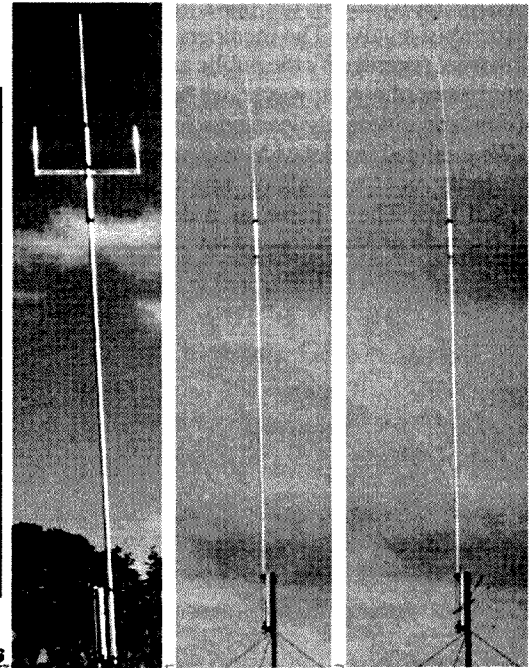

**Specifications**

Antenna	TEV-4	TEV-3	TEV-3 Warc
FREQUENCY	7, 14, 21, 28 MHz	14, 21, 28 MHz	10, 18, 24 MHz
ELEMENT HEIGHT	4090 mm	3800 mm	5025 mm
FEED IMPEDANCE	50 OHM	50 OHM	50 OHM
MAX. RADIAL LENGTH	10.7 Meters	5 Meters	7.5 Meters
SWR	1.5 or less	1.5 or less	1.5 or less

40 Blackburn Street  
STRATFORD  
Victoria 3862 AUSTRALIA

Ph: 61 3 5145 6179  
Fax: 61 3 5145 6821  
ABN: 87404541761

[www.tet-emtron.com](http://www.tet-emtron.com)  
Email: [rawmar@hotmail.net.au](mailto:rawmar@hotmail.net.au)

# An early radio amateur reminisces

Alan Gurr (SK)

Introduction by Rod Green VK3AYQ, (on behalf of the GRES)

The following is a talk given to the Geelong Radio and Electronics Society. It was given by Mr Alan Gurr in September 1971. Alan was one of the early amateur operators. Unfortunately, he passed away many years ago. However, we are fortunate to have a copy of his notes, which are presented here.

Going back to the First World War (1914-1918), restrictions were applied to any experiments in radio, or wireless, as it was then known. After the war the restrictions were lifted. I was aware of one prosecution, a local, born in Australia of German parents was charged by an overzealous official. He had in his possession some coils of wire, bells and buzzers, none of which were even remotely connected with radio. But that does give some idea of what patriotism will come up with. The prosecution failed.

After the war, several people became interested. An advertisement was placed in the Geelong Advertiser for interested people to form a club. About 10 of us met in Geelong West, and the first "Geelong Wireless Club" was formed. We got hold of a dingy room in the city, and adopted a badge representing the plate grid and filament of a valve. The members of this club were regarded by the public as either geniuses or idiots. However, we had a lot of fun, and ultimately learned a lot.

We indulged in a lot of Morse practice. We built receivers, all of which were crystal sets. The coherer, as a detector,

had been replaced during the war by the crystal. These crystals were sold under the fancy names of Neutron, PowerPlus, etc in a small tin. They were complete with cats whisker and a small pair of tweezers. The crystal was most commonly Galena (lead sulphide) held in a clamp with the cats whisker touching it on a sensitive spot. This was found by earthing one side of an ordinary buzzer, the resulting signal being heard in headphones when the whisker was spot on. Often a burst of static would burn out that spot and another would have to be found. Later, crystal detectors were made by placing two different crystals, one zincite, the other bornite, together. They weren't any better signal wise, but were more stable.

We stuck to Galena, principally because some fencing work had been going on around the port area of North Geelong. A wind jammer had come out for a cargo of frozen meat and had dumped its ballast, consisting of lumps of Galena as big as your head. These had been dumped on the site where the fencing work had uncovered it. The sale of crystals with fancy names fell off abruptly.

We would listen intently for the weather report at 9.00 pm and the time signal at midnight. Then go to bed quite happy. Occasionally we would hear a ship, somewhere, croaking away (in Morse) at a message to the Melbourne home station VIM.

Tuning was accomplished by means of tapped coils, loosely coupled. To reach the longer wavelengths used by FL in Paris and 2LO in London, we used great tapped loading coils in series with the aerial lead. This was later, of course, when we were using valves, but it was amazing to think of the immense amount of power those stations must have had to pump into the aerial to cover such distances.

Ross Hull (3JU) found that the secret to getting maximum distance with minimum power was not to increase wavelength, but to decrease it. That is, to raise the frequency. I was with Ross when he first contacted the States with a power of five watts. There was great excitement. I'm happy to see his name perpetuated in radio circles, his contribution to radio knowledge was great.

In an attempt to increase the efficiency of the crystal receivers, we tried many methods to improve the signal we applied to them. We built bigger and, we hoped better aerial systems. We went from the simple single wire inverted L to a two and three wire, single and multiple sausage type. We even erected high metal masts, which were insulated and acted as a vertical aerial. We felt that each was an improvement, but I think a good deal of wishful thinking was involved. However, they looked quite imposing and rather acted as a status symbol.

Transmission at this time was, of course, all in Morse. A coil and spark gap were used with a simple form of tuning inductance. This was generally in the form of a helix with alligator clips to keep the signal somewhere around the desired wavelength. Power was, in



"The Mighty Atom", one of the proprietary crystals that suffered a sales drop when the Geelong locals found an endless supply of free galena.



ship and commercial installations, by DC generator. The spark gap, consisting of a sphere and a plate, was increased to increase range. The more the gap was increased, the more croaky became the signal. Sustained transmission would have the effect of heating up the sphere and plate. So rotary gaps were introduced, which overcame this problem. A metal disc with knobs on it was rotated at high speed in front of two points, thus keeping the gap cool.

Amateur transmission was by the same means and helped by Henry Ford and his "Model T", better known as the "Tin Lizzie". This car had a most unconventional gearbox that was worked by pedals. It was possible to stop in a hurry by putting the car into low gear and reverse at the same time. Believe me, it stopped. The ignition system was also rather peculiar, having four spark coils powered by a dry battery to start, and then by an unconventional AC generator. This consisted of a number of coils spaced outside the flywheel with a number of permanent magnets attached to the flywheel. I mention all this, as the spark coils became very handy for us. Obtainable very cheaply, we used one for our transmitter, and stripped the others for the fine wire and the soft iron core.

The tremblers were not capable of being adjusted to give the nice high pitched note we wanted. So we replaced them with what was known as a "Wepault Break". Where it got its name from I don't know, but it gave us all we wanted.

Then we learned from American sources that valves had been made available and we imported several. The

first valve in Geelong was a Marconi V.24 and was secured by pioneer radio dealer Arthur Bent in West Geelong. It had two filaments, one for now and one for after. The next was one known as the "Dutch R", a forerunner of the present day Philips valve. All the valves first produced were triodes with plate, grid and filament - the filament was the cathode. They were classified as detectors or amplifiers according to the degree of hardness or vacuum. Detectors were "soft" (mine used a maximum of 18 volts on the plate), and amplifiers "hard" (90 to 150 volts).

Coupling between valves was by means of "interval transformers", completely disregarding the fact that valves had an amplification factor of their own. These were usually of a ratio of 3.5 or 5 to 1. Home constructed on a cotton reel and wound with some thousands of turns of fine Ford coil wire by hand. They introduced a fair bit of distortion into the final result. One detector with three stages of audio following it would make you shudder these days.

The valves were powered by first two, and then three, batteries. The "A" battery of 4 volts was used for lighting the filament. Control of this was critical, and we always had a filament rheostat in circuit. The "B" battery was for the plate supply and was obtainable in blocks of dry cells of a total of 45 volts. Wander plugs were used to select the right plate voltage, which was also rather critical. These dry batteries were expensive and did not last long. So we made up rechargeable ones. We cut the tops from Aspro bottles and looped strips of lead from one to another. The bottles were,

of course, filled with battery acid. They were charged by pushing the ends on a length of flex into a light switch. We later extended the life of the batteries by pocketing the lead strips. This was done by belting them with a 'lathers' hatchet, much like a miniature steak tenderiser. The subsequent charging and discharging filled the pockets up with oxide.

Car batteries then were 6 volts and generally failed in one cell first. They had no trade-in value, so we usually had them practically thrown at us. Each 2 volt cell was in an ebonite case and the group of three cells were built into a wooden box. The dud cell provided lead for making solder. The ebonite case, after soaking in baking soda solution to neutralize the acid, provided material for insulating various components. The acid was, of course, used in the B batteries.

Later radio frequency amplification was used to amplify the signal before detection and it was then that a second grid was added to the valve.

Component parts were fast becoming more and more numerous. It was found that tapped coils did not provide fine enough control, so we made variable condensers. Very much the same as those used in present day valve radios, but much larger. The plates were cut from sheet zinc and drilled. Assembly was with 1/8 metal threads and nuts, with the spacing washers made by winding copper wire of suitable gauge on a mandrel, then splitting down the spiral with a fine saw. It was always regarded as a good night's work if one could assemble a condenser, and get it to swing from full in to full out without the plates touching, before midnight. Body

## WANTED- OLD HI-FI

We buy old stereo equipment 1950 - 1980 working or not! Turntables, speakers & amplifiers by QUAD LEAK RADFORD TANNOY KEF LUXMAN ORTOFON LINN NAIM THORENS SPENDOR & more.

Camera Exchange (03) 9808-8811



WE BUY TURNTABLES  
PAYING UP TO \$1000+  
FOR SOME MODELS

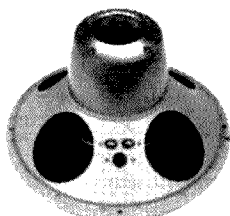

PAYING \$500-\$1000  
FOR 1950s TANNOY  
SPEAKERS

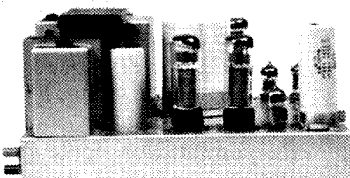
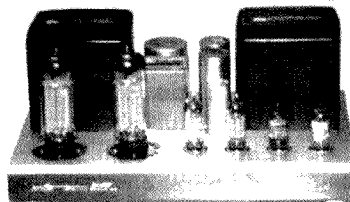

PAYING \$300-\$1000 FOR  
LEAK & QUAD VALVE AMPS

We buy single items  
or whole collections!  
Instant CASH paid.  
We even pickup!  
Radio valves wanted-  
new & used. Call John  
0418-313181

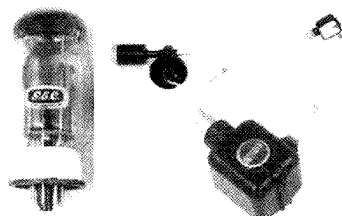

2A3 KT66 KT88 EL34 300B  
ECC33 845 6Z32 45 VALVE  
...WE PAY \$20-\$100 EACH

capacity was a problem. One would tune, remove the hand, and away went the signal. At first we treated the complaint and not the cause. We raided Mum's knitting basket and stuck a long knitting needle horizontally into the knob of the condenser. This, although effective, was a forward. We eventually overcame the problem by better design.

All this went on with very little information available and with very little knowledge of why we tried things. If it worked, we told everyone. If it didn't we tried something else. If it blew up in our faces, as it often did, we just made up more components.

Better times arrived and we could get American magazines. Plenty of information, some unreliable, some speculative, but it was information and we began to get a grip on theory.

Manufacturers climbed on the band wagon. Soon they were producing what they termed "Low Loss" components. Each one claiming to be better than his competitors.

About this time a chap named Newman started radio concerts from Canterbury on Sunday mornings. About the same time 3LO and 3AR started regular programmes. They were the only two official stations in Victoria and this prompted AWA to produce home receivers. Usually of four to five valves, in the form of "Sealed Sets", so that 3LO and 3AR were the only stations receivable. The rapid advent of commercial stations rather mucked up that idea and they died in their infancy.

The PMG (the forerunner of Telstra) always ready to make a fast buck, then introduced listeners' licences. Broadcast, I think, was £1 (\$2) per year, and the Experimenters licence 10 shillings (\$1). To qualify for one of the latter, the hams had to sit for an examination. As the examiners knew little more than we did, passing was easy. Call signs were issued with the licence, first with the initials of the holder prefixed in Victoria by 3, NSW by 2, and so on. When they found they were up against duplication of initials, they just let their heads go.

We had a pretty open go as far as regulations went. We could broadcast music as much as we liked, as long as we threw in appropriate comment now and again. We were monitored fairly well and

we would occasionally lose our licence for being a bad boy. I lost mine for working a ship while it was in port in Geelong. Working the ship was bad enough, but ships' stations were not permitted to be used while in port. The licence was quite easily recovered, though. You only had to go to the PMG in Melbourne, say you were sorry, try to look as though you meant it, and 'Bob was your uncle' until the next time.

Information was coming through in great volume. Circuits were published in various magazines under such names as Neutrodyne, Autodyne, Super-Heterodyne, Flewelling, Browning, Drake and so on. The Flewelling I recall, was a good one, but rather unstable. There was even an article published headed "Flewelling, The Wild Beast of Radio, and How To Tame It".

We got rather tired of building up and pulling down. So we arranged our components, each as a unit on its own baseboard, and fitted with terminals. Then, with a box of short lengths of flex, we could rapidly change from one circuit to another with a minimum of bother. We rarely had the same circuit going for more than two or three nights.

Our fathers were constantly complaining about their mounting electricity accounts. This was due to the fact that we charged our batteries from the DC system in series with a radiator. One of the hams discovered, by accident, that there was current available from the neutral conductor of the supply system. This current did not register on the meter. It was found that this voltage was unstable. It varied from +70 to 80 volts to -70 to 80 volts, due to changes in the way the loading was balanced. This posed problems in charging, and several lost batteries by getting them charged in the wrong polarity. Ultimately, we developed a watchdog to solve this problem. Our battery charging troubles were over.

Then somebody connected a headphone from the neutral of the DC supply to earth. They found that they could hear not only the commutator ripple from the power station generators, but also the trams starting up. All this at loudspeaker level. It also happened that, at the same time, another ham on the other side of town

was doing some Morse practice with what we referred to as the "Stray Juice", or "The Stray". The other guy found that he could hear him. Naturally, after that it was bedlam. We then got together and sorted it out into some system. We issued our own call signs, again using initials, but without the prefix 3. After that we got in some terrific Morse practice. We got up to about 30 wpm, and each seemed to develop a rhythm on the key. This was as individual as a signature and easily recognisable without the call sign.

We connected up permanent headphones, with a condenser in series. This was because we burnt out a few after the voltage rose. We attached a gramophone funnel to the phones. There it quietly hummed away to itself. That was until someone came on the line, either with a message, or just to have a yarn. To keep the voltage to the buzzer more or less constant, we had to insert a rheostat in series with it. My rheostat was wound on a long fibre tube, with a contact on a slider. One day I was playing the slider like a trombone to vary the pitch on the buzzer. I was playing, of all things, "Jesus Loves Me", when it occurred to me to try a carbon microphone in place of the buzzer. The result can be imagined.

We had taken care of Dad's light bill, and now this looked after the telephone account.

It did help with the exchange of ideas. But it upset the switchboard ammeters at the power station. They audibly reproduced the sound of our Morse exchanges. The attendants put this down to leakage from a radio station. When they heard ghostly voices and music, they thought they were going mad.

However, all good things must come to an end. It wasn't too big a price to pay for the change to an alternating current supply. From that change we gained some great advantages, even if we did lose our method of communication.

Battery powered valves arrived, first as "bright emitters", then later with a coated filament which were known as "dull emitters". Then valves with indirectly heated cathodes, with a much longer life. Valves with two to an envelope doing multipurpose functions. Really, an experimenter's dream.

At this stage I chose to get married. With the time and money needed to establish a home, there was not enough of each spare to carry on with radio. So, I'm afraid that there my story must end.

ar

## The Meccano Crystal Radio Receiving Set.

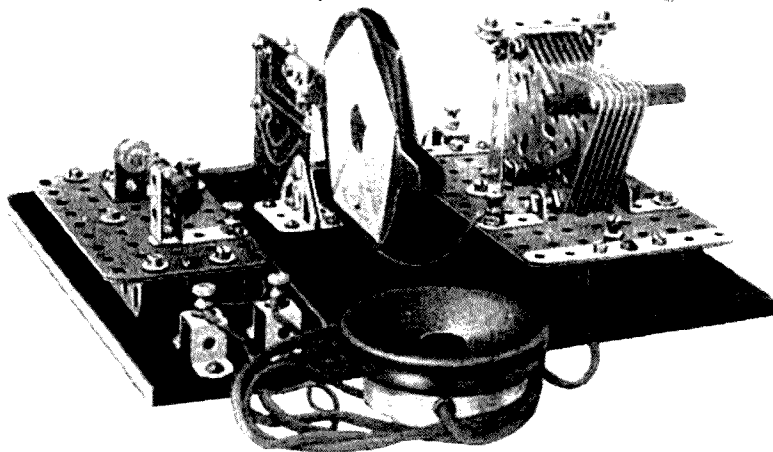

This extract is from an article which appeared in the Meccano Magazine No 25 July-August 1922.

### Meccano and Radio. A WONDERFUL NEW DEVELOPMENT.

Most of our readers are doubtless aware of the tremendous interest now being taken in Wireless Telephony in all progressive countries. America has so far taken the lead in this movement, and in that country high-power installations are established in all important and thickly populated centres, from which are transmitted news bulletins, concerts, stock and weather reports; shipping news, children's bedtime stories, fashion reports, sermons, etc., by Wireless Telephony. These installations are known as Broadcasting Stations, and anyone with a suitable receiving apparatus is privileged to "listen-in," and receive their wondrous and varied messages without restriction or payment.

The subject of radio transmission and reception is in itself a vast and complex science, but the installation of a receiving apparatus of sufficient power to receive messages from broadcasting stations at reasonable distances, is something which any bright intelligent boy can accomplish for himself with little difficulty.

Mr. Frank Hornby, the inventor of Meccano, and the Editor of the "Meccano Magazine" has just returned from a visit to the United States, where they have made a very close study of this subject. With the aid of a receiving set, constructed entirely of Meccano parts, and the addition of telephone ear-pieces, crystal, and one or two inexpensive fittings, they have listened to concerts, speeches, reports, etc., broadcasted from points five to twenty miles distant, with the greatest enjoyment.

The closest attention is being given by us to the development of this wonderful

science, and experiments are being made that we already know will result in any Meccano boy being able to instal his own receiving set made from Meccano parts. Fuller announcements will be made in our September issue. In the meantime we shall be glad to receive queries from our readers on any point connected with Wireless Telephony and Telegraphy, and to reply to them in our next issue. If a reply is desired through the post, a stamped addressed envelope should accompany the query.

Our illustration shows the Meccano Crystal Receiving Set and we wish to draw our readers' special attention to its great simplicity in design and manner of construction. Any intelligent boy can assemble it in one evening. It has been tested thoroughly in London, Paris and New York and in each of these cities clear telephonic and telegraphic messages have been received. In London we have listened to broadcasted concerts from Marconi House. In New York, where the opportunities for testing are much greater than in this country, it has proved to be as efficient as the more costly and elaborate instruments in use there. In Paris we have listened to concerts broadcasted from the Eiffel Tower and have heard them with great clarity.

No scientific instrument ever introduced has been subjected to more thorough tests than the Meccano Radio Receiving Set and if properly adjusted, according to the instructions, it will be found to be highly efficient. It is suitable for receiving telephonic or telegraphic messages on a wave length of 360 metres. Provided that the instrument is installed within a distance of about 25 miles from any of the broadcasting stations, it will be suitable for "listening in" to the concerts, etc., that will be broadcasted in accordance with the arrangements made by the Postmaster General with the Broadcasting Company of which Meccano Limited is a member.

# Rippletech Electronics

## HIGH PASS FILTERS FOR TVI PROBLEMS

Most TVI problems are due to the inability of the TV set to reject strong out-of-band signals - i.e. those from a local HF transmitter. Rippletech High Pass Filters are designed to reject all HF signals, not merely optimised to reject CB. The HPF-50/55 has a cut-off frequency of 50 Mhz and better than 55dB of attenuation on 10m and at least 80dB of attenuation on 80m.



TZ-1840	1:1 1kW 160-10m Batun	\$ 59.00
TZ-330-4	4:1 1kW HF Balun (3 - 30 MHz)	\$ 59.00
TZ-SL8	80m Sloper (use tuner on 17 - 30m)	\$ 99.00
TZ-SL16	160m Sloper (fits a suburban lot!)	\$ 110.00
TZ-D-4080	40m/80m Trapped Wire Dipole	\$ 176.00
TZ-V-3	10/15/20m Trapped Vertical	\$ 189.00
TZ-V-4	10/15/20/40m Trapped Vertical	\$ 289.00
TZ-V-3L	20/30/40m Trapped Vertical (NEW)	\$ 220.00
TZ-V-3w	12/17/30m Trapped Vertical	\$ 199.00
TZ-V-3x	12/17/40m Trapped Vertical	\$ 209.00
	Radial kits (1 radial per band)	\$ 33.00
TZ-RD-3	10/15/20m Trapped Rotary Dipole	\$ 279.00
TZ-RD-3w	12/17/30m Trapped Rotary Dipole	\$ 289.00
TZ-RD-3x	12/17/40m Trapped Rotary Dipole	\$ 309.00
TZ-RD-40	17/40m or 20/40m Rotary Dipole	\$ 289.00
TZ-1000RC	FT-1000mp remote controller	\$ 55.00
HPF-55/5C	High Pass TVI Filter (available now)	\$ 39.00
	Mobile base & Z bracket combo	\$ 11.00

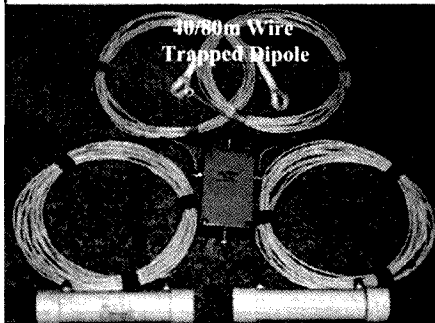

## The Innovator - not the imitator

Our tri-band, quad-band and tri-band WARC verticals have been big sellers for several years now, so good imitations are starting to appear! Compliments abound - check out buyer satisfaction on our ebay sales. We couldn't be more flattered. The verticals are perfect for the ham with limited space, field days, mini expeditions or travellers. With a packed length of only 1m, they fit in your boot or on a plane. Using the same high Q, sealed coaxial traps exhibiting 40 dB of isolation at resonance you get really great performance & ultra wide bandwidth. Even better is the ease of set-up, comprehensive and detailed instruction manual and no compromise construction.

### Need something special?

Make a call and we'll see if we can meet your needs.

[www.rippletech.com.au](http://www.rippletech.com.au)

Contact Tony - VK3TZ B.Eng (comms) MBA

0402 622 562 or 03 9887 4936

email:

[sales@rippletech.com.au](mailto:sales@rippletech.com.au)

Mastercard, Visa and Bankeard accepted

# Let down by battery condition or failure?

**CBA II ensures  
your batteries  
never let you  
down.**



**Computerized  
Battery  
Analyzer**

**CBA II**

**Graph battery voltage &  
capacity.**

**Overlay graphs for  
comparison and testing of  
different chemistries.**

**For lead acid, lithium &  
nickel chemistries.**

**West Mountain  
Radio  
premium radio  
products.**

**02 4982 5481**

**www.fastelectrics.com**

## Over to you

### Aerial analyser improvements

Steve Mahony VK5AIM

With over 250 kits of the VK5JST Antenna Analyser (AA) having been sold and about the same number of PCBs also sold, there must be many more ideas and improvements made to the design. The extension to the frequency coverage to 50 MHz by VK3DPM is excellent. The idea is not new. John VK5NI did it to his AA not long after the first unit was available. John also made the frequency display available as a Frequency Counter.

Now a word of WARNING about the removal of the AA Band Switch to add the 6th position for the 50 MHz.

The switch pins can distort with too much HEAT from unsoldering especially if you, like I did, have wrapped the ends of the inductors around the switch pins. I damaged my switch and had to buy a replacement. You are never too old to learn! Be warned. The best way to remove the switch and inductors is to unsolder the common quickly with not too much heat, or cut the wire and only solder it once more. Then solder suck all the lower ends from their common track. The PCB is of good enough quality and you should not lift off or damage the track with one unsoldering. The other minor problem is

that there is no connection for the lower end of the new 0.33  $\mu\text{H}$  coil close to the 6th position of the switch. The coil does not go to EARTH, but to the bias circuit. The only holes through the PCB to this point are back around the switch by the 100  $\mu\text{H}$  inductor.

I wound my inductor on a small toroid about 8 mm in diameter with 6 turns of #11 enamelled wire. I could measure 0.33  $\mu\text{H}$ . One end was to the 6th contact, the toroid laid on the back of the switch and the other end down the side of the switch through the hole to the track. A dab of hot-melt glue holds the toroid in place. My 6th range now goes from 27 MHz to 62 MHz: excellent.

The other improvements are shown in the photos.

One of the first mods was by Keith VK5OQ to add a 12 V DC input socket, with the switching action of the socket preventing trying to charge the dry cells. This lets you run the AA on a mains power source when you use it in the shack. It saves the batteries for portable operation.

The best mod is the Terminal to Co-Ax

*continued on pag 29*

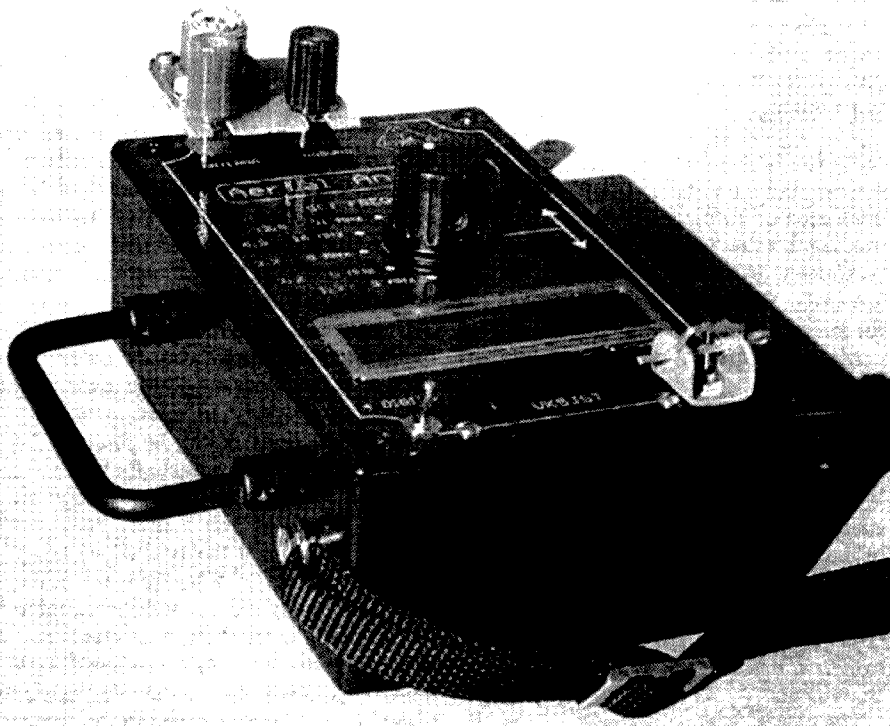

Photo 1

# Handhelds 2m or 70cm



# \$99

delivered in  
**Australia**



## SPECIFICATIONS:

- 1) Voice Prompting on Keypad
- 2) CTCSS with 39 codes
- 3) 99 Storage channels
- 4) Auto scan
- 5) Large screen LCD
- 6) Back Lighting
- 7) VFO programmed (input the frequency you need from the keypad)
- 8) Hi and Low Power selection
- 9) Channel spacing: 5KHz, 10KHz, 12.5KHz, 25KHz
- 10) Keypad lock
- 11) Monitor function (input frequency)
- 12) Low-battery warning
- 13) Frequency Modulation
- 14) Automatic power save mode
- 15) Output power: 4 - 5W
- 16) Large-capacity battery
- 17) Earphone/microphone/auto-charger connections
- 19) Frequency range:
  - a) TG-25AT: 136.000 - 174.000MHz (Covers 2m Band)
  - b) TG-45AT: 400.000 - 470.000MHz (Covers 70cm Band)

(Note: No DTMF but I am working with the factory to produce it) I am in daily contact with the factory and they have assured me they will provide support if required.

## Extras

Extra Battery (1100mah)	\$10
Speaker Microphone	\$11
Car Charger	\$12
(can charge spare battery and handheld at the same time)	
Headset/Microphone	\$8
SMA to BNC Converter	\$5

Geoff White (VK6NX)

## 08 9498 1157

(Please leave a message if unavailable, I'm at home looking after a 1 year old future ham)

116 Amethyst Cres,

Mt Richon, WA 6112

[cityonline@wdsi.com.au](mailto:cityonline@wdsi.com.au)

Payment via Paypal, Cheque or Bank Transfer.

Over 30  
sold/ordered in Western  
Australia in 2 weeks

## Equipment Review

# The Icom IC-7000 HF, VHF, UHF, all mode transceiver

Ron Fisher VK3OM and Eric Buggee VK3AX.

Ron VK3OM and Eric VK3AX give Icom's new IC-7000 a good hard look and find it a worthy successor to the IC-706

### Ron Fisher VK3OM

How time flies. Believe it or not, the Icom IC-706 is now over ten years old. It only seems like yesterday that I wrote my review of the first IC-706. With its removable front panel and full coverage from 160 to 2 metres, it was set to change the concept of compact transceivers. And it certainly did. Over the next ten years it was steadily improved, first with improved transmit audio, then with increased power on two metres, then with optional DSP, and finally with the addition of 430 MHz plus DSP as a standard feature. While all this happened, the price actually came down several hundred dollars.

Over that ten year period, Icom must have sold thousands of them and they are still in production. Mike Harrison, manager of the amateur radio division of Icom Australia, told me that he expects the IC-706 to remain in production for at least another year and, with its several hundred dollar price advantage over the new IC-7000, to remain a strong seller.

### Enter the IC-7000

Over the last ten years, Icom have been at the forefront in developing DSP based radios. Also, displays have gone from black on green to full colour high definition with multiple functions. I guess it stands to reason that the new IC-706 replacement would incorporate all of this. It certainly does, but also with many surprises that I hadn't expected.

Let's have a quick run down on what you will find in the new IC-7000. First, the frequency coverage is as expected - 160 through to 6 metres with 100 watts output. 2 metres runs at 50 watts output and 430 MHz has 35 watts output. This is up a useful 10 watts from the IC-706. All modes are there and these are: SSB, CW, AM, FM (both wide and narrow) and RTTY.



Photo 1 - An IC-706MkIIIG on top of the reviewed IC-7000.

The wide FM is handy for reception of FM broadcasts and to keep up with the sound of your favourite TV shows while out on the road. There was a story around a while ago that the IC-7000 could actually receive TV video. The review transceiver we have certainly won't and I can find nothing in the very complete manual about this facility. (However, modification information is available on the Internet. *Ed.*)

The most outstanding feature of the IC-7000 is the display, now in full colour and your choice of background colour: it can be changed from black to blue, and then from positive to negative. It is also possible to display the screen on your TV receiver by connecting the video-out

socket on the back panel to the video-in socket of your TV set. Icom's advertising even shows it connected to a video display on a car dashboard.

The front panel is of course removable for remote operation and two different length separation cables are available as options. The DC power cable and connector have changed. Just when we were getting used to the six pin DC connector, Icom have decided to change this to a four pin connector and socket. Unfortunately, this meant that I was unable to try the 7000 mobile in the car. I am wired up for a six pin radio as are most of my DC power supplies. I note with interest that an American company already has a four to six pin adapter

available to overcome this problem. I wonder if Icom might make one available. But, more to the point, why did they make this change?

The IC-7000 follows the physical format of the IC-706 very closely. Most dimensions are the same except that the length of the main cabinet is 20 mm shorter and the weight of the IC-7000 is slightly less. But, put the two transceivers together with the power switched off and it's hard to pick the difference. However, turn them on and there is no mistaking the full colour display on the IC-7000.

The front panel layout has also changed from the IC-706. Firstly, the display is slightly smaller, and the two concentric controls to the left have been moved to the extreme left. Both of these changes allow for space on either side of the display to locate eight keys that give dedicated control of commonly used functions. One quick touch turns the function on and off while a longer touch allows adjustment of that function. The band up/down buttons are much bigger and easier to activate and extend right to the edge of the front panel.

If you thought the IC-706 was lacking in memory capability, you should note that the IC-7000 has over five hundred which should keep you busy filling them up. These can be tagged with alphanumeric labels just in case your memory is not as good as the IC-7000 memory.

Perhaps the most impressive aspect of the IC-7000 is the DSP and, in particular, the IF DSP. The IC-7000 has two DSP chips to produce amazing control over the IF selectivity in both receive and transmit. There are no optional filters - they are all built in and easily activated via the menu. There are something like forty selectivity options with different bandwidths selectable for each mode. DSP also controls the twin bandpass filters. This allows the selected selectivity to be narrowed on either side to remove interference. The effect of this is outstanding.

DSP also controls the AGC system and the notch filter that can give up to 70 dB rejection to two signals at the same time.

As with the IC-706, the DSP also provides noise reduction to improve signal-to-noise ratio. This is adjustable in sixteen steps. In addition, the noise blanker is now controlled by DSP with both the level and width adjustable. It was reasonably effective in reducing

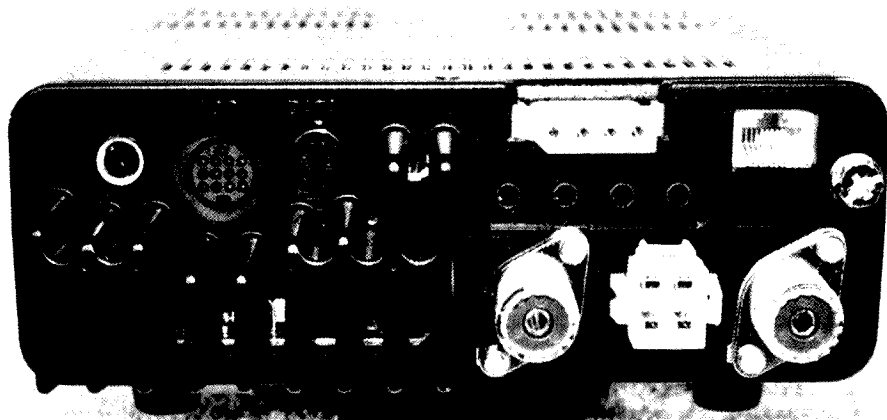

Photo 2 – The rear panel of the IC-7000.

the “woodpecker” signal often heard on 40 and 80 metres in the evening in the eastern states.

Other features controlled by the DSP include a voice recorder that provides four playback memories such as “CQ contest from VK3OM”. There is a total of 90 seconds recording time available for four different announcements. The same system also allows you to record incoming signals with up to a total time of 25 minutes.

Our vision impaired friends will be pleased to hear there is a built-in voice synthesizer that announces operating frequency, mode and signal strength. Also handy for mobile operators to help them keep their eyes on the road.

## The HM-151 microphone

This new microphone from Icom is quite a handful. With 25 buttons it gives control over functions that are not available from the transceiver itself. Fifteen of the buttons give direct access to each of the amateur bands. In addition to this, three band-stacking registers come up with extra pushes of each band button. While the microphone is large, it has a nice feel when handled. The audio quality it produces is another story which I will cover later in this review. If you have a spare IC-706 microphone it will work with the IC-7000 but does not have the control features of the HM-151. The key pad of the

microphone is illuminated in a soft green for night time operation.

## Getting to grips with the menu system

Having owned an IC-706 for a few years I thought the IC-7000 would be easy to master. However, I found it to be quite a challenge.

The two rotary controls to the left of

*Ron VK3OM continues on page 27*



Photo 3 – The back of the HM-151 microphone.

**Tests on Icom IC-7000 transceiver** serial No: 0801172.**Sensitivity tests for: MDS, 10 dB S/N & RF input at S9 "S" Meter indication.***All input levels stated in micro-volts ( $\mu\text{V}$ ) and power level in dBm at the antenna input.*

Band	Pre-Amp in @ 10 dB S/N	Pre-Amp out @ 10 dB S/N	S Meter (for S9 indicated)	
			Pre-Amp in	Pre-Amp out
	$\mu\text{V}$ - dBm	$\mu\text{V}$ - dBm		
160 m	0.162 / -122.8 (MDS: 0.041 / -134.7)	0.531 / -122.5 (MDS: 0.155 / -125.8)	20.1 $\mu\text{V}$ / -80.0 dBm	92.0 $\mu\text{V}$ / -67.7 dBm
80 m	0.155 / -123.2 (MDS: 0.043 / -134.3)	0.437 / -114.2 (MDS: 0.89 / -128.0)	17.9 $\mu\text{V}$ / -61.9 dBm	80.1 $\mu\text{V}$ / -68.9 dBm
40 m	0.156 / -123.1 (MDS: 0.041 / -134.7)	0.434 / -114.2 (MDS: 0.082 / -128.7)	20.1 $\mu\text{V}$ / -81.0 dBm	88.5 $\mu\text{V}$ / -68.1 dBm
30 m	0.148 / -123.6 (MDS: 0.040 / -135.0)	0.395 / -115.1 (MDS: 0.079 / -129.1)	16.8 $\mu\text{V}$ / -82.5 dBm	79.6 $\mu\text{V}$ / -69.0 dBm
20 m	0.148 / -123.6 (MDS: 0.040 / -135.0)	0.386 / -115.3 (MDS: 0.077 / -129.3)	18.0 $\mu\text{V}$ / -81.9 dBm	80.3 $\mu\text{V}$ / -68.9 dBm
17 m	0.144 / -123.8 (MDS: 0.040 / -135.0)	0.380 / -115.4 (MDS: 0.77 / -129.3)	18.0 $\mu\text{V}$ / -81.9 dBm	76.7 $\mu\text{V}$ / -69.3 dBm
15 m	0.160 / -122.9 (MDS: 0.040 / -135.0)	0.426 / -114.4 (MDS: 0.078 / -129.2)	19.9 $\mu\text{V}$ / -81.0 dBm	76.7 $\mu\text{V}$ / -69.3 dBm
12 m	0.159 / -123 (MDS: 0.040 / -135.0)	0.424 / -114.5 (MDS: 0.081 / -128.9)	21.1 $\mu\text{V}$ / -80.5 dBm	86.3 $\mu\text{V}$ / -68.2 dBm
10 m (SSB)	0.094 / -127.6 (MDS: 0.036 / -136.0)	0.270 / -118.4 (MDS: 0.063 / -131.1)	16.1 $\mu\text{V}$ / -82.9 dBm	68.5 $\mu\text{V}$ / -70.3 dBm
10 m (FM)	0.213 / -120.5 (MDS: 0.083 / -128.6)	.572 / -110 dBm (MDS: 0.172 / -122.3)	18.9 $\mu\text{V}$ / -81.5 dBm	79.7 $\mu\text{V}$ / -69.0 dBm

\*AGC threshold: 1.4 to 1.5  $\mu\text{V}$ .

\*Varies as set warms up, as did MDS and sensitivity thresholds, variation approx 1dB.

AM sensitivity: (1.8 MHz) 0.9  $\mu\text{V}$  for 10 dB (s + n):n @. 30% mod depth.

All FM measurements were for 12 dB SINAD.

All SSB measurements were for 10 dB (s + n):n.

2 tone dynamic range (with pre-amp in) varied in the range from 82 dB at 1.8 MHz to 86 dB at 28 MHz.

2 tone dynamic range (with pre-amp out) varied in the range from 84 dB at 1.8 MHz to 88 dB at 28 MHz.

3<sup>rd</sup> order intercept (pre-amp in) varied in the range from -12 at 1.8 MHz to -7 dBm at 28 MHz.3<sup>rd</sup> order intercept (pre-amp out) varied in the range from +3 at 1.8 MHz to +6 at 28 MHz.**Notes**

All tests were conducted with the conditions and test equipment as noted below.

Receiver settings: SSB, 2.4 kHz sharp filter selected. FM: Standard 6 kHz filter. Noise blanker: Off. Noise reduction: Off.

Audio output: at maximum, prior to clipping.

Load: 8 Ohms 2.0 W. 2.3 W at 10% distortion.

Load: 4 Ohms. 2.5 W. 3.2 W at 10% distortion.

DC Voltage Supply: 13.8 V regulated.

Test equipment: Rohde & Schwarz CMT52 and CMT 54;

Radiocommunications test sets;

Bird 43 thru-line wattmeter; Bird 694

HF Termaline wattmeter; Bird 6154 VHF/UHF Termaline wattmeter.

Anritsu MS710E spectrum analyser.

AWAG232 low distortion oscillator; AWA

F242 noise and distortion analyser.

Marconi TF893 audio output power meter.



**Ron Fisher VK3OM's review of IC-7000 continues**

the display also operate as push buttons along with four "F" buttons under the display and the Menu/GRP button at the lower left of the display. A lift-out flow chart for the menu is supplied with the instruction manual and this proved to be very helpful in sorting it all out.

There are literally dozens of combinations that can be brought up on the display. One that I found interesting was the RTTY readout. If you are not already into digital modes, here is a chance to actually look in on it. The IC-7000 has a built in RTTY demodulator and decoder with a six line readout on the display. Unfortunately, however, you will need a computer with an RTTY program to transmit a signal.

**The IC-7000 on the air**

With the menu set-up for SSB, I found the IC-7000 handled in a very similar way to the IC-706. I thought the received audio quality was slightly inferior to the IC-

706 when using the internal speaker, but improved very much when I connected my Icom IC-SP3 external speaker.

The internal speaker should be reasonable for mobile operation but its audio power handling capability appeared to be limited. Transmit bandwidth was set to maximum, 100 Hz to 2.9 kHz as suggested, but reports were not all that good. I even had reports of an echo effect and was asked if I had an audio monitor operating in the background. I tried the IC-706 microphone as a comparison but this appeared to be even worse although, when used with the IC-706, I have always had satisfactory reports. Eric VK3AX will have more to say on this later.

Transmit quality reports on two metres FM were better and, in fact, were comparable to my usual FM transceiver with a high quality desk microphone, so it appears that the IC-7000 microphone is not entirely at fault.

**The IC-7000 instruction manual**

This is actually over twice the size of the IC-706 manual. You will now get the idea how difficult it is to tell the full story of the IC-7000 in five or six pages. The manual takes 20 chapters to tell the whole story: 1. Panel description; 2. Installation and connections; 3. Basic operation; 4. Receive and transmit; 5. Functions for receive; 6. Functions for transmit; 7. Voice recorder functions; 8. Memory operation; 9. Scan operation; 10. Antenna tuner operation; 11. Packet operation; 12. Clock and timers; 13. Set mode; 14. Maintenance; 15. Trouble shooting; 16. Optional units setting; 17. Control commands; 18. Specifications; 19. Options; and 20. Menu guide.

I have to admit that I haven't read the whole book. But, I can say that it is well set out and very readable, with plenty of charts and diagrams to help you through. Overall the book is well written,

**Eric Buggee VK3AX's assessment of IC-7000 continues:**

**VHF/UHF: 50, 144, 440 MHz section tests:**

Band	Pre-Amp in.	Pre-Amp out.	S Meter (for S9 indicated)	
	@ 10 dB S/N. µV - dBm	@ 10 dB S/N. µV - dBm	Pre-Amp in.	Pre-Amp out.
6 m (SSB)	0.049 / -133.9 (MDS: 0.038 / -135.5)	0.115 / -125.8 (MDS: 0.078 / -129)	9.22 µV / -87.7 dBm	32.3 µV / -76.8 dBm
6 m (FM)	0.152 / -123.3 (MDS: 0.060 / -131.4)	0.290 / -117.7 (MDS: 0.127 / -124.9)	8.84 µV / -88.1 dBm	30.3 µV / -77.4 dBm
2 m (SSB)	0.049 / -133.2 (MDS: 0.032 / -136.8)	0.133 / -122.5 (MDS: 0.068 / -130.4)	10.4 µV / -86.7 dBm	40.7 µV / -74.8 dBm
2 m (FM)	0.158 / -123.0 (MDS: 0.058 / -131.7)	0.370 / -115.6 (MDS: 0.128 / -124.9)	9.37 µV / -87.6 dBm	37.3 µV / -75.6 dBm
70 cm (SSB)	0.053 / -132.5 (MDS: 0.032 / -137.0)	0.155 / -123.2 (MDS: 0.169 / -122.4)	5.24 µV / -92.6 dBm	32.3 µV / -76.8 dBm
70 cm (FM)	0.171 / -122.3	0.450 / -113.9	5.12 µV / -92.8 dBm	31.2 µV / -77.1 dBm

VHF/UHF 2 tone dynamic range (pre-amp in) varied from 82 to 80 dB decreasing linearly on each higher band. With pre-amp out, 2 tone dynamic range improved from 83 dB @ 50MHz to 86 dB; at 144 MHz the improvement was from 83 to 85dB; and at 440 MHz the improvement was from 80 dB to 85 dB.

VHF/UHF 3<sup>rd</sup> order intercept (pre amp in) varied from -13 dBm at 50 MHz to -18 dBm at 440 MHz.

VHF/UHF 3<sup>rd</sup> order intercept (pre-amp out) improved to -2 at 50 MHz, -2.5 at 144 MHz, and to -1 dBm at 440 MHz.

All other test conditions as stated for preceding HF section tests were applicable to the VHF/UHF tests.

**Australian made**  
**ANTENNAS**  
*Setting a new standard*  
**COM-AN-TENA**  
 (formerly a j and j coman)

115 John Street  
 GLENROY 3046

- 23 cm 36 ele slot fed yagi beam \$190
- 2 ele delta loop 10/11 metre \$249
- 2 ele quad 10/11 metre \$249
- 10/11 beams comp opt 5 ele \$327
- 10/11 5/8 vert 4 rad 1/4 wave \$185
- Tri band IIB 35 C 10/15/20 m \$745
- 3 ele 20 m comp opt \$460
- log periodic 9 ele 13 30 8.4 boom \$990
- MBV 6-12-15-17-20-40-80 \$390
- 40 m linear loaded 2 ele beam \$595
- M B Vert auto switch 10/80 m \$330
- 6 m 7 ele yagi beam 60 mm boom \$387
- 6 m 5 ele comptr opt beam \$275
- Top loaded 160 m vert \$430
- 10 ele high gain 2 m 3.9 m boom \$149
- 17 ele high gain 70 cm 3m boom \$129
- Rotable dipole 40 m \$250
- 80 m top loaded vertical \$239
- dual band 2 m & 70 vert \$140

**Guyed Masts**

**21 metres                      13 metres**

Wind-up & tilt-over. Aluminium and stainless steel  
 three-sided construction. Auto-brake winches.

**Free Standing Masts**

**9.5 metres**

**New Baluns**

**1-1 to 16-1 to 3kW**



Our Masts  
 meet Australian  
 Standards.  
 We supply all the  
 computations and  
 data you will need for  
 a permit.

**03 9773 3271**  
**Mob: 0419 542 437**

**Ron Fisher VK3OM's review of IC-7000 continues**

well presented and appears to cover all operating aspects in a clear manner.

However, one thing that is missing is any form of technical description. For instance, there is no block diagram. The only hint of technical information is in the

specifications. I am sure that in 155 pages a few pages of technical description could have been fitted in.

ar

**Eric Buggee VK3AX's assessment of IC-7000 continues**

**Power output test results**

2 tone power		Intermodulation products		
Band	Output	Harmonics	3 <sup>rd</sup> order	5 <sup>th</sup> order
160 m	103 W	-61 dB	-28 dB	-39 dB
80 m	103 W	-62 dB	-28 dB	-39 dB
40 m	103 W	-64 dB	-28 dB	-36 dB
30 m	104 W	-72 dB	-31 dB	-36 dB
20 m	102 W	-62 dB	-35 dB	-35 dB
17 m	104 W	-72 dB	-31 dB	-35 dB
15 m	104 W	-67 dB	-29 dB	-35 dB
12 m	102 W	-69 dB	-30 dB	-35 dB
10 m	105 W	-67 dB	-27 dB	-35 dB
50 MHz	97 W	-70 dB	-26 dB	-36 dB
144 MHz	53 W	-61 dB	-27 dB	-48 dB
440 MHz	35 W		-68 dB	-24 dB

**Notes**

Intermodulation products were measured with respect to PEP.

Transmitter audio frequency distortion measured as less than 1%.

Microphone input sensitivity measured to be < 8 mV for full output.

Transmitter FM deviation: 3 kHz.

Carrier suppression measured: >68 dB.

Opposite sideband suppression measured: >70 dB at 1.5 kHz.

Tx/Rx turn-around measured at 13 mSec for SSB; 12 mSec for FM.

All other test conditions as stated for preceding HF section tests were applicable to the VHF/UHF tests.

**Eric VK3AX— General comments from on-air use of IC-7000 at 160 and 80 m**

Comments on audio as received by local operators is that they were in general unimpressed by what they were hearing. Reports ranged from, "sounds like you have a cold!" to "you sound like you are talking down a drainpipe". Others reported that the audio sounded as if there was an echo from the room to an edge that was as though the audio chain in the transmitter were on the verge of tipping over into feedback.

With more time available to play with adjustments to mic gain settings and Tx filter shaping, along with other settings available, this could most have likely been sorted, but I stayed with the factory default settings due to minimal time available on-air with the rig.

On the plus side this is a very easy radio to use. The controls and features are logically arranged and, with the layered menus, are simple and easy to use. If you are familiar with the IC-706 MK2 or 2G then it is intuitive.

The display is an absolute delight to use - every operational feature you need to review is on screen.

The multi-colour display and the resolution are brilliant in every sense of the word. Even those with age-challenged eyesight should have no difficulties due to the excellent resolution offered by the screen.

All round, this rig is a very worthy successor to the IC-706MKIIG.

Top marks to Icom for a value - and feature - packed radio.

ar

## Over to you

### Aerial analyser improvements *continued*

adapter. This is just a piece of PCB with slots for the terminals and a Co-Ax socket of your choice. Be warned that the screw down terminals do not have any metal in them. The only metal connected to the circuitry is the terminal body. I got caught using double sided PCB, with the top side going to the socket body and the under side going to the SO-239 pin. It didn't work! I had to make another one with the underside to make all the connections.

I also fitted 4 little rubber feet to the bottom to stop it sliding around. The other mod is a safety strap. If you are up a ladder measuring an antenna you could drop the AA with disastrous results. My strap and anchors came off an old Cassette Recorder. It has all ready saved my AA from a sudden fall. A simple mod I am trying at the time of writing is a larger diameter knob on the fine tuning pot. I had a 45 mm diameter scrap of black plastic as the result of cutting a hole in a zippy box for a meter. I patiently filed grooves in the edge with a small triangular file. I fastened it to the back of another knob. It appears to work well and makes

fine tuning a lot easier, especially on the higher bands.

I am very pleased with my Aerial Analyser. I have proved some of my antennas OK and others require some adjustment. The 50 MHz addition makes it more valuable piece of test equipment. I should have had one years ago!

A good job done well, Jim.

ar

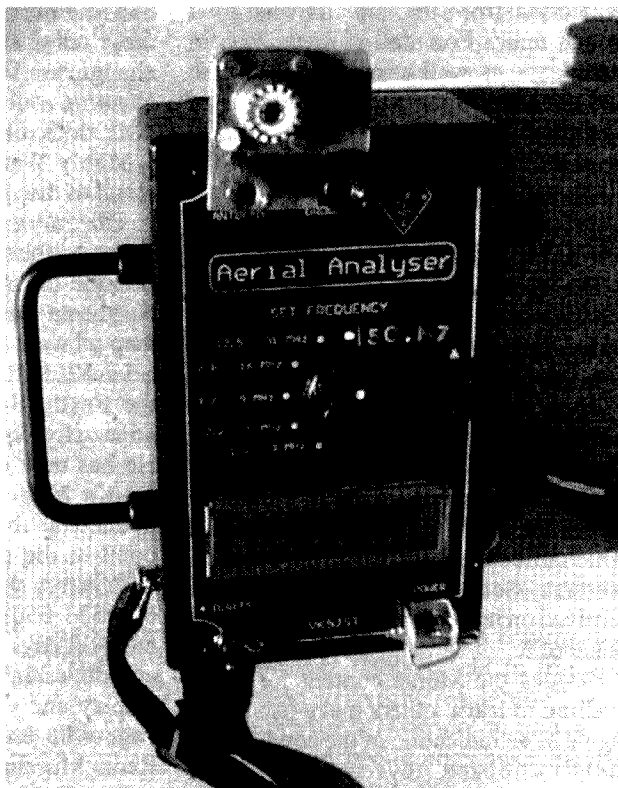

Photo 2

**TWIN CITIES RADIO AND  
ELECTRONICS CLUB Inc.**

**The Riverina  
Field Day Sunday  
20th August 2006**

Held at Murray High School  
Lavington.

10 am - 2 pm

Catering onsite Tea and coffee will be free to everyone  
Full details page 30 this issue  
and in next months AR,

Stall holders see page 30

# OzGear

[www.OzGear.com.au](http://www.OzGear.com.au)

RadioCommunications & Electronics  
Ozhelp Services Pty Ltd T/as Ozgear

Suppliers of radiocommunications,  
electronics and computer products  
and electronic test equipment

**Ph 07 3114 2506**

[sales@ozgear.com.au](mailto:sales@ozgear.com.au)

Brisbane QLD

Manager: Doug Hunter VK4ADC

**WE HAVE MOVED!**

**Unit 2**

**139 Beenleigh Rd  
Acacia Ridge 4110**

*Ozgear yagi antennas  
for 6m, 2m and 70cm  
now available*

**ICOM &  
YAESU**

*Australian-sourced radios with  
Australian-based manufacturer  
warranties*

Authorised Aust Icom and Yaesu dealer

Antenna, cable, interface, tuner and  
general accessory products from...

Amidon, Andrews USA, Austek,  
Benelec, Bushcomm, Comet, Dalwa,  
Diamond, Garland, GeoSensory, GME,  
Icom, Kingray, LDG, Lutron, Mobile  
One, RFI, Sangean SSGC, TET-Emtron,  
Tigertronics, Yaesu, ZCG Scalar plus  
ARRL and RSGB publications

# ALTRONICS

Many products stocked

*Product & pricing info?*

Phone, email or visit us on the web at

**[www.OzGear.com.au](http://www.OzGear.com.au)**

for the latest info plus on-line ordering. Our latest  
price list can be downloaded at any time

Payment?



[www.pca.cc](http://www.pca.cc)  
Email from anywhere  
via **Winlink**  
**2000**  
Use **FACTOR-3**  
on HF to send  
Mail, Grib Weather,  
Weatherfax & Images  
Contact [marc@pca.cc](mailto:marc@pca.cc)  
Sydney 02 8902 0107

## VK2

Tim Mills VK2ZTM

E-mail to vk2wi@ozemail.com.au

### New Hours

AR-NSW, from the temporary office at 8 Melville Street Parramatta, have advised a change in the opening days. Last month it was advised that it would be for two days per week, Thursday and Friday. It has now been decided the better spread would be Tuesday and Friday. The hours are 11 am to 2 pm.

Contact methods remain the same as the previous location. Mail to PO Box 9432, Harris Park 2150. Fax on 02 9633 1525; Telephone 02 9689 2417 and country member free call on 1800 817 644. Do not be put off by a Telstra announcement that the numbers have changed when you ring. It is a transfer to a different exchange. To save any confusion continue to use the old numbers.

### News Compiler

The position of news compiler for VK2WI news has been taken on by Brian VK2TOX, the AR-NSW Councillor with the Publicity role. We thank Brian for stepping into the position and relieving Mark VK2XOF of the task, who had to take on the role following my unavailability earlier this year.

Brian has been contacting the regular clubs and groups about submission methods. News can still be sent via the office, preferably by e-mail to vk2wi@ozemail.com.au. Regardless of the method used, the deadline is noon on Friday. Brian is also looking after the AR-NSW web domain.

### Examinations

The examinations conducted by AR-NSW are being held on the last weekend of the month at the temporary office and bookings should be made through the office. A change in weekend is being considered as it clashes with the bi-monthly T&T at Dural. The transfer of the Trash and Treasure to Dural in May was well attended on a fine autumn day, unlike the November 2005 event, when the drought broke briefly. The Home Brew meeting following the T&T was also well attended. It was conducted by

Peter VK2EMU and Mark VK2XOF with a practical demonstration of constructing a balun - which was then connected to an antenna - that was pruned to the desired operating frequency. The demonstration was conducted in the VK2WI Dural grounds under a canvas sail for a bit of protection from the sun. It was good to see many Foundation Licensees in attendance as well as many others who had not been to the site for many years. The next T&T and Home Brew event will be at the end of this month - Sunday the 30th - at VK2WI.

### 80 metre Morse

The 80 metre Morse transmission from VK2WI on 3699 kHz had additional text added early last month. The stored text was increased from 1100 words to over 2700. It is about 6 hours before the text is repeated. As the text is not an exact length with respect to the various sending speeds, each time it returns to the start it reuses the same text at different speeds which effectively increases the range of the text. Some good reports have been received on its operation and the use being made of it.

Besides the Morse content for those wishing to learn, others make use of the signal as an indication of the condition of the 80 metre band. Any reports, comments or questions should be directed to the Dural Technical Committee via the e-mail vk2wi@ozemail.com.au

### Around the Clubs and Groups.

The Central Coast ARC have advised the 2007 Wyong Field Day will be at the Wyong Racecourse on Sunday the 18th February. They have dropped the Disposal section and will use the space to conduct the Seminars. They held their AGM last month. For details of courses conducted by the CCARC telephone 02 4340 2500, or check www.ccarc.org.au or foundation@ccarc.org.au .

WICEN [NSW] Inc held a training day at the Waverley club in June. The WICEN AGM was also recently held at the Waverley club room. A new WICEN group has been formed in the New England region by Brian VK2WBK. Foundation Licensees have become recent new members of WICEN. Last month these notes advised of a postal address change for WICEN. The Hawkesbury Canoe event will on the weekend of 28/29th October.

Manly Warringah RS have changed email to disc@unwired.com.au .

Illawarra ARS have a new meeting venue on the second Tuesday at 7.30 pm. It is the Industry World Visitors Center, Northcote Street, Conniston. There is a map on www.iars.org.au .

Ian VK2ZIO, who previously operated the Castle Hill Military Museum, has gone to live in the lower Blue Mountains. He has now developed the Kurrajong Radio Museum which was formally opened at the end of May. It is now open to the public on most weekends - but visitors should check by phone first: 02 4573 0601. The museum will open on weekdays by appointment. There is an admission charge. It is an extensive display and you can check out the web page with a Google search 'Kurrajong Radio Museum'.

The Oxley Region ARC conducted their annual Field Day at Port Macquarie over the recent June long weekend.

The Amateur Radio Kandos Group recently logged their 6000th call in to their 40 metre net. They can be found on 7085 kHz at 1600 hours. The Hunter Radio Group in Newcastle conducted their first Foundation examinations last month.

Finally for this month is noting how busy the Waverley club was last month. They hosted Assessor Training, WICEN meetings and training and their own annual Auction. Simon VK2UA provided details about Waverley in notes in the May issue of AR. Check out the details on page 32.

73 - Tim VK2ZTM.

## Westlakes Amateur Radio Club

Westlakes Amateur Radio Club has been in existence for over 40 years and at present boasts well in excess of 200 members within Australia and overseas. Originally formed as a Company, in recent years we became an Incorporated body.

While at present Westlakes ARC enjoys affiliation with several Radio Clubs and Associations there is, in our belief always room for more.

Most clubs are affiliated with either the WIA National body, their State-based successor to the old "WIA Divisions", or both. It is Westlakes' contention however that interaction between these clubs could and should be improved.

As we all enjoy a common interest, that being Amateur Radio, it is the aim of the current committee to seek those like minded Amateur Clubs and Associations within NSW, and indeed Australia, to join us in an exchange of information, and publications and to foster a camaraderie between all clubs as is enjoyed by members within the Westlakes Amateur Radio Club.

For far too long, while we all enjoy the features of our hobby within our own circle of interest, in many cases, Amateur radio enthusiasts have not tapped or explored the many advantages which could be derived from an exchange of ideas and activities with similar amateur organisations.

The objectives of Westlakes Amateur Radio Club are:

- (a) To further the advancement of Amateur Radio and Electronic knowledge and encourage social intercourse between members of the association.
- (b) To provide a venue and teaching facility for the education of young and old in the fields of Amateur Radio, Electronics and related subjects.
- (a) To promote and conduct either alone or jointly with other persons, organisations, associations or clubs, social functions and events, outings, rallies, meetings, conferences, expeditions and to assist community

services in furtherance of the interests of the association and its members.

To this end we urge your club to accept and respond to this request in the spirit in which it is tendered.

Frank Lusa VK2FJL  
President WARC Inc

## Coffs Harbour and District Amateur Radio Club Field Day

Planning ahead? Coffs Harbour and District Amateur Radio Club Field Day will be held on Sunday 21st January 2007. The Field Day will be held at a new and enlarged venue, more space, new displays, commercial traders, special events and competitions and also a number of events for "Foundation Licence" holders.

Further details will be provided in AR closer to the end of the year.

Gary Ryan VK2ZKT  
Vice President and Field Day Coordinator  
Coffs Harbour and District Amateur Radio Club Inc

## VK1

## WICEN operators and CAMS licensing requirements.

**Are you an active WICEN member? Do you go out and assist at Car Rallies? Do you have a valid CAMS Officials Licence?**

If you answered YES to the first two questions, then you need to have a CAMS Officials Licence as from 1st July 2006.

CAMS (Confederation of Australian Motor Sport), the governing body of Australian Motor Sport, has been gradually introducing the requirements for all officials to be formally qualified, and this has finally reached the Rally/Off-road community.

It has been a requirement for other forms of motor sport such as Circuit Racing such as V8s, Touring Cars, Karts, etc, for some years.

WICEN for many years have supported various Car Rallies around Australia, and in many cases this activity has been seen as a means of fund raising. Certainly here in the ACT it forms a very large part of our budget each year. This has been a benefit

to both the Amateur Radio community in getting our "Hobby" out in front of people and to get them interested, and also to the Rally fraternity in providing them with very good communications and competitor tracking services.

**So, what does this licensing mean to you as a WICEN volunteer?**

Well, it is not as onerous as you may think. There are a number of levels of licence available from the basic "Trainee" through to a Level 1 licence that would allow you to run an International event!

Realistically, to just go out in the field and do a Start, Stop or SOS Radio point, you only need a Level 4 accreditation, which is very simple to get. You just need to have had 3 days of Rally "officialing" experience over the last 4 years and complete the CAMS application form. If you don't yet have the required 3 days experience, then you can still apply for a Trainee licence as a temporary measure.

Officials Licences are FREE, just the cost of the stamp to mail the forms in. They last for 2 years and then require renewal, which if you have been active over the 2 years is not a problem.

In the ACT we encourage all our WICEN folk to obtain a level 4 licence for both Rally and Communications (Categories V and O respectively). A few of us are undertaking an upgrade to Level 3, which consists of some on-line courses and a formal assessment, and then onto level 2. This means that we can sign the pass book of other WICEN operators so they can keep their accreditation up to date.

**Want to know more?**

Head to the CAMS website ([www.cams.com.au](http://www.cams.com.au)) and click on the Licensing - Officials link and go from there. You will find out the how's, why's, etc, and also the forms to fill out.

Phil Longworth VK1ZPL,  
State Co-ordinator, WICEN ACT  
Vice President, Canberra Region Amateur Radio Club

## VK3

Jim Linton VK3PC

Website: [www.amateurradio.com.au](http://www.amateurradio.com.au)

Email: [arv@amateurradio.com.au](mailto:arv@amateurradio.com.au)

### New Council Begins

At its first meeting, the Amateur Radio Victoria Council for 2006-09 immediately focussed on the business of forward planning. A number of new initiatives will be announced in coming months.

The council consists of Jim Linton VK3PC (President), Peter Mill VK3APO (Secretary), Ross Pittard VK3FCE (Treasurer), Barry Robinson VK3JBR (Vice President) and Keith Proctor who has the events program portfolio.

Interestingly, four of the councillors are very active accredited assessors and the fifth is an exam invigilator - all involved in amateur licence assessments.

One of the first issues they discussed was how to promote Amateur Radio and in particular the Foundation Licence. It was decided to provide assistance to Amateur Radio Victoria members to introduce the new licence to late primary or secondary schools.

The level of knowledge and comprehension skills required for the new licence make it attainable for youngsters, who are aged 10 years or older, who sufficiently apply themselves to the necessary study.

The key of getting it into schools seems to be to use an 'insider' to convince the school that the Foundation Licence is a worthwhile scholastic or self-development activity.

This can be a teacher, member of the school committee or their spouse - and it helps enormously if they are themselves a radio amateur. Another asset would be to have a student who already has a ham ticket and enjoys the hobby, making him/her an ambassador for it.

And what assistance will ARV provide to support its members? For the rest of this calendar year, up to 10 Foundation Licence Manuals will be provided free directly to a school that commits to have a training course and assessment session.

### F-Troop Launched

What an enormous initial success the F-Troop weekly Sunday net for Foundation Licensees has been, resulting in a welcoming, friendly and helpful on air session.

The idea is to provide Foundation Licensees and other new hams an opportunity to participate in and talk about their new hobby.

The net was proposed by a number of members of Amateur Radio Victoria who are Foundation Licensees. It is held at about 11.40 am straight after the Sunday morning broadcast call-backs, and using the wide coverage Mt Macedon 2 metre repeater VK3RMM.

### Office Upgrade

Much needed and overdue improvements to the computer system in the Ashburton office, including a new printer, have been completed in time for this month's major mail out of two-year membership renewal notices.

New window signage, cleaning, painting and general maintenance work has also been scheduled to improve the conditions for our office volunteers and visiting members and to make the premises more suited for training classes and an operating amateur station.

### Team Victoria Standby

The Remembrance Day Contest next month will be run under revised rules, including the manner in which the overall winning state is decided.

However for Victoria to win in 2006, it basically comes down to many more VK3's going that extra step and actually submitting a log entry.

Amateur Radio Victoria will be doing all it can to encourage both greater participation and the number of logs contributing to the VK3 score.

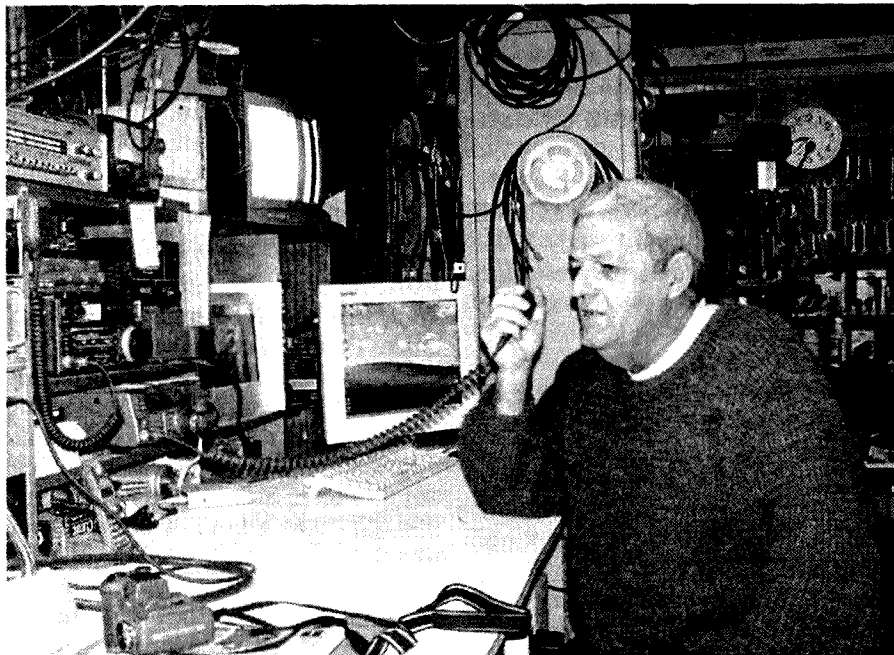

Ross VK3FCE, F-Troop net controller (and Victorian Treasurer) having a pleasant Sunday morning with the Troop.

## VK5

Christine Taylor VK5CTY

### Adelaide Hills Amateur Radio Society

The two topics of the lectures in May was particularly appropriate to many of the nearly 60 members present.

Lyle VK5ZNB spoke about taking good photographs with a digital camera, while John VK5EMI showed us how you can manipulate your pictures through your computer.

Lyle has been a photographer since his teens and has only recently 'converted' to digital photography. He showed us that many of the traditional techniques used by photographers remain important corner stones to produce good images. The right arrangement of your subject and using the correct amount of light and dark within your picture is vitally important.

Digital cameras have made us rather profligate, we just snap, snap, snap away and hope that when we get home at least one of the photos will be useful. We can be more sure of this with a little bit of care.

One useful tip to avoid 'just missing' that important moment is to turn your LCD display off. Turning the display off removes that annoying delay between pressing the button and taking the photo. Perhaps if we turned the display off we would not have so many pictures in which the subject has just moved.

Of course, the better your camera the better your pictures are likely to be, so if you can afford it, buy a digital SLR camera so you can actually see what you are taking!

In John's part of the evening, we were shown how to remove 'that child who ran into the picture' just as you were taking it. Using one of the many photo-management programs, John removed a child from a picture of his wife and a friend in front of a historic train, by cloning. Then he used cutting and pasting to replace the wheel which had disappeared in the cloning process. He was told by his audience that he had forgotten the shadow!! No doubt that omission has now been corrected.

Altogether an entertaining evening with some food for further thought.

AHARS has its meetings on the third Thursday of the month. Contact Jim VK5NB or Leith VK5QH for information.

During a recent weekend an aerial was erected for Ted VK5KBM. Some of the grey heads may be recognisable!

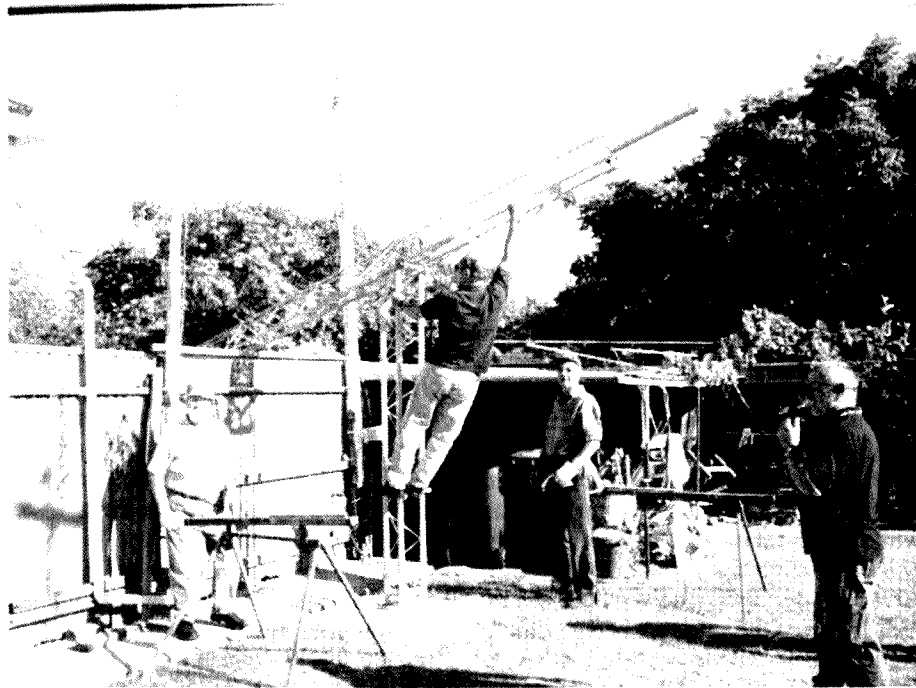

### Fleurieu Peninsula Group Luncheon

A pleasant lunch was enjoyed by the group of 24 who met recently, after which they moved to the QTH of Garry VK5ZK and his XYL, Cecily. Two new couples have been added to the group. One is just about to move to Goolwa permanently, the other has had a shack at Middleton for many years. Welcome additions!

The massed yachts that had filled Lake Alexandrina earlier had mostly disappeared but the view from the VK5ZK QTH was still quite lovely.

As usual the talk was free-flowing and interesting.

Noel VK5VT took his new toy down for inspection and created quite a bit of interest. The transceiver with power supply attached was inspected by most of the OM's either with a view to buying, or just enviously!

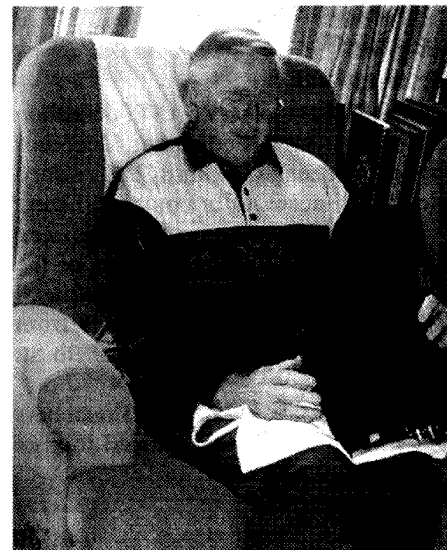

Garry VK5ZK has his hands on the new toy

## VK7

Justin Giles-Clark, VK7TW

Email: vk7tw@wia.org.au Regional Web Site: reast.asn.au

### Central Highlands Amateur Radio Club of Tasmania

A quick reminder that the VK7 Hamfest to be held on Saturday December 2nd, 2006, is hosted by CHARCT. Location is the Miena Community Hall in the Central Highlands. Many suppliers have already shown interest. This was a fantastic event last time so, mark your diary!

### North West Tasmania Amateur Radio Interest Group

By the time you read this, the July 12-16 Marconi Celebrations commemorating the first transmissions across open water in the Southern Hemisphere by the Marconi Company will be very close. In Tasmania, the celebration centres on the Maritime Museum in Devonport. There will be a re-enactment of exchange of messages between dignitaries in Queenscliff and Devonport and the Governors of Victoria and Tasmania will be in attendance. A 20-page brochure, a reproduction of the original by the Marconi Company plus with a historical insert is being printed and will be available for \$5.00 (\$6.50 posted). VI7MC and VI3MC are the special events call signs and QSL cards are being printed. A contact between the International Space Station and the two Devonport High Schools is also planned. An event not to be missed, see you there.

### Radio and Electronics Association of Southern Tasmania Inc.

May 20-21 was another REAST Foundation Licence course. 10 Foundation Licensees passed successfully and 2 Standard Licensees successfully completed their practical assessments, thanks to Reg VK7KK. A reminder that copies of the Foundation Licence Manuals and tutorial CD's are available for purchase from McCann's Model World in Elizabeth St. Hobart at \$20.

May 24 saw about 25 REAST members and friends treated to a guided tour of the Military Museum of Tasmania in Anglesea Barracks. Our two guides were Lt Col. David John (Ret) VK7DJ from the Royal Engineers and Lt Col. Owen Winter (Ret) from the Signal Corp. The museum is in the original Barracks Military

prison and was built in 1846 and each cell has been set up as a different aspect of Tasmanian military history ranging from 1804 to the present day. There is a well presented signals room which houses a replica of "Winnie the War Winner" built by Barry Riseley VK7RS. Thanks to David and Owen for giving us their time.

June 3-4 was the REAST Field Weekend at The Lea Scout Camp. The weekend focussed on portable/mobile operation and the theory and practicalities of this exciting mode of amateur radio. We had some great hands-on knowledge and experience shared about antennas, rigs, rope work, (and getting things stuck in trees, HI HI), we built tape measure Yagis and went searching for foxes. There were some great sessions from Rex VK7MO on Digital DX and Martin VK7GN on contesting and HF DX operation. The national and local broadcasts came from the Field weekend and about 15 people were then given a visual and audio tour of one of the BPL trial areas. Brian VK7BW gave a great session on connectors, coax, crimping, and standard power wiring. Danny, VK7HDM & Scott VK7HSE gave a hands-on talk and a practical demonstration of APRS and we finished up with a session from Roger 7HRW on professional on-air operation. About 30 people enjoyed the weekend including many current and soon-to-be Foundation Licensees.

The ATV Experimenter's group has been meeting weekly in the Domain ATV studio and undertaking some field signal strength tests around Hobart. The group has been playing some public domain archival films from the 1930s & 40s



Peter VK7TPE, David VK7DJ, Gary VK7JGD & Stu VK7NXX



Foundation licensees working on the ARDF tape measure Yagis.

about different aspects of the radio and telephony industry back in the "halcyon days".

ar



Getting up close and personal with BPL!



## Prepare for the contests

Next month should be a busy month for us all. The Remembrance Day Contest is in the middle of the month and the ALARA Contest is at the end. So this month is the time to ensure that your equipment is all ready and working well.

We hope there will be lots of Foundation Licensees involved this year, and hopefully some of the YL Foundation calls will be among them.

The two Contests are different in their arrangements so make a good contrast to each other.

Be sure to check the rules regarding repeat contacts on HF. In the ALARA Contest you may make repeat contacts with the same station as long as there is at least one hour between contacts.

In the Remembrance Day Contest the emphasis is on the largest number of contacts you can make in the 24 hours and you are scoring for your state as well as for yourself. By contrast, in the ALARA Contest the emphasis is on meeting friends and having a chat although, of course, you want to make as large a score

as possible, at the same time but not at the expense of time to chat.

The ALARA Contest runs for 36 hours, rather than 24, so we have a better chance of 'meeting' on 80 metres on two evenings.

Please do have a go in both Contests. Everyone will be helpful and encouraging.

Remembrance Day Contest is on 13th – 14th August and the ALARA Contest is on 27th – 28th August 2006.

## The ALARA Award

Whether you are new to operating, contesting, YL or OM, or new to ALARA, everyone can use the ALARA (and the Remembrance Day) Contest to work toward an ALARA Award.

All you need to do is to ask the YL at the other end of the contact whether she is a member of ALARA to be able to include her in your list.

During the ALARA Contest, in particular, all the YLs make a point of saying whether or not they are members of ALARA, as this makes a difference to the points we can score for each contact.

## ALARA'S birthday

ALARA was founded on 25th July 1975, so each year on the Saturday evening closest to that date we try to have a chat on 80 metres to wish ourselves "Happy Birthday". This year the date will be July 29th. If we come on between 0900 and 1300 UTC, we allow the ZL members and the VK6 members to be able to hear someone – as long as propagation is good.

There have been several nights recently when the band has been almost without noise. Hopefully conditions will favour us than night.

In VK5 and VK6 where there are sufficient members who live comparatively

close to each other, we have Birthday Luncheons on the last Sunday of July. The OM's are invited to these lunches. Sometimes we are at the same table, sometimes at different tables but we get together for coffee, at least. These are always special occasions.

Everyone can apply for this award by making at least ten contacts with members of ALARA with at least five Australian call areas (5 contacts and 4 call areas for DX applicants) among the callsigns.

To apply for the Award you send the log list signed by another amateur who

has sighted it, to Kathy VK3XBA QTHR the callbook, with \$A3 or 4IRCs.

Kathy has only recently taken over the position of Awards Manager, so give her some work to do. The award is a most attractive one, featuring all the floral emblems of the Australian States in colour, so will be worth mounting on your "Brag Board" along with those rare QSL cards.

### OzSpid Rotators

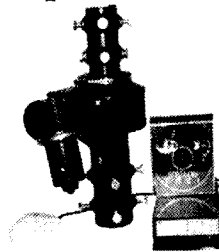

Oceania - New Zealand - Australian Distributors.

Australian Enterprise Industrial  
P.O. Box 1013

Browns Plains. QLD. 4118.

Ph. 0414 254 080.

Fax. 07 3800 8003.

aeitower@spin.net.au

<http://www.spin.net.au/~aeitower>

*continued next page*

# Australian Radio Industries Pty Ltd

The RF Specialists

# Spotlight on SWLing

Robin Harwood VK7RH

## Cold feet

It has been very cold outside and I have been occasionally playing around with the radio with disappointing results. There have been some blackouts and propagation has been very poor, at least here I have found the best results are from the [www.dxtuners.com](http://www.dxtuners.com) website. Most of the remotely controlled receivers are in the Northern Hemisphere and it is exciting to monitor signals from the other end of the World.

The news continues to be grim with more international broadcasters exiting shortwave. The Slovakian Government finally decided to halt shortwave broadcasts so another country is no longer there. YLE in Helsinki, Finland, also decided to abandon shortwave. As well the VOA in Washington DC decided to axe three more language services. These are Hindi, Serbian and surprisingly, Russian. The parent organisation, the IBB, will still be using Radio Liberty in Russian.

The reason given why Hindi was

dropped is because of the rapid growth of private FM services within India. For many decades, the Government in Delhi only permitted All India Radio to broadcast but last year decided to end the monopoly.

Radio New Zealand International commenced broadcasts in the DRM Mode on the 4th of June, mainly for subsequent rebroadcast in the Pacific Region. The DRM signal is clearly heard from 0800 on 7145 and continues to 1259, when it retunes to 6095. John Cartmill in Brisbane informs me that the audio quality is excellent with very few dropouts. It appears that this mode works well on single hop rather than multihop. Dropouts are more noticeable on the latter. Yet DRM receivers are still scarce, although software has been readily available for some time on the Net but the receiver will require a very wide IF about 12.5 kHz.

Have you noticed the prevalence of Chinese broadcasts on shortwave? They seem to be everywhere. Some are

used to jam overseas programming in Chinese. Millions of shortwave receivers have been manufactured in China and these are exported to Africa and Asia at very reasonable rates. CRI in Beijing is following the lead of western broadcasters by placing programming over local FM outlets particularly in East Africa. While FM has become popular particularly in India, there are many countries that still rely on AM signals on medium and high frequencies.

Has anybody heard amateur radio communications on the 60 meter allocation in Europe and North America? There are several fixed channels on USB. I also believe that the power output is around 50 watts PEP. There is a German propagation beacon on 5195 kHz but I have yet to hear it, either here or via the dxtuners site.

Well that is all for this month. If you have any news or comments, please send them to me at [vk7rh@wia.org.au](mailto:vk7rh@wia.org.au).

73 de Robin VK7RH

ar

## ALARA continued

### A special contribution to the Commonwealth Games

Jenny (probably with a callsign by the time this is printed) was a St John volunteer for the Commonwealth Games in Melbourne. She had been a volunteer in Sydney for the Olympic Games and was determined not to miss out on Melbourne.

However, she was away from VK5 for longer than just for the fortnight as she had also put her name down to help St John at the Grand Prix. I understand she has been at every Australian Grand Prix since the first one in Adelaide. I think we could say she is a bit of a 'petrol-head'.

She has actually been a St John volunteer for something like 40 years, as an instructor and as a team leader at many different events all over VK5 and a number of other interstate venues.

As has often been said, "Australia needs all its Volunteers" and no volunteers are as necessary as those YLs and OMs dressed in black. No one notices them till something goes wrong, but we are all grateful they are there.

ar



Jenny inspecting the Victoria Police vehicle at the Commonwealth Games.

## Profile: Joan VK3BJB

**Joan VK3BJB has had a remarkable life in amateur radio. Some of it came about by accident but much of it has happened because of the effort she has put into her hobby.**

Joan certainly took up amateur radio almost by accident. Her OM Ray VK3BRB decided to study for his amateur licence, so Joan helped him to learn and remember. She became so involved that it was suggested that she sit for the exam as well. And that is what happened. Both of them got their full calls back in the 1970s.

Ray's job took him away from home and on the road rather a lot so they decided to keep in touch by radio. To make this easier the radio was set up in the middle of the house so that Joan could hear it as she went about her daily activities.

As for many amateurs who live in the country, radio provided Joan with a link to the world. People living in the cities do not experience the feeling of isolation of those who live in the country, even in larger centres such as Mildura

Joan became intrigued by the stations she heard calling and answered them. She soon developed a number of regular skeds with amateurs around the world, exchanging information and ideas and learning about other countries and people.

One of the earliest regular skeds was with a Sacramento station. This led some years later to an exchange of police badges and other items between the Sacramento amateur and a Mildura police friend of Joan.

However, it was when Joan started to learn Japanese, just for fun, that her life started to change. Even with her limited Japanese she discovered that she could understand some of the Japanese conversations she heard on the radio.

One day she realised that one station was not able to hear another one so she offered some assistance. Then she discovered that some of the Japanese operators were keen to learn some English. She began to teach them some simple sentences in English and in exchange they taught her some Japanese words and expressions she had not heard in class.

One day she joined in a Japanese net

because she realised that they were having difficulties. This grew into a regular thing and as Joan's Japanese improved she was asked more often to act as a relay between stations unable to hear each other.

By this time Joan had realised that many of the stations she was talking to regularly were fishermen. Deep-sea fishermen are often away from home for long periods and one of the services provided by the regular net of which she had become part, was information from and to their families. There are also ocean-going yachts which need to make regular contact: Joan found herself involved with these people, too, when she could hear and others could not.

In the middle of 1988 Joan became the Net controller for the All Japanese Maritime Mobile Net, the first woman ever to undertake this role. Initially it was a temporary thing, as a relief when the regular operator was unable to be there. Very soon it became permanent. By this time, as Joan says, she knew enough Japanese 'to get herself into trouble'. In fact, she knew enough to get others out of trouble!

Living in Mildura, Joan was in the ideal position to form a link between Japan and ships in the southern oceans. Frequently she was the only station able to hear both parts of a contact. She became known as "Mrs Joan" to all the stations.

The fishermen called Joan 'the lighthouse', because she keeps them on track. However, there are sometimes problems. As Joan learned more Japanese she was more often asked to help them understand English.

One station had trouble understanding the word 'immediate' so she explained in Japanese what it meant and suggested that he try using the word in a sentence to see if he understood it now. Kudo made up the sentence, "Engine room flooded, need immediate assistance". A very good sentence. Unfortunately another station heard this part of the exchange without the earlier part, and almost put a rescue



operation into action. He thought Kudo had put out a Mayday call!! Fortunately Joan was on hand to sort it all out.

In 1991 there was a much more serious situation. The yacht "Naruto", being sailed solo from the Solomon Islands to Australia, had an engine failure which also put his satellite navigation equipment out of action. Joan had been talking to him regularly for the past few months as he sailed around the Pacific, so she understood the seriousness of the situation.

When the trouble started, Joan contacted the Maritime Rescue people in Australia but they were unable to locate him until he was sighted by the Coastguard. Joan could assure the Maritime Rescue that the yacht was still afloat so that the search should continue, and, at the same time, to reassure 71 year-old Mr Sakai that help was coming.

By the time the yacht was towed into Cairns Harbour, Mr Sakai had not slept for two nights and had only a cupful of petrol left to power the generator for the radio. Without his radio and Mrs Joan he would probably have perished somewhere in the Pacific.

This was the most dramatic, but not the only, time Joan was able to assist in the rescue of lone yachtsmen.

Mildura people have almost become accustomed to Japanese gentlemen accosting them in the street, asking for

*continued on page 40*

## Six monthly summary of ups and downs

This time we have the benefit of some real live experiences rather than just me regurgitating stuff from Internet sources and my own limited operating. David VK5DG wrote to me with an excellent summary of the situation as of a month or so ago. He is a regular listener and user of the birds. His summary follows.

*AO-16 V/U Digipeater: Still putting out a loud signal after all these years.*

*Telemetry decoded indicates it's still healthy. Only transmitting on 437.025 MHz*

*LO-19 -/U CW beacon Remained healthy during a full sunlight period.*

*Putting out ~1Watt on 437.126 MHz. Telemetry decoded and sent to ground controller*

*FO-29 V/U SSB Some QSOs made. CW beacon on 435.795 OK.*

*Used as demonstration during Foundation licence classes.*

*SO-50 V/U FM Some QSOs made. Normal operation.*

*AO-51 V/U FM Analog Some QSOs made. V/S FM Some QSOs made.*

*VO-52 U/V SSB Heard but my 2m downlink needs attention, no QSOs made.*

*CO-55 -/U CW beacon Telemetry decoded, QSL card received.*

*CO-56 -/U CW beacon Telemetry decoded.*

*CO-57 -/U CW beacon Telemetry decoded.*

*CO-58 -/U CW beacon Telemetry decoded, QSL card received.*

David also mentioned that he had not listened for UO-11 or AO-7 for a while and he had not heard SuitSat. Very interesting summary, David. Thanks very much.

For telemetry buffs, UO-11 is back in operation again but is irregular in its appearances. Roughly 10 days on and 10 days off. I have heard it on several occasions but the signal is not as strong as in earlier years. My G3RUH demodulator was disposed of in a shack clearance when I moved QTH some years ago so all I can do is listen. I believe that some sound-card software will demodulate the signal but I haven't tried it myself. The signal sounds like it's 'normal' and should demodulate and decode but I can't vouch for the authenticity of the information. The AMSAT-BB has regular bulletins regarding UO-11 and the latest information is generally available from the AMSAT-UK web site.

AO-7 also graces us with its presence on an irregular basis. It switches from mode-A to mode-B every once in a while and again an entire web site is devoted to this aging, pioneer amateur radio satellite. Its high orbit, the highest of any LEO so far, makes it capable of giving quite good QSOs into ZL, VK6, the islands to our north and even into Antarctica when it all comes together.

Oscars have always been numbered in sequence. The lower figure represents the older satellite. We're way up over 50 now so numbers like 7, 10 and 11

are becoming rarer as we speak. Along with AO-10, also now very infrequent in its appearances, these three veterans represent a glimpse into the past history of amateur radio satellites. They are worth the effort in listening and are still capable of rewarding the listener with good contacts and interesting telemetry from time to time.

The signals from SuitSat have long faded away but it's still in orbit as I write this column. I managed to detect the signals using DSP software and hear them weakly when it was operating early in the piece but I never did record the entire voice message. AMSAT-NA is promoting a competition to predict its re-entry date. Details are available on the AMSAT-BB. SuitSat-2 is already on the drawing board and we hope it will realise its full potential, unlike SuitSat-I which unfortunately failed soon after deployment.

This is the latest information I have correlated from various AMSAT sources. It has been edited to local (southern hemisphere) conditions.

## VO-52 HAMSAT

Catalog Number: 28650

Launch Date: May 05, 2005

Status: Operational

Current Mode: U/V - Indian Transponder

Indian Transponder:

Uplink: 435.220 MHz to 435.280 MHz  
LSB/CW

Downlink: 145.870 MHz to 145.930 MHz  
USB/CW

Beacon: 145.859330 MHz CW

Dutch Transponder:

Uplink: 435.225 MHz to 435.275 MHz  
LSB/CW

Downlink: 145.875 MHz to 145.925 MHz  
USB/CW

Beacon: 145.860 MHz 12 wpm with CW message

Mode and Antenna Polarization:

V: LHCP

U: RHCP

Official Webpage: <http://www.amsat.in/hamsat.htm>

## The AMSAT group in Australia

The National Co-ordinator of AMSAT-VK is Graham Ratcliff VK5AGR. Contact Graham if you wish to be placed on a mailing list for breaking news and net reminders. As a forum for members AMSAT-VK operates two monthly nets.

AMSAT-Australia Echolink Net.

The "Echolink" net meets on the second Sunday of each month. Anyone with an interest in Amateur Radio Satellites is welcome to join the net. Graham VK5AGR acts as net controller. The net starts at 0500 UTC during summer time periods and 0600 UTC during winter standard time periods. Connect to the AMSAT conference server on Echolink a few minutes before these times.

## AMSAT-Australia HF net

The HF net meets informally on the second Sunday of each month. In winter (end of March until the end of October), the net meets on 3.685 MHz at 1000 UTC. In summer (end of October until end of March) the net meets on 7.068 MHz at 0900 UTC. Start listening 15 minutes before these times.

All communication regarding AMSAT-Australia matters can be addressed to:

AMSAT-VK,  
9 Homer Rd,  
Clarence Park, SA. 5034

Graham's e-mail address is:  
[vk5agr@amsat.org](mailto:vk5agr@amsat.org)

## AO-51 ECHO

Catalog number: 28375  
Launch date: June 29, 2004  
Status: Testing  
Current Mode(s): FM Repeater - V/U  
Digipeater - ON - 9K6, V/U  
Analog voice downlink: 435.300 MHz FM  
435.150 MHz FM  
2401.200 MHz FM  
Analog voice uplink: 145.880 MHz FM  
145.880 MHz USB  
145.920 MHz FM 67Hz PL tone  
1268.700 MHz FM 67Hz PL tone  
Digital Downlinks: 435.150 MHz FM, 38k4 Digital, PBP, 1 watt output  
2401.200 MHz FM 38k4 bps, AX.25  
Digital Uplink: 145.860 MHz FM, 9k6 Digital, Pacsat Broadcast  
Protocol  
1268.700 MHz FM, 9k6 PBP Digital  
Antenna Polarization is linear on all modes and frequencies.  
Broadcast Callsign: PECHO-11  
BBS Callsign: PECHO-12  
The mode schedule is listed on the official web page:  
<http://www.amsat.org/amsat-new/echo/>

## SO-50 SAUDISAT-1C

Catalog number: 27607  
Launched: December 20, 2002  
Status: Operational.  
Uplink: 145.850 MHz (67.0 Hz PL tone) (See below for operating procedures)  
Downlink: 436.795 MHz  
Linear Polarization  
To switch the transmitter on, you need to send a CTCSS tone of 74.4 Hz. Transmit on 145.850 MHz with a tone of 74.4 Hz to arm the 10 minute timer on board the spacecraft. Now transmit on 145.850 MHz (FM Voice) using 67.0 Hz to key-up the repeater within the 10 Minute window. Sending the 74.4 tone again within the window will reset the 10 minute timer.

## FO-29 JAS-2

Catalog number: 24278  
Launch Date: August 17, 1996  
Status: OPERATIONAL  
Voice/CW Mode JA

Uplink: 145.90 to 146.00 MHz CW/LSB  
Downlink: 435.80 to 435.90 MHz CW/USB  
Beacon: 435.795 MHz  
Digital Mode JD  
Uplink: 145.850 145.870 145.910 MHz FM  
Downlink: 435.910 MHz 1200-baud BPSK or 9600-baud FSK  
Callsign: 8J1JCS  
Digitaler: 435.910 MHz  
Antenna Polarization: V: RHCP - U: RHCP

## AO-7 AMSAT OSCAR 7

Catalog number: 07530  
Launch Date: November 15, 1974  
Status: Operational depending on amount of Sunlight  
Current Reported mode: Mode-A  
Uplink: 145.850 to 145.950 MHz CW/USB Mode A  
432.125 to 432.175 MHz CW/LSB Mode B  
Downlink: 29.400 to 29.500 MHz CW/USB Mode A (1W PEP)  
145.975 to 145.925 MHz CW/USB Mode B (8W PEP)  
145.975 to 145.925 MHz CW/USB Mode C (2W PEP)  
Beacons: 29.502 MHz, 145.972 MHz, 435.100 MHz, 2304.100 MHz

## International Space Station (ISS) - ARISS

Catalog number: 25544  
Launch date: November 20, 1998  
Status: Operational  
Current Mode: Packet - Mode V  
Digipeater: ON  
The current crew is:  
Commander: Pavel Vinogradov, RV3BS  
Flight Engineer: Jeff Williams, KD5TVQ  
Digital/APRS:  
Worldwide packet uplink: 145.990 MHz FM  
Worldwide packet downlink: 145.800 MHz FM  
Voice:  
Region 1 voice uplink: 145.200 MHz FM  
Region 2/3 voice uplink: 144.490 MHz FM

Worldwide downlink: 145.800 MHz FM  
Crossband Repeater:  
Repeater Uplink: 437.800 MHz FM  
Repeater Downlink: 145.800 MHz FM  
Antenna Polarization: Linear  
Callsigns:  
Russian: RS0ISS, RZ3DZR  
USA: NA1SS  
Packet Mailbox: RS0ISS-11  
Packet Keyboard: RS0ISS-3  
Digipeater callsign: ARISS

## NO-44 PCSAT

Catalog number: 26931  
Launch Date: September 30, 2001  
Status: Operational  
General Usage Uplink/Downlink: 145.827 MHz 1200 Baud  
Special Usage Downlink: 144.390 MHz 1200 Baud  
PCSAT APRS web page: <http://pcsat.aprs.org>  
Telemetry Decoder program: <http://www.xciv.org/~iain/aprstlm/v1.2/>

## PCSAT-2

Catalog Number: 25544  
Launch Date: August 1, 2005  
Activated: August 3, 2005  
Status: Operational  
Current Mode: Digipeater / XBAUD (PSK31/CW Repeater)  
Digital Downlink: 435.275 MHz  
Digital Uplink: 145.825 MHz  
PSK-31 Downlink: 435.275 MHz  
PSK-31 Uplink: 29.401 MHz  
CALLSIGN: pcsat2

## GO-32 TECHSAT-1B

Catalog number: 25397  
Launch Date: July 10, 1998  
Status: Operational  
Downlink: 435.225 MHz FM (9600-baud FSK)  
435.325 MHz - Not Available - temperature problems  
Uplinks: 145.850, 145.890, 145.930, 1269.700, 1269.800, 1269.900 MHz.  
Broadcast Callsign: 4XTECH-11  
BBS Callsign: 4XTECH-12

*continued next page*

## KVK Antenna Systems

Best value books in VK.

The VK Antenna Handbook for Restricted Spaces

Best value antennas in VK.

The NuBeam

The Vertical-LR-dipole multiband vertical

As seen at Wyong

Check out the latest revision to the web site - more info, more antennas, more value.

For direct purchases  
[www.grimshaw.net.au](http://www.grimshaw.net.au)

For credit card purchases:  
[www.kvkanennas.com.au](http://www.kvkanennas.com.au)  
or ph 07-3216 8060 or  
fx 07-3216 8075

## Over to you:

### VK2YO article on mobile radio installation solutions.

I found Neville's article very interesting, as will any operator who buys a modern car and wonders how to fit the radio(s) without messing up the interior.

A couple of issues here:

1. Modern cars run on computers and engine management plus braking/stability systems are heavily computer dependent - one is never sure if your own radio transmitters at a critical time will have adverse consequences to vehicle behaviour - does anyone out there know how to find out?

2. I suggest extensive use of single sided mounting tape to line 'hanger' brackets - this will minimise (but not entirely prevent) interior plastics from getting marked over time from constant small movements.

3. Neville is clearly pleased with the

performance of his new 2.0 L Golf diesel - and who would not be BUT the figures quoted raise a couple of issues to my mind:

a) In Canberra, early June pump prices of \$1.47 for diesel and \$1.34 for standard unleaded, a 100 km long country trip in the Golf diesel (5.9 L per 100 km) will cost \$8.67 and in my 3 year old Calais (10 L/100 km) \$13.40. Both are modern comfortable vehicles but the Calais is more so, due to greater interior room.

b) Are small/medium diesel cars really better to own? This is clearly a personal choice but think hard about it before buying - and check the diesel service costs! One I looked at had a \$950 service scheduled down the track a bit.

Gilbert Hughes VK1GH  
email: [ghug9104@bigpond.net.au](mailto:ghug9104@bigpond.net.au)

## Silent key

Mike Oliva VK3BVR

Mike Oliva VK3BVR passed away sometime after late March. He was somewhat well known for operating AM on 7010 a while back. Further details are not available at this time. Notified by Damien Vale VK3RX.

### AMSAT continued

#### AO-16 PACSAT

Catalog number: 20439

Launch Date: January 22, 1990

Status: Semi-operational, the digipeater command is on and open for APRS users.

Uplink: 145.900 FM, 145.920 FM, 145.940 FM, 145.960 FM (using 1200-baud Manchester FSK)

Downlink: 437.026 MHz SSB (1200-baud PSK)

Mode-S Beacon: 2401.1428 MHz

Mode and Antenna Polarization:

437.050 MHz RHCP

437.025 MHz LHCP

2m: Linear

Broadcast Callsign: PACSAT-11

BBS Callsign: PACSAT-12

#### UO-11 OSCAR-11

Catalog number: 14781

Launched: March 1, 1984

Status: Semi-operational

Telemetry Downlink: 145.826 MHz.  
FM (1200-baud AFSK).

approx. 10 days ON, 10 days OFF

Mode-S Beacon: 2401.500 MHz. ...  
OFF

UHF Beacon: 435.025 MHz. ... OFF

Antenna Polarization: RHCP

Official webpage: <http://www.users.zetnet.co.uk/clivew/>

### Women in Radio continued

"Mrs. Joan". Everyone knows who these visitors are looking for and they are proud of their Mrs Joan.

It was a few years ago now, though, that the most dramatic event happened.

Mrs Joan was contacted by one of her Japanese fishermen contacts and asked if she would please arrange his wedding in Mildura. He wished to marry in Mildura and would be arriving two days before the due date. Could Mrs Joan arrange everything please?

Mrs Joan did just that. She chose the wedding dress and the clothes for the groom, the wedding venue, the celebrant and the wedding breakfast to follow, including the cake.

Joan had never met the groom before although she had known him on air for some years, but she was delighted that he wanted her to arrange such an important moment in his life.

Everything went exactly to plan. It was a lovely wedding and a happy couple.

Joan says that although she does still operate a maritime net these days, the need is not so great with satellite navigation, GPS and all the emergency equipment now available.

More important to Joan, is that she still has regular contact on-air from many of the Japanese friends she has made over the years, even though they are now land-based. Some still visit her in Mildura, and she and Ray have visited some of them in Japan: a suitable reward for much hard work and dedication.

## Contest Calendar July - September 2006

July	1	Canada day Contest	(CW/SSB)
	1	NZART Memorial Contest	(CW/SSB)
	8	VK/trans-Tasman 160 Metres Phone Contest	
	8/9	IARU HF World Championship	(CW/SSB)
	15/16	CQ WW VHF Contest	(All modes)
	15/16	Seanet Contest	(All modes)
	15	Jack Files Memorial Contest	(CW/SSB)
	22	VK/trans-Tasman 160 Metres CW Contest	
	29	Waitakere (NZART) Sprint	(SSB)
Aug	5	QRP Day Contest	(CW/SSB/FM/PSK31)
	5	Waitakere (NZART) Sprint	(CW)
	9	TARA Grid Dip	(PSK/RTTY)
	5/6	10-10 Intl QSO Party	(SSB)
	12/13	Remembrance Day Contest	(CW/SSB/FM)
	19/20	Keymen's Club of Japan Contest	(CW)
	19/20	SEANET Contest	(CW/SSB)
	26/27	ALARA Contest	(CW/SSB)
	26/27	TOEC WW Grid Contest	(CW)
26/27	YO DX HF Contest	(CW/SSB)	
Sept	2	Russian RTTY WW Contest	(RTTY)
	2/3	All Asian DX Contest	(SSB)
	9/10	Worked All Europe DX Contest	(SSB)
	23/24	CQ WW RTTY DX Contest	(RTTY)

## Greetings to all Readers

There are a few things that need to be included this month, so I have decided to defer Part Three of my thoughts about getting started in contesting. Apologies if you have found the two previous sections of any help, but it will return!

## RD Contest

Firstly this month, I take it upon myself to offer to the AR community in Australia a sincere and heartfelt apology for the absence of the results of the RD Contest 2005. It was published early this year that VK6 had again been the winners of the 2005 event; but no amount of excuses absolve the problems that have ensued with publication of the actual results.

That there were difficulties experienced by the Manager – quite serious difficulties which took time and money to rectify – cannot be denied and are not easy to

overcome. When personal problems also intrude, then it is easy for us outsiders to say 'keep the personal problems personal', but it still adds to the distress and pressure.

WIA, both through one of the Directors and myself, have tried to assist the Manager in getting through these problems. Although that assistance is on-going, I am sorry to report that the Manager is not a well man and that, as a consequence, the reins of the RD Managership have now been passed to Peter Harding VK4OD. I understand that Peter has all the details of the 2005 logs, so I ask those of you waiting for them to continue to be patient. We are confident that the results will be published, but when is open to speculation at the moment. Peter has been very busy at time of writing these notes in going through this year's Rules (see comments below on changes), liaising with the authors of logging programs and

preparing written sheets for those of you not familiar with loggers.

In the meanwhile, some of you have already said that you will not take part in any more RD Contests. I ask you not to adopt this stance – it is self-defeating and not worthy of us as a community, nor of the Australian spirit of supporting our mates in the face of adversity.

If you remember that the RD is a REMEMBRANCE of those who gave their lives in a much bigger cause than any AR contest can ever be, then our worries about poor service, etc. really pale into insignificance.

So far this year there has been very good support for the VK contests held. HF is literally alive with stations calling and making exchanges. Sadly I must say that VHF is in decline, but the RD has its VHF devotees (as has the CW section).

One thing I can assure you is that I have asked that procedures be implemented

whereby the logs information will be processed in such a way that this year, 2006, will see the results published in either December AR, or in February 2007.

This is an important statement for me, as I rest my reputation as National Contest Co-ordinator on it. It is a big job checking all logs eg. I have been told that one year the Manager had about 20 kg of paper on his table!!

Again, in apologizing to you for not having shown the most efficient leadership in the 2005 issue, I nevertheless ask for your full support for 2006. The Rules are below. I ask you to read them and to prepare to be involved.

Please note some small changes – a minimum of two hours between repeat contacts on ALL bands; the sending of logs within three weeks of the contest, and preferably via email within 48 hours of the finish of the event. Please check the rules carefully for the sections that interest you.

## Contest Logging software

Secondly, last year saw the emergence of several logging programs (loggers) designed for the RD Contest. In fact I heard many operators say that they would not have been in it at all if it were not for those logging programs.

They are available again. Please check the following web sites:-

From Mike Subocz VK3AVV, the VK Contest Log (VKCL) can be found at the following URL:  
<http://web.aanet.com/mnds>

From John Drew VK5DJ RD logging program can be found at the following URL  
[http://vk5dj.mountgambier.org/Amateur\\_radio.html](http://vk5dj.mountgambier.org/Amateur_radio.html)

From James McBride VK6FJA WinRD+ logging program can be found at URL:  
<http://www.rjmb.net/rd/index.htm>

It cannot be denied that loggers make the business of scoring much easier. Overseas it is now possible for computers to do the checking and ranking too. Such a situation is some time off here in VK-land.

However, I do urge as many of you as possible to use a logger and send the result via email to the contest address (see Rules). This way, everything is kept electronic (and probably this is where

the 20 kg of paper came in above — the Manager had to print all the emails!).

Are you worried about typing and calling at the same time? Quite understandable if you are not used to it. What is the answer?

1/ write it all down if you must then transfer it to the log (double handling and takes as long as working the contest);

2/ be prepared to restrict your area of working to one mode or band;

3/ best of all: practise, practise, practise.

Each time you work on air, try typing your contacts onto your screen, your shack logger if you use one, or just onto a blank document page. You will see that it is not such a difficult task. Working CW takes a little more practice, but again not impossible. You have over a month to practise so that when the time comes (see dates above) you will be amazed at your dexterity.

## Commonwealth Contest

Thirdly this month I print below an article received from Les Allwood G3VQO, Manager of the annual Commonwealth Contest (also known as BERU after its original name British Empire Radio Union Contest). Its message is quite self-explanatory, as are the 2005 results below.

### The 69th RSGB Commonwealth Contest, 2006

*As can be expected at this stage of the solar cycle, conditions were less than ideal on the higher bands, but it was still disappointing to find just fourteen logs from Australia for this year's contest – six in the Open section, six in the Restricted section, one checklog, and one HQ station (VK4WIA, thanks to Keith VK4TT). The contest is an excellent opportunity to work some exotic DX without a wall of QRM from Japan and elsewhere, more so as those stations will be deliberately seeking Australian contacts. The 2006 contest coincided with a major DXpedition to Rotuma, and although 3D2RO and 3D2RX made welcome appearances in many logs, they declined to actually submit a contest entry.*

*2005 had seen nobody from the Southern hemisphere in the Open section top ten, so it is a pleasure to see the situation remedied this time out. Sadly for the Aussies, it was New Zealand that took the honours here, with the Quartz Hill super-*

*station, operated by Brian ZLIAZE, gaining sixth spot. John VK4EMM was the leading Australian, finishing in fifteenth position, despite accidentally deleting his log after the contest! Luckily he was able to re-create it from notes and some mp3 audio.*

*The Restricted category shows a slightly more encouraging story, with Barry VK2BJ retaining his top ten placing, although slipping from second to seventh, having gathered only around half as many QSOs as in 2005 in the frustratingly poor conditions. Next was Tasmania's Martin VK7GN who finished at number seventeen.*

*With the 2007 Commonwealth Contest being the 70th, there will be some innovative changes to the rules, aimed at keeping this event amongst the forefront of international contests. Full details will appear on the BERU website at <http://www.beru.org.uk> together with an expanded version of this year's results, pictures, and other contest-related items. Whilst re-defining the Restricted section on a 100 watts and single-element antenna basis, we are retaining the popular choice of twelve or twenty-four hour options both here and in the otherwise unchanged Open section. Additionally, we are making provision for multi-operator and cluster-assisted entries within the current HQ category. Our hope is that these amendments, made after due discussion with entrants world-wide, will encourage greater participation.*

*A further option is the new Traveller award. This is intended to reward entrants who enter from a Commonwealth call-area that was not active in the previous year's event. This is an ideal opportunity for Australians who wish to be adventurous, as you have many such places in your quadrant of the globe (even ACT would count for 2007!!!). Who knows, we may one day work the island of Beru (yes, it actually exists) in the contest!*

*Now for the big one!! As the 2007 contest coincides with the Cricket World Cup in the West Indies, we will be running a team-based radio competition between various regions of the Commonwealth. An obvious such team would be one representing Australia. Now, we know that, on a good day, Australian teams can beat the world at cricket or rugby, and you didn't do too badly with your medal tally at the Commonwealth*



*Games, but can you assemble a team of eleven to win in the Commonwealth Contest? We'll play fair, by devising a handicap system designed to offset the known disadvantage of being in the southern hemisphere. So now is a chance to show what us you're made of. Will you be world-beaters, or just Socceroos? Take a look at the rules, select your team and we'll be ready for you at 1000 UTC on Saturday 10th March, 2007.*

Les Allwood G3VQO

Finally this month I remind you all of the Jack Files Contest in mid-July and the QRP Day Contest in early August and invite you all to join in these. These are again examples of those shorter, hour-based events that have so far proven popular this year. In the QRP Day Contest there is no specific requirement to operate at QRP levels, but as the event is sponsored by the CW Operators' QRP Club, it is understandable that they were thinking in terms of low power working.

The Club also wishes to welcome Gerard VK4TGL to the management of this event.

Mike VK3AVV has very kindly adapted his VKCL logging program for both the Jack Files and QRP Day contests. Please download from Mike's web site noted above in the comments on the RD Contest.

Good contesting and 73,

Ian Godsil VK3JS

## Results Commonwealth Contest 2005

### Open Section Leaders and VKs

Pos	Callsign	Score	QSO	BCA	80m	40m	20m	15m	10m
1	VE3EJ	7559	727	133	137/44	219/73	329/55	40/30	2/2
2	ZC4LI	6667	784	93	75/13	209/39	304/54	184/27	12/9
3	P3J	6300	759	91	50/11	284/48	282/55	139/14	4/4
4	J88DR	5816	591	103	104/29	137/30	276/49	70/36	4/4
5	G4BUO	5448	293	128	43/31	85/63	123/69	37/32	5/5
15	VK4EMM	4481	361	99	27/20	97/45	194/43	41/33	2/1
25	VK4BU	2798	174	74	17/17	53/37	95/35	9/9	0/0
31	VK8AV	2499	115	76	21/19	40/32	43/36	11/11	0/0
40	VK4XA	2107	124	56	11/11	46/30	55/24	11/11	1/1
50	VK6AJ	1656	78	47	0/0	51/38	18/17	9/9	0/0
55	VK2NU	1485	73	44	14/14	37/29	19/14	3/2	0/0

### Restricted Section Leaders and VKs

Pos	Callsign	Score	QSO	BCA	80m	40m	20m	15m	10m
1	ZF2NT	6084	570	106	67/36	156/42	269/46	73/39	5/3
2	5B4AGC	5842	576	90	24/11	176/35	330/60	120/21	4/4
3	VE3FU	5234	507	96	40/30	192/46	252/44	23/18	0/0
4	VE1OP	4430	514	66	80/21	143/32	290/44	1/1	0/0
5	VE3DZ	4207	356	84	33/25	122/44	190/44	10/10	1/1
7	VK2BJ	3446	209	86	24/23	51/42	112/35	22/21	0/0
17	VK7GN	2500	217	48	21/15	134/38	62/24	0/0	0/0
18	VK6VZ	2314	133	57	15/11	42/33	58/26	18/14	0/0
44	VK4XY	1313	70	36	5/4	33/22	23/17	8/7	1/0
48	VK2BAA	1212	61	35	5/4	43/32	12/10	1/1	0/0
49	VK6HG	1203	53	37	6/6	31/25	12/12	4/4	0/0

## Results Harry Angel Sprint 2006

### CW

1	VK4BUI	Les Styles	32 points
2	ZL1BYZ	John Shaw	30
3	VK3OZ	Pat Pavey	28
4	VK3TX	Deane Blackman	26
5	VK3NEA	Alan Potter	18

### SSB

1	VK4YZ	Charlie Strong	59 points
2	VK7VH	Vince Henderson	45
3	VK4MH	Margaret Haigh	44
4=	VK4DMC	Dale McCarthy	36
4=	VK2JAH	Laurie Gordon	36
6	VK3HJO	John Drago	35
7=	VK2LCD	Chris Meagher	34
7=	VK5ZKT	Karsten Thole	34
9	VK3AAK	Michael Coleman	31

10	VK2HBG	Gerald Bonnington	28
11	VK4BAY	Roy Mahoney	27
12	VK2KWM	Wayne Memphis	23
13	VK6ZNV/6	John Howlett	18
14	VK1EY	Bob Woodman	4

### MIXED

1	VK4SN	Alan Shannon	66
2	VK4DX	Mike Sivevic	51
3	VK4AQ	Ross Anderson	44
4	ZL1DK	David Karrasch	39
5	VK4NMC	Bryan Cunningham	26

Thank you all for your participation this year. The participation was higher than for several years.

*Note:* As Contest Manager, my own log was not included in the ranking.

Ian Godsil VK3JS Contest Manager

## Rules COQC QRP Day Contest 2006

0800z - 1200UTC Saturday, 5 August

Gerard Lawler VK4TGL  
Contest Manager

Sponsored by the CW Operators' QRP Club in Australia and open to all AR operators, the objects are --

1. to work as many stations as possible in each hour,
2. to encourage contacts between VK, ZL and P29 stations,
3. to encourage the use and enjoyment of low power equipment, whether commercial or home-brewed,
4. to test the efficiency of your station under QRP conditions,
5. to compete for a certificate for best hour and/or best three hours,
6. (in VK) to prepare for the Remembrance Day Contest.

Entrants are encouraged to compete for all four hours, but to submit their logs on the basis of "best three hours". Logs will also be considered for highest score in any individual hour.

BANDS: HF and VHF may be used. On VHF, contacts must

be on a simplex frequency. All HF bands (no WARC) may be used, although it is envisaged that the bulk of operations will be on 80 and 40 metres.

CATEGORY: Single Operator only.

MODES: CW/PSK31, Phone, Mixed.

EXCHANGE: A three-digit serial number beginning at 001 and incrementing by one for each contact.

REPEAT CONTACTS: In order to make greater use of available band space and time, repeat contacts with the same station will be allowed once each hour of the contest on each mode (ie a station may be worked each hour on CW and Phone). Please note, RS(T) no longer required, but if given should be an accurate statement of signal strength.

**Scoring:**

Stations within VK/ZL/P29 score as follows —

VK-VK 1 point	ZL-ZL 1 point	P29-P29 1 point	
VK-ZL	3 points	ZL-VK 3 points	P29-ZL 3 points
VK-P29 3 points	ZL-P29 3 points	P29-VK 3 points	

Any DX stations (outside VK/ZL/P29) score 5 points.

A BONUS of 20 POINTS may be claimed if the QRP station operated with an homebrew transmitter or transceiver.

FINAL SCORE is the sum of the total QSO points, plus any bonus points. Except for the use of homebrew equipment (see above), no multipliers apply.

LOGS: PLEASE USE SEPARATE LOGS FOR CW/PSK31, PHONE or

MIXED MODES. Logs must show full details of time UTC, station worked, band, mode, exchange and points claimed. Arrange logs so that each hour is clearly distinguishable. Logs should be submitted for "best three hours" and scores will be considered for highest score for each separate hour. Please indicate clearly if you claim the 20 points bonus for homebrew equipment (once only for the Contest).

CERTIFICATES: Certificates will be awarded to the following -

- (i) first three placegetters in each mode who submit "best three hours" entries,
- (ii) the highest scorer in each hour in each mode in each call area.

GENERAL:

(i) A SUMMARY SHEET, showing operator's callsign, name, address and points claimed should accompany the Log.

(ii) Any station claiming to operate QRP MUST NOT exceed a maximum of five watts carrier to the antenna and should add /QRP after its callsign.

SEND Logs and Summary Sheet by mail to --

Gerard Lawler VK4TGL, 82 Rowe Terrace, DARRA, 4076.

Logs may also be sent via email to lawler@asgard.net.au

All entries to be received no later than Friday, 18 August, 2006.

## 80 m Trans-Tasman Complete results 2006

Bruce Renn VK3JWZ  
Contest Manager

### Category 1 (Phone) /1

Call sign	Score	Contacts
1st. VK2CZ	3378	317
Equal 2nd. VK2ATZ (multi op)	2946	302
Equal 2nd. VK3IO	2941	305
Equal 3rd. VK3FRC (multi op)	2876	285
Equal 3rd. VK5LA	2788	259
6th. VK7VH	2702	259
7th. VK3QB/p2	2296	224
8th. VK2QV	1987	197
9th. VK4HTM	1894	211
10th. ZL1BYZ	1779	204
11th. VK2JAH	1747	187
12th. ZL1ALZ	1683	197
13th. ZL2AKM/p3	1664	227
14th. ZL2CC	1642	179
15th. VK2LCD/Q	1615	155
16th. ZL1KMN	1582	192
17th. VK7TAZ	1576	172
18th. ZL2SKY	1573	168
19th. ZL4AL	1537	179
20th. VK7GN	1409	154
21st. VK3AAK/Q	1373	127
22nd. VK4TAA	1345	186
23rd. VK2WG	1317	150
equal 24th. VK2FKJG	1307	141
equal 24th. VK2HBG	1307	176
26th. ZL4AD	1245	164
27th. VK2LEE	1222	142
28th. ZL1DT	1171	142
29th. VK7HDX	1155	165

30th. ZL1AAR	1139	121
31st. ZL4AA	1118	174
ineligible. VK3JWZ	1117	121
32nd. ZL2AYZ	1084	119
equal 33rd. ZL2AGD	1079	154
equal 33rd. ZL2AUB	1079	133
35th. VK7HAY	1046	146
36th. ZL4IM	1038	105
37th. VK3DID/Q	1001	181
equal 38th. VK3SAY (Scouts multi op)	955	128
equal 38th. VK5BP (Scouts multi op)	955	140
40th. VK4HFO	949	116
41st. VK4TWR	940	100
42nd. VK5BLS	891	92
43rd. VK5XY	833	102
44th. VK3SAA (Scouts multi op)	683	108
45th. VK5KMC	638	87
46th. VK7ARN	630	76
47th. ZL2MS	598	68
48th. VK4WIG	581	71
49th. ZL1TYR	561	85
50th. ZL2TJB	534	74
equal 51st. VK2WJD	520	80
equal 51st. VK4TGL/Q	520	66
53rd. ZL1RP	481	65
54th. ZL2UNR	441	65
55th. VK4DGG/Q	430	68
56th. VK2GR	395	50
57th. VK4CCV/Q	361	55
58th. VK5ZFW	312	50
59th. VK2FQRP	298	34

80th. VK5FROB	198	35
61st. VK6XT	137	21
62nd. VK3YB/Q	132	19
63rd. VK2ZZ	115	19
64th. VK5ATQ	112	22
65th. VK5UE	97	21
66th. VK4VCC/Q	44	14
67th. VK4MAN	38	10

### Category 2 (QRP Phone)

Call sign	Score	Contacts
1st. VK3DID	2001	181
2nd. VK2LCD	1391	131
3rd. VK3AAK	1373	127
4th. VK3DID	1001	181
5th. VK4TGL	520	66
6th. VK4DGG	430	68
7th. VK4CCV	361	55
8th. VK3YB	132	19

15 QRP stations participated

### Category 3 (Foundation Licence)

Call sign	Score	Contacts
1st. VK2FJKG	1307	141
2nd. VK2FQRP	298	34
3rd. VK5FROB	198	35

17 Foundation licensees participated

### Category 6 (SWL)

Call sign	Score
1st. Tony Newman (Qld)	1156
2nd. VK3JQ	483

# 2006 VK/trans-Tasman Contests 80 m results

80 Metres PHONE on 13th May was favoured with very quiet band conditions on the mainland, and mostly good propagation.

Hobart and New Zealand had QRN. The 80 Metre Trophy for highest overall score (PH and CW) was won by VK2CZ, David Burger, from St Leonards, NSW. David also won the certificates for 1st 80M Phone, and 1st VK.

VK2ATZ multi-operator (Westlakes ARC) from Newcastle was equal 2nd with Ron Tremayne VK3IO from Cockatoo, VIC.

Ron also won the Night Owl's Bucket Mouth Award for the highest score in the last hour.

VK3FRC (Mornington Peninsular ARC) was equal 3rd, with Andrew Williss VK5LA from Berri SA.

The QRP Phone was won by Ian Godsil VK3DID from Chelsea, Victoria.

The new Foundation Licence Category was won by John Green VK2FJKG from Anambah, NSW.

17 Foundation Licensees participated, albeit in a small way, in the Contest.

John Shaw ZL1BYZ, won the certificate for 1st ZL, with Tony Newman from QLD winning a two-horse race for the SWL Category.

A record 271 stations participated, and a record 70 logs were received. However, the percentage of ZL's participating has dropped below the previous two years.

Unfortunately, this makes the "Participation Factor" work against the ZL's scores.

Before the 2006 160 metre Contests, the Contest Manager will scrutinize the Results, to see if anything else needs to be done to further level the playing field. This may involve reducing points

for a VK contacting a VK, from 3 to 2.

Don't forget 160 metres PHONE on 8th July, and CW on the 22nd.

80M CW on 27th May had reasonably good conditions, with some QRN in some areas.

David Pilley VK2AYD from Wauchope won narrowly with 1143 pts, from Ron Tremayne (VK3IO - Cockatoo) on 1097, and John Balsillie (ZL1ALZ - Pokeno) on 1013.

G. Luscomb ZL2AVL - Waiouru won the CW QRP Category, and Bill Cousins ZL2AYZ - Blenheim, won the Night Owl's "Paddle-pumper Award" for the highest score in the last hour.

60 stations participated, and 24 logs were received, which was a slight improvement on last year.

# 2005 Remembrance Day Contest

Peter Harding VK4OD  
RD Contest Manager

Firstly I would like to congratulate Alex VK6APK for his many years as the RD Contest Manager, and many thanks to Chris Edmondson VK4AA/VK3CE who is unable to continue in the role.

I have constructed some software to aid the compiling of Scores for the RD contest. To prove this program, I started by entering all the available data from the 2004 and 2005 RD Contests. Having done this and confirmed the past winners I am now able to advise the final top scorers for each state and the overall highest winner.

In 2004 a total of 303 logs were processed with a total of 27,441 points. In 2005 we had a total of 271 Logs with a Points total of 36,171.

While we can see the number of logs received is down, we are unable to compare the points as 2005 had some bonus points that were not available in 2004.

Whilst VK6 had the top overall points (HF and VHF), this assisted by the extra points for all communications that were in excess of 1000km.

- The total logs from each state are:
- VK0 with 1
  - VK1 with 15
  - VK2 with 39
  - VK3 with 152
  - VK4 with 53

- VK5/8 with 51
- VK6 with 92
- VK7 with 30

The overall top points winner this year is VK3ACR followed by VK5BP. The total of the points is a combination of HF and VHF.

The individual state winners are:

- VK1GG with 574 points
- VK2WIA with 612 points
- VK3ACR with 2096 points
- VK4FNQ with 1018 points
- VK5BP with 1168 points
- VK6ZRE with 797 points
- VK7GN with 774 points

This year's revised rules and introduction is now available on the WIA website contest area, along with a set of Cover and Log sheets.

Certificates to the individual winners will be issued as soon as they are printed and signed.

Peter Harding

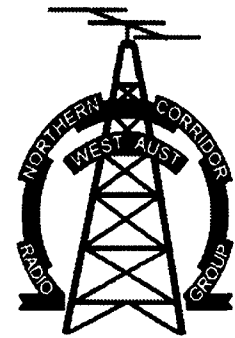

## HAMFEST 2006

SUNDAY 6<sup>th</sup> AUGUST  
CYRIL JACKSON CENTRE  
FISHER ST BASSENDEAN 9am START  
WESTERN AUSTRALIA'S PREMIERE  
EVENT IS ONCE AGAIN UPON US.  
IN THIS, OUR 20th YEAR, WE ARE PROUD TO  
WELCOME INTERSTATE TRADERS AND  
EXHIBITORS.

*AS USUAL WE WILL HAVE EXCELLENT FOOD AND DRINKS  
AVAILABLE AT REASONABLE PRICES AND GREAT RAFFLE  
PRIZES TO BE WON ON THE DAY.  
PLENTY OF TABLES AND PARKING AVAILABLE  
CONTACT KEITH VK6XH FOR FURTHER DETAILS ON  
Mobile 0419 901 539 OR vk6xh@amsa1.org*

**PLEASE NOTE THE NEW DATE !!!**  
SUNDAY 6<sup>th</sup> AUGUST 2006

Ed.: Full Results will be published in the August issue."

# Rules: 2006 Remembrance Day Contest

12/13 August 0800z Sat to  
0759z Sun

Presented by:- Peter Harding VK4OD  
Email:- vk4od@wia.org.au

## Purpose:

This contest commemorates the amateurs who died during World War II and is designed to encourage friendly participation and help improve the operating skills of participants. It is held close to 15 August, the date on which hostilities ceased in the southwest Pacific area.

It is preceded by a short opening address by a notable personality transmitted on various WIA frequencies during the 15 minutes prior to the contest. During this ceremony, a roll call of amateurs who paid the supreme sacrifice during WWII is read.

A perpetual trophy is awarded annually to the Australian state or territory with the best performance. The name of the winning State or Territory is inscribed on the trophy, and that State or Territory then holds the trophy for 12 months. The winning State or Territory is also given a certificate, as are leading entrants.

## Objective:

Amateurs in each VK call area will endeavour to contact amateurs in other VK call areas, ZL and P2 on all bands except "WARC" bands. On 1.8, 28 and 50 MHz, entrants may also contact other amateurs in their own call area.

## Contest Period:

0800z Saturday, 12 August to 0759z Sunday, 13 August, 2006. As a mark of respect, stations are asked to observe 15 minutes' silence prior to the start of the contest, during which the opening ceremony will be broadcast.

## Rules:

### 1. Categories:

- High Frequency for operation on bands below 50 MHz;
- Very High Frequency for operation on and above 50 MHz;
- Single Operator; and
- Multi-operator.

### 2. Within each Category the Sections are:

- Transmitting Phone (FM, SSB);

(b) Transmitting CW (CW); Note: CW in this context means CW only; any other digital modes such as Packet, RTTY, AMTOR, PSK31, etc are excluded from the contest.

- Transmitting Open (a) and (b);
- Receiving (a), (b) or (c).

3. All amateurs in Australia, Papua New Guinea and New Zealand may enter the contest, whether their stations are fixed, portable or mobile.

4a. Cross-band and/or cross-mode contacts are not permitted.

4b. Operation via any means other than those which use direct radio transmissions is banned. This includes all means such as IRLP or Echolink, which rely on contact via the internet.

5. Call "CQ RD", "CQ CONTEST" or "CQ TEST".

6a. On HF bands, stations may be contacted at intervals of not less than two hours since the previous contact on that band and mode.

6b. No points will be awarded for contacts between stations in the same call area on HF, except on the 160 metre and the 10 metre bands, on which entrants may work stations in the same call area.

6c. On the 10 metre band, contacts may also be made using the FM mode, using simplex only, on frequencies above 29.0 MHz only. This will be considered a different mode for scoring purposes, so an SSB or CW contact could immediately be made with the same station below 29.0MHz for an additional score.

7a. On 50 MHz and above, the same station in any call area may be worked using any of the modes listed at intervals of not less than two hours since the previous contact on that band and mode.

7b. For the VHF category, up to three contacts may be made with the same station consecutively on each band, but must be made using the different allowable modes of CW, SSB and FM. However, the different modes must be within the frequency ranges stated in the text descriptions of the latest Call Book as 'mode' only. For example, on the two metre band, RD

Contest CW contacts may only be made in the range 144.050 to 144.100 MHz. SSB contacts are restricted to 144.100 to 144.400, while FM contacts must be above 146.000 MHz. The national simplex calling channels (146.500 MHz on the two metre band), and the frequencies either side thereof, excluding recognised repeater frequencies, are the frequencies of choice. When changing modes, entrants must also change frequency.

8a. Both single and multi-operator entries are permitted. To be eligible as a single operator, one person must perform all operating and logging activities without assistance other than computer logging, using his or her own callsign. More than one person can use the same station and remain a single operator providing that each uses his or her own callsign, submits a separate log under that callsign and does not receive operating or logging assistance in any way other than computer logging during the contest.

8b. Holders of more than one licence or callsign "MUST" submit a separate entry for each callsign used.

9a. Multi-operator stations are only allowed one transmitter per band/mode at any one time. Simultaneous transmissions on different bands are permitted. Simultaneous transmissions on the same band but different modes are permitted.

Any large multi-operator stations may find it more convenient to use separate band and/or mode logs.

9b. Automated operation is not permitted. The operator must have physical control of the station for each contact. CW and voice keyers are permitted, as is the use of computers for logging purposes only.

10a. For a contact to be valid, a three-digit serial number commencing at 001 and incrementing by one for each successive contact must be exchanged between stations making the contact. (RS/RST reporting is not required, but if given should be an accurate appraisal of the signal).

10b. Separate logs are required for entrants competing on both HF and VHF, although all allowable modes

can be contained within one log for HF and one log for VHF.

11. Contacts via repeater or relay are not permitted for scoring purposes. Contacts may be arranged through a repeater, although contact numbers may not be aired there. Operation on repeater frequencies in simplex is not permitted.

12. Score:

on 160 metres two points per completed valid contact;  
on 23cm or higher bands two points per completed valid contact;

on all other bands one point;

on CW irrespective of band, double points.

all scores obtained between the entrant's local time hours of 0100 and 0600 are doubled. If working into an area where the time is outside those hours, the score is doubled only for the station whose local time is 0100 to 0600 hours.

13. Logs should be in the format shown below and accompanied by a Summary Sheet showing callsign; name; address; category; section; for multi-operator stations a list of the operators; total score; declaration: I hereby certify that I have operated in accordance with the rules and spirit of the contest; signed (postal mail only); date.

14. Entrants operating on both HF and VHF are required to submit separate logs and summary sheets for both categories.

15. VK entrants temporarily operating outside their allocated call area, including those outside continental Australia as defined for DXCC, can elect to have their points credited to their home State by making a statement to that effect on their summary sheet(s).

16a. Logs can be submitted by electronic mail or postal mail:

By mail, send logs and summary sheets to: RD Contest Manager.

Endorse the front of the envelope  
"Remembrance Day Contest".

Peter Harding VK4OD

40 Centaurus Cres Regents Park QLD 4118.

e-mail, PLAIN TEXT logs only may be sent to  
rdlogs@wia.org.au

16b. Electronic Logging is preferred but by no means mandatory. Those entrants with a suitable PC may wish to consider it for this year. By using one of these programs, the file that is Emailed to me can be imported easily into the scoring database program. Links for these programs are listed below. I have tried and tested them all with the assistance of all the creators, they have rewritten parts of their program to assist scoring.

On completion of the contest you can email the file VK4XXXX.csv, which is a comma-delimited file format, as it can be imported into our database.

See Software download links note on page 5

16c. In all cases, logs must be received by last mail on Monday 4th September, 2006. Late entries will not be eligible.

17. Certificates will be awarded to the leading entrants in each section, both single and multi-operator; in each State; P2 and ZL. Entrants must make at least 10 contacts to be eligible for awards, unless otherwise decided by the Contest Manager.

18. Any station observed as departing from the generally accepted codes of operating ethics may be disqualified.

## Determination of Winning State or Territory.

Scoring will be achieved by taking the total number of logs for each State or Territory, divided by the total number of licences issued in that State or Territory (excluding beacons and repeaters) as published in the WIA Callbook for that year, and multiplying by the total score for that State or Territory. Points can only be considered where a station has submitted a valid log.

Unless otherwise elected by the entrant concerned, the scores of VK0 stations will be credited to VK7, and the scores of VK9 to the mainland call area which is geographically closest. Scores of P2, ZL and SWL stations will not be included in these calculations.

## Receiving Section Rules

1. This section is open to all SWLs in Australia, Papua New Guinea and New Zealand. No active transmitting station may enter this section.

2. Rules are the same as for the Transmitting Section, the only double points will apply to ALLCW contacts, and contacts between 01:00 and 06:00.

3. In all cases, distances may be estimated. The Contest Manager's calculation of distance shall be the final arbiter.

4. Only completed contacts may be logged, ie it is not permissible to log a station calling CQ.

## Layout of logs:

The log should be in the format shown below, whether submitted electronically or via the postal Mail. Sample logs are available on the WIA and local website or may be posted on request, with a Self Stamped Addressed Envelope.

### Sample Summary Sheet:

#### Remembrance Day Contest 2006

**Callsign:** VK1xxx

**Name:** Operator's full name

**Address:** Physical address of contest station

**Category:** HF or VHF/Single or Multiple Operator

**Section:** Transmitting Phone, CW or Open

**Total Score:** number of points claimed

**Declaration:**

I hereby certify that I have operated in accordance with the rules and spirit of the Contest.

**Signed:** *Your signature if log is submitted via mail.*

**Date:** 20 August 2006

## Sample Transmitting Log

### Remembrance Day Contest 2006

Callsign: VK1xxx  
Category: HF or VHF / Single or Multiple Operator  
Section: Transmitting Phone, CW or Open

Time (UTC)	Band (MHz)	Mode	Call	Number Sent	Number Rcvd	Pts
0801	14	SSB	VK2QQ	001	002	
0802	14	SSB	VK6LL	002	001	2
0806	14	SSB	VK5ANW	001	003	1
0808	14	SSB	ZL2AGQ	004	004	2
0811	14	SSB	VK4XX	005	008	2

## Example Receiving Log

Name/SWL Nr:

Category: HF  
Section: Receiving Phone:

Time (UTC)	Band (MHz)	Mode	Call Op	1st Op	Call 2nd Op	Number 1st Op	Number 2nd Op	Pts
0801	14	SSB	VK1XXX	VK2QQ	001	002	1	
0802	14	SSB	VK1XXX	VK6LL	002	001	2	
0806	14	SSB	VK5ANW		001	003	1	
0809	14	SSB	VK7AL	VK2PS	007	010	1	

## Links to Computerised Logging Programs

NOTE:- Please check your favourite website for current versions, as most of the programmers are now doing a rewrite, to allow for this year's rule changes.

From Mike Subocz VK3AVV, the VK Contest Log (VKCL) can be found at the following URL:

<http://web.aanet.com/mnds>

From John Drew VK5DJ RD logging program can be found at the following URL

[http://vk5dj.mountgambier.org/Amateur\\_radio.html](http://vk5dj.mountgambier.org/Amateur_radio.html)

From James McBride VK6FJA WinRD+ logging program can be found at the following URL

<http://www.rjmb.net/rd/index.htm>

# ALARA CONTEST 26 & 27 August



## Become a radio amateur

Check out the courses on offer from Australia's premier training institution for radio amateurs and hobbyists.

## Already licenced?

Upgrade to the Standard licence using our self paced multi-media CD ROM course. The easiest way to become a licensed radio experimenter.

Discover digital communications, get more power and more bands

## Still want more?

Be guided by one of our experienced facilitators using our proven on-line study methods and get your Advanced licence.

## Visit

<http://www.radioelectronicschool.com>  
for more information,  
or email the course manager at

[info@radioelectronicschool.net](mailto:info@radioelectronicschool.net)

Telephone 07-5573-2795 12-5PM AEST

Amateur radio – a bridge to careers in radio communications technology

## Are you managing the estate of a 'Silent key'?

Please save any QSLs for the National QSL collection, but first contact:

The Hon. Curator,

Ken Matchett VK3TL

on (03) 9728 5350

or email: [jeandawson@iinet.net.au](mailto:jeandawson@iinet.net.au)

Rare DX, special call-signs prefixes and suffixes, pictorials and pre-war QSLs are needed.

Let us save something for the history of amateur radio.

## The Gippsland Gate Radio & Electronics Club Hamfest Sale

22 July 2006

Cranbourne Community Hall,  
Cranbourne

Contact  
Dianne Jackson VK3JDI  
on (03) 5625 2545

# Preparing for the Subaru Rally of Canberra 2006 A WICEN Event

A correspondent from VK1

The alarm jolts me awake in the pre-dawn darkness. As my mind struggles to adopt a working state, I think "What on earth? But it's the weekend!" Then I remember – Canberra region's WICEN is providing safety communications for the Subaru Rally of Canberra (colloquially known as "ROC"). Last night I was up late, loading my vehicle with everything needed for independent communications operation out in the bush. I drag myself out of bed and stumble towards the shower.

An hour later with a lightening eastern horizon, I'm driving towards a "Meet Point" somewhere in the forests near Canberra. This year ROC is running "Special Stages", or competition stages, in Kowen Forest and the hills around Tidbinbilla. (There are other stages such as Transport Stages which connect Special Stages.) My first task upon hitting the road is to call our Net Control Station, VK1WI, at Rally Headquarters. The familiar call signs and voices of other WICEN operators come up on the VHF repeater travellers' net as they too take to the road, or arrive at their allocated meet points. The real early birds among us conduct radio checks from locations in their respective special stages.

Another call to VK1WI upon arrival at the meet point for my special stage, where I find a growing group of rally volunteers – the advance team, the stage commander and his deputy, various post chiefs, time control officials, road closure marshals, SOS radio operators (us), flag marshals, and others. They are of all ages and come from all walks of life. Some familiar faces from previous ROCs appear – there's my post chief from last year. It's good to be working with people who've seen our capabilities and expertise in action.

Confusion reigns supreme; but the advance team soon signs us up, issues the equipment and paperwork, and orders volunteers' vehicles into convoys for insertion into the stage. Not all of our SOS radio operators are in my convoy. The others, including one each for the stage's Start and Stop points, are in convoys which will access the stage via other routes more convenient to their operating locations. The WICEN vehicles are a variable lot, but they wear the same uniform: various antennas; a large magnetic sticker on the roof or hood showing the SOS position



WICEN were not the only ones "on the air" at the Subaru Rally of Canberra 2006.  
Photo courtesy of rally.com.au

designator; the small, yellow "Rally Official" sticker; and of course the green WICEN and Canberra Region Amateur Radio Club (CRARC) signs. While the advance team sorts out some last-minute details, the operators stand beside one of the cars, chatting, occasionally pausing to listen to a "handheld", awaiting the order to move.

As our convoy moves off, VK1WI receives another round of calls to tell them what's happening. Soon we're on the dirt, and I engage low ratio 4x4 to tackle the hills. We're actually driving along the rally course, the "competition surface", and I wonder at the skill required to keep a rally car flying along this narrow, twisting, undulating, loosely-surfaced forest road. (Later, when the first competitor cars finish this stage, we discover that their average speed over the course was approximately 100 km/h.) While we're driving, I "read the mail" by listening to a net running one of the special stages

before ours. It's good to hear some of our new Foundation licensees experiencing their first ROC as WICEN operators. One of them nearly has a baptism of fire: "Rally car on fire at my location!" Thankfully it's only a blown engine – an early casualty in a traditionally trying and testing rally. The fire is extinguished, and everyone is safe.

Our stage commander detaches my flag marshal and I from his convoy at SOS point "Charlie". A quick check with the GPS receiver, compass, and "topo" map gives us reference points for reporting anything out of the ordinary. That weird-looking tree on the ridge over to the left is north. I park my vehicle in a safe spot away from the "run-out zone" where an out-of-control rally car might veer, and conduct a radio check. "Roger, please QSY to the portable VHF repeater." I go there, call in, receive a signal report,

*continued next page*

# What would you have said?

Jinkin (Jay) Frame

**At the DXCC Club (DX & Contest Club) meeting last week, chatting with Alan, one of the newer members, who has just received his Novice License, the subject of Dxpeditions came up – it always seems to these days!**

Alan said that he had been concentrating on his CW (great news – the Club needs more CW operators) and came across a big pile up on 14MHz. After a little time he managed to get the call of C21SX: not because the station was weak – but sending a lot faster than he had tried to copy before. Further listening he ascertained that the DX station was listening 1 to 2 kHz up for Europe.

Moving the receiver to listen 1 to 2 up to see what he could hear, he was amazed to find many non-European stations calling. “Surely Jay”, Alan said, “they were copying the C21 as well as he was, who clearly requested Europe only”. On one occasion when the DX went back SM0? Then lots of other EUs were calling as well as JAs – but why? The reports that

the European stations had been giving were 599 so they were obviously copying the C21SX without any difficulty and knew he was trying to QSO SM0.

Well Alan, chasing DX in recent years has changed a lot, and many would say not for the better. There seems to be a tendency these days to give a report of 599 even if you are genuinely copying at only 539. It is now very rare to get a genuine report – listen to any big contest and the exchanges are nothing other than 599 plus the rest of the data required be it a serial number – age – or zone.

Was it always like this? Well, no. Going back quite a few years everyone was crystal controlled and you called CQ and then listened plus or minus 15/20 kHz for a reply. Then came the VFO and people

started replying on the calling stations frequency. Also at the demise of crystal control, band occupancy increased so using one frequency for a QSO was a good idea. At about the same time bigger antennas starting to be used – beams and towers were beginning to be “essential” to the serious DXer. Receivers were improving as band occupancy increased and coupled with better antennas at the sunspot minima the bands were not as “dead” as they had been in the past. These “improvements” emphasised the competitive nature of DXing for Certificates and Plaques. So, we have ‘progressed’ to the situation you heard on 14 MHz. Unfortunately that is how things are today and I can’t see them changing.

What would you have said?

ar

## Preparing for The Subaru Rally of Canberra 2006 *continued*

and am told almost immediately to QSY to another fixed VHF repeater. Someone at HQ is trying out some “just in case” communications scenarios, which is not a bad idea. This repeater is harder to hit from here, so many of us unpacked and set up higher power radios and better antennas, but even so the reports on the net are generally “readable but noisy”. HQ moves us all to yet another repeater where a net running an earlier stage is in the process of finishing up.

Some of us are a bit rusty on operating in a directed net, but the radio checks and time checks soon settle everyone down. The radio chatter stops when the Start point operator reports the Course Car entering the stage. One by one the SOS points report the car’s relatively sedate progress. It stops at our point and the crew egress to make sure all is in order. Yes, we’re located in a safe spot, the SOS point designator sign can be seen by the helicopter, the “lightning flash” signs are in the correct places on the “approach” side of the course, there is a radio operator and a flag marshal present, I have a working communications link and the correct paperwork, and the “flaggie” has the yellow “caution” flag safely stowed out of competitors’ sight until needed. Satisfied, the car drives on further into the stage while I advise HQ of its departure.

After what seems an age – really only 20 minutes after the course car started – Start reports the “Triple Zero” car entering the stage, followed 20 minutes later by “Double Zero” as the second part of a double act. They roar past our point with flashing lights and blaring “wah-wah” sirens. Triple Zero reaches the Stop point, and the call comes through: “All stations, this is Rally Control. Your stage is Amber; I say again, your stage is Amber. Acknowledge!” The crisp, clear, well-ordered stream of replies shows the net has settled down to work as a team. The last of the official cars – “Zero” – flies past looking and performing very much like a rally car at near-competitive speed, throwing up a cloud of dust which swirls around but thankfully drifts away from us. I hope the wind doesn’t shift much during the morning. Meanwhile, Double Zero has reached the Stop point, and the stage goes “Green” – it’s on!

Start calls to inform us of the first competitor car entering the stage, followed by “Be advised they’re starting on two minutes intervals, over.” Traffic on the radio net resembles a prolonged silence punctuated with increasingly frequent but brief, business-like to-and-fro interchanges as more competitors start the stage. SOS Alpha reports Car

1 passing; and a few minutes later SOS Bravo follows suite. We’re next! At SOS Charlie you can cut the expectant silence with a knife; the bush is fiercely quiet in the mid-morning heat: no movement, no birds, no voices bar the radio with its minimalist reports. Then we hear it – a faint, distant, echoing series of sounds, akin to an axe hitting a tree, or a gunshot. “Turbocharger?” suggests my flaggie. In the valley immediately to the southeast we see a fast-growing tendril of dust rising from the forest, like smoke from a long, narrow, rapidly-moving fire. “They’ll be here in less than a minute!” I glance at the clock yet again: is it still working? It is, but each second seems to take an age... tick ... wait ... tick. An eerie whistling sound overlaid with the echoing staccato barks of backfiring grows louder and louder; the rally car bursts into view through the trees, engine roaring with 170 kW worth of determination; then desperate, crackling deceleration to take the sharp right-hand bend away in front of us. There’s a shower of gravel as the driver takes the curve with an admirably clean line, a vicious snarl of acceleration, and the car vanishes over the next crest in a cloud of dust. “Rally Control this is SOS Charlie, over!” “Send, over.” “Car 1, over!” “Roger, Car 1. Out.” So it begins.

ar



## Weak Signal

David Smith - VK3HZ

Winter has struck with a vengeance over the last few weeks, with record low temperatures in many areas in the south of the country – not exactly the sort of weather to be out in the shack. Despite the cold temperatures (or perhaps because of them) we have had a few periods of enhancement caused by slow moving high-pressure cells.

Colin VK5DK in Mt Gambier reports that on 13/5 at 0910Z, he worked Leigh VK2KRR at The Rock on 2 m with steady signals up to S9 and also made contact on 70 cm at 0925Z with signals peaking to S5 and deep QSB. Leigh also worked Brian VK5UBC at Gawler on 2 m (56) and 70 cm (41) and Garry VK5ZK at Goolwa on 2 m (58).

On 22/5, weather conditions produced more good propagation with VK5 stations working far into VK3 and VK2. At 0150Z, Peter VK5ZLX in the Barossa Valley was worked from this QTH in Melbourne on 2 m (57) and 70 cm (41). The opening continued for the whole day. That evening at 0816Z, Phil VK5AKK in Adelaide was worked on 2 m (57) and 70 cm (52).

On 12/6, a slow moving high produced good conditions that started across the south of the country and, over the next few days, gradually moved to central NSW. Peter VK5ZLX reports that on 12/6, the 2 m and 70 cm beacons in Geelong were good strength virtually all of the day, but he could only raise Bill VK3WN in Ballarat. The next morning at 2150Z, Mark VK2EMA in Tottenham in central NSW was receiving the Adelaide 2 m beacon on Mt Lofty at S9+20. Mark worked Garry VK5ZK on 2 m (57) and 70 cm (59). He also worked Brian VK5UBC on FM on 2 m (57) and 70 cm (52). The Mildura 2 m beacon was being heard by Rob VK1ZQR in Canberra. That evening, at around 0830Z, the Mt Lofty beacon was still S7 at Mark's QTH. Peter VK5ZLX worked Rhett VK3VHF in Gippsland on 2 m digital. He then worked Rhett on SSB. On the morning of 14/6 Mark VK2EMA again worked Garry VK5ZK with S9+ signals on both 2 m and 70 cm. The Mt Lofty beacons were now even stronger on 2 m (S9+40), 70 cm (S9+30) and 23 cm (S3). However, there was no sign of

the Adelaide beacons from the Melbourne area. Mark again worked Garry VK5ZK at 59+ levels on both 2 m and 70 cm. He also worked Peter VK5ZLX on 2 m and 70 cm and they attempted a contact on 23 cm but didn't quite make it. The following morning (15/6), Mark worked Phil VK5AKK on 2 m (55) and 70 cm (59), Peter VK5ZLX on 2 m and 70 cm (both 59+) and Garry VK5ZK on 2 m (57) and 70 cm (59). He also again worked Brian VK5UBC at Stony Point on FM on 2 m (57) and 70 cm (52). Finally, the weather moved on and the opening was over.

Rob VK3EK near Bairnsdale reports that on the evening of 13/6, "I was alerted by Rhett VK3VHF at 1010Z that he was working Peter VK5ZLX in the Barossa Valley on 144.225. They had been playing Digital and ended up on the real stuff (tongue in cheek). I didn't have any VHF gear running at the time but that soon changed and I also worked Peter up to S7 over about a 10-minute period. I had to go or we could have kept going. The distance is 851 km over a difficult path with the Baw Baw ranges directly in the way less than 100 km from me. This is a rare contact for me and the path only

seems to open when there is a large high-pressure cell in the system like the one at the time of contact (see chart). We tried on 70 cm but I could only just tell there was a voice in the noise. Thanks to Rhett VK3VHF for alerting me, and Peter for being there. It pays to keep an eye on the (VK/ZL) logger as well.

## Aircraft Enhanced Propagation

Many stations continue to "play the aircraft" during the daily AE net. Of course, the aircraft continue to fly all day, but the peak operating activity between Melbourne, Canberra and Sydney occurs between about 0815 to 0900 EST, corresponding to the morning rush hour of flights on that path. On one day recently, Rob VK1ZQR noted the following stations on 144.2 - VK2DO, VK1CJ, VK1BG, VK2RS, VK2AWD, VK3VZP, VK3HY, VK3AFW, VK3HZ, VK3BJM, VK2TG, and VK2KGX. To that list, I'd also add VK2TP, VK3VG, VK3AXH and VK3AZG as regulars. There is also activity to the north between Sydney and Brisbane, which I understand

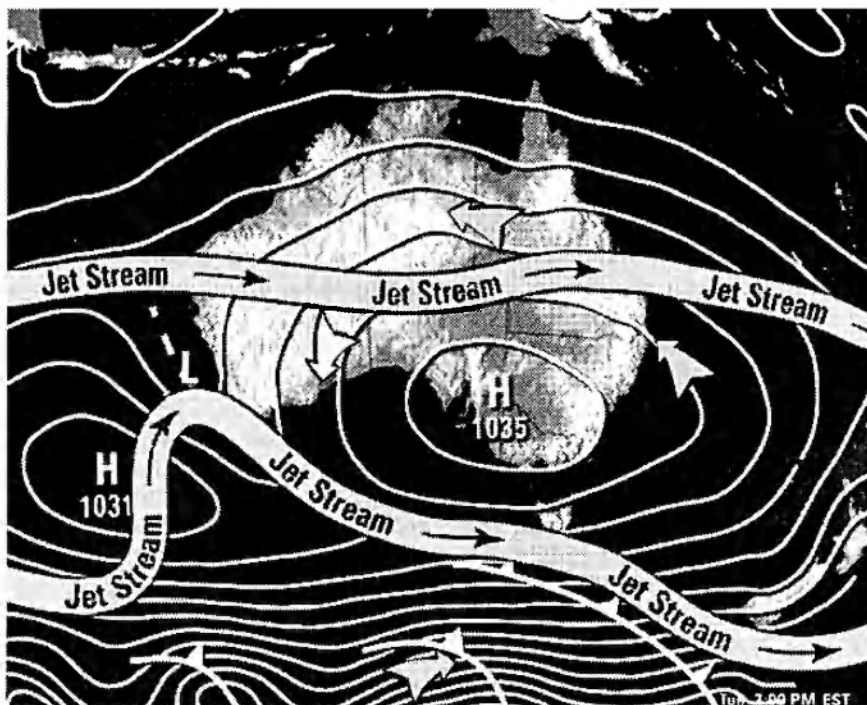

Weather Chart for 13/6

occurs earlier in the morning.

Of course, AE is not limited to those paths. Any path between two stations that is crossed by an aircraft will see some level of enhancement. Ian VK3AXH in Ballarat and Garry VK5ZK in Goolwa have been experimenting with AE between their locations using the Melbourne / Adelaide flights. A large aircraft crosses the path each day at about 0830 EST and provides some level of enhancement between Garry and, at different times, Ian, Barry VK3BJM, Jim VK3II and David VK3HZ. Unfortunately, the flight path is not aligned to provide AE into the more populated Adelaide area.

## 150 Net

The weekly net at 2030 EST each Wednesday, hosted by Rob VK3EK near Bairnsdale, continues to attract many participants. The net has been run by Rob since October 1999, and existed prior to that. It commences on 144.150 MHz and moves up through the bands as far as 2.4 GHz, if people are interested. A recent net (mid-winter) had the following participants – VK3EK, VK3AXH, VK3IDL, VK3KQB, VK3ALA, VK3XL, VK3NF, VK3HZ, VK3DMW, VK3ZYC, VK3VZP, VK3VHF, VK3HV and VK3KAI. It would be good to see people in other states start up a similar regular VHF/UHF activity net.

## Digital DX Modes

**Rex Moncur – VK7MO**

JT65 is starting to make its mark on 1296 MHz EME where it allows relatively modest stations with 100 Watts and dishes of 2 to 3 metres diameter to work each other. VK4AFL - 3.7 metre dish - and VK7MO - 2.3 metre dish - have worked each other on 20 watts. A big advantage of 1296 MHz is that one can get good gain from relatively small antennas. In addition, as almost all stations use circular polarization, one does not have problems with cross polarisation as often occurs on the lower bands due to Faraday rotation and Spatial polarisation offsets. External noise is also significantly lower. The disadvantages are that few commercial rigs are sufficiently stable to gain the full benefit of JT65 and one needs to find ways to improve stability such as by locking reference oscillators to GPS. Cable losses must be an absolute minimum and dish mounted pre-amps are a must. On receive, one can achieve

## EME

Congratulations to Alan VK3XPD in Burwood who recently achieved the first VK EME contact on 5.7 GHz, breaking a world record in the process. Alan reports:

“On May 23, 2006 at 0225 hours UTC, a new World Record distance of circa 15,931 kilometres for a 5760 MHz EME contact was set by myself - Alan VK3XPD - and the Czech Republic’s OKIKIR EME Team of Vladimir OK1DAK, Tonda OK1DAI and Jan OK1VAO. This QSO is also the first ever 5760 MHz EME contact for Australia.

Signal Reports were “O” Copy from VK3XPD & “M” Copy from OKIKIR.

The OKIKIR station uses circular polarisation with a 60 watt solid-state PA feeding a 4.5 metre dish. The VK3XPD station uses a VE4MA Feed, horizontally polarised with a rear dish mounted TWTA feeding a 3 metre dish. It is fully coaxial (coax relay at the feed) because no waveguide bits were available at the time, so my in-circuit losses are somewhat higher than they could be.

The event was also not without it’s problems. My TWTA recently developed an RF output problem, which resulted in the output power dropping (varying slowly and unpredictably) by up to 10 dB from the maximum available output of about 100 watts. Additionally, there were

overcast conditions (no visible Moon) in VK and very poor wet weather in the Czech Republic at that time. I’m hoping to resolve my TWTA difficulties soon and chase a few more QSO’s shortly.

My thanks to Vlad and his OKIKIR Team for persisting.”

Interestingly (and coincidentally), the contact occurred 30 years to the day after the first ever EME contact from OK, which was also made by OKIKIR on 70 cm.

## ATV

Good to hear of some ATV activity in the upper microwave region, with impressive results. Jack VK2TRF reports:

“Dan VK2GG and I are now active on 10 GHz ATV. We are currently using 200 mW into 17 dB horn antennas about 20 cm long. Operation is on 10.236 GHz with an FM deviation of 15 MHz.

Our last QSO was from Dobroyd Point in Sydney to Wybung Head north of Norah Head lighthouse near Newcastle - a distance of 76 km.

We are planning the construction of 60 cm dishes with penny feeds, which will increase our antenna gain to 30dB plus. However, the extra gain comes at a penalty of a 4-degree beamwidth.

Please send any Weak Signal reports to David VK3HZ at vk3hz@wia.org.au.

system noise temperatures of 100 degrees or less but even the temperature of light tree cover can mask this so a clear view of the moon well away from the horizon is essential. The effects of Doppler frequency variation, primarily due to Earth rotation, and frequency spreading due to Moon libration all add to the difficulty at this frequency.

The JT65c sub-mode is more tolerant of frequency instability and is almost universally used on 1296 MHz. The use of short-hand messages is not as effective as on the lower bands due to libration frequency spreading and frequency drift and it is better to send OOO, RO, RRR and 73 as text in place of the grid square. This is an alternate format available with the JT65 mode. Because of the effects of libration, the limiting factor is normally to achieve sync – once sync is achieved one will often achieve decodes without the use of the JT65 deep search decoder.

Most JT65 activity is in the frequency band 1296.065 to 1296.085 with a trend to use 1296.065 as a focus frequency where you have the best chance of seeing someone.

There seems to be scope to improve the effectiveness of JT65 on 1296 MHz though automatic correction for Doppler and a decoding algorithm that takes account of the frequency spreading due to libration. If these issues can be solved a further 4 to 6 dB performance improvement may well be possible. There is every possibility that within the next year or so newer versions of the WSJT program will make 1296 MHz EME available to stations with a few 10’s of watts and relatively small dishes of 2 metres diameter.

Please send any Digital DX Modes reports to Rex VK7MO at rmoncur@bigpond.net.au.

*Continued next page*

## International: CEPT Licensing

A growing number of countries have adopted the new CEPT amateur radio arrangements at Novice and/or Intermediate level. More are coming on board the scheme on a regular basis.

In amateur radio circles, CEPT refers to the European Conference of Postal and Telecommunications Administrations Amateur Radio licensing system. Holders of a CEPT-endorsed license can operate in participating countries without having to apply for a reciprocal license. Which nations are not signed on can be viewed at the CEPT Implementation status page. The URL is in cyberspace at:

[www.ero.dk/documentation/docs/implement.asp?docid=2136&wd=N%20](http://www.ero.dk/documentation/docs/implement.asp?docid=2136&wd=N%20)  
(ARNewsline 1501)

## Education:

### USA survey says science teaching is bad

A survey taken to encourage females and minorities to pursue science gives the nation's public schools a C-minus grade.

The survey, released May 3rd, is based on a telephone poll of 100 chief executives, chief financial officers and other leaders in fast-growing science and technology companies in North America.

It finds that 82% believe elementary school students learn science through hands-on, inquiry-based methods rather than through textbooks and memorization. But the survey also finds that only 37% of these executives say their companies or employees support science education programs that help create the next generation of inventors, innovators and discoverers.

The poll was sponsored by Bayer Corporation as part of its Making Science Make Sense program.

(ARNewsline 1501)

## Canada:

### Morse on exhibit at Toronto Airport

How soon does it take to make something an antique?

It's only a couple of years since Morse became obsolete as a communication system and now it's on display at Toronto Airport to demonstrate a collection of manual and automated systems used for transmitting Morse code, including little known devices such as the siphon recorder and the heliograph, as well as rare examples of early radiotelegraph equipment employed on ships before the First World War. The artifacts are accompanied with bilingual text and

historic photographs of telegraphers and radio operators at work, bringing to life the mysterious language of dots and dashes. It won't be long before we CW operators become artifacts!

More is on-line at [www.gtaa.com/artprogram](http://www.gtaa.com/artprogram) (Royal Ontario Museum)

## Germany:

### A change to entry level licence

German telecommunications authorities have made significant changes to the entry level Class E amateur radio licence. Class E holders now have access to the HF bands and can run up to 75 W output on the 160, 80, 15 and 10 m bands.

The German approach to entry level licensee holders is different from other nations. Rather than giving newcomers access to all bands but at very low power, Germany has decided to offer them reasonably high power levels but restrict the spectrum that they can use.

Meanwhile, German Class A licence holders have been allocated the 7.100 to 7.200 MHz segment of 40 meters on a secondary basis with a power output of 250 watts. German amateurs can now also use the 50 MHz band. Finally, a restriction on the use of 1,260-1,263 MHz has been lifted.

(GB2RS)  
ar

## VHF/UHF continued

### The Magic Band – 6 m DX

Brian Cleland – VK5UBC

After a few quiet months on 6 m, particularly in the southern states, the band began bursting into life in late May and early June with some excellent winter sporadic E openings.

After hearing the ZL TV on the previous 2 days, Norm VK3DUT worked Peter ZL4LV on the 1st June at 5/9. Then on the morning of the 2nd June Norm reports very good conditions into VK5 with both the Barossa VK5RBV and Adelaide VK5VF beacons strong and contacts with Keith VK5AKM and VK5BM. Norm also worked Paul VK2YVG at Broken Hill at 5/9+ and Joe VK7JG in Launceston.

On the same day (2nd June) as well as working Norm, Keith VK5AKM from Wasleys 50km north of Adelaide had good contacts with George VK3HV, Tim

VK3ALA and Rob VK1ZQR. Later that day Col VK5RO and Brian VK5UBC worked Allan VK4ID and Bob VK4BT.

On the 6th June Norm VK3DUT was at it again this time working several VK4's and the a little later ZL3AUU and Rod ZL3NW.

On the morning of the 8th June, an exceptional opening occurred with the band open from New Zealand to VK2, 3 & 5 and from VK3 & 5 to VK6. At the same time the Alice Springs and Hobart beacons were being heard in VK3 & 5. From VK5 Ian VK5AIC and Brian VK5UBC were in the thick of the action working Bob ZL3TY and Rod ZL3NW whilst Norm VK3DUT was 5/9++ in VK5 and ZL. Rob VK1ZQR and Mike VK2BZE were also working both the

ZL and VK5 directions. Despite many calls no contacts were made into VK6 or 7, although both the Perth and Hobart beacons were over S9 into VK3 & 5.

From northern Queensland, John VK4FNQ reports hearing several JA beacons on the 3rd May and working JR2ULS and JI5OZF at 5/9. On the same day Gary VK4ABW worked several JA's as well as Korean stations HL0NHQ and DS4OVT. John also reports hearing the VK2 Sydney and Hunter Valley beacons on 27th & 28th May.

I was sad to hear that John VK4PU passed away in late May. He will be missed on 6 m.

Please remember to send any 6 m information to Brian VK5UBC at [bcleland@picknowl.com.au](mailto:bcleland@picknowl.com.au).

# Hamads classified **FREE**

## FOR SALE NSW:

BOOK: "Radiotelegraph and Radiotelephone Codes, Prowords and Abbreviations" 3rd Edition (236 pages), 610 gm, 1.5 lbs, now available. Probably the world's best compilation of this info now available. Q,X,Z Codes, 142 Phonetics, 24 Morse, 8 Needle codes. Myer, Phillips, 10, 11, 12, 13 and other codes. Much other info, abbreviations, procedures and methods. AU\$25 + P&P (in Australia \$7.50) Internet: <http://www.nor.com.au/community/sarc/phonetic.htm> John Alcorn VK2JWA, QTHR, Ph +61 - 02-66215217 vk2jwa@sarc.org.au

Broadcast and Satellite Equipment. We are selling all the following equipment plus many other small items. 3.8m satellite dish \$150. 2.4m satellite dish \$25 Dual polarity Low noise amps [Ku and C band] \$30. Feed horns Ku from \$35. Satellite Receivers From \$25. Tandberg satellite Rx. \$550. VHF/UHF linear Amps From \$50. CATV - MATV mods. Channel Amp \$25. Bmac Encoder/Decoders \$50 ea. Spectrum Analyser [AVCOM] 10MHz-4Ghz \$350. SSB HF 100W Trans. Rx. \$250. PS for above [25A] \$250. Satellite Phone Inmarsat mini M \$250. Satellite Phone Inmarsat B [64k] \$450 ICOM HF Rx. R71A \$250. TV Field Store FORTEL \$50. TELETEX decoder \$50. TV translator Ch 6 to Ch 12 25 watt \$10. AM radio transmitter 400W solid state 1.4 MHz \$2000. 27 MHz direction finder [accurate] \$100. MPEG 2 Encoder/MUX/Encoder MCPC offers. RF output transistors and parts etc offers. UHF CB Yagi \$75. Many other cables and parts. Please ask for John 0428 287 930 02 9652 1269 Location Glenorie NSW VK2YTX

## WANTED NSW

Interface TRX to computer for PSK type applications. Prefer commercial unit such as Rigblaster or MFJ1275. Ph 02 4232 2842, email vk2bes@tpg.com.au

Full data for 10.7 MHz crystal filter AWA model no 5Q 62099. Contact Pat Brennan VK2ABE PO Box 158 Tamworth NSW 2340 or email patmbren@ceinternet.com.au

## About hamads....

- Submit by email (preferred) or on the form on the reverse of your current Amateur Radio address flysheet. Please print carefully and clearly, use upper AND lower case.
- Separate forms for For Sale and Wanted items. Please include name, address STD telephone number and WIA membership number if you do not use the flysheet.
- Deceased estates Hamads will be published in full, even if the ad is not fully radio equipment.
- WIA policy recommends that the serial number of all equipment for sale should be included.
- QTHR means the address is correct in the current WIA Call Book.
- Ordinary Hamads from those who are deemed to be in general electronics retail and wholesale distributive trades should be certified as referring only to private articles not being re-sold for merchandising purposes.
- Commercial advertising on these pages Contact Newsletters Unlimited.
- Copy typed or printed clearly please, and received by the deadlines shown on page 1 of each issue of Amateur Radio.

Email: [newunltd@bigpond.net.au](mailto:newunltd@bigpond.net.au)

Postal: Newsletters Unlimited, PO Box 431, Monbulk Vic 3793. Fax: 03 9756 7031

### TRADE PRACTICES ACT

It is impossible for us to ensure that the advertisements submitted for publication comply with the Trade Practices Act 1974. Therefore, advertisers and advertising agents will appreciate the absolute need for themselves to ensure that the provisions of the Act are strictly complied with.

### VICTORIAN CONSUMER AFFAIRS ACT

All advertisers are advised that advertisements containing only a PO Box number as the address cannot be accepted without the addition of the business address of the box-holder or seller of the goods.

1 only UI AM-FM unit to suit ICOM-725 HF transceiver (new or second hand in working order) 02 4295 1227 after 4pm or email [cannan\\_richard@optusnet.com.au](mailto:cannan_richard@optusnet.com.au). If someone has one they can either phone me or email me with price etc.

## FOR SALE VIC

Marconi TF2300B AM/FM mod meter, 4 to 1200 MHz \$150. Email for pics and details. AWA 25-M LB VHF mob, mod for 6M FM, was working, probs with Xtal osc's ("JAN") Free to good home! Terry VK3ZXY QTHR 0419 300 899 email vk3zxy@leithy.com

Receiver BC-348R., original condition, no mods and own dynamotor \$360. BC224D, the 12 V version of the BC-348. This one a bit rare as it omits the 200 - 500 kHz band and made by RCA. Original condx with own dynamotor \$390. Plug PL-P103 for the rear connector of the BC-348 new in box \$50. HF transceiver ARC-38 (not xtalised version) and ARC-38A. Each of these xcvsr have their own dynamotor, control box. \$220 for each. Control box 313V-1, mounting rack and cable for the HF transceiver 618 T \$160. VHF receiver aircraft band R 502 made by ARC complete with tuning cable, control head and dynamotor \$160. VHF aircraft transceiver Marconi TR1934 complete with plugs and control box \$60. 2 only BC-1206 range receivers... \$60 each. AN-ARC 49 VHF tx/rx combination -no control box /dynamotors 2 available \$50. Hewlett Packard #5061A caesium Beam Frequency standard. This instrument is faulty in that the caesium resonator is probably U/S. The internals and xtal standards are operable as is the Patek Philippe timer clock - best offers for each. 3 available. All items do not include freight. Reply to Pete Williams VK3IZ 03 5156 2053 or [jupete@bigpond.net.au](mailto:jupete@bigpond.net.au)

Shimizu HF transceiver 10W on 80.40.20. 12V or 240V operation. Ideal stater rig for "F" Licence \$120. John VK3BAF 03 8502 8627 or email vk3baf@feack.com.au

## WANTED VIC

For a Wireless Set No 11 - Two 10 pin female and two 3 pin female power plugs. Also need spare sockets with some good pins to suit these plugs. Four 12SG7 valves in good condition. Slugs for R1155 Rx front-end or remains of front-end with slugs. Heathkit IT-11 or IT-28 capacitor tester. DF loop for MN-26 compass receiver. Clem VK3CYD 03 5126 2064 [clem@dcsi.net.au](mailto:clem@dcsi.net.au)

Parts for military radio: I am looking for the parts to restore and complete my AN/TRC24 radio system. I am looking for the following:- Transmitter, T-302/TRC. Power Supply, PP-685/TRC. Receiver, R-417/TRC. "A" Band tuner, AM-1180/GRC. Amplifier/Converter, AM-2537/TRA-25. And any other bits and pieces or books/manuals for this radio. John Eggington VK3EGG Email [johne@telpacific.com.au](mailto:johne@telpacific.com.au), mobile:-0409 234 672, ph 03 9819 9065

## FOR SALE QLD

Super QTH. VK4UA views over Gold Coast 1 acre elevated. Near new Nally 3 section winch tower to 75 feet with 3B,6el HF beams tilt over. Luxury 4BR BV, 2 big car garage 320m. 2 of 9x6 metal sheds, own water and sewer \$690K or with extra 7.4 acres (31 prestige blocks) \$2.8M OBO. Now for the gear. HAL/CRFR SR150 5B 100W transceiver \$180, PSU \$70, Star 700A RX 10B \$140, Heathkit HX20TX 60W 5B \$90, BC348J with selectable 85kC 2nd IF \$190 PSU \$50 Diawa 700A rotator and control \$200. XTAL 9 MHz filter in can with three Xtals \$40, valves metal and miniature 25¢ each many parts 100s of magazines free. All items SSB with handbooks at Pimpama 07 5546 7041

CODAN Mobile H.F. Outback Radiophone, Type 8528, S/No. B5110 with Amateur Option (3.5 to 29.7 MHz) and RFDS Emergency Call. Matching Codan automatic tuning whip antenna type 8558, S/No. D3785. Remote control head, cables, microphone, speaker and handbook. All for \$1500. Ken Riding, VK4CKR, QTHR, 07 5529 1646, 0412 615 317, email [kwr@optusnet.com.au](mailto:kwr@optusnet.com.au)

IC-T90A, as new, impulse buy, no longer active. Serial nr-0701156. Receipt. Call Tim VK4CBP on 0418719123 prefer mornings, shift worker. Brisvegas. Paid \$538, make (sensible) offer... You will need a callsign.

## WANTED QLD

To Whom It May Concern. I seen your ad in the amateur radio. I own a yaesu FT-225RD all mode 2 metre transceiver I have been looking for a long time for a Freq.counter for it but no luck getting one for it. The one that's in it now won't stay stable on the last 3 digits and I can't seem to get anyone to put it right. I have had it for many years, it's a nice old timer and in very good condition for its years, just the freq counter at fault. It was made around 1980 might be 1982. So I wonder if you could help in anyway to get one or you might know where there is a rig going for spare parts. I would be very pleased if you can help out I will pay all costs no problem. My name is Roy and my call sign VK4NEC and my email: [rec@dodo.com.au](mailto:rec@dodo.com.au) hope to hear from you soon. Kind regards and thanks again. VK4NEC. Roy.

**FOR SALE SA**

VK5JST Antenna Analyser kits. [see AR article May 2006] For details contact SCARC PO Box 333 Morphett Vale SA 5162, or email: kits@scarc.org.au

**WANTED SA**

Copy of manual or circuit diagram for a Marina 60, AM transceiver (24 volt version preferred), made by Ferris Bros part of the Hawker Siddeley Group. Willing to pay any costs. Malcolm Haskard VK5BA QTHR Ph 08 8280 7192, Email - mhaskard@chariot.net.au

**SITUATION VACANT:**

Relief engineer at a cancer research and treatment facility.  
The person shall have AOCPP or BOCPP qualifications and be familiar with UHF high power valve transmitters.  
The position is casual part time and may suit a retired person from the communications industry, resident in Perth area.  
Contact Bill Macham VK6II on 9296 0137 or westwill@dodo.net.au

**Compiling a family history?  
Perhaps writing a tech manual?**

We can assist in all stages of the print and or electronic production.  
You will end up with a professional product at a price better than you can arrange yourself.

Ring John, 03 9756 7797

for a chat about your project.

Our clients include WIA (Amateur Radio and Callbook), Monash and Deakin University, APESMA and a host of other organisations and individuals.

The smallest book job we've done was six copies of a 90 page perfect bound A5 family history, the largest job 5000 copies of a Wiro bound 400 page B5 drug usage guide.

We can handle the mechanics of your project so that you can concentrate on the content.

**NEWSLETTERS**  
Unlimited



**ADVERTISERS INDEX**

AEI.....	23
Amateur Radio Bookshop .....	39
Andrews .....	8
Benelec.....	IFC
Bookshop.....	19
Camera .....	22
Com-an-tena.....	28
TET-Emtron .....	17
Fast.....	23
G & C.....	9
Icom .....	OBC
Ozgear .....	29
Rippletech .....	22
TTS.....	16
Small ads.....	55
KVK Books.....	31
Winlink.....	29
White.....	23

**AMIDON FERROMAGNETIC CORES**

For all RF/electronic applications.

See our website for complete data on all cores including prices.

www.catchnet.com.au/~rjandusimports

**RJ & US Imports**

PO Box 431, Kiama NSW 2533.

A 3.5" PC disk containing all data is available for \$5.00 incl. post.

**Agencies**

- Active Electronics, Tas
- TTS Systems, Tyabb (VIC)
- Tower Communications, Perth
- Ozhelp Services, Brisbane

**RM Products Italy**

are now available in Australia after the appointment of

**Hamak Electrical Industries Pty Ltd**

as distributor for RM products

Visit the Hamak website at

**Hamak.com.au** for

**Linear amplifiers,  
Power supplies  
and accessories**

**THE WIA QSL COLLECTION  
REQUIRES QSLs**

All types welcome, especially rare DX pictorial cards, special issue. Please contact the Hon Curator, Ken Matchett VK3TL, 4 Sunrise Hill Road, Montrose Vic 3765, tel. (03) 9728 5350



**JACKSON BROS  
JACKSON OF THE OK IS BACK**

Highest quality products made by UK craftsmen [www.jacksonbrothers.com.au](http://www.jacksonbrothers.com.au)

Full range off-the-shelf in Australia.

Variable and trimmer capacitors, reduction drives, dials, ceramic standoffs

CATALOGUES, PRICE LISTS AVAILABLE

CHARLES I COOKSON PTY LTD

11-13 Port Rd

Queenstown SA 5014

Tel: (08) 8240 3200 Fax: (08) 8240 3233

FreeFax 1800 673355 within Australia

sales@jacksonbrothers.com.au

ALL MAJOR CREDIT CARDS ACCEPTED  
SOLE AGENTS AUSTRALIA AND NEW ZEALAND



**Tunable Loop Antenna  
enhances AM  
Reception**

AM radio reception (530 to 1900KHz) enhanced. Reception where none existed before; works indoors, even in interference-polluted areas  
High value — low cost.

Simple, no connections or batteries  
Ideal for touring, caravan, boat and fringe areas. Use anywhere.

[www.amradioantennas.com](http://www.amradioantennas.com)

pkloops@bigpond.net.au

Paul 0412 302 939

**PK's Loop Antennas**

**VIDEOEMAIL.**

Also Live Video Messenger and Conferencing for Teaching, Talks and Tutorials. Do away with websites.

Brand your Videoemail and watch your business skyrocket.

Put video on your eBay ads.

FREE 30 day trial

Email to: arecibo@bigpond.com

**VKHAM.COM**

**AUSTRALIAN AMATEUR RADIO**

Hundreds of pages and links related to Amateur Radio and radio in general

Home of:

- VK Classifieds
- VK Auctions
- VK's on the Internet

Repeater Maps, Software, Prefix Maps and more ...

*“Hey, Old  
Timer...”*



If you have been licensed for more than 25 years you are invited to join the **Radio Amateurs Old Timers Club Australia**

or if you have been licensed for less than 25 but more than ten years, you are invited to become an Associate Member of the RAOTC.

In either case a \$5.00 joining fee plus \$8.00 for one year or \$15.00 for two years gets you two interesting OTN Journals a year plus good fellowship.

Write to  
RAOTC,  
PO Box 107  
Mentone VIC 3194  
or call Arthur VK3VQ on 03 9598 4262 or Bill VK3BR on 03 9584 9512,  
or email to raotc@raotc.org.au  
for an application form.

**HAMADS ARE FREE**



# Directory

## The Amateur Service:

a radio communications service for the purpose of self training, intercommunication and technical investigation carried out by amateurs, that is, by duly authorised persons interested in radio technique with a personal aim and without any pecuniary interest. 1.56 ITU Radio Regulations.

*The Wireless Institute of Australia represents the interests of all amateurs throughout Australia.*

The WIA offers one year and 5 year membership for all categories except Concession Student. The fees for each category are: Full members \$75 (\$365), Overseas members \$85 (\$403), Concession members (pensioner) \$70 (\$332), Concession members (student) \$70, Full members no magazine \$50 (\$237), Family members \$40 (\$190)

### National Office

10/229 Balaclava Road,  
Caulfield North VIC 3161,  
PO Box 2175  
Caulfield Junction Vic 3162  
Australia

### Contact

Phone 03 9528 5962,  
Fax 03 9523 8191,  
10am to 4pm daily,  
nationaloffice@wia.org.au  
http://www.wia.org.au

### News Bulletin Schedule

Subject to change. See [www.wia.org.au](http://www.wia.org.au) follow National News prompts.  
Contact [nationalnews@wia.org.au](mailto:nationalnews@wia.org.au)  
National VK1WIA news is distributed to all states.

### Advisory Committees

#### VK1 Australian Capital Territory

VK1WX Alan Hawes  
VK1ZPL Phil Longworth  
VK1ET John Woolner  
VK1GH Gil Hughes

[vk1advisory@wia.org.au](mailto:vk1advisory@wia.org.au)

Sundays at 11.00 am

VK1WIA 7.128, 146.950, 438.050  
Canberra Region Amateur Radio Club Email newsletter will be sent on request to [president@vk1.ampr.org](mailto:president@vk1.ampr.org)

#### VK2 New South Wales

VK2QV Chris Flak  
VK2XCD Chris Devery  
VK2BFN Adrian Clout

Phone 02 9689 2417  
[vk2wi@ozemail.com.au](mailto:vk2wi@ozemail.com.au)  
[vk2advisory@wia.org.au](mailto:vk2advisory@wia.org.au)

VK2WI - Sunday 1000 and 1930 hours local. 1.845; 3.595; 7.146; 10.125; 14.170; 28.320, 52.525; 145.600; 147.000; 438.525; 1273.500 megahertz. Plus regional relays.  
VK1WIA news Included in the morning

#### VK3 Victoria

VK3JJB John Brown  
VK3PC Jim Linton  
VK3APO Peter Mill

Phone 03 9885 9261  
[arv@amateurradio.com.au](mailto:arv@amateurradio.com.au)

VK1WIA, Sunday 11am and 8pm, 3.615 and 7.085 (LSB), 10.130 (USB),  
VK3RML 146.700, VK3RMM 147.250, VK3RMU 438.075.

#### VK4 Queensland

VK4BY Don Wilchefski  
VK4ZZ Gavin Reibelt  
VK4KF Ken Fuller

Phone 07 3221 9377  
[vk4advisory@wia.org.au](mailto:vk4advisory@wia.org.au)

VK1WIA, Sunday 9.0am via HF and major VHF/UHF rpters

#### VK5 South Australia and Northern Territory

VK5OV David Box  
VK5APR Peter Reichelt  
VK5ATQ Trevor Quick

Phone 08 8294 2992  
[boxesdnm@lm.net.au](mailto:boxesdnm@lm.net.au)  
[peter.reicheit@bigpond.com](mailto:peter.reicheit@bigpond.com)  
[vk5advisory@wia.org.au](mailto:vk5advisory@wia.org.au)

VK5WI: 1843 kHz AM, 3.550 MHz LSB, 7.095 AM, 14.175 USB, 28.470 USB, 53.100 FM, 147.000 FM Adelaide, 146.800 FM Mildura, 146.900 FM South East, 146.925 FM Central North, 438.475 FM Adelaide North, ATV Ch 35 579.250 Adelaide. (NT) 3.555 LSB, 7.065 LSB, 10.125 USB, 146.700 FM, 0900 hrs Sunday. The repeat of the broadcast occurs Monday Nights at 1930hrs on 3585kHz and 146.675 MHz FM. The broadcast is available in 'Realaudio' format from the website at [www.sant.wia.org.au](http://www.sant.wia.org.au) Broadcast Page area.

#### VK6 Western Australia

VK6NE Neil Penfold  
VK6XV Roy Watkins  
VK6OO Bruce Hedland-Thomas

Phone 08 9351 8873  
<http://www.vk6.net/>  
[vk6advisory@wia.org.au](mailto:vk6advisory@wia.org.au)  
[vk6ne@upnaway.com](mailto:vk6ne@upnaway.com)  
[vk6xv@bigpond.net.au](mailto:vk6xv@bigpond.net.au)

VK6WIA: 146.700 FM(R) Perth at 0930hrs Sunday relayed on 1.865, 3.564, 7.075, 10.125, 14.116, 14.175, 21.185, 29.120 FM, 50.150 and 438.525 MHz, Country relays 3.582, 147.200 (R) Cataby, 147.350 (R) Busselton, 146.900 (R) Mt William (Bunbury), 147.000 (R) Katanning and 147.250 (R) Mt Saddleback. Broadcast repeated on 146.700 at 1900 hrs Sunday relayed on 1.865, 3.564 and 438.525 MHz : country relays on 146.900, 147.000, 147.200, 147.250 and 147.350 MHz.. Also in "Realaudio" format from the VK6 WIA website

#### VK7 Tasmania

VK7ZAX Phil Corby  
VK7DG Dale Barnes  
VK7KK Reg Emmett

Phone 03 6234 3553  
[vk7advisory@wia.org.au](mailto:vk7advisory@wia.org.au)  
[phil.corby@tassie.net.au](mailto:phil.corby@tassie.net.au)  
[vk7dg@wia.org.au](mailto:vk7dg@wia.org.au)  
[regemm@ozemail.com.au](mailto:regemm@ozemail.com.au)

VK1WIA Sunday 9am on VK7WI network: 3.570MHz LSB, 146.700 MHz FM (VK7RHT South), 53.825MHz FM (VK7RAD South), 147.000MHz FM (VK7RAA North), 146.750 FM & 53.825MHz (VK7RNW North West), 146.625 MHz FM (VK7RMD North West), UHF CB Channel 15 (Hobart) and 27MHz CB - 27.225MHz LSB (Hobart). Followed at 9:30am with VK7 Regional News Broadcast also on 7.090MHz LSB & 14.130MHz USB

### Notes

1. Only three members of the state advisory committees are listed.
2. All listings are preliminary. They will be updated each month as required.
3. Membership application forms are available from the WIA web site [www.wia.org.au](http://www.wia.org.au) or the national office address above.

# New WIA member



Ash Clark VK3SSB with WIA President Michael Owen VK3KI. The picture was taken shortly after Ash signed up as a member of the WIA at the recent SERG Convention in Mount Gambier.

*Photo by Trevor Quick VK5ATQ*

## Ash Clark VK3SSB

Ash Clark, VK3SSB, is only 15 years old and has already made an impact on the radio world. Starting at 13 years of age, he studied under Mark VK3KZZ, and obtained his Limited Novice (VK3HAT). Ash immediately decided to upgrade. With the guidance and knowledge imparted by VK3KZZ, Ash qualified for his Advanced Licence in only three months.

This new found freedom on radio enabled Ash to establish his own SSTV cross band repeater, operating on 20m and 2m. This repeater enables local amateurs with limited HF capabilities access to long-range SSTV transmissions. Ash actively promotes Amateur Radio to young people and eagerly talks to the new foundation licensees on air.

Ash's other radio interests include IRLP and Space Communications, having had several conversations with astronauts on board the ISS. Ash is also keen on APRS and can often be seen on the map pushbike mobile doing his paper round.

Having been a Scout for some years, Ash readily participates in JOTA annually as a volunteer radio operator. Family, friends and local amateurs are very proud of Ash's achievements. I'm sure you will be hearing more from this involved, young amateur as he continues to bring radio into the next generation.

Christina Simon

# ICOM's price break through most affordable prices ever



## IC-7000

HF/VHF/UHF All mode Transceiver • 100W HF/50MHz, 50W/2m, 35W/70cm • I.F DSP for improved noise rejection • Digital IF filter for Dial up selectivity • 2.5" TFT colour display for bright easy reading • Remote control DTMF Mic for fingertip control & IRLP access PLUS • digital voice storage • 2 mode band scope • Multi function meter 7 SWR display • Built in RTTY modulator



## IC-756PRO III

HF\*6m • Sharp & soft IF filter shape • New receiver gives +30dBm third-order intercept point • One-touch record/play • Digital voice memory • Extended 1/4 Tuning step & BPF functions for SSB-D mode • 32-bit floating-point DSP and 24-bit AD/DA converter • SSB/CW synchronous tuning • 5-inch color TFT LCD • Built-in antenna tuner • Customisable filter shape • No optional filters to buy



## IC-7800

HF\*6m • Four 32-bit floating point DSP units • +40dBm ultra high intercept point • Automatic tracking pre-selector • Two completely independent receiver circuits • 200W output power at full duty • Ultra high frequency stability • 7-inch wide color TFT LCD • Multi function spectrum scope • RTTY / PSK31 operation without PC connection • Professional 6m receiver • Digital Voice Recorder • CF memory card.



## IC-2200H

• VHF High (65W) Power Output  
• DTCS & CTCSS Tone  
• Squelch • DTMF Encode & Decode (with optional UT108) • Digital Voice & Data Communication (with optional UT118)  
• 207 Alphanumeric Memories

## IC-P7A

VHF/UHF (2m/70cm) Dual-band FM Handheld Transceiver • Ultra compact body, light weight 47x81x28mm, 160g • Mini-power VHF/UHF dual bander with wideband receiver 0.495-999.990MHz • 1800mAh large capacity Li-Ion battery allows 20hours operating time (Tx:Rx:Standby=5:5:90) • 1.5W output power on 2m & 1W output power on 70cm • Simple operation • 1000 memory channels with flexible memory bank system • Oversize LCD for clear display of function information



## IC-T90A

A new 5W Triband handheld  
• VHF/UHF FM 2M, 6M, & 70CM  
Wideband receive 495KHz - 1GHz 555 Alphanumeric memories • 13 Scan modes DTCS & CTCSS encode & decode DTMF encoder (10 memories)  
Wide/narrow transmit capability.

**ICOM**

ICOM 84

Call your local ICOM dealer [www.icom.net.au](http://www.icom.net.au) or (03) 9549 7500

Amateur

NEW



The magazine for **AUSTRALIAN** radio amateurs

Volume 74 No 8  
August 2006

# Amateur Radio



\$6.50  
incl. GST

1906 ~  
2006

Marconi WWI mulepack  
spark transmitter

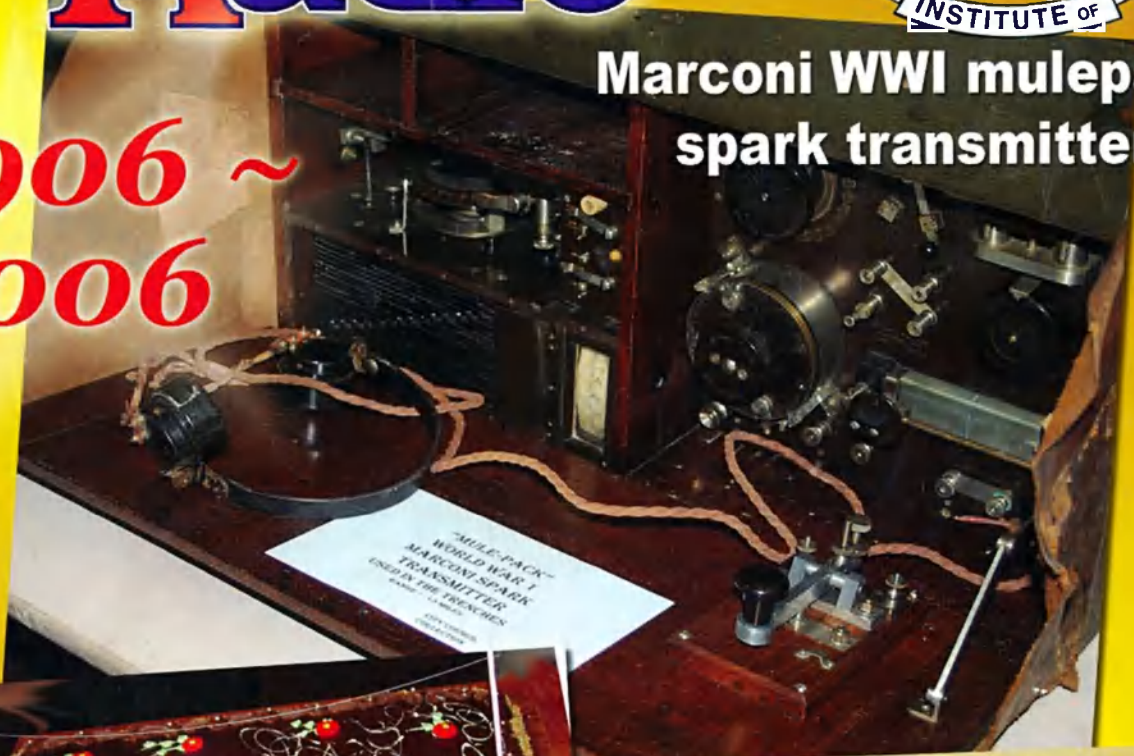

"MULE-PACK"  
WORLD WAR I  
MARCONI SPARK  
TRANSMITTER  
USED IN THE TRENCHES  
1914-18  
COLLECTOR  
GEOFFREY H. HARRIS



Mark 4 CW transmitter  
for 3.5 and 7 MHz  
Drew Diamond VK3XU

Build a replica of the  
Paraset or Type VII set

An early WW2 transceiver of the British  
Secret Service and used by the SOE

Malcolm R Haskard VK5BA



# MARCONI CENTENARY *Celebration*

*The Centenary of the first overseas wireless transmission from the Australian mainland – July 12th 1906*



*From Point Lonsdale*

Geelong Amateur Radio Club and the Borough of Queenscliffe hosted celebrations of the centenary of the first overseas wireless transmission from the Australian mainland at Royal Park, Point Lonsdale, with a reenactment of the original transmission across Bass Strait .

A highlight of the reenactment occurred when the Victorian Governor, Professor David de Kretser AC handed a copy of the inaugural message to Ken Jewell VK3NW who transmitted the message in Morse to our colleagues in Devonport. Simultaneously the 250 schoolchildren and 150-guests, who filled the marquee to overflowing, were able to read a transcript of the message on a scrolling LED display.



An outstanding feature of the celebration was the positioning of a replica of the original hut, erected by the Marconi Company in 1906. The hut, constructed by students of Geelong's Gordon Institute of TAFE, was fitted out with a spark transmitter, tuning coils, Leyden jars, headphones and key, exactly as shown in photographs taken at the time of the original transmission.

*(see full report inside)*



**Across Bass Strait to Devonport**  
*(Inside back cover)*

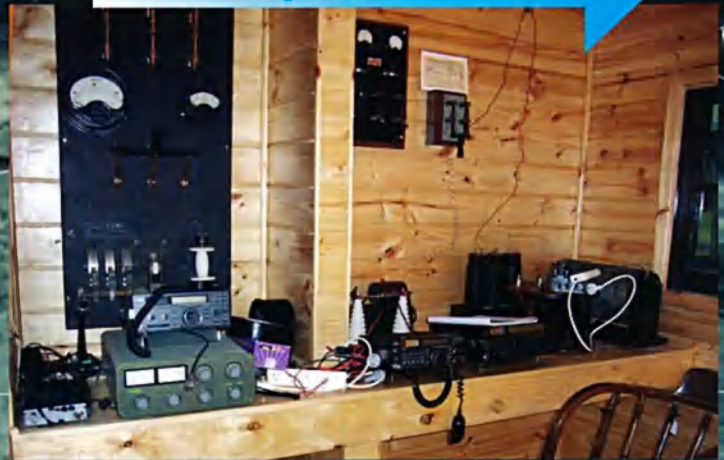



# Amateur Radio

Volume 74, Number 8  
August 2006

The Journal of the Wireless  
Institute of Australia  
ISSN 0002-6859

## Editorial

Editor: Peter Freeman VK3KAI  
editor-armag@wia.org.au

Technical Editor: Peter Gibson VK3AZL

Publications Committee Members

Branda Edmonds VK3KT  
Ron Fisher VK3OM  
Evan Jarman VK3ANI  
Tom Potter VK3UBS  
Bill Roper VK3BR  
Ernie Walls VK3FM

All circulation matters  
nationaloffice@wia.org.au

## How to submit material

### General and Technical articles

Secretary  
AR Publications Committee  
PO Box 2175,  
Caulfield Junction Vic 3161  
or armag@wia.org.au

### Columns and letters to Editor

Editor  
AR Magazine  
PO Box 273  
Churchill, Vic 3842  
or editor-armag@wia.org.au

### Hamads

"Hamads" Newsletters Unlimited  
PO Box 431  
Monbulk VIC 3793  
Fax 03 9756 7031  
newunltd@bigpond.net.au

### Advertising

All enquiries to  
Newsletters Unlimited  
PO Box 431  
Monbulk Vic 3793  
Phone: 03 9756 7797  
Fax: 03 9756 7031  
newunltd@bigpond.net.au

### Registered Office

10/229 Balaclava Road,  
Caulfield North VIC 3161  
Australia  
Phone: 03 9528 5962  
Fax: 03 9523 8191

## Production Deadlines

General articles, columns and  
advertising booking 10th day of  
previous month.

Hamads and advertising material 15th  
day of previous month

The contents of Amateur Radio are Copyright  
Wireless Institute of Australia © 2006

## GENERAL

The Centenary of Australia's first overseas wireless transmission .....	5
<i>Ron Churcher VK7RN, Devonport &amp; Barry Abley VK3SY Queenscliff</i>	
Maritime mobile operations on low power.....	16
<i>Tony Halter VK3TLA</i>	
WIA Honour Roll — update 2006.....	20
<i>Col Harvey VK1AU</i>	
GippsTech 2006 — a quick summary.....	21
<i>Peter Freeman VK3KAI</i>	
DXpedition to the top end via satellite .....	28
<i>John Titmuss VK4JWT</i>	
World Radiosport Team Championship 2005 .....	53
<i>(ARRL N/L July 14/06)</i>	

## TECHNICAL

A tuner for the 160 vertical .....	7
<i>Mick Hort VK2BZE</i>	
A dummy load for the new amateur radio practical test.....	10
<i>Jim Tregellas VK5JST</i>	
Build a replica of the Paraset or Type VII set.....	11
<i>Malcolm R Haskard* (VK5BA)</i>	
Mark 4 CW transmitter for 3.5 MHz and 7 MHz .....	22
<i>Drew Diamond VK3XU</i>	

## COLUMNS

ALARA .....	40	News from.....	30
AMSAT.....	38	VK2 .....	30
Beyond our shores.....	52	VK3 .....	31
Contests .....	41	VK4 .....	34
DXCC Standings .....	45	VK5 .....	35
DX News & Views .....	47	VK7 .....	33
Directory.....	56	Silent key .....	31
Editorial comment .....	2	Spotlight on SWLing .....	39
Equipment review.....	24	VHF/UHF — an expanding world .....	49
Hamads .....	54	WIA comment.....	3
		WIA news.....	4

## Our Cover this month

100 years have passed since the first radio communication crossing of Bass Strait by the Marconi Company. Celebrations in Devonport included an impressive cake, replete with replica antenna. An example of a Marconi World War I Spark Gap transmitter was on display in Devonport.

Jump forward to World War II: Malcolm Haskard tells us how to build a replica Paraset transmitter. Just to show that CW is still very much alive, Drew Diamond describes his Mark 4 CW transmitter. (Photos by VK7RN, VK5BA and VK3XU).

### Contributions to Amateur Radio

Amateur Radio is a forum for WIA members' amateur radio experiments, experiences opinions and news. Manuscripts with drawings and/or photos are always welcome and will be considered for publication. Articles on disc or email are especially welcome. The WIA cannot be responsible for loss or damage to any material. A pamphlet, 'How to write for Amateur Radio' is available from the National Office on receipt of a stamped self-addressed envelope.

### Back Issues

Back issues are available directly from the WIA National

Office (until stocks are exhausted), at \$4.00 each (including postage within Australia) to members.

### Photostat copies

When back issues are no longer available, photocopies of articles are available to members at \$2.50 each (plus an additional \$2 for each additional issue in which the article appears).

### Disclaimer

The opinions expressed in this publication do not necessarily reflect the official view of the WIA and the WIA cannot be held responsible for incorrect information published.

## Amateur Radio Service

A radiocommunication service for the purpose of self-training, intercommunication and technical investigation carried out by amateurs; that is, by duly authorised persons interested in radio technique solely with a personal aim and without pecuniary interest.

## Wireless Institute of Australia

The world's first and oldest National Radio Society  
Founded 1910

Representing

The Australian Amateur Radio Service

Member of the

International Amateur Radio Union

Registered Office of the WIA

10/229 Balaclava Road, Caulfield North Vic 3161

Tel: (03) 9528 5962 Fax (03) 9523 8191

email: nationaloffice@wia.org.au

<http://www.wia.org.au>

All mail to

PO Box 2175 Caulfield Junction VIC 3161

Business hours: 10am – 4pm weekdays

### National Office staff

Margaret Webb	Administrator Officer
Dianne Ashton	Examination Officer
Brenda Edmonds	Office Volunteer

### Board of Directors

President	Michael Owen	VK3KI
Vice-President	Ewan McLeod	VK4ERM
	Robert Broomhead	VK3KRB
	Glenn Dunstan	VK4DU
	Trevor Quick	VK5ATQ
	Robyn Edwards	VK6XRE
	Phil Wait	VK2DKN
Secretary	Chris Jones	VK2ZDD
Treasurer	Bruce Bathols	VK3UV

### Coordinators

AMSAT	Graham Ratcliff	VK5AGR
ARDF	Jack Bramham	VK3WWW
Australian ARISS	Tony Hutchison	VK5ZAI
Awards	Mal Johnson	VK6LC
Club Coordinator	Ted Thrift	VK2ARA
Contests	Ian Godsil	VK3JS

### John Moyle Memorial

Field Day Manager	Denis Johnstone	VK3ZUX
Editor 'AR'	Peter Freeman	VK3KAI
EMC/EMR	Gilbert Hughes	VK1GH
	Keith Malcolm	VK1ZKM
	Gilbert Hughes	VK1GH
	David Wardlaw	VK3ADW
	John Bishop	VK2ZOI
NTAC	John Martin	VK3KWA
Historian	Will McGhie	VK6UU

### IARU Region 3

Liaison Officer	Michael Owen	VK3KI
Intruder Watch	Glenn Dunstan	VK4DU
International		

Travel Host	John Miller	VK3DJM
-------------	-------------	--------

### ITU Conference &

study group	Gilbert Hughes	VK1GH
	David Wardlaw	VK3ADW
	Keith Malcolm	VK1ZKM

QSL Curator	Ken Matchett	VK3TL
-------------	--------------	-------

### QSL Bureau Coordinator &

VK9/0 QSL Manager	Neil Penfold	VK6NE
-------------------	--------------	-------

Repeater Coordinator	Peter Mill	VK3ZPP
----------------------	------------	--------

Webpage co-ordinator	Colin Thompson	VK2TRC
----------------------	----------------	--------

WICEN	Ewan McLeod	VK4ERM
-------	-------------	--------

# Editorial Comment

## Remembrance Day

August brings Remembrance Day activities and the Remembrance Day Contest. The Rules for the Contest were published in the July issue. I encourage you all to participate and to take that extra step of submitting a log. The Contest is primarily between the States, for the award of the trophy. However, your participation is crucial for the success of your state and of the contest itself.

You will see in the WIA News column, that the Board has decided to withdraw the Results from the 2005 RD Contest. Perhaps it was just as well that the results did not make it to press last month!

We have a tradition of providing a small focus on Remembrance Day for the August issue. As a result, we have a small update on the WIA Honour Roll and an article on the construction of a replica World War II Paraset transmitter. While some may question my decision, I have not published the detail drawings of the mechanical construction of the Paraset – these are available on request. Our cover links this construction article back to the Marconi celebrations, to World War I and to the present day, via another excellent project from Drew Diamond.

## Marconi centenary celebrations

July saw the centenary of the first transmissions across Bass Strait, from Queenscliff to Devonport. This issue has brief reports, together with great photographs of some of the people involved and equipment, both 100 years ago and for the celebrations. We may have more detail available in the next month or two.

## HF Propagation Predictions

I have received many messages about the decision not to publish HF Propagation Predictions, most in support. A few sought the details of the web address to access online predictions. The address is published close to the Sunspot Number chart. You will need the Latitude and Longitude for both ends of the communication circuit. The GRAFEX tool seems simple to use: [http://www.ips.gov.au/HF\\_Systems/7/1/4](http://www.ips.gov.au/HF_Systems/7/1/4)

I have received one letter indicating

reliance on the printed predictions. I can only repeat an earlier suggestion. Explore the services available at your local library. The staff will be able to assist you if required – you will need the web address for the site, plus the location details as noted above.

Remember, the Publications Committee has indicated that we would review the decision after three months – NOW is the time to have your say, either in support or against the decision.

## AR content and new licensees

With over 700 Foundation licences now issued by the ACMA, we need to offer additional assistance to our new colleagues. This may be as simple as providing guidance when required on air, acting as a mentor (Elmer) for someone local to you, or being friendly to the newcomer at the local club meeting or on-air.

The LCD restricts these newcomers to using commercial transmitting equipment, but there is still plenty of room for experimentation with other station equipment, such as antennae, and operating techniques. I invite you all to contribute your thoughts about how to set up a station, give some ideas about the techniques that you find useful in the construction and erection of antennae, in fact, any ideas that may be of assistance to our newly licensed colleagues. Items could be small or a larger article – I can provide comment on drafts if you wish.

## AR production & distribution delays

Firstly, I offer my apologies for the absence of the DX column last month. Somehow, I failed to forward the column on to the production house. I have apologised to John Bazley, the column author. In addition, July saw unusual delays in the production process and distribution system. The Publications Committee and the publication house are ironing out the problems and are aiming to return to delivery early in the month.

We are changing the distribution sequence so that members see AR before it appears on the shelves of the local newsagency.

73 Peter VK3KAI

## Membership

As reported in the News section of this AR, the WIA is actively promoting WIA membership to those qualifying for a Certificate of Proficiency. A new brochure has been produced, at this stage only in small numbers so that we may revise it, addressed to people who already know about amateur radio, but not a lot about what the WIA really does for the Amateur Service.

In recent months, it has mainly been the qualification for a Foundation licence that has dominated our assessments, though now we are seeing a new interest in the higher grades, particularly the Standard licence.

Last week 28 people joined the WIA, and 17 people joined the WIA the week before that. Certainly, they were not all Foundation licensees. A number were previous members rejoining, and a number were joining as family members.

Some came from the invitations to become a member sent with our letters forwarding notification of assessment results.

All of that means that we have had to turn our mind to answer the question, what does the WIA do for me?

Answering that question can become a bit tricky. I happen to think what we are doing in participating in the preparation for the International Telecommunications Union World Radiocommunications Conference next year and, hopefully, having as a member of the Australian delegation to WRC07 an amateur nominated by the WIA, our participation in IARU Region 3, our ongoing role of representing the amateur service to ACMA and our general advocacy for the amateur service is what matters most.

But I also know that doesn't wash with some people. They take the position that the WIA would do that anyway, whether or not they are members. They don't see the value in representation; they look for the QSL service, the magazine, the discounts on books and the like to measure the worth of the WIA to them.

What the WIA does is, in fact, many things. It was with some hesitation that we printed in last June's AR my Report to the Open Forum following the formal Annual General Meeting. It took a lot of

space, but we printed it because it gave some idea of the diverse activities of the WIA. It demonstrated not only the diverse activities, but also the number of people involved, in everything from awards and contests, to publications, training, assessments, the coordination of clubs, as well as the various aspects of representation and advocacy ranging from the WRC, to standards, to BPL to the general regulation of the amateur service in this country.

But all of that is a hard message to get across to our members, and more so to potential members.

In part that is the nature of our interest. Our interest within amateur radio is often very narrow. Some of us are interested in fox hunting. That is really amateur radio. Some of us are interested in HF DX. That is really amateur radio. Some of us are interested in contests. That is really amateur radio. Some of us are interested in EME. That is really amateur radio.

So some potential members look at what the WIA does in their particular interest area, and judges the worth of the WIA only on what they see in their area of interest.

Most clubs acknowledge that the WIA's approach to clubs is very supportive, with affiliation, support for the training of WIA Assessors, support through special arrangements for the sale of Callbooks and the Foundation Licence Manual, the Club Grants Scheme and general assistance.

The WIA has made it clear that the attraction of new amateurs depends firstly on the licence structure and the qualification means (which it influences, develops and manages) and secondly on the clubs, who provide the social meeting point, the training and the assessments.

If we are not careful, that simple separation of roles could produce competition between the clubs and the WIA for members. The potential amateur is also a potential club member and a potential WIA member. Because the club is the first contact is there a temptation for the club to advance membership to itself first, perhaps to the detriment of the WIA? Of course there is. Simply promoting both together is not easy. It invites the

response, yes, I will join the club, but I can't afford both, and so I will leave membership of the WIA to later.

The risk is that membership of a club becomes the alternative to membership of the WIA.

The WIA must look to the clubs for their support in seriously attracting new members. The clubs need to consciously promote membership of the WIA among all their members. Our structure, the product of history, requires that we recognise that the roles of the club and the role of the WIA is synergistic, not competitive.

The WIA must also look to all amateurs for their support in attracting new members.

The WIA has done much in the last two years. Many amateurs have acknowledged that. There is much more that it must do. Any organisation that is purely voluntary will wax and wane with different volunteers, with different skills and different interests and different commitments at different times. Our future security will come from an organisation managed by paid professionals and governed by competent and skilled volunteers.

That will only happen with enough members to fund the skills and experience needed in a structure governed by volunteers, with many activities always dependent on volunteers but with a paid, professional core.

So, I ask you as a member, you as an amateur and you as a club member to look to see how you get another WIA member. Perhaps even join (or rejoin) yourself.

Earlier in this Comment, I referred to the person who takes the position that they don't need to be a WIA member because the WIA would undertake the advocacy role anyway. That person sadly misses the point.

The ability and credibility of the WIA as an advocate for Australian amateurs depends very much on the number of Australian amateurs it is seen to represent, and most people will measure that number by the number of Australian amateurs who are its members.

## **2005 Remembrance Day Contest Results**

The WIA Board very much regrets to announce that it has become necessary to abandon any further attempts to determine the outcome of the 2005 Remembrance Day Contest.

The results already announced are withdrawn and no certificates will be issued for the 2005 Contest.

The then RD Contest Manager did not complete the results and data has been lost.

The new RD Contest Manager, Peter Harding VK4OD, has tried very hard to recover the situation. However, it is now clear that the amount of data lost makes it impossible to reconstruct the contest sufficiently for the Board to have confidence in any results and the fairness of those results.

The Board is acutely conscious of the fact that the RD Contest is the most supported of all the Australian contests and holds a very special position in the eyes of very many amateurs, and so has taken the step that it has with the greatest reluctance.

Changes to this year's contest include ensuring that contest logs submitted electronically will be on a secure site and available to the RD Contest Manager, Peter Harding VK4OD, the National Contests Coordinator Ian Godsil VK3JS and Trevor Quick VK5ATQ, the WIA Director responsible for contests and awards.

The WIA Board offers its sincere apologies to the many who participated in the 2005 Contest and hopes that all amateurs will again support the 2006 Contest.

## **WIA commences membership drive**

On July 8, the WIA commenced sending to candidates passing assessments, a letter of congratulations on becoming a radio amateur and inviting the successful candidate to become a WIA member. Accompanying the letter is a copy of a recent AR magazine, a membership application form and a newly produced full colour leaflet outlining the WIA and the services it provides to members.

All those people who have passed an assessment from mid October 2005 and are over the age of 15 and are not already WIA members have been sent a similar letter. These have been sent to about 500 people.

A copy of the leaflet promoting the WIA can be downloaded from the WIA website.

## **WIA broadcast callback records set**

Check-ins for the National WIA News total 7,681 with 869 reported for July 2.

Over 14,500 is the total of the RF/Podcast MP3/Internet text editions.

The single most popular RF channel is Adelaide's 2 meter broadcast with 423, followed closely by Melbourne's VK3WIA callback channel (402) and Westlakes Amateur Radio Clubs 9:00am session with 381.

State wide, VK4 leads with 1700, VK2 with 1450 then one check-in separates VK5 and VK7 (VK5 with 950 and 949 in VK7).

Podcasts account for 2,300.

## **Condition on young persons amateur licences removed**

Recently ACMA has been imposing an additional condition on amateur licences granted to people under age 16.

That condition required the licensee, while under 16, to only operate amateur equipment under the supervision of a licensed amateur over the age of 16.

The WIA immediately objected to the condition, advancing a number of reasons. The reasons included the fact that the condition was inconsistent with the whole object of the Foundation licence and in direct contradiction of the "Outcomes" paper, where it was said, "it was decided not to introduce an age limit for operating under the Foundation licensing option". It is not a condition of the class licence covering CB equipment and so discriminated against amateur licensees who were trained in the relevant safety aspects.

As more licences were issued with the condition, more people became aware of it and expressed their concern to the WIA.

Alan Jordan of ACMA has now advised the WIA as follows: "I refer to representations from the Wireless Institute of Australia about the imposition of a licence condition requiring the operation of Amateur stations by licensees less than 16 years of age to be supervised by a licensed Amateur over the age of 16.

This requirement has been reviewed and I am pleased to advise that the condition will not be applied from this date. Those licences already subject to that particular condition will be reissued in the near future.

Amateur licences will, on application, be issued to any person who demonstrates at examination that he or she possesses the necessary knowledge and skills."

The WIA welcomes ACMA's decision.

## **Amateur licence fees reduced**

From 1 July 2006 GST is no longer payable on Apparatus Licenses and so the amateur licence issue fee is now \$57.00, a reduction of \$2.00.

Licences on which the additional amount has been paid will be extended proportionately.

## **How long before I hear from the WIA after an assessment?**

Unfortunately, some candidates have unrealistic expectations about how long it can take before they should get their "new" licence. The WIA has been working very hard to ensure a fast turnaround, and indeed we think that one reason why some candidates expect a very fast response is because they have heard of some people getting their results in a week or so.

If you have asked the WIA Exam service to process your application for a Certificate of Proficiency and to lodge your application for a licence or a variation of an existing licence, and the correct fees have been forwarded, then you should get a letter from the WIA telling you that your results and the applications have been sent to ACMA on a particular date.

*Continues page 5*

# The Centenary of Australia's first overseas wireless transmission

Transmission of communications by radio waves is so integral to our lives now that we don't give it a thought. We even unlock our cars and open the garage door using them. In some cases we send emails from one room to the next by bouncing the carrier signal off a satellite hundreds of kilometres above us. But only about 100 years ago, the first overseas transmission of information by radio from Australia took place with messages to Tasmania, and it was revolutionary.

## The Mainland connection

Barry Abley VK3SY

More than a year of planning culminated at Royal Park, Point Lonsdale, with the celebration of the centenary of the first overseas wireless transmission from the Australian mainland, on Wednesday July 12, 2006.

In association with the Borough of Queenscliffe and in the presence of the Victorian Governor, Professor David de Kretser AC and other luminaries, the Geelong Amateur Radio Club facilitated a reenactment of the original transmission, albeit on the 40 metre Amateur Band.

Under the leadership of Cal Lee

VK3ZPK, a program evolved which incorporated elements of both the original Marconi Company transmissions and modern technology. A highlight of the reenactment occurred when the Governor handed a copy of the inaugural message to Ken Jewell VK3NW who transmitted the message in Morse to Devonport. Simultaneously the 250 schoolchildren and 150 guests, who packed the Marquee, were able to read a transcript of the message on a scrolling LED display.

An outstanding feature of the celebration was the positioning of a replica of the original hut, erected by the Marconi Company in 1906. The hut, constructed by students of Geelong's Gordon Institute of TAFE, was fitted out with a spark transmitter, tuning coils, Leyden jars, headphones and key, exactly as shown in photographs taken at the time of the original transmission. Members of the Geelong Amateur Radio Club and the Geelong Radio and Electronics Society spent

many months acquiring and refurbishing ancient transmitting and receiving equipment to grace the replica hut. The hut, together with additional artifacts from Amateurs and Museum Victoria, some of which have never been displayed, will be exhibited at the Queenscliff Maritime Museum until September this year.

In addition to period radio gear, members of the Western District Historical Car Club displayed vehicles which dated back to the period of the celebration.

Members of the Geelong Amateur Radio Club operated the station on HF and 2 metres for six days during the celebration, receiving approximately 800 contacts to VI3MC, the special event callsign. A commemorative QSL card has been designed and will be forwarded to all who worked either VI3MC or VI7MC.

In addition to local interest, reciprocal greetings were exchanged with Dr Jim Barnett, Director of the Museum of the History of Science at Oxford University, who has acquired and is currently exhibiting many of Guglielmo Marconi's early items of experimental equipment.

**The Tasmanian connection continues overleaf and several pictures from each site appear on the inside front and inside back covers of the magazine.**



The 'Shack' at the Queenscliff end. (A replica, built by Gordon Institute students, of the original.)

from page 4

## Assessment timing

If you haven't asked the WIA to do that, then you will get a letter from the WIA forwarding the official notification of your results, and telling you that when you have all the official results you need, you should apply for a Certificate of Proficiency and a licence or variation of a licence, from ACMA.

How long should you wait before

chasing the results from the WIA?

Please allow 3 weeks before chasing the WIA to ask why you haven't heard! If you haven't heard by then, please contact the office, preferably by email, to [nationaloffice@wia.otg.au](mailto:nationaloffice@wia.otg.au).

If you have asked the WIA to send your results direct to ACMA the you can expect it will take between one and two weeks for ACMA to issue your licence from the time you receive a letter from the WIA

saying that they have been sent to ACMA. If you include an e-mail address on your licence application, ACMA will let you know by e-mail when your licence has been issued.

If you haven't heard from ACMA 3 weeks after sending the forms to them, or after you have a letter from us saying we have sent them to ACMA, contact ACMA by email to [nlec@acma.gov.au](mailto:nlec@acma.gov.au) or by phone to 1300 805 115.

## The Tasmanian Connection

Ron Churcher VK7RN

What a day it was! July 12<sup>th</sup> 2006, 100 years to the day since Marconi's wireless conquered Bass Strait and made the first wireless crossing of open water in the Southern Hemisphere and we celebrated with our Geelong friends a wonderful century of electronic progress.

The day started with the writer up at 4.20 am in order to open the Devonport Maritime Museum for the ABC morning presenters, who did a fantastic job featuring amateur radio and the Marconi celebrations from 5.30 am to 7.45 am.

Preparing the large exhibition hall at the Museum was the next job and we managed to get about 90 chairs in between our exhibits for the invited guests. We expected we may have a few problems with 7 Megahertz HF propagation but the backup IRLP nodes gave us MORE. At 12 noon, 7 Megahertz was open to NSW, Queensland and WA, but short skip to Vic. - NO! ..... PANIC. Saved - at 12.45 pm, 5/9 to Queenscliff.

Our State Governor, His Excellency the Hon. William Cox arrived and we awaited the call from Victoria starting the exchange of messages. Both Governors spoke, then the parliamentarians present talked to each other, Victoria sending greetings to their little neighbour and Tasmania responding reminding them that Tasmanians founded Melbourne.

In a chat with Peter Turrell, the chairman of the Marconi Veterans Association in Chelmsford, England, he mentioned that Princess Elettra Marconi, the daughter of Guglielmo Marconi, was in England for the Ascot Races.

A phone call to Italy and we had a scoop! A 3-minute message in which she intimated that if she had known she would have come out to be with us. We had not known that she was still alive!

A reception by the Devonport City Council followed: we cleared the chairs and the guests were able to view our array of ancient and new radio equipment.

We hope to be able to give you a more specific report in next month's AR but let me offer all readers a reprint of Marconi's 1906 brochure - 24 pages of fascinating reading - only \$6.00 AUS posted. Apply to Marconi Centenary, 177 Best St., Devonport, 7310

Attached is the text of Princess Elettra's recording - sorry - without her lovely Italian accent.

The celebration of this milestone in

wireless telegraphy in Australia has brought to the attention of the public, through extensive media coverage, the dynamic world of Amateur Radio and the challenges and excitement that radio

communications still offers, one hundred years after those first tentative steps in wireless telegraphy.

ar



The 'Shack' at the Devonport end



La Principessa Elettra Marconi

*I am Elettra Marconi, Guglielmo Marconi's daughter. It is a great pleasure to speak with you on the centenary of my father's first wireless transmission between Devonport, Tasmania and Queenscliff, Victoria.*

*I am very happy to know that the Governor of Tasmania is present and also the Governor of Victoria and I am very thankful and grateful. I would have been*

*very pleased to have been with you in this great event and also speaking about my father.*

*My dear father, Guglielmo Marconi is always near me, always in my heart. I was a little girl when I lost him in 1939 but I have great memories. So I would like to be with you and remember him with you.*

*He loved Australia and his great wish was to visit. I have been to Australia many times in my life and also to the lovely island of Tasmania. I went with my mother Maria Christina Marconi on the liner Guglielmo Marconi on its maiden voyage in 1963. I have many friends in Victoria and I am sure I also have many in Tasmania.*

*I am wishing you all the best for this wonderful occasion, I am very moved and very excited and I would wish to be near you with all my heart. God bless you all.*



# A tuner for the 160 vertical

Mick Hort VK2BZE

The helical vertical, as described in last month's issue of *Amateur Radio* magazine, is still performing well, but suffers from a lack of bandwidth. As is to be expected, the bandwidth is about 10 kHz at best.

Many attempts to tune it in a fashion suitable for remote tuning failed dismally, requiring both capacitive and inductive tuning. Extending the whip up and down seemed to be the way forward but posed problems of connectivity, especially running 400 watts or so.

I tried making flexible copper wire coils inside the main tube and pulling them up and down, but this was very poor and made spacing against flashover difficult. Also, it was mechanically near impossible to achieve.

While pondering all this I glanced at my new air compressor and instantly saw the small coiled plastic air hose as the answer. The hose is highly flexible, and protects and prevents the turns rubbing together.

Next, a small ball of string carrying a draw-string was blown through the tube with compressed air. This required stretching the hose out fairly long, and then four strands of about 0.5 mm ECW were drawn through the tube with the string.

A suitable brass nut was threaded on to the tube far enough to allow for the thickness of the plastic pipe and another nut. This end, and the wire, was passed through a neat fit hole just above the last turn of the helical winding, and another brass nut went over the wire and screwed on to the tube to clamp it in place. The wire was soldered to the helix, allowing some extra for flexing.

This may need the winding closed in, or an extension fitted to your pipe, to allow about 600 mm of lift on your flexible coil. The top half a turn or so of the tubing is fastened to the bottom of a 1.2 kg dog food can (take out the dog food first), just following the curve of the base with three cable ties and the ECW soldered to the bottom of the can. Make sure the can you use can be soldered as some newer coatings won't solder.

My support for the whip is a 25 mm thick piece of bakelite cut round for a neat, tight fit in the open top of the can. The lid from the can should be hammered flat to spread it and make it a better fit for soldering back on to the can later.

A stud or bolt is put through the centre of the bakelite (use whatever suits your

whip material here), and the lid you flattened out, and the two are screwed tight with a nut. The bakelite is fitted into the open top of the can and the lid soldered all round back on to the can. A small hook is screwed into the lid to connect the lifting string.

This completes the whip carrier that will be lifted up and down to stretch the air hose and tune the antenna. Attach your whip (about eight feet long) to the can and insert it into your antenna main pipe making sure it slides up and down nicely. Put a stop screw in the top to prevent the can pulling out and jamming.

To lift it up and down I used a 100 mm right angle bend, with sockets both ends, which is cut in half across the middle of the bend. This gives two pieces you can use if you break one, or you can give one to a friend for his antenna. You need to fit a roller into the top edge of the bend to run your lifting string over. It must be off centre so the roller does not foul the whip.

I cut a slot in the bend wide enough to take the width of the roller, then drilled a hole either side of the bend to take a shaft for the roller to turn on. My roller was a sliding door roller but any roller with a nice deep groove will do. I made a cover for the roller to prevent the string coming off, but it is not needed once it is all set up. Put a string on the hook in the top of the can,

pass over the roller and you are ready for testing.

The helical should be tuned to about 1900 to 1950 kHz to start, with the coil in its lowest position. When you pull it up it will tune down to under 1800 kHz, depending on the amount of lift, but you will have no problem getting an SWR dip over the entire band. It also appears to have very little effect on the matching, which was a big problem trying to tune at the bottom of the antenna.

The string can be pulled manually or with a winder. Mine is pulled by a follower on a 10 mm diameter, 900 mm long screw thread wound by a 12 volt cordless drill

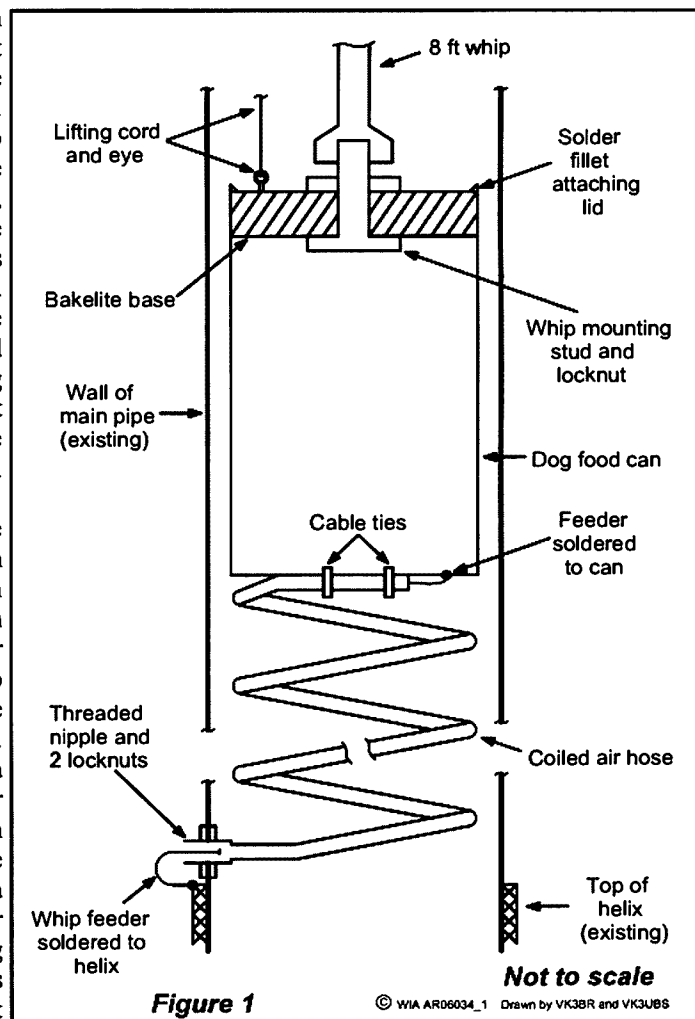

**Figure 1** Whip traverse and feed assembly. Note that the coiled air hose has 4 lengths of enamelled copper wire running in parallel inside the tube - see text for details (Ed.).

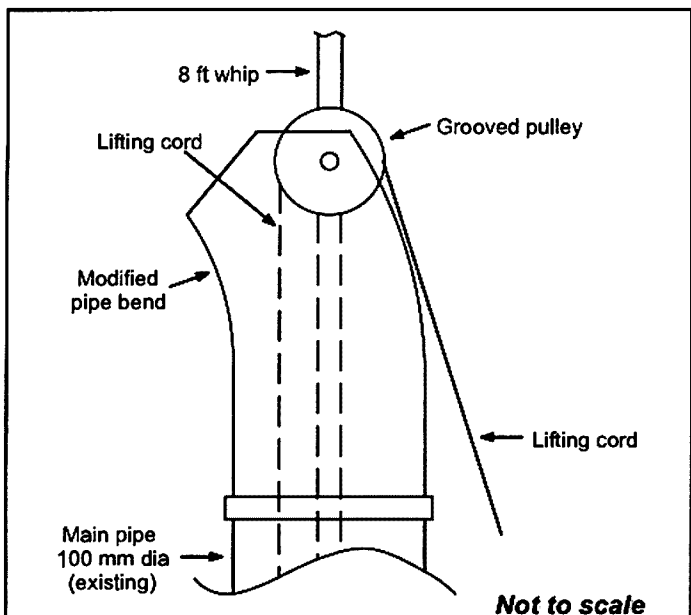

**Figure 2**

© WIA AR06034\_2 Drawn by VK3BR and VK3UBS

Guide pulley assembly.

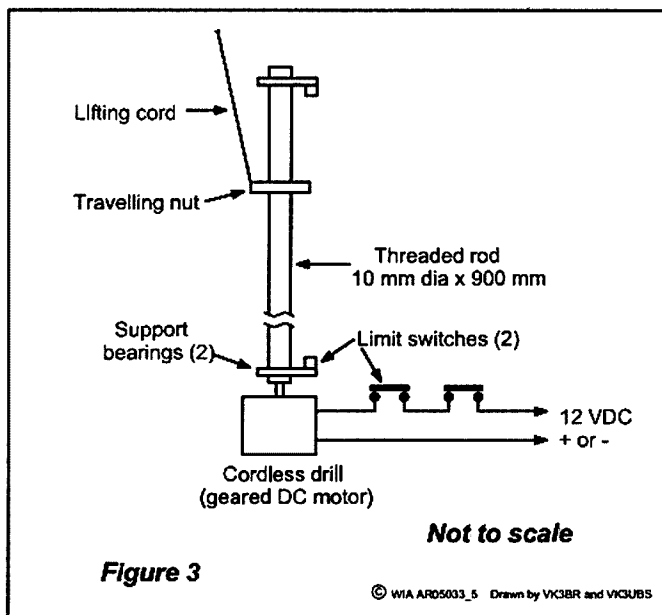

**Figure 3**

© WIA AR05033\_5 Drawn by VK3BR and VK3UBS

Motorised lift control.

Note that the support bearings and limit switches are located at the top and bottom of the assembly, whilst only labelled at the bottom of the drawing (Ed.).

which runs through up/down buttons fed from my shack 12 volt supply. It has limit switches to prevent damage.

Set the frequency you want on AM or FM, apply a small amount of power, and pull the string to get the lowest SWR. You can get into the 'ball park' by tuning on

receive noise - a good noise peak is noted near resonance.

Another good puller may be an electric antenna winder from a car radio. These

have about the right travel, speed, and in-built limits. I will test one as soon as I find a broken one.

With this add-on to your 160 metre vertical, you can cover the whole band with ease using easy to get non-critical, and cheap, parts. **ar**

**SPECIAL BUY**  
VX-150 2m H/H  
only \$249.00

# G&C COMMUNICATIONS

Authorised dealer for • Icom • YAESU • Kenwood • Barrett RFDS • GME Electrophone • Uniden

**See us for CAR Stereo too! ~ 'Cranbourne Car Sound'**

## ICOM (Aus.) TRANSCEIVERS

IC-756 Prof III HF + 6M	\$4,999
IC-7400 HF +6M +2M	\$2,699
IC-7000 NEW! HF~70cm Mob	\$2,299
IC-706MKIIG HF~70 A/Mod	\$1,399
IC-718 HF SSB	\$999
IC-910H 2M/70cm Multimode	\$2,499
IC-2720H 2M + 70cm D/Band	\$699
IC-208H 2M + 70cm D/Band	\$579
IC-2200H 2M H/Power 'NEW'	\$399
IC-T90A Tri-Band H/Held	\$479
IC-P7A New Mini D/band	\$395

**2 YEAR ICOM (Aust.) Warranty!**

★ Full Product Range Available! ★

Full range of Communications/Scanner Receivers available from Icom, Uniden, Yaesu **\$ POA**

## HF Vertical Base Antennas

Comet CHA-250Bx 2.8~57MHz	\$699
Diamond BB7V 2~30MHz	\$499

## Antenna Tuners

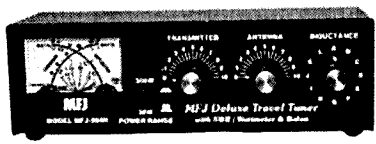

MFJ-902	MFJ-902H
MFJ-904H	MFJ-945E
MFJ-949E	MFJ-929

**More Details on Website**

## Antenna Rotators

### G450A (shown)

G-2800DXC	G-450C
G-1000DXC	G-550
G-800DXA	
G-650C	
G-5500	

## TE series EMTRON HF ANTENNAS

Australia wide orders welcome  
Credit card Cheque Money order

## YAESU Transceivers

FTDX-9000DA Elite HF Base	\$16,499
FT - 897D HF - 70cm	\$1,399
FT - 857D HF - 70cm	\$1,299
FT - 817ND HF - 70cm	\$1,049
FT - 8900R Quadband	\$ 799
FT - 8800R Dualband	\$ 699
FT - 7800R Dualband	\$ 469
FT - 1802M 2m 50W	\$ 295
FT - 60R Dualband H/H	\$ 369
VX2R 2/70 H/Held	\$ 329
VX-6R 2/70 H/Held	\$ 499
VX -7R Tri-Band H/Held	\$ 599
VX -170 2M Rugged H/Held	\$ 279
VR-5000 Receiver	\$1,199
VR-500 H/H Receiver	\$ 499
VR-120D H/H Receiver	\$ 279

**3 YEAR AUSTRALIAN WARRANTY**

Call in and see our range of power supplies, cables and connectors

**Comet & Diamond**  
Antennas & Accessories

**Proudly Supporting Australian Business**

**207 High St. Cranbourne VIC 3977**  
**Ph: 03 5996 3298 Fax: 03 5995 0184**

**Email: gcomm@bigpond.net.au**  
**www.gcomm.com.au**



# Build It Yourself Kits

Put more satisfaction into your radio hobby, build some gear for yourself



## Some of the 'Build yourself kits' we offer

### TT 1001 DC to 1 GHz RF Preamp

An easily assembled wide band RF preamp. Up to 18.5 dB gain at 100 MHz, typical gain at 500 MHz is 17 dB. Supply voltage 8 to 14 V DC.

### TT 1051 Transmatch Tuning Bridge

Just connect this kit between the receiver and antenna tuner, adjust the tuner for a null on the receiver's frequency. Full instructions included.

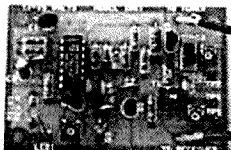

### TT 1054 4 Band Re-Gen SWL Receiver

Easy to build kit covering the 49 meter SWL band, 40 meter ham band, 31 meter SWL band plus 12 to 15 MHz. Includes screen printed front panel.



### TT 1056 Single Band Direct Conversion Receiver

This kit is based on the popular NE612 mixer/oscillator IC. The kit is supplied with tuning components that allows the receiver to be built on any of the HF ham bands from 160 through 10 meters.



### TT 1253 9 Band Re-Gen Receiver

This kit is a good performer featuring push button band selection. Covers 1.8 to 22 MHz.



### TT 1254 Double Conversion Receiver Kit

A kit for the intermediate constructor!

This kit is a high performance multi-mode HF receiver covering 100 kHz to 30 MHz. Supplied with a professional grade enclosure.



### TT 1210 2M to 10M Transverter

Add 2 meters to your HF transceiver. RF out 10W input 4 to 20W, solid state TR switch. Supplied with a professional grade enclosure.



### TT 13XX QRP CW HF Transceivers

These kits are single band CW HF transceivers with an RF power around 3 watts. Available in the 80, 40, 30, 20 and 15 meter bands. When ordering the 'XX' in the part number is replaced by the band - ie model TT 1380 is an 80 meter kit.



### TT 1064 Smart Squelch

A clever device that connects between a receiver and external speaker. It works on the principle of integrating audio (not noise) over time and closing a relay when the threshold reached. Ideal for detecting weak band openings.



### TT 1550 Utility Audio Amplifier

An ideal kit where you need an effective and low cost audio amp. 1.5 Watts with a supply voltage of 13.8 V DC. Uses the same technology as many of Ten Tec rigs.



### TT 1203 RF 50 Ohm Dummy Load

A low cost dummy load for HF and up to the 2 meter band. Easy to assemble and capable of absorbing 300W.



Coming Soon.

## LDG AT-7000

Specifically designed for the ICOM 7000



## LDG AT-200 PC Tuner.

An AT-200 controlled from your PC

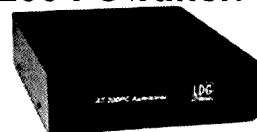

We also supply

LDG DTS-4 and LDG DTS-6 Coax Switches

Amidon Iron Powder and Ferrite Coil Forms

AUTEK WM1 Computing Power/VSWR Meter

PC Based Vector Network Analyzer

Ten Tec HF Transceivers

Buddipole Antennas

Professional RF Cables and Connectors

Solar Panels, Regulators and Batteries

### Who can build a kit?

Essentially anyone. Basic soldering, use of hand tools, the ability to recognize components and follow instructions are important. Several of the kits are assembled in phases with progress tests on each phase before proceeding to the next.

No complex test equipment is needed for these kits, generally a multimeter is all that's required. Check our web site for more kits.



# TTS Systems Communications Equipment

[www.ttssystems.com.au](http://www.ttssystems.com.au)

## HF and VHF Transceivers, Autotuners and Kits

Phone 03 5977 4808. Fax 03 5977 4801 [info@ttssystems.com.au](mailto:info@ttssystems.com.au)

# A dummy load for the new amateur radio practical test

Jim Tregellas VK5JST

During the practical examination for all of the new amateur radio licence categories (but particularly the Foundation licence), the trainee is asked to demonstrate the mastery of various skills to the assessor.

Amongst the most important of these skills are the measurement of system SWR, adjustment of the power output to a specified level for various transmitter modes of operation, correct setting of microphone gain and, finally, correct "on-air" calling and QSY procedures.

All of the above is greatly assisted if a dummy load is available which has a known SWR (other than 1:1 where no reflected power can be measured) and to which a short length of wire can be attached so that practice QSOs can be conducted reliably with another HF transceiver a short distance away without causing significant interference to others.

The photos and circuit detail a very simply constructed dummy load made from printed circuit board scraps. It will dissipate 10 - 15 watts RMS for short overs, and has an SWR of 1:1.5 (in a 50

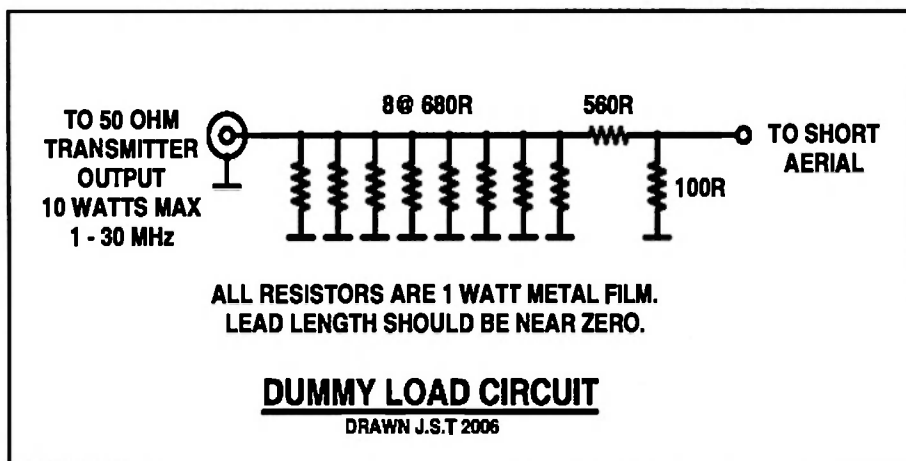

ohm system) over the 1.6 - 30 MHz range. The selection of a 75 ohm impedance for the load means there is enough reflected power to be reliably displayed on an SWR meter, and gives the student firm assurance that he/she is making the

SWR measurement correctly. It also means that the transistor output stages of most transmitters are not placed into self protection mode. Attaching a three metre length of aerial does not change the SWR significantly either. **ar**

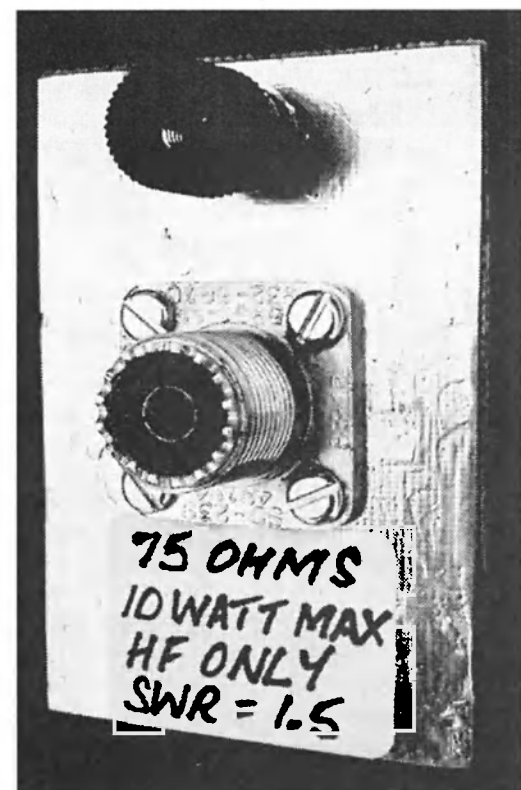

The front of the dummy load.

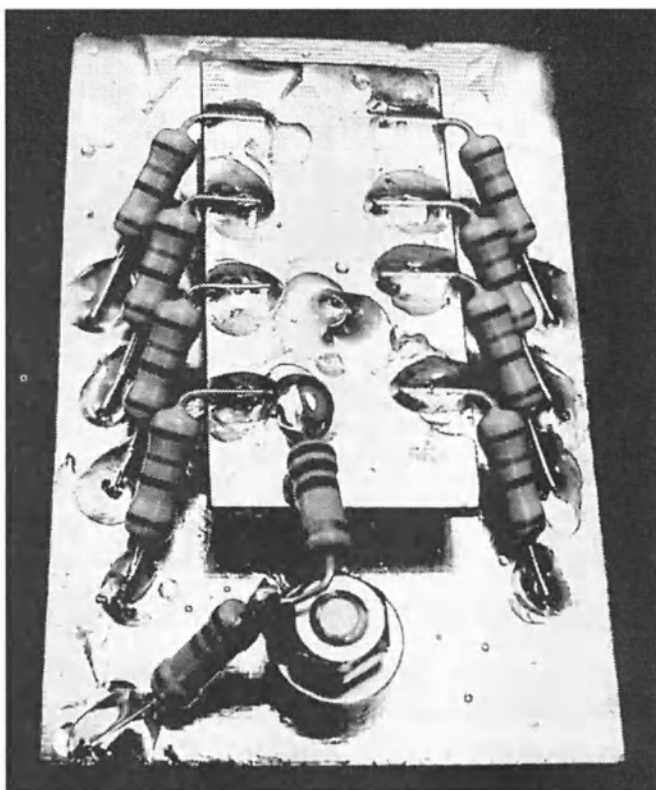

The rear of the dummy load.

# Build a replica of the Paraset or Type VII set

An early WW2 transceiver of the British Secret Service and used by the SOE.

Malcolm R Haskard\* (VK5BA)

## 1. Introduction

In the mid 1990s I discovered a book by Pierre Lorain [1] on clandestine equipment used during WW II.

Amongst the collection of transceiver sets, was a simple compact set called the Paraset and from the drawings and circuit outline given it looked possible to reverse engineer and build one.

Although work commenced then, time was needed to collect the necessary components from that era and thus the set was only completed late 2004.

In this article sufficient details are supplied so that other working replicas can be constructed. The completed replica is shown in Figure 1.

## 2. History

The Type VII set was developed by the Special Communications Group of MI6 at the outset of the war [2, 3] and was used by various clandestine operations including the SOE (Special Operations Executive) in Europe. It was even used by agents at the time of the Normandy landing.

The set, housed in a steel case, has a two valve regenerative receiver covering in one band the frequencies 3 to 8 MHz. The single valve crystal controlled 4 watt transmitter covers a slightly narrower frequency range in two bands, 3.2 to 7.6 MHz. Consequently the set will operate on both the 80 metre and 40 metre amateur bands.

It is easy to tune having a tank circuit and aerial circuit capacitor that are adjusted for maximum brightness of two lamps. The power supply is a separate unit, supplying 6.3 V at 1.1 A for filaments and a high tension of typically 250 V at 50 mA.

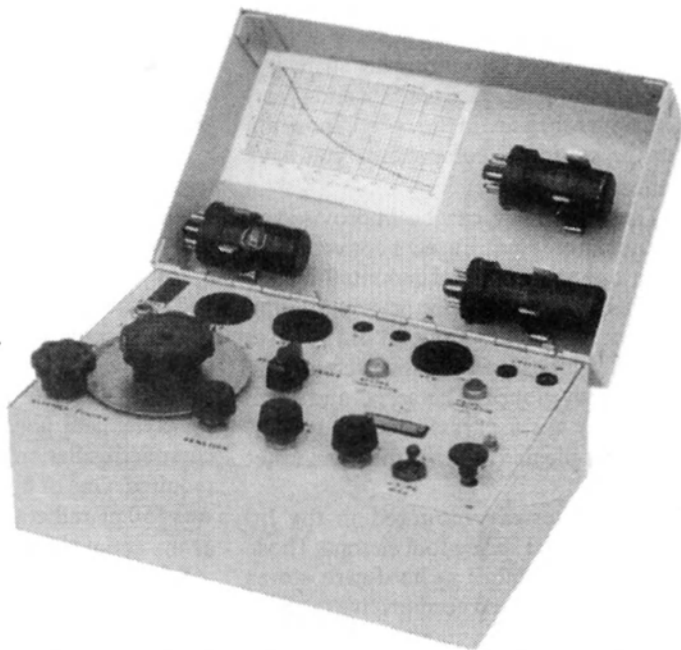

Figure 1. The Type VII or Paraset transceiver replica

## 3. The mechanical construction

Figures 3 and 4 shows the construction (Note 1). The box is made from 18 gauge zinc plated steel sheet, folded and spot welded.

A 7½" long piano hinge across the back allows the lid to open and close. Note the recess for the hinge and the holes drilled must match the hinge selected. The lid is slightly larger than the box so when closed it overhangs the box.

If access is not available to a spot welder then split or pop rivets can be used, and in the case of the latter filling the central hole with plastic steel so when painted, they look like an old style rivet.

An alternative would be to use a wooden case without a hinged lid, which is how the early Parasetts were packaged. The top panel would also have been made from zinc steel, however I chose to use 16 gauge annealed aluminium, a material much easier to work with in a home workshop.

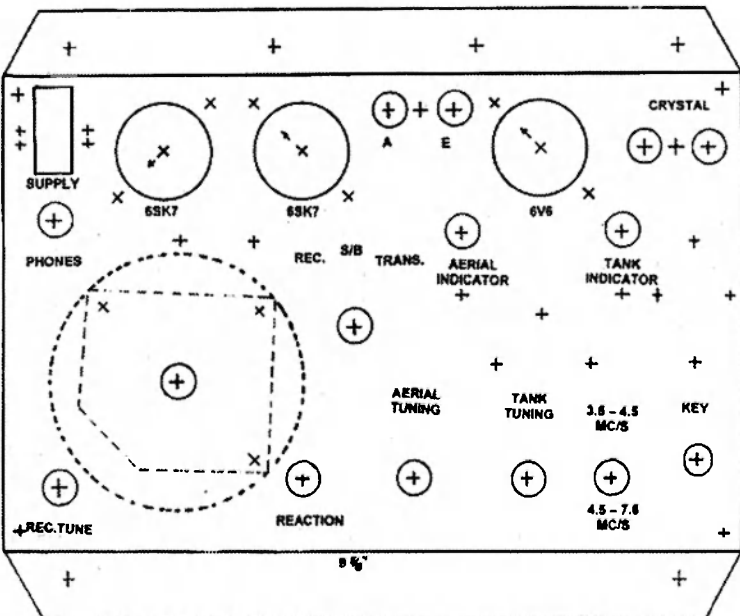

Fig 3 Layout of the operating face of the set (not scale, see Note 1)

The panel has a bent right angle portion at both the top and bottom and this gives additional rigidity so when plugging in and removing the valves the panel does not distort or deflect.

These vertical sections also provide the mounting points to the case, via attached flush fitting bushes such as "Nutserts" or "Prestincerts" fixed to the fold down sections of the top panel.

Should spot welding facilities not be available then the piano hinge can be clamped into place by these screws (4?) into the back "nutserts". Before drilling any of the holes (mounting tag strips and coils, power plug, variable capacitors, etc) make sure they are in the correct position for the particular components you have collected.

The Morse key can be improvised in a number of ways. I used a conventional style one, adapted and mounted upside down. Figure 5 shows the principle. Lamp holders were taken from an old B/C set dial, the globes replaced with screw style 2.5V torch globes. The aerial and earth terminals are a crystal socket holder, matching the one used for the transmitter crystal.

The valves are mounted in the lid using modified spring tool clamps. Those currently available in hardware stores may be too long and need to have the ends trimmed back.

**4. The circuit**

Both transmitter and receive circuits are standard configurations. Most components are non critical (remember in WW II components were 20% tolerance) and in several cases a range of values that can be used is indicated on the circuit diagram.

A problem with capacitors is the

DC working voltage is high and 400 V or 600 V ratings are preferred to 250 V. In many cases I employed old mica capacitors and carbon composition resistors (of 1/2 watt rating) to give the set the appearance of being authentic.

With some capacitor values this was not possible and knowing that many WW II capacitors had a black outer coating I simply painted the more modern components black.

One significant problem was the transmitter toggle switch that switches in the parallel 100 pF capacitor on the lower frequency band.

All of the old style WW II toggle switches I had access to had high contact resistances (switches built for switching high voltages at low currents) and eventually I had to use a more recent variety.

The spacing of the transmitter tank and aerial tuning condensers prevents the use of many B/C set styles and good quality slim ceramic insulation style ones are required. One of the capacitors I acquired was 150 pF rather than 100 and this I used as the aerial tuning capacitor.

With the receiver the power rating of the reaction potentiometer needs to be checked. Allow a 2 mA current flow through it. The series resistor must be selected so that the screen voltage can be varied from zero up to about 65 V.

For the tuning reduction drive I employed a 2" diameter drum and cord, with the tuning knob on a 1/4" diameter shaft reduced to 3/16" so the cord would not wander (See Figure 6). A drive reduction of 10:1 is achieved. The bearing

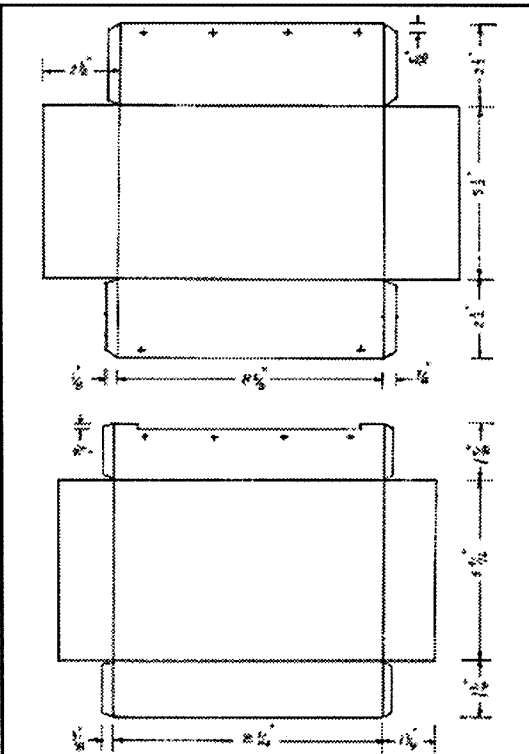

Fig 4. Box construction from 18g zinc plated steel. Holes to suit piano hinge selected

for the 1/4" shaft and knob was taken from an older style potentiometer.

The receiver tuning capacitor is mounted on a separate plate (See dotted outline in Figure 3 and also Figure 6), attached to top panel by bolts and spacers, these being on a radius greater than the 2" drum so there is no interference. Since the tuning capacitor will normally only have a short shaft an extension shaft is needed to take it though the top panel and allow the 3" tuning dial and knob to be added.

The output choke should have an air gap so the standing plate current does not cause saturation. I used a small speaker transformer from a valve B/C receiver. Although I removed the secondary winding, this is not necessary and it can be used so the set can drive modern low impedance headphones.

My choke/transformer was a little too large to mount on the underside of the top panel, between the phone jack and tuning knob and so was mounted with one side fixed to the tuning capacitor plate and the other to the top panel with a stand off spacer (See Figure 7).

The three pin Jones plug and socket for connection to the external power supply was the most difficult component to locate. A 4 pin plug and socket is much more common and can be used.

The two air coil formers, both 1" in diameter and about 2" long were also

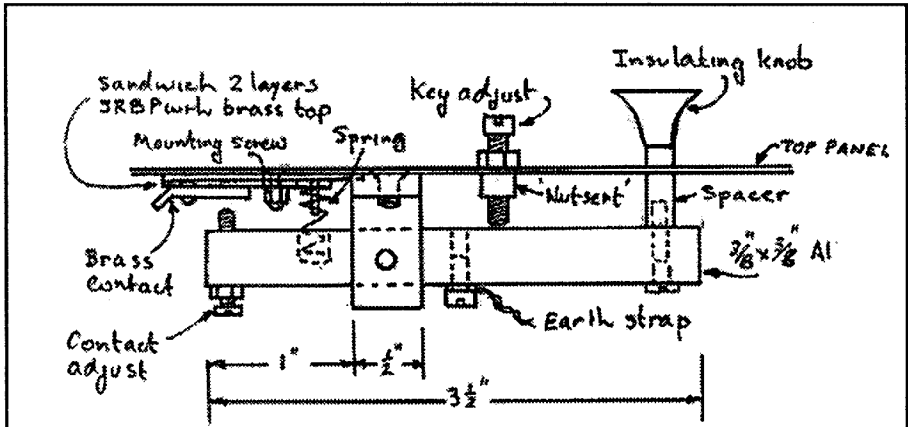
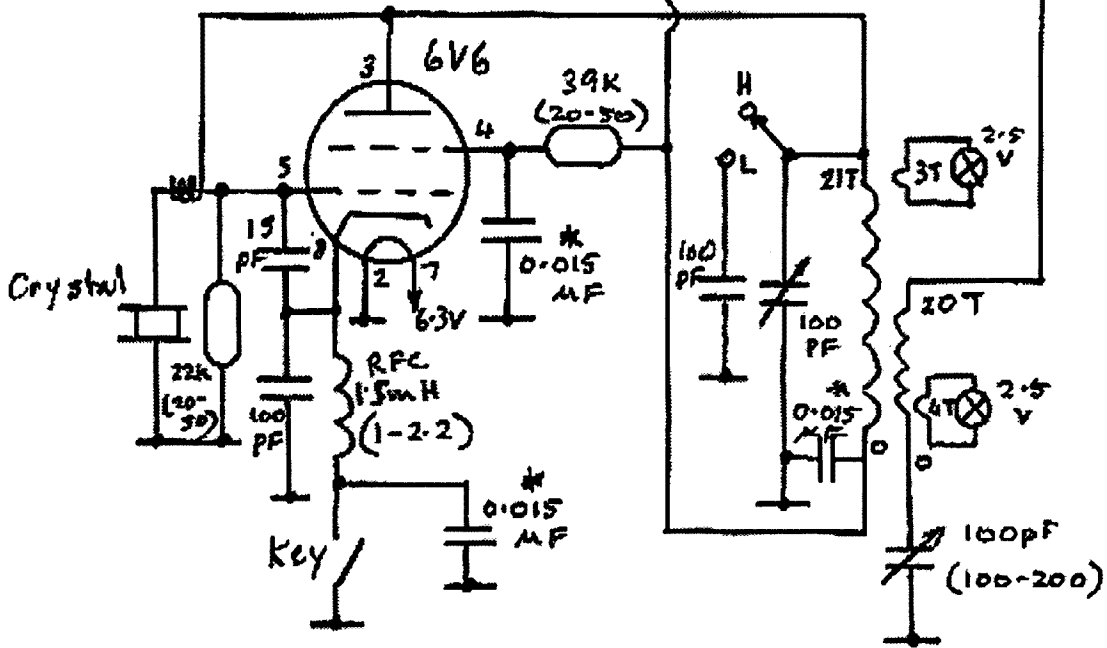
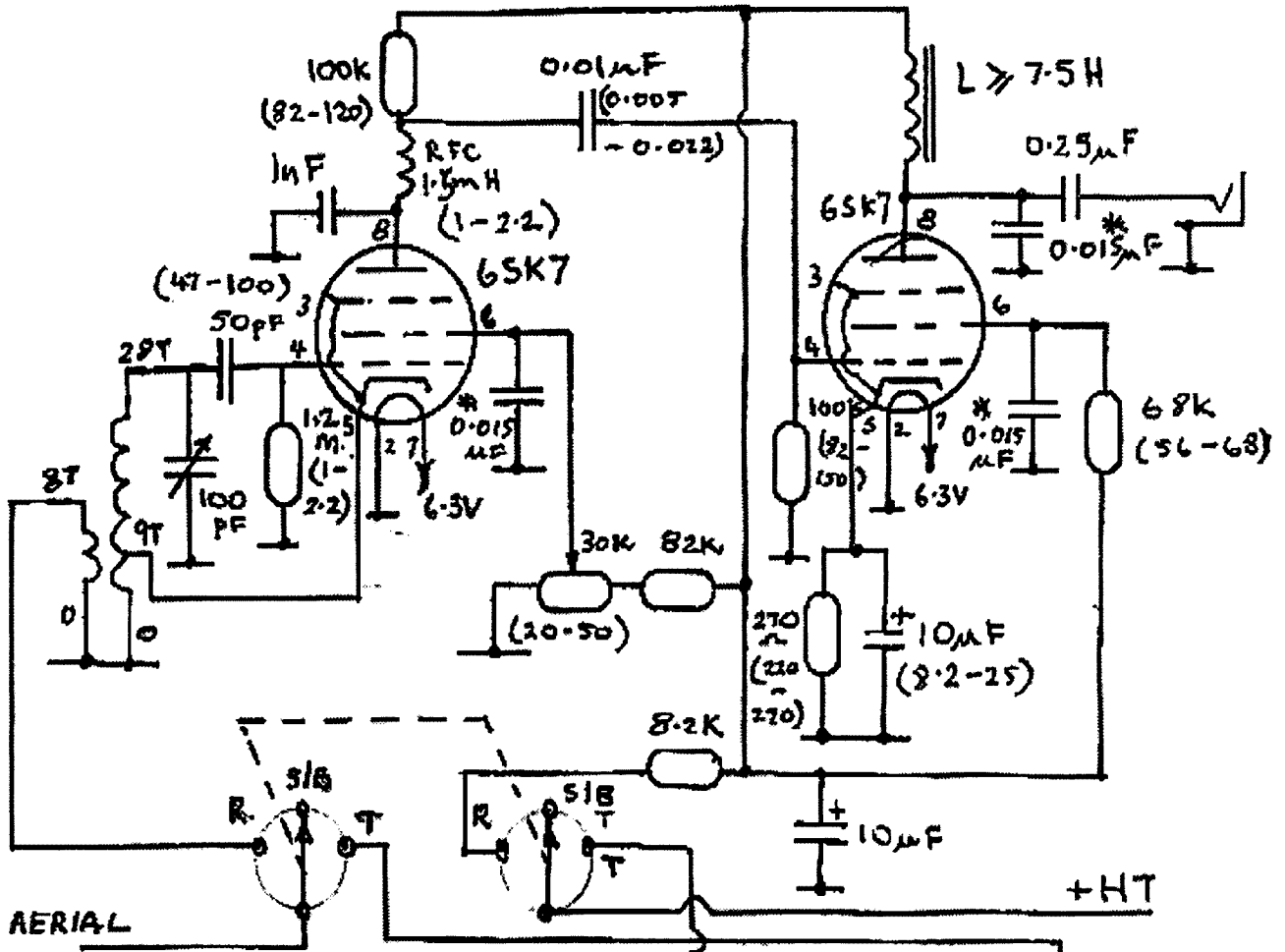

Fig 5 Morse key (not to scale see note 1) Plan view in Fig 7



\* Bypass Capacitors can be in the range 0.002 - 0.01µF

Circuit schematic of the Paraset

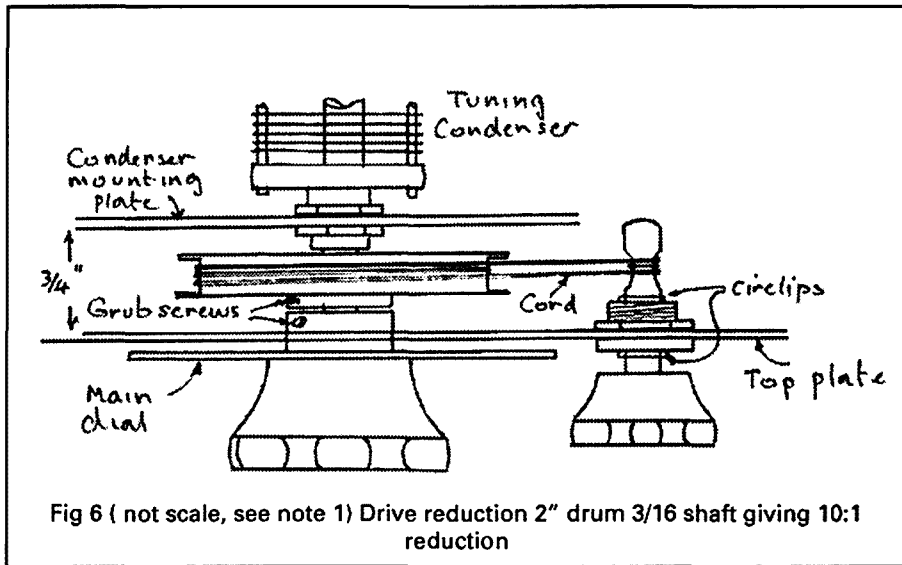

Fig 6 ( not scale, see note 1) Drive reduction 2" drum 3/16 shaft giving 10:1 reduction

the tank circuit lamp will dim as energy is coupled out of the circuit.

Plug in the two 6SK7 valves and check that both warm up when the heater voltage is supplied (Function switch on standby). Turn the regeneration control anticlockwise so on power up there will be zero volts on the screen grid of the regenerative detector valve. Switch to receive, thus applying the HT supply. Faint mains hum should be heard in the earphones. The HT current should be a few mA. Increase the regeneration until a strong hissing noise is heard, being the onset point of regeneration. Any further reaction the receiver breaks into oscillation. Tune across the receiver band and ensure that by adjusting the regeneration control there is always a position where regeneration smoothly occurs. Connect an aerial (or signal generator) and ensure the receiver operates correctly across the whole band. Should there be a drop out point for regeneration then the resistor in series with the regeneration control may need reducing or the cathode tap on the coil be increased beyond 10 turns.

## 6. Conclusion

The set is simple and works well. It should give hours of satisfaction on air as well as being a set to put on display – a replica of a famous WW II transceiver used by the SOE and MI 6.

## 7. References

1. Lorain P, *Secret Warfare, The Arms and Techniques of the Resistance*, (First published in French in 1972 and adapted to English by David Kahn), Orbis Publishing, London 1983.

## 5. Testing

Plug in the transmitter 6V6 valve. Turn the function switch to standby (filament voltage only applied) and ensure the valve heats up.

Next switch the function switch to transmit, applying the high voltage supply (if you can start with a lower voltage value do so) and the HT current should not be more than about 50 mA when the key is depressed.

Insert a crystal and check with a CRO, frequency counter or receiver that the circuit is oscillating when the key is pressed.

Tune the plate circuit and peak the tank indicator lamp (HT current will dip to 15-20mA. Also increase the HT voltage to 250V and the lamp brilliance should increase). If an aerial or load (capacitive) is attached then tune the aerial circuit by peaking the aerial lamp. At the same time

from a B/C receiver and rewound as shown in Figure 8.

The lugs at the top of the coil were made from wire wrap pins. The receiver and transmitter coils were close wound using 0.5 mm enamelled wire for the receiver and 0.8 mm for the transmitter.

The two lamp windings were wound with 0.25 mm enamelled wire, wound on top of the tank and aerial windings at the respective coil ends (Figure 8).

Figure 9 shows the completed top panel. Note the types of knobs used for the bottom row of controls, including the Morse key. The panel and box were spray painted "Dusk Grey" with the lettering either screen printed in black or painted by hand. If the latter I find it easier to use an old fashioned split nib ink pen than a fine paintbrush. The small brass plate (1 3/16" by 3/8") has Serial No. followed by a four digit number stamped on it. It is mounted using two 8BA screws.

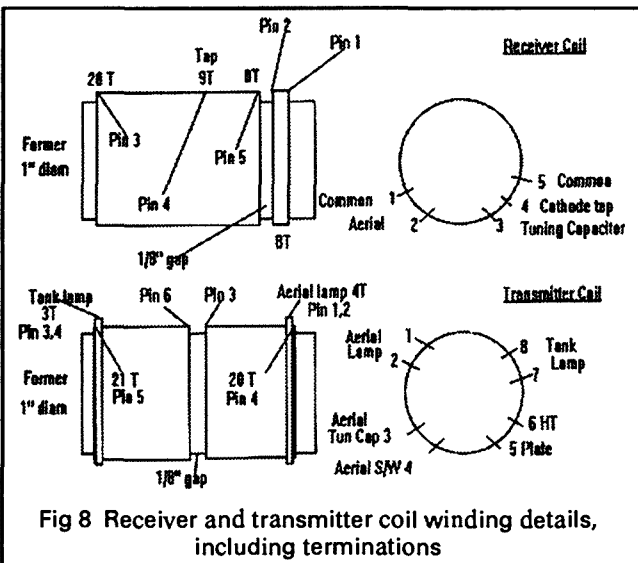

Fig 8 Receiver and transmitter coil winding details, including terminations

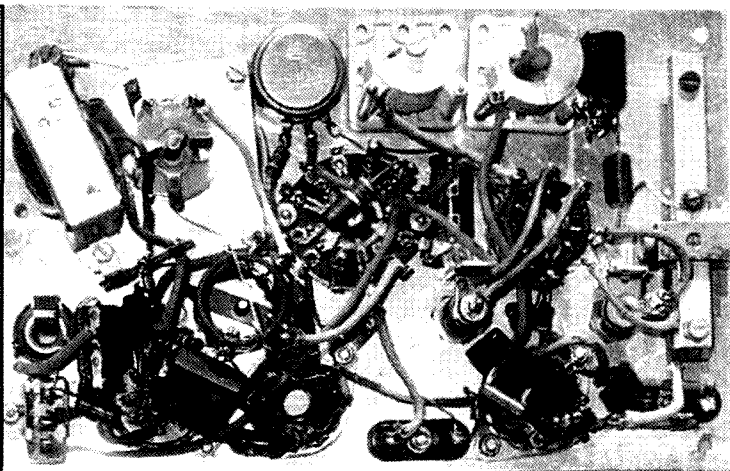

Figure 7. Underside top panel showing component wiring.



Also published in the US as: *Clandestine Operations. The arms and techniques of the Resistance, 1941-1944*, (Adapted by D Kahn) MacMillan Publishing Co, New York, 1983.

- Ladd J and Melton K, *Clandestine Warfare. Weapons and equipment of the SOE and OSS*. Blanford Press, London, 1988. See Appendix 3, Table of Section 7.
- Hawker P, *Clandestine radio – the early years, Parts 1 and 2*, "Wireless World" Vol 88 Nos 1552 and 1553 (Jan/Feb 1982)

**To contact the author:**

School of Electrical and Information Engineering,  
University of South Australia  
Mawson Lakes Blvd.  
Mawson Lakes SA 5095 AUSTRALIA  
Email – malcolm.haskard@unisa.edu.au

**Notes:**

- Some mechanical drawings are reduced in size (Figs 3, 4, 5, 6 & 8). A larger copy is available on request from the Editor in hard copy or as an Acrobat (pdf) file. (Ed.)
- For newer Amateurs unfamiliar with Imperial measure, one inch (1") = 25.4 mm (Ed.).

ar

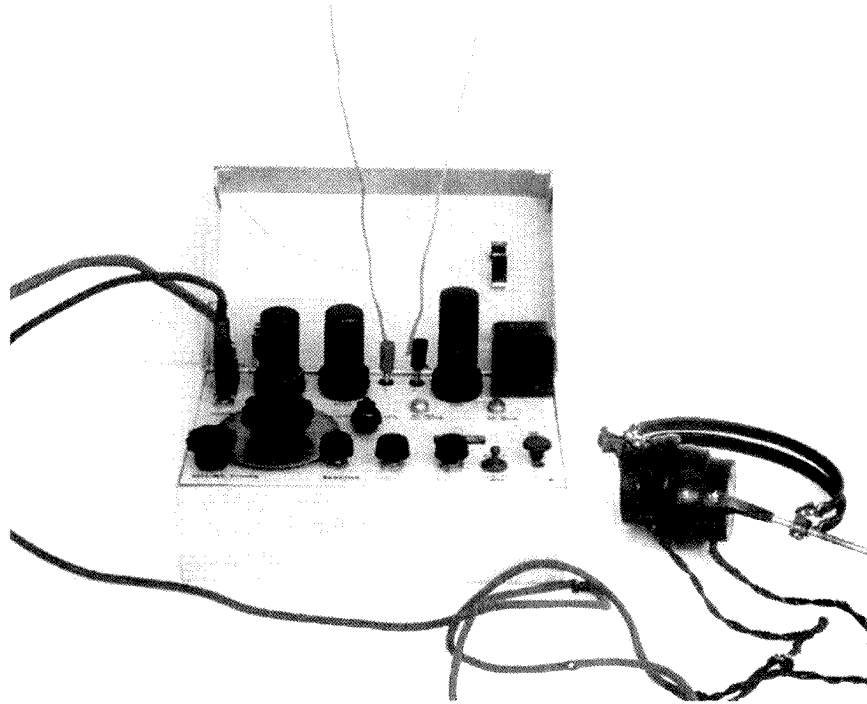

Figure 9. Top panel of the Paraset showing labels and knob styles.

# TET-EMTRON

**New**  
**Tet-Emtron Vertical Range**  
**TEV-4    TEV-3    TEV-3Warc**

**New Tet-Emtron Vertical Range Features**

- All Aluminium with Stainless steel hardware.
- No adjustment needed to main antenna.
- Light.
- Free standing-no guy wires.
- 1 kW PEP power rating.
- Can be ground mounted or elevated.

The new TET-Emtron Vertical range is designed with ease of use in mind. Tuning is done by the radials when the antenna is in its final position (where possible). The radials can either lie on the ground, be buried or hang from the elevated antenna. The antenna comes with a set of radials that has a resonate radial for each band. Further sets can be ordered from TET-Emtron if desired.

**See the web site for more info and a complete dealer list.**

**Antenna Manufacturers**

40 Blackburn Street  
STRATFORD  
Victoria 3862 AUSTRALIA

Ph: 61 3 5145 6179  
Fax: 61 3 5145 6821  
ABN: 87404541761

**www.tet-emtron.com**

*Specifications*

Antenna	TEV-4	TEV-3	TEV-3 Warc
FREQUENCY	7, 14, 21, 28 MHz	14, 21, 28 MHz	10, 18, 24 MHz
ELEMENT HEIGHT	4090 mm	3800 mm	5025 mm
FEED IMPEDANCE	50 OHM	50 OHM	50 OHM
MAX. RADIAL LENGTH	10.7 Meters	5 Meters	7.5 Meters
SWR	1.5 or less	1.5 or less	1.5 or less

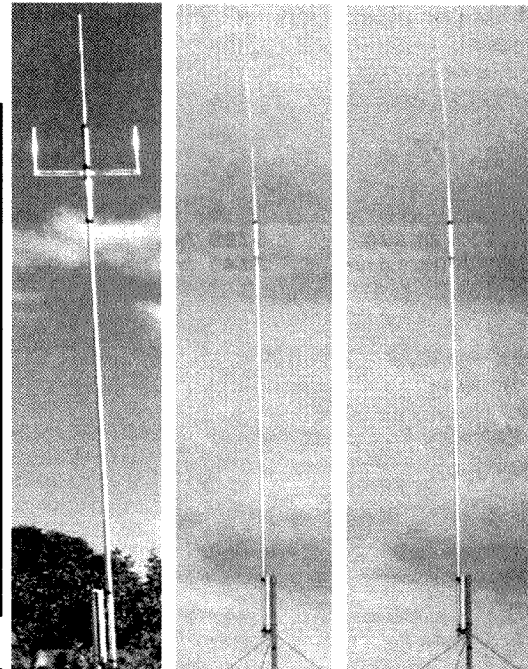

# Maritime mobile operations on low power

Tony Halter VK3TLA

As a teenager growing up in Queensland, I remember becoming very interested in communications and reading *CB Action* and *Amateur Radio Action* on the various exploits of operators all around the globe. In many ways I was envious because I did not have the equipment or ability to even remotely emulate their DX success or otherwise.

Some years later I joined the RAN as an RO (Radio Operator) and was exposed to the interesting and different world of military communications. Singularly, I learnt at the junior levels there wasn't too much playing with radios - mostly shuffling paper and typing signals. However, much was learnt in the early days of my Navy career.

After some time I gained my Commission and completed my various training regimes and completed different sea deployments. I was then posted to RAN Recruit School as a Lieutenant in charge of a division of Recruits. In this position I would have to frequently go to sea on the *Seahorse Spirit* in a supervisory role.

Being an active ham, I immediately discussed the idea of taking 2 m and 70



The Deal Island Group, a stony outcrop in the middle of Bass Strait, viewed from the west. I worked 160 metres to the US on the same day this photograph was taken. The RF noise on Deal Island is very low on the lower bands.

## Andrews Communications Systems

### ICOM DISCOUNTED

IC-756 Pro III HF+6m	<b>\$4,999</b>
IC-V8000 2m 75W	<b>\$399</b>
IC-746 Pro or IC-7000	<b>\$2,699</b>
IC-706 Mk 2G HF-70cm	<b>\$1,399</b>
IC-718 HF SSB	<b>\$999</b>
IC-910H 2m+70cm SSB	<b>\$2,299</b>
IC-208H 2m+70cm	<b>\$579</b>
IC-2200h 2m 60W	<b>\$399</b>
IC-T90A Triband h/h	<b>\$449</b>
IC-2720H Deluxe D/bander	<b>\$699</b>
IC-P7A New tiny D/bander...	<b>\$389</b>

**\*3 YEAR WARRANTY\***

### ALINCO

#### Factory Direct Importer

NEW DR-635T Twinbander	<b>\$699</b>
DR-135T Mk2 2m 50W	<b>\$349</b>
DR-435 UHF 35W	<b>\$369</b>
DJ-V5E Dualband handheld	<b>\$499</b>
DJ-X2000E Hi-tech scanner	<b>\$699</b>

**\*3 YEAR WARRANTY\***

Spectrum Analysers from **\$999**  
Oscilloscopes from 20MHz to 100MHz

### ICOM IC-7000 \$2199



#### HF-70cm COLOUR TFT DISPLAY

IF DSP, Twin PBT, 508 channel memory + more

TS-570SG HF+6m+ ATU	<b>\$1,999</b>	TM-D700A Dualband Mob	<b>\$899</b>
TS-480HX HF 200W+6m	<b>\$1,999</b>	TS-480SAT HF+6m+ ATU	<b>\$1,899</b>
TS-2000 HF-70cm + ATU	<b>\$2,799</b>	TM-G707A 2m/70cm mob.	<b>\$499</b>
TS-570DG HF + ATU	<b>\$1799</b>	TM-V708A Dual band Mob.	<b>\$799</b>
TM-271A K 2m mobile	<b>\$379</b>		

### bhi DSP NES10-2

Amazing DSP speaker

Hundreds sold!

**\$249**



### KENWOOD DISCOUNTED

TS-570SG HF+6m+ ATU	<b>\$1,999</b>	TM-D700A Dualband Mob	<b>\$899</b>
TS-480HX HF 200W+6m	<b>\$1,999</b>	TS-480SAT HF+6m+ ATU	<b>\$1,899</b>
TS-2000 HF-70cm + ATU	<b>\$2,799</b>	TM-G707A 2m/70cm mob.	<b>\$499</b>
TS-570DG HF + ATU	<b>\$1799</b>	TM-V708A Dual band Mob.	<b>\$799</b>
TM-271A K 2m mobile	<b>\$379</b>		

**\*3 YEAR WARRANTY\***

**NEW**

### YAESU DISCOUNTED

FT-1802M 2m 50W Mob.	<b>\$229</b>	FT-60R Dualband h/h	<b>\$369</b>
FT-7800R Dualband	<b>\$449</b>	FT-817ND HF-70cm Port.	<b>\$999</b>
FT-8900R Quadband	<b>\$799</b>	VX-1R H/held 2 batts	<b>\$249</b>
FT-8800R Dualband	<b>\$699</b>	VX-2R Tiny Dualband	<b>\$319</b>
FT-897D HF-70cm	<b>\$1,399</b>	VX-170 2m H/held	<b>\$269</b>
FT-857D HF-70cm	<b>\$1,299</b>	VX-6R Dual H/H	<b>\$449</b>
FT-2800M 2m 65W	<b>\$299</b>	VX-7R Deluxe H/H	<b>\$549</b>

**\*YAESU ROTATORS DISCOUNTED\***

**\*3 YEAR WARRANTY\***

**Australia's Biggest Amateur Radio Stockist**

### HF VERTICAL ANTENNA SALE

DIAMOND CP-6, 80m-6m	<b>\$399</b>
DIAMOND BB7V Broadband	<b>\$449</b>
COMET CHA-250B B/band	<b>\$599</b>
MALDOL HVU-8, 80m-2m...	<b>\$499</b>
HY-GAIN DX-88, 80m-10m...	<b>\$799</b>
THP, LDG, MFJ, ALINCO, ICOM, YAESU	
Automatic antenna tuners in stock	
TET-EMTRON HF Antennas in stock	
AVAIR POWER METERS, 'T' LEADS, ETC.	
MFJ Antennas, Tuners, Analysers, etc.	
ANDREWS AMPS...160m-10m 500W+	
w/protect. \$999, 2m 120W \$329,	
200W \$449, 300W \$999.	
ANDREWS YAESU, PALOMAR, TE SYS-	
TEMS, AMERITRON, ICOM linears	

### ANDREWS AMATEUR BASE ANTENNAS

BF-2M2 Fibreglass 2m 6.7dB	<b>\$99</b>
BF-2M3 Fibreglass 2m 7.8dB	<b>\$129</b>
UVS-200 Fibreglass 6dB/8dB	<b>\$149</b>
UVS-300 F/glass 8.3dB/11.7dB	<b>\$199</b>
CBS18 Fibreglass 5.7dB 10m \$179	
Discones from \$99, Coax switch \$29	
Hustler	From <b>\$349</b>

We export worldwide.

We also hold some stock in New Zealand

**CALL (02) 9636-9060 or (02) 9688-4301 or FAX (02) 9688-1995**

Shop 8, 41 Bathurst St., Greystanes, NSW 2145

**MAIL ORDER to PO Box 240 PENDLE HILL NSW, 2145**

<http://www.andrewscom.com.au>

email: [lee.andrews1@bigpond.com](mailto:lee.andrews1@bigpond.com)

Some items  
indent  
Prices subject to  
change without  
notice  
Limited stock  
some items  
E&OE 8/06

cm to sea with the Master of the vessel. Unlike a commissioned RAN vessel, there are no restrictions of emissions. *Seahorse Spirit* (VKNG) is a merchant vessel operated by Defence Maritime Services. The master indicated that, provided I operated on a strict non-interference basis, there would be no problem. So, it began the very next week.

I initially operated my FT-7800 portable with a GelCell battery in a green metal box with the antenna mounted on the box. This, however, meant that I had to be on the bridge wings or out in the weather to operate the radio. Winter time in Bass Strait is not at all pleasant. So, there had to be a better way. I decided to take a ground independent mobile 2 m and 70 cm antenna to sea. Dave Wilson of TTS Systems at Tyabb kindly provided me with an antenna until the arrival of the Diamond SG7500 Dual Band antenna.

This proved to be very successful; however, I had often, on air and otherwise, discussed how well HF would work at sea. My earlier communications training and experience gave me the impression that I would do very well from sea. But, I did not have a suitable rig to take to sea. And there was a significant issue with what antenna to use. Again, Dave from TTS came to the rescue. He offered me the use of the SGC 2020 20 Watt HF rig and the SG-237 Smartuner.

I initially balked. However, on further consideration I jumped at the opportunity. I already had the means to power the radio – the Gel Cell and a small power supply for the tuner. We decided that I would take the aluminium tubing from a Station Master Mk II. Initial testing revealed that the Smartuner easily handled the length of tubing on 80 metres. However, when I returned to the ship I quickly discovered that there was very little mounting space for another HF vertical antenna. I decided to go with plan B, a wire antenna. As it turned out this was a very good decision, albeit forced by circumstance.

So, after the installation I could hardly wait to try out the radio. It was at about 1000 hrs local when I fired it up. I called VK3MED, who was situated about 20 km to the south, and we conducted a test. The Smartuner and SG2020 were a formidable team. I selected CW on the radio and, with two short bursts on the key, the antenna was tuned and I was on 80 metres. Dave and I continued to test all of the bands, some of which Dave could only listen on and report back to me on 2 metres. Signals



The "shack" was set up in my stateroom (cabin/office). The SG2020 is just above my left hand, with the metal box housing the 18 Ah GelCell and the body of the FT-7800 behind it. The remote head of the FT-7800 can be seen between the desk lamp and the phone. The GelCell battery is charged by a 1 amp Arlec charger. The efficiency of this charge seemed to be affected by the ship's 60 Hz supply.



The *Seahorse Spirit*.



The SG-237 Smartuner on deck.

were S9 or greater on the bands tested. Finally, I had HF at sea.

Throughout the afternoon I managed some contacts on 40 and 20 metres. I noticed on the lower bands that the radio was not performing as well as I had expected. Originally, I had only 14 metres of wire aloft. On Tuesday morning, when the ship went to anchor at Deal Island, I proceeded aloft and altered the length of the antenna, bringing it to about 29 metres. This functioned far better.

At this point I will briefly talk about the safety issues on board ship. When a ship is under way often the RADAR is radiating and rotating. The slotted wave guide antenna visible in the photos can radiate large amount of RF. This is very hazardous, particularly when possibly grounding out antennas, etc when in close proximity to the rotating antennas. For safety reasons I did not access the antenna areas until the RADAR was switched to stand by and not rotating or radiating. This is a very important safety issue, as Masters are often reluctant to isolate RADAR equipment whilst under way. Therefore it is better to wait until the ship is at anchor.

With the extension on to the antenna I noticed a real difference. I was attempting to operate on the VK7 afternoon 80 metre net. On Monday afternoon I could barely make contact. On Tuesday afternoon with the longer antenna I was receiving S9 from most in the net. Also, working back to Melbourne I was having no difficulty. All of this on low power. I decided to try my hand at DXing next and I was pleasantly surprised.

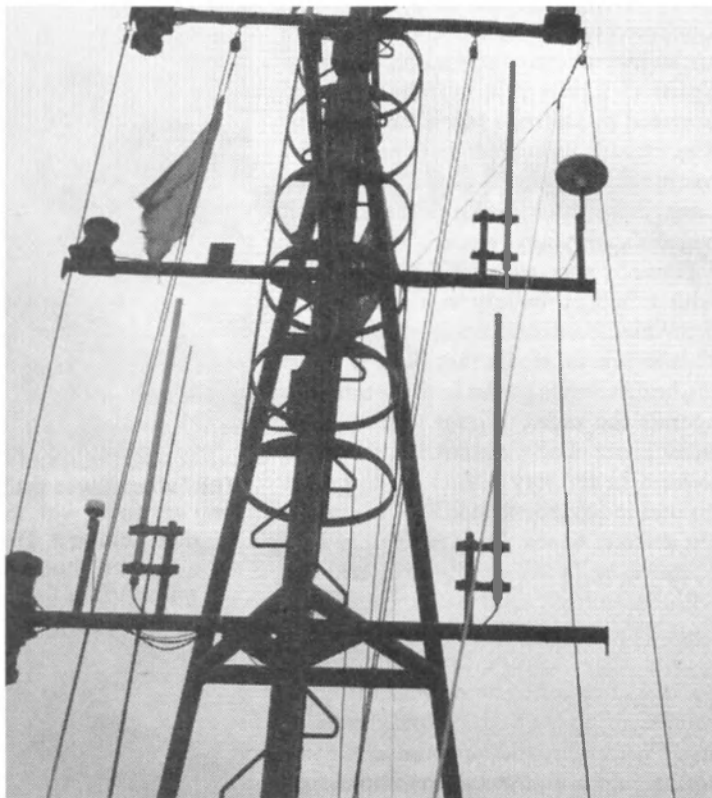

The HF wire antenna passes over the OMNI TV antenna (top right of photo) and back down the other side providing a length of 29 metres.

Simplex  
and Duplex  
operation

# Handhelds 2m or 70cm

LOCKED OUT FOR HAM BAND ONLY

144 TO 148 MHZ (VHF)(2M) OR 420 TO 450 MHZ (UHF)(70CM)

## SPECIFICATIONS:

- 1) Voice Prompt on Keypad
  - 2) CTCSS with 39 codes
  - 3) 99 Storage channels
  - 4) Auto scan
  - 5) Large screen LCD
  - 6) Back Lighting
  - 7) VFO programmed (input the frequency from keypad)
  - 8) Hi & Lo Power select
  - 9) Channel spacing: 5KHz, 10KHz, 12.5KHz, 25KHz
  - 10) Keypad lock
  - 11) Monitor function (input frequency)
  - 12) Low-battery warning
  - 13) Frequency Modulation
  - 14) Auto power save
  - 15) Output power: 4 - 5W
  - 16) Large-capacity battery
  - 17) Ear/micro/phone/auto-charger connections
- (Note: No DTMF but I am working with the factory to produce it) I am in daily contact with the factory and they have assured me they will provide support if required.



# \$99

delivered in  
Australia

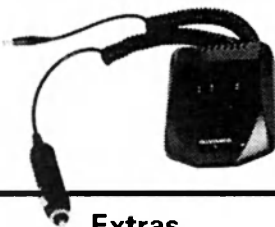

## Extras

Extra Battery (1100mah)	\$10
Speaker Microphone	\$11
Car Charger	\$12
(can charge spare battery and handheld at the same time)	
Headset/Microphone	\$8
SMA to BNC Converter	\$5

Geoff White (VK6NX) **08 9498 1157**

(Please leave a message if unavailable, I'm at home looking after a 1 year old future ham)

116 Amethyst Cres, Mt Richon, WA 6112

**cityonline@wdsi.com.au**

Payment via Paypal, Cheque or Bank Transfer.

I felt that, with low power (less than 20 watts ERP), grey line propagation would be my best hope, and this proved to be the case on Tuesday, Wednesday and Thursday nights. I managed to work European stations in Slovenia, Ukraine, Norway and Spain most nights on 20 metres. 40 metres would get me through to the US in the evenings as well as the 80 metre DX window.

Dave from TTS was quite impressed with the sound of the rig when I conversed with him as well. One feature of the rig which can not be understated was the DSP2 software of the SG2020. This feature alone makes it a worthwhile purchase. It turned very ordinary bands with high QRM/QRN in to VHF quality audio. I did notice that this was when the signal strength of the contact was about 3 or 4. It was really good for separating the 'wheat from the chaff' so to speak.

On VHF/UHF I had a high degree of success. On Tuesday morning, approximately 30 miles to the east of Deal Island, I managed to work in to north-west Tasmania on the Mount Read repeater VK7RWC. I estimated the distance somewhere about 320 km. Later the same day, I worked in to VK7RAA. During this contact a number of stations reported that I could be heard on simplex and a simplex contact was briefly established. As was a 70 cm contact on VK7RBH. All of these contacts were on about 20 watts.

The experience reminded me of some valuable lessons. Firstly, on low power you can get through, if you persist. New Foundation licence holders please note: You have access to the bands that WILL give you DX contacts. It is simply a matter of persistence. Operating at sea is very advantageous. The 'maritime mobile' at the end of the call sign does attract interest from DX stations, particularly in a pile up, and the level of ambient RF noise is much lower away from the coast. That is a distinct advantage. The other thing

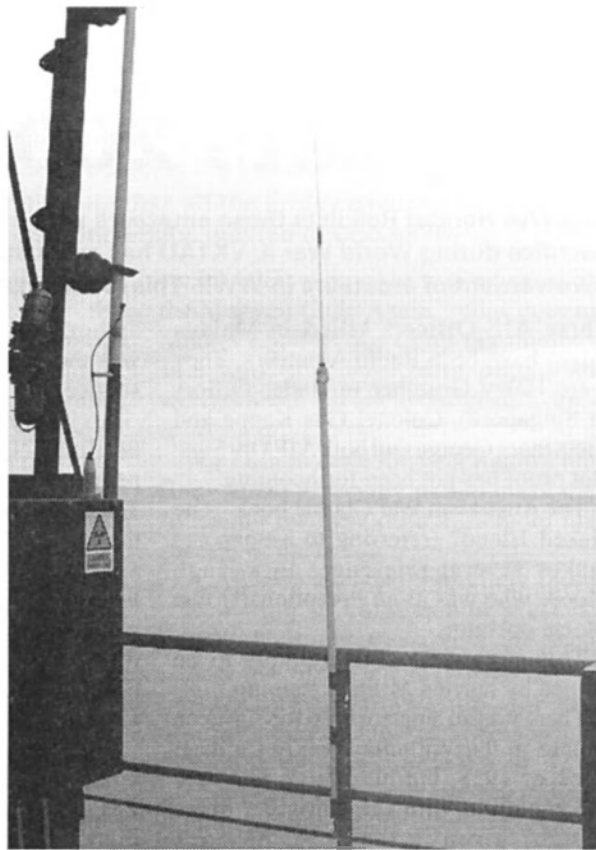

Dual band antenna inserted in to PVC pipe fastened to the guard rail 15 m above the sea. The antenna was fed with RG-214 double shielded cable.

I relearned is that automatic tuners are great. Sure, they are expensive, but a rig with all of the 'wiz bang' gear is nothing without a good antenna. An automatic tuner makes that piece of random wire into a really good antenna.

I had a fun week at sea, and I would like to thank Dave from TTS for providing all the great gear to take, and the assistance to get it on air. Also, thanks to the Master of *Seahorse Spirit* for allowing me to put some antennas temporarily on the ship.

A visit to Deal Island it is well worth the trip. It is very picturesque and would prove an excellent temporary QTH for a DXpedition or light house weekend. There is plenty of room to erect that 160 meter dipole or that tri-band beam. The caretakers are on a three months voluntary basis, accommodation provided, with Tasmania Parks and Wildlife Service.

If you were looking for three months break from society and a serious DX QTH, Deal Island may be of interest to you. There is also extra accommodation which may suit a light house weekend or DXpedition.

## Australian made ANTENNAS Setting a new standard COM-AN-TENA

(formerly a j and j coman)

115 John Street  
GLENROY 3046

23 cm 36 ele slot fed yagi beam	\$190
2 ele delta loop 10/11 metre	\$249
2 ele quad 10/11 metre	\$249
10/11 beams comp opt 5 ele	\$327
10/11 5/8 vert 4 rad 1/4 wave	\$185
Tri band IIB 35 C 10/15/20 m	\$745
3 ele 20 m comp opt	\$460
log periodic 9 ele 13 30 8.4 boom	\$990
MBV 6-12-15-17-20-40-80	\$390
40 m linear loaded 2 ele beam	\$595
M B Vert auto switch 10/80 m	\$330
6 m 7 ele yagi beam 60 mm boom	\$387
6 m 5 ele comptr opt beam	\$275
Top loaded 160 m vert	\$430
10 ele high gain 2 m 3.9 m boom	\$149
17 ele high gain 70 cm 3m boom	\$129
Rotable dipole 40 m	\$250
80 m top loaded vertical	\$239
dual band 2 m & 70 vert	\$140

### Guyed Masts

**21 metres**                      **13 metres**  
Winch-up & tilt-over. Aluminium and stainless steel  
three-sided construction. Auto-brake winches.

### Free Standing Masts 9.5 metres

**New Baluns**  
1-1 to 16-1 to 3kW



Our Masts  
meet Australian  
Standards.  
We supply all the  
computations and  
data you will need for  
a permit.

**03 9773 3271**  
**Mob: 0419 542 437**

ar

# Amateur Radio Bookshop

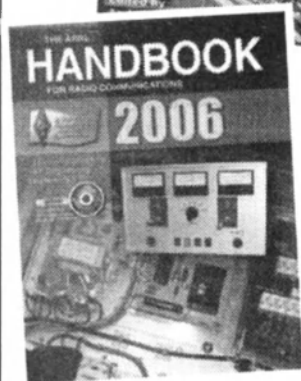

Download our catalogue at

<http://www.wia.org.au>

Amateur Radio Bookshop

PO BOX 3084

EAST BLAXLAND

NSW 2774

Office: WIA National Office

Tel 03 9528-5962

Fax 03 9523-8191

[bookshop@wia.org.au](mailto:bookshop@wia.org.au)

**ARRL – RSGB  
publications  
books  
magazines  
CDROMs - DVDs**

# WIA Honour Roll — update 2006

Col Harvey VK1AU

The WIA Honour Roll lists those amateurs who made the supreme sacrifice during World War II. VK1AU has exhaustively researched the involvement of amateurs in WWII. This is the final report.

Three AIF Officers killed in Malaya might have been Radio Amateurs. They were Harry Grumber (a Radar Officer in Singapore), Colonel Gus Kappe and Lieutenant George Gill both AIF Div Sigs. But proof has not been forthcoming.

The Australian War Classic book "The Naked Island" (referring to Singapore) makes several references to a Hugh Moore who was as an exceptionally fast Morse operator.

This suggests a skill unlikely to be gained by hurried Military training.

There was an amateur with the surname Moore in the Wireless Weekly Callsign book of 1938, but his initials E.A. are incompatible with the Christian name "Hugh" given in the book. Moore's callsigns are shown as VK2QH and VK2ABG. There is weak circumstantial evidence that E.A. Moore who lived in Sydney may have been at Sydney University with Russell Braddon, the author of the book which refers to Hugh Moore's operating skill.

Another Australian War Classic Book "The Coast Watchers" gives encyclopaedic coverage of the Coastwatch Service. Its

author, Navy Commander Eric Feldt, was the pre-war founder of this unique service.

An Appendix names more than 400 civilian, Navy, Army and Air Force people who operated the Service using Teleradio equipment. Every surname in the appendix has been checked against almost 1800 known pre-war amateur licensees. Only sixteen surname matches were found. Of these, only one was followed by a Christian name match and this (Lieut. D.A. Laws VK4DR) was already known.

Eighteen of these Coastwatchers were killed and 11 listed as missing in action. The team earned 77 decorations, ranging from 21 Mentioned In Despatches, through 8 Military Crosses to 15 Distinguished Service Crosses. But for difficulties in making cross-service commendations, more would have been decorated for their part in protracted, dangerous & difficult operations.

Although it is highly unlikely that so few Amateur operators lost their lives in WW2, Honour Roll listings have reached a dead end. SK

ar



The Watcher. from "SIGNALS, Story of the Australian Corps of Signals"  
Artist L Kelly — Halstead Press 1944

# GippsTech 2006 – a quick summary

Peter Freeman VK3KAI

In early July, 101 amateurs and 19 partners converged on the Latrobe Valley, 170 km to the east of Melbourne for the ninth annual Gippsland Technical Conference. This was a record attendance to date. Over 50 gathered for an informal dinner and get-together on the Friday evening. On Saturday morning, all converged on the Gippsland Campus of Monash University, located in Churchill.

The 19 partners departed quickly for a tour of some of the local features – this year there was an historical celebration occurring in the small hamlet of Walhalla, deep in the foothills of the Great Dividing Range. Pauline Corrigan led the ladies' activities, ably assisted by "the Pom" (a.k.a. Mike VK3NMK) as the minibus driver, only just back from a trip to the homeland to visit family.

In Churchill, the amateurs settled in for a packed program. WIA President Michael Owen was kind enough to open proceedings and to talk about some of the topical issues at a national level. A total of 18 further technical presentations filled out the program over the next day and a half, covering a variety of topics from modern vehicle electronics and their interactions with transceivers through to microwave EME communications and optical communication experiments. The conference has a broad theme of weak-signal VHF, UHF and microwave communications.

Saturday evening saw 85 amateurs and partners enjoying a chance for relaxed

social interaction over a good meal at the Morwell Club. Again, kudos goes to Mike VK3NMK for using the minibus as a "taxi" for dinner participants – no worries about having to designate a non-drinking driver!

The Eastern Zone Amateur Radio Club (Inc) would especially like to thank the following for their contributions to the success of the event:

- All who attended, especially those willing to volunteer to present. Without presenters, an event such as this would not be possible.
- Churchill Lions Club, for the provision of lunches at reasonable cost (and especially at low energy input from the organising committee!).
- Pauline Corrigan and Mike Hurnell VK3NMK, for taking such good care of the Partners' Tour – a key component of the success of this event.
- Monash University Gippsland Campus for access to top quality

facilities at a significant discount, and for the production of the Proceedings volume from the 2005 event.

- Special thanks must go to the following, for their generous donations to the impromptu raffle: TTS Systems of Cranbourne for the RF5 Antenna Analyser, RF Resale for the RF Connector kit and numerous items for the "junk table", VK5 Equipment Supply Committee for the HF PA stage, VK3XP & Bosch for the Automotive Interference Handbooks, Richard VK3ZCL for CDs of filter design software, Bryan VK3YNG for interface circuit boards for the AS5040 position encoder chip and Icom (via AA Radio) for numerous small items. These items brought in over \$800, by themselves covering the venue costs for the weekend.

The Eastern Zone ARC looks forward to seeing you at GippsTech 2007, to be held on the weekend of July 7 & 8. Put it in your diary now.

ar

## Radio Amateurs Old Timers Club (South Australia)

### The Annual Luncheon

will be held on

**Thursday, 26th October 2006**

(12 noon for 12.30 pm lunch)

*Please bring your Seniors Card.*

**Venue:** Marion Hotel, Marion Road, Mitchell Park  
Public transport Bus 243, stop 24.

*RSVP to one of the following committee members before 22nd October 2006:*

**President:** Jim McLachlan VK5NB - phone 8294 2992  
**Secretary:** Ray Deane VK5RK - phone 8271 5401  
**Assistant Secretary:** Ron Coat VK5RV - phone 8296 6681

## OzSpid Rotators

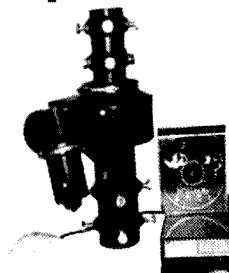

Oceania - New Zealand - Australian  
Distributors.

Australian Enterprise Industrial

P.O. Box 1013

Browns Plains, QLD. 4118.

Ph. 0414 254 080.

Fax. 07 3800 8003.

aceutower@spin.net.au

# Mark 4 CW transmitter for 3.5 MHz and 7 MHz

Drew Diamond VK3XU

Photographs by Andrew Diamond

**It is a singular pleasure to operate on air a transmitter and/or receiver of one's own construction. Except for the amateur with a desire to build, there appears to be only two kinds of published circuit from which to draw ideas: the cut-to-the-bone KISS (keep it stupidly simple) and the fully optioned "all-bells-and-whistles" outfit.**

Counter to expectations, CW (Morse) continues in active use on our bands. Indeed, now that Morse is no longer a mandatory qualification for full HF privileges, our CW segments are enjoying renewed interest from enthusiasts who now freely choose to use the mode.

Numerous outlines may be found for very basic CW transmitters and they certainly make ideal "fun" projects to demonstrate just how simple a CW station can be.

However, a one or two-stage solid-state transmitter will almost certainly be chirpy, clicky, and generate harmonics and/or spurious signals. We must always remember, any signal that we regularly

put to air, even a QRP one, should be as clean and stable as can reasonably be achieved.

Here is a fourth model (Mark 4) of a circuit, which has evolved over more than a decade. It is intended as a companion to the Simple Superhet receiver (Photo 1). I have tried to make it as uncomplicated as possible, yet produce an on-air signal that sounds as good as any factory-made rig. Output power on 3.5 MHz and 7 MHz is at least 5 W into 50  $\Omega$  from a 12.6 V DC supply. Harmonics are more than 45 dB below the fundamental. The output power amplifier (PA) is very tolerant of load mismatch, and can operate into a short or an open load without damage.

The PA remains stable, even under serious mismatch or reactive load conditions.

Best simplicity is achieved by employing variable crystal (VXO) control. Cheap, stock QRP frequency crystals are available from at least one mail-order supplier, and a single 3.520 MHz ceramic resonator covers the entire CW segment of 3.5 MHz. 7 MHz crystals can be "pulled" about 6 kHz in this circuit.

## Circuit

The line-up is the classic oscillator-buffer-driver-PA configuration, which allows the oscillator to run continuously during sending periods. Ordinary semiconductors are used throughout. The



Photo 1 - Complete 2-band CW station.



crystal (or ceramic resonator) is maintained in oscillation with a 2N5485 FET. In order to provide a constant frequency, a second 2N5485 buffer amplifier is placed between the oscillator and the keyed driver, which effectively isolates the oscillator from load variations of the keyed stage.

A 74HC04 CMOS hex inverter is wired so that five paralleled inverters drive the gate of the IRF510 power MOSFET PA. The square-wave signal from the driver turns the PA on and off at signal frequency, whereupon a square-wave is produced at the drain. To provide a smooth control over the output power, an adjustable amount of forward bias is applied to the gate of the PA. Output may thus be varied from less than 100 mW to a maximum power of nominally 5 W.

On-off keying of the driver (and bias supply) is had with a single 2N3906 PNP transistor in series with a regulated 8 V supply. The 220 nF capacitor



Photo 2 - Circuit board layouts (front panel lowered for clarity).

and 22 k resistor give a rise-time of about 3 milliseconds, and a fall-time of about 10 ms, to effect crisp, click-free keying.

Drain impedance of about  $12.5 \Omega$  is stepped up to  $50 \Omega$  through a 1:4 broadband toroidal transformer. The transformer also functions as the drain current feed choke. The output waveform is a very fruity square-wave, so the signal must be passed through an appropriate seven-element low-pass filter (LPF) to attenuate harmonics to an acceptable level.

A supply voltage of nominally 12.6 V DC is provided by a popular LM317 regulator chip, which can supply up to about

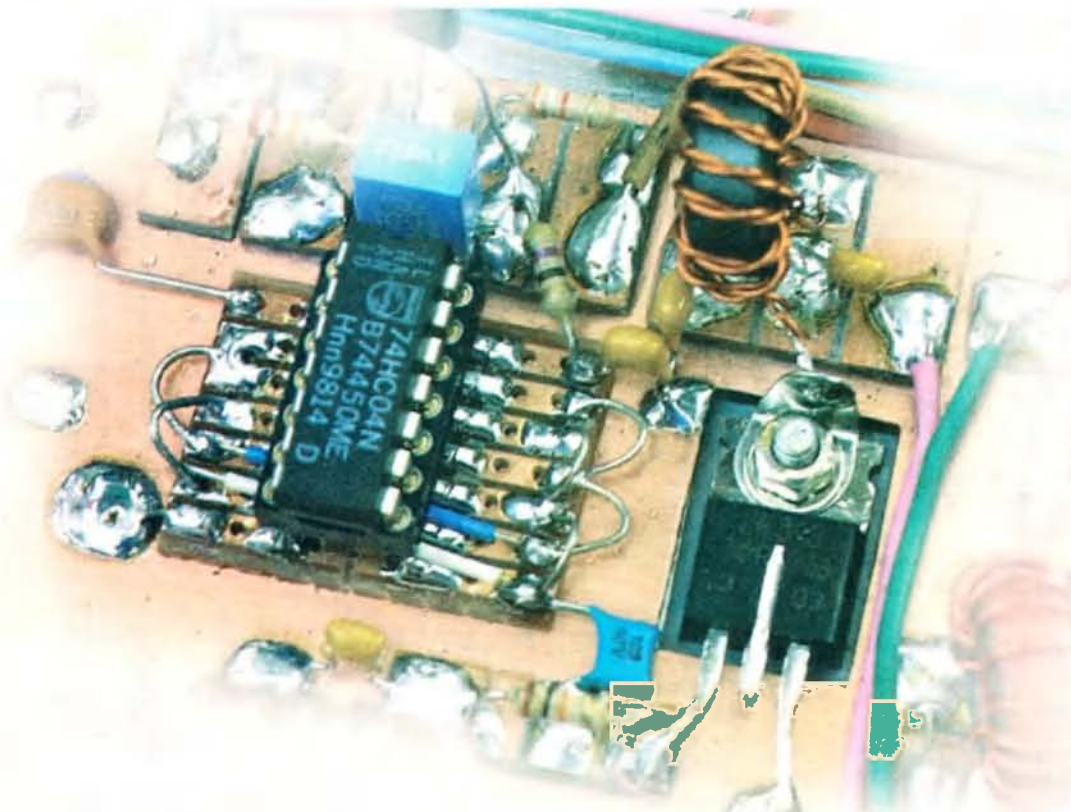

Photo 3 - 74HC04 substrate and PA





1.5 A, but no more, thus adding a useful level of protection for the PA. The supply may also power a companion receiver.

**Construction**

The prototype model (centre, Photo 1) is housed in a homemade aluminium case measuring 190 x 190 x 60 mm (the same "foot-print" as the receiver). Any metal case of similar size will do.

The transmitter circuitry is accommodated "paddyboard" style (Reference 1) upon a copper-side-up board. The power supply is wired upon a separate board. Suggested layouts are illustrated in Figs 2 and 3, and Photo 2. The chassis/case acts as a heat-sink for the LM317 regulator. Make sure you include a silicone washer and the necessary mounting hardware.

The 74HC04 driver chip is accommodated in a 14-pin IC socket, which, in turn, is soldered to a 7-strip x 25 mm substrate of "Vero" board (Photo 3). A single, shallow, junior hacksaw cut is made along the Vero's length to separate the pins each side of the chip. With care,

the socket may now be soldered to the substrate (copper-side-up) so that the IC pins simply contact the copper strips, rather than pass through the holes (and risk shorting to the board foil). The substrate is then (sparingly) super-glued to the main board.

To wind the PA output transformer, take two 270 mm (approx) lengths of #24 B&S (0.5 mm) enamelled copper wire (ecw), twist them together at one end, and fit that end in your vice. Then twist the free ends together and fix in the chuck of a hand-drill. Whilst maintaining a steady tension, turn the drill until you have about three twists per cm. Give the twisted pair a firm pull to "set" the twist, then remove. Carefully wind about 11 "loops" onto an Amidon FT50A-43 core, as drawn in Fig 1. Snip the leads, leaving tails of about 20 mm.

Then remove about 10 mm of enamel from each lead and, with your multimeter on ohms, identify each winding. Now connect the end of one winding to the start of the other to become the drain connection. The winding starts are shown schematically with dots in Fig 1.

The IRF510 PA MOSFET is mounted so that the bottom of the case provides heat-sinking. Accordingly, a 12 x 18 mm hole is made in the board as shown in Fig 2. Fit a TO-220 silicone washer at the MOSFET/case interface, and insulating/mounting hardware as appropriate. A solder lug under the fixing nut provides the drain connection, to which is soldered the aforementioned transformer wire(s) (Photo 3).

Ordinary shielded wire, being close to 50 Ω Zo, may be used for the necessary coax cable connections between the antenna and the receiver connectors, and the T/R switch S2. Outer braid connections should be made as shown in Fig 1. Ordinary hook-up wire may be used for the low-voltage and LPF-S3 connections. All wiring on the 240 V mains side of the power transformer MUST be suitably covered to prevent accidental contact.

For convenience and improved frequency stability, a 3.520 (or 3.580) MHz ceramic resonator may be mounted inside a defunct crystal case, modified as described in Reference 2.

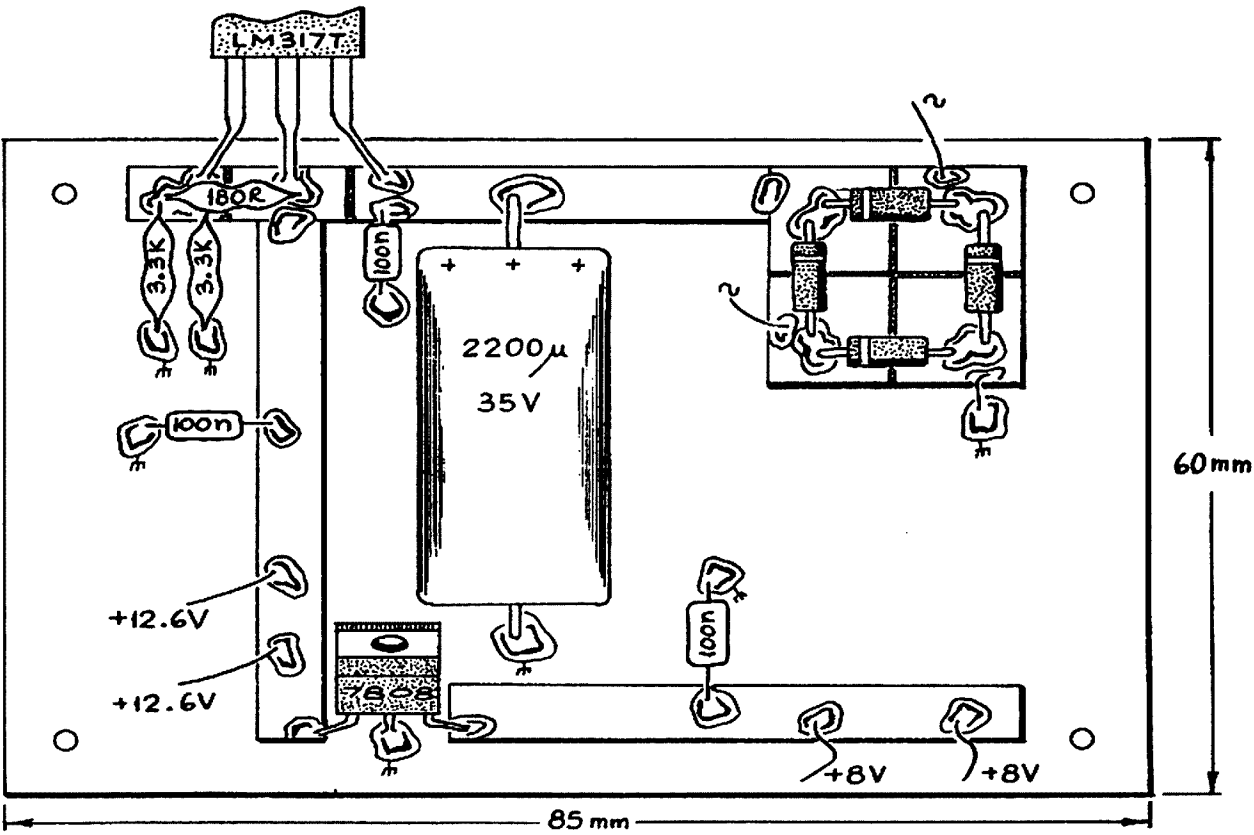

Fig. 3

**Operation**

Do a thorough wiring and parts placement/ orientation check. Pay particular attention to the polarised components, the semiconductors, IC, regulator chips, and electrolytic capacitor, etc.

With the T/R switch in the R(eceive) position, apply mains power. Measure the output from the LM317 regulator, which should read close to +12.6 V DC. Confirm, also, the output from the 7808 at about +8 V DC.

Using a short length of 50 Ω coax, connect a suitably rated RF power meter to the antenna connector. Install a crystal/ resonator and select the corresponding LPF with S3.

With S2 in the T(ransmit) position (and 'Net' switch SI at normal), close the Morse key. Clockwise rotation of the power (PWR) potentiometer should cause a smooth rise in output power to at least 5 W, whereupon the drain current will be about 800 mA.

In use, the antenna (load) should have an SWR of, generally, less than 2. No damage should result, however, working into a somewhat higher SWR load.

To net onto a received signal, operate SI to 'Net', then vary the crystal frequency by adjusting the VXO capacitor to obtain a similar beat-note to that of the received signal. When sending, you will be able to hear your own signal (strongly), and thus monitor your Morse and signal quality.

**Parts**

The ordinary parts are available from our usual electronics suppliers, including Altronics, Jaycar, Semtronics, Rockby and Electronic World (Ph 03 9723 3860).

The latter can supply the preferred Philips or Hitachi 74HC04, and polystyrene (Styroseal) capacitors for the LPF. IRF510s are available mail-order from Ocean State Electronics (www.oselectronics.com). The more common IRF511 will work, but not as efficiently as the '510.

The variable capacitor for the VXO may be any well-made part of 200, 300 or 400 pF maximum capacitance. 3.520 MHz ceramic resonators may be ordered from Wagner Electronic Services (WES Components); Ph 02 9798 9233.

Crystals for popular QRP frequencies of 3.535 MHz, 7.030 MHz and 7.038 MHz may be mail-ordered from Expanded Spectrum Systems (www.expandedspectrumsystems.com), and cost US\$2.55 each (plus postage, etc). They

come with flying leads only, so consider mounting them in a defunct crystal case, as for the 3.520 MHz resonator.

See Hamads in *Amateur Radio* for your local Amidon supplier.

If you have genuine difficulty in locating a particular item or two, please telephone, or drop me a line QTHR. I usually have spares on hand, or can suggest a source.

**Automatic T/R**

With additional circuitry, VFO and QSK may be included, along the lines of that shown in Reference 3.

**References and Further Reading**

1. "'Paddyboard' Circuit Construction - Revised"; *Amateur Radio*, May 2005.
2. "A Simple HF Signal Source"; *Amateur Radio*, Oct. 2002.
3. "A 4-Band QRP CW Transmitter with QSK T/R"; *Lo-Key #66* (CW Ops' QRP Club).

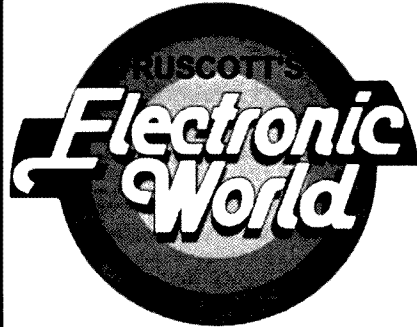

**We've got what you need!**

- |                            |               |
|----------------------------|---------------|
| Aerosols                   | A/V Leads     |
| Batteries                  | Cable         |
| Capacitors                 | CB Access.    |
| Ceramic Filters            | Crystals      |
| Coil Form Assemblies       | Fuses         |
| Hardware*                  | IC Sockets    |
| Knobs                      | Plug Packs    |
| Poly Switches              | Relay Bases   |
| Quikcrimp Terminals        | Resistors     |
| Soldering Irons/Acc        | Speaker Acc.  |
| Ventilation Fans           | Bakelite      |
| Books (inc Drew Diamond)   |               |
| Cable Clips/Ties           | Cases/Boxes   |
| CB Antennas                | Ferrite Cores |
| Ceramic Resonators         | Globes        |
| Computer Leads/Adapts.     | Kits          |
| Heatshrink                 | LEDs          |
| Plugs — Sockets — Adaptors |               |
| Potentiometers             | RF Chokes     |
| Semi-conductors            | Valves        |
| Solid State Relays         | Switches      |
| Transformers               | Veroboard     |

**Phone: (613) 9723 3860**

**Fax: (613) 9725 9443**

**27 The Mall, Croydon South, Victoria, Australia 3136**

(the heart of Melbourne's amateur radio scene)

**sales@electronicworld.com.**

**www.electronicworld.com.au**

**We'll know what you need!**

**KVK Antenna Systems**

Best value books in VK.

**The VK Antenna Handbook for Restricted Spaces**

Best value antennas in VK.

**The NuBeam**

**The Vertical-LR-dipole multiband vertical**

As seen at Wyong

Check out the latest revision to the web site - more info, more antennas, more value.

For direct purchases  
www.grimshaw.net.au

For credit card purchases:  
www.kvkantennas.com.au  
or ph 07-3216 8060 or  
fx 07-3216 8075

# DXpedition to the top end via satellite

John Titmuss VK4JWT

My job as a radio technician takes me to some very diverse locations. I thought I would share my most recent trip with you all, as I was in contact most days using AO-51 and SO-50.

The gear I took with me was a home made 'Arrow' antenna, consisting of a piece of conduit with a 'dirty' six element Yagi for 70 cm, and holes drilled at right angles for three 2 m elements, which were cut in half and tapped with a thread for easy transportation. The rig I used was an Alinco DJ-G5, which operated full duplex with just two watts output.

The first contact was from Weipa on SO-50. Although there were a lot of trees around, I was still able to get a good signal from VK2TXT and VK2TJU in Sydney. The next day I was due to fly across the Cape to Lockhart River. The helicopter arrived from Thursday Island but, unfortunately (or fortunately!), the chopper would not start. Another one was despatched from Thursday Island and, two hours, later we were on our way.

I arrived at Lockhart River just after the AO-51 pass, so no contact. The chopper has to land on a purpose-built deck on top of a mountain, where solar powered ship to shore equipment is installed.

That afternoon we flew from Lockhart River to Thursday Island. I had a good contact that night with Rob VK4ZQ, and George VK2WEL, as well as a host of others. The next day I flew to a mountain top on Moa Island, in the Torres Straits. The chopper has to land about a kilometre down from the site, so it is a bit of a walk through the tropical jungle to reach the top. Once on top, I had a successful contact via AO-51 with VK4ZQ, VK2TJU, VK2TXT, and VK2WEL. That night I had a contact from the balcony of the Grand Hotel on Thursday Island via AO-51.

The next day was a plane flight from Horn Island to Cairns, where I had a contact from the inside balcony of the Holiday Inn on AO-51. The next day (Friday) was a helicopter trip to Bells Peak, just south of Cairns. Here I had another successful AO-51 contact.

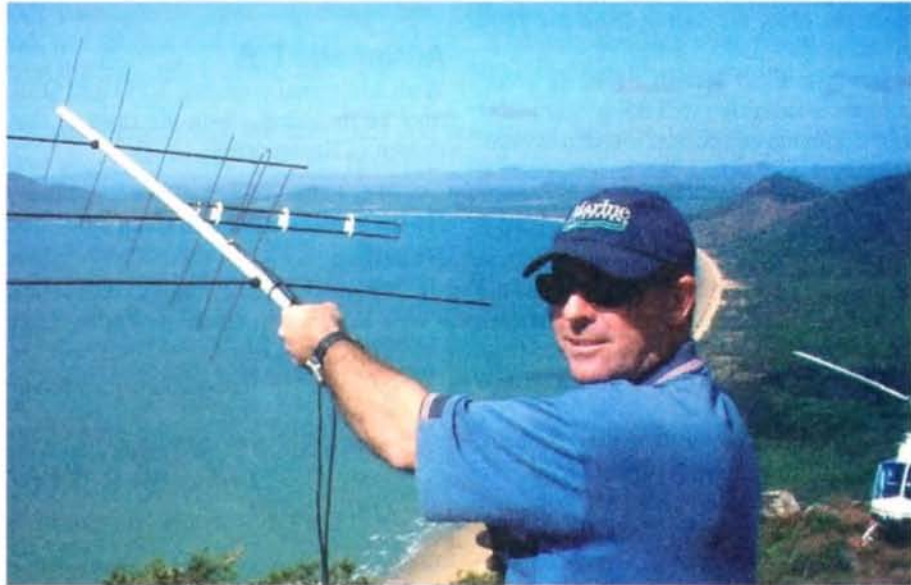

Waving a strange looking piece of apparatus at the sky!



I had another AO-51 contact from Indian Head.

On Saturday I flew via chopper to Cooktown, where I had another AO-51 contact from Indian Head. Sunday saw another contact on AO-51 from the esplanade at Cairns. I think there were a few people wondering what this guy was doing waving a strange looking piece of apparatus at the sky!

On the Monday I drove to Townsville, where I had contacts on AO-51 from the

roof of the Holiday Inn, and from Mt Archer. My last contact on AO-51 was from Home Hill, south of Cairns.

As you can see, working the LEOs is not that hard, provided you have a schedule of passes worked out before you go. All that is required is a home brew antenna, and a dual band H/T. I will definitely be taking my portable 'Earth station' on my next trip

ar

Let down  
by battery  
condition or  
failure?

**CBA II** ensures your  
batteries never let you  
down.

Graph battery voltage &  
capacity.

Overlay graphs for comparison  
and testing of different  
chemistries.

For lead acid, lithium &  
nickel chemistries.

Computer  
Battery  
Analyzer  
**CBA II**

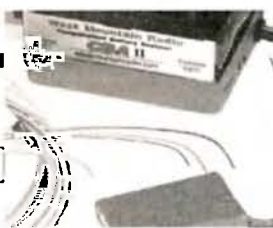

**West Mountain Radio**  
premium radio products.

**02 4982 5481**

[www.fastelectrics.com](http://www.fastelectrics.com)

**S.A.D.A.R.C.**  
**SHEPPARTON**  
**HAMFEST**

10TH SEPT 2006

ST AUGUSTINE'S HALL SHEPPARTON

Pat VK3OV, phone 03 58217774,  
or e-mail [patbarbo@bigpond.net.au](mailto:patbarbo@bigpond.net.au)



**SUNFEST 2006**

Woombye School of Arts  
9 September

Blackall Street, Woombye  
(UBD Map 66 F12)

The Sunshine Coast Amateur  
Radio Club's annual HAMFEST

Richard VK4YRP (07) 5492 9898.

Email: [randwphilp@bigpond.com](mailto:randwphilp@bigpond.com)

[www.pce.cc](http://www.pce.cc)

Email from anywhere

via **Winlink**  
2000

Use **PACTOR-3**

on HF to send  
Mail, Grib Weather,  
Weatherfax & Images

Contact [marc@pca.cc](mailto:marc@pca.cc)  
Sydney 02 8902 0107

**Rippletech**  
**Electronics**

HIGH PASS FILTERS FOR TVI PROBLEMS

Most TVI problems are due to the inability of the TV set to reject strong out-of-band signals – i.e. those from a local HF transmitter. Rippletech High Pass Filters are designed to reject all HF signals, not merely optimised to reject CB. The HPF-50/55 has a cut-off frequency of 50 MHz and better than 55dB of attenuation on 10m and at least 80dB of attenuation on 80m.



TZ-1840	1:1 1kW 160-10m Balun	\$ 59.00
TZ-330-4	4:1 1kW HF Balun (3 - 30 MHz)	\$ 59.00
TZ-SL8	80m Sloper (use tuner on 17 - 30m)	\$ 99.00
TZ-SL16	160m Sloper (fits a suburban lot!)	\$ 110.00
TZ-D-4080	40m/80m Trapped Wire Dipole	\$ 176.00
TZ-V-3	10/15/20m Trapped Vertical	\$ 189.00
TZ-V-4	10/15/20/40m Trapped Vertical	\$ 289.00
TZ-V-3L	20/30/40m Trapped Vertical (NEW)	\$ 220.00
TZ-V-3w	12/17/30m Trapped Vertical	\$ 199.00
TZ-V-3x	12/17/40m Trapped Vertical	\$ 209.00
	Radial kits (1 radial per band)	\$ 33.00
TZ-RD-3	10/15/20m Trapped Rotary Dipole	\$ 279.00
TZ-RD-3w	12/17/30m Trapped Rotary Dipole	\$ 289.00
TZ-RD-3x	12/17/40m Trapped Rotary Dipole	\$ 309.00
TZ-RD-40	17/40m or 20/40m Rotary Dipole	\$ 289.00
TZ-1000RC	FT-1000mp remote controller	\$ 55.00
HPF-55/5C	High Pass TVI Filter (available now)	\$ 39.00
	Mobile base & Z bracket combo	\$ 11.00



**The Innovator - not the imitator**

Our tri-band, quad-band and tri-band WARC verticals have been big sellers for several years now, so good imitations are starting to appear! Compliments abound – check out buyer satisfaction on our ebay sales. We couldn't be more flattered. The verticals are perfect for the ham with limited space, field days, mini expeditions or travellers. With a packed length of only 1m, they fit in your boot or on a plane. Using the same high Q, sealed coaxial traps exhibiting 40 dB of isolation at resonance you get really great performance & ultra wide bandwidth. Even better is the ease of set-up, comprehensive and detailed instruction manual and no compromise construction.

**Need something special?**

Make a call and we'll see if we can meet your needs.

[www.rippletech.com.au](http://www.rippletech.com.au)

Contact Tony – VK3TZ B Eng (Comm) MBA

0402 622 562 or 03 9887 4936

email:

[sales@rippletech.com.au](mailto:sales@rippletech.com.au)

Mastercard, Visa and Bankcard accepted

**TWIN CITIES RADIO AND**  
**ELECTRONICS CLUB Inc.**

**The Riverina**  
**Field Day Sunday**  
**20th August 2006**

Murray High School Lavington.

10 am - 2 pm

Catering onsite

Greg 02 6021 5438

## VK2

Tim Mills VK2ZTM

E-mail to vk2wi@ozemail.com.au

### The Clubs

This month will see activity with the Blue Mountains club holding their Winterfest on Saturday the 19th at Glenbrook. Next day - Sunday the 20th - the Riverina Field Day at Lavington [Albury], hosted this year by the Twin Cities Radio and Electronic Club. In October, the Oxley Region ARC will celebrate 35 years since being formed. In January 2007, the Coffs Harbour and District ARC have a new venue for their annual Field Day.

Last May, the Orana Region ARC mounted a display of the hobby at the three-day Dubbo Show. Various clubs and groups will be taking part in the Lighthouse Weekend and Marconi celebrations. Everybody should support the RD Contest, your log helps the State score.

### A Morse mural.

Visitors passing through the Port Macquarie Airport should pause a while when departing to view the mural. Completed recently is a feature wall where the theme is Morse Code. At the top of the wall, the code symbol with its letter is displayed. In the centre there are two half globes of the world. Below is a message, in Morse - it reads - 'enjoy your flight' 'port macquarie airport'. To the left is a wall-mounted box that speaks to you when you approach. Mounted on top is

a hand Morse key and in front of it is a message - in Morse - for you to send: 'is anybody out there?'

### Exams

ARNSW exams this month will be on the weekend of 26th and 27th. Book via the temporary office at Parramatta: Phone 02 9689 2417. Write to PO Box 9432 Harris Park 2150 or email vk2wi@ozemail.com.au. Are you conducting exams? Please let the ARNSW office know so they can answer the inquiries that come in. One of the services provided by ARNSW is helping dispose of equipment from Deceased Estates. Check out the details with the office.

### Local Publicity

Has your club approached your local parts retailer to display a notice about your existence and the exams that you conduct? This has a two-way benefit, you may gain members and expand the hobby with more call signs and the store could benefit with a sales increase.

### VK2WI

VK2WI has restored the AM mode to the 40-metre transmission. A bit of a reception struggle in the evening at the moment as Radio New Zealand is operating nearby

due apparently to a transmission problem on another of their frequencies. The 160-metre transmission is currently off. A new and relocated antenna is planned. Many clubs provide relay services of the VK2WI news and some advise on the number of callbacks they take. These figures are passed on to WIA news. We would like all relay stations, who take callbacks, to either advise VK2WI direct or by email or VK1WIA. The news text can be found early in the week on the ARNSW web site [www.arnsw.org.au](http://www.arnsw.org.au). VK2WI News is now being compiled by Brian VK2TOX who has requested the items, if possible, to reach him by email with the deadline set at noon Friday. If it is sent by mail or fax, please send it early in the week so it can be passed on to him.

### WICEN

WICEN [NSW] Inc held their AGM on 8th July. The retiring committee did not move fast enough and were re-elected. They also found a couple of 'volunteers' for the committee. There have been a few changes in that there are no longer Regions by boundaries. This enables more flexibility in the operations. Contact WICEN direct for details and membership.

73, Tim VK2ZTM

## The Central Coast Field Day – Wyong LECTURES

Sunday 18th February 2007

**Mark your calendar and start making plans to attend the premier Field Day of the year, the Central Coast Field Day - Wyong**

With the opening of our new and expanded lecture facility the CCARC is soliciting expressions of interest from Hams and non Hams to present Amateur Radio related topics.

Presenters and attendees will have

the opportunity to exchange ideas and learn about recent advances, theories, experimental results, and practical applications.

The ideal lecture would be 30 – 50 minutes in duration.

For further information  
CCARC Field Day,  
PO Box 1408 Gosford 2250 NSW  
Phone 02 4340 2500  
Web [www.ccarc.org.au](http://www.ccarc.org.au)  
Email [fieldday@ccarc.org.au](mailto:fieldday@ccarc.org.au)



## VK3

### Amateur Radio Victoria News

Web: [amateurradiocom.au](http://amateurradiocom.au)  
Email: [arv@amateurradio.com.au](mailto:arv@amateurradio.com.au)  
Jim Linton VK3PC

#### Office Upgrade

Anyone visiting the Ashburton Office recently would have noticed the new window signage that identifies Amateur Radio Victoria plus our website address. Thanks to member Brian Smith VK3NBS for offering and doing this job. It is the first of a number of changes planned.

The Amateur Radio Victoria Council at its meeting last month agreed on an office improvement program to make it more functional and create a better work place for our volunteers. Hopefully it may also lead to additional volunteers coming forward.

Our Treasurer Ross Pittard VK3FCE met with the regular volunteers to discuss proposals before they were to be considered by the council. This process identified improvements for the kitchenette, office space, equipment and amenities.

His subsequent report to the council meeting resulted in a schedule being drawn up with matters identified as either being an immediate priority, a medium term goal, or under consideration for early 2007.

The running of two amateur licence classes at the office earlier this year demonstrated its suitability, while the internal layout would need to be changed to accommodate a class of more than eight.

Progress is also being made towards the installation of an HF, VHF & UHF station at the office that could be used for class instruction and general operation as a club station. WICEN (Vic) would also have access to the station for its needs.

Council decided to purchase an Icom IC-7000 transceiver for the purpose. Separate VHF/UHF FM transceiver(s) are also proposed to form the overall amateur station.

#### RD Contest Reminder

The Remembrance Day Contest on 12-13 August will be run under revised rules. The overall winning State depends not just on activity but for participants

going that extra step and submitting a log entry.

The so-called 'friendly contest' is in memory of those radio amateurs who died as a result of their involvement in World War 2. Running 24 hours, it begins at 6pm on Saturday 12 August, immediately preceded by an opening address broadcast.

Amateur Radio Victoria encourages all VK3's to prepare for, take part in even if only for a short period, and making their effort count towards Victoria total tally.

#### Barriers still exist?

Since the start of the three-tier licence structure ten months ago there has been an influx of new people to amateur radio and the bands are certainly a lot more active.

When the introduction of the Foundation Licence was being considered, the need for existing radio amateurs to be mentors for the newcomers was recognised.

This is occurring to some degree, which is good. What is emerging is that there are still barriers for people wanting to get into the hobby or once in, getting maximum enjoyment from it.

The Amateur Radio Victoria F-Troop Net held each Sunday is doing its bit to provide 'on air' operating opportunities for new licensees in a friendly environment, with the ability to ask questions and receive answers from knowledgeable radio amateurs.

There are reports that a few Foundation Licence courses and assessments are only willing to do so if they get a minimum number of say six people or so.

That practice is rooted in the past when the WIA Exam Service did require an additional exam event fee, and advance payments for exam material that could only be used for a specific candidate, time, date and venue.

The new assessment system did not continue that practice in the belief it would make access to assessments much more frequent, either through regular events or at a convenient time for assessors and candidate.

Amateur Radio Victoria at its monthly events has included candidates willing to travel long distances to get into a course and be assessed, rather than wait until one may be available locally.

Another barrier is a lack of knowledge about transceiver types. There are concerns about being an ill-informed consumer - Not knowing what second hand price is fair or excessive. The used equipment market is showing signs of price inflation in comparison with those for the same or similar equipment last year.

With young people, often their entry into amateur radio is dependant on the household budget. Some parents, while willing to pay for the training course, are reluctant to go that extra step and spend \$57 for a licence, until a radio transceiver is obtained as a birthday or Christmas present.

These and probably other barriers need to be recognised and possible responses considered to reduce or minimise their negative impact on the growth of amateur radio. Any suggestions on how to address these barriers would be welcome.

---

### Silent key

---

#### Michael Rogers VK7DU

Mike lived in Bellerive and was mainly heard maritime mobile on HF. Mike was a keen yatchy and was a long time member of the Bellerive Yatch Club, his nickname was "Spike". Mike regularly sailed the yacht "Siesta". Port Davey on the West coast of Tasmania was a favourite destination with regular skeds on HF. Mike was also a regular on the 2 m broadcast callbacks.

Vale Mike.

(Mike VK7FB & Dave VK7DM)

#### Peter Pavey VK3VB / G3NFT,

Peter became a silent key on 1st of July 2006, aged 66. Survived by his wife Patricia (VK3OZ) and children Paula, Patsy-anne, Phil (VK3YB) and Peter.

Phil VK3YB

## VK5

Christine Taylor VK5CTY

### Adelaide Hills Amateur Radio Society

The meeting in June was a strange one. There was a power blackout on "our" side of the street. The meeting was held was conducted by the light of the "Exit" signs! That included supper!a

To complicate the problems the lecturer got lost and neither he nor the President Jim VK5NB had the other person's mobile phone number!

However, the lecture situation was overcome because one of the visitors was Justin VK7ZTW. Justin stepped into the breach and gave a very interesting talk about the experiences they have had in Tasmania with PBL interference.

Because it is not happening "in our own backyards", most of us in the other states are not aware of just how bad the interference experienced by amateurs is. Those who are 'testing' transmission of electronic signals on the power lines are doing so in some of the less populous areas and where there are fewer people who are likely to be affected by any interference.

The problem then is that the "results" obtained by these tests will be used to

argue that there is not much interference when the telcos want to use PBL in more populous places.

As amateurs who WILL be affected by this interference, we need to be aware of it and we need to be vocal in our objections to it.

Justin has been writing about the experiences of VK7 amateurs for some time. Perhaps we should go back and have a closer look at what he has had to say – and what the President of the WIA, Michael Owen had to say on the matter.

Apart from the very thought provoking lecture, mention was made by Jim VK5NB of the several projects to be offered to club members in the next few months. These projects include making a G5RV antenna and the associated ladderline feeder, an antenna tuner, a balun and an SWR bridge.

Watch this column for more information.

Please note, there will be a change of venue for the AHARS meetings from the August meeting.

We will be meeting in the Belair Community Hall. Listen to the Sunday morning broadcast for more details or ring Jim VK5NB or Leith VK5QH QTHR the callbook if necessary.

At the beginning of July AHARS had its usual mid-year Dinner. Barry VK5ZBQ is seen here with Noel VK5VT.



### Lower Murray Amateur Radio Club

This club is a subsidiary of AHARS, taken under their wing several years ago when the number of members of the LMARS was too low to support the cost of the callsign etc.

It was felt that centred at Murray Bridge and with a number of members, members of both clubs, it was appropriate that the larger club assist the smaller one.

Since then the number of amateurs in the Lower Murray has increased to the extent that they can hold mid-year and Christmas Dinners to which they invite the President of AHARS.

The Club has access to clubrooms for a nominal fee through the support of the local community. The LMARC now holds weekly meetings in the clubrooms at which

they share experience and undertake local projects.

It was recently reported that the Radio Club had a booth at one of the local Field Days, which generated quite a bit of interest. Perhaps other clubs could follow suit.

The photo shows that the ladies are well represented at the dinner and in the

Club, with two licensed amateurs, Meg VK5YG and Jenny VK5ANW, here seen



with John VK5CJM and two of the XYLs on either side.

## VK7

Justin Giles-Clark VK7TW

Email: vk7tw@wia.org.au Regional Web Site: reast.asn.au

It was great to see so many VK7s in the 80 m Trans-Tasman contest results. Congratulations to VK7s – VH, TAZ, GN, HDX, HAY, ARN in the phone section and VK7RO in the CW section. It was also great to see Rex VK7MO at it again at GippsTech 2006 with two talks entitled – “Newcastle TV - A Frequency Reference and Propagation Beacon” and “QRP EME on 1296 MHz”.

### Tassie Devil and Trout Award Net

Thanks to Vince VK7VH who has handed over the net controller reins to Jack VK7IL on the Tassie Devil and Tassie Trout Awards net. This net enables amateurs to gain points for these prestigious awards and it takes place on Thursday nights from 8:00pm to 8:30pm EST prior to the CHARCT Quiz Net. The frequency is 3.585 MHz.

### VK7 Regional Broadcast Report Card

The first six-month callback statistics for 2006 for the VK7 Regional News broadcast have been released and it's great news! Compared to 2005, there is an overall 13% increase in callbacks with an average of 90 callbacks each week. This can be attributed to a 23% increase in HF and an 18% increase in Southern repeater callbacks. Take a look at <http://reast.asn.au/archive.php> for more information.

### VK7REC needs your help!

Alan VK7ZAR and Joe VK7JG are currently undertaking some much needed work on VK7REC at Snow Hill covering the East Coast, Southern Tasmania and even as far as the NW coast. Joe has replaced the repeater hardware, Brian VK7RR has replaced the PA and Alan is replacing the antennas thanks to Chris Edwards at Moonraker Antennas. Thanks also to Dick VK7DIK, Paul VK7KPG and Peter VK7PD for helping with the maintenance. The cost of the antenna replacement/upgrade alone will be approx. \$300 not including fuel and sundries. It is now up to the users of VK7REC to contribute to this maintenance/upgrade

work. Please seriously consider donating if you use this repeater. Donations may be sent to REAST and these will be forwarded on.

### Central Highlands Amateur Radio Club of Tasmania

Please note that CHARCT has a new web address: <http://www.qsl.net/charct/> Do not forget the VK7 Hamfest on Saturday 2nd December 2006, at the Miena Community Hall in the Central Highlands.

### Northern Tasmania Amateur Radio Club

June 14 saw Ken VK7DY and XYL Wendy VK7FWJS give a talk about ATV. Ken had a table full of goodies to show/explain and tell, as well as informing us how cheap it can be to get started; thanks Ken! Brian VK7RR and Joe VK7JG also need thanks for their work on getting the Barren Tier to Mt Barrow link up and going again. Thanks to Rick VK7HBR for the donation, at the June meeting, of a CD player and Greg VK7YAD for his interference detective work with VK7RAA.

### North West Tasmania Amateur Radio Interest Group

There has been an incredible amount of work undertaken by the NWTARIG in preparing for the Marconi Centenary Celebrations over 12-16 July 2006. This was to commemorate the first transmissions over open water in the Southern Hemisphere in 1906 by the Marconi Company between Queenscliff (VK3) and Devonport (VK7). Special event stations VI3MC & VI7MC operated and an attractive QSL card is available. An exhibition of original and historic equipment was held at the Devonport Maritime Museum. A reprint of the original brochure with supplement is available. Check <http://vk7ax.tassie.net.au/marconi/> for more details.

### Radio and Electronics Association of Southern Tasmania Inc.

There is a new 160-metre net on 1.840 MHz at 4:45pm EST on Tuesdays, Wednesdays and Thursdays. Dave VK7DM is the net controller and takes reports and callbacks



Mike VK7MJ explaining while Eric VK7TAS talks with Reg VK7KK via the photo-phone.

# News from...

## VK7 continued

on 1.840 MHz or on repeater VK7RAD/RHT (146.700/146.850). We welcome new foundation licensees: Damien VK7FDNA, Michael VK7FMRS, Mike VK1FMJP, Sue VK1FADM, Steve VK7FAME, Rhonda VK7FRAE, Tom VK7FTWS, Scott VK7FREK, Declyn VK7FUNN and Dean VK7FNWO. We also welcome our new standard licensees: Spencer VK7HSY, Ben VK7HAH, Bruce VK7MBD and Brian VK7HAI.

We had some sad news from Cape Bruny at the end of June from Andy VK7WS, who is lighthouse keeper at the Cape. A fire in the shack destroyed all his radio equipment along with historical radio and weather recording equipment. It also destroyed the radiotelephone, causing some difficulty in raising assistance. Fortunately, the shack was in a separate building from the house.

On Wednesday 5 July, about 20 people enjoyed a demonstration and talk by Mike Groth VK7MJ. Mike is a leading experimenter in the area of optical communications methods and set the world distance record in February last year with Chris Long. The evening started with a contact made between the Queens Domain to Reg VK7KK on Mt Rumney. The evening then progressed with an illustrated talk by Mike on the practicalities and theory behind optical communications. Thanks to Mike for giving us the time and his vast experience with this fascinating subject. A detailed



Mike, VK7MJ, with his new optical transceiver.

description of the night is available on the REAST website.

## VK4

### Redcliffe and Districts Radio Club

The Redcliffe and Districts Radio Club recently received a grant for the Gaming Commission Community Benefit Fund to upgrade the clubs facilities.

Work is well underway and the club has a new radio room, upgraded kitchen, upgraded 2 m repeater and new computer and audiovisual equipment for training purposes. The roof of the clubrooms will also be relined to improve insulation and reduce the noise when it rains.

Thanks to the help of many club members, the facilities are now ready for use and the club is planning to operate from the clubrooms during the upcoming Remembrance Day Contest. All are welcome to come down and check out the clubs facilities which are in MacFarlane Park, Klingner Road, Kippa Ring, opposite the Redcliffe PCYC. See our new website at <http://vk4rc.we.net.au> for a map of our location plus

more information on the club and its activities.

The Redcliffe club also has two accredited assessors and has successfully completed a number of Foundation Licence assessments. More courses, foundation, standard and advanced are being planned, and if you would like to participate, please contact the club secretary Peter Richardson on 0419015613 or via email [secretary@vk4rc.we.net.au](mailto:secretary@vk4rc.we.net.au)

### VK4 Inwards QSL Bureau

#### Eddie DeYoung VK4AN

The new direct postal address for the VK4 Inwards QSL Bureau is P.O. Box 1335, Maryborough QLD 4650. The old address can still be used, but will delay receipt and processing.

QSLs for WIA members will be processed and posted Free-of-charge via affiliated clubs or direct to the member's postal address. If the member is QSL manager for any non-WIA members, then the non-WIA member fees are applicable. If the member has cards forwarded for personal operations in other areas, those cards will be handled Free-of-charge.

QSLs for non-WIA members will be

processed, but a "processing & postage" account must be opened and kept in credit. Cards will be processed at the rate of 5 cents each, plus cost of envelope (10 cents) and postage. It is suggested that a minimum of \$5 be sent to open an account. This is for cards posted via clubs or sent direct.

QSLs for JOTA operations will be processed Free-of-charge for all stations. Cards received will usually be processed within 7 days of receipt.

Cards not claimed within 5 years of receipt will be sent to the WIA QSL Museum.

Cards will usually be available at the Brisbane, Sunshine Coast & Gold Coast Hamfests. Cards may be personally claimed free-of-charge.

It is the responsibility of members to keep the bureau informed of any change in postal address; change of callsign; additional callsign(s); card management.

It would also be appreciated that I be advised of any VK4 that becomes a 'silent key'.

Yours in amateur radio,  
Eddie DeYoung VK4AN

# VK5

Elizabeth Amateur Radio Club

## Antenna Testing Field Day

9th April 2006

Paul Gale VK5ZKG and Keith Gooley VK5OQ

The primary reason for the field day was to test the new VK5ROC repeater antenna constructed by Dennis VK5FDEN and Keith VK5OQ.

**Signal Source:** Icom IC706IIG transceiver

**Ref Antenna:** Dipole constructed from 1" dia tubing

**Receive Antenna:**

Rohde&Schwarz Active Broadband Directional Antenna model HE200

**Field Strength Meter:** Home-brew broadband RF power meter based on an Analog Devices AD8307 Log-detector IC



### Method

The Icom transceiver was used to provide 9 watts at approx 437 MHz.

The antenna under test was replaced by our reference antenna and the field strength was measured. This provided our basis for quoting the "gain" of the antennas.

The antenna under test was installed and the field strength noted on the Field Strength Meter. The receive antenna was moved up and down by about one wavelength to check that ground reflection was not influencing the measurement significantly. The test antenna was also rotated to measure directional characteristics.

As the field strength meter indicates in dBm the two readings could be simply subtracted to give a gain directly in dB.

### Antenna descriptions

**Reference antenna:** a half wave dipole on 70 cm made from 25 mm aluminium tube with broad bandwidth in mind.

**VK5ROC antenna:** a vertical array of 4 aluminium folded dipoles fed in phase.

**Club J-pole:** a dual band 2 m / 70 cm aluminium antenna built by Dennis

VK5FDEN 5-el Yagi: a small 70cm Yagi used for field days.

**Copper J-pole:** 2 m J-pole made of copper pipe and soldered fittings.

**3-el Yagi:** 2m antenna

Yagi with a gain of 11 dB. The surprise was the copper J-pole which was 6 dB down on the aluminium J-pole. This is an unexpected result as the two should have roughly the same gain. As 3 of these copper antennas were made at the same time the poor performance requires investigation. The SWR of the copper J-pole is good at better than 1.5.

The results indicate the value of quantitative testing of antennas.

### Results

#### (70 cm)

Noise floor:	-48 dBm	
Reference:	-9 dBm	
ROC antenna	0°: -1 dBm	Effective gain 8 dB
	90°: -2 dBm	
	180°: -9 dBm	
Club J-pole	-5 dBm	Effective gain 4 dB
5-element Yagi	0°: +2 dBm	Effective gain 11 dB
	90°: -6 dBm	
	180°: -33 dBm	

#### (2 m)

Noise Floor:	-34.5 dBm	
Reference:	none available	
Club J-pole	0 dBm	
Copper J-pole (VK5ZKG):	-6 dBm	
3-element Yagi	0°: +4 dBm	
	90°: -9 dBm	
	180°: -6 dBm	

### Discussion

The main result that the repeater antenna had a gain of 8 dB over the dipole reference was pleasing and indicates that the antenna will perform well in service.

The Club 2 m / 70 cm aluminium J-pole also performed well as did the 5-element



## Exciting news in the development of the "Eagle" high orbit satellite

This announcement was made in mid-June on the AMSAT-BB. It was in response to a cry from some members that a veil of secrecy hung over the "Eagle" project. This claim is often made, almost every time a new bird is on the drawing board. It usually falls to one of the project team to act as information officer and the calls on their time and energy are many. The various project teams have been acutely aware of this for some time and now it appears a satisfactory solution has been achieved. It has meant a huge workload for one or two people, Emily Clark in particular. Here is the announcement:

### The AMSAT group in Australia.

The National Co-ordinator of AMSAT-VK is Graham Ratcliff VK5AGR. Contact Graham if you wish to be placed on a mailing list for breaking news and net reminders. As a forum for members, AMSAT-VK operates two monthly nets.

### AMSAT-Australia Echolink Net.

The "Echolink" net meets on the second Sunday of each month. Anyone with an interest in Amateur Radio Satellites is welcome to join the net. Graham VK5AGR acts as net controller. The net starts at 0500 UTC during summer time periods and 0600 UTC during winter standard time periods. Connect to the AMSAT conference server on Echolink a few minutes before these times.

### AMSAT-Australia HF net.

The HF net meets informally on the second Sunday of each month. In winter (end of March until the end of October) the net meets on 3.685 MHz at 1000 UTC. In summer (end of October until end of March) the net meets on 7.068 MHz at 0900 UTC. Start listening 15 minutes before these times.

All communication regarding AMSAT-Australia matters can be addressed to:  
AMSAT-VK,  
9 Homer Rd,  
Clarence Park, SA. 5034  
Graham's e-mail address is:  
vk5agr@amsat.org

*Today EAGLE Project Manager Jim Sanford WB4GCS, announced that EaglePedia is now open for general use. EaglePedia is the communication medium used by the EAGLE developers, and is now accessible to all AMSAT members. A basic principle of the EAGLE project is open design, so Jim made the decision to open access to the EAGLE development effort once EaglePedia, a new effort itself, was judged to be ready for general use.*

*The entire Eagle team has been enthusiastically supportive of openness to the members, said Jim. We are excited to give all AMSAT members the opportunity to understand and to follow the design process of the various satellite components and system.*

Emily Clarke N1DID has developed and customised the EaglePedia application using the MediaWiki software engine that was developed for Wikipedia.

*I'd like to thank Emily for all her efforts. She has adapted the wiki product to our needs, educated the illiterati (mostly me) and added functions to make it easier for us to use. EaglePedia would not be the tool that it is, without tremendous effort on Emily's part, and I am extremely grateful for all her work.*

All major decisions about the spacecraft and their supporting documentation will be available through the site. Although

only EAGLE team members will have the ability to comment on what is posted there, all will be able to see them.

Jim notes that, *There will be some areas of the site that are available only for internal EAGLE team communications during the preliminary development stages. I have made this decision to allow unfettered communications among the team during the early phases of concept refinement and design. Once peer review of a design is complete, the initial design, peer review comments, the resolution of those comments, and the revised and approved designs will all be available to AMSAT members.*

Jim, the entire EAGLE team and AMSAT President Rick Hambly encourage everyone interested in amateur satellites to take advantage of this "new way of working" and to follow the EAGLE design process and developments.

*We are excited about offering the unprecedented access into EAGLE's development. I fully expect this approach to enhance the EAGLE design process and improve overall product quality,* said Rick. EaglePedia can be accessed via the AMSAT.org front page using the EAGLE link in the "Quick Access to Project Pages:" section found on the top right of the page. Welcome to open satellite design.

## Preparing your station for the High Earth Orbiters – Part 1

While discussing the above item with friends the other day it became apparent that many newer satellite operators will have developed their interest during the recent period where the only birds available have been low earth orbiters. Oscar-10 occasionally pokes its head up but it is a mere shadow of its former self and certainly not spectacular enough to get anyone excited about high-earth orbiters.

The unexpected revival of AO-7 will have given newer AMSAT-ers a glimpse of how much difference even a doubling of the usual low-earth-orbit satellite

altitude can make to the footprint area and therefore the enjoyment factor. Multiply this by the first number you think of - and you have a High Earth Orbiter (HEO).

Oscar-10 was the first HEO. It was launched back in 1983, yes, that's 23 years ago. Time flies - eh? And what a sensation it was. The first attempt at launching a "Phase-3", high altitude, elliptical orbit bird had resulted in a disaster with P3A going into the ocean along with a quantity of commercial satellite hardware and the hopes and dreams, the sweat and tears of a dedicated and hard-working AMSAT project team. There was no internet or

instant information coverage then and I can remember everyone being stunned when Graham confirmed our worst fears on the HF net. All fingers were firmly crossed on June 16th 1983 and sure enough, at the appointed time the beacon turned on and we all breathed a little easier. AO-10 was alive and we never had it so good.

There had been nine previous "Oscars", all low-earth-orbiters and eight similarly placed Russian "RS" birds. Everyone was agog at the anticipated extended footprints of high orbiting satellites. AO-10's elliptical orbit had a perigee 3 times the height of most satellites to that time and we watched in awe as it was flung out almost 40,000 km into space at apogee where it slowed to walking pace before plunging back again. Its vantage point at apogee afforded a position where 'half the world' came under its footprint – not for just a minute or two but for several hours. We were all made familiar with the geometry and the expected coverage but it was still amazing to hear those first signals come in from all over the USA, Europe and Africa.

Many operators had their stations ready for the earlier unsuccessful launch attempt and their hard work began to pay off straight away. With the right gear, operating AO-10 was a breeze. We even conducted the AMSAT-VK net on the mode-b transponder with all states from Antarctica to New Guinea and ZL joining in. AO-10's 70 cm receiver was very sensitive and easily accessed with a few Watts, even at apogee. All you needed was a good antenna system, more on that later.

QRP became the "in" thing among the VK/ZL gang at least. Next, we saw the French Arsene satellite in its amazing high altitude 20,000 km – 40,000 km elliptical equatorial orbit. An orbit still spoken about in revered whispers by those fortunate enough to experience it. For many it was their first foray into the mysteries of microwaves. The signal-to-noise on the 2.4GHz downlink was amazing. The SSB signals stood out many "S" units above the whisper quiet noise floor which was just audible – again – if you had a good enough antenna.

Then in June 1988 came P3C or Oscar-13 as it became known. It went on to become a great performer with nearly all its transponders and modes tried out and operated successfully before its orbit decayed in December 1996.

Then came P3D or Oscar-40. It looked like being a winner until an unexpected, perhaps even explosive event on board caused a catastrophic failure of several vital components. It limped along, taking up an enormous amount of time by the control stations but failed altogether some time ago. While it was operational, AO-40 performed magnificently on all modes tested. Like Arsene, its 2.4GHz down link surprised everyone with the clarity of reception. Such then is a potted history of the HEOs to date.

So, what about setting up a station today? What does one need? What would be the minimum requirement? What would be considered a good HEO ground station? Why bother at all considering the present situation?

It has been suggested that I spend some time, perhaps over a column or three, looking at these questions – and of course I welcome any input from satellite old timers. There's quite a few around with fully equipped stations out there waiting for the next HEO but there's also a heap of folk wondering what they'll need when the time comes. The next few years will – if all goes well – see the launch of two HEOs, each with a different emphasis but with many common requirements in regard to ground station equipment.

It is a steep learning curve from LEO to HEO but many operators have made the jump. In VK, the population of AO-10 regulars 23 years ago probably exceeded the total number of satellite operators today. Rather surprisingly even the earliest HEOs had capabilities up into the microwave regions. Their orbits were similar to the high orbiters we now await, so the basic requirements for the ground station have not changed much in all that time. If anything, it should be simpler and comparatively cheaper to set up a HEO ground station today.

Now, as then, you still need to do it right. You will still need stable, sensitive VHF/UHF SSB transmitters and receivers as the basis. Computer access to the CPUs is more or less a must. Modern multi-mode transceivers featuring computer control have been available for a long time and

many operators use such a device as the central pillar in their station.

Some however, still prefer separate transceivers for each band for greater flexibility or even entirely free-standing receivers acting as tunable IF strips for microwave or UHF down-converters.

Either way there is no shortage of "out-of-the-box" equipment suitable for VHF, UHF and the lower microwaves. I couldn't have said that 10 years ago or even 5, but a lot's happened in the last few years.

You will need to pay close attention to your antenna system as a whole. That was true in 1983, it's still true today. The people who got the best results were those who did not compromise in the design and construction of their antenna systems. The most radical change from LEO to HEO, and the one for which you will be least prepared, is the need to cope with greatly reduced and often quite weak received signal levels. High orbiting birds can be a long way from your ground station, up to 50,000 km at times when the working footprint is greatest. The transmitter power will often be measured in milliwatts, you do the maths. It represents quite a challenge. Most LEOs are one or two thousand kilometres

away and sometimes only hundreds of kilometres away during optimum contact times.

Preparing for the high orbiters is rather like setting up for weak signal reception such as meteor scatter or UHF-DX and it shares many of the same problems. The 'weak-signal' aspect of serious satellite operating is where most problems occur and

it needs to be addressed when setting up or augmenting your present station for the HEOs. Do not try to do it with a hand-held and rubber ducky. It is absolutely no use whatever trying to compensate for receiver inadequacies by using higher power or talking louder! A bigger linear amplifier may well be able to blast a hole in a DX pile-up on 20 m but you can't do that on a satellite. This is a difficult point to get over and the message applies to the LEO fleet as well.

One of the most common problems associated with operation on the HEOs is that of the "Alligators": operators with tiny ears and big mouths. People

**If you have cut your teeth on the LEOs, now is a great time to upgrade your station for the forthcoming HEOs. Your new "Oscar" ground station will be useful in other areas too. If you do it right you will have the basis of a fine weak-signal station for terrestrial DX or meteor scatter.**

who cannot hear their own signal being transponded by the satellite, or even hear the satellite's beacon for that matter, and who attempt to make it all happen by yelling or turning up the power. A surprising number of people don't seem to be able to grasp this simple point and it has turned out to be so much of a problem that clever counter-measures have had to be taken to prevent such practice from making everyone else's life a misery.

"LEILA" is such a system. Don't worry about the name. It's a German mnemonic that doesn't make the journey into English easily. The system was devised many years ago and to a large degree perfected on AO-40. Leila is very effective in dealing with "Alligators". You should read-up on Leila before getting too excited about HEOs. It's good practice to plan your station so that you are able to hear the beacons loud and clear before ever attempting to transmit through any satellite transponder and this maxim applies nowhere more than to the HEOs.

If you are aiming for a top-line station, you should not stop improving until you can hear the transponder noise floor. This is a bit hard to do without a HEO to practice on but you know what I mean.

In the case of LEOs, hearing the beacon was and still is relatively easy. Not as easy as the local repeater; but in terms of serious satellite operating, a pushover. You could make do with a rubber ducky on your hand held radio to make contact with LEOs like MIR, ISS, the Space Shuttle and some of the FM birds. Forget about doing the same with a HEO. Even with simple beams or outdoor omni antennas you'll be restricted to very brief and very short range contacts when the satellite is close to perigee – and acting much like a LEO.

Remember too that the most exotic and exciting modes are not turned on around perigee. They are reserved for the long apogee periods when they are most useful. You will need to grapple with some sort of simple tracking system and achieve at least moderate gain in your antennas.

Receiver de-sensing can be a problem on some modes. Most HEO satellite work is conducted using full duplex. With up-link and down-link antennas in close proximity, often on the same rotator, your out-going signal can seriously degrade your receiver performance, even wipe it out. Diplexers or cavity filters can overcome this problem.

To do the antenna job properly, you would be well advised to invest in good rugged rotators to begin with. It's too late to consider adding a small dish or more yagis at some future time if your original decision was a little on the light side. A proven, reliable computer tracking system and a set of high gain antennas with low-noise, high gain preamplifiers at the feed points will fill the bill nicely. That's the ultimate. That will get you there. Anything left out of that list will make it that much more difficult. You will see it written that you can do without this, or without that; but the facts are that any compromise will be detrimental to your station performance and you'll only have yourself to blame. No good blaming AMSAT, the weather, or the neighbour's cat. If you intend to get a station together for the high orbiters, make "no-compromise" your watchword and you will not go wrong.

Apart from the core transceiver, cost blow-out can be alleviated by home brewing. You can home brew antennas and many operators do, particularly in the microwave area. You can make your own pre-amps, diplexers, polarity switchers, cavity resonators, even dishes and down-converters, and many operators do. If you have experience with a headband magnifier and soldering iron you can modify surplus MDS and satellite TV LNAs and down-converters. You can even—with engineering skill, a workshop and a good junkyard close handy—produce a very effective AZ/EL rotator system. Most serious EME-ers do, as they are apt to be dealing with much larger antennas be they dishes or Yagis. So, it can be done. Whether you build, buy or plunder is of little consequence, the main point is that you should do one or the other and not compromise by leaving out some essential item. Plan ahead now. You have plenty of time to put together an excellent station ready for P3E and Eagle.

Remember, you don't need to aim to make use of every feature that the new birds will offer. I don't know of anyone who's ever done that. If you can muster 2 m/70 cm SSB gear and a tracking antenna system as above there will be transponder modes to suit you and they will open up almost hemisphere-wide footprints to your station.

If your experience runs to microwaves, there will be modes that tie together 70 cm, 23 cm and 13 cm into transponder combinations that will whet your appetite.

Small parabolic dishes and multi-band patch feeds were becoming the industry standard before AO-40 expired.

While unusual, patch feeds are quite simple devices and are well within the capabilities of the home constructor. Home brewers did nearly all of the development of these antennas and the designs proved to be reliable and repeatable. In the last days of Oscar-40, they quickly began to supplant more traditional dish feeds. Satellite TV dishes of two, three and four metres diameter are relatively cheap and often available second hand. Many stations I contacted on AO-40 were using such discarded equipment, as was I, and even quite small MDS dishes of one or two metres diameter can be used on the higher frequencies like 2.4 GHz and above.

Don't be frightened of microwaves. They don't bite. You just need to get used to doing stuff that looks more like plumbing than electronics in some cases. There is plenty of help available in the pages of AMSAT publications and on the World Wide Web. The AMSAT-NA site is a mine of useful information, as are other AMSAT sites. If you have cut your teeth on the LEOs, now is a great time to consider upgrading your station for the forthcoming HEOs. Your new "Oscar" ground station will be useful in other areas too. If you do it right you will have the basis of a fine weak-signal station for terrestrial DX or meteor scatter. Aircraft enhancement is another area open to AMSAT-ers (and vice-versa). Hearing your own moon echoes will be drawing a rather long bow but some fully equipped Oscar-class stations can and do work the "big-gun" moon-bouncers.

## Next month

This has been a general introduction to the subject. In future issues I will get together some more specific information on each element needed to upgrade your station for the HEOs; beginning with the most important: **The antenna system.** How much antenna gain do you need? Positioning the pre-amp for the best noise figure. What is circular polarisation, how important is it and do you really need to provide right to left hand switching? What kind of co-ax to use? Diplexers and cavity resonant filters. Elevation rotators, do you need them? Flip-over mode, is it worth the trouble? Tracking software and Doppler shift compensation.

ar



## Feverish activity

The World Cup is over and billions of viewers watched the 32 teams fight it out till 9th July, when two European neighbours fought out the final in Berlin. Although there were plenty of reports on the matches, there were few live descriptions of the matches on shortwave, particularly in English. Internet streaming also was absent. Radio Netherlands did provide commentary from their domestic service of matches involving Holland, plus the World Cup final between Italy and France.

As reported earlier, Radio Slovakia International from Bratislava did indeed switch off their shortwave senders on 30th June. Programming can now be found on the Net and on an obscure satellite platform. Funding for the continuation of some language sections did pass the US House of Representatives but became bogged down in the Senate. It is unclear whether the programming has been revived.

My faithful Icom R70 finally died and I am left with the Yaesu FRG 7700.

A friend has promised he will look at

the moribund set. Anyway, propagation has been extremely disappointing with the MUF in the evening slipping as low as 7 MHz.

North Korea launched seven missiles and immediately created tension in the East Asian region. A clandestine station has been heard within the 25-metre band allocation. It is speculated that the senders are from Taiwan and the programming is aimed at the release of Japanese and Korean citizens who were illegally abducted by North Korean agents. After years of denial, the North Koreans eventually admitted to Japan, they had indeed done so and a few were released but these ceased when tensions escalated.

In June, a Chinese broadcasting station appeared within the exclusive 20 metre amateur allocation, first on 14260, then 14180 and finally on 14310 from 1100 to 1400. It is believed to have been a jammer against a religious station from Taiwan and the program was a relay from the Chinese National Radio (CNR1). There was no sign of the Taiwanese signal, leading to

speculation that it was a harmonic from 40 meters, where the Taiwanese transmitter is known to operate.

Bob Padula has just advised me that he has started "Australian DX Report" from WWCR on 9985 at 0945 to 1000 on Tuesdays. It apparently is a repeat of an earlier release on 5070 at 0200 Sundays.

## More fever!

June was a difficult month for me as I was fighting a suspected case of whooping cough. I am currently awaiting final test results and hope whatever it is would go away.

Well that is all for this month. Do not forget you can email me your news and comments to [vk7rh@wia.org.au](mailto:vk7rh@wia.org.au).

73 de VK7RH

ar

## PERSONALISED QSL CARDS

Westlakes Amateur  
Radio Club Inc.

W.A.R.C.  
Your supplied Club logo here

Progress through Activity

Operator's name

VK2ATZ

PO Box 3001  
Teralba NSW 2284  
Australia

MU Zone 59  
CQ Zone 30

Confirming Contact with..

Date Time Freq Mode R.S.T

Rig: Antenna: Pre-QSL via Bureau

Personalised QSL cards bearing your callsign, Club's name and supplied logo. White gloss card, full colour with WIA logo watermark if a WIA member. Alternative microphone if not. 25 cents per card. Orders in batches of 4, Minimum order 40 cards. plus postage. Email: [flusa@optusnet.com.au](mailto:flusa@optusnet.com.au) with details

This is a Westlakes Amateur Radio Club Project

## Got something to say about amateur radio?

*Perhaps you have had a contest adventure?*

*Maybe an organised DXpedition or just off by yourself to an out of the way place, or perhaps an unusual not-out-of-the-way place?*

*A real IOTA or even domestic 'IOTA' adventure, Pinchgut or Popes Eye perhaps?*

*Or you have devised an antenna that doesn't offend the body corporate?*

*Perhaps you have a historical record or story?*

*You built a homebrew whatever, or put together a kit or have a suitcase set you use in the park?*

*You might even disagree with some facet of the activity?*

## Share it!

*Tell Amateur Radio. We always welcome suitable material.*

*In the first instance send the editor a short synopsis and he'll put you on the right track (see page 1)*

## Prepare for the Contests

This month should be a busy one for us all. The Remembrance Day Contest is in the middle of the month and the ALARA Contest is at the end. So this month is the time to ensure that your equipment is all ready and working well.

We hope there will be many Foundation Licensees involved this year, and hopefully some of the YL Foundation calls will be among them.

The two Contests are different in their arrangements so make a good contrast to each other.

In the Remembrance Day Contest you

may not make a repeat HF contact with the same station unless it is on a different band. In the ALARA Contest you may make repeat contacts with the same station as long as there is at least one hour between contacts.

In the Remembrance Day Contest, the emphasis is on the largest number of contacts you can make in the 24 hours and you are scoring for your state as well as for yourself. By contrast, in the ALARA Contest the emphasis is on meeting friends and having a chat although, of course you want to make as large a score

as possible, at the same time but not at the expense of time to chat.

The ALARA Contest runs for 36 hours, rather than 24 so we have a better chance of 'meeting' on 80 metres on two evenings.

Please do have a go in both Contests. Everyone will be helpful and encouraging.

**Remembrance Day Contest is on  
13th – 14th August  
and the ALARA Contest is on  
27th – 28th August 2006.**

## Travellers from the south move north

The winter months are the months when southerners go north to escape the cold. If you are already a Northerner, please keep an ear on your repeaters for these visitors

Most amateurs carry 2-metres or 70-cm rigs in their cars so they can contact the locals. A friendly voice is always welcome.

Please do not ignore a visitor. They may need some help to find a particular place or they may be interested in hearing about your local beauty spots or places of special interest.

Some travellers do a lot of homework about the places they are going to see, but some wait until they arrive to discover what is worth seeing.

This year, with so many new Foundation licensees, there may be some strange and interesting calls to be heard. Some new call signs to add to your list.

Remember, too, if these contacts are with ALARA members they can qualify for the ALARA Award. Ten VK contacts from five call areas are all it needs to apply for this very attractive Award.

## A traveller's tale

Maria VK5BMT and OM Keith VK5MT were somewhere in the wilds of Northern Australia at the time they knew their daughter in Sydney was due to make them grandparents for the first time.

However, as we all know, communication with mobile phones is not the same everywhere, but they were determined to

hear the news as soon as possible.

They covered themselves from head to foot with mosquito netting before they climbed a hill carrying pole antenna, lantern, digital camera, cable and phone. They were thrilled to lock onto a Telstra announcement that a baby boy had arrived safely. When they were offered the option

to return the call they did so and were delighted to be able to talk to Mary direct – for a few minutes only – before the signal dropped out.

A very different and exciting way to hear of the arrival of your first grandchild. Congratulations to all concerned.

## Foundation callers on Monday nights

Those on the Monday night Net, on about 3.578, (the preferred frequency at the moment as there is a heterodyne on 3.580) were delighted to have Pam VK4FADD call in one night and equally delighted to hear the callsign VK5FJAY (for the FJ Holden!) used by a familiar voice.

Jenny has been a regular on the Monday Nets under her OM Kevin's callsign VK5AKZ, but last Monday she called in with her own. Congratulations Jenny – that makes OM, YL and two Harmonics all with callsigns! Fortunately they do not all live in the same household!

## The YL Nets

Propagation has not been good recently on 20 metres so the 222 Net has not had many people calling in. However, the regulars were pleased to hear June VK4SJ one Monday afternoon. June has been missing for a few months but when she called into the Net she was on her way to Alice Springs with her son. Maria has also managed to make contact once or twice, to say "Hello" to everyone.

Elizabeth VE7YL can usually be heard by someone in VK or ZL but few other DX callsigns are heard.

Hopefully we are at the bottom of the

sunspot cycle this year, so propagation should improve.

If you are free on a Monday afternoon, somewhere round 0530 to 0600 Zulu, tune up to 14.222 MHz. There will be some YLs to talk to. Gwen VK3DYL and Dave ZL1AMN take it in turn to run the Net but you can be sure someone will be there.

There are several Echolink Nets used regularly by YLs, the most popular one being on Sunday mornings. If you have Echolink, listen around I am sure you will find them and be pleased that you did.

## Contest Calendar August – October 2006

Aug	5	QRP Day Contest	(CW/SSB/FM/PSK31)
	5	Waitakere (NZART) Sprint	(CW)
	5	TARA Grid Dip	(PSK/RTTY)
	5/6	10-10 Intl QSO Party	(SSB)
	12/13	Remembrance Day Contest	(CW/SSB/FM)
	19/20	Keymen's Club of Japan Contest	(CW)
	19/20	SEANET Contest	(CW/SSB)
	26	ALARA Contest	(CW/SSB)
	26/27	TOEC WW Grid Contest	(CW)
	26/27	YO DX HF Contest	(CW/SSB)
Sep	2	Russian Radio RTTY Contest	(RTTY)
	2/3	All Asian DX Contest	(SSB)
	9/10	Worked All Europe DX Contest	(SSB)
	23/24	CQ WW RTTY DX Contest	(RTTY)
	23	Westlakes Cup	(SSB/DSB/AM)
Oct	7/8	PSK31 Rumble	(PSK)
	7/8	Oceania DX Contest	(SSB)
	14/15	Oceania DX Contest	(CW)
	9	10-10 International Day Sprint	(All Modes)
	14/15	JARTS WW RTTY Contest	(RTTY)
	14	Asia-Pacific Sprint Contest	(CW)
	15	RSGB 21/28 MHz Contest	(CW)
	23	RAOTC QSO Party	(CW/SSB/FM)
	28/29	CQ WW DX Contest	(SSB)

## Greetings to all Readers.

A few weeks ago some of you were kind enough to write encouraging words about this column. In return, I say thank you very much. One never knows who reads material, especially when it is a regular column. However, please be assured that your support is much appreciated.

A couple of things this month – further thoughts for newcomers to the business of contesting, and a welcome return of a previous experiment in Australian contesting.

Hope that there will be something there for many of you.

## Contest loggers – again!

Some four or five years ago I was roundly attacked by some VK contesters for suggesting that there were many

Australian AR operators who did not use computers in their shacks, so therefore our contests should continue to embrace pen and paper scoring methods.

At the time I was disturbed by these taunts, but I still believe that my summation of the situation at the time was right.

However, we all know that in today's fast-paced world, a few years can bring widespread changes. Today I would say that there are still operators of senior years who continue to work with the traditional methods, but I would concede that their numbers are quite thin, compared to those of all age groups now using computers in one way or another in their shacks. Of course, it is understood that younger operators use computers for almost everything, and this is where logging programs enter the field.

Some of this change has come

about because of the availability of comprehensive loggers for the DX contests, and more recently by some specifically for our RD Contest.

In this context, I would like to pay an historical tribute to Geoff Hudson VK3VR who produced an excellent RD logging program in the 1990s. It did everything from sending CW to total scoring of all categories of entrants. It was excellent! I know I used it for several years and it really was my own introduction to logging by computer. This helped me to tackle the "big" programs for the DX events.

2004 and particularly last year saw the emergence of several programs for VK contests – Alan Shannon VK4SN produced a marvellous thing for the VK/trans-Tasman Contests, and it has proven very worthy, as long as you remember that this is a post-contest logger, not one

designed to enter data as you go. The reason for this is simply that there are certain variables in the rules of the VK/trans-Tasman, and it can be useful to enter things quietly after the event.

2005 saw three loggers for the RD Contest. All three did the job well, but one of them I found to be less "intuitive" to operate than the other two (you know those people who say that if you have to read the handbook, it ain't a good product?).

John Drew VK5DJ's program proved to be very popular in last year's RD and I heard of several operators who said that they took part after an absence of many years simply because a logging program was now available. Most of these chaps were not younger men, but older people who have come to use computers for so much of their work activities. John told me some weeks ago that he will have his program updated for this year, so it is probably ready by now. So too have James McBride VK6FJA and Mike Subocz VK3AVV (VKCL Log) produced most comprehensive offerings. Please check the URLs below for these programs.

## VKCL Log

Whilst I have the greatest admiration for all of the authors of these aids to modern contesting, I cannot refrain from showing a strong interest in the VKCL Log program.

What attracts me to VK3AVV Mike Subocz's program is the way that he has adapted the modules to embrace almost all of our VK contests. Recently I had the privilege and pleasure of helping Mike with the Beta testing of VKCL v. 2.3.

Page layout is the same for each contest and information can be entered by mouse or by key presses – I strongly recommend the latter; it is just too fiddly to be reaching for a mouse whilst concentrating on exchange information.

However, Mike has not restricted his logger just to Australian contests. He has included some of the popular DX events as well, thus making this the most comprehensive Australian contest logging program available. Here is one program you can use for QRP Day, RD and ALARA (all in August), as well as the Oceania DX in October, Spring and Summer Field Days and CQ WW at other times of the year.

Log output is in comma-delimited format (.csv) for emailing, as well as

standard text (.txt) for keeping hard copy. As yet, Cabrillo format is not supported, so that may slightly restrict its use in DX events at present.

Mike tells me that he is considering adding a radio-controlling interface, something offered by the big DX loggers. This would be marvellous, so that band changes made on the screen would be transferred to the radio (if you have a suitable radio that has this facility).

## General Comments

1. There are those who say that we have too many contests. As a bald statement, they are right if you think that there are about 12 contests every weekend somewhere in the world. In addition, it can be argued that this shows that contesting is popular with operators and gives them a range of events relevant to their home areas as well as worldwide.
2. I do think that there is need for discussion by WIA about the allocation of Contest Sub-bands in Australia and I intend to present a paper to WIA Executive about this soon. Any comments from you, the band users, will be most welcome.
3. Computer logging is well and truly a fact of life in the contesting world, so I strongly urge all of you to familiarise yourselves with its use by trying one of the programs listed above. Do not think that you must leave it until a particular contest comes round, but load it up and set it up and practise with the program repeatedly until you are familiar with its operation. This is not hard to do and will pay you handsome dividends in the actual event because you will not be worrying about what to do to log the exchange. The good old rule "Practise, practise, practise" is a tried and true rule for most things in Life. Please do not ignore it then wonder why things did not go so well.
4. I referred in a previous column to the idea that a logging program sending CW is not considered "in the spirit of the contest". I mention it again now because it is a feature of the DX loggers, it is used widely by every CW contester and it does make for faster logging. For those serious DX contesters, the hourly scoring rate is important, so any feature that helps increase this rate will be used.

We have to get past this idea that the operator is not in physical control of the station during the contest exchange. We all know that ideas are bent every day of our lives, so if you want to justify auto CW sending, then you say to yourself that you have to press keys and type a callsign, so you are in physical control of your station. I suggest that we must "move on" as regards this issue, because I can assure you that using a logger and operating a key separately means that you must become very good at typing with your left hand whilst sending with your right (or vice versa for left-handers). Again, this is not impossible and CAN be achieved with "practice, practice, practice".

I do not raise this to cause dissention, even though I know that for some people it is an issue. It makes common sense to take advantage of what is on offer. Also, the argument that CW is not necessary any more so who cares is not relevant either, as there will be many dedicated CW operators around for some time yet. Only when we all die out will there be a place for debates about CW in contests.

## Summary

I suggest that you download the above programs and try them. Most people find that there is much to admire about them all, but that one in particular will suit YOU. All of the above are designed for Australian use, but VKCL Log embraces the widest range of VK contests.

The URLs for these programs are –  
**VKCL Log** <http://web.aanet.com/mnds>  
**VK5DJ RD** [http://vk5dj.mountgambier.org/Amateur\\_radio.html](http://vk5dj.mountgambier.org/Amateur_radio.html)  
**Logger**  
**VK6FJA** <http://www.rjmb.net/index.htm>  
**WinRD+**

## Something different

1. Some years ago, a group in VK7 decided to promote a contest called the Wadda Cup. For whatever reason(s), this never worked very well – I suspect because of lack of administrative cohesion.

You may be interested to know that Paul Linsley and the Westlakes AR Club have decided to reinvent this contest under the name 'Westlakes Cup' and the rules are below.

Please add this to your list of Australian events. It is phone only, so should appeal to most HF operators interested in contests. The Club

will welcome as much support for this new event as possible, and Paul says that he will make every effort to get results out quickly.

- This year marks the 30th Anniversary of the Radio Amateurs Old Timers' Club. To celebrate, the Club has decided to hold a QSO Party and all AR operators are invited to join in. This will be a two-hour event on a Saturday afternoon in October, so please see the rules below and note it in your diaries.

The term "Old Timers" does not mean that the operators are old fogies who

can only talk in terms of vacuum tubes and Morse Code. It means that they are operators who have had some years of experience on the air, joined by a bond not only of AR, but also of common interests and activities. Come and join us on this once-only occasion, please.

## Finally

This is my last column with you. Senior years are beginning to make themselves felt in the family and the time has come to back off somewhat.

I hope that my writings have been of

help to some of you and that if you hear me on the air you will call me. I shall still be active with the QRP Club and Radio Amateurs Old Timers' Club and shall be making every effort to get going on PSK as well as continuing my interest in the Linux OS.

Thank you all for your comments over the years. If you can help the AR community and WIA in this contesting area, please contact Trevor Quick VK5ATQ (vk5atq@wia.org.au) and he will be very happy to talk to you.

Good AR, good contesting and 73,

Ian Godsil VK3JS

# Rules: Westlakes Cup

Paul Linsley VK2BPL,  
Contest Manager

**Date:** Saturday, 23rd September, 2006  
**Time:** 1030 - 1130 UTC (20:30 - 21:30hrs EST)  
**Band:** 3.545 - 3.620 MHz  
**Categories:** Single Operator; Club; SWL  
**Modes:** SSB, DSB, AM  
**Max Power Limit:** 100 Watts Standard and Advanced Licence Holders  
 10 Watts Foundation Licence Holders.

once each half hour - if you can find the mischievous little devil.

This year, 2006, the BONUS station will be VK2BPL/BONUS.

## Points B:

Every Amateur Radio Club that takes part in the Contest will be worth two points. Club stations taking part will sign /CLUB after their call eg. VK2.../CLUB and may be worked once only. WIA stations such as VK2WI, VK4WIT, VK2BWI etc., will qualify under the same scoring system as Amateur Radio Clubs and must identify themselves with "/CLUB" after the Callsign.

## Points C:

Every station that does not fall into the BONUS category listed above shall be worth one point per QSO and may be worked only once during the Contest.

## Points D: SWLs

SWLs must record the callsigns and information of both stations in the QSO and will claim the same points as transmitting stations. For example, if the SWL hears the BONUS station he may claim one point plus three bonus points. If he hears a Radio Club Station, he can claim two points for the QSO.

## Contest Procedure:

At 1015 UTC (2015 hrs EST) on 3.585 MHz +/- QRM, the BONUS station will make an announcement outlining the basic rules of the Contest. If there are any last-minute questions to be asked, they will be answered at this stage.

At two minutes prior to the beginning of the Contest, the BONUS station will make an announcement to the effect that the Contest will begin in two minutes.

At the completion of the Contest, the BONUS station will call in all stations that wish to declare their scores for the Contest. The call-in will be on 3.585 MHz +/- QRM and will start from the lowest scoring stations (eg 10 pts) up to the top scorers in the Contest.

During this process, additional stations may be seconded from the group on frequency to take call backs from any region which the BONUS station thinks his signal may not be covering well. Such station/s may receive a special certificate in recognition of their efforts.

The object of this 'Check In' after the Contest is that stations may get an idea of the Contest results on the same night as the Contest takes place. Places will only be confirmed after the Contest Manager has received and checked the logs.

## Contest Logs:

Logs submitted shall contain the following information:

### Cover Sheet

Call Sign:	
Name of Licensee:	
Address of Licensee:	
E-Mail Address of Licensee: (optional)	
Points Claimed including BONUS Points	

## Rules:

All Stations shall call 'CQ Westlakes Cup'.

Exchange for points shall be a signal report and the operator's name.

After the contact is made and reports exchanged, the station that called 'CQ' must QSY at least 5 kHz from the frequency before calling again. There will be no 'sitting' on a frequency and working a 'pile up'.

You must QSY after each contact.

## Valid Contacts:

For this, the initial running of the Contest, only VK stations may be worked. The Contest may expand to ZL, P2 and other South Pacific neighbours in the future.

## Points A:

All contacts score one point.

There shall be a BONUS station operating in the Contest. The BONUS station is the station that holds the Cup from the previous year's Contest.

This station shall be worth one point for the QSO plus three bonus points and may be worked twice in the Contest,

## Log Details

Time: Local or UTC	
Call Worked:	
Signal Strength of station worked and name of operator:	
Signal Strength given to station worked:	

## Declaration:

"I declare that I have operated in accordance with the rules and spirit of the Contest and in compliance with my licence conditions"

## Awards:

An inscribed Cup will be awarded to the station with the Highest Points Score. The Cup will be inscribed with the Callsign and details of the winner and will be retained by the winner of the Contest.

The station that gains possession of this Cup will become the BONUS station for the next year's Contest. The Contest Manager retains the right to decide to change the rules of the next year's Contest.

Certificates will be awarded to the first, second and third place-getters in the Contest.

Additional Certificates may be issued to those who, in the opinion of the Contest Manager of Westlakes Amateur Radio Club, have contributed, maintained or attained prominence in any particular area of expertise or excellence.

## Logs:

Logs should be sent to:  
The Contest Manager  
Westlakes Amateur Radio Club  
PO Box 3001,  
TERALBA, NSW 2284

Email logs may be sent to:  
vk2bpl@hotmail.com

The closing date for the receipt of logs will be midnight EST on **31st October, 2006**.

Results can be expected to be processed and posted on the Westlakes Amateur Radio Club Website and distributed to WIA News outlets within one week of the closing date for entries. The Contest Manager's decisions with regard to logs and positions in the Contest will be final and no correspondence will be entered into regarding the results.

Good Luck to you all.

Paul P29PL/VK2BPL

*"Hey, Old  
Timer..."*



**If you  
have been  
licensed for  
more than 25 years  
you are invited to  
join the  
Radio Amateurs  
Old Timers Club  
Australia**

or if you have been licensed for less than 25 but more than ten years, you are invited to become an Associate Member of the RAOTC.

In either case a \$5.00 joining fee plus \$8.00 for one year or \$15.00 for two years gets you two interesting OTN Journals a year plus good fellowship.

Write to  
RAOTC,  
PO Box 107  
Mentone VIC 3194  
or call Arthur VK3VQ on 03 9598 4262 or  
Bill VK3BR on 03 9584 9512,  
or email to raotc@raotc.org.au  
for an application form.

## RAOTC 30th Anniversary QSO party

- Date:** Saturday, 21 October 2006.  
**Open** to all Amateur Radio operators  
**Bands:** 160, 80, 40, 20, 15, 10, 6 and 2 m and 70 cm  
**Category:** Single Operator  
**Modes:** CW, SSB, FM  
**Times:** 0600 – 0800 UTC (1600 – 1800 EST)  
**Calling:** "CQ OT"  
**Scoring:** A valid QSO requires exchange of call sign and name for all operators, plus member number for RAOTC members.  
10 points per QSO with non-RAOTC members  
20 points per QSO with any RAOTC member.  
50 points per QSO with either VK6OTN or VK3OTN.  
Stations may be worked on more than one band, each contact scoring one point.
- Award:** A Certificate will be available to any operator who scores a total of 250 points or more. Endorsements will be given for operators who score 200 points or more on both Phone and CW separately.
- Send  
Logs to:** Secretary,  
RAOTC,  
PO Box 107,  
Mentone, 3194;
- or via vk3js@bigpond.com by 31st October to claim a certificate.  
**email to:**

# DXCC Standings July 2006

(335 entities)(4th.July 2006)

Mal Johnson VK6LC

Callsign	Countries	Callsign	Countries	Callsign	Countries	Callsign	Countries
<i>DXCC Ex.(335)Phone</i>		<i>General listing-Phone</i>		<i>General listing-CW</i>		<i>General listing-Open</i>	
VK5MS	335/389	VK4AO	240/000	CT1EEN	294/000	VK2HV	289/000
VK4LC	335/382	VK8KTC	231/233	VK4ICU	291/000	VK3CIM	284/288
VE6VK	335/372	VK4DMP	227/228	VK3JI	274/299	VK6ANC	284/288
VK4UA	335/370	DL6MRS	226/000	VK6MK	249/252	9A2KL	280/283
VK5WO	335/368	UA6LDD	225/226	VK2CWS	245/247	UA6LDD	279/280
VK6LK	335/360	VK8AM	225/000	VK3DP	245/247	VK3JMB	277/000
VK3AMK	335/354	VK2AU	210/000	VK3DQ	243/270	VK6MK	256/259
VK3QI	335/349	VK3DVT	206/209	VK3CIM	235/236	VK8NSB	256/000
VK3AKK	335/348	VK6RZ	198/201	RD3AF	233/000	VK3DQ	255/284
VK2FGI	335/341	VK7JAB	198/000	VK7TS	219/000	VK5UO	251/255
VK3DYL	335/341	VK2EO	195/000	DL7PA	203/000	VK2CWS	251/253
VK3EW	335/341	G0VXX	184/000	VK6RO	204/206	VK2FHN	247/000
VK3SX	335/341	VK6EH	170/000	VK3KE	200/000	VK4DA	237/239
<i>Honour Roll (326) Phone</i>		VK3PA	178/179	PY2DBU	179/181	VK8AM	236/000
VK6HD	334/360	VK2EJK	176/000	VK4CXQ	174/000	DL9UBF	206/208
VK6NE	333/349	9A2KL	172/175	VK5UO	171/172	DL6USA	201/000
VK2AVZ	333/344	VK2BQS	166/169	SP9ADV	168/171	SP9ADV	200/203
VK1ZL	333/339	DL6USA	162/000	DK6AP	168/000	VK3PA	187/188
VK2DEJ	333/339	VK5EMI	160/000	VK4AN	167/169	VK2BQS	183/186
VK3TZ	332/336	VK7LUV	160/000	DL6USA	165/000	VK4CXQ	179/000
CT1EEN	332/336	VK4ARB	159/160	VK4UA	151/164	DL6UGF	161/000
VK3OT	331/345	JA6KTY	156/000	VK4AAR	144/146	VK5ATU	158/160
VK4OH	330/337	VK6HZ	151/000	VK8AM	138/000	VK3VB	153/155
VK6APK	330/335	VK2SPS	143/145	NOTM	135/000	VK2AR	152/156
VK4AAR	330/334	VK2QV	141/000	DL1TC	133/000	VK6HZ	151/000
VK3CSR	329/338	VK3JXO	141/000	VK7DQ	131/132	VK3JXO	146/000
VK3YJ	327/333	VK3DQ	138/152	VK2AR	130/133	VK2SPS	144/145
VK5FV	326/329	VK8LC	137/000	DL6UGF	126/000	SV1XV	142/144
VK4SJ	326/327	OK1ZSV	136/000	DJ4BG	121/000	VK4EZ	140/147
<i>General listing-Phone</i>		DL9UBF	165/000	VK5BWW	110/113	ON9MCR	129/140
VK3Euz	325/326	SV1XV	130/131	SM6GZN	110/111	ON5SPA	127/000
EA3AKN	323/331	VK4FNQ	134/000	T94VT	108/000	VK3OZ	126/127
VK2UK	322/327	VK4AN	133/136	9A2KL	103/000	VK7CQ	123/125
VK6ABS	322/000	WA5UA	128/000	DL3GDS	102/000	VK5DC	117/118
VK4LV	319/321	VK4VIS	127/129	<i>DXCC Ex.(335)Open</i>			
VK1TX	319/000	VK5ATU	126/128	VK4LC	335/382	NOMSB	117/000
VK6RO	312/319	VK2IRP	125/101	VE6VK	335/380	VK9RS	111/000
VK6LC	312/314	CU3AAT	125/000	VK4UA	335/372	VK2AJE	109/000
VK3JI	310/325	SV1UT	123/000	VK5WO	335/372	UA0IGV	103/000
DL2AWG	309/000	VK2VZQ	122/000	VK6HD	335/362	VK2AWD	102/106
VR2XMT	309/000	VK4EZ	119/125	VK3AMK	335/354	VK5GX	100/101
PY2DBU	308/315	VK5UO	112/115	VK3QI	335/350	DL1APX	100/000
VK4ICU	303/305	VK3CML	109/000	VK3AKK	335/348	RA3BZ	100/000
VK6DY	297/301	AX4EJ	105/000	VK3EW	335/341	VK1AI	100/000
JA3EY	296/300	VK1EOS	105/000	<i>Honour Roll (326) Open</i>			
VK4EJ	296/298	VK9RS	104/000	VK3OT	334/348	VK3EBP	253/255
DL1TC	294/295	3W2LC	102/000	VK2UK	334/339	VK3AMK	200/202
VK3DU	292/301	SV1FTY	102/000	VK2AVZ	333/344	VK3KE	183/000
VK2CSZ	290/293	SV1GYG	102/000	CT1EEN	333/337	VK2BQS	126/128
VK3KE	289/292	VK6ISL	102/000	VK3UY	333/336	DL4ARJ	120/000
VK2HV	288/000	HS1NGR	101/000	VK4AAR	332/336	ON5SPA	111/000
VK4BAY	287/290	VK5JAZ	100/000	PY2DBU	328/343	CT1EEN	110/000
VK2CA	287/000	VK6ZAI	100/000	<i>General listing-Digital</i>			
VK7TS	285/286	VK2RO	103/105	VK3EBP	253/255	VK3AMK	200/202
9V1RH	283/285	<i>DXCC Ex.(335)CW</i>		VK2AJE	109/000	UA0IGV	103/000
VK6ANC	282/286	Postion Vacant		UA0IGV	103/000	VK2AWD	102/106
VK3JMB	275/000	<i>Honour Roll(326)CW</i>		VK5GX	100/101	DL1APX	100/000
VK3DP	274/277	VK6HD	334/355	DL1APX	100/000	RA3BZ	100/000
VK3UY	264/266	VK3QI	334/346	VK1AI	100/000	<i>General listing-Digital</i>	
JA7MGP	260/000	VK5WO	333/349	VK3EBP	253/255	VK3AMK	200/202
VK2XH	257/000	VE6VK	330357	VK3AMK	200/202	VK3KE	183/000
DL3ASJ	256/000	<i>General listing-CW</i>		VK2BQS	126/128	VK2AJE	109/000
VK8NSB	255/000	VK6RZ	319/324	DL4ARJ	120/000	UA0IGV	103/000
VK3CIM	254/258	VK3AKK	312/317	ON5SPA	111/000	VK2AWD	102/106
VK8DK	253/254	VK3KS	307/335	CT1EEN	110/000	VK5GX	100/101
VK2FHN	243/000	VK4LV	299/306	VK5RY	100/102	DL1APX	100/000
				<i>Gen-listing 2m. Open</i>			
				Postion Vacant			
				<i>Gen-listing 6m. Open</i>			
				VR2XMT 154/000			
				VK4FNQ 141/000			
				CT1EEN 110/000			
				VK4ABW 109/000			
				VK6JQ 103/104			
				VK4CXQ 101/000			
				<i>Gen-listing-Satellite</i>			
				VR2XMT 112/114			
				VK3XDQ 106/000			
				<i>General listing-SWL</i>			
				DE2DAD 100/000			

	Callsign	2m	6m	10m	12m	16m	17m	20m	30m	40m	80m	160m	Bands	Total	Average
1	VK6HD			303	256	320	286	329	295	328	312	238	9	2667	296
2	VK3QI			285	271	298	278	333	297	288	232	105	9	2387	265
3	VK3EW			278	231	304	254	328	137	292	284	106	9	2214	246
4	CT1EEN		110	294	290	324	305	328	146	243	163		9	2203	245
5	VK5WO			155		153		252	109	225	134		6	1028	171
6	PY2DBU			198	125	185	103	279	102				6	992	165
7	VK6LC			119		153		306		175	125		5	878	178
8	9V1RH				141	264	119	222		129			5	875	175
9	VK3PA			133		139		253		136	187		5	848	170
10	VK2CA			162	101	203	108	205					5	779	156
11	VK4AN			217		233		272					3	722	241
12	XR2XMT		154			127	162	172					4	615	154
13	VK3DYL			114		168		295					3	577	192
14	VK3KE			108		153		268					3	529	176
15	VK2DEJ					114		305		101			3	520	173
16	WA5UA			102		106		128					3	336	112
	Averaged		110	190	202	203	208	282	181	227	205	150	6	1418	210

Awards information and downloadable files are available on WIA website <http://www.wia.org.au/awards/> or email to: [awards@wia.org.au](mailto:awards@wia.org.au)

Malcolm K. Johnson VK6LC, WIA Awards Manager Postal address: PO Box 196 Cannington. 6987. Western Australia.  
email: [awards@wia.org.au](mailto:awards@wia.org.au), website: <http://www.wia.org.au/awards/>

## New DXCC entity: Republic of Montenegro

Mal Johnson VK6LC

The WIA formally announces the acceptance of the Republic of Montenegro as the 336th. DXCC entity to our DXCC Programs.

The United Nations admitted the Republic of Montenegro as its 192nd member on 28th. June 2006, and that action automatically makes the tiny Balkan nation a new DXCC entity.

The WIA has added The Republic of Montenegro to the DXCC Programs.

WIA DXCC formal documents and website data will take some time to update.

Claims for DXCC credit will be accepted immediately from current Montenegrin radio amateurs using their YU, YT, YZ, 4O and 4N – prefix call signs until the International Telecommunication Union designates a new call sign block for the new country.

ar

## HF Propagation Predictions

– go to [http://www.ips.gov.au/HF\\_Systems/7/1/4](http://www.ips.gov.au/HF_Systems/7/1/4)  
for up-to-date information.

You will need Lat/Long of both ends of circuit. Type >Find latitude/longitude< into your search engine. Strangely, a good, simple, quick site for location is <http://www.astro.com/atlas>

## Sunspot Numbers

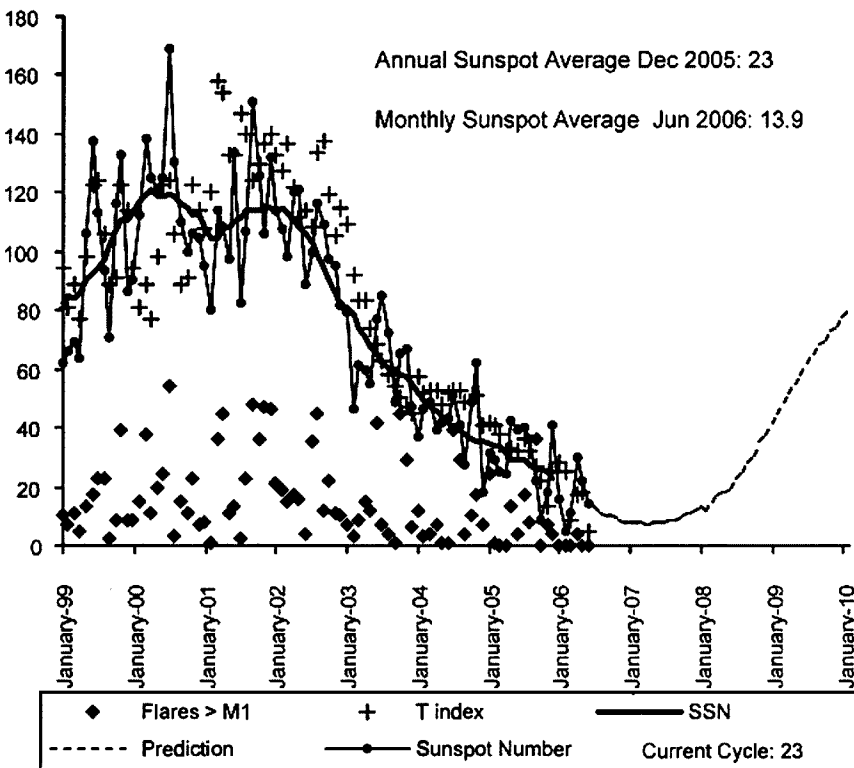

Drawn from data provided each month by the Ionospheric Prediction Service  
Web Ionospheric Predictions - [http://www.ips.gov.au/HF\\_Systems/7/1/4](http://www.ips.gov.au/HF_Systems/7/1/4)



## Those were the days!

The experts tell us that we still have not yet reached the bottom of the sunspot cycle, but I must admit that conditions seem to be worse now than at any time that I can remember. If the same experts are right then in a few years we can look forward to conditions that will be “sparkling”; similar to the conditions that we enjoyed in 1947, when it was possible to work the world just running a few watts into a simple antenna on 28 MHz.

How things have changed. In those days a STABLE VFO was a rarity, with the majority of stations running crystal-controlled transmitters and calling CQ, announcing that they would be tuning up from, say 28025 to 28200 for calls! No TVI in those days! The main discussion at the radio club meetings was how to stabilise 807s that were notorious for parasitic oscillations, and how to improve receiver selectivity with the war surplus “command sets” that were becoming available. THE method of “accurately” measuring frequency was the war surplus BC221 – it was many years before we had the luxury of digital readout.

Although conditions may be down, we now have quite a number of factors in our favour. The quality of the receivers we now use, with DSP, are far superior for resolving weak dx signals to the ones we acquired or built over 50 years ago. The gradual acceptance of SSB was a major step forward for voice communication. Similarly antennas have improved with a larger number of beams now in use. The quality of feed lines has also dramatically improved. The surplus coax was nothing like the quality of the coax we use today.

Another facility that we also have, which I believe is not used as much as it could be, is the IARU Beacon chain. If the band appears dead CHECK THE BEACONS (all the details are in the WIA Callbook). It is surprising how often a path is open to a DX location. Maybe everyone is doing just what you are – listening – so call CQ! It can be very productive!

ZK1CG, reports as of June 1 2006, ZK1 stations will finally change to the new E51 prefix in the Cook Islands. On August 15 2004 ITU Operational Bulletin

No. 818 stated “Following a request from New Zealand, the International Call Sign Series E5A-E5Z, in accordance with the provisions of No. 19.33 of the Radio Regulations, has been provisionally allocated to New Zealand for exclusive use by the Cook Islands (formerly ZK1).” Don’t forget to add the prefix E5 to your logging programs. ZK1CG plans to be QRV with his new call E51CG on June 1st and later with E51USA.

The VI9NI team on Norfolk Island have been very active on all bands in spite of major problems at the beginning of their operation with gale force winds bringing down their antennas.

Neil VK6NE has recently compiled a “most wanted list” from VK DXers – the results of which are tabulated below:

Position	Prefix	Country
Equal 1	3Y/B	Bouvet Island
	PY0/T	Trinidad Island
	VP8/O	S.Orkney Island
Equal 2	VP8/S	S.Sandwich Island
	VP8/G	S.Georgia Island
Equal 3	P5	North Korea
	PY0/P	St Peter & Paul
4	FR/J	Juan de Nova
Equal 5	KP1	Navassa Island
	SV/A	Mount Athos
	3C0	Pagalau Island
	BS7	Scarborough Reef
	CY0	Sable Island
	VU7	Lakshadweep Island
Equal 6	HK0/M	Malpelo Island
	PY0/F	Fernando de Norohna
	VP8/S.S.	S.Shetland Island
	7O	Yemen
Equal 7	CE0/SF	San Felix Island
	S0	Western Sahara
	TY	Benin
	YA	Afghanistan
Equal 8	EP	Iran
	FO/C	Clipperton Island
	1A0	S.M.O. of Malta
	TT8	Chad
Equal 9	4U1ITU	ITU Geneva
	9Q	Congo
	KP5	Desocheo Island
	CE0/JF	Juan de Fernandez
Equal 10	VP6/D	Ducie Island
	3Y/P	Peter 1st Island

It is interesting to see that Peter 1st Island is still in the top ten in spite of the recent operation from there. Likewise TY (they had just under 24,000 QSO’s) and S0 (who had just under 30,000 QSO’s) have recently been activated with dedicated DXpeditions. Even more surprising was to see Afghanistan at number 7, for T6KB LRM and T6X were very active for at least 6 months and 11 months respectively during 2005. T68G has also operated for 9 months in 2005 and is still active, as recently as the WPX Contest, and will be there until March 2007! Many thanks to Neil for collecting the information, which I am sure readers will find very interesting to compare with the widely circulated lists from North America and Europe.

## Now to DXCC news.

Since June, the ARRL DXCC desk has approved the following operations for credit:

T68G, Afghanistan, current operation effective April 2005.

4W6AAB - Timor – Leste Current operation effective May 22, 2006

ZV0F - Fernando de Noronha Operation from March 30 through April 4, 2006

6O0M – Somalia Operation from April 7 through April 24, 2006

S01R - Western Sahara Operation from April 11 through April 21, 2006

YI9NS – Iraq Operation from January 5 through March 28, 2006

YI9HU – Iraq Operation from May 18 through June 5, 2005

HN0Z – Iraq Operation March 27 and 28, 2004. Operation May 29 and 30, 2004

A6/OD5TX - United Arab Emirates Operation from October 5 to November 5, 2005.

TT8WL – Chad November 19, 1996 through March 8, 1997

J5DOT Guinea-Bissau Operation from April 25 through May 5, 2005

The ARRL DXCC Desk has announced DXCC program fees will rise slightly when a new awards fee schedule <<http://www.arrl.org/news/stories/2006/05/23/3/>>

fees-06Jul.html> went into effect July 1. The fee for a basic DXCC application (including certificate and pin for initial applications only, 120 QSO maximum) and for first endorsement applications within a year will increase to US\$12 for ARRL members and to US\$22 for foreign non-members. Second and subsequent endorsements (120 QSO maximum) within a year will be US\$22 for ARRL members and US\$32 for foreign non-members. The US\$10 fee for a basic DXCC application (120-credit maximum) was established in 1990, and the current overall fee schedule has been in effect since 1998. "It costs us to provide this service," explains ARRL Membership Services Manager Wayne Mills, N7NG. "We don't make any money from DXCC." The cost of other DXCC-related items such as plaques and pins also will go up July 1. Mills advised that DXCC fees would increase further in the years ahead—possibly at two-year intervals - at least to catch up with the Consumer Price Index, which has risen 49 percent since 1990. He estimates the active population of DXCC members at between 15,000 and 18,000.

## DXCC Rule Change

Upon request of the Programs and Services Committee (PSC), the DXAC has studied the impact of a change to the DXCC Rules. The rule change will become effective June 15, 2006 at 0001 Z. New text replaces the previously removed DXCC Rule, Section II:

Political Entities, Paragraph c). The new text shall read:

- c) The Entity contains a permanent population, is administered by a local government, and is located at least 800 km from its parent. To satisfy the "permanent population" and "administered by a local government" criteria of this subsection, an Entity must be listed on either (a) the U.S. Department of State's list of "Dependencies and Areas of Special Sovereignty" as having a local "Administrative Centre," or (b) the United Nations list of "Non-Self-Governing Territories."

Rule 1c) is intended to recognize entities that are sufficiently separate from their parent for DXCC purposes but do not qualify under Rule 1a) or 1b). The new rule will cause a change to Point 1 status for certain entities. This

in turn will reduce the mileage for a first separation for these entities from 800 km to 350 km.

The lists referenced in the text of the rule can be viewed at the following Web sites: the DOS list of Dependencies and Areas of Special Sovereignty at <http://www.state.gov/s/inr/rls/10543.htm>, and the U.N. list of Non-Self-Governing Territories at <http://www.un.org/depts/dpi/decolonization/trust3.htm>.

QSOs with any new entity resulting from this rule change will count for credit for the new entity only if the QSOs are made on or after the Start Date for the entity. In no case will QSO's made prior to the date of this notice be considered for credit for any new entity created under this rule. Applications for DXCC award credits resulting from this change will be accepted on or after October 1, 2006.

By now everyone knows that the Republic of Montenegro recently declared independence. This was the result of a national referendum on May 21st, 2006. All international authorities and institutions, as well as the government of the Republic of Serbia, from whom Montenegro separated on June 3, 2006, have recognized the referendum. We now have a new DXCC entity.

The first major Amateur Radio activity from this new DXCC entity will be managed by an International DXpedition Team, which is planned to take place very quickly after DXCC approval has been granted to Montenegro. The DXpedition Organizing Committee consists of: Bob Grimmick N6OX, Hans Blondeel Timmerman PB2T, Martti Laine OH2BH, Dave Sumner K1ZZ, Linda Sumner KA1ZD (YL), Ranko Boca YT6A, Vladan Kecman YT3T, Wayne Mills N7NG and Carsten Esch DL6LAU.

Initial activity from Montenegro will take place on all Amateur Radio bands and all modes, for two to three weeks from several locations along the Adriatic Coast.

Amateur radio operators who feel they are qualified to handle a real pile-up can apply to be part of the 2006 International Team for the DX Festival in Montenegro. The Organizing Committee will allow or reject candidates based on the information provided in their applications (<http://www.yu6scg.cg.yu/download/application.txt>). As the exact time-frame for the expedition is not yet known, applicants should indicate the weeks that they can be available (July 15

through September 15, 2006).

One object will be to establish an 'All time DXpedition World QSO Record', expected to be well over 200,000 QSO's. With this amount of activity everyone should have an opportunity of working them without too much difficulty.

**9Q5 Democratic Republic of Congo.** Hopefully, we will soon hear legitimate stations active from here. Four Amateur Radio operators, who have been working in this country for several years, and with government officials, think they may be close to obtaining their licences. Gus SM5DIC (9Q1D), Georges VE2EK (9Q1EK), Phil F5LTB (9Q1TB) and Ghis ON5NT (9Q1NT), have all recently paid \$500 to the PTT for their licences. They are now waiting for the government officials to process their paper work. There have been no valid 9Q, 9R or 9S licensed since 2004.

**3D2 Rotuma.** F4ELJ, F0ELK and F0ELI will use the call 3D2BD from Rotuma (OC-060) from 5th August to 17th August. On their way home they will stop and operate from Suva, Fiji Islands (OC-016), from 18th August to 21st August. QSL via F4ELJ, direct or bureau.

**OX Greenland.** Dwayne KD4POJ will spend eleven months in Greenland (NA-018) starting on 30th July. He plans to operate as OX3PG on most bands and modes and to participate in contests as work and propagation permit. QSL direct only via WA0SMQ.

V47/DL2AAZ Look for him from 20th July to 10th August on 40/20/15/10 metres on SSB or CW using 100 watts to a dipole antenna. QSL direct or via the bureau to his home call.

**5W0TR (K8AQM), 5W0JB (N8CC), 5W0BS (KG8CO), 5W0KI (JF3MYU) and 5W0DW (KT8X),** will be active on 160 to 30 metres inclusive on SSB, CW and digital modes from 25th July to 10th August. They also plan to operate in the IOTA Contest. QSL direct or via the bureau to the operator's call.

Special thanks to the authors of *The Daily DX* (W3UR) and *425 Dx News* (I1JQJ) and *QTC DX* PY2AA for information appearing in this month's *DX News & Views*.

For interested readers you can obtain from W3UR a free two-week trial from [www.dailydx.com/order.html](http://www.dailydx.com/order.html)

ar

# VHF/UHF - an expanding world

## Weak Signal

David Smith - VK3HZ

The annual GippsTech conference was well attended by amateurs from around the country. Peter VK3KAI and his band of helpers once again organised a very slickly-run weekend with all events running to plan and suitable diversions organised for the many "other halves" who attended. The conference presenters covered a wide range of subjects – both theoretical and practical – in the areas of propagation, construction and operation for the VHF/UHF/Microwave bands. By Sunday afternoon, I was exhausted from the effort of absorbing the sheer volume of information presented. The Friday and Saturday night dinners provided good opportunities to meet people and discuss current topics of interest. It's always interesting to meet someone whom you'd previously only spoken to – the shattering of the mental image you had formed of the person is almost audible! So, congratulations to all concerned for another great weekend. To those who have not yet attended a GippsTech conference, I would highly recommend that you make the effort. Get in early with the XYL and reserve that second weekend in July 2007 (July 7 & 8) now.

## EME

Congratulations to Doug VK3UM who has used his new dual band (70 cm / 23 cm) feed to reset the VK 23 cm EME

distance record. On June 10th, Doug worked Michael CT3/DL1YMK on the island of Madeira - a terrestrial distance of 18,354 km. Of course, the actual radio path is via the moon and the path length does not change much for different stations, so one might ask what is the relevance of the terrestrial distance? To work a station on the other side of the earth via the moon, the antennas at both ends have to be very low to the horizon, and ground noise pickup then causes significant degradation to the signal. Also, apart from some areas of Europe and the USA, EME-capable stations are few and far between and it is hard to find a station at maximum terrestrial distance (particularly for southern VK where the opposite side of the Earth is the mid-Atlantic Ocean – not many EME stations there!). Fortunately, Michael DL1YMK had organised an EME DXpedition to Madeira. Michael's equipment consisted of an Icom IC-910H with 500 watt PA's on 70 cm and 23 cm feeding a 4.1 m fold-up preloaded/stressed dish. After several attempts, Doug and Michael successfully worked on 70 cm where the small dish size was definitely marginal. Then, again after several attempts, they succeeded on 23 cm with surprisingly good signal strength (O/549).

Please send any Weak Signal reports to David VK3HZ at vk3hz@wia.org.au.

*continued next page*

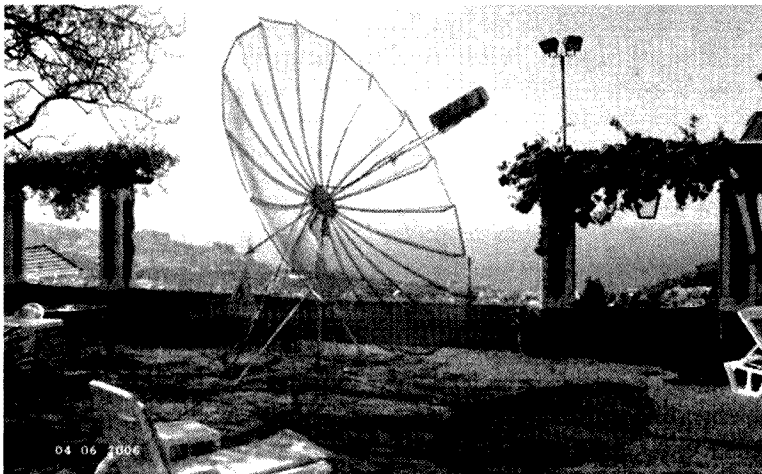

CT3/DL1YMK EME DXpedition 4.1 m Dish

# OzGear

www.OzGear.com.au

RadioCommunications & Electronics

Ozhelp Services Pty Ltd T/as Ozgear

Suppliers of radiocommunications, electronics and computer products and electronic test equipment

Ph 07 3114 2506

sales@ozgear.com.au

Brisbane QLD

Manager: Doug Hunter VK4ADC

**WE HAVE MOVED!**

**Unit 2**

**139 Beenleigh Rd  
Acacia Ridge 4110**

**Ozgear yagi antennas  
for 6m, 2m and 70cm  
now available**

**ICOM &  
YAESU**

**Australian-sourced radios with  
Australian-based manufacturer  
warranties**

Authorised Aust Icom and Yaesu dealer

Antenna, cable, interface, tuner and general accessory products from...

Amidon, Andrews USA, Austek, Benelec, Bushcomm, Comet, Dalwa, Diamond, Garland, GeoSensory, GME, Icom, Kingray, LDG, Lutron, Mobile One, RFI, Sangean SSGC, TET-Emtron, Tigertronics, Yaesu, ZCG Scalar plus ARRL and RSGB publications

# ALTRONICS

Many products stocked

**Product & pricing info?**

Phone, email or visit us on the web at

**www.OzGear.com.au**

for the latest info plus on-line ordering. Our latest price list can be downloaded at any time

Payment?

**Direct Deposit**

**PAY**

**elpas**

**MasterCard**

**VISA**

# Digital DX Modes

**Rex Moncur – VK7MO**

Allan VK4EME at QG63kq, 135 km North of Brisbane is a new and active participant in the 144 MHz meteor scatter activity sessions. Allan uses a TS2000 transceiver running 80 watts to a 10 element DL6WU Yagi. Since May, he has worked VK2ZZF, VK2EAH, VK2AWD, VK2FZ, VK3HZ, VK3HY, VK3VHF, VK3II and VK7MO. On his better mornings, he has been completing four QSOs with stations down south in the one-hour session.

Nick, ZL1IU, is now operational on Digital Modes and has been attempting to work across to VK on meteor scatter. The distances are generally over 2000 km and thus one needs a very good take-off. Tests to date with VK4AFL, VK2FZ and VK4EME have resulted in one or two decodable pings an hour, well short of completing a QSO. It seems that it will require someone with a very good take-off and lots of patience to complete a QSO in normal conditions. However, Nick does provide an excellent opportunity to test out ideas on tropo-ducting extensions of meteor scatter as were discovered last

summer with ZL3TY. It is suggested the stations in VK2 and VK4 monitor the Hepburn charts and whenever these indicate "yellow" for a few hundred km at either end of the path try some tests with Nick and see if we can improve our understanding of this dual mode of propagation.

Peter VK5ZPG reports on how meteor scatter can allow stations who are remote from concentrations of VHF activity to participate in VHF DX and then because of this activity are available for SSB contacts when the bands are open. Peter moved to Quorn near Port Augusta in 2002 after operating VHF/UHF from Willunga close to Adelaide. Following the move, contacts on VHF/UHF were nil except for a few sporadic E contacts on six metres around Christmas each year. He almost gave up on VHF/UHF until he noticed reports of meteor scatter in this column. Over the last 10 months, Peter has been an active participant in the weekend meteor scatter activity sessions and has completed 78 contacts on 2 metres using FSK441. As a result of this

activity, he has maintained an active VHF station and completed 32 SSB contacts in the same period, as well as contacts on JT65. Peter says "I'd recommend MS to others in my position, located away from Adelaide (or any capital city) and normally missing out on VHF/UHF activity". Peter's experience is in line with my own where from Hobart, SSB openings to the mainland are so rare that there was almost no activity and stations dropped out of VHF DX. Through the use of Digital Modes, I can regularly work into VK3 on JT65 and to VK1/2/4/5 via meteor scatter on FSK441. As a result of being active, I am then aware of the rare DX openings that allow SSB contacts, enhancing this mode of activity as well. The message is that stations who are remote for the concentration of VHF activity on the East Coast of Australia but within meteor scatter range (1800 km) should consider this mode as an opportunity to participate in VHF DX in all its forms.

Please send any Digital DX Modes reports to Rex VK7MO at [rmoncur@bigpond.net.au](mailto:rmoncur@bigpond.net.au).

# The Magic Band – 6 m DX

**Brian Cleland – VK5UBC**

June continued to produce some good sporadic E openings particularly in VK2, 3 & 5. Interstate beacons and/or TV signals were recorded on many days in these states but unfortunately not always accompanied by contacts.

A good opening occurred between VK1/2 and VK5 on the afternoon of the 11th June. Keith VK5AKM and Brian VK5UBC portable at Corny Point (PF85mc) worked several stations including VK2ZZY, VK1ZQR, VK2KRR, VK2PDW and VK2TG.

On the 29th June, Norm VK3DUT worked ZL3AAU and VK4FLR. Norm seems to have a permanent path to New Zealand. The same day Joe VK7JG reported the band open to VK4 but could not raise a station and Allan VK2ADB in the Snowy Mountains reported hearing the Townsville beacon.

With very little to report in mid-winter, I thought it would be interesting to look at the background and achievements of one of Australia's keen 6m DXers, John VK4FNQ.



John VK4FNQ

John was first licensed in 1979 and has operated with the following callsigns:-  
11/08/1979 – 28/01/1982  
VK8NGM Darwin  
28/01/1982 – 6/04/1982  
VK4NIE Muttaborra

22/09/1983 – 6/03/1984  
VK4YLG Muttaborra  
6/03/1984 – Today  
VK4FNQ Charters Towers

## John says:-

My first activity was on HF from Darwin, which was an excellent location for DX where I also used a Lafayette valve receiver on six, on which I heard many JAs.

In mid 1979, I purchased a Kenwood TS520-S as a novice and around the same time Kenwood advertised their complete station so I purchased the AT200, DG5, EXT VFO, SP520 and the TV506 transverter.

I put up a dipole to listen on 6 m in August 1983 and heard nothing for weeks. I remember one day hearing a lot of noise (I now know it was BYTV) and suspected the TV506 had failed. A few days later (31/10/83), I heard JA stations calling so I worked several. The first VK was Paul VK2YVG in Sydney on 01/11/83. The interest intensified from there and I built a 4-element Yagi and logged many QSOs in VK and JA.

I travelled around from 1984 to 1988 until settling in Townsville. I operated portable from many locations. I carried the 4 ele around and operated portable from Wonga Beach north of Cairns to Cloncurry and all points in between. I remember one night going to activate the Croydon shire on 80 metres and working a heap of JAs from the mobile on 6 m. (north of Richmond).

After settling down near Townsville, I built the 6-element Yagi from the ARRL

Antenna Handbook and still use the design as my backup antenna. I have experimented with this antenna with good results and a 3-element quad that is tuned for 52 MHz repeater work. After moving to Charters Towers I built a 9-element Yagi on a 10 metre boom (VK4ABW design) which is up 19 metres. When mobile, I mostly use a ¼-wave whip.

Over the years I have used several Rigs including:-

Kenwood TS520-S + TV-506 Transverter

ICOM IC 505 + HL66-V amp

Kenwood TS 680-S + HL66-V.amp

Yaesu FT847

For logging I used a paper log until 2000 in conjunction with a database so I could cross reference to the log books, and I am now using MixW and have transferred the database entries into MixW.

I have worked 138 countries on 6 m. One of the more memorable portable QSO's was VK0SJ on Macquarie Island (12 May 1986). I was located at Trinity Beach - a northern suburb of Cairns. Another was YC0UVO (19 Mar 1989) from the mobile near Hughenden. My most memorable European opening was on 29 October 2000 which lasted from 0641Z to 1011Z (operating time), in which I worked 90 stations including 4N, 9A, EH, EH8, I (55 worked), IG9,

LZ, S5, UY, YO, YU and S3.

My log database has over 14000 entries on 6 m. Japan is by far the easiest worked with over 3300 QSO's in the log. I have around 400 JCC's and 200 JCG's confirmed from Japan on 6 m. The log also includes around 500 QSO's into Italy.

I considered the best years were 1989 - 1992 with 1320 QSO's logged (including approx 534 JA and 213 VK) and 1999 - 2002 with 4823 QSOs logged (including approx 1400 JA and 900 VK).

My advice to newcomers to 6 m is to program beacons and some out-of-band indicators into a scanner to give an idea when the band is open. Although the band will appear to be dead, it will produce propagation at surprising times. I use an Icom IC505 with a 6-element Yagi in scan mode 24 hours, 7 days a week and even in the depths of winter will produce some QSOs.

John is meticulous in his logging and logs all contacts plus beacons and stations heard. Although he has had many international 6 m contacts and worked many countries, John still enjoys a chat during the Australian sporadic E openings. When the band is open to Northern Queensland, he can normally be found on 50.190 MHz.

Please remember to send any 6 m information to Brian VK5UBC at [bcleland@picknowl.com.au](mailto:bcleland@picknowl.com.au).

ar

# What would you have said?

Jinkin (Jay) Frame

Quietly sitting drinking a welcome cup of coffee after a most interesting talk on Antenna tuners – yes it was the monthly meeting of the DXCC, I saw Alan heading my way. I thought now what will he be asking me this month!

Sure enough - straight to the point - "Jay do you QSL?" "Well, yes I do." "Ah" said Alan, "but do you QSL every contact or only QSL for cards received?"

"Before I answer that Alan, what has prompted the question?"

"Well, I have now been licensed for 12 months and have, as I said I would, QSL every QSO that I have had – but the return has been very disappointing. Every contact I have had said that they would QSL via the bureau, and I would have thought that in 12 months I should by now have received at least one QSL?"

"Well I am afraid that it is a fact of life that quite a number of amateurs do say that they will QSL but have intention of

doing so – don't ask me why because I do not know. Probably the worst example of this is where they ask for QSL's direct only, and then never reply."

"At the other extreme there are the amateurs who do QSL absolutely every QSO without fail. So going back to the bureau, just be patient - you may be pleasantly surprised in a month or two."

"Basically DXpeditions are excellent for confirming contacts – amateurs go on a DXpedition for the sole purpose of making as many QSOs as possible AND confirming them. The usual procedure is either direct – with a self addressed envelope and funds to cover return postage – or via the bureau – or if you

are really only interested in getting your ARRL DXCC country total confirmed as high as possible then there is LOTW. More and more stations are putting their QSO data there."

"Going back to your original question – do I QSL – the answer is yes for every contact - via the bureau. If I want a particular card then I will QSL direct to make sure I get it for occasionally cards do get lost in the Bureau (and for that matter in the post!)"

"So the policy is up to you - if you say you will QSL then do so."

What would you have said?

ar

# Beyond our shores

David A. Pilley VK2AYD

## Spain:

### Restructuring

New Amateur Radio regulations became effective in Spain back on June 10. The new licensing regime essentially eliminates the former Novice, General and Restricted licence classes and extends the same privileges to all radio amateurs. URE, Spain's IARU member-society, says the change means EB and EC prefix call signs will be showing up on all bands now, in addition to the familiar EA prefix.

(ARNewsline)

## Netherlands:

### Restructuring

In the Netherlands, IARU member-society VERON reports that as of June 10, radio amateurs in the Netherlands are using the band 7.100-7.200 MHz on a secondary basis with a maximum power output of 250 watts.

(ARNewsline)

## Japan:

### Technology Trivia:

#### The Hard Drive Turns 50

You may find it hard to believe, but the computer hard drive will turn 50 on September 13th.

According to Hitachi, the first Hard Drive was called the RAMAC and designed for use in the IBM System 305 Computer. It required fifty 24-inch diameter platters coated with iron oxide paint mounted on a rotating spindle to store only 5 megabytes of data.

Now, compare that to the current desktop PC drives that are available with a capacity of up to 800 megabytes and terabyte size drives for home PC are rumoured to be not far away.

(ARNewsline)

## Germany:

### More Trivia

#### Soccer, FIFA and RFID

Every ticket holder of 2006 FIFA World Cup Soccer games is carrying an RFID or Radio Frequency Identification Tag. These tags are scanned whenever a fan arrives at the gates of any of the 12

stadiums across Germany.

Philips Corporation supplied the RFID tags, the track-and-trace chip tags. They are to combat counterfeiting and ensure only those with legitimate tickets can get in to watch the matches.

(ARNewsline)

## Radio Aids:

### New Google mapping improvement

Most radio amateurs who have computers and access to the internet have downloaded Google-Earth and taken an aerial view of their QTH. Google have released the latest upgrade to the mapping tools that should have a big interest to those that are Grid Square hunters. The improvements include a major expansion of the satellite imagery included in Google's three-dimensional software for touring Earth.

The Mountain View based company says four times more land will be covered in the latest version of its free Google-Earth software. This will enable about one-third of the world's population to obtain an aerial view of their homes and neighbourhood and maybe even antennas as well.

(ARNewsline)

## UK:

### Pat Hawker G3VA honoured by the Queen

Many of the older hams that read this column will know Pat Hawker, if not in person, from his written words. Pat Hawker G3VA, has written the column "Technical Topics" in the RSGB Journal for almost 50 years. Now G3VA has been named as Member of the British Empire in the United Kingdom's recent Queen's Birthday Honours List.

Pat has had an illustrious career. After World War II, G3VA became an assistant to the General Secretary of the RSGB. A few years later,

he was editing the *Radio and Television Service, Radio and Television Engineer's Reference Book*, while laying the foundations of a technical career with the Independent Broadcasting Authority. He later became the writer of "Technical Topics", for which he is still world-renowned and the most read column in "RadCom". His column was so well read that it has been re-produced in four excellent books. The latest, covering the years 1990-1994, known as "Technical Topics Scrapbook" and is available from the WIA Bookshop. No shack should be without one.

## World:

### More trivia

#### A new IRC

The Universal Postal Union (UPU) has announced that a new International Reply Coupon (IRC) design <http://www.dailydx.com/2007irc.jpg> has been selected. Radio amateurs often enclose IRCs when QSLing DX stations directly to cover the cost of return postage. Volodymyr Taran, a graphic artist from Ukraine, submitted the new design, known as "Beijing Model No. 2". Chosen by a jury of 40 UPU member countries, the coupon design was inspired by Michelangelo's painting on the ceiling of the Sistine Chapel – two fingers about to touch framed in a postage stamp, representing the notions of communication and exchange. The new IRC will be valid until December 31, 2009. The current IRC is valid to December 31, 2006.

(ARRL N/L)



# World Radiosport Team Championship 2005

## Canadian team takes WRTC-2006 Gold - "Phantom QSOs" Mystery Clouds Event

Canadians John Sluymmer VE3EJ and Jim Roberts VE7ZO (ex-VE3IY) officially topped the 46-team field at World Radiosport Team Championship 2006 (WRTC-2006) in Brazil <http://www.wrtc2006.org> July 8-9.

As PT5M they logged nearly 2.44 million points to take home the gold. US teams took the second and third positions for silver and bronze medals, respectively. But the appearance in one log of a large number of what officials are calling "phantom QSOs" took another team out of medal contention.

Earning the silver medal was the US-West team of Californians Dan Craig N6MJ and Dave Mueller N2NL, with nearly 2.32 million points from PW5C.

The national special invited team of Doug Grant K1DG and Andy Blank N2NT – operating as PT5Y – landed in third place with almost 2.1 million points. They had been in fourth place in the preliminary "Scoreboard" results as the event ended at July 9 at 1200 UTC. The final five changed, however, once WRTC-2006 officials reviewed all logs.

Preliminary Scoreboard numbers had the Serbia-Montenegro team of Ranko Boca YT6A and Djurica Maletin YT6T – operating as PT5L – scrambling from 11th to third place in the final hour of the event. When the smoke cleared, however, they ended in 11th place.

In a statement <http://www.wrtc2006.com/release59.html> July 14, WRTC-2006 officials explained that the PT5L log contained an unusually high number of

"uniques" – call signs that appeared rarely or not at all in the logs of more than 1000 IARU contest participants or of other WRTC-2006 competitors. The officials said recorded audio from PT5L confirmed that the QSOs had in fact taken place.

"It appeared to the judges, from listening to the recording while examining annotated log extracts identifying the 'uniques,' that there was a small number of stations, probably more than one, feeding 'phantom QSOs' to PT5L," the WRTC-2006 statement said.

Signing the statement in addition to Atilano de Oms PY5EG, as WRTC-2006 steering committee chair, were judges David Sumner K1ZZ and Roger Western G3SXW, and Log-Checking Committee members Larry "Tree" Tyree N6TR and Phil Goetz N6ZZ.

As a result, the judges and log-checking committee decided to reduce the threshold for determining a unique QSO to a relatively small number of logs and to delete all uniques from the logs of all 46 competing teams.

While most teams lost about 15 QSOs, the action resulted in the deletion of 240 contacts – nearly all "manufactured" at the other end – from the PT5L log and the loss of the bronze medal.

The five WRTC-2006 officials said it appears most likely that the "phantom QSOs" were intended to sabotage either one or both of the PT5L operators specifically or a randomly selected WRTC station.

"Such behaviour, by amateur operators

outside the WRTC event itself, is both reprehensible and illegal and deserves to be thoroughly investigated," the officials said. "However, doing so within the time frame of the WRTC event was impossible."

Taking the fourth spot with some 2.02 million points was the Ukrainian team of Yuri Onipko UT4UZ and Dimitry Stashuk UT5UGR, who competed as PW5X. They had showed up in fifth place in the preliminary standings. Rounding out the top five was the PT5D team of Stefano Brioschi IK2QEI and Stefano Galli IK2JUB, of Italy. They racked up nearly 1.99 million points.

These special awards were also presented: PW5U (XE1KK/XE1NTT) for the most CW QSO points among stations with at least 35 percent SSB QSOs; PT5N (9A8A/9A5K) for the most SSB QSO points; PW5K (ES5TV/ES2RR) for the most accurate log among the top 20 finisher, and PW5G (IZ3EYZ/9A1UN) for the top score among Bi-National Young Team participants.

WRTC-2006 selected 47 teams to take part, but only 46 competed because the Czech Republic team of OK1FUA and OK2RZ was unable to get to Brazil because of an airline service suspension. Citing other commitments, three-time WRTC winners Dan Street K1TO and Jeff Steinman N5TJ did not participate in this year's event in Brazil.

(ARRL N/L July 14/06)

ar

## Sharpen up your contesting skills, there are some big local contests coming

<b>Remembrance Day</b>	<b>12-13 August.</b>	<b>Let's get a record log list</b>
<b>ALARA</b>	<b>26 August.</b>	<b>Ladies' choice</b>
<b>Westlakes Cup</b>	<b>23 September</b>	<b>New contest, ideal Foundation starter</b>
<b>RAOTC 30th Anniversary</b>	<b>21 October</b>	<b>Open all ages</b>

# Hamads classifieds **FREE**

## FOR SALE NSW

Two Philips FM900, one converted, one as rec'd, pair \$175. Outback OBS8 split antenna with heavy duty spring mount \$275. Mobile One 2m/70cm Hamtenna, one new \$15, one s/h \$5. Cliff VK2CJL 02 6972 3788

ICOM 751A HF transceiver \$1500. Kenwood PS30 13.8V 20A DC power supply o/v protect \$225. Yaesu FT 227R transceiver \$125. ICOM AH2 all band ATU \$425. Spirit Viper 33,600 bps tel/fax modem \$115. All with manuals, all VGC, all ONO. Art Stowar VK2AS 02 0072 3540

Broadcast and Satellite Equipment. We are selling all the following equipment plus many other small items. 3.8m satellite dish \$150. 2.4m satellite dish \$25 Dual polarity Low noise amps [Ku and C band] \$30. Feed horns Ku from \$35. Satellite Receivers From \$25. Tandberg satellite Rx. \$550. VHF/UHF linear Amps From \$50. CATV - MATV mods. Channel Amp \$25. Bmac Encoder/Decoders \$50 ea. Spectrum Analyser [AVCOM] 10MHz-4Ghz \$350. SSB HF 100W Trans. Rx. \$250. PS for above [25A] \$250. Satellite Phone Inmarsat mini M \$250. Satellite Phone Inmarsat B [64k] \$450 ICOM HF Rx. R71A \$250. TV Field Store FORTEL \$50. TELETEX decoder \$50. TV translator Ch 6 to Ch 12 25 watt \$10. AM radio transmitter 400W solid state 1.4 MHz \$2000. 27 MHz direction finder [accurate] \$100. MPEG 2 Encoder/MUX/Encoder MCPC offers. RF output transistors and parts etc offers. UHF CB Yagi \$75. Many other cables and parts. Please ask for John 0428 287 930 02 9652 1269 Location Glenorie NSW VK2YTX

## FOR SALE VIC

Free: Old AWA 10 W FM mobile service base station, complete except for crystals. Unlikely to be suitable for on-air conversion, but has a multitude of good parts. Free to the first

person able to collect. Bill Adams VK3ZWO ph 03 9598 6304.

Receiver BC-348R., original condition, no mods and own dynamotor \$360. BC224D, the 12 V version of the BC-348. This one a bit rare as it omits the 200 - 500 kHz band and made by RCA. Original condx with own dynamotor \$390. Plug PL-P103 for the rear connector of the BC-348 new in box \$50. HF transceiver ARC-38 (not xtallised version) and ARC-38A. Each of these xcvs have their own dynamotor, control box. \$220 for each. Control box 313V-1, mounting rack and cable for the HF transceiver 618 T \$160. VHF receiver aircraft band R 502 made by ARC complete with tuning cable, control head and dynamotor \$160. VHF aircraft transceiver Marconi TR1934 complete with plugs and control box \$60. 2 only BC- 1206 range receivers...\$60 each. AN-ARC 49 VHF tx/rx combination -no control box /dynamotors 2 available \$50. Hewlett Packard #5061A caesium Beam Frequency standard. This instrument is faulty in that the caesium resonator is probably U/S. The internals and xtal standards are operable as is the Patek Philippe timer clock -- best offers for each. 3 available. All items do not include freight. Reply to Pete Williams VK3IZ 03 5156 2053 or jupete@bigpond.net.au

## WANTED VIC

Service/maintenance manual for Wavetek model FG5000A function generator. All copy costs refunded. Drew VK3XU ph 03 9722 1620 or QTHR.

Parts for military radio: I am looking for the parts to restore and complete my AN/TRC24 radio system. I am looking for the following:- Transmitter, T-302/TRC power supply, PP-685/TRC. Receiver, R-417/TRC. "A" Band tuner, AM-1180/GRC. amplifier/converter, AM-2537/TRA-25. And any other bits and pieces or books/manuals for this radio. John Eggington,

VK3EGG. Email johne@telapacific.com.au Mobile 0409 234 672, Ph 03 9819 9065

## FOR SALE QLD

Two (2) solid state HF wide band linear amps. 100 watt, in good cond'n and in going order. VK4DV QTHR or email vk4dv@yahoo.com.au

Super QTH. VK4UA views over Gold Coast 1 acre elevated. Near new Nally 3 section winch tower to 75 feet with 3B,6el HF beams tilt over. Luxury 4BR BV, 2 big car garage 320m. 2 of 9x6 metal sheds, own water and sewer \$690K or with extra 7.4 acres (31 prestige blocks) \$2.8M OBO. Now for the gear. HAL/CRFR SR150 5B 100W transceiver \$180, PSU \$70, Star 700A RX 10B \$140, Heathkit HX20TX 60W 5B \$90, BC348J with selectable 85kC 2nd IF \$190 PSU \$50 Diawa 700A rotator and control \$200. XTAL 9 MHz filter in can with three Xtals \$40, valves metal and miniature 25¢ each many parts 100s of magazines free. All items SSB with handbooks at Pimpama 07 5546 7041

## WANTED QLD

Emtron DX-1 linear amp in good condition and no mods. Model with the meters preferable. VK4DV QTHR email vk4dv@yahoo.com.au

## FOR SALE SA

Large variety of new TV valves. Any offers. Lorraine VK5LM 08 8527 2151.

VK5JST Antenna Analyser kits. [see AR article May 2006] For details see www.scarc.org.au For mail SCARC PO Box 333 Morphett Vale SA 5162, or email: kits@scarc.org.au

## WANTED SA

De-soldering station in good working condition. VK5ZE QTHR, phone 08 8255 7586

# About hamads....

- Submit by email (preferred) or on the form on the reverse of your current Amateur Radio address flysheet. Please print carefully and clearly, use upper AND lower case.
- Separate forms for For Sale and Wanted items. Please include name, address STD telephone number and WIA membership number if you do not use the flysheet.
- Deceased estates Hamads will be published in full, even if the ad is not fully radio equipment.
- WIA policy recommends that the serial number of all equipment for sale should be included.
- QTHR means the address is correct in the current WIA Call Book.
- Ordinary Hamads from those who are deemed to be in general electronics retail and wholesale distributive trades should be certified as referring only to private articles not being re-sold for merchandising purposes.
- Commercial advertising on these pages Contact Newsletters Unlimited.
- Copy typed or printed clearly please, and received by the deadlines shown on page 1 of each issue of Amateur Radio.

Email: [newunltd@bigpond.net.au](mailto:newunltd@bigpond.net.au)

Postal: Newsletters Unlimited, PO Box 431, Monbulk Vic 3793. Fax: 03 9756 7031

### TRADE PRACTICES ACT

It is impossible for us to ensure that the advertisements submitted for publication comply with the Trade Practices Act 1974. Therefore, advertisers and advertising agents will appreciate the absolute need for themselves to ensure that the provisions of the Act are strictly complied with.

### VICTORIAN CONSUMER AFFAIRS ACT

All advertisers are advised that advertisements containing only a PO Box number as the address cannot be accepted without the addition of the business address of the box-holder or seller of the goods.

## THE WIA QSL COLLECTION REQUIRES QSLs

All types welcome, especially rare DX pictorial cards, special issue. Please contact the Hon Curator, Ken Matchett VK3TL, 4 Sunrise Hill Road, Montrose Vic 3765, tel. (03) 9728 5350

## ADVERTISERS INDEX

AEI.....	21
Amateur Radio Bookshop .....	20
Andrews .....	16
Com-an-tena.....	19
Fast Electrics .....	29
TET-Emtron .....	15
G & C.....	8
Icom .....	OBC
KVK.....	27
Ozgaar .....	49
Rippletech .....	29
Truscotts .....	27
TTS.....	9
Small ads.....	55
ARI .....	18
Westlakes .....	39
White.....	18
Winlink.....	29



## VKHAM.COM

AUSTRALIAN AMATEUR RADIO

Hundreds of pages and links related to Amateur Radio and radio in general

Home of:

- VK Classifieds
- VK Auctions
- VK's on the Internet

Repeater Maps, Software, Prefix Maps and more ...

## HF, VHF, UHF ANTENNAS & ACCESSORIES

Aluminium towers, guys etc

Diamond VSWR/PWR meters.

HD copper antenna wire & insulators, TX tubes & pwr transistors, full range Create Rotators

Quality coax cables & connectors. Free advice & catalogue.

**ATN Antennas**

Ph 03 5492 2224 Fax 03 5492 2666,

email [atnant@iinet.net.au](mailto:atnant@iinet.net.au)

PO Box 80, Birchip Vic 3483

## AMIDON FERROMAGNETIC CORES

For all RF/electronic applications.

See our website for complete specs and prices  
[www.catchnet.com.au/~rjandusimports](http://www.catchnet.com.au/~rjandusimports)

**RJ & US Imports**

PO Box 431, Kiama NSW 2533.

A 3.5" PC disk containing all data is available for \$5.00 incl. post.

Agencies

Active Electronics, Tas

TTS Systems, Tyabb (VIC)

MiniKits

Tower Communications, Perth

OzGear, Brisbane

## RM Products Italy

are now available in Australia after the appointment of

Hamak Electrical Industries Pty Ltd  
as distributor for RM products

Visit the Hamak website at

[Hamak.com.au](http://Hamak.com.au) for

**Linear amplifiers,  
Power supplies  
and accessories**



## JACKSON BROS

JACKSON OF THE UK IS BACK

Highest quality products made by UK craftsmen

[www.jacksonbrothers.com.au](http://www.jacksonbrothers.com.au)

Full range now off-the-shelf in Australia.

Variable and trimmer capacitors, reduction drives, dials, ceramic standoffs

CATALOGUES, PRICE LISTS AVAILABLE

CHARLES I COOKSON PTY LTD

11-13 Port Rd

Queenstown SA 5014

Tel: (08) 8240 3200 Fax: (08) 8240 3233

FreeFax 1800 673355 within Australia

Email: [sales@jacksonbrothers.com.au](mailto:sales@jacksonbrothers.com.au)

com.au

ALL MAJOR CREDIT CARDS ACCEPTED  
SOLE AGENTS AUSTRALIA AND NEW ZEALAND

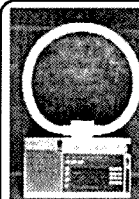

## Tunable Loop Antenna enhances AM

### Reception

AM radio reception (530 to 1900KHz) enhanced. Reception where none existed before: works indoors, even in interference-polluted areas  
High value — low cost.

Simple, no connections or batteries

Ideal for touring, caravan, boat and fringe areas. Use anywhere.

[www.amradioantennas.com](http://www.amradioantennas.com)

[pkloops@bigpond.net.au](mailto:pkloops@bigpond.net.au)

Paul 0412 302 939

**PK's Loop Antennas**

## Become a radio amateur

Check out the courses on offer from Australia's premier training institution for radio amateurs and hobbyists.

### Already licenced?

Upgrade to the Standard licence using our self paced multi-media CD ROM course. The easiest way to become a licensed radio experimenter.

Discover digital communications, get more power and more bands

### Still want more?

Be guided by one of our experienced facilitators using our proven on-line study methods and get your Advanced licence.

### Visit

<http://www.radioelectronicschool.com>

for more information,

or email the course manager at

[info@radioelectronicschool.net](mailto:info@radioelectronicschool.net)

Telephone 07-5573-2795 12-5PM AEST

Amateur radio – a bridge to careers in radio communications technology

## Are you managing the estate of a 'Silent key'?

Please save any QSLs for the National QSL collection, but first contact:

The Hon. Curator,

Ken Matchett VK3TL

on (03) 9728 5350

or email: [jeandawson@iinet.net.au](mailto:jeandawson@iinet.net.au)

Rare DX, special call-signs prefixes and suffixes, pictorials and pre-war QSLs are needed.

*Let us save something for the history of amateur radio.*

## VIDEOEMAIL

Also Live Video Messenger and Conferencing for Teaching, Talks and Tutorials.

Do away with websites.

Brand your Videoemail and watch your business skyrocket.

Put video on your eBay ads.

FREE 30 day trial

Email to: [arecibo@bigpond.com](mailto:arecibo@bigpond.com)



# Directory

## The Amateur Service:

a radio communications service for the purpose of self training, intercommunication and technical investigation carried out by amateurs, that is, by duly authorised persons interested in radio technique with a personal aim and without any pecuniary interest. 1.56 ITU Radio Regulations.

*The Wireless Institute of Australia represents the interests of all amateurs throughout Australia.*

The WIA offers one year and 5 year membership for all categories except Concession Student. The fees for each category are: Full members \$75 (\$365), Overseas members \$85 (\$403), Concession members (pensioner) \$70 (\$332), Concession members (student) \$70, Full members no magazine \$50 (\$237), Family members \$40 (\$190)

### National Office

10/229 Balaclava Road,  
Caulfield North VIC 3161,  
PO Box 2175  
Caulfield Junction Vic 3161  
Australia

### Contact

Phone 03 9528 5962,  
Fax 03 9523 8191,  
10am to 4pm daily,  
nationaloffice@wia.org.au  
http://www.wia.org.au

### News Bulletin Schedule

Subject to change. See [www.wia.org.au](http://www.wia.org.au) follow National News prompts.  
Contact [nationalnews@wia.org.au](mailto:nationalnews@wia.org.au)  
National VK1WIA news is distributed to all states.

### Advisory Committees

#### VK1 Australian Capital Territory

VK1WX Alan Hawes  
VK1ZPL Phil Longworth  
VK1ET John Woolner  
VK1GH Gil Hughes

### Contact

[vk1advisory@wia.org.au](mailto:vk1advisory@wia.org.au)

### News Bulletin Schedule

Sundays at 11.00 am  
VK1WIA 7.128, 146.950, 438.050  
Canberra Region Amateur Radio Club Email newsletter will be sent on request to [president@vk1.ampr.org](mailto:president@vk1.ampr.org)

#### VK2 New South Wales

VK2QV Chris Flak  
VK2XCD Chris Devery  
VK2BFN Adrian Clout

Phone 02 9689 2417  
[vk2wi@ozemail.com.au](mailto:vk2wi@ozemail.com.au)  
[vk2advisory@wia.org.au](mailto:vk2advisory@wia.org.au)

VK2WI - Sunday 1000 and 1930 hours local. 1.845; 3.595; 7.146; 10.125; 14.170; 28.320, 52.525; 145.600; 147.000; 438.525; 1273.500 megahertz. Plus regional relays.  
VK1WIA news included in the morning

#### VK3 Victoria

VK3JJB John Brown  
VK3PC Jim Linton  
VK3APO Peter Mill

Phone 03 9885 9261  
[arv@amateurradio.com.au](mailto:arv@amateurradio.com.au)

VK1WIA, Sunday 11am and 8pm, 3.615 and 7.085 (LSB), 10.130 (USB),  
VK3RML 146.700, VK3RMM 147.250, VK3RMU 438.075.

#### VK4 Queensland

VK4BY Don Wilchefski  
VK4ZZ Gavin Reibelt  
VK4KF Ken Fuller

[vk4advisory@wia.org.au](mailto:vk4advisory@wia.org.au)

VK1WIA, Sunday 9.0am via HF and major VHF/UHF rpters

#### VK5 South Australia and Northern Territory

VK5OV David Box  
VK5APR Peter Reichelt  
VK5ATQ Trevor Quick

Phone 08 8294 2992  
[boxesdnm@lm.net.au](mailto:boxesdnm@lm.net.au)  
[peter.reichelt@bigpond.com](mailto:peter.reichelt@bigpond.com)  
[vk5advisory@wia.org.au](mailto:vk5advisory@wia.org.au)

VK5 South Australia  
VK5WI: 0900 am local time. 1.843 LSB, 3.550 LSB, 7.095 LSB, 28.470 USB, 53.1 AM, 147.000 FM Adelaide, 146.800 FM Mildura, 146.900 FM South East, 146.925 FM Central North, 439.975 FM Adelaide North.  
VK8 Northern Territory  
0900 local time 3.555 LSB, 7.050 LSB, 10.130 USB, 146.900 FM.

#### VK6 Western Australia

VK6NE Neil Penfold  
VK6XV Roy Watkins  
VK6OO Bruce Hedland-Thomas

Phone 08 9351 8873  
<http://www.vk6.net/>  
[vk6advisory@wia.org.au](mailto:vk6advisory@wia.org.au)  
[vk6ne@upnaway.com](mailto:vk6ne@upnaway.com)  
[vk6xv@bigpond.net.au](mailto:vk6xv@bigpond.net.au)

VK6WIA: 146.700 FM(R) Perth at 0930hrs Sunday relayed on 1.865, 3.564, 7.075, 10.125, 14.116, 14.175, 21.185, 29.120 FM, 50.150 and 438.525 MHz, Country relays 3.582, 147.200 (R) Cataby, 147.350 (R) Busselton, 146.900 (R) Mt William (Bunbury), 147.000 (R) Katanning and 147.250 (R) Mt Saddleback. Broadcast repeated on 146.700 at 1900 hrs Sunday relayed on 1.865, 3.564 and 438.525 MHz : country relays on 146.900, 147.000, 147.200, 147.250 and 147.350 MHz..Also in "Realaudio" format from the VK6 WIA website

#### VK7 Tasmania

VK7ZAX Phil Corby  
VK7DG Dale Barnes  
VK7KK Reg Emmett

Phone 03 6234 3553  
[vk7advisory@wia.org.au](mailto:vk7advisory@wia.org.au)  
[phil.corby@tassie.net.au](mailto:phil.corby@tassie.net.au)  
[vk7dg@wia.org.au](mailto:vk7dg@wia.org.au)  
[regemm@ozemail.com.au](mailto:regemm@ozemail.com.au)

VK1WIA Sunday 9am on VK7WI network: 3.570MHz LSB, 146.700 MHz FM (VK7RHT South), 53.825MHz FM (VK7RAD South), 147.000MHz FM (VK7RAA North), 146.750 FM & 53.825MHz (VK7RNW North West), 146.625 MHz FM (VK7RMD North West), UHF CB Channel 15 (Hobart) and 27MHz CB - 27.225MHz LSB (Hobart). Followed at 9:30am with VK7 Regional News Broadcast also on 7.090MHz LSB & 14.130MHz USB

### Notes

1. Only three members of the state advisory committees are listed.
2. All listings are preliminary. They will be updated each month as required.
3. Membership application forms are available from the WIA web site [www.wia.org.au](http://www.wia.org.au) or the national office address above.

# MARCONI CENTENARY *Celebration*

*The Centenary of the first overseas wireless transmission from the Australian mainland – July 12th 1906*

## *From Devonport*

What a day it was! July 12th 2006, 100 years since Marconi's wireless conquered Bass Strait and made the first wireless crossing of open water in the Southern Hemisphere and we celebrated with our Geelong friends a wonderful century of electronic progress.

The day started at 4.20 am to open the Devonport Maritime Museum for the ABC morning presenters, who did a fantastic job featuring Amateur Radio and the Marconi celebrations from 5.30 am to 7.45 am.

Our State Governor, His Excellency the Hon. William Cox (pictured below) arrived and we awaited the call from Victoria starting the exchange of messages. Both Governors spoke, then the parliamentarians present talked to each other, Victoria sending greetings to their little neighbour and Tasmania responding reminding them that Tasmanians founded Melbourne.

In a chat with Peter Turrell, the chairman of the Marconi Veterans Association in Chelmsford, England, he mentioned that Princess Elettra Marconi, the daughter of Guglielmo Marconi, was in England for the Ascot Races.

A phone call to Italy and we had a scoop! A 3-minute message in which she intimated that if she had known she would have come out to be with us. We had not known that she was still alive!

*(See full report and transcript of Princess Elettra Marconi's recorded speech inside)*



**Across Bass Strait to Point Lonsdale**  
*(inside front cover)*



# ICOM's price break through

## most affordable prices ever



### IC-7000

HF/VHF/UHF All mode Transceiver • 100W HF/50MHz, 50W/2m, 35W/70cm • I.F DSP for improved noise rejection • Digital IF filter for Dial up selectivity • 2.5" TFT colour display for bright easy reading • Remote control DTMF Mic for fingertip control & IRLP access PLUS • digital voice storage • 2 mode band scope • Multi function meter 7 SWR display • Built in RTTY modulator



### IC-756PRO III

HF\*6m • Sharp & soft IF filter shape • New receiver gives +30dBm third-order intercept point • One-touch record/play • Digital voice memory • Extended 1/4 Tuning step & BPF functions for SSB-D mode • 32-bit floating-point DSP and 24-bit AD/DA converter • SSB/CW synchronous tuning • 5-inch color TFT LCD • Built-in antenna tuner • Customisable filter shape • No optional filters to buy

Amateur



### IC-7800

HF\*6m • Four 32-bit floating point DSP units • +40dBm ultra high intercept point • Automatic tracking pre-selector • Two completely independent receiver circuits • 200W output power at full duty • Ultra high frequency stability • 7-inch wide color TFT LCD • Multi function spectrum scope • RTTY / PSK31 operation without PC connection • Professional 6m receiver • Digital Voice Recorder • CF memory card.



### IC-2200H

• VHigh (65W) Power Output • DTCS & CTCSS Tone Squelch • DTMF Encode & Decode (with optional UT108) • Digital Voice & Data Communication (with optional UT118) • 207 Alphanumeric Memories

NEW

### IC-P7A

VHF/UHF (2m/70cm) Dual-band FM Handheld Transceiver • Ultra compact body, light weight 47x81x28mm, 160g • Mini-power VHF/UHF dual bander with wideband receiver 0.495-999.990MHz • 1800mAh large capacity Li-Ion battery allows 20hours operating time (Tx:Rx:Standby=5:5:90) • 1.5W output power on 2m & 1W output power on 70cm • Simple operation • 1000 memory channels with flexible memory bank system • Oversize LCD for clear display of function information

### IC-T90A

A new 5W Triband handheld • VHF/UHF FM 2M, 6M, & 70CM Wideband receive 495KHz - 1GHz 555 Alphanumeric memories • 13 Scan modes DTCS & CTCSS encode & decode DTMF encoder (10 memories) Wide/narrow transmit capability.



# ICOM

ICOM 84

Call your local ICOM dealer [www.icom.net.au](http://www.icom.net.au) or (03) 9549 7500

The magazine for **AUSTRALIAN** radio amateurs

Volume 74 no 9  
September 2006

# Amateur Radio



\$7.00  
incl GST



**Amateur radio  
in action**

**The Briar Hill  
ARRISS  
project**

**Magneto-ionic holes:  
is your antenna coupling well into  
the ionosphere?**

**Let your hand-held lead  
you to adventure!**

**You CAN work DX from  
apartments!**



**COMING SOON!**

**2007**

**WIA Callbook**

*All Australian Callsigns*

**Plus great detail about:**

Amateur Radio Clubs, WICEN, ALARA, AMSAT, ARDF,  
Band Plans, Beacons, the ACMA, Examinations, QSLs,  
Great Circles, Maidenhead, DXCC, Packet Radio,  
Repeaters *and more.*

**All Foundation Licence callsigns**

**NEW  
features**

**BONUS** on disc:

**NZ callsigns**

**"HamStuff" shareware**

**~a great link between amateur radio and  
computer**

*How to get your copy:*

**Contact your local Amateur Radio Club**

**or WIA National Office**

**03 9528 5962 [nationaloffice@wia.org.au](mailto:nationaloffice@wia.org.au)**

*Club secretaries pre-order NOW*



# Amateur Radio

Volume 74, Number 9  
September 2006

The Journal of the Wireless  
Institute of Australia  
ISSN 0002-6859

## GENERAL

Amateur Radio Remembrance Day Contest 2006 Opening Speech.....	5
Horrie Young VK2AMZ	
The secret spectrum - clandestine broadcasting.....	10
Dr Hank Prunckun, VK5JAZ	
Aussie kids chat with the space station .....	16
North East Radio Group	
Aircraft enhancement. A project beginning almost 50 years ago.....	22
Don Heberecht VK2RS	
You can work DX from apartments!.....	24
Ira Lipton WA2OAX	
Marconi centenary celebration hailed a great success .....	25
Ron Churcher VK7RN	
Adventures with a hand-held .....	26
Rob McKnight VK2MT	
Lightning. Effects of a near strike.....	29
Guy Fletcher VK2KU	

## TECHNICAL

6 metre propagation.....	6
Mick Hort VK2BZE	
The Slim Jim revisited .....	7
Bill Sinclair VK2ZCV	
A scalable solar regulator.....	12
Dale Hughes VK2DSH	
Magneto-ionic holes: Is your antenna coupling well into the ionosphere?.....	19
Robert R Brown NM7M	

## COLUMNS

ALARA .....	36	News from.....	32
AMSAT .....	51	VK7 .....	32
Beyond our shores.....	38	VK3 .....	33
Contests .....	41	VK2 .....	35
Directory.....	56	VK5 .....	35
DX – News & Views .....	45	Over to You .....	15
Editorial comment.....	2	Silent Keys .....	11, 33, 37, 46
Gridsquare Standings.....	40	Spotlight on SWLing .....	39
Hamads .....	54	VHF/UHF – an expanding world .....	47
		WIA comment.....	3
		WIA News .....	4

## Our Cover this month

Two of the Briar Hill Primary School School students and their teacher Natalie Will show their obvious delight at the success of the ARISS contact with astronaut Bill McArthur NA1SS on the International Space Station. Kitty Nguyen is holding the microphone. Unfortunately, the correspondent did not identify the student in the background. See the story starting on page 16.

## Editorial

Editor: Peter Freeman VK3KAI  
editor-armag@wia.org.au

Technical Editor: Peter Gibson VK3AZL

Publications Committee Members  
Brenda Edmonds VK3KT  
Ron Fisher VK3OM  
Evan Jarman VK3ANI  
Tom Potter VK3UBS  
Bill Roper VK3BR  
Ernie Walls VK3FM

## All circulation matters

nationaloffice@wia.org.au

## How to submit material

### General and Technical articles Secretary

AR Publications Committee  
PO Box 2175,  
Caulfield Junction Vic 3161  
or armag@wia.org.au

### Columns and letters to Editor

Editor  
AR Magazine  
PO Box 273  
Churchill, Vic 3842  
or editor-armag@wia.org.au

## Hamads

"Hamads" Newsletters Unlimited  
PO Box 431  
Monbulk VIC 3793  
Fax 03 9756 7031  
newunltd@bigpond.net.au

## Advertising

All enquiries to  
Newsletters Unlimited  
PO Box 431  
Monbulk Vic 3793  
Phone: 03 9756 7797  
Fax: 03 9756 7031  
newunltd@bigpond.net.au

## Registered Office

10/229 Balaclava Road,  
Caulfield North VIC 3161  
Australia  
Phone: 03 9528 5962  
Fax: 03 9523 8191

## Production Deadlines

General articles, columns and  
advertising booking 10th day of  
previous month.

Hamads and advertising material 15th  
day of previous month

The contents of Amateur Radio are Copyright  
Wireless Institute of Australia © 2006

## Contributions to Amateur Radio

Amateur Radio is a forum for WIA members' amateur radio experiments, experiences opinions and news. Manuscripts with drawings and/or photos are always welcome and will be considered for publication. Articles on disc or email are especially welcome. The WIA cannot be responsible for loss or damage to any material. A pamphlet, 'How to write for Amateur Radio' is available from the National Office on receipt of a stamped self-addressed envelope.

## Back Issues

Back issues are available directly from the WIA National

Office (until stocks are exhausted), at \$4.00 each (including postage within Australia) to members.

## Photostat copies

When back issues are no longer available, photocopies of articles are available to members at \$2.50 each (plus an additional \$2 for each additional issue in which the article appears).

## Disclaimer

The opinions expressed in this publication do not necessarily reflect the official view of the WIA and the WIA cannot be held responsible for incorrect information published.

## Amateur Radio Service

A radiocommunication service for the purpose of self-training, intercommunication and technical investigation carried out by amateurs; that is, by duly authorised persons interested in radio technique solely with a personal aim and without pecuniary interest.

## Wireless Institute of Australia

The world's first and oldest National Radio Society  
Founded 1910

Representing

The Australian Amateur Radio Service

Member of the  
International Amateur Radio Union

Registered Office of the WIA

10/229 Balaclava Road, Caulfield North Vic 3161

Tel: (03) 9528 5962 Fax (03) 9523 8191

email: nationaloffice@wia.org.au

http://www.wia.org.au

All mail to

PO Box 2175 Caulfield Junction VIC 3161

Business hours: 10am – 4pm weekdays

### National Office staff

Margaret Webb Administrator  
Dianne Ashton Examination Officer  
Brenda Edmonds Office Volunteer

### Board of Directors

President Michael Owen VK3KI  
Vice-President Ewan McLeod VK4ERM  
Robert Broomhead VK3KRB  
Glenn Dunstan VK4DU  
Trevor Quick VK5ATQ  
Robyn Edwards VK6XRE  
Phil Wait VK2DKN  
Secretary t b a  
Treasurer Bruce Bathols VK3UV

### Coordinators

AMSAT Graham Ratcliff VK5AGR  
ARDF Jack Bramham VK3WWW  
Australian ARISS Tony Hutchison VK5ZAI  
Awards Mal Johnson VK6LC  
Club Coordinator Ted Thrift VK2ARA  
Contests Ian Godsell VK3JS  
John Moyle Memorial  
Field Day Manager Denis Johnstone VK3ZUX  
Editor 'AR' Peter Freeman VK3KAI  
EMC/EMR Gilbert Hughes VK1GH  
Keith Malcolm VK1ZKM  
Standards Gilbert Hughes VK1GH  
David Wardlaw VK3ADW  
John Bishop VK2ZOI  
NTAC John Martin VK3KWA  
Historian Will McGhie VK6UU.  
IARU Region 3  
Liaison Officer Michael Owen VK3KI  
Intruder Watch Glenn Dunstan VK4DU  
International  
Travel Host John Miller VK3DJM  
ITU Conference &  
study group Gilbert Hughes VK1GH  
David Wardlaw VK3ADW  
Keith Malcolm VK1ZKM  
Ken Matchett VK3TL  
QSL Curator  
QSL Bureau Coordinator &  
VK9/0 QSL Manager Neil Penfold VK6NE  
Repeater Coordinator Peter Mill VK3ZPP  
Webpage co-ordinator Colin Thompson VK2TRC  
WICEN Ewan McLeod VK4ERM

# Editorial comment

Peter Freeman VK3KAI

## How time flies!

It seems that it was only a few days ago that I sat down to write the Editorial for the August issue – where have the last four weeks gone? The August issue was undergoing preparation in the days immediately following the weekend of the GippsTech conference. Most of those interested in VHF/UHF and microwave communications will be aware of the annual Gippsland Technical Conference (GippsTech), held in early July each year at the Gippsland Campus of Monash University in Churchill. This event is hosted by the Eastern Zone Amateur Radio Club Inc. I have a key role in this event – I am the Conference Chair (it was my idea to hold the first conference, back in 1998). A couple of hectic last weeks led to an extremely busy weekend for the conference, then finalising the August issue. Work then imposed another busy time, anticipated but always tiring.

## Project progress?

The net result has been very little time to devote to the long list of projects that sit on the “to do” list. There has been little time spent “on-air”, although some of the time at the computer has been spent with the radios running in the background. Have you managed to move some of those projects off the “to do” list, even if only along to “currently refining”?

We have some regular contributors of technical articles, as well as those that coordinate the monthly columns. These individuals keep this journal going, with both news and new ideas and reflections on implementation of ideas. This helps to stimulate most of us to consider just how we might improve our own station.

I urge you all to consider writing up your most recent project and submitting it to this journal for publication. The lead time for publication is reducing. Many may consider that this is a good thing – if I write an article, it will appear in print sooner. The flip side needs to be considered: a shorter time between submission and publication means that the list of available articles must be growing smaller!

I have received several comments complementing me on this journal. I accept those comments, but must point out that the praise must really rest with those of you who submit articles for

publication. As Editor, I can only work with the material that I have available. If I only have several articles about operating experiences, then that will be reflected in the journal contents. On the other hand, if the pool of available articles is entirely made up of HF antenna articles, then I can only publish such articles. To achieve a reasonable balance in this journal (magazine), I need to be able to select across a variety of topic areas. Given the diversity of our hobby, I hope that you all agree that we need to have a spread of topics in each issue. The result should be that most readers should find something stimulating and/or interesting, sparking that desire to consider a positive improvement in station components or layout, antennae in use, exploring a new mode of operation, or simply making the time to turn the radio on and making some on-air QSOs.

I must also remind you of the need to have a spread of material across different technical levels – we must have material that has appeal to the “old hands” as well as the “new chums”.

## This month's reading and next month's activity.

In this issue, we see several smaller articles covering a variety of topics, both of general interest and of a technical nature. In my attempts to publish articles predominantly in order of receipt, that was how the articles fell. It is good to have articles of differing lengths – it allows for greater flexibility in selecting content. I hope that you find the reading stimulating.

On the inside back cover, we can see an example of how we, as a hobby, are being portrayed to an outside group – in this case to Scouts. It reminds us of an annual opportunity to promote our hobby to many of the youth in our community: Jamboree On The Air (JOTA), and the recently added Jamboree On The Internet (JOTI), has a long history with Amateur Radio. I encourage you to consider being involved – I am sure that there will be a Scout or Guide group nearby that would appreciate the chance to be involved, if they were aware of opportunities that you might be able to provide.

73 – Peter VK3KAI



# The 13th IARU Region 3 Conference

The 13th IARU Region 3 Conference was held in Bangalore, India from 7 to 10 August 2006.

The IARU (the International Amateur Radio Union) was described in WIA Comment published last July in *Amateur Radio*. A little of its history was set out, and the importance of its role presenting a global position for the amateur service, particularly within the ITU framework, was described.

The Regional organisations were referred to and their participation in the Administrative Council of the IARU, the body that determines IARU policy. The Regional organisations also conduct Conferences every three years, are responsible for representing the amateur service to their regional organisations (the APT in Region 3), and to an extent are the link between the member societies and the IARU.

There are today 30 member societies of IARU Region 3. Each must be a member of the IARU.

One has many members, the Japan Amateur Radio League, currently around 78,000 members.

Then there are a number of medium sized societies such as KARL (Korea) with around 8,000 members, the WIA with around 4,000 members, NZART (New Zealand) with around 2,000 members and CTARL (Chinese Taipei) with around 1,200 members.

Then there are much smaller societies, such as ARSI (India) with around 500 members, RAST (Thailand) with around 500 members, HARTS (Hong Kong) 239 members, SARTS (Singapore) with around 50 members, RSSL (Sri Lanka) around 60 members, ARM (Macau) around 60 members, BARL (Bangladesh) some 35 members, VARC (Vietnam) some 26 members, VARS (Vanuatu) some 10 members and PIARA (Pitcairn Island) with 9 members.

In addition, two of the world's most influential societies, ARRL (USA) and RSGB (UK) are members and participate for their members in the Region (for example, the USA possessions in the Pacific).

The list is not complete, but gives an idea of the geographic spread and spread

of size of the member societies. JARL is a large amateur radio society by any standard but many national amateur radio societies have around the same number of members (or indeed fewer members) than the usual local Australian radio club.

Among the clubs not mentioned above are some that are currently un-financial, often, as in the case of ORARI (Indonesia) for the very good reason that the Region's dues are expressed in US dollars, and the Indonesian currency has fallen in recent times, making the US dollar unbelievably expensive.

Therefore, the Region has a wide spread, in terms of geography and in terms of the number of amateurs in a country.

The WIA pays a fee to the Region 3 organisation, currently 71 US cents per member. At the exchange rate when this was written, that is 93 Australian cents. In other words, nearly one dollar from every member's subscription goes to Region 3.

That is only part of the cost. The cost of participating in a Regional Conference every three years may be quite high, depending on where it is held.

Why does the IARU Region 3 organisation matter to the WIA?

It is through the Regional organisations that the IARU member societies can have input to the IARU. There is no global assembly of the IARU, in which member societies may participate. Policy is developed by the IARU Administrative Council, comprised of the President, Vice President and Secretary of the IARU and two representatives of each of the three Regional organisations.

An example of the sort of policy issues that may be addressed is the possibility that at an appropriate time it may be possible to seek a secondary allocation for the amateur service around 5 MHz.

In addition to the formulation of policy, the Regional organisations undertake other activities.

Since the changes to Article 25 of the ITU Radio Regulations made by the World Radiocommunications

Conference in Geneva in 2003, the underpinning international regulation of the amateur services, a new and important emphasis on international emergency communication by the amateur service has existed.

It is through forums such as the IARU Region 3 Conference that structures and plans to address this responsibility may be developed.

It is also a forum where experiences may be exchanged.

One example is that it is clear that many societies are concerned at the diminishing number of amateurs and the need to attract new amateurs. The WIA is one of the few societies that can talk of growing numbers of amateurs and an upward trend in membership. The WIA cannot say that what has been done in Australia in the development of an entry level licence will provide a solution for any other country. However, it can share its experiences, and leave it to others to see if what has happened in this country is of any assistance to another country.

Then, of course, it is the forum where band plans are developed, and the organisation through which national societies may work together to attempt to remove intruders.

I have no doubt that the WIA's involvement in the IARU Region 3 is inescapable.

But that also means that we can say that IARU Region 3 must be effective and that it and the IARU generally must make sure that its member societies and their members know what it is doing.

Whether or not the present structure should be retained, changed or replaced, is a matter for the future. In the short run, we must make what we have work as well as we can.

In the longer run, we must ask the question is what we have now the best for the future. In addition, through the Administrative Council of the IARU and a working group appointed by it, that is a question that is already being asked.

## **13th IARU Region 3 Conference in India**

The International Amateur Radio Union Region 3 held the 13th Regional Conference from 7 to 11 August 2006 in Bangalore, India.

The Amateur Radio Society of India was the host society, and the WIA was represented by its President, Michael Owen VK3KI, and Jim Linton VK3PC.

Because of the way the work of the conference is divided into two areas, with two Working Groups working in parallel, one dealing with policy items, the other with operational and technical items, each representative is fully committed.

Jim Linton was Chairman of the Editorial Committee and a member of the Finance Committee, and Michael was Chairman of a third Working Group dealing with constitutional matters and the future of the IARU.

Thirteen IARU national member societies participated in the Conference.

The many challenges facing amateur radio and the opportunities for the future were actively discussed.

Some 70 documents were considered, covering a wide range of topics including the Foundation Licence, BPL, intruders, reciprocal and visiting licensing, new frequency allocations perhaps around 5 MHz and emergency communications.

The overriding concern of the conference was the declining numbers of radio amateurs in most countries, and how that situation may be addressed. Another key theme in the wake of a series of natural disasters was preparation by radio amateurs for their role in providing emergency communications.

The WIA paper on the Australian Foundation Licence, presented by Michael Owen, attracted strong interest from many, who asked the WIA delegates questions and commented very favourably on the WIA Foundation Licence Manual. Each delegation was presented with at least one copy.

The Conference formally resolved as follows: "That IARU Region 3 member societies take note of the introduction of the WIA Foundation licence, building on the success of the RSGB model, as a way to encourage newcomers into the Amateur Radio Service."

There is no doubt that the Australian

experience attracted real interest, as the WIA was one of the few societies talking of growing numbers of amateurs and growing membership.

The issue of emergency communications was also discussed at length. At least three radio societies announced that they were setting up their first amateur radio emergency service organisations and were aiming to prepare better for disasters.

Leading the discussion was Chairman of the IARU Region 3 Emergency Communications Committee, Jim Linton. Jim was confirmed in that position by the Conference.

The Conference resolved to encourage radio societies to have their administrations fully implement the changes to Article 25 of the ITU Radio Regulation in respect of third party traffic and preparation for emergency communications.

It also resolved to encourage the societies to participate in a regional simulated emergency test in the future to explore the potential for inter-country networking in times of emergencies.

The WIA paper on the new proposed Australian 40 metre band attracted interest as a way forward as the availability of 7.1 to 7.2 MHz spreads across the region.

The WIA's approach to the issue of BPL also attracted interest. The JARL reported that it has been working with its administration on in-house BPL to keep emissions low and requiring filters to stop them radiating from power lines. The ARRL reported a very low number of BPL consumers across the US.

Intruders on the amateur bands were of serious concern to many societies. These included over the horizon radar systems and broadcasters. The Conference resolved to escalate efforts to have them stopped.

An important matter discussed was raised by the IARU Vice President, Tim Ellam VE6SH, concerning the future of the IARU.

The Region 3 Constitution was amended, primarily to make amendment more difficult and requiring notice, as proposed by the WIA.

Four of the five current directors did not seek re-election, namely Park Young-Soon HL1IFM, K.C. Selvadurai 9V1UV, Yoshiji Sekido JJ1OEY and R. Ramachandra VU2RCR.

As there were five nominations for

the five positions, the following were declared elected:

Michael Owen VK3KI, who was also elected Chairman of Directors, Shizuo Endo JE1MUI, Gopal Madhavan VU2GMN, Peter Lake ZL2AZ and Professor Rhee-Joong Guen HL1AQQ.

Keigo Komuro JA1KAB continues as Secretary of the Region.

Keith Malcolm VK1ZKM was confirmed by the Conference as the Region 3 EMR Coordinator.

The 14th conference, in 2009, will be hosted by NZART and held in Christchurch.

## **The WIA Presents at the IIR conference - BPL in Australia**

WIA Director Phil Wait VK2DKN delivered a presentation entitled "BPL and Amateur Radio" to the IIR conference "BPL in Australia" held in Sydney on 26 and 27 July. The WIA was invited to present their concerns about the interference potential of BPL to HF radiocommunications.

The conference was attended by management level decision makers from the power and utility industries, the Department of Defence, the regulator - ACMA, ISPs, and others interested in providing access and in-house BPL services, automatic meter reading (AMR), and demand side power management such as dynamic electricity pricing and load shedding.

The WIA presentation was very well received, and has increased the awareness of amateur radio and the importance of avoiding interference to radiocommunications services, including amateur radio.

## **Growth for amateurs and for the WIA**

July was a big month for new Radio Amateurs.

The WIA Examination Service processed 90 Foundation licence assessments, 84 of the 90 were competent, 23 Standard assessments with 22 competent and six Advanced assessments, 3 competent.

Around 70% of the Standard and Advanced grade assessments were upgrades from the Foundation licence and

combined this gave us just over 90 new amateurs for the month.

The WIA examination service has processed 870 successful Foundation licence assessments since the first examination in late October 2005. There now seems little doubt that the WIA examination service will process more than 1,000 successful candidates in the first full year of assessing Foundation licence candidates.

Feedback from a growing number of clubs indicates that club membership and meeting attendance is growing. July was a record month for the WIA, with 77 new members for the month.

Since the restructure to a national WIA in May 2004, amateur numbers have grown by around 4% and WIA membership by 14%.

## A new 28 MHz calling frequency

Following consultation with Australian 28 MHz operators, the WIA has nominated a new suggested 28 MHz national calling frequency of 28390 kHz.

## WIA in Western Australia

WIA President, Michael Owen VK3KI visited Perth to attend a series of meetings with local clubs, in a program organised by WIA director Robyn Edwards VK6XRE.

On Sunday 23 July, there was a lunchtime BBQ meeting of the West Australian Repeater Group (WARG), on Monday evening there was a meeting of the WA VHF Group and on Tuesday, at their new premises, the Northern Corridor Radio Group.

The message to each club was the same. The President outlined recent developments, particularly in relation to the new amateur licence structure and the WIA's qualification of amateurs relying on WIA accredited and registered WIA Assessors.

He stressed that the attraction, training and qualification of new amateurs, particularly Foundation licensees, depended on a partnership between the clubs and the WIA, as each could do what the other could not do. The relationship must be seen as synergistic, not competitive, and the WIA particularly relied on the support of the clubs in attracting new members.

ar

# Worthy recruits, with a flare for performing unique tasks

## Amateur Radio Remembrance Day Contest 2006 Opening Speech by Horrie Young VK2AMZ

*This year the speaker was to be Mr. Horrie Young VK2AMZ. Horrie has been a speaker on this broadcast at times previously, and has always been succinct in his comments.*

*Sadly, this year Horrie became ill after preparing and sending his text to WIA and before the recording of the speech. Thus, another amateur, on Horrie's behalf, did the recording.*

*In thanking Horrie for his efforts this year, we wish him a good recovery and speedy return to the amateur bands.*

*The text of Horrie's speech follows:*

*Editor and Ian Godsilk VK3JS*

**How fortunate that the Government had had the foresight to approve the Amateur Service, thus being assured of a nucleus of highly skilled and trained communicators who required only minimal training to be fully absorbed into the armed forces**

**S**eptember 1939 saw a major movement in the Australian Amateur Service. Hostilities had been declared with Germany and in compliance with a direction from the then Wireless Branch of the Postmaster-General's Department, amateurs were required to pack up their radio equipment and seal it for the duration of the conflict. At the same time many amateurs changed from civilian dress to the uniforms of the Navy, Army and Air Force.

It was a period of considerable excitement, for apart from those who had enrolled in the Reserve Forces pre-war, few had experienced Service life and all that goes with it.

How fortunate was the Government of the day that it had had the foresight to approve the Amateur Service, while many other foreign Administrations

had declined to do so – regarding radio amateurs with a degree of suspicion and even worse. The Australian Government was thus assured of a nucleus of highly skilled and trained communicators who required only minimal training to be fully absorbed into the armed forces.

The ubiquitous amateur soon proved to be a most worthy recruit, often quickly moving through the ranks to positions of responsibility, and seemed to have a flare for performing unique tasks. Yes, the amateurs seemed to be everywhere – serving on warships on the high seas in dangerous convoys, minesweeping etc, flying as air-crew and improvising when need be, with the technical equipment of the day, which at times left quite a bit to be desired.

Some of their lesser known exploits included the dangerous task of serving as “stay behind parties” in territory occupied by the enemy, while volunteering to work with Services Reconnaissance Department and Z Special unit -- and who could forget the vital role played by the Coast Watchers of ‘M’ Force?

Sadly, the work of Special Force Operatives entailed tremendous risks, often working out of uniform and even employing the enemy's flag when it suited them. Capture meant instant execution and as a consequence many of these brave men lost their lives. It is thought that casualties in this branch of the Armed Forces were as high as thirty percent.

So it is by means of this important Contest that amateurs of today are accorded the opportunity of paying their respects to these gallant Australians who paid the supreme sacrifice, not only those of World War II, but also those who served in subsequent conflicts such as Korea, Vietnam and later peace-keeping groups. We also acknowledge that their sacrifice has in no small measure contributed significantly to the continuance of the Amateur Service as we know it today.

*At the going down of the sun...  
we will remember them*

ar

# 6 metre propagation

Mick Hort VK2BZE  
mickh1@exemail.com.au

Like many before, I had pondered the link between weather patterns and VHF propagation. Following the intense high-pressure cells and other ideas floating around did not reveal anything remotely repeatable. A brief following of Hepburn charts found them useless on 6 metres. I have not followed other VHF bands on Hepburn.

Some two years ago, I remembered a massive 2-metre opening to ZL and went digging through old logbooks to find it.

Shortly after finding the log details, a kind gentleman at the Bureau of Meteorology sent me the analysis charts for the 8th and 9th of January 1979, covering this opening in which many contacts were made on 2 metres FM simplex and via ZL repeaters for two days. These maps revealed nothing remarkable at first, having a large, moderate high-pressure cell extending west from ZL and a cold front in the lower Tasman. I scratched my head and put the maps aside for a long time, until one day I noticed on the maps an intense low cell north of ZL and east of Rockhampton. This was pushing lots of warm moist air from the tropics into the air stream heading down the Tasman from the high. This gave me the seed of an idea and I decided to study 6 metres since openings are much more prolific.

Since then I have kept a record of as many openings as I could using my own observation and input from other local amateurs. These date from 23 November 2003, being a copy of the daily analysis charts and, later, the cloud maps as well, and a brief notepad file on the happenings on that day which I can email to anyone interested in following this. Having followed this for some two years, the hit rate for ZL TV (45 MHz) is nearly 100%. Even with the low numbers of ZL 6-metre stations, myself and other locals have had a high contact rate to ZL as well as other areas in Australia. The mechanism has been discussed repeatedly by myself and John VK2BHO, who has been an observer and sounding board during this exercise. I do not purport to know the answer as to why it works, only that it is a ducting mechanism whose refractive properties are greatly enhanced by the moisture content of the air and thermal input from the sun. This process is described very well in the RSGB VHF UHF Manual 1969, Chapters 2.1 to 2.8. The key factor being that I think the ducts are at very similar heights and can link. They also vary in height giving rise to different propagation for 52, 144 and 432 MHz. These ducts have been followed as they move from Adelaide to Tasmania by looking for beacons in the path as the weather front moves eastward, and from the southern tip of ZL to the northern tip of ZL by following the TV stations as a front moves up the Tasman. Of late, I have been using Digipan to identify the ZL TV stations. This way you can see which part of ZL the duct is favouring. The ducting is not limited to large expanses of water but can, and does, occur with the heating and cooling of the land. This usually is noticed as coastal 2-metre openings but, in fact, can give long distance openings on 6 metres, one of which we worked to VK6 on the evening of 7th December 2005.

After a few months, it became obvious to me that every time some basic factors came together, there was propagation to ZL, either contacts or varying levels of ZL TV. These factors are a source of warm air, a source of cold air, a source of moisture, and input from the sun.

The observations are too many to list but I am happy to email anyone who

*continued on page 9*

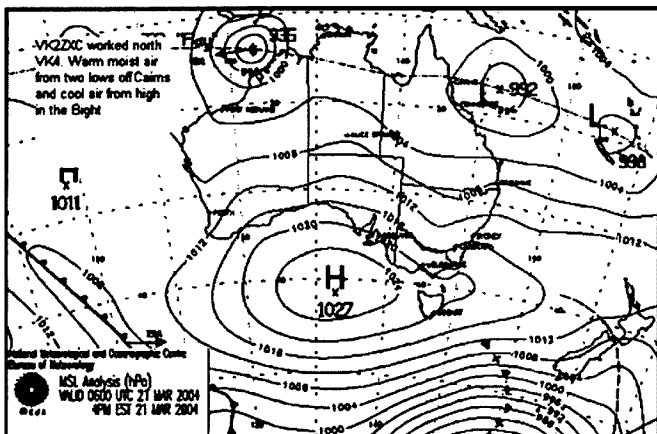
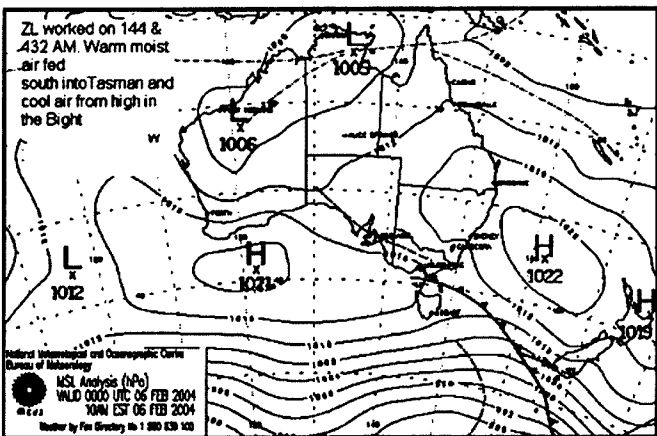
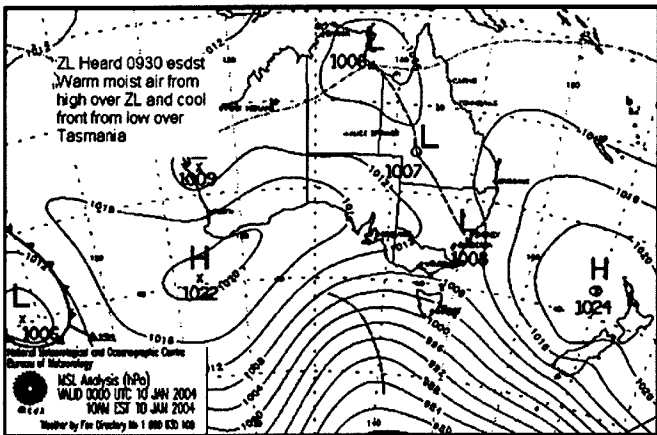

# The Slim Jim revisited

Bill Sinclair VK2ZCV

The Slim Jim antenna was developed by Fred Judd (SK) and the details first published in *Practical Wireless* and, subsequently, in *Out of Thin Air* and *More Out of Thin Air*. The name comes from its slender construction and the use of the "J" type Integrated Matching stub (JIM) that feeds the base. The antenna is basically an end fed, vertically operated, folded dipole and has been duplicated in various forms, and for different frequencies, throughout the world.

The version to be described came about after some discussions on our local Wednesday night net. It is an ideal and relatively cheap (approx \$20 at 18 December 2005) antenna to build using only hand tools. All parts are available locally and none are specialised. See Photo 1 for the complete antenna.

From information gleaned from various sources the following deductions were made. The original design frequency was 145 MHz, so this version has been scaled to 146.5 MHz.

It is advisable to feed the antenna with a balanced feed, therefore a "choke" balun has been incorporated (the cheapest effective method to achieve balance - see Photo 3).

Some form of tuning the antenna to resonance will give some latitude in construction errors. The method used here is taken from Fred Judd's Ultra Slim Jim and consists of a simple capacitor at the high impedance points. It consists of a strip of single-sided fibreglass printed circuit board with the copper side out (see Photo 2).

A more accurate method of locating the correct feed point without multiple holes, or a slot cut in the elements was deemed necessary. This was achieved after assembly of all except the feed point holes in the bar. It was done by sliding the feed point insulator, with feed coax attached and in contact with the bar, up or down to obtain the match (100 mm. in this case). Holes were then drilled in the bar.

Construction should be evident from the photos except for the dimensions. Lay the flat bar on your working surface and, from one end, which will be the top of the "J", mark the first bend centre at 487mm and the second bend centre at 1990 mm.

*NOTE that both measurements are from the same starting point.*

The two bends may be made by clamping a piece of pipe

approximately 40 mm in diameter vertically in a vice, laying the bar horizontally on the vice top, and clamping the bar to the pipe with vice grips or "G" clamp, then pulling both ends around the pipe. If all has gone to plan there should be a gap of 15 mm between the free adjacent ends.

From the longer of these ends cut off 10 mm to make a gap of 25 mm. Measure 490 mm along the longer side from the gap and mount the 43 mm x 12 mm x 12 mm piece of cutting board, which acts as a stiffener at a low impedance point. Notch the 25 mm x 50 mm x 12 mm cutting board approximately 6 mm or enough that the piece of PCB material when mounted will clear the mounting screws and attach at the gap. The PCB may also be mounted to the centre of this insulator at this time.

Clamp the two 50 mm x 45 mm x 12 mm pieces of board together and align carefully. Along the 50 mm side, at 25 mm and in 20 mm, drill a 20 mm hole that is a sliding fit on the

Photo 3 - Complete antenna

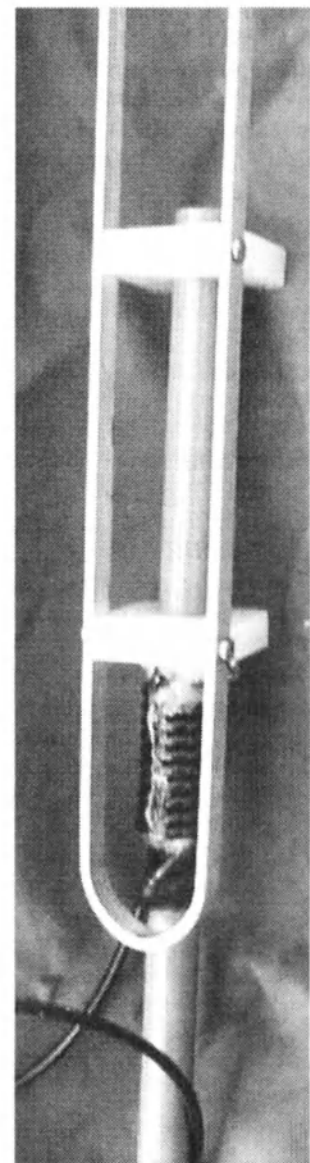

Photo 1 - Feed point and choke balun.

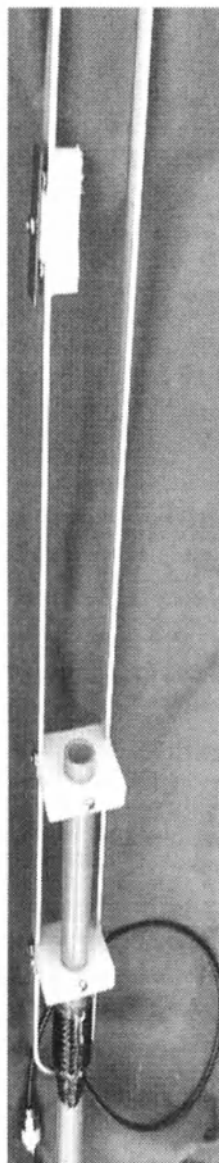
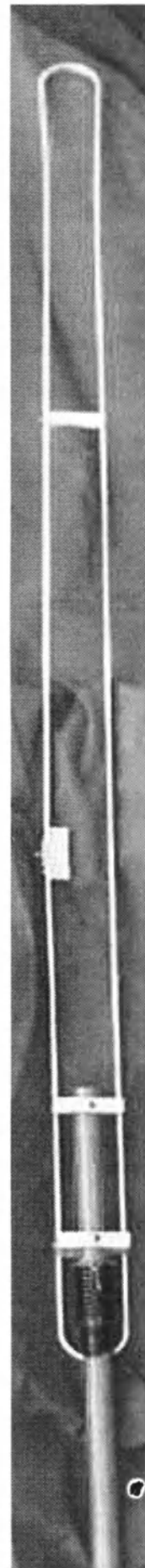

Photo 2 - Tuning and feed point.



*...America's Best!*  
**TEN-TEC**

# TEN TEC'S MIGHTY SIGNAL HUNTERS



Led by Orion II, the Mightiest Hunter of all

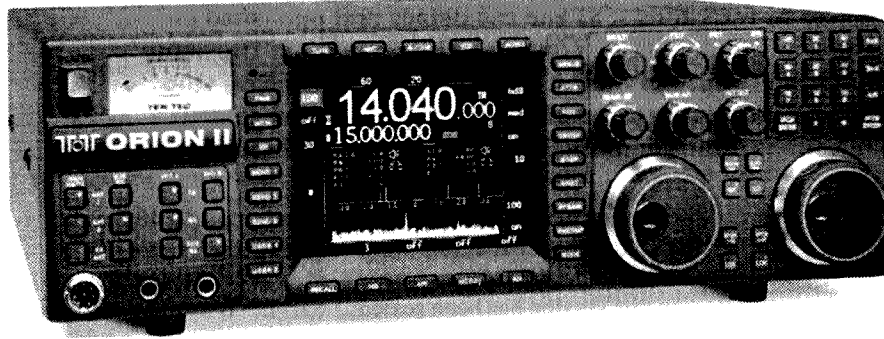

**Model 566 Orion II**  
Ultra High-End HF  
Transceiver

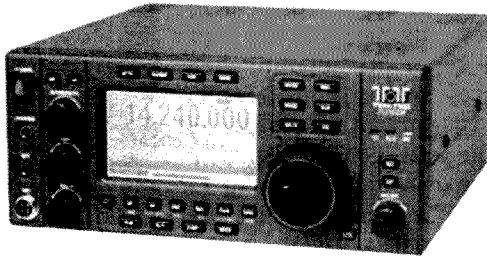

**Model 538 Jupiter**  
An old favorite

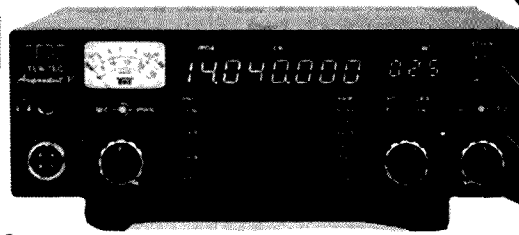

**Model 516 Argonaut V**  
The best in QRP

**AT 7000  
Tuners  
Now In  
Stock**

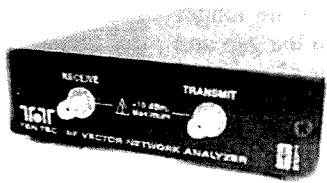

**Model 6000 Vector  
Network Analyser**  
Turn your PC into a VNA

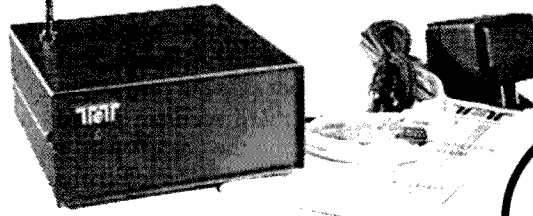

**Model RX320D 'PC Radio'**  
Shortwave Receiver  
Ideal for DRM reception

Check us out for  
Solar Panels,  
Regulators and  
Deep Cycle Batteries

## We also supply

LDG DTS-4 and LDG DTS-6  
Coax Switches

Amidon Iron Powder and  
Ferrite Coil Forms

AUTEK WM1 Computing Power/  
VSWR Meter

PC Based Vector Network  
Analyzer

Ten Tec HF Transceivers

Buddipole Antennas  
Professional RF Cables and  
Connectors

**KITS**  
for all levels of DIY Amateur



# TTS Systems Communications Equipment

[www.ttssystems.com.au](http://www.ttssystems.com.au)

**FREE CATALOGUE**

## HF and VHF Transceivers, Autotuners and Kits

Phone 03 5977 4808. Fax 03 5977 4801 [info@ttssystems.com.au](mailto:info@ttssystems.com.au)

conduit. On the opposite face notch each side 3 mm as seen in Photos 2 and 3.

Assemble the coax plug on to the coax and prepare the ends for solder lugs. At 170 mm from one end of the piece of conduit, wind and secure 10 turns of the coax (refer Photos 2 and 3). Slide both pieces of prepared cutting board on to the conduit and attach, with self-tapping screws, the TOP piece ONLY at 20 mm from the top of the conduit and 235 mm from the inside of the bottom of the "J".

Using tails as short as possible attach, with solder lugs and self-tapping screws, the coax to remaining block so that the heads of the screws can make contact with the "J" at about 100 mm from the bottom. Adjust the position of the tuning PCB and this block for best match. Attach the coax permanently after drilling holes in the aluminium at this point. Seal all the connections and secure the blocks to the conduit.

The antenna is now complete. For best operation, mount outside as high as possible, and in the clear, using low loss coax. It may be coated with TECTAL 151

for weather and UV protection. The 2:1 VSWR points of the prototype occur 15 MHz apart.

## Parts list

- 3 m 12 mm x 3 mm aluminium bar.
- 11 S/Steel self-tapping screws, pan 8G x 12 mm.
- 600 mm x 20 mm PVC conduit.
- 2 of 50 mm x 45 mm x 12 mm kitchen cutting board.
- 1 of 43 mm x 12 mm x 12 mm kitchen cutting board.
- 1 of 25 mm x 50 mm x 12 mm kitchen cutting board.
- 1 wavelength coax @ 2 m = 1354 mm + 60 mm for tails.
- 1 of 12 mm x 60 mm piece single sided fibreglass PCB.
- 1 of coax plug or socket to suit your gear.
- 2 of solder lugs with 4 mm hole.

## 6 metre propagation continued

has questions on the maps and their interpretation.

As a double blind, observations of many days when no fronts were showing were studied and on none of these days did anything but brief meteor or aircraft enhancement occur. Sporadic E never came to the rescue to save the day. This phenomenon goes on in winter as well, and contacts or strong ZL TV signals have been observed every month of the last winter.

The text file is too big for this brief introduction, and there are many weather analysis and cloud maps available to anyone sending an email to the above address. If there is enough interest, I will write another article with maps and comments.

*A version of this article has been previously published as "6 metre propagation and weather patterns" Break-In, p17, Jan/Feb 2006.*

ar

ar

# Andrews Communications Systems

## ICOM DISCOUNTED

IC-756 Pro III HF+6m	<b>\$4,999</b>
IC-V8000 2m 75W	<b>\$399</b>
IC-746 Pro or IC-7000	<b>\$2,699</b>
IC-706 Mk 2G HF-70cm	<b>\$1,399</b>
IC-718 HF SSB	<b>\$999</b>
IC-910H 2m+70cm SSB	<b>\$2,299</b>
IC-208H 2m+70cm	<b>\$579</b>
IC-2200h 2m 60W	<b>\$399</b>
IC-T90A Triband h/h	<b>\$449</b>
IC-2720H Deluxe D/bander	<b>\$699</b>
IC-P7A New tiny D/bander...	<b>\$389</b>

\* 3 YEAR WARRANTY\*

## ALINCO

### Factory Direct Importer

NEW DR-635T Twinbander	<b>\$699</b>
DR-135T Mk2 2m 50W	<b>\$349</b>
DR-435 UHF 35W	<b>\$369</b>
DJ-V5E Dualband handheld	<b>\$499</b>
DJ-X2000E Hi-tech scanner	<b>\$699</b>

\* 3 YEAR WARRANTY\*

Spectrum Analysers from **\$999**  
Oscilloscopes from 20MHz to 100MHz

## ICOM IC-7000 \$2199



### HF-70cm COLOUR TFT DISPLAY

IF DSP, Twin PBT, 508 channel memory + more

## bhi DSP NES10-2

Amazing DSP speaker  
Hundreds sold!



**\$249**

## KENWOOD DISCOUNTED

TS-570SG HF+6m+ ATU	<b>\$1,999</b>	TM-D700A Dualband Mob	<b>\$899</b>
TS-480HX HF 200W+6m	<b>\$1,999</b>	TS-480SAT HF+6m+ ATU	<b>\$1,899</b>
TS-2000 HF-70cm + ATU	<b>\$2,799</b>	TM-G707A 2m/70cm mob.	<b>\$499</b>
TS-570DG HF + ATU	<b>\$1799</b>	TM-V708A Dual band Mob.	<b>\$799</b>
TM-271A K 2m mobile	<b>\$379</b>		

\* 3 YEAR WARRANTY\*

NEW

## YAESU DISCOUNTED

FT-1802M 2m 50W Mob.	<b>\$289</b>	FT-60R Dualband h/h	<b>\$369</b>
FT-7800R Dualband	<b>\$449</b>	FT-817ND HF-70cm Port.	<b>\$999</b>
FT-8900R Quadband	<b>\$799</b>	VX-1R H/held 2 batts	<b>\$249</b>
FT-8800R Dualband	<b>\$699</b>	VX-2R Tiny Dualband	<b>\$319</b>
FT-897D HF-70cm	<b>\$1,399</b>	VX-170 2m H/held	<b>\$269</b>
FT-857D HF-70cm	<b>\$1,299</b>	VX-6R Dual H/H	<b>\$449</b>
FT-2800M 2m 65W	<b>\$299</b>	VX-7R Deluxe H/H	<b>\$549</b>

\* YAESU ROTATORS DISCOUNTED\*

\* 3 YEAR WARRANTY\*

Australia's Biggest Amateur Radio Stockist

## HF VERTICAL ANTENNAS

DIAMOND CP-6, 80m-6m	<b>\$499</b>
DIAMOND BB7V Broadband	<b>\$499</b>
COMET CHA-250B B/band	<b>\$599</b>
MALDOL HVU-8, 80m-2m...	<b>\$499</b>
HY-GAIN DX-88, 80m-10m...	<b>\$799</b>

THP, LDG, MFJ, ALINCO, ICOM, YAESU  
Automatic antenna tuners in stock  
TET-EMTRON HF Antennas in stock  
AVAIR POWER METERS, "T" LEADS, ETC.  
MFJ Antennas, Tuners, Analysers, etc.  
ANDREWS AMPS ..160m-10m 500W+  
w/protect. **\$999**, 2m 120W **\$329**,  
200W **\$449**, 300W **\$999**.

ANDREWS YAESU, PALOMAR, TE SYSTEMS, AMERITRON, ICOM linears

## ANDREWS AMATEUR BASE ANTENNAS

BF-2M2 Fibreglass 2m 6.7dB	<b>\$99</b>
BF-2M3 Fibreglass 2m 7.8dB	<b>\$129</b>
UVS-200 Fibreglass 6dB/8dB	<b>\$149</b>
UVS-300 F'glass 8.3dB/11.7dB	<b>\$199</b>
CBS18 Fibreglass 5.7dB 10m	<b>\$179</b>
Discones from <b>\$99</b> , Coax switch <b>\$29</b>	
Hustler HF Verticals	From <b>\$349</b>

We export worldwide.

We also hold some stock in New Zealand!

**CALL (02) 9636-9060 or (02) 9688-4301 or FAX (02) 9688-1995**

WHY PAY MORE?

Shop 8, 41 Bathurst St., Greystanes, NSW 2145

**MAIL ORDER to PO Box 240 PENDLE HILL NSW, 2145**

<http://www.andrewscom.com.au>

email: [lee.andrews1@bigpond.com](mailto:lee.andrews1@bigpond.com)

Some items indent.  
Prices subject to change without notice.  
Limited stock some items E&OE 8/06

# The secret spectrum - clandestine broadcasting

Dr Hank Prunckun, VK5JAZ

**No, the "secret spectrum" isn't the new name for a government regulatory agency, but a reference to the world of secret radio transmissions. In this article, Dr Hank Prunckun looks at one aspect of this shadowy world, that is, clandestine broadcasting.**

The "war on terror" has highlighted how agents of, not opposition government intelligence services, but radical political groups, are operating in our midst. Even though these groups spend their entire time doing their work in secret, the electro-magnetic spectrum is a rich source of potential information about some of these secret organisations. Like a parallel universe, the radio spectrum is full of transmissions which can be part of elaborate psychological operations or "psy-ops."

Even though this is a secret world, it can, and is, "penetrated" all the time, not by intelligence organisations sent to track down these radical groups, but by radio amateurs, shortwave listeners, and just about anyone with a radio receiver. Really! Anyone with a radio has the potential to open up this world. Let's have a look at the most high-profile form of secret radio transmissions - clandestine broadcasting.

## Clandestine Broadcasting

What distinguishes clandestine broadcasting from other forms of broadcasting are four factors.

Clandestine broadcasting is political in nature; its operations employ some degree of deception; it is political; and they are extra-legal (that doesn't mean that their solicitors charge more - I'll explain this term in a minute).

For a radio station to be a true clandestine operation each of these elements must be present but of course, will vary in degree with the individual station.

The first element - political in nature - means that the station wants to bring about change or action. Such stations are likely to appear as a result of some civil unrest in the country that is its "target" (or perhaps in another country outside its

borders that is sympathetic to the group's cause).

The second thing that makes a clandestine station is that it operates under a veil of deception. Transmitter sites and studios are never revealed. For instance, you'd never hear, "...this is the Voice of the Political Underdog, operating from its studio in exile here in the Strzelecki Desert..."). In fact, some clandestine stations have even broadcast false locations to throw any secret spectrum sleuth off their track.

Thirdly, clandestine broadcasts are fleeting phenomena of the airwaves. As their sole purpose is to drive a political message, clandestine stations appear and vanish as quickly as the political "trouble" they are addressing has passed (or the "trouble" locates them and destroys their radio equipment and throws them in jail...). A clandestine station is not a stable operation.

Finally, clandestine stations are extra-legal. This means that they operate in violation of national and international laws. It is common for them to utilise frequencies outside those that are internationally allocated for commercial broadcasting. In addition to ignoring these "band plans," these stations often encourage illegal activities in the country to which they beam their broadcast. This usually takes the form of encouraging opposition to, and struggle against, the government in power (or in some situations, the dictator, junta, or military ruler that might have installed itself in the seat of government).

Now that we have a picture of what

constitutes a clandestine station, the next question is, "why do they broadcast?" The answer is simple. A clandestine broadcasting station can easily demonstrate its supremacy over other communication media in several respects. It is immediate and it is universal.

It is immediate in the sense that there is no time lag between announcement and reception of the message; and it is universal because it cannot be easily stopped at national borders. Telephone lines, including internet links and other land-based telecommunication systems, can be cut or interrupted, but radio can get through regardless. It also has the attraction of being, arguably, the most popular communication medium in the world.

Finally, clandestine broadcasting eliminates an otherwise impossible logistical problem that would be

**Even though this is a secret world, it can, and is, "penetrated" all the time, not by intelligence organisations sent to track down these radical groups, but by radio amateurs, shortwave listeners, and just about anyone with a radio receiver. Really! Anyone with a radio has the potential to open up this world.**

encountered if, say, the print media were used. Can you visualise this happening: a group of underground operatives using a DC-3 Dakota to air-drop leaflets over Sydney, Melbourne, and Canberra. Not likely! However, a broadcast via a satellite to a large "footprint" of the earth's surface is not only possible, it happens every day.

As a tool for political manipulation, broadcasting has an enormous potential to influence public opinion.

For example, in August 1997 news headlines carried the story that it was the first time the Bosnian Serb republic's electronic media broadcasts were not under the control of strongman Radovan



Karadz. The president of the newly created Bosnian Serb sub-state, Ms Biljana Plavisc, was credited with now having a "powerful weapon." The media report stated, "NATO can protect Ms Plavisc from physical harm but cannot shape public opinion the way television [the electronic media] can. Bosnian Serbs, who mostly live in rural areas and are poorly educated, generally believe what they see on TV [and hear on the radio.] (Savic, Misha, The Advertiser, 26 Aug 1997: p14)."

On the other hand, Radio Australia prides itself on unbiased and objective reporting of current and political events around the world. It is widely acknowledged that stations like Radio Australia and the BBC counter the "disinformation" propagated by these clandestine broadcasters.

As such, people in many countries, especially third-world countries where the literacy rate is low, seek out these reputable and respected broadcasts. Australian stations are arguably amongst some of the world's best for objective reporting.

## Current clandestine radio activity

To describe the current clandestine broadcasting situation would be difficult, not because of any technical radio related reason but because the world's political landscape changes so rapidly that any attempt to catalogue the stations, times of broadcast and their frequencies, would result in an out-of-date list as soon as it is published.

This is because clandestine radio is the gathering of several worlds under the umbrella of media broadcasts - politics, international relations, and most importantly, espionage.

Over the decades there have been numerous clandestine stations that operated in different parts of the world and they have come-and-gone from the radio spectrum as abruptly as the politics that surround their issues changed.

For instance, at the time of this writing, a London-based group with alleged sympathies to a branch of al-Qaeda, abruptly ceased its satellite radio broadcasts days after the 7th July 2005 terrorists attacks on London's underground trains and bus facilities.

Previously, clandestine stations in our region have operated from Papua New

Guinea, East Timor, and Vanuatu.

It is fair to say that, where one finds political unrest and upheaval, one will find clandestine broadcasting. If the country's target listening population is less developed and ill educated, then the likelihood that clandestine broadcasting will be heard increases dramatically.

In the days before the internet, the only way to keep track of clandestine broadcasters was to join a shortwave listening club or subscribe to a publication that monitored these broadcasts.

However, there are now several websites that specialise in monitoring developments. The website considered by most as the premier in keeping tabs on what's happening in this part of the secret spectrum is [www.clandestineradio.com](http://www.clandestineradio.com).

This website features information about current clandestine stations and has archival information about "inactive" stations. It also has a section that lists the clandestine stations that are on the air at that time and the frequencies on which they are transmitting.

There is background information about the political stance of these stations, and more. It is worth a visit to this website. This website states that it is "...regularly used by radio monitors, academics and historians, journalists, and military and intelligence analysts to track 'psy-war' developments across the globe."

## Summary

Because clandestine stations transmit their signals to the world at large, anyone with a radio receiver and a reasonable antenna can join in the political intrigue, along with the long list of intelligence agencies (friend and foe) that no doubt follow these broadcasts closely (and in the case of some countries, they may even sponsor them...). Good hunting!

ar

*Dr Hank Prunckun is a research criminologist specialising in the study of trans-national crime — including espionage. In addition, he holds an advanced amateur radio operator's licence (VK5JAZ) and a marine VHF radio operator's licence. He has been awarded the DXCC by the Wireless Institute of Australia and has earned several awards for his work in shortwave listening.*

ar

# Silent Key

## Chris Jones, VK2ZDD

It is with very great sadness that I have to tell you that Chris Jones, VK2ZDD, passed away early Friday 25 August 2006.

Chris was Secretary of the WIA, but more importantly the person whose vision and commitment made the WIA what it is today.

It was Chris who talked a group of amateurs in late 2003 into believing that a national WIA was a realistic and better option.

It was Chris who believed fervently that the organisation would grow if it delivered service and avoided conflict.

It was Chris who inspired so many to contribute in so many different ways.

It was Chris who contacted and organised the WIA Assessor training courses, who inspired so many people to make our new licence system really work.

It was Chris who made sure that somehow the WIA delivered many things that many wanted.

It was Chris who worked the phones like no one else I have ever met. It was Chris who involved so many people in so many things.

Chris Jones was a person who avoided conflict and loved to be surrounded by his many friends.

I extend our most sincere sympathy to his family and his many friends.

His passing is a very great loss to the Wireless Institute of Australia.

submitted by Robert Broomhead  
VK3KRB



# A scalable solar regulator

Dale Hughes VK2DSH

Renewable energy has captured the attention of many people. The most accessible form at present is capturing energy directly from the sun and solar panels are now readily available at reasonable prices. Along with the solar panels, the user needs batteries to store the collected energy and a means of regulating the current into and out of the batteries (there are grid connected systems that convert the collected power directly to 240 VAC 50 Hz for resale, but this is outside the scope of this article). This article covers the design and construction of a regulator that can be scaled to any required capacity.

Many people might wonder why not just purchase a suitable regulator? They are readily available and are not expensive. However, designing and building a system offers the advantage of being able to build something that suits the needs of the user and, perhaps more importantly, offers the chance of learning new ideas and techniques – and that is one of the great things about our hobby!

In this case, there is opportunity to learn about using high power field effect transistors (FETs) to control significant amounts of power.

The system I will describe uses components that are easily sourced, either new through the usual merchants, or salvaged from switch-mode power supplies or other junk electronic devices. This design does two things:

- Controls the charge current into the batteries from the solar panels by means of sensing the battery terminal voltage.
- Disconnects the load from the battery if the battery voltage drops to an unsafe level due to charge failure.

## Circuit description

For long-term stability of the regulator voltage set points, a temperature stable reference voltage is required and this is provided by U3. The device used is an LM336-5, a 5.00 V reference diode, the output of which is buffered by a voltage follower U2b. The reference voltage is then connected to two operational amplifiers (U2a and U4) connected as voltage comparators. U2a has two inputs; the 5.00 V reference and the battery voltage via R4, R5 and VR1. When the sampled battery voltage on the wiper of VR1 falls below 5.00 V, the output of U2a falls to a value that is close to ground, turning transistor Q1 off, allowing current from the solar cells to flow into the

batteries (and load).

Transistor Q1 is configured to act as a switch that is either completely open circuit or short circuit. When the battery voltage reaches the required level, the output of U2a swings to approximately 11 V, turning Q1 on and shunting the charge current away from the batteries. Diode D1 prevents the batteries from discharging through the same path.

Positive feedback around U2a by means of R3 speeds up the switching action of U2a and provides a useful amount of hysteresis so that rapid on-off switching of the charge current is avoided. With the component values shown, the hysteresis is approximately 2 V, so that if the switch-off point is 27 V, the battery voltage has to fall to 25 V before charging recommences. Increasing the value of R3 will decrease the amount of hysteresis; for example, if R3 is 680 k $\Omega$  the hysteresis is approximately 0.5 V.

Note that it is important that Q1 does not enter a linear region; it must be either 'hard' on or off otherwise it will quite likely be destroyed due to exceeding the safe operating region of the device.

The shunt connection of Q1 might be questioned, but as the solar panels have a fairly high internal resistance and approximate a current source, it seems that shorting their output causes no harm (the same configuration is used in a number of commercial regulators). When the system is working correctly and the input is being shunted, Q1 dissipates very little power. In my case, using two 80 W panels in series in full sunlight, the shunt current was 6 A and the voltage across the transistor Q1 was only 60 mV, giving a power dissipation of 0.36 W - not even warm to the touch. The other advantage (for me, at least) was that I could have common ground between the solar panels, the batteries and the load, thereby eliminating some potential problems.

As previously mentioned, batteries

are generally required in renewable energy systems and they are often the most expensive part of the system – thus they should be protected against being excessively discharged. Transistors Q2 through Q5 and U5 form a 'high-side' switch which can turn the output voltage on, or off, as required. U5 is a small DC-DC converter (1 watt, 12 VDC galvanic isolated output) that is used to provide the gate-source voltage which switches the transistors on as they are enhancement-mode devices. U5 is powered by U4 which is configured as a comparator that senses the battery voltage via R8 and VR2. When the battery voltage falls to an unsafe level, U4 output swings low turning off U5 and Q2 through Q5. The parallel connection of U4a and U4b provides sufficient current capability to power U5.

During development of this system, I destroyed several regulator transistors. Even though power FETs are quite rugged, they can be easily destroyed if sufficient care is not taken. The 10  $\Omega$  resistor in each gate circuit is to prevent spurious oscillation of the devices and the resistors should be mounted as close to the transistor as possible. In the prototype the resistor was soldered to the gate lead and covered with a small piece of heat-shrink tubing.

Components D2, D5, D6, C1 and C5 help protect the regulator from externally induced transients (D2 is a 51 volt, 5-watt Zener diode).

The automatic charge control may be overridden by closing the 'Boost' switch, as this forces comparator U2a to the 'off' position. This facility is useful for 'boost' charging the batteries, but the facility should be used with care as it disables the charge regulator, possibly overcharging the batteries. Switch S3 controls the output high-side switch and can be used to override the low voltage cutout switch.

**Switch Function:**

- 1 = Off
- 2 = Battery
- 3 = Battery/solar
- 4 = Off

**Low battery voltage disconnect**

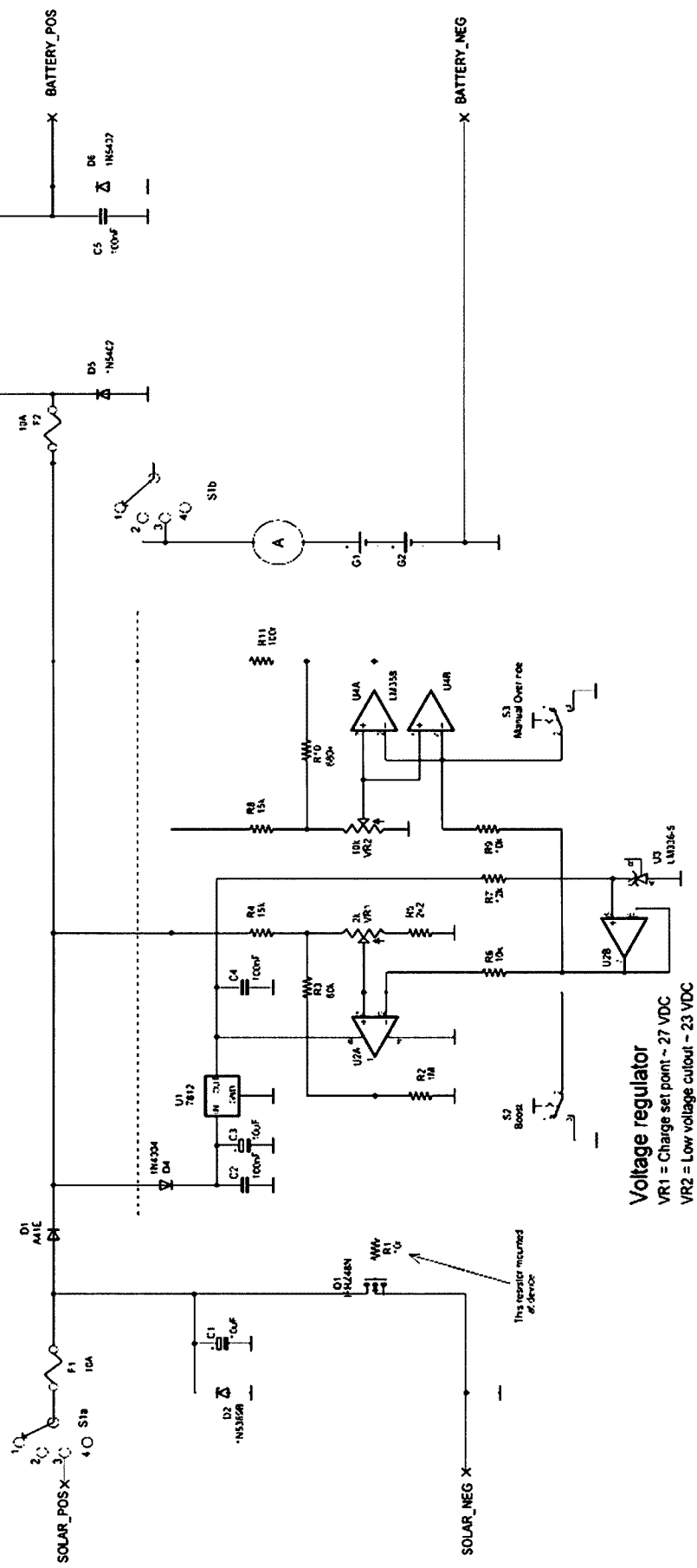
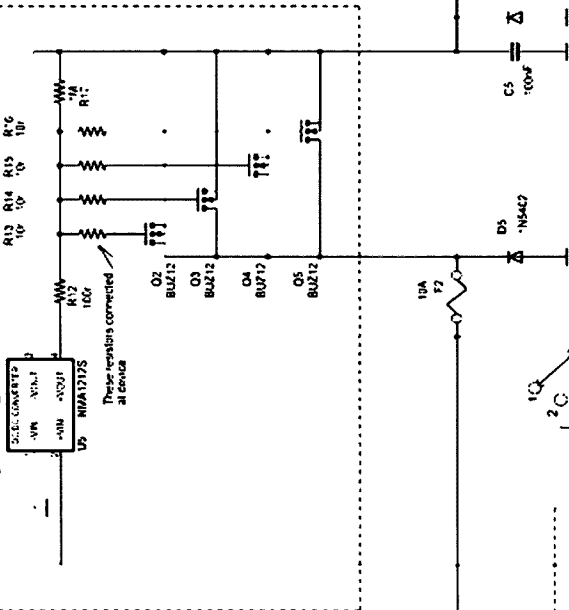

**Voltage regulator**  
 VR1 = Charge set point ~ 27 VDC  
 VR2 = Low voltage cutoff ~ 23 VDC

Figure 1 - Schematic diagram of the regulator and low voltage cutoff.

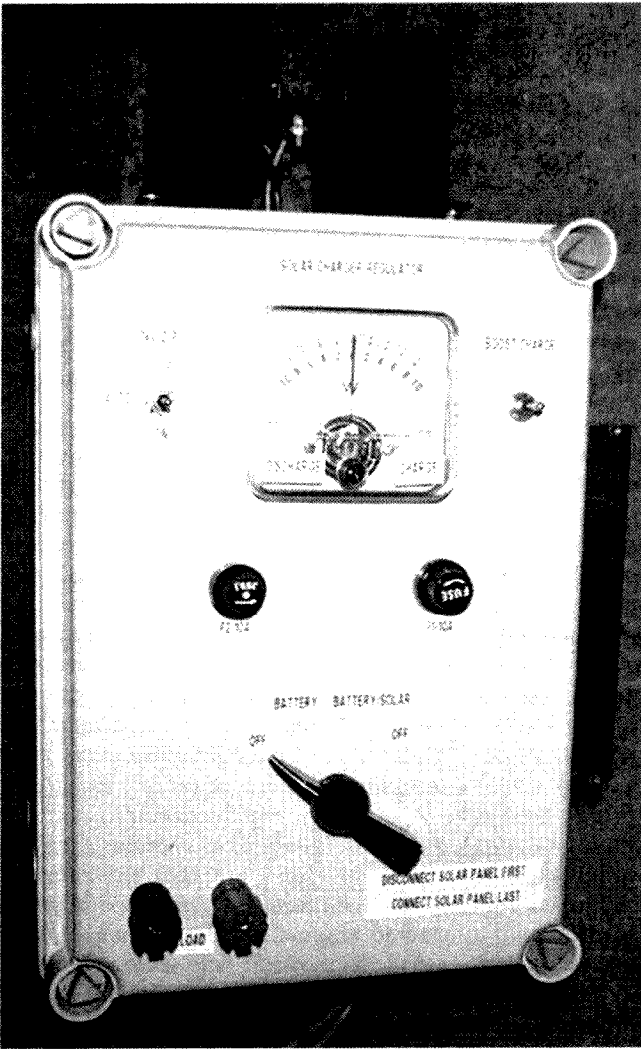

Photo 1 - Completed unit. The heat sinks are probably excessive, but they offered convenient mounting of the power FETs.

In this design, I have included switching that allows the power to be supplied from the batteries alone, or allows the batteries to be charged while connected to the load. Rupture of the output fuse (F2) disconnects the load but keeps the connection between the solar panels and batteries intact. The switch needs to have sufficient current carrying capacity for the anticipated current flow. I used a large wafer switch with four switch sections paralleled. A centre-off toggle switch with a sufficient current rating could be used instead. Protective fuses and a centre-zero ammeter complete the circuit. The current consumption of the complete circuit is approximately 15 mA.

### Expanding the system

Parallel connection of power FETs offers a convenient way of increasing

their power handling capacity. Devices of the same type can be connected in parallel without taking special precautions as they have a positive temperature coefficient that forces proper current sharing. However, I did ensure that the wires connecting each device were all of the same length and gauge. When they are switching, the input capacitance needs to be charged or discharged, but after that, no power is required to maintain the device on or off. Thus, provided the devices can be switched quickly enough, as many as required may be connected in parallel to provide the regulating and load current capacity.

Many different FETs are available, the main factors to consider are:

- $R_{ds(on)}$ : which should be as low as possible so that power dissipation is minimised.
- Maximum drain-source voltage ( $V_{ds}$ ) rating should be at least 60 V for the regulator transistor (Q1) as the solar panel open circuit voltage can approach 40 V and transients can

- easily exceed this value;  $V_{ds}$  should be at least 40 V for Q2 through Q5.
- Maximum drain current rating ( $I_D$ ) for Q1 should be sufficient for the short circuit current of the solar panels; and for Q2 through Q5  $I_D$  should be sufficient to handle the maximum likely short circuit current before the load fuse ruptures.

The safe operating area for the BUZ12 devices is shown in Figure 2. It can be seen that the DC region current rating is significantly less than the 10 ms rating. For the BUZ12 devices used in the low voltage switch, the 10 ms current rating, with  $V_{ds} = 30$  V, is 20 A per device, so the parallel connection of four devices should easily tolerate the full short circuit current before the fuse ruptures (I have tested this!). The shunt regulator device has a current rating of 30 amps at  $V_{ds} = 1$  V, so the device should be easily capable of handing quite large solar arrays.

Diode D1 will also need to be changed to suit the requirements of the system. I used an A41 diode recovered from an old power supply. This device is stud mounted with a 50 V rating and a continuous current rating of 20 A. Systems with more solar panels will require a diode with a higher current rating.

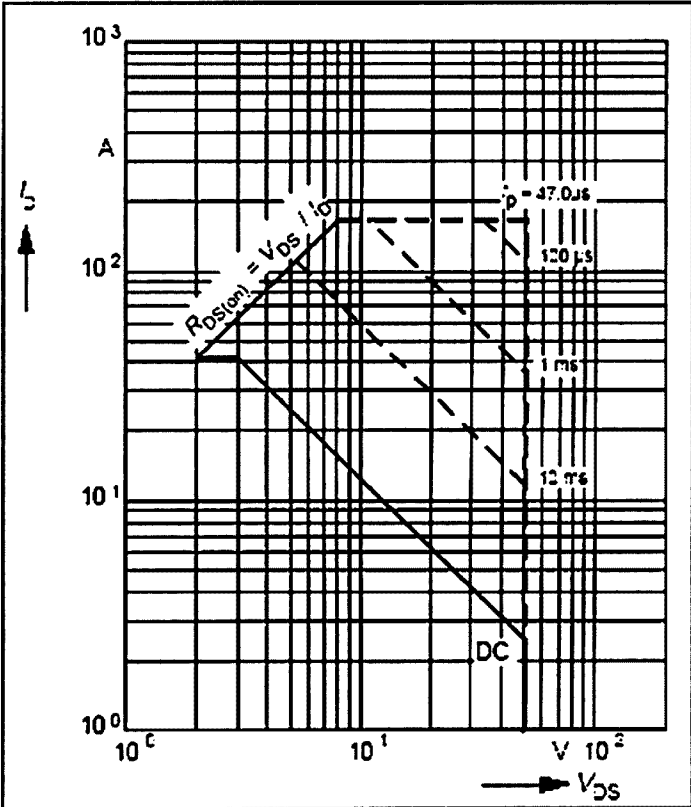

Figure 2 - Safe operating region for BUZ12 device.

## Safety

There are a number of safety issues that should be considered:

- Always ensure that the solar panels are not connected to the load without batteries being connected, as the open-circuit voltage of the solar panels can be much higher than the usual system voltage. In my system (nominally 24 V), the open circuit voltage of the panels is nearly 40 V and this would be sufficient to damage equipment on the load side if the batteries are not connected – always connect the solar panels last and disconnect them first when installing or working on the system.
- In these types of systems, ALWAYS be aware that large batteries can supply very large amounts of current. Make sure that suitable fuses are installed and that connecting leads have sufficient current carrying capacity.

- Solar panels are often mounted at height, therefore use appropriate safe working procedures when installing or servicing panels that are mounted on roofs or posts.

## Conclusion

A design for a simple regulator has been presented and the capability of the unit can be scaled to suit the user's needs. The components are readily available. I purchased Q1 from Futurelec (www.futurelec.com.au) and these devices could also be used in the low voltage cut-out switch. Futurelec has a good range of FETs, along with data sheets, and they offer a very useful internet purchasing facility. The DC-DC converter can be purchased new from Farnell (NMA1212S Cat No 330-796), and Jaycar also offers suitable devices. Other than noted already, there are no special construction requirements; the prototype was built on Vero-board in a surplus plastic enclosure.

ar

## Over to You

### Fuel economy

In relation to the VK1GH reply to Neville Chiver's article (pp. 19-21, May AR), I wish to make the following points regarding fuel economy:

- 1) Most people in Australia will do 90% of their driving around town, with the typical stop-start pattern.
- 2) Under these conditions, Neville's diesel golf will still be achieving approximately 5.9 L per 100 km. Personally, I am on my fourth diesel-powered vehicle and they all achieved exactly the same fuel consumption on a long trip as when driving around town.
- 3) What will a Calais be doing around town? Perhaps 14 L per 100 km?
- 4) 100 km is not a very long trip. The saving on a 1,000 km trip is approximately \$144.
- 5) One of the services for a medium size Hyundai is around \$750.

These represent a few more issues for one to consider.

Mick Hort VK2BZE

Simplex  
and Duplex  
operation

# Handhelds 2m or 70cm

LOCKED OUT FOR HAM BAND ONLY

144 TO 148 MHZ (VHF)(2M) OR 420 TO 450 MHZ (UHF)(70CM)

### SPECIFICATIONS:

- 1) Voice Prompt on Keypad
- 2) CTCSS with 39 codes
- 3) 99 Storage channels
- 4) Auto scan
- 5) Large screen LCD
- 6) Back Lighting
- 7) VFO programmed (input freq. from keypad)
- 8) Hi & Lo Power select
- 9) Channel spacing: 5KHz, 10KHz, 12.5KHz, 25KHz
- 10) Keypad lock
- 11) Monitor function (input frequency)
- 12) Low-battery warning
- 13) Frequency Modulation
- 14) Auto power save
- 15) Output power: 4 - 5W
- 16) Large-capacity battery

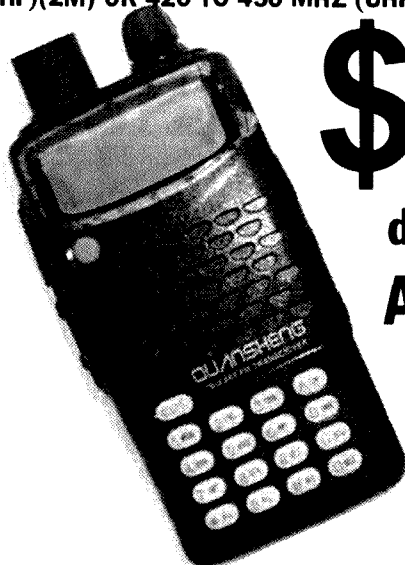

# \$99

delivered in  
Australia

2.4Ghz  
Bench top  
frequency  
counters  
on the way.  
Register your  
interest now



### Extras

Extra Battery (1100mah)	\$10
Speaker Microphone	\$12
Car Charger	\$12
(can charge spare battery and handheld at the same time)	
Headset/Microphone	\$8
SMA to BNC Converter	\$5

Geoff White (VK6NX) **08 9498 1157**

(Please leave a message if unavailable, I'm at home looking after a 1 year old future ham)

116 Amethyst Cres, Mt Richon, WA 6112

[cityonline@wdsi.com.au](mailto:cityonline@wdsi.com.au)

# Aussie kids chat with the space station

## ARISS talk to Briar Hill Primary School

North East Radio Group

Just how does a radio club get involved in participating in the international space program? Well, in our case the concept was initiated by one of our local Banyule city councillors, Jenny Mulholland, and swiftly followed through by the NERG.

The NERG (the North East Radio Group, in Melbourne's north eastern suburbs) had the use of facilities at Simpson Army Barracks in Watsonia until the atrocity of September 11, after which upgraded security initiatives prevented civilians from entering the base, leaving the NERG homeless. Our approach to Banyule council for help was heeded by Jenny who saw the possibility of an amateur radio club providing much needed alternative interests for youth in the local community, so with her help the NERG was provided with permanent use of an excellent hall in an ideal



Teacher Natalie Will rehearses questions with the students

**SPECIAL BUY**  
VX-150 2m H/H  
only \$249.00

# G&C COMMUNICATIONS

Authorised dealer for Icom • YAESU • Kenwood • Barrett RFDS • GME Electrophone • Uniden

**See us for CAR Stereo too! ~ 'Cranbourne Car Sound'**

### ICOM (Aus.) TRANSCEIVERS

IC-756 Prof III HF + 6M	\$4,999
IC-7400 HF +6M +2M	\$2,699
IC-7000 NEW! HF~70cm Mob	\$2,299
IC-706MKIIG HF~70 A'Mod	\$1,399
IC-718 HF SSB	\$999
IC-910H 2M/70cm M'mode	\$2,499
IC-2720H 2/70cm D/Band	\$699
IC-208H 2/70cm D/Band	\$579
IC-2200H 2M H/Power'	\$449
IC-T90A Tri-Band H/Held	\$479
IC-P7A Mini D/band H/Held	\$395

**2 YEAR ICOM (Aust.) Warranty!**

★ Full Product Range Available! ★

Full range of Communications/Scanner Receivers available from Icom, Uniden, Yaesu \$ POA

### HF Vertical Base Antennas

Comet CHA-250Bx 2.8-57MHz	\$699
Diamond BB7V 2-30MHz	\$499

### Antenna Tuners



MFJ-902	MFJ-902H
MFJ-904H	MFJ-945E
MFJ-949E	MFJ-929

**More Details on Website**

### Antenna Rotators

**G450A (shown)**



G-2800DXC	G-450C
G-1000DXC	G-5500
G-800DXA	
G-650C	

### TE series EMTRON HF ANTENNAS

Australia wide orders welcome  
Credit card Cheque Money order

### YAESU Transceivers

FTDX-9000DA Elite HF Base	\$16,499
FT - 897D HF - 70cm	\$1,399
FT - 857D HF - 70cm	\$1,299
FT - 817ND HF - 70cm	\$1,049
FT - 8900R Quadband	\$ 799
FT - 8800R Dualband	\$ 699
FT - 7800R 2/70 Mobile	\$ 469
FT - 1802M 2m 50W Mob	\$ 299
FT - 60R2/70 H/D H/H	\$ 369
VX2R 2/70 H/Held	\$ 329
VX-6R 2/70 H/Held	\$499
VX -7R Tri-Band H/Held	\$599
VX-170 2M Rugged H/Held	\$279
VR-5000 Receiver	\$1,199
VR-500 H/H Receiver	\$499
VR-120D H/H Receiver	\$ 279

**3 YEAR AUSTRALIAN WARRANTY**

Call in and see our range of power supplies, cables and connectors

**Comet & Diamond**  
Antennas & Accessories

Proudly Supporting  
Australian Business

207 High St. Cranbourne VIC 3977  
Ph: 03 5996 3298 Fax: 03 5995 0184

Email: [gccomm@bigpond.net.au](mailto:gccomm@bigpond.net.au)  
[www.gccomm.com.au](http://www.gccomm.com.au)

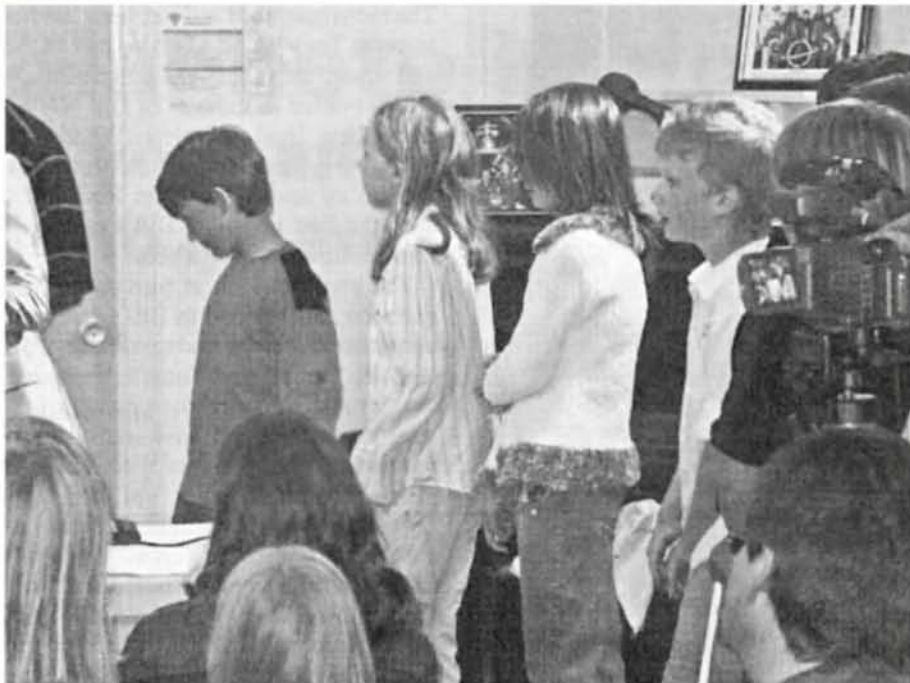

Students line up to talk to Bill McArthur, the ISS commander

hill top location.

In recompense, the NERG was asked to work with local youth groups, essentially by introducing them to all that amateur radio had to offer. To have Briar Hill Primary School students involved in the space program became an obvious choice, as they had earlier provided us with temporary accommodation, and had a very open and broad approach to their students' education, in no small way due to Principal Ross Dudgeon and staff member Natalie Will.

The NERG approached Australian ARISS Coordinator Tony Hutchison VK5ZAI in June 2005, seeking inclusion in the ARISS program, and then followed the normal routine of applying and addressing preliminary requirements. We could not believe our good fortune when, on January 31, Tony sent us a message offering a possible contact with the ISS in early March. We had anticipated several more months for preparation, but with the expert guidance from our mentor Tony VK5ZAI, all preparations went quickly and smoothly ahead.

In late February, Tony advised that the scheduled contact had been deferred and that they were working on providing another date. We were a little concerned

as the time was drawing very close for the ARISS crew to return to earth, and contacts were rarely made during the last weeks of an expedition. But our fears dissipated when Tony came back to us with the offer of a contact in the last week in March, actually Friday 31st – an offer quickly accepted as it still gave the school and NERG adequate time to prepare.

The prospect of the contact had created quite a deal of local media interest. Details of the planned contact were reported, complete with photos, in our local newspapers throughout February. We did not expect any media attention mid-March, as Melbourne was in the midst of hosting the Commonwealth Games. Nevertheless, to our surprise, and through the hard work of our Publicity Officer John Kent VK3BIZ, Natalie Will, the Briar Hill teacher in charge of the event,

**Was it worthwhile? If you could see the children's faces at various times during the contact, and after, when John VK3ZRV presented each their "Participation Award", you would not need to ask.**

was interviewed on the Star Stuff science program on ABC's News Radio, broadcast nationwide. The interview was replayed on two later occasions.

This was followed by another radio interview on our local community radio station. The interviews were a credit to Natalie, adding solid support to all involved.

With the date set, final preparations

## Australian made ANTENNAS Setting a new standard COM-AN- TENA

(formerly a j and j coman)

23 cm 36 ele slot fed yagi beam	\$190
2 ele delta loop 10/11 metre	\$249
2 ele quad 10/11 metre	\$249
10/11 beams comp opt 5 ele	\$327
10/11 5/8 vert 4 rad 1/4 wave	\$185
Tri band IIB 35 C 10/15/20 m	\$745
3 ele 20 m comp opt	\$460
log periodic 9 ele 13 30 8.4 boom	\$990
MBV 6-12-15-17-20-40-80	\$390
40 m linear loaded 2 ele beam	\$595
M B Vert auto switch 10/80 m	\$330
6 m 7 ele yagi beam 60 mm boom	\$387
6 m 5 ele comptr opt beam	\$275
Top loaded 160 m vert	\$430
10 ele high gain 2 m 3.9 m boom	\$149
17 ele high gain 70 cm 3m boom	\$129
Rotable dipole 40 m	\$250
80 m top loaded vertical	\$239
dual band 2 m & 70 vert	\$140

### Guyed Masts

**21 metres**                      **13 metres**  
Winch-up & tilt-over. Aluminium and stainless steel  
three-sided construction. Auto-brake winches.

### Free Standing Masts 9.5 metres

**New Baluns**  
1-1 to 16-1 to 3kW



Our Masts meet Australian Standards. We supply all the computations and data you will need for a permit.

**03 9773 3271**  
**Mob: 0419 542 437**



Natalie Will and Don Haslam VK3KDT prepare for the event

The room quietened and everyone listened intently. Tony VK5ZAI called up NA1SS and a sigh of relief was heard through all assembled in the hall as Bill NA1SS responded, loud and clear. Wonderful! After a very brief introduction from Tony we are up and away, Sam leading off with the first question. Bill's reply was immediate and very audible.

The students each in turn asked their question and listened to Bill's reply and to our amazement and gratitude, both to Bill's timing and Tony's prompting, we actually managed to have all 22 questions asked and answered. At 8.12 pm, acknowledgements were made to all in the ARISS team, and Tony, for providing an excellent contact. The night culminated with the presentation of a very nice "Certificate of Participation" as a memento of their special night to each pupil by John VK3ZRV. A light supper then followed.

During the following weeks, Jack VK3WWW spent hours editing and preparing 2 DVD's of the occasion, one solely for school use and another better suited for Amateur Radio. They are of exceptional workmanship and quality and are likely to be used internationally by the ARISS team. Likewise, Grant VK3HFS put in hours to produce an excellent audio CD of the event and has included very informative interviews with the students, parents and other dignitaries who attended. Their comments on the value of having such an event are worth hearing and add to the pleasure of those who helped provide the contact.

Was it worthwhile? If you could see the children's faces at various times during the contact, and after, when John VK3ZRV presented each their "Participation Award", you would not need to ask. Oh, and yes, it has created a greater awareness of amateur radio within the community.

Our sincere thanks to Astronaut Bill McArthur on board the ISS, Natalie Will from Briar Hill Primary School, all the hard working people in ARISS, to Tony VK5ZAI, Greg VK3VT, John VK3ZRV, Mark VK3BYY, John VK3BIZ, David VK3THY, Grant VK3HFS, Jack VK3WWW, and others who made the night one that everyone will always remember.

To any VK amateur radio club, I highly recommend you select a local school, and arrange a contact. It is fun – and shows amateur radio in a very positive aspect.

ar

began. Tony VK5ZAI was to ship off to the NERG a very sturdy Telebridge unit for us to use, and Natalie, with assistance from NERG President Greg Williams VK3VT and NERG Secretary John Weir VK3ZRV, rehearsed the questions to be put to the ARISS crew. The children's excitement was obvious; we had 22 participants, all armed with questions for Bill McArthur, the ISS commander – and they were ready.

Why a Telebridge? Good question! ARISS and NASA are keen for every public contact with the space station to present a positive outcome. We didn't feel that we had enough experience with satellite and ISS communications to guarantee a direct contact, and chose the Telebridge option. Telebridge uses a telephone link from the school to an ARISS ground station for a high reliability link to the ISS. In this case, we linked to Tony's well-equipped and proven amateur satellite station.

The NERG duly received the Telebridge, and carried out several trials to ensure all was in readiness. There were no problems - it was felt this was going to be an easy affair, given the preparation.

Tony had provided a time schedule of what we could expect, starting with the "live" phone call beginning 30 minutes prior to the actual contact. He advised allowable contact time was to be a maximum 8 minutes, as he had only 15 degrees elevation on the scheduled ISS pass. The pupils were advised, and

accepted, that due to time constraints only half of them might be able to ask their question.

Friday March 31 arrived.

The NERG crew, with Grant Stowell VK3HFS, Jack Bramham VK3WWW and others, arrived at Briar Hill Primary school at 6.00 pm to set up the Telebridge, amplification system and video equipment. Final tests were carried out and all was well. No worries!

By 7.15 pm, the assembly room was full of excited children and expectant parents, plus Banyule Mayor Wayne Phillips, a State Government representative, and others. In all, we had 100 people all eager to witness the contact.

At 7.30 pm, the much-awaited call comes into the Telebridge. We answer the phone but cannot hear anyone talking - still not a problem as Tony had provided clear instructions on how to best adjust both microphone and audio volume. All normal adjustments were made but still no useable audio. Murphy's Law had struck once again!

For the next 20 minutes we had electronic experts Grant VK3HFS, Mark VK3BYY and John VK3ZRV all working frantically to resolve the problem. Finally, with approximately 6 minutes left to the scheduled contact time, we were able to obtain enough audio to be heard throughout the room, not the best by any means but sufficient for the night to be the success all had hoped.

The formal contact began at 7.55 pm.



# Magneto-ionic holes: Is your antenna coupling well into the ionosphere?

Robert R Brown NM7M

The phenomenon of 'power coupling' is one that is relatively little known by radio amateurs. Simply put, power coupling is how well the RF waves propagated by a transmit antenna used on the 1.5 to 30 MHz spectrum 'couple' into the ionosphere.

In some parts of the world, such as large parts of Australia, Asia and Africa, horizontal polarisation of antennas offers optimum power coupling, while in others, such as the United States of America, vertical polarised antennas provide the optimum [1].

An important factor affecting whether vertical or horizontal antenna polarisation will provide optimum power coupling is the geomagnetic latitude of a particular station location. Geomagnetic latitudes are different from geographical latitudes, as the magnetic North and South Poles are located in different places from the geographic North and South Poles, with which we are more familiar.

Mercator projection world maps that show geomagnetic latitudes are presented in some specialised books – a small map of this kind is shown on page 1-25 of ON4UN's Low-Band DXing book. The use of optimum power coupling methods to enhance propagation began in 1965 with the work of two broadcast engineers, Philips and Knight [2], who were dealing with medium frequency (i.e. 1.5 to 5 MHz) communication problems.

As I worked extensively in Australia before retiring from my work as a professor of physics, I thought it would be of interest to let my fellow amateurs 'down under' know how power coupling may affect their activities on the HF spectrum.

I recently wrote an article for the US-based Low Band Monitor magazine [3] about the effect of magneto-ionic power coupling loss on low-band DXing. In this article, two widely separated examples of power coupling were given - one for the use of vertical antennas at an equatorial latitude (i.e. close to the equator), and the other for the use of a horizontal dipole antenna in the USA.

Those two examples showed the effects of power coupling that resulted from the

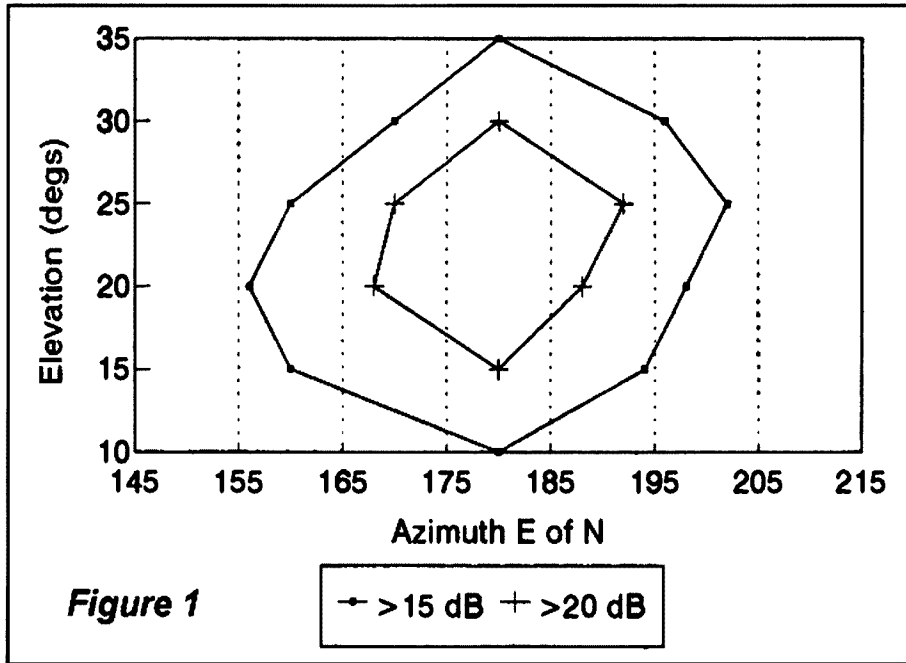

Figure 1 – Magneto-ionic hole: Power coupling losses with horizontal polarisation at 1.8 MHz, southwards from Sydney, NSW.

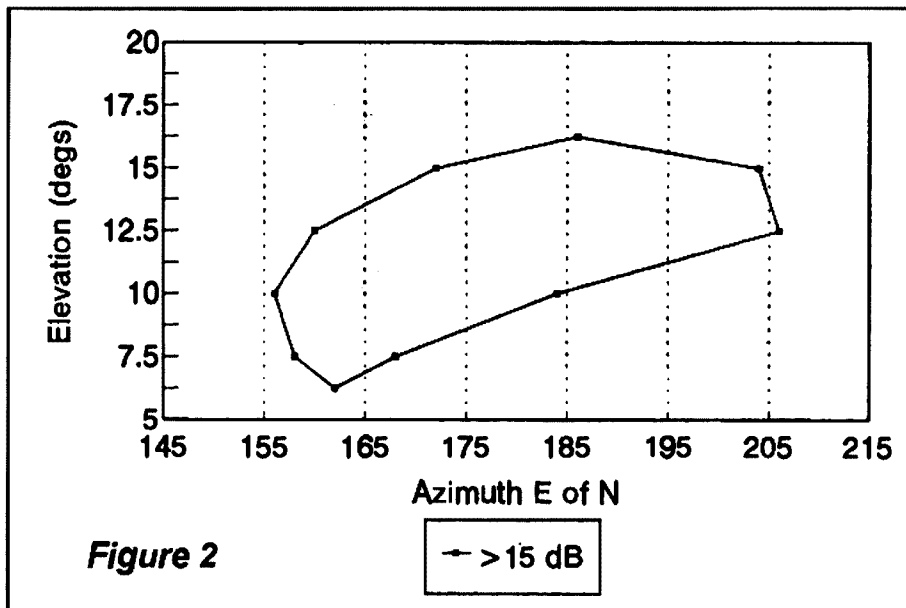

Figure 2 – Magneto-ionic hole: Power coupling losses with horizontal polarisation at 7.0 MHz, southwards from Hobart, Tasmania.



Photo 1 - Steve VK6VZ (pictured with his two children, Hannah and Sam) regularly works DX on 160 m.

use of these particular antennas at these particular locations, but did not reveal the full extent or nature of the problem of signal losses that result from non-optimum power coupling.

In the article you are reading, I have extended the treatment of power coupling in order to show in dramatic terms the full extent of the signal-loss problem that is present with power coupling - signal loss from what are termed "magneto-ionic holes" in the ionosphere. To start with, I need to take you back to the kind of

things you learn about in high school physics lessons.

Another way of looking at power coupling is that it is concerned with the polarisation effects that result when signals are sent through an ionosphere immersed in our geomagnetic field.

In many ways, these radio wave polarisation effects resemble the behaviour of polarised light in optical physics. A radio transmitter is the source of signals, then the magnetic field in the ionosphere polarises the waves and the

intensity of received signals depends on the orientation of the analyser - a receiving antenna - relative to the field of the polariser.

The degree and the type of polarisation both depend upon the path-field geometry of waves that are incident on the polariser. If the axis of the polariser and the axis of the analyser are 'crossed', zero transmission through the system, or full extinction, results in the case where the polariser creates linearly polarised signals (eg. from the Law of Malus in optics).

If the polariser yields elliptically polarised signals (where one axis of polarisation is partially suppressed whilst the other is relatively unattenuated), a minimised received signal results, even when the analyser is oriented for maximum rejection.

For amateur radio problems, I developed a computer modelling method in 1998 [4] to explore these matters using either vertical or horizontal antennas and the features of the geomagnetic field ('strength', 'dip' and 'declination') at any location as given by the International Geomagnetic Reference Field [5].

The parameter of 'dip' is one with which many people may be unfamiliar - this is the angle a horizontally pivoted compass needle makes with the horizon. For example, in Australia, the compass points up at an angle of about 65 degrees, showing the direction of the earth's magnetic field at that location.

The 1.8 MHz amateur band, in which I have a special interest, is one where the effects of power coupling can be particularly severe. My computer modelling showed a quite significant power coupling loss for the east to west transmission of vertically polarised signals from the country of Togo, West Africa (7N, 1W), in which there was a radio amateur who was interested in 160 m DXing.

Modelling also showed significant power coupling loss for horizontally polarised signals going north toward the polar cap from Minneapolis, Minnesota (45N, 93W), where there are a number of active 160 m operators. A signal angle of 15 degrees above the horizon was chosen because the magnetic dip is 73 degrees, thus putting the signals going north nearly perpendicular to the field lines.

However, these were only limited results from two 'spot' calculations. At this time of the sunspot minimum, where many radio amateurs are turning to our

**NOVA SCOTIA, CANADA**  
HALIFAX COUNTY

VE1ZZ

VK6VZ

13 JAN 95

UTC	MHz	RST	2-WAY
2.131	1.8	559	CW

JOHN (JACK) LEAHY *Leahy*  
RR2 Head Jeddore  
Halifax Co, Nova Scotia  
CANADA B0J 1P0

A WAMPY OSL      RSE OSL      B1HX OSL

Photo 2 - VK6HD and VK6VZ have been working VE1ZZ (QSL card pictured) for many years on 160 m.

lowest amateur band of 1.8 MHz, I would now like to present some more complete results for this band for a number of sites in Australia, over ranges of elevation angles and azimuths of propagation.

The first site I will look at is the major population centre of Sydney, for which the elevation angle of signals was swept from 10 to 35 degrees, while the azimuth ranged 155 to 205 degrees east of north (ie. +/- 25 degrees about due south).

From data points, the limits of azimuth and elevation within which power coupling losses were greater than 15 dB and greater than 20 dB, respectively, are shown in Figure 1. The lack of symmetry of the curves about due south is due to the declination of the geomagnetic field at Sydney.

For Sydney, the dip is -64.5 degrees and Figure 1 shows that a huge portion of the southern ionosphere would not propagate signals very effectively in the general direction of the South Pole when transmitting at about 23 degrees elevation, which is approximately perpendicular to the geomagnetic field. Those results were for the case of horizontal polarisation of signals to the south and I believe they give proof for "magneto-ionic holes in the ionosphere".

Different results are found toward the north from Sydney, where, over the same range in elevation angles, the power coupling loss is only five to six dB. This is because signals for northern azimuths are predominantly elliptically polarised, as compared to almost linear polarisation for southern azimuths.

From a magnetic dip chart [6], you can find sites in the USA with dip latitudes as low as +60 degrees. Over Australia, dip latitudes are lower, down to -40 degrees around Darwin. That being the case, magneto-ionic hole patterns such as those shown in Figure 1 are centred at higher radiation angles for Australia - almost 50 degrees at Darwin. The greatest dip angles are found in Tasmania, the dip at Hobart reaching -73 degrees. The magneto-ionic hole pattern for Hobart on 1.8 MHz resembles that at Sydney in all respects, except it is centred on a lower radiation angle of about 13 degrees.

Such high angles generally have no value for long distance low-band DX contacts, owing to suffering heavy ground losses and D-region absorption with many hops. However, Australian 160 m operators such as my friends VK6HD and VK6VZ (see Photo 1) have had

great success working long-distance DX (see Photo 2) using inverted vee dipole antennas at less than a quarter wavelength in height above the ground. With such antennas the major radiation occurs at over 50 degrees and is of the "cloud warming" type.

However, power coupling problems on 1.8 MHz are not the whole story with regard to magneto-ionic holes in the ionosphere. The higher DX bands have to be considered too, as computer modelling work I carried out in 2005 showed the presence of magneto-ionic effects at 7 MHz and 28 MHz.

As a result, I have carried out computer modelling for horizontal polarisation for the higher dip latitude at Hobart using 7 MHz and 14 MHz signals. In this case, the elevation angles were lower for losses greater than 15 dB on 7 MHz, as shown in Figure 2. Again, the lack of symmetry of the curve about due south is due to the declination of the magnetic field at Hobart.

On 14 MHz, the elevation range for losses greater than 15 dB is even narrower - from 10 to 12 degrees - but the azimuthal range is about the same as on 7 MHz. The latter is due to the high field strength - 59,000 nT at Hobart. At low latitudes, the field strength is about 30,000 nT and power coupling loss regions are narrower in azimuth.

In conclusion, the theory of magneto-ionic holes in the ionosphere rests on the reciprocity of ionospheric paths and the limiting signal polarisations [7] that can leave or enter the bottom of the ionosphere. As such, they depend on the antenna polarisation involved and signal direction relative to the geomagnetic field.

Since the ionosphere is always immersed in the Earth's magnetic field, the potential absorption effects of magneto-ionic holes are always present. In practice, they are present everywhere, across both hemispheres, giving rise to background signal losses, but especially when trying to work pole-wards from mid-latitudes with horizontal polarisation. In contrast, the absorption effects from auroral activity come and go at high latitudes.

Magneto-ionic holes are smaller in size on the higher frequency bands, a fact that should be of some aid and comfort to 14 MHz DXers 'down under' who use horizontally polarised antennas.

## References

- [1] Devoldere, J, ON4UN's Lowband DXing, 2nd edition, 1999, page 1-24.
- [2] Philips, G.J. and P. Knight, Effects of polarization on medium frequency sky-wave service, Proc. I.E.E., Vol. 112, 1965.
- [3] Brown, R.R., The Lorenz Force Law, Low Band Monitor, Nov 2005.
- [4] Brown, R.R., Demography, DXpeditions and Magneto-Ionic Theory, DX Magazine, March/April 1998.
- [5] International Geomagnetic Reference Field, Utility Programs for Geomagnetic Fields, NGDC, Boulder, CO, 1995.
- [6] Oler, C., PropLab Pro, A High Frequency Radio Propagation Laboratory, Solar Terrestrial Dispatch, Canada 1994.
- [7] Davies, K., Ionospheric Radio, Peter Perigrinus Ltd, London, 1989.

ar

---

## As amateur numbers grow, so does the WIA

As we have read in the WIA comment/news section, we can see that the number of licensed amateurs in Australia is currently growing - a large turn around from previous years. It is clear that a significant part of this growth is the result of the new entry point - the Foundation Licence, introduced last October.

Our WIA has also been experiencing positive growth with a huge influx of new members: last month 77 Amateurs showed their support by joining. If you haven't yet become a member, there's never been a better time than now.

### Member benefits

As a member, you will receive AR monthly in your letterbox, your own WIA email address, member's prices at the WIA Bookshop, free access to the WIA QSL bureaux, plus all the other benefits of WIA membership.

In addition, for the next month, the first 100 people to join will also get a copy of the WIA Callbook absolutely free.

ar

# Aircraft enhancement

## A project beginning almost 50 years ago

Don Heberecht VK2RS

During the Geophysical Year way back in 1957/58, together with well known two metre operators VK3RK, VK3BQ and others, we conducted a regular schedule during the evenings for 364 days on 144 MHz (AM or CW) from Albury NSW to Melbourne as part of the Geophysical Study conducted by a Victorian University.

Contact was established on each of the 364 days by aircraft enhancement at about the midpoint of the flight path for a period that varied from a few minutes to 10 minutes or so.

The antennas used were phased arrays of 16 to 24 elements. Mine was 16 elements at 15 metres and constructed from 12 gauge fencing wire!

Yagis were originally tried but the wider captive capabilities of phased arrays gave a longer and more reliable period at the expense of some forward gain. I do recall one installation of a four bay five element stacked array installation

that gave comparable opening periods. (Long Yagis as we know them today were not popular then).

Whatever happened to the data from this experiment is unknown to me. I guess it is stored in the archives of the particular University that initiated the study.

What it did do, however, was to raise a number of questions in respect to the predictability of future aircraft enhanced transmission and reception: what would happen as aircraft changed, would there be impediments or limitations that precluded the potential to develop the possibilities, and could there be medium

change through pollution or natural phenomena properties; indeed a study for later on...when I retire.

Recently I retired and moved to Corryong in North Eastern Victoria, a few kilometres from the NSW border and in the shadow of the Snowy Mountains.

This location has little potential for VHF communication with the possible exception being in a westerly direction. However, it does have a unique resource. The Sydney to Melbourne Flight Path is directly above the town and closely follows the Valley topography.

The parallel return path is a few



# TET-EMTRON

## Antenna Manufacturers

### New Tet-Emtron Vertical Range Features

- All Aluminium with Stainless steel hardware.
- No adjustment needed to main antenna.
- Light.
- Free standing-no guy wires.
- 1 kW PEP power rating.
- Can be ground mounted or elevated.

The new TET-Emtron Vertical range is designed with ease of use in mind. Tuning is done by the radials when the antenna is in its final position (where possible). The radials can either lay on the ground, be buried or hang from the elevated antenna. The antenna comes

### New

#### Tet-Emtron Vertical Range

TEV-4
TEV-3
TEV-3Warc

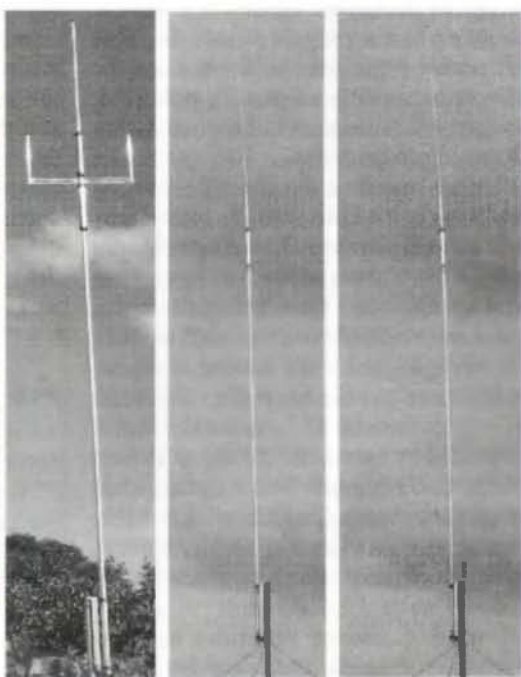

40 Blackburn Street  
STRATFORD  
Victoria 3862 AUSTRALIA

Ph: 61 3 5145 6179  
Fax: 61 3 5145 6821  
ABN: 87404541761

#### Specifications

Antenna	TEV-4	TEV-3	TEV-3 Warc
FREQUENCY	7, 14, 21, 28 MHz	14, 21, 28 MHz	10, 18, 24 MHz
ELEMENT HEIGHT	4090 mm	3800 mm	5025 mm
IMPEDANCE	50 OHM	50 OHM	50 OHM
MAX. RADIAL LENGTH	10.7 Meters	5 Meters	7.5 Meters

[www.tet-emtron.com](http://www.tet-emtron.com)

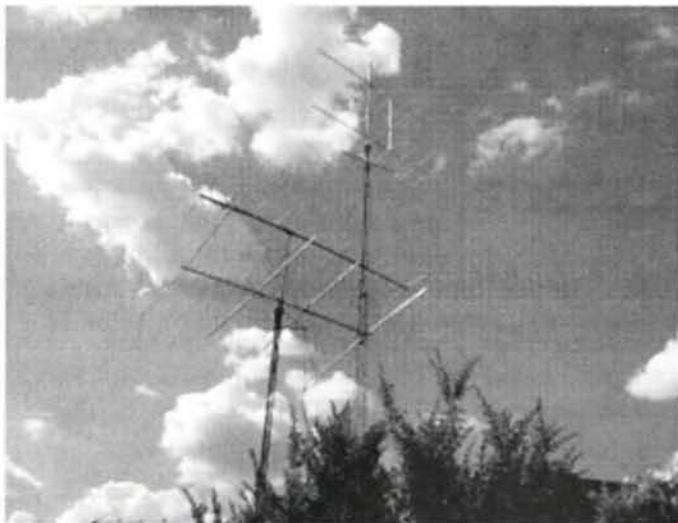

Photo 1 – The pair of stacked nine element Yagis at 1.5 metre separation and horizontally polarised at a mean height of 18 metres

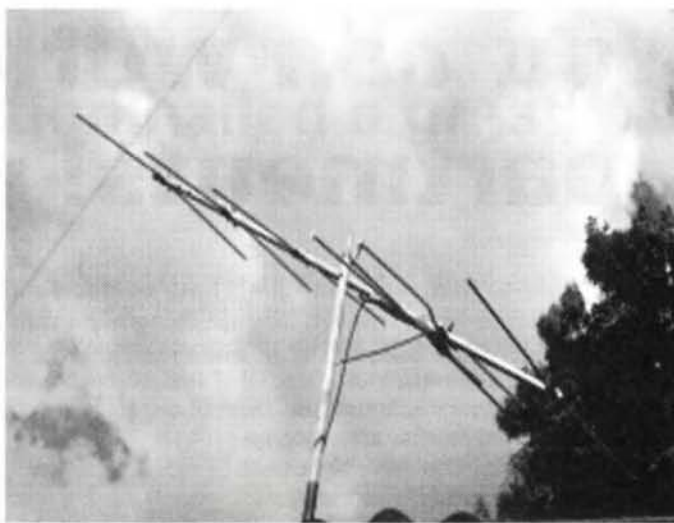

Photo 2 – The north AE fixed five element Yagi at 45 degrees.

kilometres to the west and outside the Valley.

In recalling the experiments of earlier days, I was mindful of the legacy of this unfinished project. Encouraged by well-known VHF enthusiasts, Ian VK1BG and Chris VK2DO, it was decided to investigate the potential of utilising the overhead Sydney to Melbourne flight path.

The equipment used included two, fixed five element Yagis, one to the northern section of the path at 45 degrees, the other on the southern section also at 45degrees, both horizontally polarised and centred at about three metres above ground.

A 12 element fixed phased array is mounted just above the house roof looking at the sky and covering the 30 degrees or so about the vertical, thus attempting to fill the gap between the north and south tilted antennas.

A pair of stacked nine element Yagis at 1.5 metre separation and horizontally polarised at the mean height of 18 metres (rotary) serve as the station antennae.

One nine element long Yagi on a separate tower at about 10 metres with rotator is used as a standby when coupled to an Icom IC-271A Transceiver. The transmitted power output is a nominal 100 watts (Kenwood TS-2000).

I have written an application in Microsoft Access which records stations that I have heard against the four antennas with reference to date, time, signal strength peak, temperature, barometric pressure, sunny, cloudy, wet, dry, and

solar level (as received by the vertical phased array mounted on the roof and looking towards the sky).

All of these measures intended as general “layman’s” observations that may be of value in the final evaluation. The observation usually involves three readings of each antenna where possible and records the maximum signal strength received. Often, however, the opening is too short in time to allow this.

In the first month of operation, there have been 170 loggings, which include the north, south and vertical loggings as well as the direct path.

What has been surprising is that frequently the vertical antenna (phased array which I will call the “scatter” antenna) hears openings that appear on any of the other antennas, and generally for a longer time, when compared with the north and south tilted aerials. This without the usual peaks and troughs and short bursts associated with aircraft enhancement and appears to be independent of aircraft schedules.

I find myself automatically monitoring with the “scatter” antenna to determine the direction of the incoming signal before directing the horizontal array.

This has been an unexpected phenomenon for which I have no explanation and, in effort to gain a better understanding, I have sought advice through the Internet VHF group, challenging others in both country and city to replicate the experience by recording what is heard at their location when you point the antenna skyward.

By way of interest, in the first sample period for the month of January and part of February 2006 there has been 427 “S” points of data logged on the direct route, 49 points on the north AE antenna, 98 points on the south AE antenna and 157 points on the “scatter” antenna pointed skyward.

It is still far too early to draw any serious conclusions, but already there are some interesting data trends that may indicate that at the end of the year-long study there may well be, in “layman’s” terms, some factors or properties overlooked in determining current aircraft enhancement considerations.

Therefore, in 2007, exactly fifty years on, I would hope to provide some answers to satisfy a young man’s curiosity or an older man’s dilemma.

ar

[www.pca.cc](http://www.pca.cc)

Email from anywhere

via Winlink

2000

Use PACTOR-3

on HF to send  
Mail, Grib Weather,  
Weatherfax & Images

Contact [marc@pca.cc](mailto:marc@pca.cc)  
Sydney 02 8902 0107

# You *can* work DX from apartments!

Ira Lipton WA2OAX

**Since moving to Manhattan in 1994, I have contacted 310 DXCC entities from two different apartment locations. I have decided to write this article describing my antennas to encourage others who may feel that they must abandon chasing DX because of antenna restrictions.**

I arrived at the final configurations of my antenna arrangements after poring over many articles that have appeared in the amateur literature over the years, regarding mobile whips, ground losses, and coil design, etc, and LOTS of experimentation. I have been very surprised at the performance differences even slight changes can make in the system.

I must admit that my first apartment was chosen with radio in mind. I rented an apartment on the top (19th) floor of a building. The unit faced north and provided clear paths from east to west with few buildings obstructing the view (the most challenging DX paths from the northeastern US run from 90 degrees to 270 degrees on the great circle chart). The apartment also had a 3 by 12 foot terrace with a large railing that did not seem to be tied to the building's steel framework.

Once I conquered my fear of working on the terrace, and peering over the edge at about 190 feet from terra firma, I obtained an approximately 2 foot square ½ inch steel plate (heavy) and had a pipe flange welded to it close to one corner. A 5 ft length of 1½-inch pipe was threaded into the flange for a mast (a small section of slightly larger diameter pipe was slipped over the top of the mast and welded in place for a bit more secure clamping surface for the antenna). The steel plate and mast were placed at one corner of the terrace.

A large ¼-inch aluminium plate was fitted with u-bolts at one end to attach to the mast. A heavy-duty (cast) mobile ball mount was fitted to the other end of the plate. I was ultimately able to securely attach a 2 foot long stainless steel mast, a large silver plated loading coil, and an 8 foot "whip" configured from aircraft grade aluminium tubing (total length 12 feet) to the mobile mount.

The antenna was mounted horizontally and could be swung out 90 degrees from



Photo 1 – Ira WA2OAX standing on the balcony with the loaded whip swung out into the operating position.  
(Photo by Bill VK3BR)

the building. A nylon safety rope was attached to the supporting pipe and the antenna just in case my calculations were incorrect! There were never any mechanical failures in eight years of operation. Of course, the antenna was safely tucked back into the confines of terrace when not in use.

Now for the electrical details: Experiments at another apartment location in the 1970s showed that the whip antenna worked much better in the horizontal position, and as far away from the walls of the building as possible (ie at a 90 degree angle). I leave the explanation for the improved performance to my more sophisticated engineering colleagues, but I assume this placement minimises interaction with the building's steel framework. A 20 dB or so improvement in received and transmitted signals was evident on all bands when the antenna was rotated out from the confines of the terrace.

The antenna counterpoise required considerable experimentation. I attached varying lengths of well insulated (3,000 volt) wire to the ground (braid) connection at the ball mount with solid copper clips. It was difficult to predict the ultimate optimal length of wire for any given band because of the effect of all the metal on the terrace and the proximity of the building. As you would expect from minimising ground losses, the best performance, both receive and transmit, occurred when the radials were tuned for minimum SWR bandwidth.

Optimum performance was obtained on the lower bands (80 and 40) metres when the large diameter aluminium terrace railing was used as a counterpoise.

The performance of this system was, at times, astounding even on the lower bands. A computer-generated plot of the vertical pattern provided for me by NE2Q was impressive. On one occasion, I was able to work JA3CZY on 80 metre SSB

with S9 signals both ways (no mean feat from the east coast of the US, even with a full sized antenna).

After purchasing a hilltop location in the country a few years ago, I decided to rent a less insanely expensive apartment in Manhattan, this time without a terrace and facing south. I reasoned that, with the availability of large directional antennas in the country, and virtually no ambient noise or problematic neighbours on the weekends, why would I need to operate from the city during the week? This resolve lasted approximately three months.

Realising that the management at the new building would probably be less sympathetic to radio antennas, I attempted to use various indoor antenna configurations. The results were disappointing. I then purchased an MFJ base loaded whip supplied with a bracket that could be clamped onto a window.

Things were starting to look better. I was able to hear and work some DX, but it was a struggle even running about 400 watts output from a small Ameritron amplifier. There was evidence of considerable RF coupling back to the equipment. The antenna bracket placed the base loading coil adjacent to the framework of the building and, by necessity; the counterpoise wire was run back into the apartment along a windowsill.

After considerable head scratching, I decided to place my old two-foot long stainless steel mast on the MFJ antenna bracket, then screw the base coil onto the mast. This arrangement effectively places the base of the antenna two feet from the building. I then wound most of a 16-foot length of 3,000-volt wire onto the mast to act as a counterpoise. The remainder was left dangling into the apartment.

The improvement has been dramatic. Signals, both receive and transmit, average two S units louder on all bands (40 through 10 metres). In a little over a year of sporadic operation I have worked 144 countries with the little antenna (including FT5XO and 3Y0X), but who is counting?

Of course, one must exercise a bit of discretion. The antenna is placed out the window only under the cover of darkness, or early on Sunday morning (as Manhattanites do not usually see the light of day until noon on Sunday.)

ar

# Marconi centenary celebration hailed a great success

Ron Churcher VK7RN

**The tumult and the shouting has just about died but this successful co-operative venture between the Geelong and the Tasmanian North-West radio clubs, will be remembered for a long time. It certainly wasn't a simple thing to set-up but the result fully justified the hours of organization on both sides of the Strait.**

Hundreds of QSL cards have been made out and the ones not required to be posted are in the QSL bureau. We were very fortunate to have commercial help with Icom Australia loaning us one of their brilliant Icom IC-7000 transceivers – we would recommend this set to anyone needing an all band set. Moonraker Antennas in Hobart loaned us the required HF antennas. We must thank these two companies for their co-operation. We learnt a couple of lessons -- One – when transmitting using all band verticals and long wires with open wire feeders (non-coax), don't expect to use computers etc. within 50 feet! and Two – when working in an exhibition hall with lots of 12 volt lighting (split-mode transformers) expect strength five noise.

One disappointment – We had a scheduled schools chat with the space station astronauts on the Thursday

(13th.) but with the delayed space shuttle docked at the space station this had to be postponed. It is now on Friday, 18th August. However, the twenty students from our two main high schools are still all fired up.

One big highlight – the success of our Marconi centenary 24-page booklet – a reprint of the original Marconi 1906 brochure plus a report of the actual 1906 proceedings. Orders for this have come from around the world. An interesting aspect is the way some radio clubs have ordered multiple copies for their members. At \$6.00 posted, it is a very cheap but valuable historical document. We still have some copies left so it's "first up – best dressed". When they are gone – that is it. Order yours at Marconi Centenary, 177 Best St., Devonport, Tasmania 7310.

ar

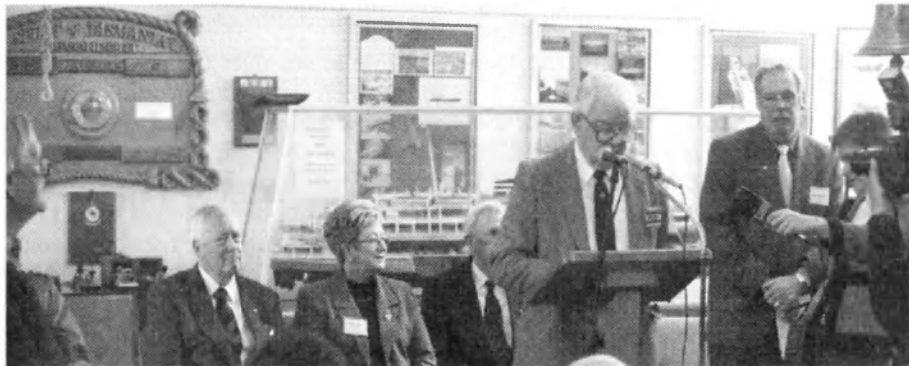

Barry VK7FR reads overseas greetings in Devonport



The crowd at Queenscliff

# Adventures with a hand-held

Rob McKnight VK2MT  
mcknightr@winns.com.au

Always have your handheld in your pocket, you just never know what opportunities may arise!

**My family had always wanted to go on a cruise, so after much saving and close scrutiny of island destinations, a 10-day cruise to the South Pacific Islands of Vanuatu and New Caledonia was finally booked over the last Christmas period.**

The 30 years of interest that I have had in radio has always revolved around propagation characteristics, whether they be via skywave or groundwave. As much as the relaxation side of the cruise was welcome, the opportunity to perhaps also “play radio” and see what propagation characteristics would be encountered, with thousands of kilometres of water and little or no man-made noise, was something rather intriguing.

As well as packing all the usual tourist paraphernalia, several radio items were taken along: a MW/SW/FM broadcast band radio, VX-7R handheld and charger, GPS, small earphone, list of Australian Amateur repeaters, log book, small LED torch (you just don’t know what your operating situation might be!), copy of my Amateur Licence. Of course, I also packed all the relevant licensing documentation needed for the only country that we were visiting that had Reciprocal Licensing with Australia, that being New Caledonia.

The broadcast band radio was for the aforementioned interest in propagation for the various bands while surrounded by water. The handheld was to see how far the Australian VHF and UHF repeaters would reach out to sea, and to use it via the Noumea FK8ZHA 2 m repeater, a repeater I had often accessed previously from back home in Wollongong.

Before the ship’s departure from Sydney at 7 pm, I quickly sought approval with the ship’s Radio Officer to use my handheld while on-board. After a very pleasant chat, approval was granted. As we exited the heads of Sydney Harbour, I made easy contact with friends via the VK2RMP 6850 repeater.

Later on, as we enjoyed the first of many fantastic 5-course dinners, the ship tracked closely to the NSW north coast

until just past Coffs Harbour. It then headed out to open sea on a NE tack towards the islands of New Caledonia. Repeaters from Gosford to Lismore were all accessible until we were well out to sea, the last repeater being accessible was V K 2 R C H 6650 at Coffs when about 150 km from the coast.

While at sea over the next few days, in between partaking in the shipboard activities and the vast array and huge amount of food on offer, I regularly grabbed the broadcast radio and went for a wander to two different spots I had found offered the best radio positions. These were the large viewing area located above the bridge on Deck 10, or on Deck 11 mid-ship, above the main pool and waterslide.

Deck 10 was great for stations in front of the ship, but often suffered from high wind and also some radar desensing on some of the broadcast frequencies. Deck 11 was my favoured position, as it was more sheltered, closer to the bar and also provided far more alternative viewing around the pool area when the bands were dead!

The MW band was as expected. During the day, despite the noise floor being



Photo 1 – VK2MT and VX-7R on board the Pacific Sun with Noumea in the background.

very low (almost non-existent), the band was almost dead with only a couple of very weak, unidentifiable stations fading slowly in and out. Of course, during the night the band absolutely came alive, with stations from Australia, New Zealand, New Caledonia (easy to identify because of the French language) and even a few stations from Hawaii. Because of the low noise floor, listening was an absolute pleasure even on such a small radio, with minimal signal fade, no crackle or static, just lots of signals.

The FM band was a surprise though. I expected a “dead band” while out at sea, but surprisingly, not once during the entire 10 days did I not hear at least 5 to 10 stations coming in. Even 1,000 km from land, there were always many stations to be heard both day and night. Gold Coast was the main area of transmission heard, but I also heard stations from Cairns, Port Macquarie, Newcastle and even



Batemans Bay. In the other direction, French-speaking stations from New Caledonia were heard more than a day and a half before reaching the area.

About midnight on the second night, while still around 500 km from Noumea, I was able to easily trigger the FK8ZHA repeater, but being late, my calls went unanswered. Something to keep in mind, this repeater on 146.800 MHz appears to require audio to trigger it successfully, not just a carrier, something I wish I had known when trying to access it earlier.

For the next 7 days, we enjoyed the beautiful Isle of Pines, the duty-free shopping of Vila and the spectacular snorkelling and seclusion of Lifou.

On Christmas Eve morning, we arrived in Noumea Harbour and while my wife and younger children went for a plane ride over the city, my eldest son and I hired a motor scooter for two hours to explore the city at ground level.

The art of keeping to the right hand side of the road tended to come naturally when you are one of the smallest road users (I suspect it was self-preservation kicking in!). Some big roundabouts that were several lanes wide proved to be a bigger challenge: one instance requiring us to go around three times before being able to get off!

About half an hour into our ride I noticed a sign pointing to what I figured was a lookout, my high school French being of no help deciphering the sign's words but the little camera icon being a giveaway, although it could well have been pointing to a camera shop.

The road led to a hilltop that was over 350 m high and provided a majestic 360-degree view of Noumea and obviously must have afforded some past strategic military advantage as there were a couple of large old cannons on top as well.

After taking the necessary tourist photos of the city and the aqua blue bays to the north, I pulled out the VX-7R, which I had almost forgotten I had put in my shorts pocket hours earlier, and put a call out on the local FK8ZHA 2 m repeater.

My calls once again resulted in no replies, maybe this time it was my very poor attempt at a French accent, so I aimlessly "kerchunked" a few repeater frequencies just for the hell of it. To my surprise, a few repeater tails came back on 6700, 6925 and 6950. At first, I just assumed they were just some repeaters located elsewhere in the island's region;

after all, I was on top of a high hill.

I then came across an English speaking conversation on 7075. I figured they were probably just a couple of Aussie tourists in the area. When they announced their VK4 callsigns, minus the "portable FK8" suffix, my excitement rose considerably.

Not expecting to be able to access this apparent VK4 repeater, I pessimistically put a call in between their overs, to which they immediately replied. Still not being totally convinced and not wishing to embarrass myself, I cautiously asked their location to which they replied - Brisbane. They in turn asked me my location.

Here was one of those rare moments ..... what would you say? You are standing in a foreign country, exposed to some very unusual radio conditions, using a handheld radio and accessing a repeater around 1,500 km away! So I calmly (not) replied, explaining my location and circumstance, to which after initial disbelief and questioning, they believed.

Over the next half an hour, from 11.05 am, I enjoyed a great conversation with VK4IBR and VK4KOR on the VK4RAX Brisbane repeater. We could even hear each other's input signals, so we went to 146.500 MHz for a simplex contact. VK4RAX's signal strength varied between S5 and S9, with the direct signals being



Photo 2 - The old and the new - a traditional island hut with a satellite dish.

between S3 and S7. During this time, my son took a photo of myself (complete with my big grin) and using the digital camera's movie mode, I recorded parts of the conversations to both prove the contact and for my own record.

Despite continuing good conditions, all too soon we had to leave to return the scooter to the hire place. On the way back, still being in a state of disbelief and excitement, we took a wrong turn and got quite lost, eventually finding our way back to the harbour with the help of some friendly, but non-English speaking locals.

Upon arrival back on board the "Pacific Sun", I attempted to share with my family my excitement and also explain the rather



Photo 3 - The Pacific Sun at Port Vila.

extraordinary radio conditions that I had just experienced, but this was only met with an "OK, that's great dear, let's go and have some lunch".

After a very quick lunch, I wanted to check what the conditions were like from my favourite spot on Deck 11. To be honest, I truly did not expect anything; after all, I was now at sea level compared to the 350 m hilltop.

Well it took no more than 30 seconds to discover that in fact, conditions were FAR better than they were on the hilltop. Every 2 m repeater frequency from 6625 to 7100 had at least one, if not two or three, triggerable repeaters. Could it get any better than this?!

From 12.20 pm through to 1.50 pm, I made contact with the following list of Amateurs via repeaters VK4RSC 6850 Sunshine Coast, VK4RRC 6925 Redcliffe, VK4RGG 6950 Gold Coast and VK2RGL 7100 Great Lakes on the mid north coast NSW, some contacts as noted, were also on 146.500 MHz simplex.

June VK4SJ/m  
Wayne VK4TWD  
Bernard VK4KAC  
Ray VK4YRS (plus simplex)  
Phil VK4KVK (plus simplex)  
Lee VK4KLA (plus simplex)  
Frank VK3DYE/4  
Greg VK4AML (plus simplex)  
Spiro VK4IBR  
Graham VK4JGH

Peter VK4TGV/m  
Allan VK4HDM  
Warwick VK4NW  
Garry VK2UNI

Most signal strengths varied from S2 to S9, with some being full-scale on the VX-7R. I could wrap my hand around the rubber duck antenna, turn the radio horizontal and face it away from Australia, and it made little or no difference, the signals were so strong!

Once again using the camera's movie mode, I made 27 more recordings of various conversations. At that point, with great sadness, the handheld's battery went flat mid over, promptly putting an immediate end to my fun. I have since e-mailed some recordings to those who have sent me their details.

I'd had an absolute ball, despite the burning sun, high humidity and 37 degree heat. The handheld's case was past touch hot. It was a challenge to manage the many hectic conversations: trying to juggle the radio, camera, log book and pen, while also trying to co-ordinate the pushing of the PTT button at the right time in conjunction with the record button on the camera - it had been great fun!

The only sad note for me was being able to access my home repeater VK2RMP 6850 back at Wollongong, but I was not able to hold it reliably to make a contact. This was the southern-most repeater that I could identify, over the multitude of

carriers and Morse identis.

An enforced break of four hours was occupied by a pre-booked tourist ride around Noumea on the "Le Petit Train" and the kid's dinner. The VX-7R's battery was now charged, so it was back to the airwaves. By this time (6 pm), we were now departing Noumea Harbour. The best radio position was at the front of the ship on Deck 10 facing towards Australia.

Conditions had also changed in those hours and now only NSW repeaters were coming in. Using the VK2RGL 7100 and VK2RCH 6650 Coffs Harbour repeaters, the following stations were contacted:

Keith VK2AT  
Garry VK2UNI  
John VK2SWR  
Ray VK4YRS

Sunset was at 7.05 pm and the conditions coincidentally ceased almost immediately. Much later on, when about 100 km out to sea from Noumea, I eventually made my one and only contact via the FK8ZHA repeater to Patrice FK8HA. He was an extremely friendly chap, who invited us on our next trip to Noumea to come visit him.

For the many contacts had, distances achieved on the handheld had varied from 1,475 km to Brisbane, just under 1,800 km to mid-north coast of NSW and 2,056 km to Wollongong.

On Christmas Day, conditions were back, but nowhere near as good as the day before. Many calls resulted in only one contact made, that being to Graham VK4JGH via the VK4RRC 6925 repeater. As one might expect, most radios were probably turned off for the festive day's family activities.

From a radio perspective, the remainder of the trip was uneventful. A visit to the ship's bridge was a privilege. Since 9/11, such visits are rare. One interesting, if saddening point, was being told that except for entering or leaving a port, all the ship's radios are only now used for monitoring the distress frequencies, as all business is now handled via satellite accessed e-mail. Incidentally, the ship has three tracking satellite dishes for phone, internet and in-cabin television reception.

So next time you head for a holiday, make sure you have a radio stashed away somewhere: you just never know what is going to be on offer. Oh, and by the way, the cruise was good too!

ar

Photo 4 - A view of Noumea from the scenic hilltop.

# Lightning

## Effects of a near strike

Guy Fletcher VK2KU

Following a move from a suburban environment in the Blue Mountains to a rural property in the Southern Tablelands of NSW with no close neighbours, I was faced with a complete rebuild of both shack and VHF antennas. Some 8 months later on 31 December 2004, I finally powered up the linear for the first time. One month later, I was again off the air for an extended period following a severe storm and close lightning strike on the evening of 1 February 2005. The damage was extensive and largely my own fault, because I had not yet completed an adequate earthing system for the shack and antennas. I would like to share with you some details of what happened, the extent of the damage, and how it might have been prevented.

The shack is located in a room within a large shed about 100m from our house. Mains power comes to this shed from the house through underground cabling with a sub-board in the shed.

### Damage in the house

The actual lightning strike was not a direct hit – it is difficult for an amateur to provide adequate protection to equipment from a direct strike. We never did find the

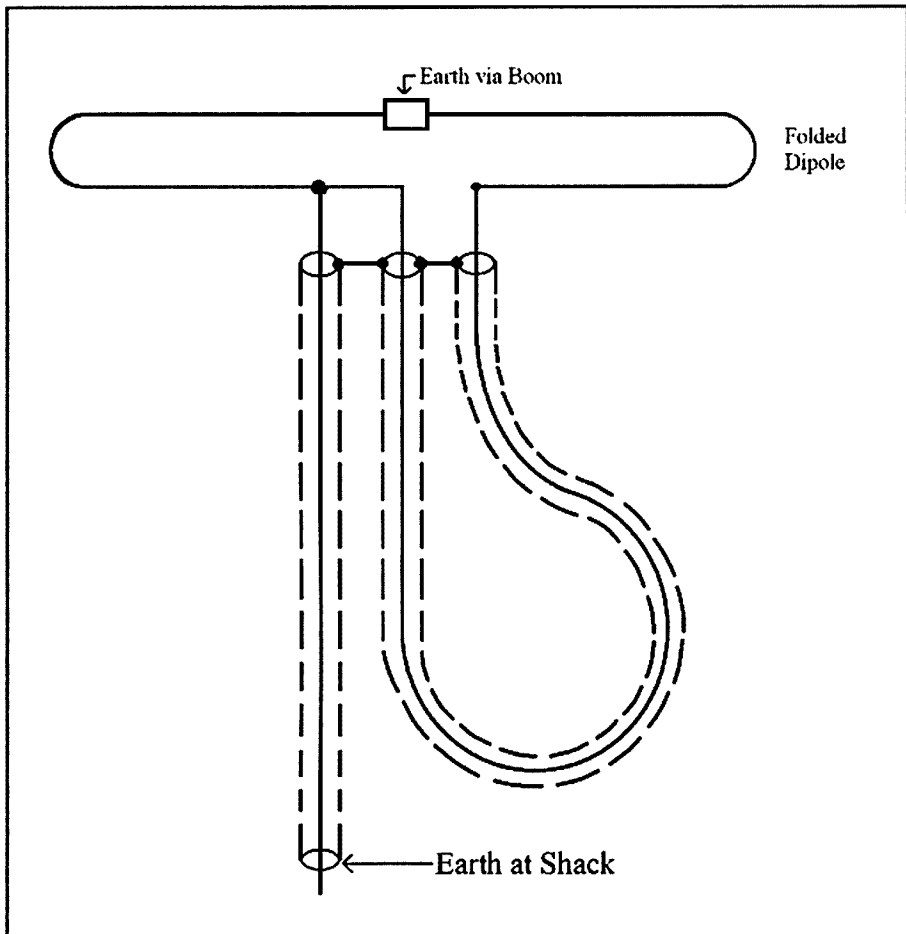

Fig. 1. Earthing arrangements in a typical half-wave balun

# OzGear

www.OzGear.com.au

RadioCommunications & Electronics

Ozhelph Services Pty Ltd T/as Ozgear

Suppliers of radiocommunications, electronics and computer products and electronic test equipment

Ph 07 3114 2506

sales@ozgear.com.au

Brisbane QLD

Manager: Doug Hunter VK4ADC

**WE HAVE MOVED!**

**Unit 2**

**139 Beenleigh Rd  
Acacia Ridge 4110**

**Ozgear yagi antennas  
for 6m, 2m and 70cm  
now available**

## ICOM & YAESU

**Australian-sourced radios with  
Australian-based manufacturer  
warranties**

Authorised Aust Icom and Yaesu dealer

Antenna, cable, interface, tuner and general accessory products from...

Amidon, Andrews USA, Austek, Benelec, Bushcomm, Comet, Dalwa, Diamond, Garland, GeoSensory, GME, Icom, Kingray, LDG, Lutron, Mobile One, RFI, Sangean SSGC, TET-Emtron, Tigertronics, Yaesu, ZCG Scalar plus ARRL and RSGB publications

## ALTRONICS

Many products stocked

**Product & pricing info?**

Phone, email or visit us on the web at

**www.OzGear.com.au**

for the latest info plus on-line ordering. Our latest price list can be downloaded at any time

Payment?



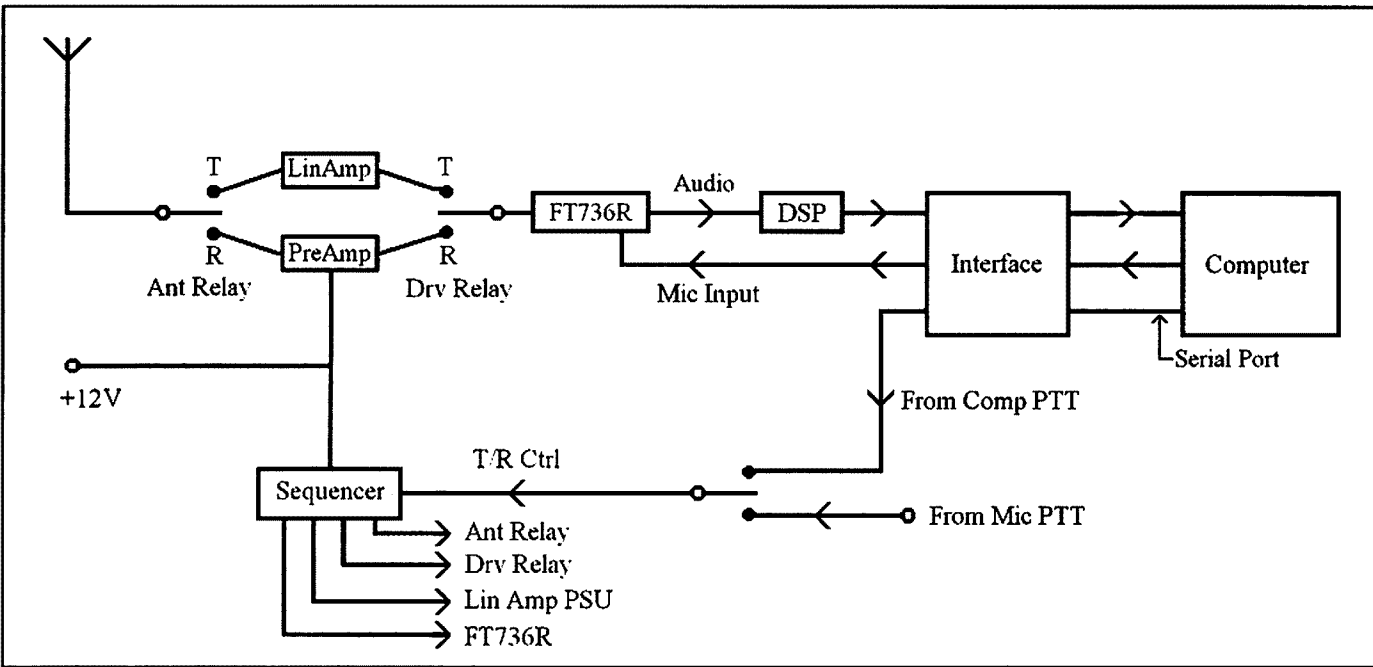

Fig. 2. Interconnection diagram for shack equipment

impact point, but I estimate it was about 150m away in trees on an unoccupied neighbouring property. There was certainly a very loud bang; a big surge on the mains supply, and most of the mains circuit breakers tripped out.

Within the house, we lost the control electronics for our oven, the temperature sensor in the fridge, a movement sensor on the verandah, and every light globe that happened to be on at the time. All of these were live to the mains. A surprising number of other items which were also live escaped unscathed – two TVs, two VCRs, two hi-fi systems, the central heating control, a chest freezer (presumably not actually running), and my internet modem. Perhaps only one of our two phases carried the surge.

## In the shack

Everything in the shack was connected and ready to go, mains power points were on, but everything was switched off at the individual units. Coaxial cables, elevator and rotator control cables were likewise still plugged in. In hindsight, of course, I should have braved the horizontal rain and made the trip to the shack to disconnect everything, but the weather was anything but inviting and I did not do this.

Precious instruments such as my 275 MHz CRO, Signal Generator and Spectrum Analyser were live to the mains, and only switched off at their internal switches. None of those things suffered

any damage. It seems that most of the damage in the shack was not caused by the mains surge, but entered the system through the cables from the tower.

The following items in the shed/shack were destroyed:

- Control electronics for the shed roll-a-door (from the mains surge)
- Rotator controller but not the rotator itself
- Elevator controller and screw jack on the tower
- Antenna coaxial relay
- Low noise receive preamp
- Yaesu FT736R transceiver
- Transmit/Receive sequencer
- Computer interface for digital modes
- Computer on-board sound card
- 12V power supply to preamp and sequencer
- Slow-start circuit in HV supply

## What actually happened?

I naturally spent a lot of time analysing the probable sequence of events. In order to understand this I need to describe the setup in a little more detail. The four individual Yagis on 144 MHz are fed from the balun arrangement with open-wire lines to T-matches on each driven element. It will be simpler if we look at an equivalent and simpler conventional

arrangement with a single Yagi having a folded-dipole element with a half-wave balun, as in Figure 1.

The centre of the folded element is grounded to the tower for mechanical reasons, although this is not electrically necessary. The two driven points can be traced back through the coax centre conductors to the shack. Thus, there is a DC connection from the tower (and its earth point) through the coax inner to the shack. The coax braids are electrically bonded to each other at the balun, but for mechanical reasons are not bonded to the tower earth – again, this is not electrically necessary – and can be traced back to the shack earth. This arrangement works perfectly well; however any direct voltage difference between the tower earth and shack earth will appear directly across the coax input to the shack. I believe that this is what happened in a microsecond on that day.

Good earthing practice requires that all earth points be bonded solidly together to prevent (or at least minimize) any voltage differences between them, but this was still a station under construction, and that aspect of the new shack had not yet been completed. So the probable scenario is a brief but very high earth current in the dry and stony ground following the lightning strike, which caused a high voltage difference (possibly 1kV or more) between the shack earth and the

tower earth about 15m away. This voltage appeared directly across the coax input to the shack!

## The path of destruction

The controllers for the elevation system and the rotator were of course fried through their own cables. The main rotator was not resting at either end stop, so the diodes which prevent overrun at each end of travel were not exposed, being shorted by the internal microswitches. The rotator itself seems undamaged, though it is not possible to buy a replacement controller without the rotator unit, and in any case, Kenpro no longer supply to Australia (but Yaesu units are nearly identical). Both controllers are probably beyond economic repair. The elevation jack was resting in its lowest position, exposing one of its internal diodes, and this diode was in two separated pieces! That may have been its only fault, but since this screw jack had insufficient travel anyway, I took the opportunity to replace it with one having a longer travel.

Figure 2 shows a simplified diagram of the connections between the various pieces of equipment in the station as it then was. The antenna relay and drive relay rest in the transmit position to protect the preamp both when the station is off and when another band is being used. The inside of the CX520D relay provided no protection on this occasion! The transmit contact is a mass of melted metal, and although the receive contact is earthed when not in use; the voltage spike clearly entered the preamp by this route.

The preamp contains only low voltage components, and the spike was easily passed into its 12V power supply leaving an impressive path of destruction behind it in the preamp. Unfortunately the sequencer was at that time run from the same 12V regulated supply (not any more!), and almost every active device in the sequencer was fried. I believe that the spike was distributed to the rest of the station through the sequencer rather than along the coax. In any event the control system of the FT736R was taken out, leaving it in a permanent transmit mode and with regular and unwanted increments in frequency!

The two small audio isolation transformers in the computer interface unit were open circuit on all windings, with black soot all over the circuit board under them, especially the one on the receive path. This is a little curious

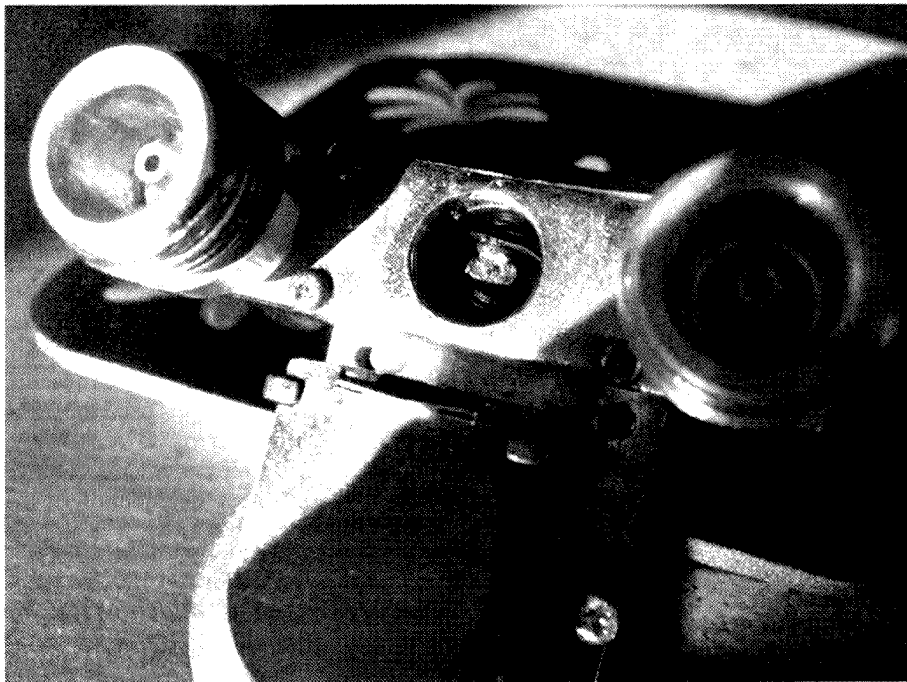

Fig. 3. The Inside of the Antenna Relay

because the Timewave DSP unit in that path was completely undamaged. The optical isolation transistor in the PTT line from the computer also failed, but it did its job in protecting the serial port of the computer from damage. This was little consolation however, as both the input and output audio connections to the computer were completely dead. Possibly a replacement soundcard would have fixed the computer, but I did not have one to hand, and the computer was due for upgrade anyway, being too slow for the increased size of later versions of the WSJT program.

## The Aftermath

Rebuilding the station took several months and a lot of work, but I took the opportunity to change over from using a VHF transceiver to a transverter with a decent HF transceiver, an arrangement that gives me a much better receive system and improved frequency stability. The insurance assessor was to my great relief very helpful and sympathetic; one hears so many stories where this has not been the case.

I have completed the bonding of all three earth points in the system, using the heaviest gauge copper wire that I could afford! The three earths are of course the tower earth, the shack earth,

and the mains earth at the point of entry into the building. I have spent some time improving the first two of these earths, and intend to add still further earth points to the tower since the ground is dry and stony, with solid rock quite close to the surface.

We have now fitted surge arrestors to both the house and the shed switchboards. I have competed an earthed patch panel in the window of the shack, at which all antenna cables and elevator/rotator control cables can be easily and quickly disconnected, and whenever I am away from the shack I disconnect all these cables as well as removing all mains plugs from the wall (except the station clock). It takes two or three minutes to do this, but I have no intention of being taken down again by anything less than a direct lightning strike. There is still of course the possibility of direct wind damage to the antennas and tower, but that is a normal risk of weak-signal work – if it doesn't fall down sometimes, then it isn't big enough!

Note: This article was previously published in "GippsTech2005: Proceedings from the eighth annual Gippsland Technical Conference, 9/10 July 2005".

ar

## VK7

Justin Giles-Clark VK7TW

Email: vk7tw@wia.org.au Regional Web

Site: reast.asn.au

### BPL issues raised at Government hearings

The Tasmanian House of Assembly, Government Businesses Scrutiny Committee hearings in July saw a number of questions raised about the BPL trials by Mr Will Hodgman MHA, the leader of the Opposition. Dr Davis, CEO Aurora Energy, commented that he thought they had around 300 customers and admitted that they have had some technical challenges with the trial. The issue of interference was raised and the discussion wrapped up with an outline of the ACMA's role in complaint management and interference resolution and it was good to see that Minister David Llewellyn MHA remembered some radio theory from his past in Telecom (HI HI).

### Latest BPL emission reports released

The third round of measurements have just been released from the Tasmanian BPL trial from the Mt Nelson, Tolmans Hill, North Hobart, Mount Stuart and West Hobart trial areas. A second round

of measurements was also taken in Burnie on the North West coast of Tasmania. These are available at: <http://reast.asn.au/vk7bplwatch.php#emissionmeasurements>. The measurements used the FSM software developed by Owen Duffy, VKIOD and the measurements confirm there is still a severe degradation of the noise floor in the trial areas.

### New 160 metre net in Southern Tasmania

A new 160-metre net on 1.840 MHz AM at 1645K on Tuesdays, Wednesdays and Thursdays. Dave VK7DM is the net controller and takes reports and callbacks on 1.840 MHz or on VK7RAD/RHT (146.700/146.850).

### North West Tasmanian Amateur Radio Interest Group

The Marconi Centenary Celebrations in Devonport from the 12-16 July went very well with the Devonport Maritime Museum filled to overflowing for the official re-enactment. There was an

exchange of messages between Governors and officials in VK3 and VK7. Messages came from the Premier and Opposition and the highlight was a very special recorded message from Guglielmo Marconi's daughter Princess Elettra Marconi. Special events stations VI7MC and VI3MC operated throughout the celebrations.

### Northern Tasmania Amateur Radio Club

Thanks to Joe VK7JG and Tony VK7YBG for getting the Barren Tier link repeater back on the air. Joe, Alan VK7ZAR and a number of other helpers have been also undertaking the upgrade of VK7REC on Snow Hill in the South East and this repeater is back to its usually state-wide coverage.

Congratulations to Dale Wright, Paul Blundell and Leon Atkins for passing their Foundation Exam. By the time you read this, they will no doubt have their call signs and be on the air.

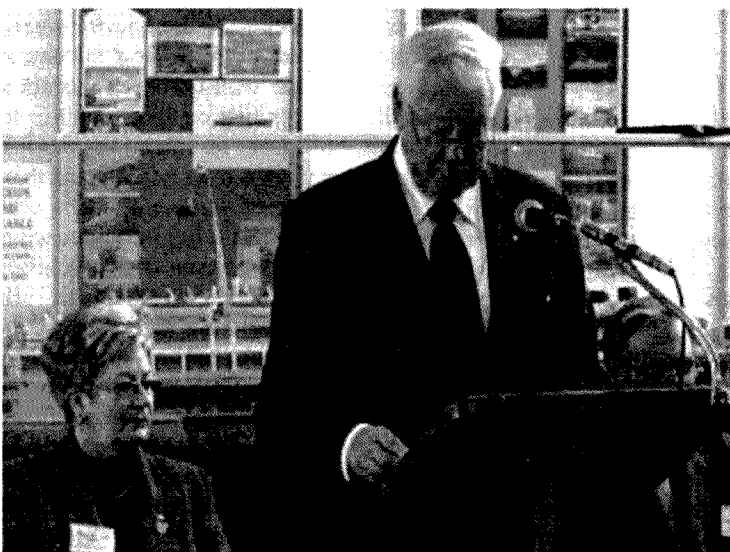

From L to R: Devonport Mayor Lynn Laycock, Governor William Cox AC, RFD, ED and Tony Bedelph, VK7AX

### OzSpid Rotators

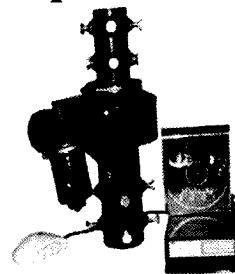

Oceania - New Zealand - Australian Distributors.

Australian Enterprise Industrial

P.O. Box 1013

Browns Plains. QLD. 4118.

Ph. 0414 254 080.

Fax. 07 3800 8003.

[aitower@spin.net.au](mailto:aitower@spin.net.au)

## Radio and Electronics Association of Southern Tasmania

IRLP node 6720 is now available on repeaters VK7RAD/RHT (146.700/146.850). We welcome our new REAST Treasurer, Scott VK7FREK, who brings a wealth of experience from the public finance sector.

Thirty eight WICEN members were deployed on the 2006 Subaru Safari over 15-16 July 2006. This event is different from Targa Tasmania in that there are short bursts of fast-paced activity and an opportunity to get out into the forests! 20 stations were operated, plus Command and repeaters. APRS was successfully trialled using a shared voice channel to

track the Zero car's location around the course.

*Our octogenarian go-getters:* John VK7JK turned 83 and Charles VK7PP turned 80 in the last month and it's definitely a case of 80 years young! John still reads the VK7 Regional News broadcast and Charles is regularly involved in FL training and with the Travellers' Net.

Martin VK7GN, our resident hardcore DXer and contester, gave us a very interesting illustrated presentation called Optimised Radio which included location analysis, operating hints, contests and standard operation and that one key element in any contest is Score = BIC "bum-in-chair"! Thanks Martin.

Martin, VK7GN with his homebrew speech processor for the "G"!

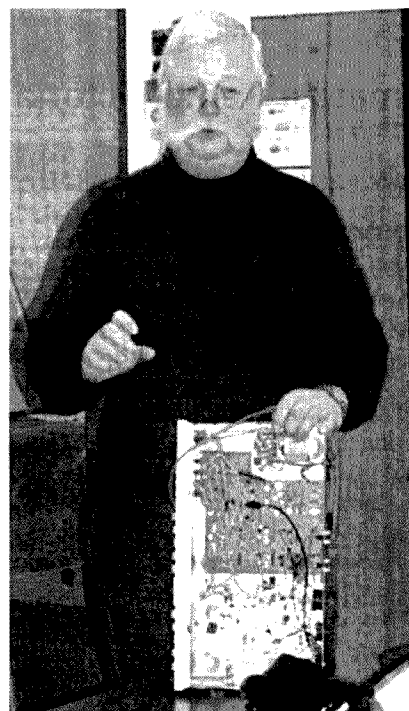

## VK3

### Geelong Radio And Electronics Society

Rod Green VK3AYQ

Over the last three months, our members have enjoyed many interesting syllabus items. Murray VK3ACQ organized a visit to the TV service centre where he is a technician. The focus of the night was free-to-air digital television. The second visit did not involve electronics, but all who attended enjoyed an informative and educational tour of a vitreous enamelling factory.

A representative from "Jaycar" showed us how to make printed circuit boards. He demonstrated the correct method of using "Press n Peel" film. A complete PCB was made on the night and the finished board was certainly of commercial quality. This method of manufacture will certainly be of great use to those who "roll their own", particularly those who like to produce boards populated with surface mount components. Another interesting evening was a discussion on the uses of Picaxe micro-controller chips. Neil VK3XNH explained how he developed a circuit to keep a second battery charged in his utility.

We had one practical evening where members constructed a small low power FM transmitter. The main purpose of the evening was to make certain that the

circuit worked reliably. As the circuit was reliable, John VK3TKH held two practical evenings for a local Scout group. The Scouts constructed their own transmitters under the guidance of John, Keith VK3XKS and Neil VK3XNH. The Scouts deemed these practical evenings to be a great success, and they have become a regular activity for the Scouts.

John VK3TKH and Keith VK3AFI have continued to run classes and exams for all levels of amateur licences. These classes have been conducted on both our regular meeting nights and midweek on an afternoon. So far, we have had new licensees in all classes of amateur licence.

Our daytime Wednesday group continues to meet each week. This group works on specific club projects. In addition, the computer group meets on the first and third Friday of each month. The numbers attending each group are increasing.

Visitors to Geelong are welcome to attend our weekly meetings. These are held at 237A High St., Belmont. Meetings start at 2000 Hrs every Thursday.

## Silent Key

### Ken Saxon VK7AI

Ken was born in 1922 and grew up on his father's farm at Henrietta, just south of Yolla in North-West Tasmania. At an early age, he developed an interest in 'wireless' and would catch and sell rabbits so he could afford to buy parts. He gained his Amateur Licence in 1937 at the age of 15, remarkable at that time. In the Second World War, Ken joined the Royal Australian Air Force. Eventually, he was posted to Egypt, supporting Montgomery in the pursuit of Rommel in North Africa. Here he 'acquired' a short-wave radio and would use it at night in his tent to secretly tune the bands. Recently, he donated that radio to the Australian War Memorial in Canberra. In the 1950s, he became interested in the new mode of 'single sideband suppressed carrier' and built his own transmitter, when few had heard of SSB. Ken was a reserved man, a true gentleman who will be sadly missed. Vale Ken VK7AI.

(Submitted by Winston VK7EM)

## VK3

### Amateur Radio Victoria News

Website: [www.amateurradio.com.au](http://www.amateurradio.com.au)

Email: [arv@amateurradio.com.au](mailto:arv@amateurradio.com.au)

Barry Robinson VK3JBR

#### CommGames QSL Cards

A set of four QSL cards, two each for AX3MCG and AX3GAMES, was printed last month and many have been despatched in response to the many direct and bureau cards that have arrived.

These two callsigns were put on air during the XVIII Commonwealth Games Melbourne logging more than 7,000 contacts with over 150 DX countries during March this year.

They have become Australia's most successful special event callsign activity ever. A sincere thank you to the members involved.

Two of them, Peter Forbes VK3QI and David McAulay VK3EW, not only operated AX3MCG but also handled the QSLing for both special callsigns.

#### Super September

Amateur Radio Victoria has decided to double its education efforts in September by scheduling two Foundation Licence Training and Assessment weekends.

It asks its members for assistance by encouraging a relative, friend or workmate to take the step and join the wonderful activity of amateur radio.

Can we achieve 20 new radio amateurs in the same month to add to the 100 already assisted through the ARV sessions to get their callsigns since they began in November 2005?

The dates are 9-10 September and 23-24 September. For inquiries or to enrol contact - Barry Robinson VK3JBR 0428 516 001 or [arv@amateurradio.com.au](mailto:arv@amateurradio.com.au)

#### 95th Anniversary

The Amateur Wireless Society of Victoria (now Amateur Radio Victoria) was formed on 30 November, 1911. Thoughts are being given as to how to celebrate its 95th anniversary.

Members are invited to put forward their ideas, which will be considered at the next meeting of the Amateur Radio Victoria Council.

#### Getting radio into schools

Only a few members have so far made further inquiries about the Amateur Radio Victoria offer to help introduce the Foundation Licence to schools.

The key to getting it into schools seems to be the use of an 'insider' to convince the school that the Foundation Licence is a worthwhile scholastic or self-development activity.

Amateur Radio Victoria will support its members for the rest of this calendar year 2006 by providing up to 10 Foundation Licence Manuals free directly to any school that commits to have a training course and assessment session.

#### F-Troop

A reminder that the F-Troop weekly Sunday net for Foundation Licensees is held at about 11.40 am through the Mt Macedon 2-metre repeater VK3RMM immediately after the broadcast call-back.

Net controllers Ross Pittard VK3FCE and Keith Proctor VK3FT will make all newcomers most welcome.

#### E-Member Services

To obtain email updates and access to the Members Only section of the Amateur Radio Victoria website, members need to register and provide their email address.

If you're a member and not e-registered, please help us to keep you informed by either visiting the website and registering online, or sending an email request for registration to [arv@amateurradio.com.au](mailto:arv@amateurradio.com.au)





## VK5

### Adelaide Hills Amateur Radio Society

Christine Taylor VK5CTY

As usual, the Mid-year Dinner was a success. There were over fifty people present, with a number travelling from warmer climes. Judging from the noise and the fact that no one was in a hurry to go home, the food and the company were enjoyable.

This year we also had a meeting visit during July. About thirty members and their wives went to the Traffic Control Centre. Unfortunately we are no longer allowed to walk among the desks in the Centre but the talk we were given was most interesting.

We now understand the wide extent of traffic oversight. The South Eastern Freeway and the Southern Expressway are watched by cameras all the way. Nothing happens there that the Control Centre cannot overlook. In fact when someone called in recently to report an incident, while he was still on the phone the cameras were moved to view the incident in question, so that before the phone call ended the police and emergency services were activated.

One of the last displays we saw was actual movement of cars and the changing of lights happening at a particular intersection, as it happened. Our informant said it was very old technology that was bringing the images and information to the centre, but "if it ain't broke, why fix it?" It doesn't matter how old or new technology is, as long as it does what it is/was designed to do.

One corner of the working area was highlighted. It is a desk set up with a television camera where the person who tells us about the traffic each morning sits. He has all the most up to date information at his fingertips because he is in the place where it is all collated, moment-by-moment. What a great idea and so practical!

AHARS also had a construction evening where a group had the opportunity to make themselves a sewer pipe balun, under the eagle eye of experts. The photo shows some of the "experts" having a consultation.

There will be more construction nights in the coming months.



L to R: Jim VK5NB, Ted VK5 VK5KBM, and Rob VK5RG studying the plans

## VK2

Tim Mills VK2ZTM

### Clubs.

Early next month the Oxley Region ARC, based at Port Macquarie, will celebrate its 35th year. A lunch is planned in place of the usual monthly meeting. Last month they held their AGM with some change in the committee. Alan VK2GD is President, Bruce VK2HOT is Vice President, Jim VK2VIV became Secretary and John VK2KCE the Treasurer. The committee members are Bill VK2ZCV,

Bill VK2ZCW and Henry VK2ZHE.

The St. George ARS, in southern Sydney, meet on the first Wednesday evening at the 1st Kyle Bay Scout Hall, Donnelly Park, Kyle Parade, Connells Point at 7.30 pm. The Blue Mountains ARC meets on the first Friday at the 1st Blaxland Scout Hall, Reading Street, Glenbrook. Also on the first Friday, the Orange and District ARC meet at 7.30 pm in the RAAF building, 64 Warrendine

Street. Westlakes ARC are to conduct their "Westlakes Cup" on 80 metres on Saturday the 23rd September in the hour 20.30 to 21.30 EST.

### ARNSW.

The Radio Veterans Group meets on the third Thursday morning at the Ryde Eastwood Leagues Club, 117 Ryedale Road, West Ryde. The Radio Experimenters and Home Brew Group

# ALARA

Christine Taylor VK5CTY

## The Contest

As I am writing this before the event, I hope everyone had a good ALARA Contest. Hopefully the propagation was good and there were lots of stations on the air. The Contest is an excellent chance to talk to some of our members who do not often come on the air.

If everyone takes notice of the previous suggestions, our Award Manager, Kathy VK3XBA will be busy processing the applications.

**DON'T FORGET TO SEND IN YOUR LOGS** no matter how few the number of contacts you made, please send the log in to Marilyn VK3DMS QTHR or on line via

via [alaracontest@wia.org.au](mailto:alaracontest@wia.org.au)

While you are re-writing your logs for Marilyn, why not do the same with your Remembrance Day logs. It really is important that the logs are sent to the Contest managers so they can be checked against each other.

## The Birthday Net

Unfortunately, this was disappointing this year. Marilyn VK3DMS and Shirley VK5JSH had a lovely long chat but didn't hear any other stations. What a

shame! If the same thing happens next year, I suspect the idea of wishing each other a "Happy ALARA Birthday" might become a thing of the past. It is certain that the committee will have a discussion about it.

## The Birthday Luncheons

I have not heard about the Birthday Luncheon in VK6 (hint, hint), but it is usual for them to have a special Luncheon in July, so maybe there will be some stories or pictures in a later edition.

In VK5, the special Birthday Luncheon was very well attended. There were 13 YLs and 8 OMs at the Marion Hotel on July 30th. Everyone enjoyed it immensely.

Unfortunately, this year there was one empty chair. Janet VK5NEI was toasted by the YLs. We do not usually see Janet (and her lovely Dalmatians) for the rest of the year but she has not missed many Birthday Luncheons. She was missed.

To make it even more poignant, on the Monday morning, Jean VK5TSX received a thank you card for the family on which there was a picture of the sunrise taken on the morning of her death. Janet had only recently acquired a digital camera and was trying it out. When the family looked at the photos on the card



Back row: Myrna VK5YW, Tina VK5TMC, Sue Mahony, and Jeanne VK5OQ  
Middle row: we have Meg VK5YG, Shirley VK5JSH, Christine VK5CTY and Jenny VK5ANW. Sue VK5AYL and Joy VK5YJ are between the middle & front rows.  
Front row: Melanie VK5FMEL, Susie VK5FSUE (holding VK5GAL), Jean VK5TSX and Jenny VK5FJAY

73 - Tim VK2ZTM  
ar.

they found this picture of the sunrise. She must have seen the beautiful colours and decided to try out the new toy.

Jean will show the card to the YLs at the regular Luncheon in August.

## Monthly Luncheons

The VK5 luncheons are now held at the Museum Café. Myrna found the new venue but it has the approval of us all. There are usually eight or nine of us and sometimes more. In August we are having another Red Hat Day. The red hats were introduced to us at the ALARAMeet in Mildura, by Shirley VK5JSH, where they helped to relax the formality in a "nice way".

We do not wear purple dresses as the true Red Hat ladies do, but we do come up with some inventive red hats. If you do not know about the Red Hat Society perhaps you should look for some information about it.

In essence, once a lady (YL) reaches a certain age she should not feel hidebound by the conventions of "making a good impression" or "behaving properly". She should feel free to be a bit unconventional. If she feels like it she should wear a red hat and a purple dress, or in any other way, show her independence.

She has earned the right!

## Foundation Licensees

We have been delighted to have a number of Foundation licensed YLs join the Monday Nets recently. Not only Jenny VK5FJAY, but also both her daughters, Melanie VK5FMEL and Amanda VK5FAAJ have been heard. Pam VK4ABB, who sometimes is in VK4 land and sometimes in VK2 land, just over the border has almost become a regular. We have heard Daina, and another Jenny. We have had a number of OM F calls join in, too. We welcome OMs into the ALARA Net although most of the stations are YLs. The conversation is very wide ranging.

One OM recently had a link with ALARA that was unexpected. He knew Clarice VK3UE and her OM from many years ago. ALARA recognised Clarice, some years ago as someone who had held an amateur licence for over 40 years. Few of us will ever achieve that distinction!

## The travellers

Many amateurs are travelling at this time of the year. Listening in to the Travellers' Net at lunchtime is an excellent way to hear about interesting and often strange places in Australia.

But LARA was delighted recently to have June VK4SJ, who has helped run the 222 Net and is a very keen Dxer, and Maria VK5BMT, a long time 222 Net member, both call in to that net to let

others know what they were doing and where they were.

The 222 Net is suffering from the poor propagation at the moment, but we hope for improvement in the next few years. If you join in there is usually someone you can talk to or who can hear to pass on greetings to stations you know are on the air but whom you cannot hear. Monday afternoon on 14.222 with call in from 0530 UTC.

## You need never be lonely

As a radio amateur you need never be lonely. All you need to do is to turn on your rig and call "CQ". Someone else will be sitting at their rig too, and will be willing to talk to you.

You do not need to drive to a friend's house, or ring them up, maybe at an inconvenient time, you know they will also be sitting in front of the radio ready for the regular nets.

You don't need to talk on the net if you are not ready to do so but you can listen to the friendly voices and feel that they are not far away.

We have a great hobby!

ar

## Vince Nugent VK2ALZ

### Tumut NSW

The death of long time and well known Ham Radio Operator Vince Nugent VK2ALZ at Tumut NSW occurred on 7 June 2006.

Vince was a senior member of the Wireless Institute of Australia and a regular participant on the Sunday Morning sked.

Originally from Bexley, Sydney, Vince was a senior technician for over 40 years with the PMG.

Vince was active on HF bands. He designed and built several antennas. He was an active member of the Tumut Radio Club and was widely known in south western NSW & the Riverina.

Vince was a member of the Old Timers Club and was very proud of his association with the older hams of that elite club.

Ham radio is a hobby that brings enjoyment to so many radio operators but nobody got more pleasure than did Vince Nugent.

Vince taught theory to many local amateurs, at the Tumut Club, when obtaining our amateur licenses, for which we are most grateful.

Vince is survived by Frances, and children Mark, John, Anne, Monica, Paul and Shelly and several grandchildren.

Vince's voice and call sign VK2ALZ and his sense of humour will be sadly missed by all.

The family and local amateurs are grateful to Allan VK2OA who helped to prepare the silent key notice.

Vale Vince.

submitted by AG (Ted) Dean VK2FUP

## Silent key

FEATURE TECH



**AT3000**

Automatic Tuner  
1.8-30MHz, 200W

Smart Tuning No need for control cable  
Rapid Tuning 2s fist tune, 0.5s memorized

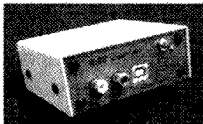

**USB Link-All**

Fully Isolated  
Radio-PC Interface

Connecting rig to PC soundcard  
USB port to control PTT and frequency

**Pocket Frequency Counter**

Frequency Range:  
10Hz ~ 50MHz  
1MHz~2.6GHz  
Stability: 1ppm (VCXO)  
Battery: Rechargeable Li-Ion

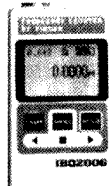

For More Products Visit:

<http://featuretech.co.nz>

Ph: 64-9-630 5078 Fax: 64-9-630 5038

Email: [sales@featuretech.co.nz](mailto:sales@featuretech.co.nz)

Featuretech Limited

# Beyond our shores

David A. Pilley VK2AYD

## We are important

Since Hurricane Katrina hit the Mississippi coast last year, the U.S. authorities are taking a new view of the benefits of Amateur Radio to the community and how it played an important part when communications were disrupted. Amateur Radio operators are now being recruited for special training for hospital communications.

When terrorists attacked trains in Mumbai, India, on July 11th, the cities cellular telephone network failed. Amateur Radio took over and today in Mumbai 'HAM' means "Help All Mankind". We are not just a hobby but a service provider in times of need.

## New Zealand

The New Zealand Administration's Radio Spectrum Management group has advised NZART that the European Radiocommunications Office has advised the acceptance of the New Zealand application to participate in CEPT TR61-02 arrangements for mutual recognition of radio amateur operators certificates.

NZART's Administration Liaison Officer Fred Johnson ZL2AMJ says that New Zealand with its one-grade licence now has both TR61-01 and TR61-02 recognition and that this is a significant milestone and brings great international portability for the New Zealand qualification.

Other changes in New Zealand's Radiocommunications Regulations include a General Users Radio Licence for Amateur Radio Operators. This GURL is common to all New Zealand's Radio Amateurs and contains the terms, conditions and restrictions with which they work. Each Radio Amateur will have a General Amateur Operators Certificate of Competency that will carry the individual operator's unique Call-sign. The GURL provides for the ZL/ZM call-sign prefix facility to be decided by individual operators for contests and special events.

Nations agreeing to CEPT minute TR61-02 permit radio amateurs from other CEPT signatories to operate portable to the extent of the privileges and limitations on their home nation's licence.

(ZL2BHF via ARNewsline)

## UK:

### New regulations to permit remote operations

Remote operation will be a standard feature of the new United Kingdom Amateur Radio licence due to come into force on October 1st. After that date, U.K. full licensc class holders will be allowed to remotely control an unattended station for their personal use. For example, they could run a home station from elsewhere or operate a remote-base system located at another site.

The remote control link can be a simple radio system on permitted Amateur frequencies. Or, it can use any publicly available system including dial-up, I.S.D.N., the Internet or even Wi-Fi. In addition, all U.K. licensed amateurs will be allowed to remotely control their station within a range of 100 metres. Under the new licence structure, this will not be regarded as unattended operation.

(GB2RS).

## Ireland:

### IRTS wants 500 kHz

The Irish Radio Transmitters Society has applied to Ireland's Telecommunications regulator ComReg for a small allocation in the region of 500 kHz, for use by Amateur Radio experimenters.

The move follows a similar proposal made by the Radio Society of Great Britain to U.K. regulator Ofcom in 2004. Ofcom has not yet made a decision on the RSGB proposal but the Society is hopeful of an allocation between 501 and 504 kHz.

The GB2RS News Service says that there is a possibility that Ofcom might designate the spot frequency of 500 kHz a maritime memorial frequency. In recent years, there has been little traffic on the band 415 to 526.6 kHz, after most countries stopped using it as a Morse emergency maritime frequency in the 1990s.

(IRTS)

## Libya:

### November operation allowed

Following years of silence, an international team of operators will activate Libya from November 14th to 28th.

The goals of this DXpedition are to support the development of amateur radio in Libya while bringing a rare country onto the airwaves.

Activity will be on all bands running CW, SSB, FM, RTTY, SSTV and PSK. The operators hope to provide more than 50,000 QSOs during the 14-day operation using the callsign 5A7A.

They also plan to take part in CQWW DX CW Contest as a Multi/Multi entry.

ar

## KVK Antenna Systems

Best value books in VK.

The VK Antenna Handbook for Restricted Spaces

Best value antennas in VK.

The NuBeam

The Vertical-LR-dipole multiband vertical

As seen at Wyong

Check out the latest revision to the web site - more info, more antennas, more value.

For direct purchases

[www.grimshaw.net.au](http://www.grimshaw.net.au)

For credit card purchases:

[www.kvkantennas.com.au](http://www.kvkantennas.com.au)

or ph 07-3216 8060 or

fx 07-3216 8075

## Stormy times

I have not been doing much listening this month, as I have been caught up by activities away from the radio. I did manage to hear the historic re-enactment of the first wireless communications across Bass Strait on 12th July. It was so disappointing that there was deliberate interference to the short transmission. I expect there will be further coverage of the activities elsewhere in this journal.

In late June, the Middle East again erupted in War, following the kidnapping by Hamas and Hezbollah of Israeli soldiers. Naturally, this led to immediate hostilities that are still ongoing as I write this report. Shortwave broadcasts escalated as domestic senders were destroyed, particularly in Lebanon.

Tens of thousands were evacuated out of the conflict zone. Sadly, the innocent civilians have been the main casualties on both sides.

Syria is involved in this crisis, yet it has been almost impossible to hear their external programs due to extremely poor modulation. They are supposed to be on 12085 but all I hear is often hum and unintelligible audio. Iran is reportedly a backer of Hezbollah and there has been an increase in the output of Radio Farda, the American clandestine station. I have heard them on 7590 from time to time.

I also have heard the Chinese firedrake jamming station on 14260 at 1010.

Why they are in exclusive amateur bands has been a mystery but they are probably jamming a station on 7130. Taiwan has operated on that channel for many decades and the Chinese may be overdriving their jammer.

Radio Japan may be the next station to quit shortwave. Broadcasts to Europe are reported to be slashed, particularly French, German and other languages, yet excluding Japanese and English. It is believed that the European audience has significantly decreased in size and broadcasts cannot be economically justified. Radio Korea may also follow this trend.

Apparently, several former Soviet republics have decided to discontinue relays of international stations via medium and shortwaves. Both Armenia and

Uzbekistan have notified their clients that the facilities will no longer be available. Both countries also announced they are also suspending shortwave relays of their domestic programming.

You may have noticed in the press that Telstra have suspended their plans to develop a fibre optic network for "Broadband". As the government has been promoting the benefits for rural areas for the fibre optic technology, the idea of BPL becomes more attractive to fulfil the need for Broadband. Here in Tasmania, we have had ongoing trials of BPL but this may increase if Telstra indeed does not roll out the fibre optic network.

*(These developments are interesting; especially as the current Australian "Broadband" technologies available outside of fibre optic and coaxial cable service areas do not begin to approach the speeds of delivery that are recognised internationally as Broadband. In addition,*

*costs are comparatively very high in Australia. One must really wonder about the future of telecommunications delivery within Australia. Editor.)*

The American FCC also recently re-affirmed their support for BPL, despite considerable opposition from amateurs and other HF users. It really is depressing for the future of our hobby.

Niger is a country in West Africa that has recently returned to shortwave. I believe that it has been heard on 9705 at 2100 in French and local languages.

However, Ethiopia has also been known to use this channel so just do not assume it is Niger.

Nigeria, which is next door, has been heard on 15120 in English, Hausa and French from 0600 until 2100.

Well that is all for this month. Until next time, the very best of monitoring and 73 - Robin L. Harwood VK7RH

ar

### Radio Amateurs Old Timers Club (South Australia)

## The Annual Luncheon

will be held on

### Thursday, 26th October 2006

(12 noon for 12.30 pm lunch)

*Please bring your Seniors Card.*

**Venue:** Marion Hotel, Marion Road, Mitchell Park  
Public transport Bus 243, stop 24.

**RSVP to one of the following committee members before 22nd October 2006:**

**President:** Jim McLachlan VK5NB - phone 8294 2992

**Secretary:** Ray Deane VK5RK - phone 8271 5401

**Assistant Secretary:** Ron Coat VK5RV - phone 8296 6681

# Gridsquare Standings at 4 August 2006

Guy VK2KU

## 144 MHz Terrestrial

VK2FLR	Mike	113
VK3NX	Charlie	104
VK2KU	Guy	102
VK3KAI	Peter	81
VK2ZAB	Gordon	78 SSB
VK2KU	Guy	69 SSB
VK3HZ	David	69
VK3CY	Des	68
VK3PY	Chas	68 SSB
VK2DVZ	Ross	63 SSB
VK2TK	John	62
VK3EK	Rob	62 SSB
VK3QM	David	56 SSB
VK2EI	Neil	54
VK3TMP	Max	53
VK7MO	Rex	53
VK3BJM	Barry	52 SSB
VK3BDL	Mike	51 SSB
VK3ZLS	Les	51 SSB
VK3KAI	Peter	48 SSB
VK2DXE	Alan	47
VK2KU	Guy	47 Digi
VK3WRE	Ralph	46 SSB
VK4TZL	Glenn	45
VK2DXE	Alan	43 SSB
VK4CDI	Phil	41
VK3CAT	Tony	40
VK3KEG	Trevor	39
VK3KAI	Peter	36 Digi
VK2TK	John	35 SSB
VK4KZR	Rod	35
VK7MO	Rex	35 Digi
VK3UUX	Denis	33 SSB
VK6HK	Don	33
VK7MO	Rex	33 SSB
VK3ZYC	Jim	31
VK2KRR	Leigh	28 FM
VK3CJ	Chris	28 SSB
VK4CDI	Phil	28 SSB
VK2TK	John	27 Digi
VK2EAH	Andy	26
VK4DFE	Chris	26 SSB
VK5ACY	Bill	26 SSB
VK2TG	Bob	25 SSB
VK3BBB	Brian	25
VK1WJ	Waldis	24
ZL3TY	Bob	24
VK3DMW	Ken	23
VK3YB	Phil	23
VK4EME	Allan	23
VK3HV	George	21 SSB
VK3TLW	Mark	20 SSB
VK3VHF	Rhett	20 SSB
VK6KZ	Wally	20
VK1WJ	Waldis	18 Digi
VK3AL	Alan	18 SSB
VK3BG	Ed	17 SSB
VK6KZ/p	Wally	16
VK2EAH	Andy	15 SSB
VK3ZYC	Jim	14 SSB
VK4EME	Allan	14 Digi
VK3UDX	Geoff	13 SSB
VK4CDI	Phil	13 Digi
VK2CZ	David	12
VK7ZSJ	Steve	12
VK2EAH	Andy	11 Digi
VK2EI	Neil	11 Digi
VK3VHF	Rhett	11 Digi
VK2DXE/p	Alan	10
VK3ANP	David	10
VK4EME	Allan	9 SSB
VK6DXI	Mirek	6
VK6HK	Don	6 Digi
VK1WJ	Waldis	5 SSB
VK2TWO	Andrew	5
VK3ZDR	David	5 SSB
VK1WJ	Waldis	3 CW
VK2DXE	Alan	3 Digi
VK4TJ	John	3 SSB
VK3QM	David	1 Digi

## 144 MHz EME

VK2KU	Guy	210
ZL3TY	Bob	208
VK2KU	Guy	193 Digi
VK7MO	Rex	154 Digi
VK2FLR	Mike	120
VK3CY	Des	70 CW
VK3AXH	Ian	60 Digi
VK2AWD	Dave	52 Digi
VK2KU	Guy	39 CW
VK2KRR	Leigh	30
VK4CDI	Phil	30
VK3HZ	David	14
VK3NX	Charlie	5
VK3KEG	Trevor	4
VK3VHF	Rhett	4
VK2DVZ	Rosa	2
VK2DXE	Alan	2
VK3AXH	Ian	2 CW
VK4EME	Allan	1 Digi

## 432 MHz Terrestrial

VK2ZAB	Gordon	57 SSB
VK3PY	Chas	50 SSB
VK3NX	Charlie	48
VK3QM	David	47 SSB
VK3ZLS	Les	40 SSB
VK2KU	Guy	38
VK2KU	Guy	34 SSB
VK3EK	Rob	34 SSB
VK3HZ	David	34
VK2DVZ	Ross	32 SSB
VK3BJM	Barry	32 SSB
VK3CY	Des	32
VK3KAI	Peter	29
VK3KAI	Peter	28 SSB
VK3BDL	Mike	27 SSB
VK3WRE	Ralph	26 SSB
VK3TMP	Max	25
VK3KEG	Trevor	21
VK2TK	John	18
VK7MO	Rex	18
VK2TK	John	17 SSB
VK3CAT	Tony	16
VK3ZUX	Denis	15 SSB
VK3BG	Ed	14 SSB
VK4KZR	Rod	14
VK3TLW	Mark	13 SSB
VK4TZL	Glenn	13
VK6KZ	Wally	13
VK2KRR	Leigh	11 FM
VK3UDX	Geoff	11 SSB
VK3AL	Alan	10 SSB
VK3ANP	David	10
VK3YB	Phil	10
VK4CDI	Phil	10
VK2TG	Bob	9 SSB
VK3BBB	Brian	9
VK4CDI	Phil	9 SSB
VK4DFE	Chris	9 SSB
VK3CJ	Chris	8 SSB
VK3VHF	Rhett	8 SSB
VK6KZ/p	Wally	8
VK2FLR	Mike	6
VK6DXI	Mirek	6
VK7MO	Rex	6 Digi
VK2KU	Guy	5 Digi
VK3HV	George	5 SSB
VK3KAI	Peter	4 Digi
VK3PY	Chas	4 Digi
VK3QM	David	4 Digi
VK3ZYC	Jim	4 SSB
VK4EME	Allan	4 SSB
VK1WJ	Waldis	3 SSB
VK2CZ	David	3
VK2TWO	Andrew	3
VK2DXE/p	Alan	2
VK3DMW	Ken	2
VK4TJ	John	2 SSB
VK2TX	John	1 Digi
VK3VHF	Rhett	1 Digi
VK4CDI	Phil	1 Digi

## 432 MHz EME

VK4KAZ	Allan	14 CW
VK7MO	Rex	10
VK7MO	Rex	9 Digi
VK3NX	Charlie	5
VK3HZ	David	4
VK4CDI	Phil	4
VK2KRR	Leigh	1
VK3AXH	Ian	1 Digi

## 1296 MHz Terrestrial

VK3QM	David	37 SSB
VK3PY	Chas	36 SSB
VK3NX	Charlie	34
VK2ZAB	Gordon	29 SSB
VK3ZLS	Les	26 SSB
VK2KU	Guy	25
VK2KU	Guy	22 SSB
VK3EK	Rob	20 SSB
VK3KAI	Peter	20
VK3KAI	Peter	19 SSB
VK3KWA	John	19
VK2DVZ	Ross	17 SSB
VK3WRE	Ralph	16 SSB
VK3BDL	Mike	12 SSB
VK3BJM	Barry	12 SSB
VK3HZ	David	11
VK3TMP	Max	11
VK2TK	John	10 SSB
VK4KZR	Rod	10
VK7MO	Rex	10
VK3BG	Ed	8 SSB
VK3TLW	Mark	8 SSB
VK3AL	Alan	7 SSB
VK3UDX	Geoff	6 SSB
VK4TZL	Glenn	6
VK2CZ	David	5
VK3HV	George	5 SSB
VK3ZUX	Denis	5 SSB
VK3ZYC	Jim	5
VK6KZ/p	Wally	5
VK2KRR	Leigh	4
VK3BVP	Shane	4
VK3VHF	Rhett	4 SSB
VK3YB	Phil	4
VK3ZYC	Jim	4 SSB
VK4CDI	Phil	4
VK6KZ	Wally	4
VK2KU	Guy	3 Digi
VK3BBB	Brian	3
VK3KEG	Trevor	3
VK4CDI	Phil	3 SSB
VK6DXI	Mirek	3
VK2DXE/p	Alan	2
VK2FLR	Mike	2
VK3CJ	Chris	2 SSB
VK3CY	Des	2
VK3KAI	Peter	2 Digi
VK3QM	David	2 Digi
VK4TJ	John	2 SSB
VK3DMW	Ken	1
VK3ZYC	Jim	1 Digi
VK4CDI	Phil	1 Digi
VK7MO	Rex	1 Digi

## 1296 MHz EME

VK7MO	Rex	12
VK7MO	Rex	11 Digi

## 2.4 GHz

VK3PY	Chas	14 SSB
VK3QM	David	14 SSB

VK3NX	Charlie	11
VK3WRE	Ralph	9 SSB
VK3KAI	Peter	7 SSB
VK3EK	Rob	5 SSB
VK3HV	George	4 SSB
VK3HZ	David	4
VK6KZ	Wally	4
VK3BJM	Barry	3 SSB
VK3KAI	Peter	2 Digi
VK3VHF	Rhett	2 SSB
VK4KZR	Rod	2
VK2DVZ	Ross	1 SSB
VK3BG	Ed	1 SSB
VK3TLW	Mark	1 SSB
VK3ZUX	Denis	1 SSB
VK4TZL	Glenn	1

## 3.4 GHz

VK3NX	Charlie	11
VK3QM	David	9 SSB
VK3KAI	Peter	6 SSB
VK3WRE	Ralph	6 SSB
VK3HV	George	4 SSB
VK6KZ	Wally	4
VK3EK	Rob	3 SSB

## 5.7 GHz

VK3NX	Charlie	12
VK3WRE	Ralph	9 SSB
VK3QM	David	8 SSB
VK3KAI	Peter	7 SSB
VK6KZ	Wally	4
VK3BJM	Barry	2 SSB
VK3EK	Rob	2
VK3HV	George	2 SSB
VK3KAI	Peter	2 Digi
VK6BHT	Neil	2 SSB
VK3ZUX	Denis	1 SSB

## 10 GHz

VK3NX	Charlie	11
VK3QM	David	11 SSB
VK3KAI	Peter	9 SSB
VK3PY	Chas	9 SSB
VK6BHT	Neil	9 SSB
VK3WRE	Ralph	8 SSB
VK3EK	Rob	5 SSB
VK6KZ	Wally	5
VK3HV	George	4 SSB
VK3HZ	David	4
VK3TLW	Mark	3 SSB
VK3ZYC	Jim	3 SSB
VK5ACY	Bill	3 SSB
VK2EI	Neil	2 SSB
VK3BJM	Barry	2 SSB
VK3DMW	Ken	2
VK3ZUX	Denis	2 SSB
VK7MO	Rex	2
VK3BG	Ed	1 SSB
VK4KZR	Rod	1
VK4TZL	Glenn	1

## 24 GHz

VK6BHT	Neil	3 SSB
VK2EI	Neil	2 SSB
VK3NX	Charlie	2
VK6KZ	Wally	2

## 474 THz

VK3CJ	Chris	2
VK7MO	Rex	1

Additions, updates and requests for the guidelines to Guy VK2KU, vk2ku@clearmail.com.au, or by mail (QTHR 2005).

The guidelines (and the latest League Table) are also available on the website of the NSW VHF DX Group at www.vhfdx.radiocorner.net - click on Gridsquares.

Next update of this table will be in early November 2006.

Stations who do not confirm their status for more than 12 months may be dropped from the table.

## Contest Calendar September - November 2006

Sep	2	Russian Radio RTTY Contest	(RTTY)
	2/3	All Asian DX Contest	(SSB)
	9/10	Worked All Europe DX Contest	(SSB)
	23/45	CQ WW RTTY DX Contest	(RTTY)
	23	Westlakes Cup	(SSB/DSB/AM)
Oct	7	PSK31 Rumble	(PSK)
	7/8	Oceania DX Contest	(SSB)
	14/15	Oceania DX Contest	(CW)
	9	10-10 International Day Sprint	(All Modes)
	14/15	JARTS WW RTTY Contest	(RTTY)
	15	Asia-Pacific Sprint Contest	(CW)
	15	RSGB 21/28 MHz Contest	(CW)
	21	RAOTC QSO Party	(CW/SSB/FM)
	28/29	CQ WW DX Contest	(SSB)
Nov	11/12	Japan Intl. DX Contest	(SSB)
	11/12	Worked All Europe DX Contest	(RTTY)
	25/26	CQ WW DX Contest	(CW)

## VK trans-Tasman 160 m PHONE Results

Bruce Renn VK3JWZ  
Contest Manager  
vktasman@hotmail.com

The VK/ trans-Tasman Contests 160M PHONE Results have now been published on the Contest website:

<http://home.iprimus.com.au/vktasman>

The winner of the 160 metres Trophy (for Overall Winner), is RON TREMAYNE (VK3IO), from Cockatoo, VIC. He also won the certificate for 1st PHONE, and may be among the winners in the 160 m CW (yet to be announced).

2nd PHONE went to Ron Falconer ZL4RMF, in his first VK/ trans-Tasman effort. Unfortunately for Ron, his log score was reduced by application of the

performance factor, leaving him just 34 points below VK3IO's score.

Equal 3rd went to Club station VK2ATZ (Westlakes ARC, Newcastle) and, to VK2CZ David Burger, St Leonards, NSW. VK2ATZ's score was 27 points higher than VK2CZ, but under the Multi-operator rule, did not have the 100 point margin required to claim the outright prize.

1st QRP PHONE went to VK3AAK (Michael Coleman). There were only 2 QRP stations in the Contest.

The number of participating stations and number of logs received, while well up on the first year of this Contest in 2004, was significantly lower than last year.

Propagation was poor although there was no QRN.

73, Bruce Renn VK3JWZ

### Local Contests coming

23 September	Westlakes Cup — Ideal Foundation starter
21 October	RAOTC 30th Anniversary — open all ages

**ROSS HULL in DECEMBER**

### Results CQ RTTY WPX 2006

(VKs only Call\Cat.\Score)

VK6GOM	SOAB High Power	124,509
VK3FM	SOAB High Power	10,325
VK2KM	SO 40 metres	193,052

# Spring VHF-UHF Field Day 2006

John Martin VK3KWA  
Contest manager

## Changes in this year's Contest

For this contest the maximum operating period for stations in Sections B and D has been changed from 6 hours to 8 hours. This will allow stations in these two Sections to work other stations three times during their period of operation, rather than only twice as in previous Field Days.

## Dates

**Saturday and Sunday November 11 and 12, 2006.**

**Duration in all call areas other than VK6:** 0100 UTC Saturday to 0100 UTC Sunday.

**Duration in VK6 only:** 0400 UTC Saturday to 0400 UTC Sunday.

## Sections

- A: Portable station, single operator, 24 hours.
- B: Portable station, single operator, 8 hours.
- C: Portable station, multiple operator, 24 hours.
- D: Portable station, multiple operator, 8 hours.
- E: Home station, 24 hours.

Single operator stations may enter both Section A and Section B. If the winner of Section A has also entered Section B, his log will be excluded from Section B. The same applies to the winner of Section C if the station has also entered Section D.

## General Rules

A station is portable only if all of its equipment is transported to a place which is not the normal location of any amateur station. Operation may be from any location, and stations may change location during the Field Day. You may work stations within your own locator square. Repeater, satellite and crossband contacts are not permitted.

One callsign per station. If two operators set up a joint station with shared equipment, they may choose to enter Section A or B as separate stations under their own callsigns, or Section C or D under a single callsign. If they enter Section A or B, they may not claim contacts with each other. Stations with more than two operators must enter Section C or D. Operators of stations in Section C or D may not make contest exchanges using callsigns other than the club or group callsign.

No contest operation is allowed below 50.150 MHz. Recognised DX calling frequencies must not be used for any contest activity. Suggested procedure is to call on .150 on each band, and QSY up if necessary.

## Contest Exchange

RS (or RST) reports, a serial number, and your four digit Maidenhead locator.

## Repeat Contacts

Stations may be worked again on each band after three hours. If the station is moved to a new location in a different locator square, repeat contacts may be made immediately. If the station moves back into the previous locator square, the three hour limit still applies to stations worked from that square.

## Scoring

For each band, score 10 points for each locator square in which your station operates, plus 10 points for each locator square worked, plus 1 point per contact. Multiply the total by the band multiplier as follows:

6 m    2 m    70 cm    23 cm    Higher  
x 1    x 3    x 5    x 8    x 10

Then total the scores for all bands.

## Logs

Logs should cover the entire operating period and include the following for each contact: UTC time, frequency, station worked, serial numbers and locator numbers exchanged, points claimed.

## Cover Sheet

The cover sheet should contain the names and callsigns of all operators; postal address; station location and Maidenhead locator; the section(s) entered; the scoring table; and a signed declaration that the contest manager's decision will be accepted as final.

Please use the following format for your scoring table. In this example the operator has operated from one locator and worked four locators on each band:

Band	Locators Activated (10 points each)	+ Locators Worked (10 points each)	+ OSOs (1 point each)	x Multiplier	= Band Total
6 m	10	+ 40	+ 40	x 1	= 90
2 m	10	+ 40	+ 30	x 3	= 240
70 cm	10	+ 40	+ 20	x 5	= 350
<b>Overall Total</b>					<b>= 680</b>

A sample cover sheet and scoring table is available on the WIA web site. Copies can also be obtained from the e-mail address given below.

## Entries

Paper logs may be posted to the Manager, VHF-UHF Field Day, 3 Vernal Avenue, Mitcham, Vic 3132.

Electronic logs can be emailed to [vhf-contests@wia.org.au](mailto:vhf-contests@wia.org.au). The following log formats are acceptable: ASCII text, MS Office RTF, DOC, XLS or MDB (Format - Office 2000 or earlier).

Logs must be received by Monday, November 27, 2006. Early logs would be appreciated.

ar



## WIA VHF-UHF FIELD DAY

Section entered:

- A** Single operator 24 hours  
 **B** Single operator 8 hours  
 **C** Multi operator 24 hours  
 **D** Multi operator 8 hours  
 **E** Home station 24 hours

*If entering more than one section, please use a separate copy of this sheet for each section.*

For Section B or D, time period to be scored:

The station operated from the following grid locators:

Date:

Station callsign:

Callsigns and names of all operators:

--

Postal address for notification of results:

--

Postcode:

The station was operated in accordance with the rules and spirit of the contest. I / We agree to accept the Contest Manager's decision as final.

Signed: \_\_\_\_\_

### SCORING TABLE

Band	Locators Activated 10 points each	Locators Worked 10 points each	QSOs made 1 point each	Total	Band Multiplier	Band Total
50 MHz	+	+	=	x	1	=
144 MHz	+	+	=	x	3	=
432 MHz	+	+	=	x	5	=
1296 MHz	+	+	=	x	8	=
2.4 GHz	+	+	=	x	10	=
3.4 GHz	+	+	=	x	10	=
5.7 GHz	+	+	=	x	10	=
10 GHz	+	+	=	x	10	=
Higher	+	+	=	x	10	=

**FINAL TOTAL** = \_\_\_\_\_

# 2006 160 metre VK/trans-Tasman Contest

Bruce Renn VK3JWZ  
Contest Manager

## Complete Results

### "Participation factor"

#### PHONE:

42 ZLs, and 108 VKs participated.  $42/108 = 0.3981$

All ZL "overseas contacts points (not prefix groups), were reduced by multiplying by 0.3981.

#### CW:

15 ZLs, and 30 VKs participated.

$15/30 = 0.50$

All ZLs contacts with VKs (not incl "call prefix groups" bonus), were multiplied by 0.50

### Category 6 (Phone)

	Call sign	Score	Contacts
1st.	VK3IO	1147	153
2nd.	ZL4RMF	1113	118
Equal 3rd.	VK2ATZ (multi-op)	800	154
Equal 3rd.	VK2CZ	773	135
5th.	VK7VH	768	120
6th.	ZL4AA	714	87
7th.	ZL3UR	673	95
8th.	VK2ADB	655	108
9th.	ZL2AGD	606	82
10th.	VK3FRC (multi-op)	577	118
11th.	ZL2RC	551	69
12th.	ZL2CC	528	76
13th.	VK4WR	524	97
14th.	ZL2KO	435	62
15th.	VK2BI	424	56
16th.	VK3AAK/Q	397	66
17th.	VK4QD (multi-op)	362	102
18th.	VK5LA/Q	340	48
19th.	ZL3TT	312	44
20th.	VK2GR	276	68
	VK3JWZ	267	63
21st.	VK7CK	234	54
22nd.	ZL1ALZ	186	26
23rd.	ZL2MS	181	24
24th.	VK2JNA	163	54
25th.	VK7ARN	105	29
26th.	ZL4IM	98	14
27th.	VK3AMW	58	21
28th.	VK2ZEN	50	21
29th.	VK2WL	40	20
30th.	VK4SN	28	14

### Category 7 (QRP Phone)

	Call sign	Score	Contacts
1st.	VK3AAK	397	66
2nd.	VK5LA	340	48

### Category 8 (CW)

	Call sign	Score	Contacts
1st.	ZL6QH	838	91
2nd.	ZL3IX	787	89
3rd.	VK2BJ	737	81
4th.	ZL4AA	724	80
5th.	VK2BPL	722	84
6th.	VK3IO	717	80
7th.	ZL3ARC	552	66
8th.	VK7GN	512	57
9th.	VK2AWD	510	70
10th.	ZL1NI	457	55
11th.	VK3OZ	439	63
12th.	VK2GR	416	56
13th.	VK3FGE	412	56
14th.	VK3DID	353	52
15th.	ZL4IM	241	31
16th.	VK4TGL/Q	182	31
17th.	ZL2CD	173	25
18th.	VK4SN	169	22
19th.	VK7RO	105	15
20th.	ZL2ALJ	104	14
21st.	ZL1ALZ	96	12
22nd.	VK2CJC	25	7

Note: VK3JWZ (Contest Manager) Cat 1 Phone score of 267 is ineligible.

### PERSONALISED QSL CARDS

**Westlakes Amateur Radio Club Inc.**

**VK2ATZ**

PO Box 3001  
Teralba NSW 2284  
Australia

ITU Zone 59  
CQ Zone 30

**Operator's name**

**Confirming Contact with...**

**Rlg:**  **Antenna:**  **Pre-QSL via Bureau**

Date  Time  Freq  Mode  R.S.T

Personalised QSL cards bearing your callsign, Club's name and supplied logo. White gloss card, full colour with WIA logo watermark if a WIA member. Alternative microphone if not. 25 cents per card. Orders in batches of 4, Minimum order 40 cards. plus postage. Email: flusa@optusnet.com.au with details

This is a Westlakes Amateur Radio Club Project

**Don't just sit there twiddling  
your dials.  
Get in the contest, any contest**

## Montenegro's exciting debut

I don't think that any previous new country has had such large scale operations launched at the same time and so soon after being approved for DXCC as Montenegro. I am sure that everyone who wanted a contact with this new country was not disappointed. It will be very interesting to see the statistics of these operations when they are completed. Particularly the breakdown of QSOs, by band and continents, taking into consideration the poor conditions that we are experiencing at the moment.

### Brief details of the stations and operators:

The first team to announce activity from the newest DXCC Entity, The International Montenegro Festival (IMF) group began their activities on July 20th with the callsign 4O3T following an opening ceremony including a luncheon for the participants, and special honoured guests.

The team operated from four different locations along the Adriatic Coast line. The list of operators who took part included -- 9A6AA, A61M, DJ7EO, DJ9ZB, DL3DXX, DL6LAU, DL8OBQ, DL5NAM, DL7AJA, DF3TJ, G3TXF, I0SNY, I8NHJ, IK8HBA, I1JQJ, IK1ADH, IK1PMR, K1ZZ, KA1ZD, K2LEO, K2WR, N6OX, W6OSP, WW5L, LZ1JY, LZ1UQ, LZ2UU, OH2BH, OH2RF, OH2TA, ON4IA, ON4ATW, ON5TN, PA0R, PB2T, S50R, SM0W, SP5XVY, T95A, UA3AB, UA4HBW, UA4HOX, YU1AA, YU3YQ, YT3T, YT6A, YT6T, YT6Y and Z35G. QSL cards to 4O3T go via YT6A: Ranko Boca, Nikole Ljubibratica 78, Herceg Novi, MONTENEGRO.

The second team active from Montenegro used the callsign YU6AO and operators who took part included -- YU6AO, YT1AD, YU1AU, YU1NR, YU7NU, YU7KW, 4N1JA, YT7AW, RA3AUU, RW3QC, RK3AD (?), YU1DX, Z35A, Z32AU, S56A, IZ0BTV, YZ1EW, YU6ST and YZ6DCT. The YU6AO host station operated from the capital city of Podgorica with four

stations. QSL direct to YU6AO, Gojko Mitrovic, Crnojevica 4, 81000 Podgorica, Montenegro or via the bureau. Note YU6AO has been approved for DXCC for QSOs commencing from 0000 GMT, 4th July onwards.

### Laccadive Islands

In reaction to the VU7 announcement recently the National Institute of Amateur Radio (NIAR) from Hyderabad, India released a press release of the upcoming Lakshadweep (Laccadive) DXpedition planned for mid-January 2007. "All the announcements regarding VU7 activity conducted in January, 2007 will be made by NIAR HQ, Hyderabad and NIAR will not be responsible for announcements made by individual participants to any other agency." NIAR cited "the event can only be achieved with collaboration of various agencies of the Government of India including supporting and sponsoring agencies." At this point NIAR wants all participants to keep "correspondence" between themselves and NIAR!

### DXCC News

With the addition of Section II, Criteria Rule 1c) to the Political Entity criteria, certain former separation entities may now qualify as Political Entities. One such entity has been determined to be American Samoa. American Samoa is now a Political Entity for DXCC purposes.

As a result of the reclassification of American Samoa, and upon the filing of a request and substantiating evidence, and with the concurrence of the DXAC and the Awards Committee, Swain's Island has been added to the DXCC List.

Swain's Island, entity number 337, qualifies as the first separation entity from American Samoa, now a Political Entity. The distance between American Samoa and Swain's Island has been determined to be in excess of 350 km as required by DXCC Rules Section II, Paragraph 2, Section b). QSO's made with Swain's Island on or after 0001Z; July 22, 2006 will count for DXCC credit.

July 26th saw the announcement that the following would be activating Swain's Island. The team was lead by JA1BK/KH6BK, Kan; along with him was F6EXV/WH7S, Paul, K1ER, John, AH7C, Tets, K8YSE, John, and KS6FO, Uti (XYL). They commenced operating on July 28 and finally closed on August 2. QSLs for this KH8SI operation via JA1BK.

**KH3 Johnston Island.** YL W7KFI, Susan, had sailed from Pearl Harbour, Hawaii headed for Johnston Island but had to turn back to California instead. Susan, who sails a Hunter 42, is now trying to set off again. She expected to leave California for Hawaii Sunday morning (June 18th) a 16-21 day voyage. After a three-week rest in Hawaii she will be off again heading towards Johnston Island.

**LX Luxembourg.** Five Belgians, OQ0A, OP7A, OO7A, ON6RJ and OR9Q will be active from September 29th to October 1st on 80, 40, 20, 15 and 10 m CW, SSB and RTTY. They will sign LX/ their home call. QSL direct or via the bureau to their individual home callsigns.

**OX3PG, Greenland,** will be active for 11 months starting July 30th 2006. Operator Dwayne KD4POJ plans to be on most bands and modes and get into contests as work permits. QSL direct only, via WA0SMQ.

**P2 Papua-New Guinea,** G3KHZ, SM6CVX and G0LMX will activate the Trobriand Islands, OC-115, from October 2nd to October 10th. QSL's via G3KHZ. Then moving to Daru Island, OC 153, from October 11th to October 14th for this operation QSL via SM6CVX.

**J6/G3XAQ,** Phil Whitchurch G3SWH, has recently got a copy of the log for the 2002 and 2004 operations. QSL cards are now available direct or via an e-mail request for a bureau reply, or via the bureau the old-fashioned way. Phil reminds us that the bureau process is inherently slow. He usually sends outgoing cards via the RSGB once a year.

*continued next page*

# Silent key

## Peter Pavey VK3VB/G3NFT

29.11.1939 - 1.7.2006

Dad was aged 66, born in Exeter, England on 25th November 1939, the last 30 years spent in Australia. His first memory of radio is when he was 5½, listening to the "McMichael" radio chime with Big Ben as the station fired up at 5:30 am.

Over time the "McMichael" moved into the bedroom; an external antenna was added. With the apprentice radio mechanic position having already been taken, Peter started an electrical apprenticeship on 1 January 1955.

The following year Dad visited the "shack" of Tony, the apprentice radio mechanic. Tony later became G3LMT. The afternoon was spent listening to amateurs from around the world. During the next 12 months, they experienced portable operation visiting the local field days. The transmitters were limited to 10 watts DC input CW only. Mains power was not allowed. The passion for portable operation was a lifelong one.

Shortly after a field day, he became aware of an ex-government radio sale and for 10 pounds became the owner of a Marconi CR100. It covered 100 Hz to 30 MHz in 8 bands, with noise blanker, RF & AF gain and an antenna trimmer.

Sensitivity was good for 20 m, but not on 10/15. Dipoles were put up for 10, 15 and 20 metres, a half size G5RV for 40 m and 132 ft wire for 160 metres.

With no courses, it was a case of reading the RSGB Handbook and asking a lot of questions to get a licence! Theory was turned into practice, building 160 metre transmitters, but after 12 months of study he was disappointed to fail his first exam in mid 1958. This led to a trip by bicycle and train to Cardiff, Wales, to sit the exam again in October 1958 – with a pass. Limited exams didn't exist so CW was next and the callsign G3NFT was received on 13th Dec 1958. First contact was at 13:40 on 20 m. More contacts took place on 20 m, 160 m AM and CW that day. Dad's last QSO was with me on the local 70cm repeater the day he went into hospital in June.

1964 saw marriage to Patricia (now VK3OZ) and the gradual arrival of harmonics Paula, Patsy-Ann, Phil (VK3YB), Peter and Petra.

In 1976, the family migrated to Australia settling in Frankston, Victoria. VK3BFA was his first VK callsign and it wasn't

long before a variety of dipoles, beams and quads adorned the roof. Dad changed his callsign to VK3VB and moved to Tooradin in 1985. This gave enough room for the long-held dream tower and beam. The Nally tower and Log Periodic cannot be missed as you drive down the highway.

While at Frankston, Dad joined the Frankston and Mornington Peninsula Amateur Radio Club and encouraged me to get my licence. Since 1991, he has been an active member of the Gippsland Gate Radio and Electronics Club Inc, including serving as President. His passion was for CW and portable operation, but he had a keen hunger to learn about any aspect of our great hobby, which saw experimentation with ATV, weak signal VHF/UHF and 6 m SSB. Many local amateurs are on-air today after sitting exams at his QTH and learning CW from Peter.

Peter is survived by his wife Patricia VK3OZ and harmonics Paula, Patsy-Ann, Phil and Peter.

Amateur radio has truly lost one of its gentlemen.

submitted by Phil VK3YB

## DX News & Views continued

He plans to go LOTW at some point in the future.

**BX3/DJ3KR.** Jurgen will be on the air as BX3/DJ3KR from the end of September until early November.

**VQ9LA.** Larry, will be on the island for another year, scheduled to leave in December 2007. His company's contract has been renewed. His Alpha 99 and FT-1000 are both being repaired, his K9AY receiving loop is going to be fixed and he expects to have four Beverages switchable to use on receive this year. He still has some "AM hash" but says there's not much more he can do.

**ZM8CW.** Jacky hopes to go back to ZL8 later this year, says Ron, ZL1AMO, who is handling the QSLs for the recent operation. Jacky could not stay more than five days and he was only able to operate

for four days during his spare time. He reported that band conditions were very bad as he noticed weak signals and high noise on most of the bands. Jacky tried 160, 80, 15, 12 and 10 metres without much joy. He made just under 2,000 contacts on 17 through 40 metres CW only.

**FH Mayotte Island.** A two-man team from Germany has announced they will be operating from here starting at the end of August through to September 11th. Look for DL2RUM, Tom, and DJ8NK, Jan, to be QRV as TX5T and TX5NK. Plans are to be active on 6 through 160 metres on CW, SSB and RTTY. QSL via home calls.

Having trouble finding an address for a certain Russian station? K3ZO, Fred Laun, suggests trying <http://ric.cqham.ru/>.

The resulting addresses are in Russian Cyrillic script, however if you print out the address on your printer, paste it on an envelope and write "Russia" you are good to go!

**YX5IOTA - La Tortuga Island (SA-044)** Members of the 4M5DX Group along with the support of MDXC plan to operate YX5IOTA from September 24th to 30th. Team members will include: YV5ANT, YV5KAJ, YV5WW (OH0XX), YV5TX, YV5MSG, YY5RED, YY1RDX, YV1FM, YV5SSB, YY5HBO, YY1ALE, YV1CTE, YV5OHW and YY4MP. They will be QRV on all bands and modes. QSL via IT9DAA.

Special thanks to the authors of *The Daily DX* (W3UR) and *425 Dx News* (IIJQJ) for information appearing in this month's *DX News & Views*.

ar

## Weak Signal

David Smith - VK3HZ

It's great to see our newest arrivals to amateur radio taking a keen interest in weak signal VHF/UHF operation. One such person is 14-year-old Tom VK4FTDX located at Glendon, about 180 km west of Mackay. Tom is running an IC-706 to a 12-element homebrew wide-spaced Yagi up about 13 m.

On the morning of July 31st, conditions were very good in his area and at around 6.30 am he heard the Toowoomba beacon (716 km) on 144.440 MHz at S9+30 dB. On 2 m, he managed to work VK4TZL (5/5, 688 km), VK4JMC (5/9+, 827 km), VK4AFL (5/9, 854 km), VK4KDD (5/3, 845 km) and VK4ARN (5/6, 871 km). Well done Tom, and keep up the good work.

On August 10th, favourable weather conditions produced some good propagation across the southern part of the country. Ron VK3AFW in Melbourne reports:

*Usually we associate mid winter troppo with inland DX, but this morning we had summer-like conditions in the SE. I noted that I could work the Mt William 2 m repeater in central-west Victoria, something that occurs reasonably regularly, but then Jim VK3II, reported that Phil VK5AKK, was calling CQ on 144.200 a few minutes before 9:00 am local. I swung the beam and asked Phil to QSY to 144.180. Phil peaked 5x9 but there was noticeable QSB. He gave me 5x7. John VK3ACA, also worked Phil and Ken VK3ALA, in Jindivik, Gippsland, was copying Phil but wasn't able to get a clear channel and complete the QSO. I announced I was going to 144.1 where I worked Brian VK5UBC in Gawler at 4x1 - he gave me 5x1. Gary VK5ZK, in Goolwa then called me and his signal was easy copy although not getting above S2. I didn't hear any one else. Fred VK3AZG copied Phil with his beam NE but had no copy of Brian or Gary with his beam West North West. That's not his best direction. A check of the beacons showed the 2 m VK5VF beacon at a steady 5x1 with little QSB. Channel 5A sound from Mt Dundas very strong. A high of 1031*

*mB and Hepburn says fair to moderate across the path.*

Thanks for that, Ron. Brian VK5UBC also had some good contacts that morning:

*I managed to work the following on 2m SSB: VK2KRR (5/7, 760km), VK2EMA (5/1, 840 km), VK3II (5/5, 730 km), VK3ATS (5/9, 300 km), VK3LY (5/7, 328 km), VK5DK (5/9, 400 km) and VK3AFW (5/1, 660 km). On 70 cm, I worked VK3ATS (5/7, 300 km) and VK5DK (5/7, 400 km). Also was able to work several interstate repeaters with good contacts on Mt Macedon and Albury/Wodonga 2 m repeaters.*

## New Microwave ATV Records

On Saturday August 5, Nick VK2ZTY and Jack VK2TRF completed a record 195.2 km 2415 MHz ATV QSO. Nick was located on Mt Nardi, north of Lismore and Jack, with Dan VK2GG, was at a point about 40 km west of Dorrigo near Ebor. Nick used 25 W into a 22 dB gridpack antenna while Jack had 18 W into an identical antenna. Picture quality at both ends was P5++ meaning no noise or interference at all.

Two days later, Jack travelled to Mt Nardi with his 10 GHz gear and Dan was joined by Gary VK2UNI. After waiting most of the day for rain to clear along the path (10GHz doesn't like getting wet on a direct path), contact was made just before 4 pm. A two-way QSO was completed with P4 signals at the Mt Nardi end and P3 signals at the Dorrigo end. Dan used a 1.2 m dish for receive while Jack used a 1 W transmitter into a 17 dB horn about 7.5 cm across. Dan then fired up his 200 mW transmitter into his 60 cm dish and Jack received the signals on another 17 dB horn. Both systems were on 10236 MHz. The path was 194.4 km, as Jack had to descend the mountain to avoid some trees which are impervious to 10GHz.

Both of these contacts are, as yet, unofficial VK records.

## EME

Hot on the heels of the news in July's column of Alan VK3XPD completing the first VK EME contact on 5.7 GHz, another VK3 has now become active on 5.7 GHz EME after a lot of work. Charlie VK3NX reports:

*Having spent the better part of 18 months trying to perfect my "QRP" setup on 5.7 GHz along with a QTH move etc., I finally had the very encouraging result in the first week of August of hearing my own echoes on 5.7 GHz EME. Hot on the heels of Alan VK3XPD, who became the first VK to establish a 5.7 GHz QSO on the EME path, on the 10th August I had the very rewarding experience of completing a QSO with the OKIKIR team. Signal reports were a very "easy" O report both ways. The QSO took 15 minutes to complete and it was a challenge tracking the moon, Doppler shift, and conducting a CW contact all at once with very little margin for error! Nonetheless, after many trials and tribulations, I was pleased to make the QSO with my first attempt at the new QTH and with the new setup. The circular feed on this band made all the difference, compared with previously failed attempts running linear polarisation, as the European stations on this band are all running CP. (Fading seemed to be non-existent, however a 15 min QSO is no real indicator). Equipment at VK3NX consists of all homebrew equipment: using an N1BWT-design transverter, numerous PA stages to arrive at 20 W at the feed point, approx 0.7 dB NF 30 dB gain LNA followed by another LNA prior to mixer. Dish is 3.7 m. Feed is VE4MA with "circular polarising screws" with actuator drive for both azimuth and elevation. Control is via PICAXE-based software. Moon tracking is via a logarithmic detector (operating on a sub receiver channel on 144 MHz) to track moon noise. The 2 m IF driver is an IC746. I hope to continue on 5.7 GHz EME with a number of "improvements", until all possible QSO partners have been exhausted.*

## Birthday Greetings

Finally, one of our most well respected VHF DX operators celebrated his 95th birthday on August 11th. Wally Green VK6WG, in Albany, is one of the most active VHF DX operators on the VK6 south coast and is usually worked at least once during the summer months by stations in the eastern states.

Wally still holds the Australian records for 1296 MHz (2455 km), 2.4 GHz (1885 km) and 3.3 GHz (1885 km).

Everyone in the east hopes to hear Wally's signals again soon.

(Thanks to Leigh VK2KRR and Wally VK6KZ for that information).

Please send any Weak Signal reports to David VK3HZ at vk3hz@wia.org.au.

Charlie VK3NX's 3.7 m EME Dish looking towards the moon

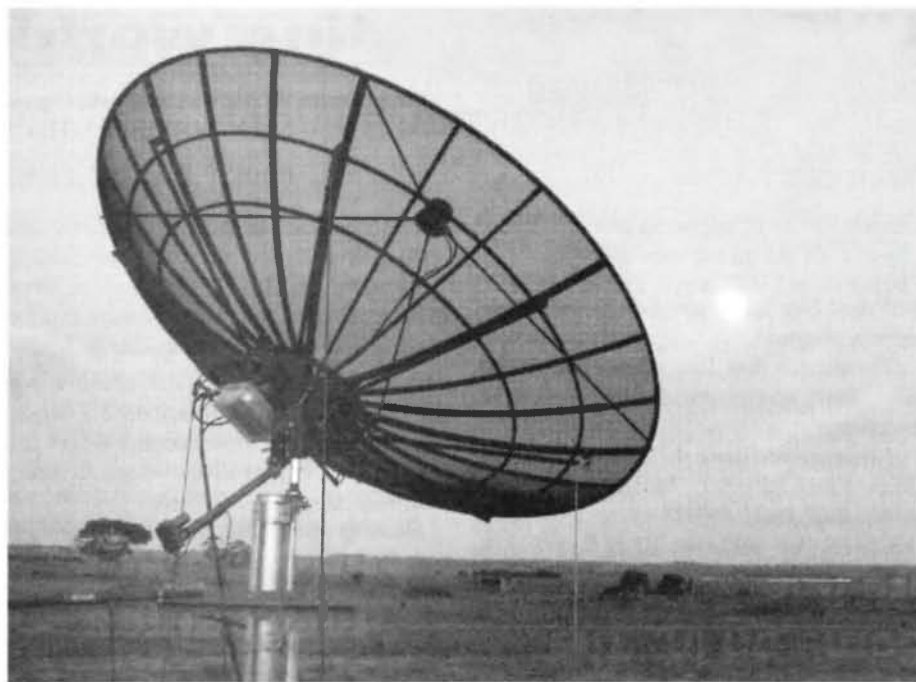

## Digital DX Modes

### Rex Moncur – VK7MO

Joe Taylor K1JT has released a new version of WSJT - version 5.9.5 - which is available from his web site at <http://pulsar.princeton.edu/~joe/K1JT/>. He has also released a new "User's Guide and Reference Manual" which is available from the same site. The most important features of the new version are a dramatic reduction in false decodes and an improved AFC and Sync system for JT65c, that allows the program to cope better with frequency drift and libration effects on 1296 MHz. VK4AFL (3.7 meter dish) and VK7MO (2.3 meter dish) have found that through the use of the new version they have been able to complete 1296 MHz EME contacts at 10 watts whereas they previously required 20 watts. Decodes have also been achieved both ways at 5 watts.

There has been one important operational change. With previous versions, it was general practice in VK to use the second TX line and replace the grid square with a dB level report such as in the following format:

VK7MO VK4AFL -27 OOO

It appears that overseas practice was to send either the -27 report or OOO report but not both. Unlike the old version, the new version does not respond to messages with both systems of reporting which

has trapped a number of us in VK. With new version you can use either reporting system but not both – thus the options are:

VK7MO VK4AFL -27

VK7MO VK4AFL QG62 OOO

Trevor VK4AFL reports, "With the new version I have not received one false decode in a few hours of operating QRP EME but when I once reverted to the previous version I immediately encountered false decodes". The improvement in false decodes is very impressive. But it is first useful to explain that there are two types of false decodes as follows:

1. False Positives: These occur when you receive a message (eg callsign or signal report) from the station you are working in error and thus you might believe you have completed a QSO but it would be invalid.
2. False Negatives: These are when you see an odd callsign which is easy to recognise as being false. These do not lead to invalid QSOs because if you call them they will not respond and if you see them later in a QSO you just reject them.

In practice, it is the False Negatives that dominate and, while these can be annoying, one needs to be aware that they

do not lead to invalid QSOs. We are faced with the conundrum that it is the False Negatives that you see – but these don't matter – but it is the False Positives that you are not aware of that do matter. The way to get a handle on the False Positives is to do simulation tests by looking for a particular callsign, which is not being transmitted, as an indicator of the rate of False Positive Errors. For example, I look for the callsign VK3AYH (which I include in the call.txt file) as an indicator of False Positives when the message being transmitted is to VK3AXH.

I have done simulation tests under worst case conditions designed to stimulate the maximum number of false decodes. These worst case conditions are with the signal at -29 dB, and the program set to "aggressive", "exhaustive", "sync" = 0 and "freeze/tolerance" disabled and with the Deep Search decoder using the full call.txt list of 4720 callsigns. With the older software version, 5.9.4, I found the rate of false decodes was almost 50% under these extreme settings, but of these only 0.01% were False Positives that could lead to an invalid QSO. The False Positive error rates increase by a factor of about 10 to around 0.1% when "Sked" was enabled.

With the new version, the rate of false

decodes dropped to 0.3% and the error rate for False Positives is so small that I could not find one. From tests on the earlier version it was found that the rate of False Positives could be derived from the false decodes divided by the random chance that the expected message would be found on the list. If this also applies to the new version, as one would expect, the error rate for False Positives would drop to around 0.0001%. As for the earlier version, I would expect this error rate to increase by a factor of about 10 if "Sked" is enabled.

Now I qualify this by saying that all the above tests were with white noise and the rates will increase under "on-air" conditions with birdies and interfering signals. While it is early days and I have completed only about 15 hours on air testing I have not seen one false decode with the new version.

In an attempt to stimulate the rate of False Decodes in the "Real World" situation, I have left the program running for almost two days on 144 MHz with the antenna beaming over the CBD of Hobart to produce lots of birdies and rubbish. I again used the extreme settings with sync set to 0 so it gains sync almost every time from the Hobart "rubbish" and attempts a decode from this "rubbish". I used two receiving computers, one set to Sked and the other using the full call.txt list of 4720 callsigns. The one set to Sked gave no False Positives in some 40 hours of testing. The one set to the full list gave an increased False Positive Error Rate of 0.0006%. While I would need a lot more

data it seems reasonable to assume the rate for Sked would again be around 10 times higher at around 0.006%.

As the error rates measured above are for individual decodes and at least four messages must be exchanged the actual error rate could be four times higher if these worst-case conditions pertained for every message of the QSO. However, with typical QSB this is extremely unlikely and a doubling of the error rates is a more reasonable, but still conservative, figure in practice for a complete QSO. Based on doubling of the individual error rates the Table below gives an indicative percentage level of confidence one can have with JT65 QSOs in marginal conditions where all extreme settings are used.

The figures in this table are based on extreme settings designed to "stress test" the program to its limit and are thus very conservative. Error rates will be much lower if one, for example, sets sync to 1 as recommended by the program's author or if the signal is slightly stronger than -29 dB.

I suspect most people would consider that even 98% confidence, with the old version in a noisy environment with sked enabled was acceptable. However, some have had a concern when they saw False decodes of the False Negative type even though these were readily rejected. The substantial improvement with the new version should allay any lingering fears.

Please send any Digital DX Modes reports to Rex VK7MO at rmoncur@bigpond.net.au.

Version	Country Environment on 144 MHz or City on 1296 MHz, No birdies	City Environment on 144 MHz With birdies and "Rubbish"
5.9.4 Sked enabled	99.8 %	98 %
5.9.4 Full call.txt file	99.98 %	99.8 %
5.9.5 Sked enabled	99.998 %	99.98 %
5.9.6 Full call.txt file	99.9998 %	99.998 %

*continued next page*

**Do you know an amateur who isn't a WIA member.**

**Invite them to 'Come on in, the waves are fine'.**

# Amateur Radio Bookshop

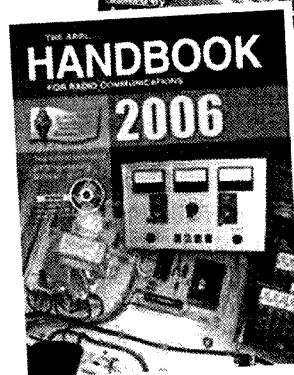
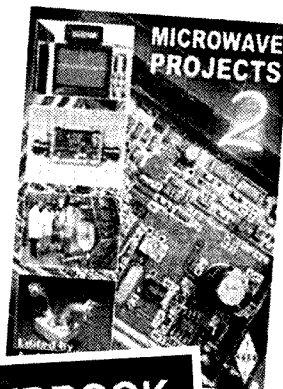

Download our catalogue at

<http://www.wia.org.au>

Amateur Radio Bookshop  
PO BOX 3084  
EAST BLAXLAND  
NSW 2774  
Office: WIA National Office  
Tel 03 9528-5962  
Fax 03 9523-8191  
bookshop@wia.org.au

**ARRL - RSGB  
publications  
books  
magazines  
CDROMs - DVDs**

# The Magic Band – 6 m DX

**Brian Cleland – VK5UBC**

Not a lot of activity on 6 m during the July period with only a few sporadic E openings.

On 18th July, Wayne VK4WS worked VK3's VG, DUT, WN, XQ and VK5UBC.

The afternoon of 1st August saw the band open for several hours covering a large area of the eastern states and SA with John VK4FNQ Charters Towers in Northern Queensland having several contacts into VK2, 3 & 5 and Brian VK5UBC into VK2 & 4.

On 2nd August, an opening occurred between VK4 (Sunshine Coast area) and VK5 with VK5AKM and VK5UBC working VK4's ID, AHW, ADM & CWJ.

Noel VK3FI (VK3FGN) advises that the Mildura 6 m beacon is still operational using the callsign VK3FGN on 52.438 MHz, however it is only running low power of about 3 watts into a J pole at about 15 feet on top of a communications building in Mildura.

It is hoped that the Mildura site will be a temporary situation if the antenna at the old location on the Merbein water tower can be repaired.

There should be some big signals out of the Launceston area this summer. Joe VK7JG advised that, because the rotator could not handle the wind loading, he has replaced his 9-element 2WL 6 m beam

In its place is a 7-element M2JHV which is about 8 feet shorter for only a loss of 1 dB and half the wind loading.

Since erecting the aerial, Joe has worked VK4BT and VK4ADM on 3/7/06 and VK4CZ and VK4DMI on 23/7/06.

Norm VK7AC is now the owner of Joe's old antenna. Meanwhile Karl VK7HDX is building a 6 m Moxon antenna. It will be interesting to see how it performs.

Peter VK5ZLX in the Barossa Valley is gradually installing (or should that be 'onstalling') his antennas on a newly erected tower.

To date, Peter has got his 2 m & 70 cm antennas up and shortly will be erecting his 9 el M2 6 m beam which he used with great success in Alice Springs.

Please remember to send any 6 m information to Brian VK5UBC at [bcleland@picknowl.com.au](mailto:bcleland@picknowl.com.au).

**ar**



Norm VK7AC's Antennas - from top, 18 el 2 m, 9 el 6 m, 3el StepIR

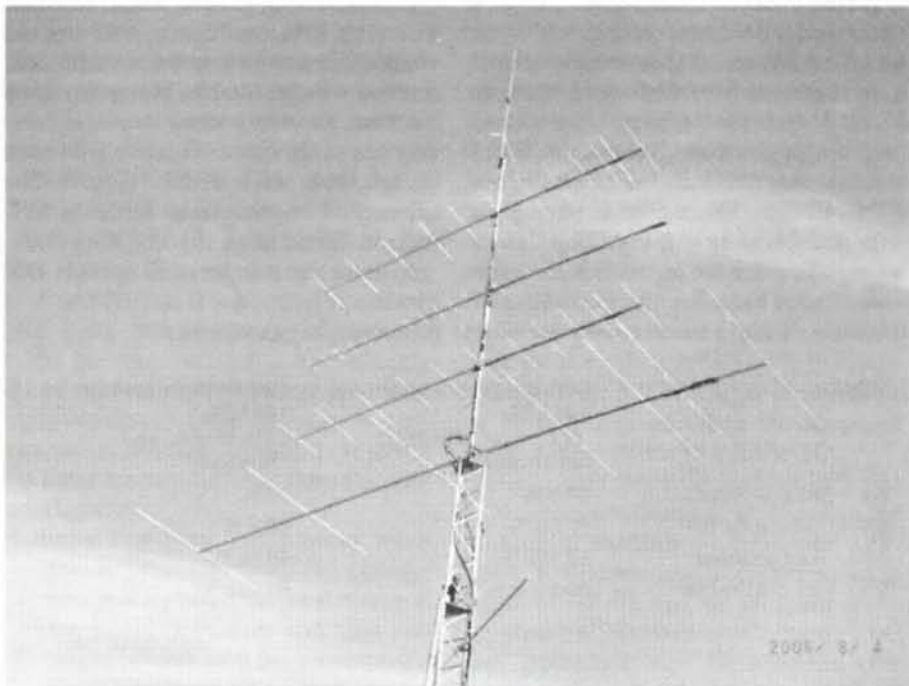

Joe VK7JG's Antennas - from top, 2 m 12 el, 28 el 70 cm, 2 m 12 el, 7 el M2JHV 6 m

**Do you have a story to tell about amateur radio?**

**Perhaps about a DXpedition, or a piece of gear you have built.**

**Maybe you are into experimental stuff.**

**No matter what, if it is about amateur radio you will have an audience in these pages. So get to it, contact the editor, tell him what you have and he will let you know how to go about getting your name (and topic) in print.**



## Preparing your station for the High Earth Orbiters

A word of caution before we begin part-2

The satellite game is very dynamic. Just how quickly it can change was demonstrated in late July when the Eaglepedia site at [amsat.org](http://amsat.org) contained some news that has the potential to impact heavily on all future Oscars. I mentioned "Eaglepedia" last month. It is a site within a site, which allows the Eagle development team to keep everyone informed about the latest ideas concerning the design and construction of the new Eagle high orbit satellite. The team made some preliminary announcements, which on the surface could throw several spanners in the works. Their exhaustive study of the currently most favoured bands, U, L and S has shown that perhaps even before Eagle is launched

these bands will be almost useless for amateur radio satellite downlinks and may well be unsuitable for uplinks. That has caused them to undertake a major re-think of the whole design; consequently, users of all future Oscars will need to be prepared to make changes in their ground station requirements. The relentless march of domestic computer based communications technology and networking is already biting deep into L-band and making S-band unusable in city environments around the world.

The deployment of the European Galileo GNSS (GPS competitor) navigation system is poised to have a detrimental effect on all serious weak signal work. Satellite design teams must use their crystal ball to look 10 years or more down the line when making fundamental decisions regarding frequencies, bands and modes. Government agencies move quickly to protect new communications technology from interference and in some countries transmission on L-band has already been severely curtailed due to its potential for interference with the new "essential" services. No such protection is afforded amateur radio activities however from the ever-increasing noise floor caused by wireless computer communications. The Eagle team has

predicted that with the launch of Eagle still being about 4 years away, inclusion of any facilities for L-band and S-band may well be a waste of time except perhaps for some telemetry downlinks.

Does this mean we are to be denied two of the bands that were emerging as optimum just one satellite generation ago? Perhaps it does. Early in the last column, I mentioned that L-band and S-band would run on the two up-coming high orbit birds. P3E is at a much later stage of development than Eagle and it will have facilities for L and S bands, which will allow AO-40 type ground stations to take part. Now just a month later, it looks very much like this will not be the case with Eagle. I again urge you to keep an eye on Eaglepedia on the AMSAT web site and to keep an eye on the AMSAT-DL web site, especially if you are in the process of planning your HEO ground station. P3E should give us some years of operation on these bands and if you are out of town, the noise floor problem may not bite as deeply. However, the long-term future of L and S bands on amateur radio satellites could well be influenced by events already underway in the all-consuming world of domestic entertainment and communications. So – taking all that on board, back to the plot!

### The AMSAT group in Australia

The National Co-ordinator of AMSAT-VK is Graham Ratcliff VK5AGR. Contact Graham if you wish to be placed on a mailing list for breaking news and net reminders. As a forum for members AMSAT-VK operates two monthly nets.

### AMSAT-Australia Echolink Net

The "Echolink" net meets on the second Sunday of each month. Anyone with an interest in Amateur Radio Satellites is welcome to join the net. Graham VK5AGR acts as net controller. The net starts at 0500UTC during summer time periods and 0600UTC during winter standard time periods. Connect to the AMSAT conference server on Echolink a few minutes before these times.

### AMSAT-Australia HF net

The HF net meets informally on the second Sunday of each month. In winter (end of March until the end of October) the net meets on 3.685 MHz at 1000 UTC. In summer (end of October until end of March) the net meets on 7.068 MHz at 0900 UTC. Start listening 15 minutes before these times.

All communication regarding AMSAT-Australia matters can be addressed to:

AMSAT-VK,  
9 Homer Rd,  
Clarence Park, SA. 5034

Graham's e-mail address is:  
[vk5agr@amsat.org](mailto:vk5agr@amsat.org)

## Part-2 Antenna requirements for working the High Earth Orbiters

If you have convinced yourself that it might be worth the effort to have a serious go at the HEOs: Let's look at some of the questions that arise – and there are quite a few. This is where you decide if you are serious or not! How much antenna gain do you need? What is Circular Polarisation? Do you need it? Do you need to switch polarity? Do you need elevation rotation? What about receive pre-amplifiers? Realistic gain and noise figures. Where should you fit them? Is manual control good enough or do you need auto-tracking? Is "flip-over" mode worthwhile? I am going to take time to discuss some of the myths associated with these topics and see if we can separate them from the realities.

### The first myth - how much gain can you expect from any VHF/UHF Yagi?

Glossy brochures can be deceptive and will always put the best "spin" on any product. However - real antenna gain is of utmost importance in any weak signal endeavour. Published gain figures aim to sell antennas. You will sometimes see them quoted in dB. "Our 'ionosphere-buster' has a hefty 22 dB gain". Looks exciting but means nothing. The decibel is a comparative expression, not an absolute one like Amps. The antenna gain should be expressed in comparison to some standardised radiating source. It

is often a reference dipole, in which case the gain would be quoted as so many dBd (dB gain compared to a dipole) or dBi, if comparison is made to a theoretical isotropic (point) source. Front to back ratios can be correctly expressed in dB, as can comparisons between the performance of different antennas. This situation became so serious several years ago that some amateur radio magazines refused to accept advertising matter from antenna manufacturers that contained gain claims. This was not to suggest dishonesty but rather to prevent confusion among unwary readers, the magazine editor often getting the blame for unreal claims.

The story does not end with commercial antennas either. Authors and designers, anxious to sell their new ideas may be tempted to exaggerate. Therefore, here are some tips. Begin by reading the fine print. Do not take notice of gain claims that are not expressed in meaningful terms, either dBd or dBi. Be cautious of amateur designs unless presented by a recognised guru and backed up by peer review with repeatable measurements. If you decide to build from an established design, remember that it is in your hands to follow the original design faithfully – and do not blame the designer if you cut corners and it does not measure up in the end.

Be careful of “word-of-mouth”. Some people are unwilling to admit they bought a ‘lemon’ and on the other hand, some are reluctant to admit they messed up the construction. So set your sights realistically. A gain figure of 20 dBd on two metres is very eye-catching. It is also difficult to attain in practice even with long booms or multiple Yagis working in concert. Gain claims of 12 to 15 dBi for a single long crossed Yagi are likely to be reasonable, if they come from reputable manufacturers or designers who properly submit their designs to peer review before printing. I would be suspicious of higher figures unless they were for very long Yagis with their attendant construction and handling difficulties. A look at the link budgets of the various modes/satellites will show that if you can achieve a real 10-12 dBi on VHF and 12-15 dBi on UHF you will be in the running. Remember you have to double the boom length of a Yagi to get an extra 2.8 dB gain and sheer size quickly becomes a problem at two metres wavelength. Remember too that if the satellite is using circular polarisation, as many do, you will lose a precious 3 dB if

your antenna is linearly polarised. CP will be discussed next. Pretty well all serious operators venturing onto 1.2 or 2.4 GHz will use a dish of some sort and in that case, real gain figures approaching and exceeding 20 dBi can be achieved using medium to larger dishes and simple feeds. Such figures are indeed desirable to do consistently good work on “L” and “S” bands. On “U” and “V” bands however, most operators will use Yagis where physical size quickly becomes a problem in limiting realistic gain.

## Now, what is all this fuss about circular polarisation?

It stems from the fact that all satellites, even those in the lowest orbits, spend their lives outside the ionosphere. Normal ionospheric refraction does not play much of a part, except for those, very few nowadays that carry HF modes when it can produce some interesting over-the-horizon effects. In general terms and neglecting bending and ducting that happens at some times of the year, mostly at lower angles of penetration, VHF/UHF/MW signals from the high orbiters in question will pass right through the ionosphere without much in the way of refraction, reflection or attenuation. However - there is a fly in the ointment, a large one. The signals both up and down will suffer something called Faraday rotation. The polarisation will change during the journey through the ionospheric layers. The rotation is random and therefore quite unpredictable. It can be slow or rapid and it increases at lower elevation angles. Anyone who has ever worked Scandinavia via Oscars 10, 13 or 40 at 0 to 5 degrees elevation with the bird around apogee will know what I am talking about. Circular polarisation (CP) will help overcome this effect. In short then, if you are going to get serious about HEO satellite operation, CP is highly recommended.

There is a further problem however. CP has a “hand” or a direction of rotation. You can have either right-hand CP or left-hand CP – and ne’er the twain shall meet. There is an enormous price to pay for getting it wrong and it is not always easy to get it right. Even NASA got it wrong on one famous occasion and they almost lost an expensive spacecraft. The hand of polarisation of antennas like the helix is easy to tell apart. A helix wound

for right-hand CP (RHCP) will look like a right-hand thread. It is as simple as that. You need the same “hand” of polarisation at both ends; get one end wrong and signals just disappear. Yagis with phasing harnesses are not so easy to determine. Patch antennas can be difficult to the casual glance. That is where switching comes in handy, then you have the choice of either hand. Switching also takes care of the fact that some satellites use RHCP and others LHCP. Still others use linear polarisation or combinations of all. This can be for various reasons, but it is often done to reduce receiver desensing on the satellite.

In summary, switchable CP is a very attractive proposition for the serious satellite operator and as a result, most operators take the trouble to implement it.

## Do you need that elevation rotator?

Back in the early days when AZ/EL rotators were virtually unobtainable or impossibly expensive, we used the trick of mounting the Yagi boom permanently at an elevation angle of 20 degrees or so. Using short Yagis with moderate gain, it meant that the beam-width of the Yagi would cover pretty well from horizon level to about 45-50 degrees. Some bright spark had worked out that 90% or so of available satellite passes were within this range, so if you were prepared to miss out on a few very high angle passes, you didn’t need an elevation rotator. That worked well for LEOs and still does today but do not expect it to work on the HEOs. To begin with you need more gain and more gain means narrower beamwidth. If you go to the trouble of building an antenna system with enough real gain to work a HEO reliably at apogee you can forget about fixed elevation as an option. Therefore, the answer is yes, you do need elevation rotation control if you are going to pursue seriously the HEOs.

## Do you really need that receive pre-amplifier?

“But my radio’s got a built-in preamplifier”. You often hear this plea when the topic comes up. All radios are built to a price. The pre-amp in your radio will be good enough for most amateur radio purposes. If however you have committed yourself to the cause of working the HEOs or doing other weak-signal work, you will probably find it is simply not good

enough. There are two main reasons. One – the gain or more likely, the noise figure may be found wanting and – two – being inside your radio, it is in the wrong spot. Why? To exploit the virtues of your u-beaut pre-amp, it needs to be as close to the feed point of the antennas as possible. One may argue that the two-metre band is marginal in this respect and I will come to that in a moment. As the frequency increases, it becomes more and more important to locate it upstairs. No serious operator would think of mounting a 2.4 GHz antenna at the “mast” end of 50 metres or even 10 metres of co-axial cable and the down-converter or pre-amp at the “shack” end. You would not hear anything! GPS receivers are a case in point. The main antenna element is an integral part of the first active solid-state device. Early ones were gold plated and pressure welded to the input gate of the GaAs FET. The idea is to reduce the number of noise-producing components between the antenna element and the device that sets the system noise figure.

The same principle applies to satellite earth station antennas and any other weak signal applications. Sky noise from all sources, solar, planetary and galactic diminishes as the frequency increases, finally leaving only the “microwave background radiation” hiss of about 3 degrees Kelvin. According to Kraus, the average sky temperature at 150 MHz is about 290 K. Again, according to the same source, this equates to approximately 3dB in terms of noise figure. Some people use this to mount an argument for not bothering about mast mounting your 2 m pre-amp. My first excursion into this kind of practice was with the NOAA weather satellites some 20 years ago. A good set of “filtered ears” can fill in many gaps in ordinary voice communications. However, when it comes to data, and in particular, picture data, missed data is missed forever and you end up with gaps in the pictures or noise-bands right across if the losses are great enough. I was astonished at how much the results improved when I mounted the pre-amplifier on the boom of the cross-Yagi, adjacent to the feed point. No more missed lines. No more missed pixels. Just a perfect picture from horizon to horizon.

Remember all this was happening on 138 MHz, not all that far from our 2 m band. That experience convinced me that it was well worth the effort of weather proofing even a 2 m pre-amp and mast mounting it. The best way I can explain

this goes back to Kraus’s ‘average’ sky noise. There are some very powerful noise sources out there in galaxy-land but in general, they are point sources and widely separated in the sky. Their sheer intensity brings the average up but your antenna is not very often going to be pointing directly at one when following a satellite across the sky. You can neglect this point if you wish but you will never know the real potential of your system if you do. It can make the difference between strong signals and weak signals, between perfect readability and signal lost in noise. It means you will need a totally weatherproof pre-amp enclosure. It means mounting it on the boom right alongside the driven element. If you are going to transmit using that antenna, it means switching relays in-built. Again, it looks like a real chore. Most serious operators would not consider any other approach at UHF and microwaves. It does not matter if you are going to build or buy, go for a gain of about 15-20 dB and a noise figure of less than one dB. Many transistors will give these figures in standard designs and a host of relatively cheap pre-amps and kits on the market meet these figures.

## Auto-track or manual control?

If you have made a wise choice of rotators, auto-tracking is a breeze. There is no reason why any HEO operator should not use it. We all have a computer of some sort in the shack these days. I use a Kansas City Tracker/Tuner, the ubiquitous KCT/T. It takes care of automatically tuning for Doppler correction as well as tracking the antennas. The KCT/T is decades old now and requires a computer with ISA slots. Remember them? Like me, you are showing your age if you do. However, the KCT/T is a robust unit that does it all and still works perfectly, so it still graces my radio desk inside an ancient Pentium-1 box running Win98. That so many of these units are still in service is a credit to the original design. The original DOS software is rarely used these days. The development of WiSP produced a very smooth software package, which ruled in the world of digi-sats.

Today, more choices are available. A web search will reveal many tracker designs. Some are in kit form. Some come fully assembled and working. All need to connect to the rotators and most to a computer. Some follow the ideas of

the older designs like the “Track-boxes” and “Sat-Trackers” which came with a special purpose processor built in. These days, software does more and more of the clever stuff. Again, whether you decide to build or buy, the greatest boon to any amateur satellite ground station is the auto-tracker. Before you make a decision, an inquiry on the bulletin board will elicit plenty of advice.

## Do you need to implement “flip-over” configuration?

Data reception from LEO satellites makes a flip-over system an almost essential requirement of your tracking system, regardless of the data type – pictures or mailbox. To get maximum data transfer during a pass, you need to consider what happens when a satellite crosses your location almost overhead and makes your system want to change the azimuth direction from say 179 to 180 and then to 181 degrees. In other words, for the rotator to “go through south”. The NOAA satellites mentioned earlier often do this and I learned very quickly just how easily pictures could get totally messed up by missed and irretrievable data. Reason: Most rotators sold in the southern hemisphere have a mechanical stop at south. You cannot rotate through south. The rotator has to go right back around the full 360 degrees to get from 179 to 181 degrees azimuth. Your rotator driver will take care of this, but while the antennas are moving – this usually takes about a minute – you will not be getting any data. Flip-over mode takes care of this but many people are frightened of it because if you get it wrong, it could tangle up your cables and antennas in the most frightful mess.

The HEO satellites are not usually as demanding, as they do not as often “go through south”, but depending on the orbit, they could. My suggestion is to have a good look at flip-over mode. Do not be afraid of it. I know of many stations including my own where it has been in operation for years with no mishaps, no tangles. It takes a bit of thought and effort to set up but I believe it is worth that effort particularly in the case of data downloading.

Keep watching Eaglepedia. I will try to summarise what is happening there next month.

# Hamads classifieds **FREE**

## FOR SALE NSW

•Complete multimode 144 MHz transceiver. Yaesu FT-290R with Microwave Modules 30 W linear amplifier and receiver preamp. Mounting bracket and manuals included, \$250 + freight. Ron VK2WB 02 4232 1794.

•Ten-Tec 20/6 metres converter, brand new and in mint condition, 10 watts output \$200. Yaesu FT-290RMkII with matching Yaesu FT-2025 linear amplifier (25 watts), comes with rubber flexible antenna, NiCads and mobile cradle \$390. Yaesu FT-1500 2 m mobile FM, 50 watts output, in mint condition, with mike, mobile mounting bracket, etc. Original package. \$300. Ramsey CT-70 frequency counter, goes up to 600 MHz, with Ni-Cads and manual, in perfect condition \$85. Kenwood SW-100 SWR/power meter, 140-450 MHz, power range 0-150 watts, in perfect condition \$95. Mirel VK2BOD, email adslqls8@tpg.com.au, Phone 02 4333 1823.

•Yaesu FT-817. In original packing with all standard accessories plus FNB82 NiCad battery. Mint condition. S/N 2M630057 \$800. or ONO. John VK2FIZZ

## WANTED NSW

•Yaesu FT-230R in good condition. No mods. VK2LY 02 9874 5050.

•Copy circuit diagram and parts list plus operator's instructions for AWA distortion noise meter 3 A56068, also same for Nordmende TN6001 "Globertrotter" receiver. Costs reimbursed. John VK2ZCG QTHR 02 9521 5181

## FOR SALE VIC

•Midland 70 cm 22CHAN radio s/n 121036/T \$50. 3 ele 10 m Yagi \$50. David VK3ADL 03 5952 5940.

•Shimizu HF/trncvr 10 W on 80, 40, 20. 12 V or 240 V operation. Ideal starter rig for "F" licence \$120. John VK3BAF 03 8502 8627 or email vk3baf@jeack.com.au.

•WW2 Command transmitter BC458A (SCR-274N) (5.3-7 MHz), VHF transmitter BC625

(SCR-522), large selection of those hard-to-obtain valves to restore that old equipment - send list of your needs. WW2 surplus equipment conversion manuals vols 1 and 2, contains most common and useful circuits and details. QTHR VK3APB 03 5442 1693 or 5443 3601.

•Transformers 240 in 20 V, out at 20 A. 220/230/240/250 in, 650/525/c/525/650 out, 500 mA DC, very heavy, \$50 each. Buyer to collect, Glenhantly. Max VK3ATK 03 9578 3662.

•Werner Wolfe 5 element tribander beam, not trapped, \$250. VK3CMS email Otterburn@netspace.net.au

## WANTED VIC

•Circuit and manual for BWD CRO model 502. Brian VK3WYN QTHR Phone 03 5664 1251.

•AN/TRC24 parts. I am trying to restore/complete my AN/TRC24 Radio system and I am looking for the following parts/units:- Transmitter, T-302/TRC Power Supply, PP-685/TRC Receiver, R-417/TRC A Band Plug-in AM-1180/GRC Amplifier/converter, AM-2537/TRA-25 and any other bits and pieces for this radio. Thanks for reading this. John Eggington, VK3EGG johne@telapacific.com.au. Mobile: 0409 234 672.

•Desperately seeking plugs for Wireless Set No 11. Photos of these interesting plugs can be seen at: [www.members.dcsi.net.au/clem/vk3cyd/no11set/plugs.htm](http://www.members.dcsi.net.au/clem/vk3cyd/no11set/plugs.htm). VK3CYD 03 5126 2064 clem@dcsi.net.au

## FOR SALE SA

•Antenna Analyser kits. Australian designed world class analyser. For details [www.scarc.org.au](http://www.scarc.org.au). VK5JST. By mail contact SCARC PO Box 333 Morphett Vale SA 5162, or email: kits@scarc.org.au:

## FOR SALE WA

•Kenwood HF TS-440s s/n 7060326 \$750. Kenwood 2M TS-9130 s/n 4010131 \$300. Kenwood 2M TS-9000 s/n 1050970 \$300. All the

above txs. have handbook & w/s manual. Power supply 13.8 V 20 A home brew fully protected \$200. EMOTOR Beam Rotator complete with cables & handbook \$250. LOTS MORE! For complete list contact VK6AMG, Phone 08 9582 1984, email montrose@southwest.com.au and a copy will be forwarded.

## FOR SALE TAS

•New valve 2C39BA \$50, also used one \$30. 20 MosFETs 2SK1058 \$9 each. FT-231IR 7MO21355 FM mobile transceiver 12 MHz, 1 or 10 watts, handbook, circuit \$250. ATV 2.4 GHz 20 db Horns rx tx 1 watt \$300. 3 UHF relays changeover \$10 each. QTHR VK7ZAL Robert.

•Used Heath HW101, Serial No. 31004, needs some repair or parts use. \$70 Heath PS 23 power supply for HW101 (Serial No. 01915), good working order \$50 (includes cable). Used valves (tubes) for HW101 including 6CL6, 6EA8, 6HS6, 6CB6, 12AT7, 6146B, 6BN8, OA2, 6GW8. Whole package \$100 Please contact Jim VK7SM on 0419 321 787 or via email at [jdu85255@bigpond.net.au](mailto:jdu85255@bigpond.net.au). Freight not included.

## THE WIA QSL COLLECTION REQUIRES QSL

All types welcome, especially rare DX pictorial cards, special issue. Please contact the Hon Curator, Ken Matchett VK3TL, 4 Sunrise Hill Road, Montrose Vic 3765, tel. (03) 9728 5350

## VIDEOEMAIL.

Also Live Video Messenger and Conferencing for Teaching, Talks and Tutorials.  
Do away with websites.  
Brand your Videomail and watch your business skyrocket.  
Put video on your eBay ads.  
FREE 30 day trial  
Email to: [arcibo@bigpond.com](mailto:arcibo@bigpond.com)

## About hamads....

- Submit by email (preferred) or on the form on the reverse of your current Amateur Radio address flysheet. Please print carefully and clearly, use upper AND lower case.
- Separate forms for For Sale and Wanted items. Please include name, address STD telephone number and WIA membership number if you do not use the flysheet.
- Deceased estates Hamads will be published in full, even if the ad is not fully radio equipment.
- WIA policy recommends that the serial number of all equipment for sale should be included.
- QTHR means the address is correct in the current WIA Call Book.
- Ordinary Hamads from those who are deemed to be in general electronics retail and wholesale distributive trades should be certified as referring only to private articles not being re-sold for merchandising purposes.
- Commercial advertising on these pages Contact Newsletters Unlimited.
- Copy typed or printed clearly please, and received by the deadlines shown on page 1 of each issue of Amateur Radio.

Email: [newunltd@bigpond.net.au](mailto:newunltd@bigpond.net.au)

Postal: Newsletters Unlimited, PO Box 431, Monbulk Vic 3793. Fax: 03 9756 7031

### TRADE PRACTICES ACT

It is impossible for us to ensure that the advertisements submitted for publication comply with the Trade Practices Act 1974. Therefore, advertisers and advertising agents will appreciate the absolute need for themselves to ensure that the provisions of the Act are strictly complied with.

### VICTORIAN CONSUMER AFFAIRS ACT

All advertisers are advised that advertisements containing only a PO Box number as the address cannot be accepted without the addition of the business address of the box-holder or seller of the goods.

## ADVERTISERS INDEX

These organisations support the WIA, please support them.

AEI.....	32
Amateur Radio Bookshop .....	49
Andrews .....	9
Com-an-tena.....	17
Featuretech.....	37
G & C.....	16
KVK Books.....	38
Icom.....	OBC
Old Timers.....	55, 39
Ozgear.....	29
TET-Emtron.....	22
TTS.....	8
Radio School.....	55
Small ads.....	55
Westakes.....	44
White.....	15
W/Inlnc.....	23

## VKHAM.COM

AUSTRALIAN AMATEUR RADIO

Hundreds of pages and links related to Amateur Radio and radio in general

Home of:

- VK Classifieds
- VK Auctions
- VK's on the Internet

Repeater Maps, Software, Prefix Maps and more ...

## AMIDON FERROMAGNETIC CORES

For all RF/electronic applications.

See our website for complete data on all cores including prices.

[www.catchnet.com.au/~rjandusimports](http://www.catchnet.com.au/~rjandusimports)

RJ & US Imports

PO Box 431, Kiama NSW 2533.

A 3.5" PC disk containing all data is available for \$5.00 incl. post.

Agencies

Active Electronics, Tas  
TTS Systems, Tyabb (VIC)  
Tower Communications, Perth  
Ozhelp Services, Brisbane

*"Hey, Old Timer..."*



If you have been licensed for more than 25 years you are invited to join the

## Radio Amateurs Old Timers Club Australia

or if you have been licensed for less than 25 but more than 10 years, you are invited to become an Associate Member of the RAOTC. In either case a \$5.00 joining fee plus \$8.00 for one year or \$15.00 for two years gets you two interesting OTN Journals a year plus good fellowship.

RAOTC,

PO Box 107

Mentone VIC 3194

or call Arthur VK3VQ on 03 9598 4262 or

Bill VK3BR on 03 9584 9512 or

email [raotc@raotc.org.au](mailto:raotc@raotc.org.au) for an application form.



## JACKSON BROS

JACKSON OF THE UK IS BACK

Highest quality products made by UK craftsmen

[www.jacksonbrothers.com.au](http://www.jacksonbrothers.com.au)

Full range now off-the-shelf in Australia  
Variable and trimmer capacitors, reduction drives, dials, ceramic standoffs

CATALOGUES, PRICE LISTS AVAILABLE

CHARLES I COOKSON PTY LTD

11-13 Port Rd

Queenstown SA 5014

Tel: (08) 8240 3200 Fax: (08) 8240 3233

FreeFax 1800 673355 within Australia

Email: [sales@jacksonbrothers.com.au](mailto:sales@jacksonbrothers.com.au)

ALL MAJOR CREDIT CARDS ACCEPTED

SOLE AGENTS AUSTRALIA AND NEW ZEALAND

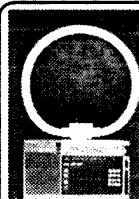

## Tunable Loop Antenna enhances AM Reception

AM radio reception (530 to 1900KHz) enhanced. Reception where none existed before; works indoors, even in interference-polluted areas

High value — low cost.

Simple, no connections or batteries

Ideal for touring, caravan, boat and fringe areas. Use anywhere.

[www.amradioantennas.com](http://www.amradioantennas.com)

[pkloops@bigpond.net.au](mailto:pkloops@bigpond.net.au)

Paul 0412 302 939

PK's Loop Antennas

## RM Products Italy

are now available in Australia after the appointment of

Hamak Electrical Industries Pty Ltd

as distributor for RM products

Visit the Hamak website at

[Hamak.com.au](http://Hamak.com.au) for

**Linear amplifiers,  
Power supplies  
and accessories**

## Are you managing the estate of a 'Silent key'?

Please save any QSLs for the National QSL collection, but first contact:

The Hon. Curator,

Ken Matchett VK3TL

on (03) 9728 5350

or email: [jeandawson@iinet.net.au](mailto:jeandawson@iinet.net.au)

Rare DX, special call-signs prefixes and suffixes, pictorials and pre-war QSLs are needed.

*Let us save something for the history of amateur radio.*



## RADIO & ELECTRONICS SCHOOL

### Become a radio amateur

Check out the courses on offer from Australia's premier training institution for radio amateurs and hobbyists.

### Already licenced?

Upgrade to the Standard licence using our self paced multi-media CD ROM course. The easiest way to become a licensed radio experimenter.

Discover digital communications, get more power and more bands

### Still want more?

Be guided by one of our experienced facilitators using our proven on-line study methods and get your Advanced licence.

### Visit

<http://www.radioelectronicschool.com>

for more information,

or email the course manager at

[info@radioelectronicschool.net](mailto:info@radioelectronicschool.net)

Telephone 07-5573-2795 12-5PM AEST

Amateur radio — a bridge to careers in radio communications technology



# Directory

## The Amateur Service:

a radio communications service for the purpose of self training, intercommunication and technical investigation carried out by amateurs, that is, by duly authorised persons interested in radio technique with a personal aim and without any pecuniary interest. 1.56 ITU Radio Regulations.

The Wireless Institute of Australia represents the interests of all amateurs throughout Australia.

The WIA offers one year and 5 year membership for all categories except Concession Student. The fees for each category are: Full members \$75 (\$365), Overseas members \$85 (\$403), Concession members (pensioner) \$70 (\$332), Concession members (student) \$70, Full members no magazine \$50 (\$237), Family members \$40 (\$190)

### National Office

10/229 Balaclava Road,  
Caulfield North VIC 3161,  
PO Box 2175  
Caulfield Junction Vic 3161  
Australia

### Contact

Phone 03 9528 5962,  
Fax 03 9523 8191,  
10am to 4pm daily,  
nationaloffice@wia.org.au  
http://www.wia.org.au

### News Bulletin Schedule

Subject to change. See [www.wia.org.au](http://www.wia.org.au) follow National News prompts.  
Contact [nationalnews@wia.org.au](mailto:nationalnews@wia.org.au)  
National VK1WIA news is distributed to all states.

### Advisory Committees

#### VK1 Australian Capital Territory

VK1WX Alan Hawes  
VK1ZPL Phil Longworth  
VK1ET John Woolner  
VK1GH Gil Hughes

### Contact

[vk1advisory@wia.org.au](mailto:vk1advisory@wia.org.au)

### News Bulletin Schedule

Sundays at 11.00 am  
VK1WIA 7.128, 146.950, 438.050  
Canberra Region Amateur Radio Club Email newsletter will be sent on request to [president@vk1.ampr.org](mailto:president@vk1.ampr.org)

#### VK2 New South Wales

VK2QV Chris Flak  
VK2XCD Chris Devery  
VK2BFN Adrian Clout

Phone 02 9689 2417  
[vk2wi@ozemail.com.au](mailto:vk2wi@ozemail.com.au)  
[vk2advisory@wia.org.au](mailto:vk2advisory@wia.org.au)

VK2WI - Sunday 1000 and 1930 hours local. 1.845; 3.595; 7.146; 10.125; 14.170; 28.320, 52.525; 145.600; 147.000; 438.525; 1273.500 megahertz. Plus regional relays.  
VK1WIA news included in the morning

#### VK3 Victoria

VK3JJB John Brown  
VK3PC Jim Linton  
VK3APO Peter Mill

Phone 03 9885 9261  
[arv@amateurradio.com.au](mailto:arv@amateurradio.com.au)

VK1WIA, Sunday 11am and 8pm, 3.615 and 7.085 (LSB), 10.130 (USB),  
VK3RML 146.700, VK3RMM 147.250, VK3RMU 438.075.

#### VK4 Queensland

VK4BY Don Wilchefski  
VK4ZZ Gavin Reibelt  
VK4KF Ken Fuller

[vk4advisory@wia.org.au](mailto:vk4advisory@wia.org.au)

VK1WIA, Sunday 9.0am via HF and major VHF/UHF rpters

#### VK5 South Australia and Northern Territory

VK5OV David Box  
VK5APR Peter Reichelt  
VK5ATQ Trevor Quick

Phone 08 8294 2992  
[boxesdnm@lm.net.au](mailto:boxesdnm@lm.net.au)  
[peter.reichelt@bigpond.com](mailto:peter.reichelt@bigpond.com)  
[vk5advisory@wia.org.au](mailto:vk5advisory@wia.org.au)

VK5 South Australia  
VK5WI: 0900 am local time. 1.843 LSB, 3.550 LSB, 7.095 LSB, 28.470 USB, 53.1 AM, 147.000 FM Adelaide, 146.800 FM Mildura, 146.900 FM South East, 146.925 FM Central North, 439.975 FM Adelaide North.  
VK8 Northern Territory  
0900 local time 3.555 LSB, 7.050 USB, 10.130 USB, 146.900 FM.

#### VK6 Western Australia

VK6NE Neil Penfold  
VK6XV Roy Watkins  
VK6OO Bruce Hedland-Thomas

Phone 08 9351 8873  
<http://www.vk6.net/>  
[vk6advisory@wia.org.au](mailto:vk6advisory@wia.org.au)  
[vk6ne@upnaway.com](mailto:vk6ne@upnaway.com)  
[vk6xv@bigpond.net.au](mailto:vk6xv@bigpond.net.au)

VK6WIA: 146.700 FM(R) Perth at 0930hrs Sunday relayed on 1.865, 3.564, 7.075, 10.125, 14.116, 14.175, 21.185, 29.120 FM, 50.150 and 438.525 MHz, Country relays 3.582, 147.200 (R) Cataby, 147.350 (R) Busselton, 146.900 (R) Mt William (Bunbury), 147.000 (R) Katanning and 147.250 (R) Mt Saddleback. Broadcast repeated on 146.700 at 1900 hrs Sunday relayed on 1.865, 3.564 and 438.525 MHz : country relays on 146.900, 147.000, 147.200, 147.250 and 147.350 MHz..Also in "Realaudio" format from the VK6 WIA website

#### VK7 Tasmania

VK7ZAX Phil Corby  
VK7DG Dale Barnes  
VK7KK Reg Emmett

Phone 03 6234 3553  
[vk7advisory@wia.org.au](mailto:vk7advisory@wia.org.au)  
[phil.corby@tassie.net.au](mailto:phil.corby@tassie.net.au)  
[vk7dg@wia.org.au](mailto:vk7dg@wia.org.au)  
[regemm@ozemail.com.au](mailto:regemm@ozemail.com.au)

VK1WIA Sunday 9am on VK7WI network: 3.570MHz LSB, 146.700 MHz FM (VK7RHT South), 53.825MHz FM (VK7RAD South), 147.000MHz FM (VK7RAA North), 146.750 FM & 53.825MHz (VK7RNW North West), 146.625 MHz FM (VK7RMD North West), UHF CB Channel 15 (Hobart) and 27MHz CB - 27.225MHz LSB (Hobart). Followed at 9:30am with VK7 Regional News Broadcast also on 7.090MHz LSB & 14.130MHz USB

### Notes

1. Only three members of the state advisory committees are listed.
2. All listings are preliminary. They will be updated each month as required.
3. Membership application forms are available from the WIA web site [www.wia.org.au](http://www.wia.org.au) or the national office address above.

# Cohen prepares for **JOTA**

*~but this time it's different*

**how our  
hobby is  
promoted to  
Scouts**

Meet Cohen Lewis. He's 12 years old, and is a Scout with 1st Casey Scout Group in Melbourne. Cohen has another identity. It's VK3FCLL.

Is that some kind of coded name for a secret agent? No, nothing like that. In fact it's heaps more interesting. Cohen is, in fact, a licensed Amateur Radio Operator.

In March 2006, Cohen studied, sat for an exam, and gained his Foundation Amateur Radio Licence. The Foundation Amateur Radio Licence was introduced by the Government in November 2005, providing an entry level license designed to get people into the hobby. More than 500 people have gained this licence since its introduction, many of whom are young people like Cohen.

Cohen is presently studying for the next level of Amateur Radio Licence, the Standard Licence. This will enable him to use more radio power and use a wider range of frequency bands.

I stumbled across Cohen while searching the web for something, and found his website, where he enthusiastically tells the world what a great hobby he has entered. On his website, Cohen also tells the world that he's a Scout.

By this time I was really curious, so I emailed Cohen, and asked him if he would like to be featured in an article about him and his hobby. After he gained his parents' permission, he consented.

Cohen's Father, Grandfather and Uncle are all Amateur Radio Operators, as are several of his friends. Cohen takes

part in local radio nets for young people. These sessions were set up to help newcomers into the hobby to develop their skills and knowledge.

Cohen has taken part in two Jamborees Of The Air, and is looking forward to taking part again this year, this time with his own callsign.

Amateur Radio has been with us for a long time, and in spite of some perceptions about it, the hobby is actually growing in Australia, especially after the introduction of the Foundation Licence.

I encourage Scouts of all ages to take a good look at this hobby. Like Cohen, you will find it interesting and will soon develop enthusiasm for talking to other people around Australia and indeed around the world. A good way to do introduce Scouts to Amateur Radio is to organize a JOTA activity, and have on hand information that will enable them to find out more about the hobby.

To find out more about Amateur Radio, or JOTA-JOTI, contact your Branch Activity Leaders for Radio, Electronics, Communications. You can also visit <http://www.wia.org.au/> to find out about Amateur Radio in Australia.

*Bob Bristow VK6FJAB, JOTA-JOTI Coordinator  
Scouts Australia*

**49th Jamboree  
On The Air**

**10th Jamboree  
On The Internet**

**21-22 October  
2006**



# ICOM's price break through

## most affordable prices ever



### IC-7000

HF/VHF/UHF All mode Transceiver • 100W HF/50MHz, 50W/2m, 35W/70cm • I.F DSP for improved noise rejection • Digital IF filter for Dial up selectivity • 2.5" TFT colour display for bright easy reading • Remote control DTMF Mic for fingertip control & IRLP access PLUS • digital voice storage • 2 mode band scope • Multi function meter 7 SWR display • Built in RTTY modulator



### IC-756PRO III

HF\*6m • Sharp & soft IF filter shape • New receiver gives +30dBm third-order intercept point • One-touch record/play • Digital voice memory • Extended 1/4 Tuning step & BPF functions for SSB-D mode • 32-bit floating-point DSP and 24-bit AD/DA converter • SSB/CW synchronous tuning • 5-inch color TFT LCD • Built-in antenna tuner • Customisable filter shape • No optional filters to buy

Amateur



### IC-7800

HF\*6m • Four 32-bit floating point DSP units • +40dBm ultra high intercept point • Automatic tracking pre-selector • Two completely independent receiver circuits • 200W output power at full duty • Ultra high frequency stability • 7-inch wide color TFT LCD • Multi function spectrum scope • RTTY / PSK31 operation without PC connection • Professional 6m receiver • Digital Voice Recorder • CF memory card.



### IC-2200H

VHHigh (65W) Power Output • DTCS & CTCSS Tone Squelch • DTMF Encode & Decode (with optional UT108) • Digital Voice & Data Communication (with optional UT118) • 207 Alphanumeric Memories



### IC-P7A

VHF/UHF (2m/70cm) Dual-band FM Handheld Transceiver • Ultra compact body, light weight 47x81x28mm, 160g • Mini-power VHF/UHF dual bander with wideband receiver 0.495-999.990MHz • 1800mAh large capacity Li-Ion battery allows 20hours operating time (Tx:Rx:Standby=5:5:90) • 1.5W output power on 2m & 1W output power on 70cm • Simple operation • 1000 memory channels with flexible memory bank system • Oversize LCD for clear display of function information



### IC-T90A

A new 5W Triband handheld • VHF/UHF FM 2M, 6M, & 70CM Wideband receive 495KHz - 1GHz 555 Alphanumeric memories • 13 Scan modes DTCS & CTCSS encode & decode DTMF encoder (10 memories) Wide/narrow transmit capability.

ICOM

ICOM 84

Call your local ICOM dealer [www.icom.net.au](http://www.icom.net.au) or (03) 9549 7500



Volume 74 No 10  
October 2006

The magazine for AUSTRALIAN radio amateurs

# Amateur Radio



\$7.00  
incl GST

## The Amazing Journey of



# the CAPE JAFFA LIGHTHOUSE

**INTERNATIONAL  
LIGHTHOUSE & LIGHTSHIP  
WEEKEND**





Now with manufacturer support  
... need we say more ?

Model Pictured: FT DX 9000MP, 400 W Special Order Version



**Vertex Standard (Australia) Pty. Ltd.**  
Normanby Business Park 14/45 Normanby Road  
Notting Hill Victoria 3168 Australia  
P 61 3 9518 2100 • F 61 3 9518 2199  
E [info@vxstd.com.au](mailto:info@vxstd.com.au) • W [vxstd.com.au](http://vxstd.com.au)



# Amateur Radio

Volume 74, Number 10  
October 2006

The Journal of the Wireless  
Institute of Australia  
ISSN 0002-6859

## Editorial

**Editor:** Peter Freeman VK3KAI  
editor-armag@wia.org.au

**Technical Editor:** Peter Gibson VK3AZL

**Publications Committee Members**

Brenda Edmonds	VK3KT
Ron Fisher	VK3OM
Evan Jarman	VK3ANI
Tom Potter	VK3UBS
Bill Roper	VK3BR
Ernie Walls	VK3FM

## All circulation matters

[nationaloffice@wia.org.au](mailto:nationaloffice@wia.org.au)

## How to submit material

### General and Technical articles

Secretary  
AR Publications Committee  
PO Box 2175,  
Caulfield Junction Vic 3161  
or [armag@wia.org.au](mailto:armag@wia.org.au)

### Columns and letters to Editor

Editor  
AR Magazine  
PO Box 273  
Churchill, Vic 3842  
or [editor-armag@wia.org.au](mailto:editor-armag@wia.org.au)

### Hamads

"Hamads" Newsletters Unlimited  
PO Box 431  
Monbulk VIC 3793  
Fax 03 9756 7031  
[newunltd@bigpond.net.au](mailto:newunltd@bigpond.net.au)

### Advertising

All enquiries to  
Newsletters Unlimited  
PO Box 431  
Monbulk Vic 3793  
Phone: 03 9756 7797  
Fax: 03 9756 7031  
[newunltd@bigpond.net.au](mailto:newunltd@bigpond.net.au)

### Registered Office

10/229 Balaclava Road,  
Caulfield North VIC 3161  
Australia  
Phone: 03 9528 5962  
Fax: 03 9523 8191

## Production Deadlines

General articles, columns and  
advertising booking 10th day of  
previous month.

Hamads and advertising material 15th  
day of previous month

The contents of Amateur Radio are Copyright  
Wireless Institute of Australia © 2006

## GENERAL

<b>Idyll Daze on the Clarence River</b> .....	17
Richard Cortis VK2XRC	
<b>Radio skills needed for international disaster relief work</b> .....	23
RedR Australia	
<b>How to make contesting a little easier</b> .....	24
Vince Henderson VK7VH	
<b>International Lighthouse &amp; Lightship Weekend</b> .....	26
<b>Operation Grassy Hill lighthouse</b> .....	26
<b>Mackay at the Pine Islet Lighthouse</b> .....	28
<b>Westlakes ARC at Norah Head</b> .....	29
<b>ORARC inc. 2006 Lighthouse Weekend Operation at Tacking Point</b> .....	31
<b>East Gippsland Amateur Radio Group goes to Point Hicks</b> .....	31
<b>ILLW 2006 and VK3WI</b> .....	34
<b>Radio Clubs combine for Lighthouse Weekend at Cape Jaffa Lighthouse</b> .....	36

## TECHNICAL

<b>In praise of the humble "Inverted V" dipole</b> .....	5
Felix Scerri VK4FUQ	
<b>Equipment review. Ten-Tec RF Vector network analyzer</b> .....	6
Ron Sanders VK2WB	
<b>Curtain rod antenna mast</b> .....	10
Steve Porter	
<b>A 4-125 linear amplifier for 160 m. Part 1</b> .....	12
Drew Diamond VK3XU	
<b>An Isolation unit for answering machines</b> .....	21
P Anderson VK2GPT	

## COLUMNS

<b>ALARA</b> .....	38	<b>VK3</b> .....	47
<b>AMSAT</b> .....	51	<b>VK5</b> .....	48
<b>Awards update</b> .....	40	<b>VK7</b> .....	49
<b>Beyond our shores</b> .....	53	<b>VK4</b> .....	50
<b>Contests</b> .....	41	<b>Silent key</b> .....	20, 41, 45
<b>Directory</b> .....	56	<b>Spotlight on SWLing</b> .....	42
<b>Editorial comment</b> .....	2	<b>VHF/UHF – an expanding world</b> .....	43
<b>Hamads</b> .....	54	<b>WIA comment</b> .....	3
<b>News from</b> .....	46	<b>WIA News</b> .....	4
<b>VK2</b> .....	46		

## Our Cover this month

See note on page 4

### Contributions to Amateur Radio

Amateur Radio is a forum for WIA members' amateur radio experiments, experiences opinions and news. Manuscripts with drawings and/or photos are always welcome and will be considered for publication. Articles on disc or email are especially welcome. The WIA cannot be responsible for loss or damage to any material. A pamphlet, 'How to write for Amateur Radio' is available from the National Office on receipt of a stamped self-addressed envelope.

### Back Issues

Back issues are available directly from the WIA National

Office (until stocks are exhausted), at \$4.00 each (including postage within Australia) to members.

### Photostat copies

When back issues are no longer available, photocopies of articles are available to members at \$2.50 each (plus an additional \$2 for each additional issue in which the article appears).

### Disclaimer

The opinions expressed in this publication do not necessarily reflect the official view of the WIA and the WIA cannot be held responsible for incorrect information published.

## Amateur Radio Service

A radiocommunication service for the purpose of self-training, intercommunication and technical investigation carried out by amateurs; that is, by duly authorised persons interested in radio technique solely with a personal aim and without pecuniary interest.

## Wireless Institute of Australia

The world's first and oldest National Radio Society  
Founded 1910

Representing

The Australian Amateur Radio Service

Member of the

International Amateur Radio Union

Registered Office of the WIA

10/229 Balaclava Road, Caulfield North Vic 3161

Tel: (03) 9528 5962 Fax (03) 9523 8191

email: nationaloffice@wia.org.au

http://www.wia.org.au

All mail to

PO Box 2175 Caulfield Junction VIC 3161

Business hours: 10am – 4pm weekdays

### National Office staff

Margaret Williams

Administrator

Dianne Ashton

Examination Officer

Brenda Edmonds

Office Volunteer

### Board of Directors

President	Michael Owen	VK3KI
Vice-President	Ewan Mcleod	VK4ERM
	Robert Broomhead	VK3KRB
	Glenn Dunstan	VK4DU
	Trevor Quick	VK5ATQ
	Robyn Edwards	VK6XRE
	Phil Wait	VK2DKN
Secretary	Ken Fuller	VK4KF
Treasurer	Bruce Bathols	VK3UV

### Coordinators

AMSAT	Graham Ratcliff	VK5AGR
ARDF	Jack Bramham	VK3WWW
Australian ARISS	Tony Hutchison	VK5ZAI
Awards	Mai Johnson	VK6LC
Club Coordinator	Ted Thrift	VK2ARA
Contests	Ian Godsil	VK3JS
John Moyle Memorial		
Field Day Manager	Denis Johnstone	VK3ZUX
Editor 'AR'	Peter Freeman	VK3KA1
EMC/EMR	Gilbert Hughes	VK1GH
	Keith Malcolm	VK1ZKM
	Gilbert Hughes	VK1GH
Standards	David Wardlaw	VK3ADW
	John Bishop	VK2ZOI
	John Martin	VK3KWA
	Will McGhie	VK6UU.
NTAC		
Historian		
IARU Region 3		
Liaison Officer	Michael Owen	VK3KI
Intruder Watch	Glenn Dunstan	VK4DU
International		
Travel Host	John Miller	VK3DJM
ITU Conference & study group	Gilbert Hughes	VK1GH
	David Wardlaw	VK3ADW
	Keith Malcolm	VK1ZKM
	Ken Mather	VK3TL
QSL Curator		
QSL Bureau Coordinator & VK9/0 QSL Manager	Neil Penfold	VK6NE
Repeater Coordinator	Peter Mill	VK3ZPP
Webpage co-ordinator	Colin Thompson	VK2TRC

# Editorial comment

Peter Freeman VK3KA1

Welcome again to all our readers. Another month has passed, with much activity. The failure of a satellite launch mission and the associated loss of several MicroSat projects. The successful launch and return of a Shuttle mission to the ISS. The launch of the first female "space tourist" via the Russian system, headed for a brief stay at the ISS.

Some months ago, the Publications Committee decided to cease publication of the propagation prediction charts. I have received several items of correspondence on this issue. I have not been ignoring these emails or letters; rather I have been assessing the overall level of the responses. I would assess the outcome as about neutral – some in favour and some against.

Part of the "against" response relates to the lack of access to the more up-to-date tools available via the IPS website, and/or lack of familiarity with the tools available. I am happy to report that I have managed to convince a "volunteer" to prepare an article regarding the available tools. We anticipate that this "how to" article will be ready soon. We hope that the information will assist amateurs to access the excellent tools offered by the IPS, be that from home or via a computer at the local library.

August saw a busy month of "contest" activity locally: the RD Contest, the ALARA Contest and the International Lighthouse and Lightship Weekend. I hear that the RD result preparations are well underway. It looks as if they will not appear until the November issue at the earliest, but this will be an immense improvement on last year.

Firstly, I must confess that the information supplied to me was incomplete regarding the RD Contest. I was supplied with the intended text for the opening speech for the contest. Unbeknown to me, an opening speech, by the same author, from a couple of years ago was used. No offence was intended to Horrie Young VK2AMZ, the author of this year's intend speech. I was totally unaware of the situation until I listened to the WIA broadcast on September 17. It just goes to show that, as communicators, we need to improve our communications!

## International Lighthouse & Lightship Weekend (ILLW)

One activity that occurred during August was a little different – the ILLW. I thank those that managed to submit material promptly, either via the normal channels or in response to my request for material, in time for this issue. I decided to make the ILLW a feature of this issue. Not really a contest, this activity weekend promotes operation from lighthouse and lightships. Part of the reason for the feature is the considerations required for such an activity. A great deal of advance planning is required: deciding on the venue, seeking approval to operate, booking the accommodation (in many cases), and planning the logistics..... Perhaps your club or group should start thinking now about next year's ILLW event?

I must also thank many of the team at Lighthouses of Australia Inc. for their assistance in sourcing pictures of the Cape Jaffa Lighthouse and platform, as used on the front cover. At this time, we are unsure of the source of the photograph of the lighthouse in its original location. I trust that the original photographer does not take offence – we would happily acknowledge him or her. Lighthouses of Australia Inc. has a comprehensive website covering Australian lighthouses and promotes the preservation of these historical sites. It is also a valuable resource for those considering an ILLW activity next year.

## Graphics error

Unfortunately, the September issue showed what can happen if we do not pay total attention to detail. The circuit diagram of the solar regulator by Dale Hughes VK2DSH managed to lose some detail during the translation from draft to production. The entire production team has already passed their apologies on to Dale. Anyone needing a copy of the circuit diagram can request a copy either electronically, or via the mail, via the Secretary of the Publications Committee – see the left-hand column on page 1.

## New Publications Committee Secretary

For some months now, our long standing Secretary of the Amateur Radio Publications Committee has been

*continued on page 9*

## Saying farewell to the Big Man

**The last few weeks have not been easy. WIA secretary Chris Jones, a "big man" by any standard, tragically and unexpectedly passed away. At Chris's funeral, many people spoke of their affection, of many shared adventures, and of his significant achievements.**

It may surprise you that Chris was a fully-fledged, initiated, member of the Sulka tribe in Papua New Guinea and had supported the village community for many years. The PNG Provincial Government is currently funding an upgrading of the school at Sulka tribe, including building a school library, which on opening will not have any books. Chris's family has established a memorial fund in order to buy books for the school library. Details are on the WIA website at <http://www.WIA.org.au/>.

Chris Jones was a leader in the revitalization and the restructuring of the WIA into a single national organization – a WIA which is now much more effective and much better able to serve the needs of you its members, and Australian radio amateurs generally.

This "one-man-call-centre" knew everyone everywhere, and worked tirelessly within the WIA for the introduction of the new entry level Foundation Licence and the new accredited assessment system. Chris (white pella belong Sulka tribe -VK2ZDD) is very sadly missed by very many people, within and outside the amateur radio community.

Putting tragic events behind us, we at the WIA have been taking a hard look at the administrative side of the organization. The WIA Board has recently appointed Ken Fuller VK4KF as Company Secretary to the WIA. With a background in Engineering and Administration, Ken has agreed to take the position on a short-term basis.

In an AR comment last year, I described just how very complex the WIA is for what is essentially a quite small organization. The WIA provides many complex and specialist functions: International representation through the IARU; high level liaison with ACMA on licensing regulations and policies which affect the amateur service; magazine publishing; running an accredited amateur assessment

system with the help of accredited assessors and the clubs; fighting threats to amateur radio such as interference from BPL and intruders into our bands; weekly news broadcasts; a Clubs Grants Scheme; contests; a QSL service – the list goes on and on.

Hard working individual volunteers, volunteer groups and committees, do much of this work. Permanent salaried staff in the WIA Melbourne office perform core business functions such as membership administration, the administration of the examination service, the club insurance scheme, day-to-day liaison with ACMA, accounts, and other time-critical functions.

Getting the mix of work right between groups of volunteers and paid staff is a tricky business, and volunteers need to be co-ordinated and managed in a very particular way. In general, I believe we rely too much on a very small core group of over-worked volunteers and we need to change that situation.

One solution would be to find more volunteers; but their management, in order to ensure the right person has the right task, also consumes time. Another way would be to pay for more office staff, but this is expensive and we are striving to keep membership fees as low as possible, especially considering that many of our long-term members are either retired or nearing retirement. Conversely, many of our newer members are quite young with many financial commitments.

The answer will lie in a little of both, more volunteers with particular skills, and in the longer term, an expanded WIA office. We are already looking in depth at some issues, such as the requirement to set up a system for the Advisory Committees, and the Technical Advisory Committees.

Such expansion takes money. Although the WIA is now in a very strong financial position, much of the available funds have

been transferred from the old Divisions and from recent bequests – not so much from operating profit. Bequeathed funds are invested for the future good of amateur radio, they are not intended to fund day-to-day operations, but rather are targeted to specific purposes consistent with the wishes of the benefactor.

Any expansion of the WIA office must come from operating profit, and unless we increase membership fees (which we do not want to do), more operating profit can only come from more money from publications and services, and more new members. The very best scenario is increased membership – more new members.

Therefore, if you want to see an even more effective WIA working for Australian radio amateurs, please help us attract new members to the WIA.

If you are not already a member, please consider joining.

If you are in a club, please encourage other club members to join the WIA.

This way we can guarantee the ongoing viability of the WIA well into the future, and do the big-fella proud.

ar

## *Plan ahead*

### **49th Jamboree On The Air**

### **10th Jamboree On The Internet**

### **21–22 October 2006**

## Call for Expressions of Interest In 505-510 kHz

The United States Federal Communications Commission has granted an experimental licence to the ARRL on behalf of a group of 23 US radio amateurs interested in investigating spectrum in the vicinity of 500 kHz.

Experimental license WD2XSH was issued September 13. The two-year authorization permits experimentation and research between 505 and 510 kHz using narrowband modes at power levels of up to 20 W ERP.

The FCC decision to allocate an experimental band from 505-510 kHz is a logical outcome - it avoids the distress and safety channel at 500 kHz and the NAVTEX maritime safety information broadcast channel at 518 kHz.

The WIA is prepared to apply for a similar experimental allocation for Australian amateurs if there is sufficient demand.

Please send expressions of interest to WIA Director Glenn Dunstan, VK4DU, at [vk4du@wia.org.au](mailto:vk4du@wia.org.au).

## Ken Fuller VK4KF appointed WIA Company Secretary

Ken Fuller, VK4KF, has been appointed Company Secretary to the WIA, following the passing of Chris Jones VK2ZDD, our previous Company Secretary.

Ken has a background in engineering and administration and has agreed to take the position on a short term basis.

The principal tasks of the Company Secretary are to support the Board of Directors and oversee the various

governance functions of the WIA. The duties of the Company Secretary are in general what the Board decrees but there are some core duties for which the secretary will be held responsible by members and Government through the Australian Securities Investment Commission (ASIC).

The WIA would like to thank Ken very much for accepting this position at such short notice.

## Five WIA affiliated clubs win cash grants

This year the WIA Board decided to trial a club grants scheme where an allocation of member's funds could be channelled back, through WIA affiliated clubs, for specific projects. The WIA Board made \$5000 available for this trial.

The decision as to which club should receive a grant was made by an appointed 2006 Club Grants Committee, comprising Ken Fuller VK4KF (Chair), Deane Blackman VK3TX and Wally Howse VK6KZ. These gentlemen, each with extensive professional experience in such matters, had the very difficult job of identifying the most worthy submissions based on the viability of the project, and the maximum benefit to all Australian radio amateurs.

Eighteen submissions from 13 WIA affiliated clubs were reviewed. Submissions were of a high standard; however with limited funds available, naturally not all worthy club projects could be supported.

The 2006 Grants Committee report recommends the following five grants be made:

- The Scout Radio Activities Group, with approximately 50% WIA membership, a grant of \$770 to support the building and operating of 3 APRS Tracking Units as a demonstration project for scouts and like groups.
- The Orana Region ARC, with approximately 50% WIA membership, \$930 toward a project to link 5 repeaters to improve 2 metre and 70 centimetre coverage over an extensive area in the Condobolin and Dubbo areas of New South Wales.
- The Northern Tasmania ARC, with a 58% WIA membership, \$1,900 toward the purchase of a commercial diplexer to allow mounting of the transmitter and receiver antennas at single point on its Mt Barrow site, covering a wide area of Tasmania.
- The East Gippsland ARC, with an 86% WIA membership, \$500 to replace solar panels stolen from the club's repeater site at Mt Cann.
- The Ballarat Amateur Radio Club, with an 80% WIA membership, \$900 to fund phase 3 of stage 1 of a project to establish a modern HF and 2 metre and 70 centimetre club station providing facilities for remote access in times of emergency and for members from their homes and elsewhere, described by the Committee as the most innovative of all the proposals submitted, and also commended as being very well presented.

The WIA Board accepted the committee's recommendations and is in the process of distributing the grants.

The WIA thanks all affiliated clubs who offered proposals for consideration, and particularly thanks the members of the Grant Committee for a detailed, carefully considered and well presented report. The full report of the Grant Committee can be found on the WIA website at [www.wia.org.au](http://www.wia.org.au)

The Board believes the Club Grants Scheme offers a valuable opportunity for the WIA to further support its affiliated clubs and encourage innovative projects to the benefit of all Australian radio amateurs. The outcomes from this first allocation of grants will be watched very carefully.

## Cover Note

Our cover this month features the Cape Jaffa Lighthouse. The lighthouse was originally sited on the Margaret Brock reef (top). In 1978 the lighthouse, with its built-in accommodation for 2 families, was lifted from the platform and taken to shore at Kingston, where it now serves as a popular tourist stop, as well as the site for the V15CJ ILLW operation. The platform remains at the reef, now providing a home to 630 nest-

ing pairs of Australian Gannets. Thanks to Robert Mock (bottom left photo), Tony Hutchison VK5ZAI (bottom right photo) and Lighthouses of Australia inc for assistance and photographs. Despite our best efforts, we have not been able to identify the photographer of the top photograph in our montage. We would be happy to acknowledge him or her, once identified.

# In praise of the humble "Inverted V" dipole

Felix Scarri VK4FUQ

The last couple of weeks I've felt like I did when I first became licensed in 1985, spending many enjoyable hours in the backyard playing around with antennas. In those days there were quite a few antenna failures, but also one or two successes. All of it was a valuable learning experience. In recent years I've come to depend on simple wire antennas such as dipoles and verticals, and these have worked well subject to a couple of qualifications. I have a particular fondness for the quarter wave vertical, except for one thing ..... noise pickup!

## The problem

Power line noise has been a very long-time annoyance at this QTH due to the presence of very old aerial power feeders in the area. Depending on the prevailing weather, the general level of power line noise ranges from moderate (the lowest) to very high. It is even audible on the VHF broadcast band where it interferes badly with strong signals. The local electrical utility, responding to my many complaints over the years, has changed insulators and such, but the problem has essentially remained unchanged.

## The "inverted V" solution

Consequently, it has been a long term desire of mine to mitigate this noise problem as much as possible. Over the years I have found that some wire antennas do differ considerably in their power line noise pickup. Sadly, verticals are by far the worst in general terms. Dipoles are better (less noise pickup) and full wave loops also possess a low noise pickup characteristic. However, loops do present some constructional difficulties compared to simple dipoles. Listening to an "on-air" QSO a while back, where the subject of "inverted V" dipoles was being discussed, it occurred to me that I'd never tried an "inverted V" dipole on 20 m.

My 40 m antenna is a separate "inverted V" dipole which has performed extremely well long-term; I realised that it has never been overly bothered by power line noise. Thus encouraged, after first noting the level of power line noise received with my existing 20 m horizontal dipole, I hurriedly reconfigured the dipole into a classic "inverted V" dipole. I was stunned to note that the level of power line noise had dropped by an average 2 to 2½ "S" points. Listening around on the band

showed no deterioration in the strength of signals being received; if anything, the opposite!

## Feeding options

The time since that afternoon has seen much tweaking, involving feedline changes, baluns and even noise bridge measurements, which have been rather interesting. It is nice when the practical observations agree with theory! Certainly, the noise bridge measurements confirm that the feed-point impedance at resonance has indeed dropped to slightly less than 50 ohms and that the SWR bandwidth has narrowed somewhat, again in accordance with theory. I have even opted to feed the "inverted V" with coax via a 1:1 current mode balun at the feed-point, given that the feed impedance is so low.

Ordinarily I would prefer to feed antennas with high impedance balanced feeder; however, resorting to the antenna books showed that direct feeding with balanced feed line and using an ATU in the shack was not that efficient in terms of additional loss caused by SWR. Direct feeding with RG58 coax is actually somewhat more efficient. The use of the balun is also a worthwhile addition in the interests of achieving a properly balanced feed. Digressing onto the subject of baluns briefly, I find the simple current mode 1:1 balun excellent in this application, although I am also a fan of the voltage mode 4:1 balun. Baluns! Yes, it is a complex and involving subject, but it's nice to know that both types work well in practice.

## Performance

The best thing about the "inverted V" dipole is its excellent performance. Apart from the excellent low noise receive profile, it radiates beautifully as well! My

definite "gut feeling" is that my "inverted V" dipole is performing better than its earlier configuration as a horizontal dipole. Perhaps I shouldn't be surprised. I noticed the same order of improvement when my 40 m "inverted V" was changed from a horizontal dipole, something necessitated by the loss of one of the end supports in a storm.

I've had some fantastic contacts on the 20 m "inverted V" dipole of late, and I've been hearing European and American DX with much stronger signals than I did with the horizontal dipole. Why should this be? Is it the result of "mixed" signal polarisation, or is it due to the elevated high current feed-point? I don't really know. Whatever the reason, it works beautifully! This is definitely one antenna that is easy to put up, requiring only one high centre support. I highly recommend it as a basic but high performance antenna.

ar

## Got something to say about amateur radio?

Perhaps you have had a contest  
adventure?

Maybe an organised DXpedition or just  
off by yourself to an out of the way place,  
or perhaps an unusual not-out-of-the-way  
place?

An IOTA or even domestic 'IOTA'  
adventure, Pinchgut or Popes Eye perhaps?

Or you have devised an antenna that  
doesn't offend the body corporate?

Perhaps a historical record or story?

You built a homebrew whatever, or have a  
suitcase set you use in the park?

You might even disagree with something?

## Share it!

We always welcome suitable material.

*In the first instance send the editor  
a short synopsis and he'll put you  
on the right track (see page 1)*

## Equipment review

# Ten-Tec RF Vector network analyzer

Ron Sanders VK2WB

I often experiment with RF transformers and filters, so was delighted when TTS Systems gave me the opportunity to try the Ten-Tec Vector Network Analyzer (VNA).

The unit was designed by Tom McDermott N5EG and Karl Ireland and described in the QEX magazine (July/August 2004), published by the ARRL. The authors gave the design to the Tucson Amateur Packet Radio (TAPR) group in USA. Given the devices used and the challenges for the average amateur in soldering small SMD devices, TAPR arranged for the Analyzer to be manufactured and sold by Ten-Tec. The VNA has transmit and receive ports, and measures transfer characteristics of networks using S parameters. Connection to a computer is via USB and the software operates through the Microsoft Windows© .NET 1.1 system, which is freely available. All relevant software is provided on the CD, and updates can be downloaded via the internet.

The VNA comes complete, with CD, plug-pack, USB cable, two coax cables, two attenuators, and a 50 and a 0 (short circuit) ohm terminator used for calibration. To allow for individual test setups there is provision for calibrating and saving data for different test fixtures, so that any test fixture data can be used to correct the final measurement. The frequency range for normal accuracy is 1 – 100 MHz but can be used from 200 kHz to 120 MHz with reduced accuracy. Normal accuracy is much better than required for amateur use and, in fact, is comparable to commercial instruments costing many times more.

A separate program allows the VNA to be used as a signal generator with frequency resolution of 1 Hz. The complete manual can be downloaded from the Ten-Tec or TAPR website. The unit measures 160 mm long x 115 wide x 30 mm high (see photos).

## Tests

The simplest arrangement to check an RF matching transformer is to use a passive

50 ohm Return Loss Bridge, an RF signal source and a detector (receiver with S-meter would do) to measure the bridge balance. This will give a rough indication of SWR, but nothing to show loss through the transformer. The VNA is designed for 50 ohm in/out and incorporates all the necessary equipment to make all the measurements over a range of frequencies and display the result on a computer screen.

Photo 4 shows a 4:1 transformer designed to match 200 to 50 ohms over 1.8 – 30 MHz, and Figure 1 shows the circuit diagram of the transformer which is made up of two transmission lines (T1 and T2)

which are wound on the same core. Each transmission line is made up of two 18 g PTFE insulated wires forming two turns through a BN-43-7051 large balun core. All wires must be of equal length for correct operation, and in this case each wire is approx 250 mm long.

By connecting two of these transformers back to back we can achieve 50 ohms in and out, which is required for the VNA. It is common to use this “back

to back” arrangement where input and output impedances are required to be identical. The compromise is that losses are double that for a single transformer and the Return Loss is decreased (less negative) which increases the SWR of the combination when compared with a single transformer. If the combination provides satisfactory results then it can be assumed that each transformer is also acceptable.



Photo 1 – Front view of the analyzer.

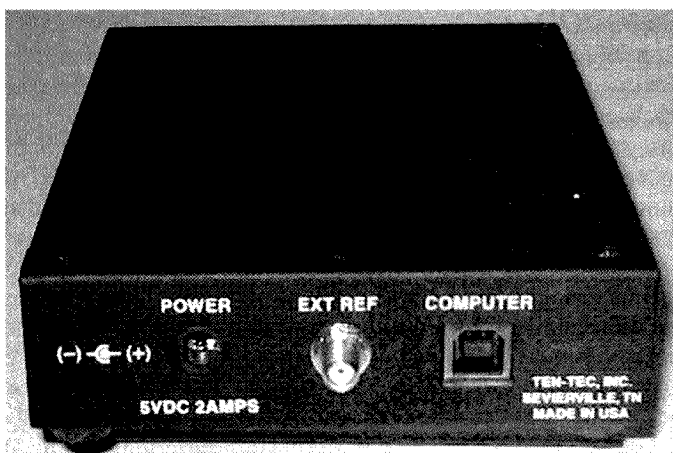

Photo 2 – Rear view of the analyzer.



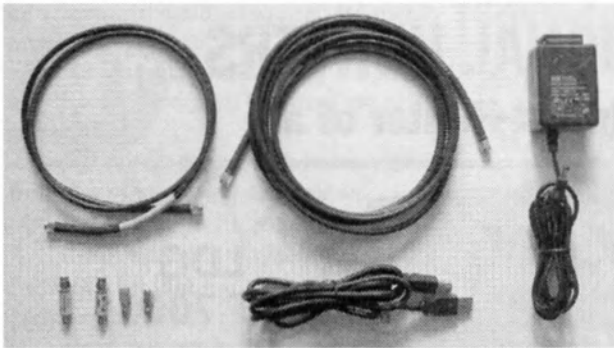

Photo 3 – Accessories that come with the Analyzer.

The following table shows the relationship between SWR and Return Loss (-db)

SWR	Return Loss	SWR	Return Loss
1.0:1	infinite	1.3:1	17.7
1.1:1	26.4	1.4:1	15.8
1.2:1	20.8	1.5:1	14.0

**VNA features**

Fig 2 shows the S11 and S21 screen presentation for the two back to back transformers as mentioned above.

The test Start and Stop frequencies can be set to 1 Hz resolution. The plot shows the sweep is from 0.5 – 35 MHz, which easily covers the HF amateur bands. Plots can be Single Sweep (SgSwp) or Free Run and the number of points across the sweep can be set between 100 and 1020 with the FreqGrid menu.

There is provision to load a test fixture file by selecting the relevant file from the Calibration menu and selecting Apply Fixture Calibration – bottom right hand corner.

The File menu allows you to give the plot a title.

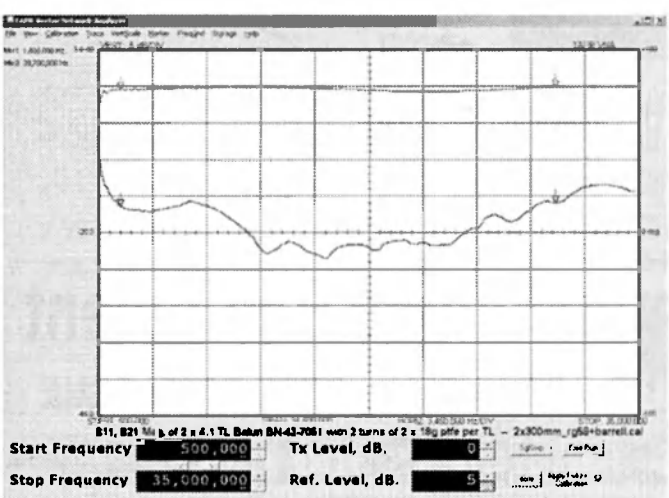

Fig 2 - The S11 and S21 screen presentation for the two back to back transformers (see text)

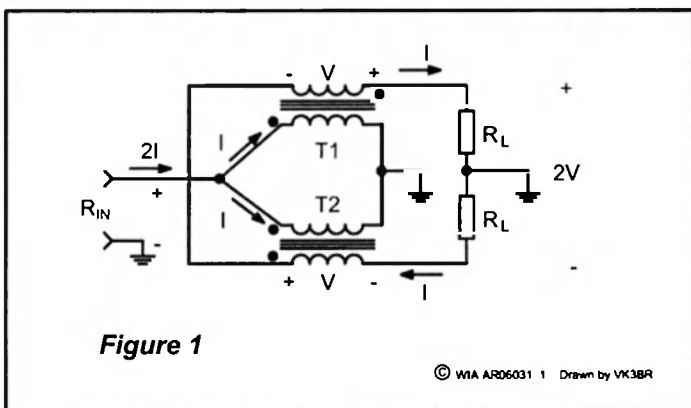

Figure 1

© WIA AR06031 1 Drawn by VK3BR

Fig 1 – Circuit diagram of the 4:1 transformer shown in Photo 4.

The Tx Level is usually set to a maximum of 0dB, but can be increased up to about +3dB.

Note that there is an absolute maximum of +10 dBm which can be applied to either the Receive or Transmit port.

The Ref Level in conjunction with the VertScale menu can be set to a value that gives a clear display of the traces.

Up to five markers can be set anywhere on the plots at points of interest and will display relevant data in the top left corner. The trace in Fig 2 shows markers at the HF amateur band limits.

The green (upper) trace is the S21 measurement and indicates the gain/loss through the two transformers. The maximum loss is about 1dB and occurs around 21 MHz – note that the grid line just above the green trace is 0 dB (Ref Level offset +5 dB) which is the Tx Level shown at the bottom of the screen. This indicates that each transformer has about 0.5 dB max loss.

The red (lower) trace is the S11 measurement of Return Loss and indicates

the SWR of the combination.

A reading of -14 dB or more corresponds to an SWR of 1.5 or better. The combined transformers are at least -16 dB which indicates each transformer has an SWR of 1.4 or less.

As mentioned previously, the sweep can be set to Free Run which is very useful if you want to adjust the tuning

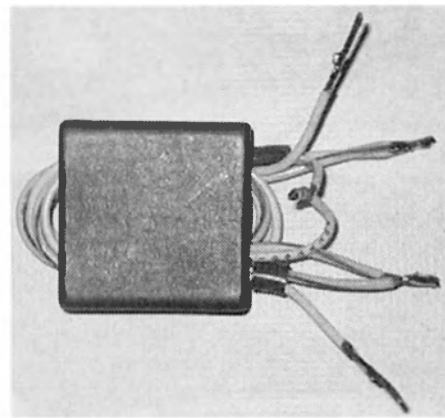

Photo 4 - A 4:1 transformer designed to match 200 to 50 ohms over 1.8 – 30 MHz.

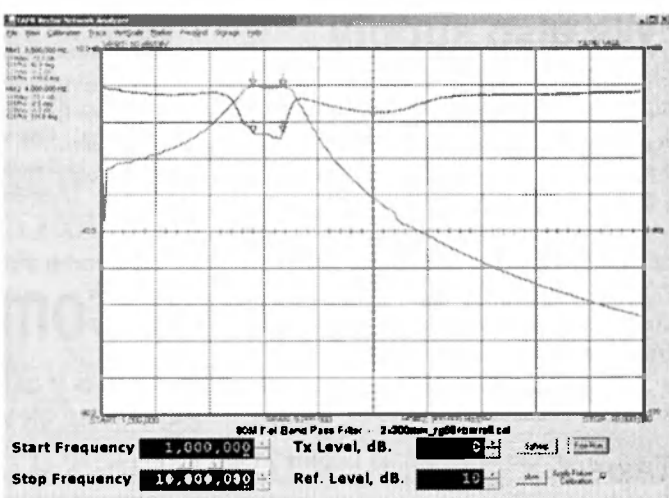

Fig 3 - Plots of an 80 metre bandpass filter which has markers at 3.5 and 4 MHz.

...America's Best!  
**TEN-TEC**

# TEN-TEC'S MIGHTY SIGNAL HUNTERS

Led by Orion II, the Mightiest Hunter of all



**Model 566  
 Orion II**  
 Ultra High-End  
 HF Transceiver

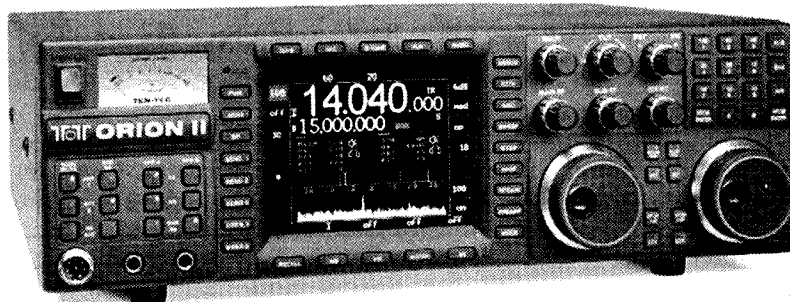

**LDG  
 AT 7000  
 Tuners  
 Now In  
 Stock**

## Model 6000 Vector Network Analyser

Turn your PC  
 into a VNA

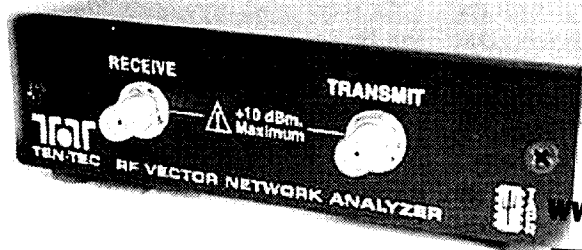

Download  
 the VNA  
 User manual from  
 our web-site



[www.ttssystems.com.au/new\\_page\\_4.htm](http://www.ttssystems.com.au/new_page_4.htm)

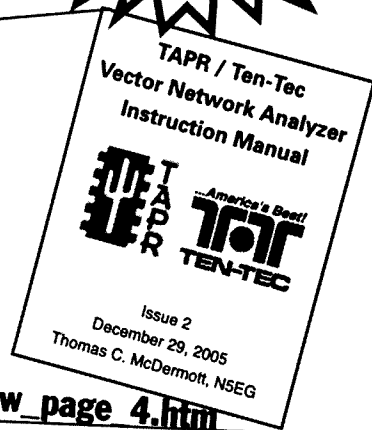

**Model 538 Jupiter**  
 An enduring favorite

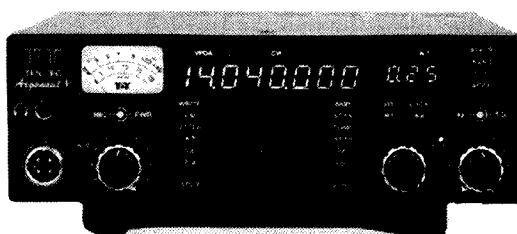

**Model 516 Argonaut V**  
 The best in QRP

Check us out  
 for  
 Solar Panels,  
 Regulators and  
 Deep Cycle  
 Batteries

### We also supply

- LDG DTS-4 & DTS-6 Coax Switches
- Amidon Iron Powder & Ferrite Coil Forms
- AUTEK WM1 Computing Power/VSWR Meter
- Buddipole Antennas
- Professional RF Cables and Connectors

**KITS**  
 for all  
 levels  
 of DIY



See you all  
 at Miena on  
 December 2



# TTS Systems Communications Equipment

[www.ttssystems.com.au](http://www.ttssystems.com.au)

**FREE CATALOGUE**

**HF and VHF Transceivers, Autotuners and Kits**

Phone 03 5977 4808. Fax 03 5977 4801 [info@ttssystems.com.au](mailto:info@ttssystems.com.au)

of a device to get the required frequency response.

Fig 3 shows plots of an 80 metre bandpass filter which has markers at 3.5 and 4 MHz.

Some other measurements available from the menus are listed below:

- (a) Time Domain Reflectometry (TDR) measurements, useful for coax cable fault finding.
- (b) Smith Chart (Polar) plots which show markers in frequency, complex number form and SWR.
- (c) Phase measurements of S parameters.

## Conclusions

The VNA is easy to use and can replace several different instruments which are often found around the ham shack. The only extra pieces of equipment you may require are SMA adaptors to suit your normal coax connectors.

See the following internet references for more information:

- <http://www.ttssystems.com.au>
- <http://www.tapr.org>
- <http://www.tentec.com>

## Editorial comment continued

struggling with health issues, while assisting with easing me into the Editor's role. Bill Roper VK3BR has been a tower of strength behind this journal for a long time, as recognised by the Board of the WIA with the presentation of Life Membership earlier this year. Not only has Bill been the "gatekeeper" for the Publications Committee; he has subedited material as it passed along the production chain, prepared the graphics (both photographs and circuit diagrams) for publication, maintained the Articles Register (essential to keep track of the progress of articles), and has been an excellent point of reference for many issues relating to publication preparation. Bill's contributions over many years are very much appreciated by many amateurs. Were it not for Bill's contributions, I probably would have continued to say "NO!" to the approaches I received late last year to take up this role!

I welcome Ernie Walls VK3FM aboard

the team as the new Secretary. In reality, this new role is simply a "change of hats", as Ernie has been a member of Publications Committee for some time. There may be some hiccups during the transition, but I am sure that Ernie will do the role proud. Bill will continue to assist as his health allows, especially in the preparation of diagrams – the consistent quality that you (normally) see is the result of Bill's hard work!

## New Contest Columnist

I can announce that we will have a new Contest column author, as of the November issue. Firstly, I must thank Ian Godsil VK3JS for his continued contributions. I welcome Ian's replacement, Phil Smeaton VK2BAA. Phil can be contacted via [vk2baa@wia.org.au](mailto:vk2baa@wia.org.au), so why not drop Phil a line and make some suggestions for column content – it is your column after all!

Cheers,

Peter VK3KAI  
ar

SPECIAL BUY  
VX-150 2m H/H  
only \$249.00

# G&C COMMUNICATIONS

Authorised dealer for • Icom • YAESU • Kenwood • Barrett RFDS • GME Electrophone • Uniden

See us for CAR Stereo too! ~ 'Cranbourne Car Sound'

## ICOM (Aus.) TRANSCEIVERS

IC-756 Prof III HF + 6M	\$4,999
IC-7400 HF +6M +2M	\$2,699
IC-7000 NEW! HF-70cm Mob	\$2,299
IC-706MKIIG HF-70 A'Mod	\$1,399
IC-718 HF SSB	\$999
IC-910H 2M/70cm M'mode	\$2,599
IC-2720H 2/70cm D/Band	\$699
IC-208H 2/70cm D/Band	\$579
IC-2200H 2M H/Power'	\$449
IC-T90A Tri-Band H/Held	\$479
IC-P7A Mini D/band H/Held	\$395

2 YEAR ICOM (Aust.) Warranty!

★ Full Product Range Available! ★

Full range of Communications/Scanner Receivers available from Icom, Uniden, Yaesu **\$ POA**

## HF Vertical Base Antennas

Comet CHA-250Bx 2.8-57MHz	\$599
Diamond BB7V 2-30MHz	\$499

## Antenna Tuners



MFJ-902	MFJ-902H
MFJ-904H	MFJ-945E
MFJ-949E	MFJ-929

More Details on Website



## Antenna Rotators

G450A (shown)	
G-2800DXC	
G-1000DXC	
G-800DXA	
G-650C	G-450C
G-550	G-550

## TE series EMTRON HF ANTENNAS

Australia wide orders welcome  
Credit card Cheque Money order

## YAESU Transceivers

FTDX-9000DA Elite HF Base	\$16,499
FT-897D HF - 70cm	\$1,399
FT-857D HF - 70cm	\$1,399
FT-817ND HF - 70cm	\$1,049
FT-8900R Quadband	\$799
FT-8800R Dualband	\$699
FT-7800R 2/70 Mobile	\$469
FT-1802M 2m 50W Mob	\$299
FT-60R2/70 H/D H/H	\$369
VX2R 2/70 H/Held	\$329
VX-6R 2/70 H/Held	\$499
VX-7R Tri-Band H/Held	\$599
VX-170 2M Rugged H/Held	\$279
VR-5000 Receiver	\$1,199
VR-500 H/H Receiver	\$499
VR-120D H/H Receiver	\$279

3 YEAR AUSTRALIAN WARRANTY

Call in and see our range of power supplies, cables and connectors

Comet & Diamond  
Antennas & Accessories

Proudly Supporting  
Australian Business

207 High St. Cranbourne VIC 3977

Ph: 03 5996 3298 Fax: 03 5995 0184

Email: [gccomm@bigpond.net.au](mailto:gccomm@bigpond.net.au)

[www.gccomm.com.au](http://www.gccomm.com.au)

# Curtain rod antenna mast

Steve Porter

(hopefully VK4VSP when the exam results come through)

Anyone that's ever done any renovating will tell you it's a never-ending job. There's always something more interesting or more important to do than sanding that ceiling ready to paint, or grouting those tiles that you put up two months ago.

Then there's the problem with disposing of all the rubbish. I mean, what do you do with a load of old wooden curtain rods and bits of PVC pipe?

You stick an antenna on them, that's what.

This was very much a make-it-up-as-you-go-along project, as I didn't really know what would work until I tried it. I had four wooden curtain rods sitting in the shed just collecting dust and gecko droppings. They're the type that use wooden rings to hold the curtains (the curtain rods, not the geckos).

In my darkroom (photography is another hobby), I had a length of one and a half inch diameter PVC pipe. This was originally meant for developing sheet film in, but that didn't work too well.

The PVC slips over the rods easily with a bit of play. In fact there's too much play, so each nine inch piece had a hole drilled in the middle and a piece of fencing wire passed through and twisted together on the outside. Duct tape was wrapped around the outside to protect fingers from the sharp ends of the wire. This wire stops the tube sliding down the rod and as it's only supporting the weight of the tube itself, it doesn't have to be too over-engineered.

Okay, that's the poles joined together, but they won't stand up by themselves so some kind of guying is required. Remember the curtain rings I mentioned earlier? Well, if you wrap a few pieces of fencing wire around a curtain ring and form a loop in each one, you have a way of attaching a

guy line. To stop the ring slipping straight over the PVC sleeve a joining piece was used for the top of each sleeve and the ring pushed onto that.

I was quite proud of myself when I made the first sleeve, but while making the second one the curtain ring broke

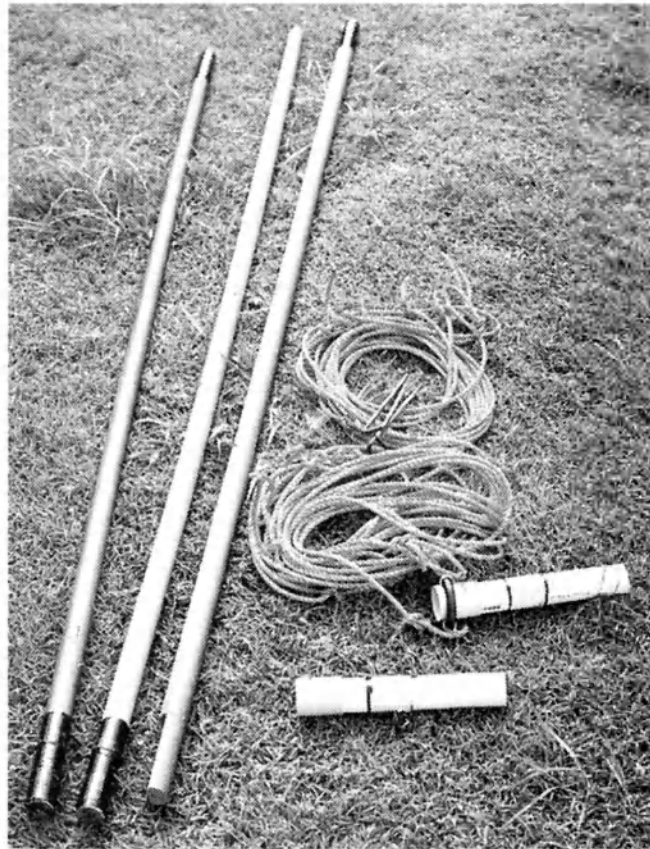

Photo 1 - The disassembled mast. Apart from the poles, everything, including the antenna, will fit into a small backpack.



Photo 2 - One of the PVC sleeves showing the attachment of the guy ropes.

**Adelaide Hills ARS  
BUY & SELL  
November 18th  
Westbourne Park RSL**

**BALLARAT ARG  
HAMVENTION  
SUNDAY 5TH. NOVEMBER 2006  
The Great Southern Woolshed  
Western H'way Ballarat**

**Central Highlands  
ARC of Tasmania  
Hamfest MIENA  
December 2**

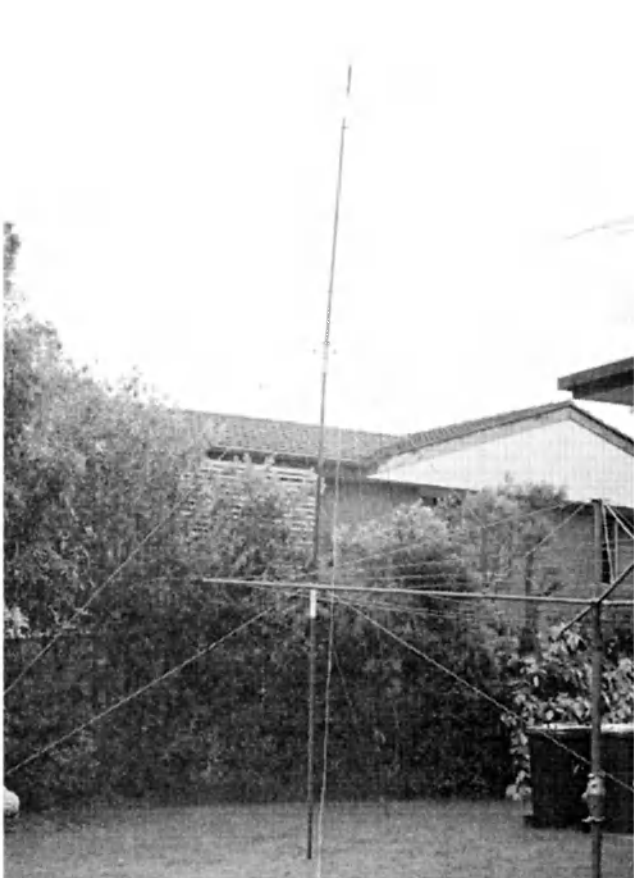

Photo 3 - The assembled mast in the backyard with the MP1 at the top. The wires hanging down are counterpoise wires for the antenna.

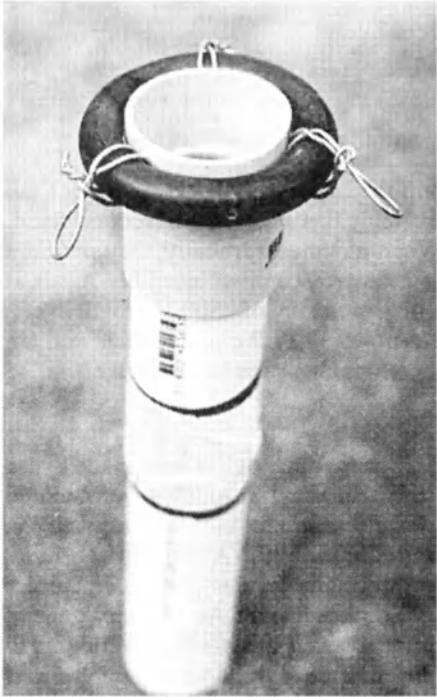

Photo 5 - Close up of one of the guy rope attachments. Fencing wire would probably be more effective and reliable, but almost anything that will fit around the pole could be used.

while I was trying to force it on. An easier method was just to use yet another piece of fencing wire formed into a ring with the loops on that. The curtain rod slips through the ring before going into the sleeve and the joint stops it sliding down any further.

And that is pretty much it. The guy ropes are just a couple of 30 metre rolls of poly rope bought from Bunnings, tied onto the loops at one end and pegged to the ground with tent pegs at the other. Duct tape was wrapped around the ends of the poles to make them a slightly tighter fit, and one end of the top pole was sanded flat on the side to hold a Super Antenna MP1.

Any more than three poles is probably going to be a bit too rickety and very difficult to get up. Getting three poles up



Photo 4 - It also works well as a flag pole. I do my bit for Australia Day.

was very easy, with my wife helping by holding the bottom on the ground while the rest was lifted.

The whole thing was tested with three poles and the MP1 at the top, but it could also be used as two masts of two poles each with a dipole between them, or three on one side and one on the other for a sloper. The possibilities are endless.

Just make sure you use poles that are no longer required for their original purpose, otherwise you may be using them as tent poles and the curtains as a tent.

Incidentally, it also works well as a flag pole.

# A 4-125 linear amplifier for 160 m

## Part 1

Drew Diamond VK3XU

Hardly a week goes by where we do not welcome a new station to the "Top-Band" 160 metre day-time amplitude modulation 11 am session. For the urban amateur with limited antenna space and height, the challenge of putting out a useful signal may seem rather daunting. A major factor limiting good reception is the almost universally high ambient noise level in most areas around our cities and towns.

In practice, it has been found that a fully modulated carrier power level of about 50 to 100 W into a reasonably effective vertical antenna is required for reliable cross-town ground-wave working. Yet few (if any) production model commercial transceivers will deliver much more than about 20 to 30 W continuous for AM work. Remember that the peak envelope power (PEP) will be about four times the carrier level, so a 100 W, 100% modulated, AM transmitter must be capable of delivering a PEP of 400 W to the load.

An accepted method of producing a potent AM signal at amateur power levels is with "plate and screen" modulation using valves such as 807s or 6146s. Unfortunately, for many amateurs today, there may be various technical and supply reasons as to why this approach is not viable. Therefore, my goal was to build a sensitive, single-band, 400 W amplifier using valves and parts that are obtainable either locally with reasonable effort, or from well-known US mail-order businesses.

The popular grounded-grid configuration, which requires a large input drive, is rejected in favour of a grid driven arrangement. Hence, a 100% modulated AM signal input of only 5 W carrier is required to produce a clean 100 W (400 W PEP - the legal limit) output from the amplifier. Additional low-pass filtering ensures that harmonics are at least -50 dB down on the fundamental. Naturally, the amplifier may also be used for SSB or telegraphy service.

### Choice of valves

Let me briefly discuss the choice of valves suited to the 400 W power level. My personal preference is for glass transmitting valves because when, and if, they glow too "red in the face", I want to



Photo 1 - The 4-125 linear amplifier for 160 m.

be able to see and correct it, so the ceramic family is ruled out.

Supplies of "sweep" type TV valves (6JS6, etc) are rapidly drying up; those remaining command high prices as replacements in older transceivers (nevertheless, their lower HV operating voltage is an attraction [Reference 1]). At least four of these operating in parallel or push-pull would be required (Reference 2).

813s certainly are still fairly plentiful, and (usually) reasonably priced, even new. They are rather tall, however, and cannot (or should not) be operated on their side, and so dictate a tallish cabinet assembly.

This leads us to the more compact 4-125, 6155, RSI007, QB3/300, 4D21 family (Reference 3). Maximum anode/plate dissipation is 125 W, and the screen, 20W. Maximum plate voltage is 3000 V (Reference 4). These devices,

and their necessary sockets, are not too difficult to find, new or second-hand. When mounted vertically, they permit a satisfactorily compact assembly. A pair, at a plate potential of 2500 V, will deliver a clean 400 W PEP output signal, and are therefore chosen in this instance.

### Circuit

An earnest attempt has been made to use parts that may reasonably be obtained by the resourceful builder. For instance, a modified 500 VA microwave oven transformer provides power for the 2.5 kV dc plate supply. An ordinary generic toroidal power transformer, in addition to powering the bias and screen supplies, has an additional winding fitted to supply the 5 V ac at 13 A for the two valve heaters. There we have two common difficulties neatly tackled. More information is given below.

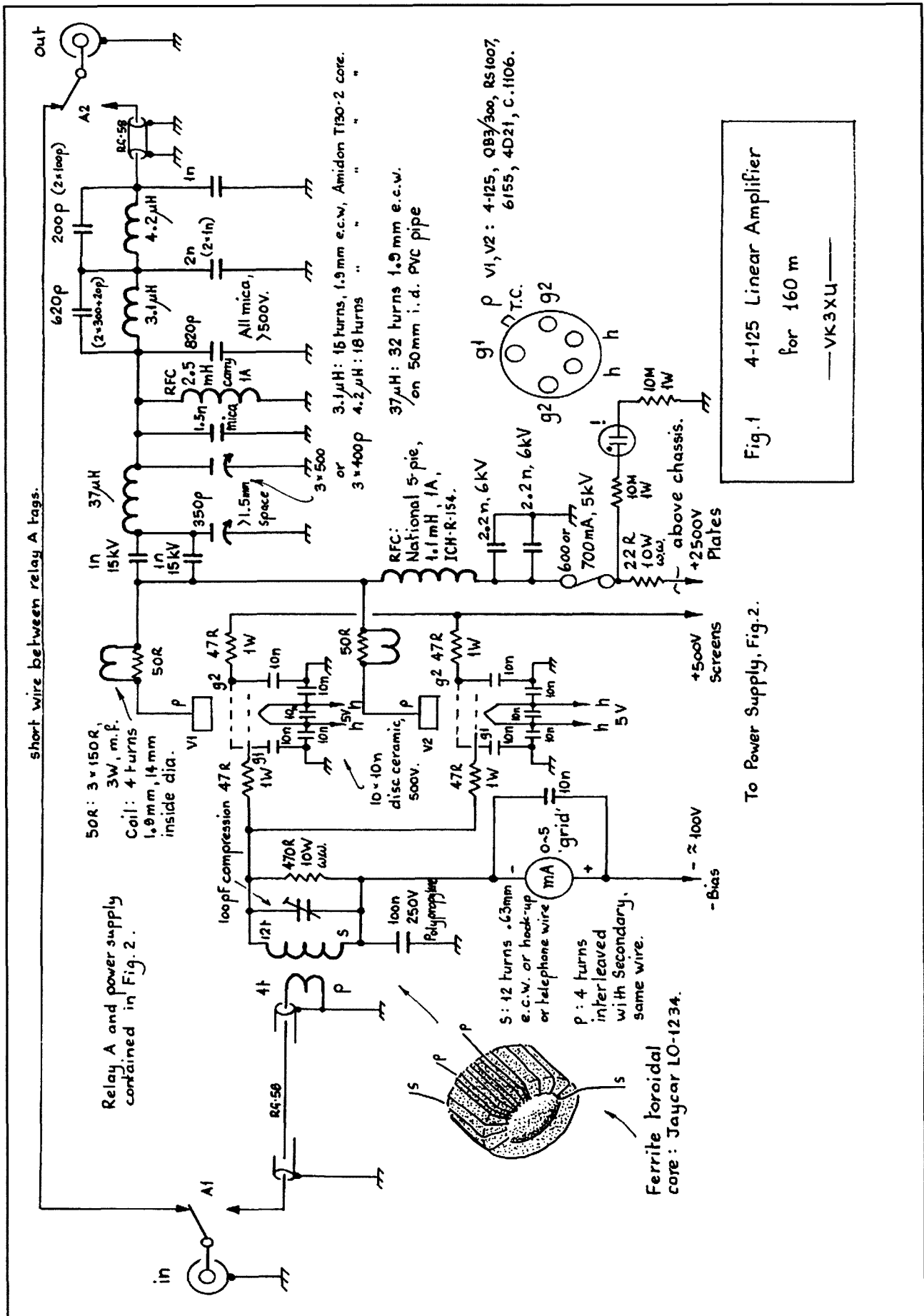

Fig.1 4-125 Linear Amplifier  
for 160 m  
—VK3XU—

To Power Supply, Fig.2.

Figure 1 - Schematic of the RF section of the 4-125 160 m linear amplifier.

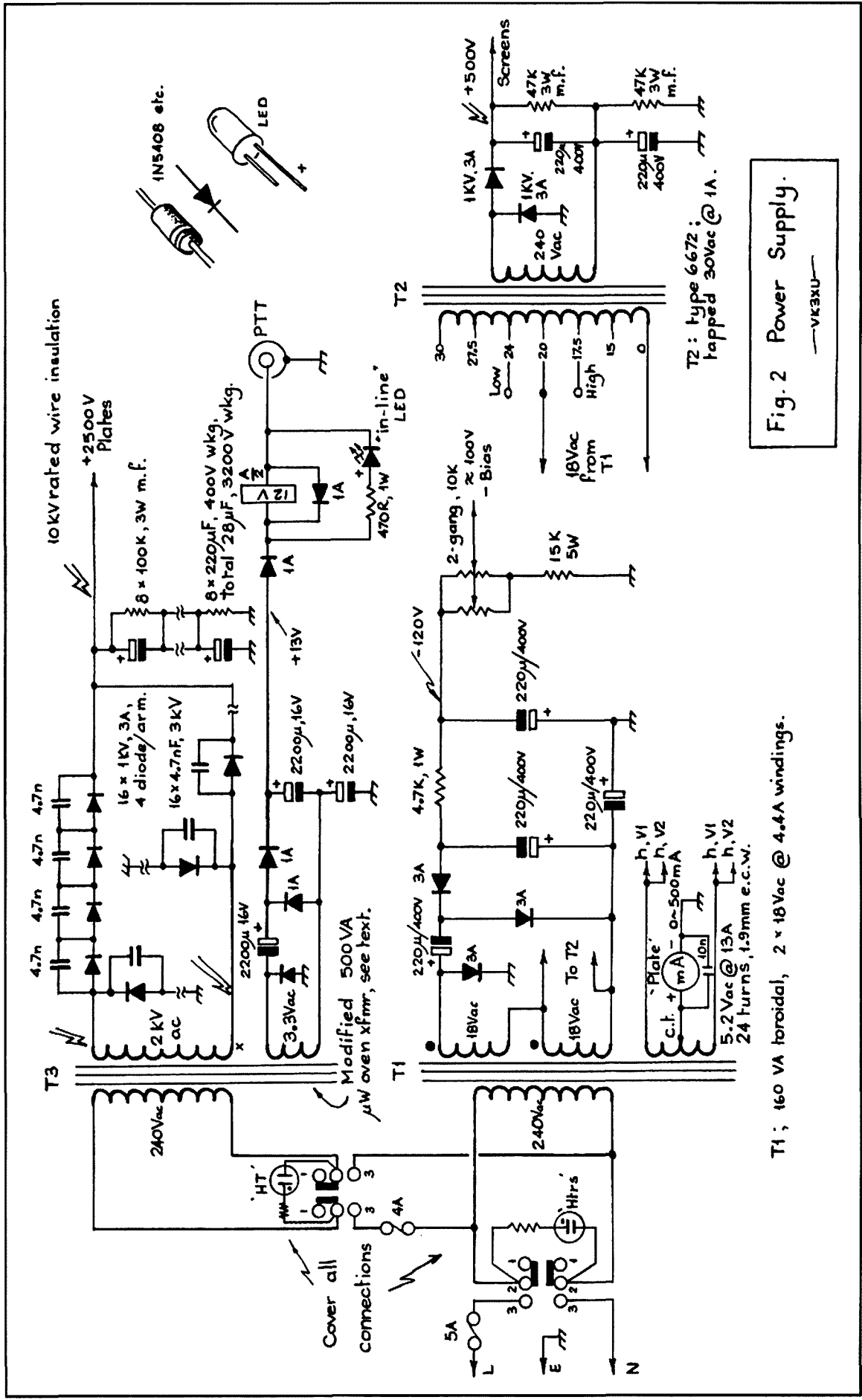

Fig.2 Power Supply.

—vk3xu—

T1; 160 VA toroidal, 2 x 18Vac @ 4.4A windings.

Figure 2 – Schematic of the power supply for the 4-125 160 m linear amplifier.



Two 4-125 (or equivalent) power tetrodes are operated in parallel, as shown in Figure 1. Rather than simply terminate the input grid circuit in 50 ohms, a 1:9 broadband toroidal step-up transformer effectively triples the signal voltage applied to the control grids. Only about 5 W drive is required to produce 100 W (the amplifier has 13 dB gain, so 20 W PEP input produces 400 W PEP output).

The secondary of the signal input transformer is terminated with a 470 ohm 10 W wire-wound resistor. A compression mica trimmer capacitor is adjusted to effectively cancel the self-inductance of the wire resistor, and thus establish a resistive input impedance to the amplifier that is close to 50 ohms at 1.8 MHz.

A generic 160 VA toroidal transformer T1 (Figure 2) with two series 18 V ac windings powers a conventional voltage tripler, and so delivers a maximum -120 V dc smoothed bias voltage to the control grids. A parallel wired (to improve reliability of this part) dual-gang 10 k potentiometer allows adjustment of the bias voltage (and hence control of the amount of standing no-signal plate current). A bias potential of (nominally) -100 V dc is applied to the grids, and thus establishes a no-signal standing plate current of about 20 or 30 mA for class AB1 or AB2 operation.

By experiment, it was determined that a screen voltage of 500 V dc yields maximum output coincident with best linearity for valve types QB3/300, RSI007 and 4-125. There are no known stock transformers presently available capable of providing such a potential, so I have applied the old dodge of using an ordinary low-voltage transformer (T2) back-to-front, powered by applying 18 V ac to the 0-20 V ac connections as shown. A voltage doubler on the (nominal) 240 Vac winding provides a satisfactorily regulated potential of about 500 V dc at the 10 or 20 mA needed by the screens. The screen voltage may be altered (within reason) by changing the tap position on T2, if required.

A plate potential of about 2500 V dc would be typical for such an amplifier, and that would call for a secondary HT winding of 2000 V ac at up to perhaps 400 mA. Fortunately, ordinary microwave oven transformers have a secondary HT winding of around that figure. When applied to a diode bridge and filter capacitor, a loaded plate voltage of 2300 to 2500 V dc is obtained, which is just

sufficient in this instance to give 400 W PEP output power. A 500 VA transformer, modified in accordance with Reference 5, is used here.

The 16, 1 kV/3 A controlled-avalanche diodes in the HT bridge do not require equalising resistors (as do ordinary diodes), but they each should have a 4.7 nF transient suppressor capacitor wired as shown to quench diode switching noise. Eight 220 µF/400 V electrolytic capacitors connected in series (total 28 µF) function as filter/reservoir capacitor for the HT plate supply. A 100 kΩ, 3 W bleeder resistor is connected across each capacitor to equalize the voltage distribution across these, and to bleed off their charge when mains power is removed (but read on).

In use, HT transformer T3 need only be powered when actually required to go "on-air". Where no HT plate supply is applied, the valves are effectively biased off, or at a very low, safe level. A special 600 or 700 mA high-voltage fuse is included in the dc plate supply line, which will blow should the plate to pi coupling capacitor fail. Also included is a 22 ohm 10 W current limiting resistor. In the unlikely event of a "flash-over" occurring, the resistor will limit the amount of instantaneous current available from the HT filter capacitor, and thus prevent serious damage (Reference 8).

The existing 3.3 V ac magnetron heater winding on T3 is voltage tripled to provide 12 V dc needed for the amplifier in/out relay (which must only be operable when the HT is "on"), operated by pulling the PTT line to ground via the transceiver. A panel mounted LED is wired across the relay coil to indicate that the amplifier is "in-line".

In order to determine the values required in the pi output tank circuit (Figure 2), we need first to calculate plate load impedance. According to most texts, plate load impedance for a class B amplifier (like this one) is approximately:

$$Z_p = \frac{E}{1.6 \times I} \quad \dots \text{(Reference 6)}$$

where

$Z_p$  = plate load impedance,

$E$  = plate voltage, and

$I$  = plate current in amperes.

In an experimental "lash-up" model it was found that, at a loaded plate voltage of 2300 V, plate current at maximum output measured 250 mA (0.25 A), which represents a calculated plate load impedance of approximately 5750 ohms.

Using the very helpful tables provided in Reference 6, for a loaded Q of 14, in round figures, input C (Tune) = 220 pF, inductance = 37 micro-Henry, and output capacitance (Load) = 1600 pF. Tune and load capacitors are (naturally) variable, so any error may be allowed for by adjustment. However, to check the correctness of the inductance needed, coils of values slightly larger, and slightly smaller, than 37 µH were made and tested in the pi tank circuit. The calculated 37 µH does indeed yield best output efficiency.

Rejection of the second (3.7 MHz) and third (5.55 MHz) harmonics by the pi output matching circuit alone is only about 30 or 35 dB, which is not nearly good enough for an amplifier of this kind. Therefore, the output is more thoroughly cleaned-up by passing the signal through a very effective and efficient elliptical low-pass filter (Reference 7). Insertion loss is measured at only 0.1 dB, whereas rejection of 2nd and 3rd harmonics exceeds 40 dB.

In accordance with standard practice, HF and VHF stability is assured by installing a 47 ohm 1 W parasitic stopper resistor close to each control grid and screen grid, and a 50 ohm (three parallel 150 ohm 3 W metal-film non-inductive resistors) and a four-turn coil at each plate cap (References 8 and 9). The chassis effectively isolates the input (below) from the output circuit (above chassis). These measures, together with the swamping effect of the 470 ohm terminated "passive-grid" input, render the amplifier unconditionally stable.

When the amplifier is in "idle" mode (heaters and bias on, and screen volts applied), there is a curious phenomenon where the un-powered plates "float" up to a potential near that of the screens (500 V dc in this instance). It is due, I think, to "electron-coupling" between screen and plate for each valve. There is a danger, therefore, that when work is required to be done in the high-voltage output area, one might assume that it is sufficient to simply switch the HT off, and all will be safe. Not so. Accordingly, a simple neon/resistor device is wired right there to remind the operator that high voltage exists, and to remove mains power (and allow time for filter capacitors to discharge) before any work is done.

Now for some deliberate (but plausible) mis-treatment:

For a tetrode amplifier, it is sometimes possible to damage the valve(s) if full

drive signal is applied where plate voltage is absent (HT fuse blown, for instance), but screen voltage exists. For the prototype model, screen current is 50 mA for each valve (total 100 mA). Such a demand causes the screen supply to fall to 360 V. Screen dissipation is .05 x 360 = 18 W, just below the 20 W maximum. No damage was detected.

Next test was to "hot-switch" the amplifier in and out (by switching HT on and off) with full drive and maximum output power. No damage was detected.

Brief but intentional serious mis-tune, causing brightly glowing plates, caused no damage, and full HT applied to cold valves (no warm-up) also caused no damage.

Construction details will be given in Part 2.

## References and further reading

1. "A 250 W SSB Linear Amplifier"; I Pogson VK2AZN, Electronics Australia, April 1967.
2. "400 W Geaard-rooster versterker met passiefingangscircuit (Friniair); P Geerligs PA0FRI, Electron (Dutch) October 1997.
3. "A Linear Amplifier for Australian Conditions"; R Reynolds VK3AAR, Amateur Radio, April-June 1978 (3 parts).
4. Care and Feeding of Power Grid Tubes; Varian Publication, 3<sup>rd</sup> edition, 1978.
5. "Re-using Microwave Oven Transformers for HV Supplies"; Amateur Radio, March 2006.
6. "Pi-network design for high-frequency power amplifiers"; I Hoff W6FFC, Ham Radio, June 1978.
7. "Low-pass filters for solid-state linear amplifiers"; K Shubert WA0JYK, Ham Radio, March 1974.
8. Radio Handbook; Wm Orr W6SAI, Sams, 23<sup>rd</sup> edition and recent previous editions.
9. "Using the 4-125, 4-250 and 4-400 in Kilowatt Amplifiers"; R Rinaudo W6KEV, QST, July 1962.

**to be continued**

# Gold Coast Hamfest

## 11th November

at the

Albert Waterways Hall, cnr Hooker & Sunshine Boulevards, Broadbeach Qld. Doors open to the public at 9am.

# Andrews Communications Systems

### ICOM DISCOUNTED

IC-756 Pro III HF+6m	\$4,999
IC-V8000 2m 75W	\$399
IC-746 Pro or IC-7000	\$2,499
IC-706 Mk 2G HF-70cm	\$1,399
IC-718 HF SSB	\$999
IC-910H 2m+70cm SSB	\$2,299
IC-208H 2m+70cm	\$579
IC-2200h 2m 60W	\$399
IC-T90A Triband h/h	\$449
IC-2720H Deluxe D/bander	\$699
IC-P7A New tiny D/bander...	\$389
IC-V82 2 m H/H	\$369

**\*3 YEAR WARRANTY\***  
**ALINCO**

### Factory Direct Importer

NEW DJ-V17 5W 2m H/H	\$249
NEW DR-635T Twinbander	\$699
DR-135T Mk2 2m 50W	\$299
DR-435 UHF 35W	\$369
DJ-V5E Dualband handheld	\$499
DJ-X2000E Hi-tech scanner	\$679

**\*3 YEAR WARRANTY\***

Spectrum Analysers from \$999

### ICOM IC-7000 \$2199

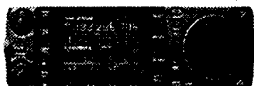

**HF-70cm COLOUR TFT DISPLAY**  
IF DSP, Twin PBT, 508 channel memory + more

### bhi DSP NES10-2

Amazing DSP speaker

Hundreds sold!



**\$249**

### KENWOOD DISCOUNTED

TS-570SG HF+6m+ ATU	\$1,999	TM-D700A Dualband Mob	\$899
TS-480HX HF 200W+6m	\$1,999	TS-480SAT HF+6m+ ATU	\$1,899
TS-2000 HF~70cm + ATU	\$2,799	TM-G707A 2m/70cm mob.	\$499
TS-570DG HF + ATU	\$1799	TM-V708A Dual band Mob.	\$799
TM-271A K 2m mobile	\$379		

**\*3 YEAR WARRANTY\***

**NEW**

### YAESU DISCOUNTED

FT-1802M 2m 50W Mob.	\$289	FT-60R Dualband h/h	\$369
FT-7800R Dualband	\$449	FT-817ND HF-70cm Port.	\$999
FT-8900R Quadband	\$799	VX- 1R H/held 2 batts	\$249
FT- 8800R Dualband	\$699	VX- 2R Tiny Dualband	\$319
FT- 897D HF-70cm	\$1,399	VX- 170 2m H/held	\$269
FT-857D HF-70cm	\$1,299	VX- 6R Dual H/H	\$449
FT- 2800M 2m 65W	\$299	VX- 7R Deluxe H/H	\$549

**\*YAESU ROTATORS DISCOUNTED\***

**\*3 YEAR WARRANTY\***

**Australia's Biggest Amateur Radio Stockist**

### HF VERTICAL ANTENNAS

CUSHCRAFT R8 40m-6m	\$899
CUSHCRAFT A3 WS WARC Yagi	\$999
DIAMOND CP-6, 80m-6m	\$499
DIAMOND BB7V Broadband	\$499
COMET CHA-250B B/band	\$599
MALDOL HVU-8, 80m-2m...	\$499
18 AVQ Mk II	\$449
HY-GAIN DX-88, 80m-10m...	\$799

THP, LDG, MFJ, ALINCO, ICOM, YAESU Automatic antenna tuners in stock  
TET-EMTRON HF Antennas in stock  
AVAIR POWER METERS, "T" LEADS, ETC.  
MFJ Antennas, Tuners, Analysers, etc.  
ANDREWS AMPS ..160m-10m 500W+ w/protect. \$999, 2m 120W \$329, 2m 200W \$449, 2m 300W \$999.  
ANDREWS YAESU, PALOMAR, TE SYSTEMS, AMERITRON, ICOM linears

### ANDREWS AMATEUR BASE ANTENNAS

BF-2M2 Fibreglass 2m 6.7dB	\$69
BF-2M3 Fibreglass 2m 7.8dB	\$99
UVS-200 Fibreglass 6dB/8dB	\$149
UVS-300 F'glass 8.3dB/11.7dB	\$199
CBS18 Fibreglass 5.7dB 10m	\$179
Discones from \$99, Coax switch \$29	
Hustler HF Verticals	From \$349
Massive stocks MFJ Antennas, Tuners, Digital Analysers	

**CALL (02) 9636-9060 or (02) 9688-4301 or FAX (02) 9688-1995**

Shop 8, 41 Bathurst St., Greystanes, NSW 2145

**MAIL ORDER to PO Box 240 PENDLE HILL NSW, 2145**

<http://www.andrewscom.com.au>

email: [lee.andrews1@bigpond.com](mailto:lee.andrews1@bigpond.com)

**WHY PAY MORE?**

Some items inc'dent.  
Prices subject to change without notice.  
Limited stock some items E&OE '0/06

# Idyll Daze on the Clarence River

Richard Cortis VK2XRC

Some time on a cold winter evening in 2005, my wife said she wanted to go somewhere different for our Christmas-New Year break. OK. But you make some suggestions. What about a houseboat on a river somewhere up north? OK. Where do you have in mind? "I'll have a look" she said. An hour later I am presented with the website of Clarence Riverboats. OK. But you have to book it. So she did.

Presented with the booking, I thought I had better get my gear into shape and work out how I was going to play amateur radio on my holiday. I decided that it had to be light weight, portable and simple to erect. At the planning stage, I did not know much about the houseboat apart from the brochure pictures from the internet. I assumed that the houseboat would have a decent 12 volt battery because that is how they run the lights and the TV, etc. The fridge is gas. So I did not take a battery.

The antenna was a major consideration. It had to be simple to transport and erect, and be frequency agile so that I could change bands without a lot of kerfuffle. I had one of those ten metre extendable fibreglass rod/tower things

from a previous dream and I thought it would be a good start. However, a vertical whip has to have a ground plane to drive against, so I drew on experience playing with marine radios on ocean racing yachts which told me I only needed about 150 mm of copper plate in the water.

I scouted around and found a discarded, corroded, and bent piece of 40 mm diameter copper pipe, hacked off 250 mm (for good measure) and attached some wire with an ugly looking soldered joint. I ended up having to use the old Scope soldering iron augmented with a reasonable propane burner to get the solder to flow. Also, the corrosion pits were a bit deeper than I first thought. I do not think the RF (at HF) cared about the look of the joint. In the racing yachts we

## Rippletech Electronics

### HIGH PASS FILTERS FOR TVI PROBLEMS

Most TVI problems are due to the inability of the TV set to reject strong out-of-band signals - i.e. those from a local HF transmitter. Rippletech High Pass Filters are designed to reject all HF signals, not merely optimised to reject CB. The HPF-50/55 has a cut-off frequency of 50 MHz and better than 55dB of attenuation on 10m and at least 80dB of attenuation on 80m.



TZ-1840	1:1 1kW 160-10m Balun	\$ 59.00
TZ-330-4	4:1 1kW HF Balun (3 - 30 MHz)	\$ 59.00
TZ-SL8	80m Sloper (use tuner on 17 - 30m)	\$ 99.00
TZ-SL16	160m Sloper (fits a suburban lot!)	\$ 110.00
TZ-D-4080	40m/80m Trapped Wire Dipole	\$ 176.00
TZ-V-3	10/15/20m Trapped Vertical	\$ 189.00
TZ-V-4	10/15/20/40m Trapped Vertical	\$ 289.00
TZ-V-3L	20/30/40m Trapped Vertical (NEW)	\$ 220.00
TZ-V-3w	12/17/30m Trapped Vertical	\$ 199.00
TZ-V-3x	12/17/40m Trapped Vertical	\$ 209.00
	Radial kits (1 radial per band)	\$ 33.00
TZ-RD-3	10/15/20m Trapped Rotary Dipole	\$ 279.00
TZ-RD-3w	12/17/30m Trapped Rotary Dipole	\$ 289.00
TZ-RD-3x	12/17/40m Trapped Rotary Dipole	\$ 309.00
TZ-RD-40	17/40m or 20/40m Rotary Dipole	\$ 289.00
TZ-1000RC	FT-1000mp remote controller	\$ 55.00
HPF-55/5C	High Pass TVI Filter (available now)	\$ 39.00
	Mobile base & Z bracket combo	\$ 11.00

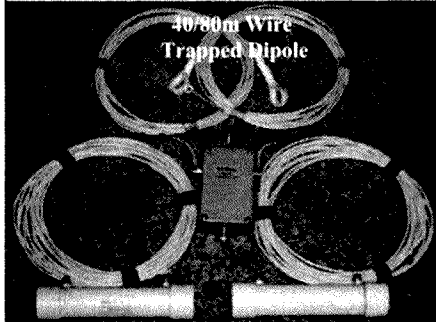

### The Innovator - not the imitator

Our tri-band, quad-band and tri-band WARC verticals have been big sellers for several years now, so good imitations are starting to appear! Compliments abound - check out buyer satisfaction on our ebay sales. We couldn't be more flattered. The verticals are perfect for the ham with limited space, field days, mini expeditions or travellers. With a packed length of only 1m, they fit in your boot or on a plane. Using the same high Q, scaled coaxial traps exhibiting 40 dB of isolation at resonance you get really great performance & ultra wide bandwidth. Even better is the ease of set-up, comprehensive and detailed instruction manual and no compromise construction.

### Need something special?

Make a call and we'll see if we can meet your needs.

[www.rippletech.com.au](http://www.rippletech.com.au)

Contact Tony - VK3TZ B.Eng (comms) MBA

0402 622 562 or 03 9887 4936

email:

[sales@rippletech.com.au](mailto:sales@rippletech.com.au)

Mastercard, Visa and Bankcard accepted

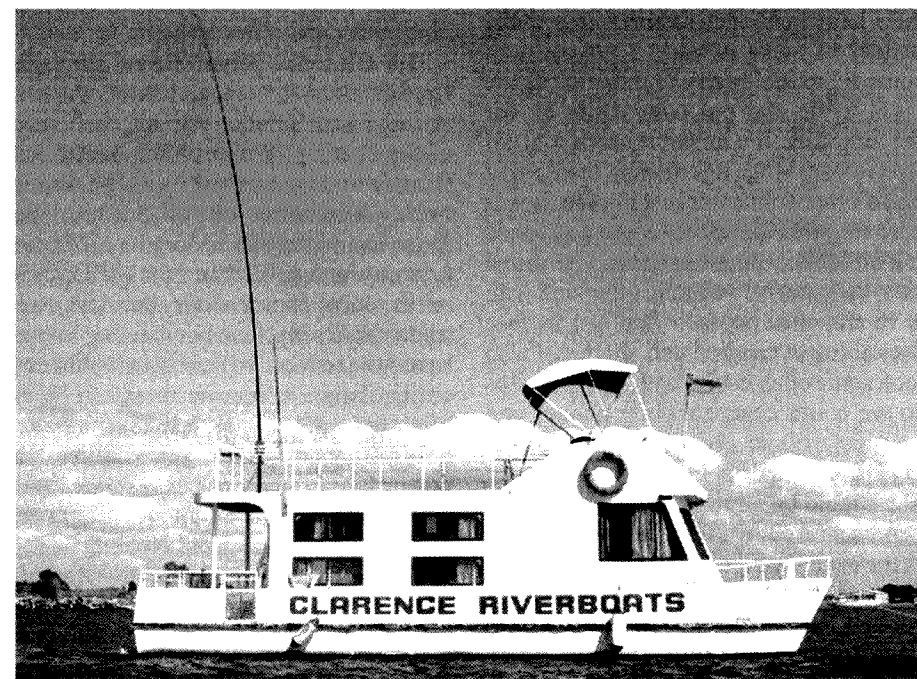

Photo 1 - The *Idyll Daze* with the two antennas mounted to the rear of the upper deck.

had nice hydrodynamic dynaplates. On the houseboat we were going to have an ugly piece of copper pipe about the same surface area as the dynaplate. And a bit cheaper too!

Being a belt and braces type (you only have to look at my figure to see why), I decided that a second antenna was in order. I had recently purchased an Outbacker antenna for another dream and I thought I should bring it along and give it a go. The Outbacker is intended for mobile use, and has a large and stiff mounting spring with a half inch diameter bolt to connect it to the support structure. Band tuning is with a jumper lead into banana sockets on the antenna and fine tuning is achieved with a stub at the top. You have to bend the spring to get to the stub which means the support structure has to be up to it. I guess that is why the half inch bolt is there.

I welded up a stainless steel angle bracket and welded a half inch stainless steel nut to it to accept the antenna. I bolted the bracket to a metre length of pine floor board I found on the Council cleanup. I

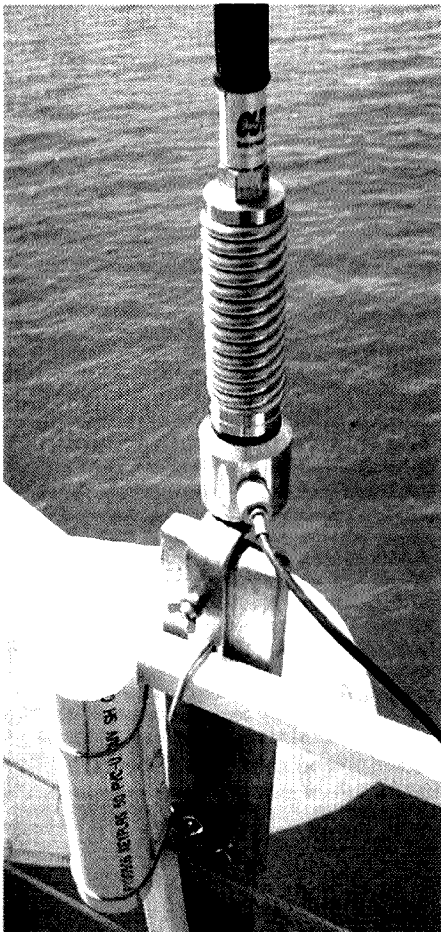

Photo 3 – The mount and spring for the Outbacker antenna (see text).

drilled and tapped some studs to allow connection of the recommended heavy earth strap and then drilled some holes for some U-Bolts to allow attachment to a rail. I also drilled some holes in the timber and inserted some Venetian blind cord to tie the bottom of the timber to the rail. I tried out the Outbacker using the manufactured bracket attached to the temporary fence panel on a nearby construction site. Indications were that it tuned satisfactorily on all installed bands.

Now for the tuner: I have an EAT300 from years ago but it was a bit of a hassle because I wanted to play radio propped up in bed and I also wanted to tune the antenna at the feed point. Using the EAT300 would mean putting down my beer and getting out of bed. So I just rationalised. We were going on a holiday to have fun and it was costing a heap. I have always lusted after an auto tuner. So I wrote away and ordered one of those SG-237 auto tuners. I will be able to use it for years and years I told myself.

The rig I intended to use was a Yaesu FT817 which is only capable of about five watts (the IC706 was a bit big to take to bed with a beer). So I needed some power. I bought a small HF amplifier from a member of our local Waverley Amateur Radio Club. The intent was to set the amplifier up next to the tuner and run co-ax and a light power cable down to the FT-817 in the cabin.

The system is starting to come together. All I have to do is to connect it up to the battery to make it work. I set out with some relatively heavy (I thought) figure eight cable and put connectors on for the amplifier, the tuner (it needs a bit of twelve volts when it is tuning), the FT-817 and a spare connector just in case. It was hard to guess the cable length so I made it a bit longer. I put big (battery terminal size) alligator clips on the other end with a 35 amp fuse in each line just in case the cable got crushed and shorted. I also took some other cables with alligator clips so we could charge mobile phones and (particularly) so my wife could use her DVD player and her twelve volt hairdryer. She should be allowed some toys too.

As a shakedown test, I set the gear up in the back yard and made a few contacts. I was satisfied that the system worked. I packed the lot up and it all (apart from the telescopic mast) fitted in a slightly large shopping bag from the hardware store. I turned it around so I could not see the advertising on the bag. I added a

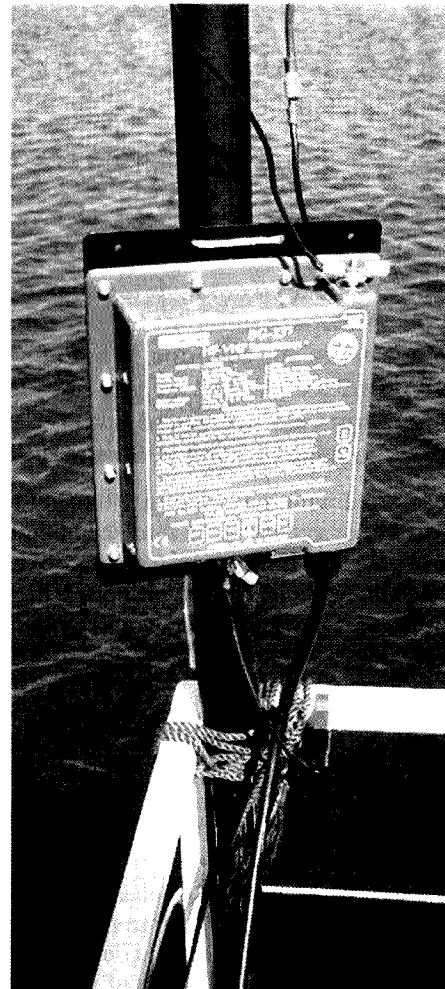

Photo 2 – The SG-237 auto tuner mounted at the base of the ten metre extendable fibreglass rod antenna.

multimeter and a few basic tools.

The Clarence River flows through Grafton and Maclean, and enters the sea at Iluka and Yamba, one on each side of the opening. We hired the boat from Brushwood, a one pub village about twenty kilometres out of Grafton. We drove from home in Sydney to Taree the first day and talked to Noel VK2ZNS on the local repeater. On holidays, we try to drive only four hours a day so we have time to look at places we would not ordinarily see. It was nice to talk to Noel because I had not spoken to him since he left Sydney quite a few years earlier. He said he tries to answer all calls on the local repeater so that travellers at least get an answer. Most appreciated Noel.

The next day we drove to Grafton where we discovered that the whole town was locked and deserted. Only one pub was open. Eerie. Walking down the street felt like the day after the neutron bomb. It was 35 degrees and it seems the whole place goes to the coast where it is several

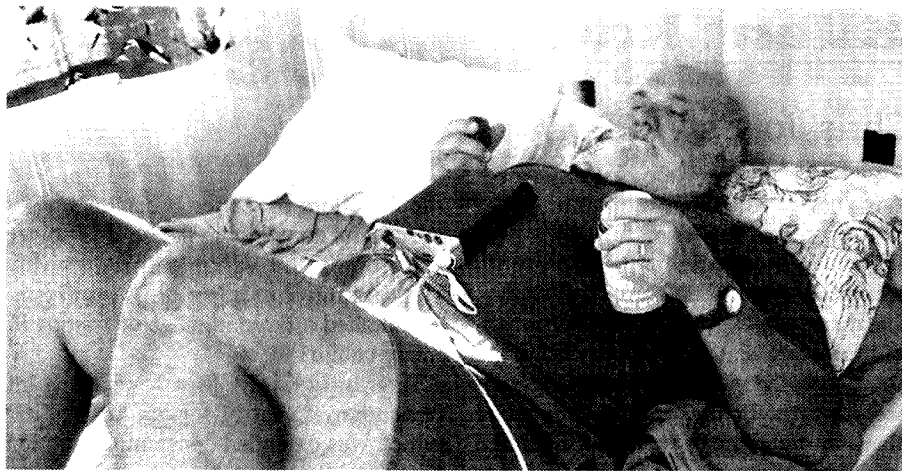

Photo 4 – In my comfortable marine mobile operating position.

degrees cooler. Anyway, the supermarket was open and we were able to buy supplies and some liquid ammunition.

After breakfast and another visit to the supermarket, we went out to the base at Brushwood and made our acquaintance with *Idyll Daze*, our home for the next week. When we stepped on board the boat, I discovered that it was aluminium, so the slightly heavy copper pipe with the ugly soldering was not required. Eager to get going, we dumped all our gear and necessary supplies on board and set off on our little odyssey.

I did not put the antenna up before we left, for several reasons. Firstly, there were overhanging trees at the base. Secondly, we had to go under a low bridge close to the base, and thirdly, I was too impatient and I wanted to go then and there. So we set out.

We headed downstream and anchored for lunch. Then I set up the antennae and had a swim. The ten metre telescopic mast was set up in the corner of the rail on the upper deck. I used Venetian blind cord to tie the mast to the rail and to tie the tuner to the mast. The ground side of the tuner was attached to the rail with the large (battery terminal size) alligator clip I attached at home. The radiating element of the antenna is a piece of copper power wire attached at the top and wound a few times around the mast to stop it sagging away. The top of the mast is VERY bendy. Some insulating tape was also useful.

The Outbacker antenna was set up on the rail on the opposite side. The stainless steel bracket I manufactured and attached to a plank worked perfectly. I just bolted it on with the U-bolts as intended and it stayed there the whole trip. I did not connect the Outbacker initially.

As planned, I put the amplifier on the

deck and attached it to the tuner and the power cable. In the back yard, I had set everything up next to the antenna and made it go. However, on the houseboat, I wanted to operate propped up in bed in the cabin. But the power cable went upstairs to the sundeck. So I demonstrated that the system was operable and went downstairs to check if the beer was cold enough.

Later, we moved on down the river and anchored for the evening in an idyllic looking place. As darkness was gathering, we made some dinner and watched the lightning in a thunderstorm on a nearby hill. The storm looked like it was passing us by. A couple of minutes later it was on us just as the dinner hit the table. In a matter of five seconds the wind turned from five knots from the north east to fifty knots from the south east. It

hit us on the side blowing the clock off the wall and the food off our plates. My wife saved the bottle of wine. We were driven across the river as though we did not have an anchor down. The motor had

not enough power to stand the boat into the wind so we just went sideways with the maelstrom. Luckily, we were driven into the entrance of an inlet called the Broadwater. The anchor caught when we had less than a foot of water under the keel.

When the wind abated, we discovered the dinghy swamped and the oars gone. We collected the steak and put it through the grill to treat whatever was picked up off the floor and warm it up a bit. We

**When the wind abated, we discovered the dinghy swamped and the oars gone. We collected the steak and put it through the grill to treat whatever was picked up off the floor. We never did find the salad. My wife produced the two remaining wine glasses and what was left of that good bottle of wine. "Are we having fun yet, dear?"**

never did find the salad. As the wind dropped to about fifteen knots, we sat down to what was left of dinner. My wife produced the two remaining wine glasses and what was left of that good bottle of wine. Then she asked "Are we having fun yet, dear?" The wind was calm an hour later and we had a good night's sleep. Welcome to the Clarence River!

Next morning we motored further downstream to Maclean. We arranged for a replacement pair of oars. Then I spent an hour scouring the town trying to find some suitable power cable and some connectors. My wife was not amused because she does not like that kind of shop and really just wanted to have a cup of coffee and a cake in one of the lovely coffee shops in town. We did, but I wanted to get the cable before we got too settled. All satisfied.

Later, we motored a few kilometres downstream and anchored in a lovely inlet, where we had some lunch and a swim. The water was thirty degrees Celsius. Doesn't everyone take an inside/outside thermometer with them on holidays?

I actually played some radio in the afternoon and dropped in on Col's Net. In the evening, I played a bit more radio. The setup worked beautifully on 40 metres. However, with the amplifier on high power there was a big voltage drop and associated distortion. I dropped the power a bit and lost the distortion. I tried all the HF bands and they seemed to tune quite well. However, most of my contacts were on 40 metres for no reason other than I felt like it.

The next day we set off downstream to Iluka and spent a couple of pleasant evenings anchored in the little harbour. The locals seemed to spend the daylight

hours of New Year's Eve with vigorous exertion water skiing around the place so it was no surprise that they all seemed to be in bed by 10 pm. At this stage I must apologise to all the contacts I made because I have misplaced (lost) my log notes. One contact was a guy in Victoria who said he had a friend who owned a yacht and was presently anchored in Iluka but he could not remember the name of the boat. I looked out the window and

suggested the name of the boat anchored next to us. That was it! What a coincidence.

Next morning I joined the yachties net on twenty metres and said hello. We had an eyeball from boat to boat but time and the very swift tide were against us making closer contact. We wanted to see Yamba (just across the river) and then move upstream with the tide rather than against it.

We spent a pleasant day in a little backwater channel between Yamba and Maclean. However, I did have one little emergency when my wife casually asked if my antenna would fit under the 11 kV power lines just ahead. A very quick stop and an about turn was in order.

As I went up to the top deck I found what had made the noise I had heard a bit earlier. I thought at the time that it was the wind blowing a chair over on the sundeck upstairs. The sound was a bit like a billiard ball rolling down the stairs. What actually made the sound was the extendable antenna mast un-extending itself with a bit of help from the wind. Apparently, one of the lower sections loosened and dropped and, as it hit the deck like a billiard ball on the stair, the next section was loosened and dropped too, and so on till there were only two sections standing. Well, at least I would not have collected the 11 kV power line. But we were very, very careful after that little episode.

We went on upstream the next day, and had lunch and dinner in Maclean before moving out onto the river to anchor over night. After Maclean we moved further upstream to the historic little town of Ulmarra which has a nice pub with properly cold beer. Our last night was spent in a quiet little channel with yet another wild thunderstorm, but this time the anchor held.

I did not use the Outbacker antenna a lot because I wanted to tune around a bit and the Outbacker is best suited to use where people want to work a particular part of a band. At the time of this trip, the weather was about thirty five degrees Celsius every day so I was particularly disinclined to stand in the sun adjusting the antenna. But I was impressed. I just have to find part of the old Falcon that is stiff enough not to buckle when I bend the support spring. I always need a project!

Although I did not play a lot of radio games, we did have a good holiday. In answer to the question at dinner on the

## Silent key

### Chris Jones VK2ZDD

I met Chris Jones for the first time about two years ago, when momentum was gathering for the formation of a new national WIA, and he invited me over to his place in Menai one Thursday evening. The diverse backgrounds of other guests, and the convivial spirit which filled the place, resulted in this becoming a regular social event for me. It was over many meals and glasses of wine that I learned something about Chris' past and his hopes for the future of the WIA.

He was very active on 2 m in the 1970s, and was a frequent visitor to the old WIA establishment at Atchison Street, St. Leonards. He was a conspicuous member of the younger section of the Sydney VHF Group, who injected new life and a good deal of frivolity into an otherwise staid group of old hands.

His interest in amateur radio was re-kindled about four years ago, and he was one of the prime movers in the founding of the new WIA. He vigorously expended much effort to get the new organisation under way. He was on the phone sorting out WIA matters from his sickbed the evening before he died.

In professional life, he was one of the founders of Zener Electric, a very successful company in the field of power electronics and variable speed drives. His regular business trips overseas established a large number of friends in many countries.

But the genial Chris Jones will be remembered mostly for his hospitality, which was extended constantly from his home in Menai. It was a regular meeting place for an amazing variety of people, a large number of them from the amateur radio fraternity. He was a wonderful host, whose intelligent conversation and dry wit enlivened any gathering. The enthusiastic welcome lavished on all visitors by Chris's faithful labrador Max somehow reflected his master's approach to the world at large.

Chris Jones will be sadly missed by his friends in amateur radio, and the many in this country and beyond who had the good fortune to know this remarkable Australian.

ARNSW extends its deepest sympathy to Chris's sister Anne and her family.

submitted by Owen Holmwood VK2AEJ  
Secretary ARNSW



# An isolation unit for answering machines

A control unit providing telephone line isolation and removal of mains power from an answering machine during stand-by periods.

P Anderson VK2GPT

This offers protection against the damaging effects of mains supply surges and telephone line transients. Owing to minimal power consumption, battery operation of the unit has been adopted.

## Circuit description

On receipt of an incoming telephone ringing signal, the isolation unit connects the telephone line and the mains supply to the answering machine which starts recording an incoming message. After a period of about three minutes the unit switches to stand-by mode in readiness for the next eventual incoming call.

To reduce the possibility of false triggering caused by invalid signals that may occur on the telephone line, such as transients, a DC signal of required

amplitude is applied to IC1 only after reception of a pre-selected number of ringing cycles. This delay is achieved by network elements ahead of IC1.

With IC1 activated, monostable IC2 triggers and its output at pin 10 goes high for a duration of about three minutes. This causes current to flow through Q2 and activates solid-state relay IC3 to restore power to the machine. Concurrently, relay RL1 is energised and connects the telephone line to the machine.

Four "AA" alkaline cells supply current

to the isolation unit, which draws 165  $\mu$ A on stand-by through a low drop-out regulator IC4.

When a large number of incoming calls is anticipated, type "C" or "D" cells are advisable.

## Construction notes

One of the dual multi-vibrators in IC2 is not used and consequently it is necessary to link the relevant pins of IC2 to VDD or VSS in the manner shown in the diagram.

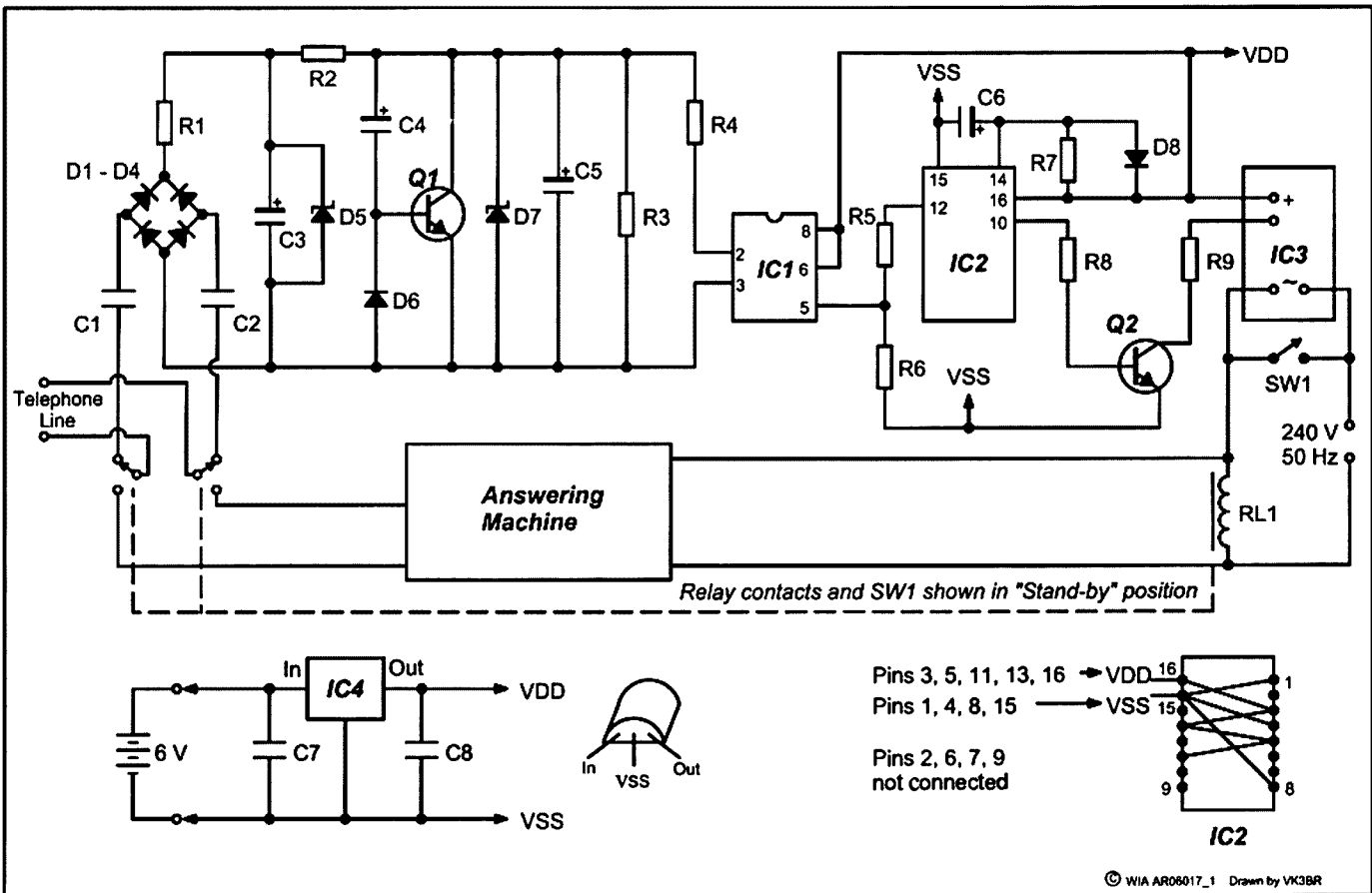

Fig 1 - Circuit diagram of the isolation unit.

For safety considerations, all mains-carrying wires and components must comply with wiring rules. To avoid erratic triggering, all mains-carrying leads must be distanced from other leads and especially from the inputs of IC1 and IC2.

All components are mounted on Vero board except for RL1 and IC3 which are affixed onto an earthed shielded partition. C6, R7, and D8 should be mounted very close to pins 14, 15, and 16. R5 should be mounted close to IC1 and IC2, and R4 close to pin 2 of IC1.

No effort was expended in optimising the type of relay and IC3. The units used were readily available when the prototype was built.

## Operation

On connecting the snap-on clips to the battery, the unit instantly activates IC3 and RL1 for a duration slightly longer than three minutes, after which the unit is

ready for use. For calls of longer duration, the three minutes period can be extended indefinitely by operating switch SW1 located on the unit's front panel. At the end of the conversation, SW1 should be returned to its normal stand-by position.

The monostable period of three minutes can be shortened, if one so desires, by reducing the value of C6. In the prototype, the number of ringing cycles elapsing prior to the machine switching "on" can be changed from two cycles, when R4 equals 10 k, to five cycles when R4 equals 33 k.

## Components

R1	100 k, 0.5 W
R2	100 k, 0.5 W
R3	1 M, 0.25 W
R4	10 k, 0.25 W
R5	10 k, 0.25 W
R6	10 k, 0.25 W
R7	1M5, 0.25 W
R8	100 k, 0.25 W

R9	1 k, 0.25 W
C1	1.5 $\mu$ F polyester, 250 V
C2	1.5 $\mu$ F polyester, 250 V
C3	3.3 $\mu$ F tantalum, 35 V
C4	33 $\mu$ F, 16 V
C5	47 $\mu$ F tantalum, 16 V
C6	100 $\mu$ F tantalum, 10 V
C7	0.1 $\mu$ F ceramic, 50 V
C8	100 $\mu$ F tantalum, 16 V
D1 to D4	Bridge rectifier
D5	33 V Zener diode, 1 W
D6	GEX34 germanium diode
D7	5.1 V Zener, 1 W
D8	1N914 diode
IC1	Opto-isolator 6N138
IC2	Monostable MC14538B
IC3	Solid state relay by Arkansas
IC4	LM2931 regulator from 'RS' stock # 640-018
RL1	250 V AC relay by 'Omron'
Q1	BC639
Q2	BC147

ar

# TET-EMTRON

## Antenna Manufacturers

### New Tet-Emtron Vertical Range Features

- All Aluminium with Stainless steel hardware.
- No adjustment needed to main antenna.
- Light.
- Free standing-no guy wires.
- 1 kW PEP power rating.
- Can be ground mounted or elevated.

The new TET-Emtron Vertical range is designed with ease of use in mind. Tuning is done by the radials when the antenna is in its final position (where possible). The radials can either lay on the ground, be buried or hang from the elevated antenna. The antenna comes with a set of radials that has a resonate radial for each band. Further sets can be ordered from TET-Emtron if desired.

See the web site for more info and a complete dealer list.

Ph: 61 3 5145 6179

Fax: 61 3 5145 6821

ABN: 87404541761

[www.tet-emtron.com](http://www.tet-emtron.com)

Email: [rawmar@hotmail.net.au](mailto:rawmar@hotmail.net.au)

40 Blackburn Street, STRATFORD, VICTORIA 3862 AUSTRALIA

## New Tet-Emtron Vertical Range

TEV-4      TEV-3      TEV-3Warc

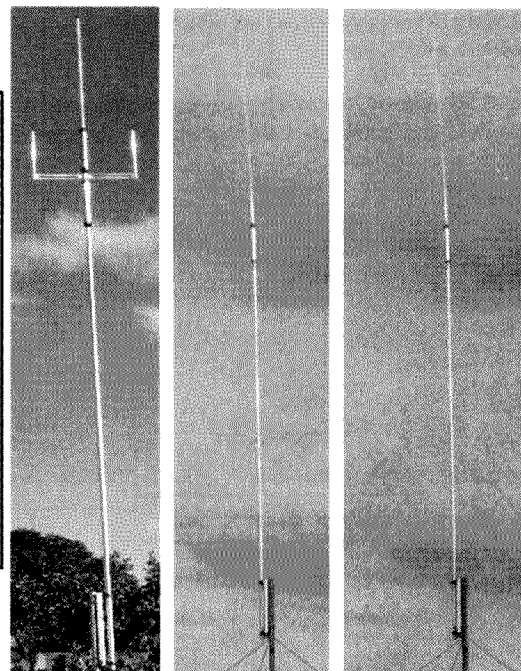

### Specifications

Antenna	TEV-4	TEV-3	TEV-3 Warc
FREQUENCY	7, 14, 21, 28 MHz	14, 21, 28 MHz	10, 18, 24 MHz
ELEMENT HEIGHT	4090 mm	3800 mm	5025 mm
FEED IMPEDANCE	50 OHM	50 OHM	50 OHM
MAX. RADIAL LENGTH	10.7 Metres	5 Metres	7.5 Metres
SWR	1.5 or less	1.5 or less	1.5 or less



# Radio skills needed for international disaster relief work



Have you ever thought that as an amateur radio enthusiast you may well have the type of skills that could be used in international disaster relief work? A major need in disaster situations, for example the earthquake in Pakistan or the tsunami in Asia, is to establish the relief operation bases as rapidly as possible in order to facilitate the humanitarian response, and radio communications are essential to this.

If you have the skills and practical experience to establish a stand alone HF network, or set up a VHF/UHF network using a duplex repeater, experience with setting up satellite phones, or microwave connections or data communications generally, or setting up a power supply with generator and batteries, coupled with an interest in using these skills in humanitarian work, RedR Australia is interested in hearing from you.

RedR Australia is a not-for-profit organisation, which provides a register of technical experts that various United Nations agencies can call on for short-term disaster relief work. It is mainly funded by AusAID, the Australian government's international aid agency, and this funding helps provide deployees with a salary whilst on assignment – the usual length of assignment being between three and six months. And you're not sent off to these international disasters without having attended the RedR Australia training courses which assist you in preparing

for aid work and the personal health and security issues of being deployed in a disaster relief setting.

It's not just telecommunications experts that RedR Australia needs; skills in information communication technology generally, civil or structural engineering, surveying, planning, water and sanitation, logistics and air operations are always in demand. To find out more about what RedR Australia does, and how you might apply to join its register, telephone Rhodri Wynn-Pope on (03) 9329 1357 or 0418 328 785, or the next time you're on the internet, check our website <http://www.redr.org/australia>.

RedR Australia is a humanitarian organisation whose mission is to relieve suffering in disasters by selecting, training and providing competent and effective relief personnel to humanitarian relief agencies worldwide.

21 Bedford St, North Melbourne Vic 3051  
Ph: (03) 9329 1357  
E: [rwp@redr.org.au](mailto:rwp@redr.org.au)

ar



Mark Tell, a RedR Australia register member, aligning a duplexer for a VHF repeater, Middle East

## OzGear

[www.OzGear.com.au](http://www.OzGear.com.au)

RadioCommunications & Electronics

Ozhelp Services Pty Ltd T/as Ozgear

Suppliers of radiocommunications, electronics and computer products and electronic test equipment

**Ph 07 3114 2506**

[sales@ozgear.com.au](mailto:sales@ozgear.com.au)

Brisbane QLD

Manager: Doug Hunter VK4ADC

**WE HAVE MOVED!**

**Unit 2**

**139 Beenleigh Rd  
Acacia Ridge 4110**

**Ozgear Yagi antennas  
for 6m, 2m and 70cm  
now available**

## ICOM & YAESU

**Australian-sourced radios with  
Australian-based manufacturer  
warranties**

Authorised Aust Icom and Yaesu dealer

Antenna, cable, interface, tuner and general accessory products from...

Amidon, Andrews USA, Austek, Benelec, Bushcomm, Comet, Dalwa, Diamond, Garland, GeoSensory, GME, Icom, Kingray, LDG, Lutron, Mobile One, RFI, Sangean SSGC, TET-Emtron, Tigertronics, Yaesu, ZCG Scalar plus ARRL and RSGB publications

## ALTRONICS

Many products stocked

**Product & pricing info?**

Phone, email or visit us on the web at

**[www.OzGear.com.au](http://www.OzGear.com.au)**

for the latest info plus on-line ordering. Our latest price list can be downloaded at any time

Payment?



# How to make contesting a little easier

Vince Henderson VK7VH

I have dabbled in contests for 30 years. I will never forget my first contest, the 1977 Remembrance Day Contest. I was still studying for my Novice licence. I thought that I would have a go at the SWL section. I felt sure that it would give me a few operating clues for when I eventually got my licence. I used a Realistic DX 160 receiver. My score was over the top. I managed to log over 1,400 contacts. I knew that I would need to re-write the log. You could imagine what it may have looked like, scribbling down contacts at the rate of three to four a minute.

I kept putting off the chore of re-writing the log. This was a mistake as, by the time I was close to finishing, the contest log submission date had passed. All that work and no chocolates! Never again would I miss a log deadline. I was hooked. It was the start of a love-hate relationship with the world of contesting.

Over the past few years, I have been developing the potential of the computer power in my shack. I have tried many different logging programs and contesting tools. After many attempts, I finally have a system that is easy to use and has rekindled my contesting spirit. I want to share some ideas with you that may make contesting a little easier and even more rewarding for those that like to just go for it. I only use phone or digital modes in any contest I enter. I do not like CW. If you do like CW, then that is a good thing.

One of the biggest hassles with any contest is putting the log submission together. Paper logs make things harder than they should be. Many people tend to use a paper log and then re-enter all the log information into some sort of computer based word processing or spreadsheet program. You are not on your own. I did this for many years. What a chore! There is a better way.

The lynch pin behind my set up is the ability to interface my computer with my radios. There are fancy programs available that have the ability to do some amazing things like remotely controlling an entire station. I have those sorts of programs and, whilst some are challenging to use, my contest set up is about as simple as I can make it.

Simplicity is the key to a good contest set up. The less there is to go wrong, the better. I have an all dancing PC that is fast and full of the latest type stuff. But, I do not use it with my radios. I do not need to. I use an old Pentium III PC with 256 Meg of RAM and about 600 MHz in

speed. You could survive on much less. While I will not try and convince you that the Windows XP operating system is the way to go, it is what I use and I like it. Everything that I do with my PC-to-radio set-up is based around it.

My contest set-up allows me to replay a pre-recorded voice file for contest

CQs and on-screen logging of contacts. I use a microphone and speaker headset with VOX. So, how do you put it all together?

A Pentium II at 266 MHz will run XP and it is the minimum you should use. The main point here is that you do not need a fancy PC. Having established

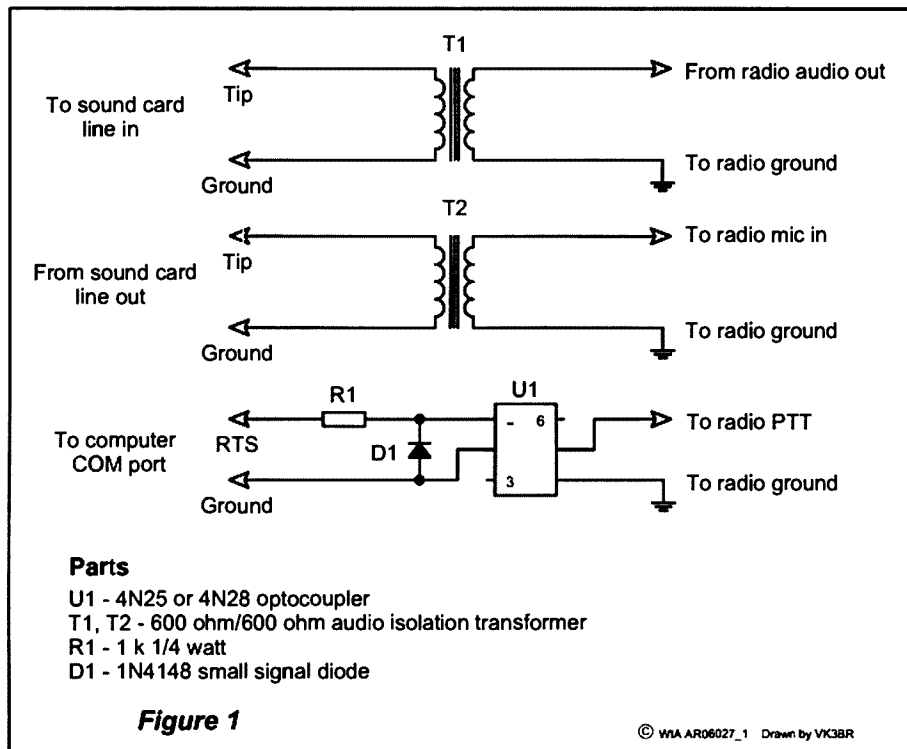

Fig 1 - A simple and effective interface.

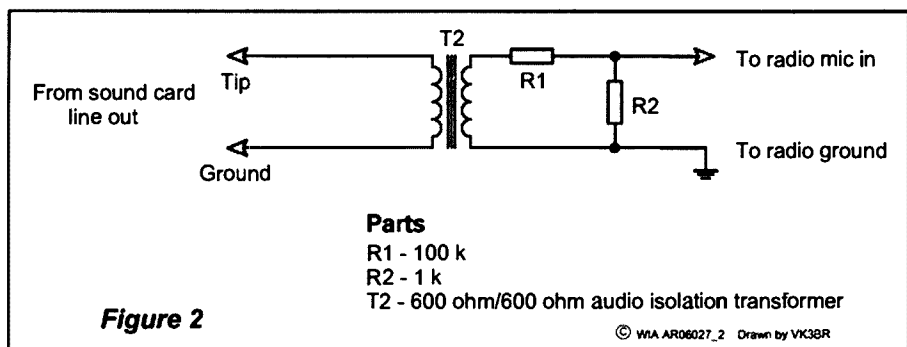

Fig 2 - A resistor attenuation pad.

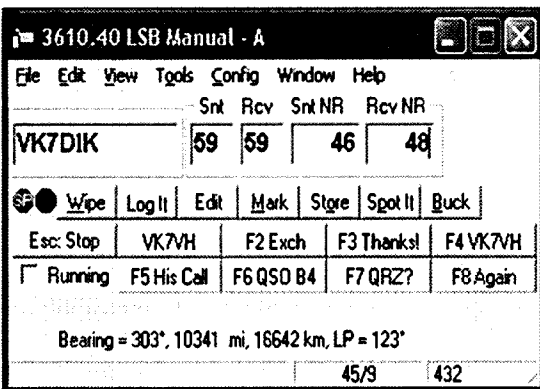

Fig 3 – The main program interface.

be the answer for everyone, I do think it is an easy solution.

The most basic interface is one that has a connection from the sound card output to the radio Tx input, using VOX as the PTT. This may work for some. My approach is similar, but not the same. The radio I use for contest work is a Kenwood TS-440s. It has an accessory socket on the rear panel that has a PTT switch, Tx audio in and Rx audio out. It also has a PTT mute that switches off

Trans Tasman, Harry Angel Sprint and the Jack Files Contest, just to name a few. You need to adapt an inbuilt contest such as the CQWPX. The program has the ability to output a complete log in text format. The log may be imported into a spreadsheet program for final tidying and scoring, prior to emailing it to the contest manager. Experiment a little and, when in doubt, read the help files.

The NIMM logger also allows you to import a voice wave file. You can play the file at the click of a button. The screen shot, Fig 3, is the main program interface. You only need to input the call sign of the station and the number you receive. You must remember to change the band on the program if you change your radio to another band. If you have CAT control in your radio, the program will interface to it well and even record your exact frequency and any band changes.

Another nice feature is the automatic dupe look-up. If you type in a call sign that you have already worked, the program will tell you. This can be overridden when you need to work stations again, such as in the Trans Tasman Contest. The program also has a separate on-screen log file. You are able to see at a glance who you have worked. Fig 4 shows a screen shot. The program has many great features, too many to describe here. Just download it and have a look - I am sure you will not be disappointed.

Using a pre-recorded voice file for CQs will save your voice. It allows you to call more often, especially during longer contests. To record a voice file, you need to connect a microphone to your soundcard microphone input. A computer desktop microphone will do the job. You could use Windows inbuilt Sound Recorder. A better alternative is to use a sound recorder/mixer program. I have a commercial program that allows me to shape the wave form. This produces the most suitable output for my radio. There is a good program available for the job. It is called Audacity. It is freeware and is available at [www.audacity.sourceforge.net/](http://www.audacity.sourceforge.net/).

If this article has sparked or renewed your interest in the world of contesting, then I encourage you to have a bash. The most important thing is to have fun experimenting. I also encourage you to support our local contests. Remember, it is vital that you send in your log, even if you only make a few contacts. Good luck and happy contesting.

ar

the front panel microphone input when the accessory PTT is switched on. These accessory connections are available on most modern-day radios.

I have an interface that is simple and effective. The circuit is shown in Fig 1. The circuit isolates the computer connections from the radio. The design eliminates one of the biggest interface problems, ground loops. This is achieved in the audio lines with the 600 ohm audio transformers. The opto-coupler isolates the PTT. It is housed in a small aluminium case. I use the computer sound card mixer to control the audio input and output. I also use a small program, called Quickmix, to remember the settings for a particular program application. Quickmix is a freeware program available at [www.msaxon.com/quickmix/QuickMixIn.EXE](http://www.msaxon.com/quickmix/QuickMixIn.EXE).

If the audio output from the soundcard is patched to the radio microphone input, the signal level will possibly need padding down. This is easily done by inserting a resistor attenuation pad. A ratio of 100 to 1 is a good starting point. Fig 2 shows one way to achieve this.

The contesting program that I use is the NIMM Contest Logger. All major contests are supported and the program will automatically output the log file in Cabrillo format for immediate emailing to the contest manager. It is freeware and the author, Tom Wagner, is constantly improving the program. The software is available at [www.pages.cthome.net/nlmm/](http://www.pages.cthome.net/nlmm/) along with a wealth of information and help files.

The program can be used with many of our local contests – the Remembrance Day Contest,

what you need, PC wise, the next step is to interface it with your radio(s). Again, simple is sweet. The connections you need are PC sound card output to radio Tx, radio Rx out to PC sound card input, and a method of using a PC com-port output to key the radio PTT. This set up will allow you to play around with lots of amateur radio software. A basic contest set-up does not need radio Rx out to PC sound card input.

One of the biggest stumbling blocks for many amateur operators is successfully connecting an interface between a radio and a PC. There is a wealth of information on the net. Some easy to understand and some so convoluted (and with dozens of interface components) it makes you wonder if it is all worth it. I can only suggest that it is. While my set-up may not

TS	Call	Freq	Sent	NR
22/04/2006 10:15:52	VK2KWM	3610.40:9	5	
22/04/2006 10:17:02	ZL1SWW	3610.40:10	8	
22/04/2006 10:17:44	VK7HAY	3610.40:11	2	
22/04/2006 10:18:56	VK2HMV	3610.40:12	3	
22/04/2006 10:19:52	VK2UGB	3610.40:13	5	
22/04/2006 10:20:41	VK3DY	3610.40:14	2	
22/04/2006 10:21:56	VK6LC	3610.40:15	2	
22/04/2006 10:22:55	VK2IAH	3610.40:16	16	
22/04/2006 10:25:22	VK5MAP	3610.40:17	8	
22/04/2006 10:27:32	VK5UE	3610.40:18	2	
22/04/2006 10:28:43	VK5BBB	3610.40:19	3	
22/04/2006 10:33:20	VK4CYA	3610.40:20	22	
22/04/2006 10:34:14	VK3FAWB	3610.40:21	19	
22/04/2006 10:35:07	VK5SR	3610.40:22	7	
22/04/2006 10:36:35	VK4YZ	3610.40:23	30	
22/04/2006 10:40:27	VK2HPN	3610.40:24	2	
22/04/2006 10:17:44	VK7HAY	3610.40:11	2	

Fig 4 – The program also has a separate on-screen log file.

# INTERNATIONAL LIGHTHOUSE & LIGHTSHIP WEEKEND

## Operation Grassy Hill lighthouse

J R (Rossco) Anderson VK4AQ

Generally derogatory, always humorous, mainly ribald, were the comments that flew thick and fast as an intrepid bunch of radio amateur enthusiasts formed up in convoy at a truck stop outside Mareeba, FNQ, prior to departure for the International Lighthouse and Lightship Weekend (ILLW) in Cooktown on a Friday morning recently. An essential ingredient in one's character for this weekend was obviously going to be the need for hide as thick as a rhino's to cop all the well-intentioned banter that was going to be the theme for the weekend!

An eight-vehicle convoy left Mareeba at 10 am bound for Cooktown via 'smoko' and lunch breaks at Rifle Creek and Lakeland Downs. Many Amateur Radio readers would not be aware that road sealing all the way through to Cooktown was completed in the last twelve months and we were all looking forward to an easy, relaxing trip. Inter-vehicle communication was established on 146.5 MHz thus ensuring a continuation of the light-hearted banter combined with a running commentary of local history, geography and aboriginal legend by Alan VK4HBN and Stan VK4MFA, both of whom spent many, many years as timber and plant equipment men in the district. It was sometimes hard to concentrate on driving with tears of laughter often being the order of the day. Our erstwhile band of merry-makers comprised seven

hams, four XYLs and one OM along for the ride.

The speed limit on the new road is 110 kph, but most of the area is unfenced so a particularly good eye had to be kept out for roadside cattle. Kangaroos are prevalent but, provided driving is done during daylight hours, 'roos are not too much of a problem. Tourist traffic, of course, was fairly high with many caravans from the southern states trying to beat the winter months.

So began the culmination of many months of preparation by team leader Mike VK4MIK, well known amateur 2 m proponent, and his jovial off-sider Dennis VK4JDJ.

As is the logistical nature of going onto a historical

site such as the Cooktown Lighthouse on Grassy Hill, approvals had to be sought from the various local and state government instrumentalities beforehand. Mike VK4MIK had put all approvals from the Council and police in place in good time and we had been briefed well in advance of our responsibilities. Mike had



Photo 1 - Our "quaint" roof barely kept the sun out of the very hard working operator's eyes.



Photo 2 - The historic Cooktown lighthouse

## INTERNATIONAL LIGHTHOUSE & LIGHTSHIP WEEKEND

also arranged with the local newspaper to run articles about the event beforehand and had organised media coverage for the actual day, which culminated in a fine article. The Cook Shire Council was most helpful in seeing our excursion was a success. Resident ex-hams Pat and Dave Edmonds were ever helpful and went out of their way to see we had everything we needed.

Following an evening of fun and frivolity over a great dinner at the Cooktown RSL Club on the Friday evening (Long Tan Day) it was an early morning start on Saturday getting our station up and running. The first chore was to get the centre mast in the air. Using some ingenious anchoring devices, previously welded up by Dennis VK4JDJ, we soon had it secured in position, the Australian National Flag prominent at the masthead. Guys and halyards in place, Wayne VK4ARW's inverted L dipole was very quickly up and away. After a couple of teething problems with SWR his 20 m beam was also up and performing.

Then Murphy decided to join the party.

The tent frame was very quickly fitted together - many hands making light work of that - when it was discovered that a person, who shall remain nameless,



Photo 3 - The view we had to endure for the weekend



Photo 4 - The "wash up".

but a portly gentleman nonetheless, had forgotten to include the tent cover. After much ribaldry about by which parts of his anatomy we should hoist him up the newly installed mast halyard, a mad dash to round up a few blue tarps soon had a practical, but rather "quaint", roof over our heads. Murphy was not finished with us, unfortunately, as he paid another visit by way of a suspect N type connector, during some VHF/UHF trials we were trying to conduct back into the Cairns repeater.

The main rig, a Yaesu FT-897, was then set up, powered by a monster array of batteries gratefully borrowed from Ray VK4TFT in Mareeba. This power source coped quite well without recharge for the entire operation. For our secondary station, used for data transmission, Bill VK4WL utilised an ICOM IC-703 and laptop computer, and generated quite a lot of interest from passing tourists.

Unfortunately, activity on this mode was limited and some cross modulation was experienced from the main rig.

The all important brew station followed. A myriad of easy chairs, snacks and savouries, and a couple of the quintessential Eskys, rounded the site out admirably. By then the start time deadline had been reached and it was down to the serious business of making QSOs.

Thus ILLW station VK4GHL (Grassy Hill Lighthouse) AUS083, came into being for the second year running. The station operated mainly using phone but a number of contacts were made on CW. Our efforts on digital were unsuccessful but a big improvement for next year is expected given the experience gained this time around. Manning was almost continuous, although a small break was taken during the small hours of Sunday morning when the bands became quiet.

Statistics from the station over the past

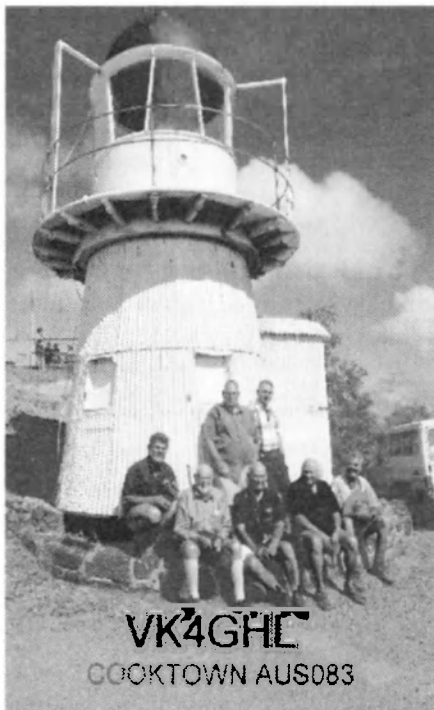

Photo 5 - The QSL card.

# INTERNATIONAL LIGHTHOUSE & LIGHTSHIP WEEKEND

two years are as follows:

	2005	2006
VK2	6	12
VK3	2	0
VK4	4	5
VK5	1	1
VK6	1	0
VK7	0	2
VK8	0	1
VK	15	36 not lights
JA	3	2 (1 light)
NZ	0	2 (1 Light)
UA	1	1
T88	0	1 (Palau)
USA	0	1
Total	33	64

Making our good tally of contacts were Mike VK4MIK, Alan VK4HBN, Wayne VK4ARW, Dennis VK4JDJ, Stan VK4MFA, Bill VK4WL and CW operator Rossco VK4AQ.

The wind experienced on Grassy Hill during the period can only be described as intense. It probably averaged about 15 - 20 knots for the most part, with gusts to 50 knots on occasion. Unfortunately, we were perched on the face of a rather steep bank and, on a couple of occasions, the more fleet of foot had to scarp down this embankment in pursuit of seats, documents or other odds and sods that were dislodged because of the wind.

Regrettably, all good things had to come to an end and, by lunchtime on Sunday, the site had been broken down, gear safely packed for the long trip home, and 'emu

parades' of the area conducted.

During a wash-up over 'smoko', we kicked around ideas where improvements could be made and these were noted for next year. All agreed that from a technical point of view, the weekend had been quite successful. Socially, the camaraderie and fellowship was second to none, despite having to have a hide about four inches thick at times. It was indeed good to get away from the pristine environment and refinements of the home "shack" for a while and to see how things really do operate under less-than-ideal conditions.

Only one thing remained to be decided in open forum and that was where to next year? The answer? Grassy Hill Lighthouse, Cooktown, of course.

## Mackay at the Pine Islet Lighthouse

**2006 Lighthouse weekend 19th and 20th August at Pine Islet Lighthouse (AUS127) now located at the Mackay Marina complex.**

We started to setup at 09:00 on Saturday for the 10:00 AM start, and by about 10:15 we had our first set of radio equipment setup and were making contacts.

We were using the Kenwood TS-830S of mine (VK4AKV) with the Kenwood AT-230 tuner of George's (VK4AJL) and the 3 wire Bushcom antenna of Roy's (VK4HRO).

Shane (VK4KHZ), loaned us a Yaesu FT-ONE HF Amateur radio, an FL-2100Z Linear amplifier and a Multiband vertical antenna for the weekend.

We also had an ICOM IC-208H 2m VHF/UHF radio for local contact and to broadcast the WIA news on Sunday morning, and a quantity of handhelds because we can!

During the time spent at the lighthouse we made about 88 contacts using the club callsign of VK4WIM. These contacts were mostly to Australia and New Zealand but we managed to get to Russia, the Caribbean islands and the US of A.

We had 36 lighthouse contacts and of these there were 24 different lighthouses

As we were about to start

packing up we made our last contact to K6AA located at lighthouse USA621 Point Fermin, San Pedro our only international lighthouse contact!

### Mackay Amateur radio association members at the event:

VK4AKV Kevin, VK4AJL George, VK4NRA Gus, VK4KHZ Shane, VK4FTDX Thomas, VK4FMKY Neil, VK4FSPM Chris, VK4HRO Roy, VK4HOG Tony, VK4NPF Bruce, VK4JWG John and VK4AAU Bob

### List of lighthouses contacted

Some on more than 1 band, some more than once during the 2 days

If you want a copy of the log please let me know and I can email it to you

AUS024	AUS149
AUS027	AUS154
AUS033	AUS158
AUS045	AUS166
AUS071	AUS170
AUS083	AUS175
AUS085	AUS218
AUS103	AUS226
AUS110	AUS281
AUS113	NZL016
AUS119	NZL033
AUS142	USA621



# Westlakes ARC at Norah Head

Frank Lusa VK2FJL

The International Lighthouse/Lightship Weekend is over for another year. Westlakes ARC activated Norah Head as VK2ATZ portable, while throughout the commonwealth approximately 30 other amateur stations activated lighthouses in a bid to attract public awareness and promote the preservation of these structures that served the maritime community for many years. They are in danger of being left to decay, now that technology in the form of satellite navigation have taken over their purpose.

Westlakes has only been actively involved in this weekend for the past three years. Mike Dalrymple GM4SUC,

who sadly passed away last December, first introduced the event seven years ago. During the previous two years, thanks to the generosity of the Norah Head Search and Rescue Base, Westlakes ARC operated with success from that site. This year, thanks go to The Central Coast Tourism who were in part instrumental in gaining permission from The Norah Head Lighthouse Trust to operate Club Station VK2ATZ from within the Lighthouse grounds, giving our claim as operating from Norah Head Light real legitimacy. (In the past, we could only claim to be in the vicinity).

Central Coast Tourism's CEO Horst

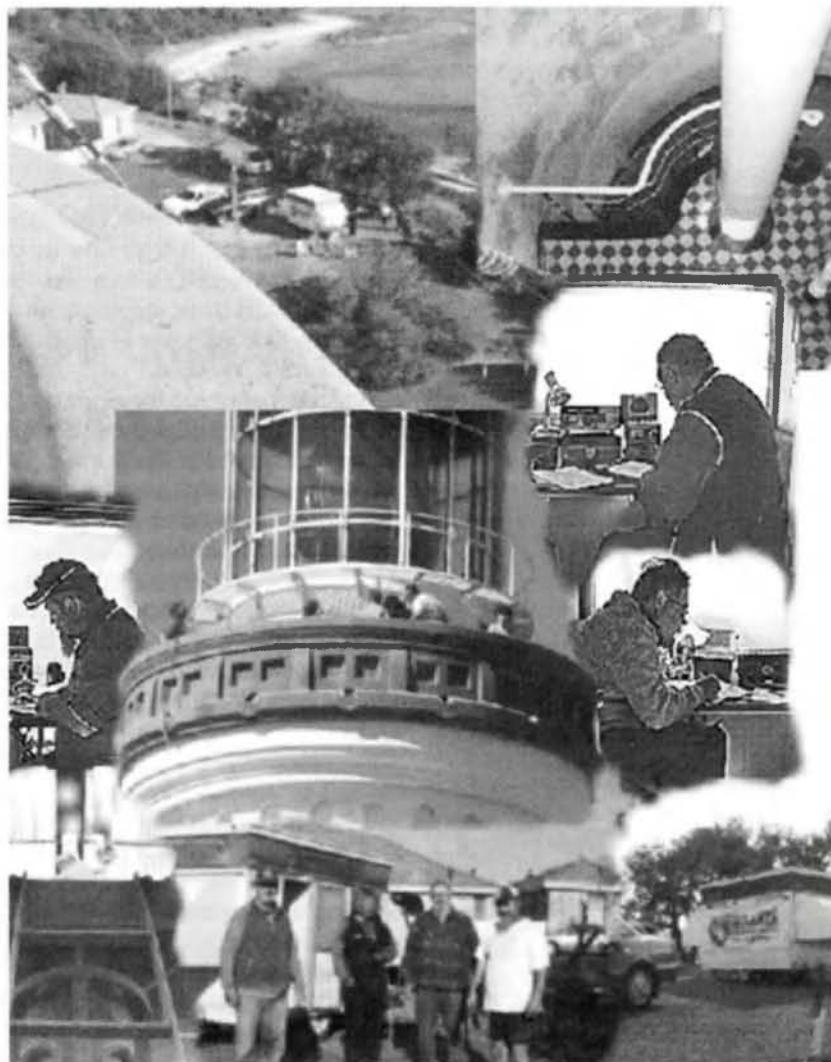

## Australian made **ANTENNAS** Setting a new standard **COM-AN-TENA**

(formerly a j and j coman)

115 John Street  
GLENROY 3046

23 cm 36 ele slot fed yagi beam	\$222
2 ele delta loop 10/11 metre	\$255
40-80 metre Vertical	NEW \$330
10/11 beams comp opt 5 ele	\$351
10/11 5/8 vert 4 rad 1/4 wave	\$195
Tri band HB 35 C 10/15/20 m	\$745
3 ele 20 m comp opt	\$460
log periodic 9 ele 13 30 8.4 boom	\$1050
NEW 160 m vertical (SUBURBAN)	\$355
40 m linear loaded 2 ele beam	\$595
M B Vert auto switch 10/80 m	\$330
6 m 7 ele yagi beam 60 mm boom	\$387
6 m 5 ele comptr opt beam	\$275
Top loaded 160 m vert	\$430
10 ele high gain 2 m 3.9 m boom	\$149
17 ele high gain 70 cm 3m boom	\$139
Rotable dipole 40 m	\$250
80 m top loaded vertical	\$273
dual band 2 m & 70 vert	\$164

### Guyed Masts

**21 metres**      **13 metres**  
Winch-up & tilt-over. Aluminium and stainless steel  
three-sided construction. Auto-brake winches.

### Free Standing Masts

9.5 metres

**New Baluns**  
1-1 to 16-1 to 3kW



Our Masts meet Australian Standards. We supply all the computations and data you will need for a permit.

**03 9773 3271**  
**Mob: 0419 542 437**

# INTERNATIONAL LIGHTHOUSE & LIGHTSHIP WEEKEND

Endrulat, realising the Public relations potential in having Amateur Radio promoting both Lighthouses and our hobby, arranged the distribution of flyers throughout the Central Coast as well as interviews on the local radio stations and newsgroups. The culmination was an NBN Television news crew arriving on site during the event.

Pete VK2YPW volunteered the use of his pop-top van as a mobile station; this unit had served us well in our two previous ventures. While very Spartan in design, it served its purpose, allowing a modicum of comfort to those who manned the station.

The club had its own transceiver, power supply and antenna. Other club members assisted by loaning various pieces of equipment, thankfully including a back up power supply, which was called upon within a few hours of operation as the club's unit failed. Jim Smith, the lighthouse tour guide, assisted in installing the antenna, which we managed to hang from just below the lantern itself, some 26 metres above ground sloping down to a convenient light pole at around 6 metres. The antenna, the "Cobra Ultralight" described in a previous

issue of the club magazine, tuned in extremely well on all workable bands. The set up was ready for the big event by late Friday, thanks to the assistance of Paul VK2BPL, Keith VK2PKT, Allan VK2JED, Warren VK2UWP and Russ VK2KEG. Allan and Warren volunteered to stay overnight and carried out some on air test transmissions. Saturday dawned bright and clear leading into a perfect weekend weatherwise. Some concern was felt in the early morning, when the local corellas and galahs decided to test the wire out by hanging off it in droves (thankfully it survived).

Operations began in earnest at 10 am, with several members arriving to assist in operating VK2ATZ portable. Our very first contact was a lighthouse from Tasmania's Cape Bruny working as VK7OTC on 40 metres gave us a 5x5 while he came in at 5x6.

Looking back through the log, the signal strengths seem to be generally of that order over the weekend with a few bending the needle. The initial contact being a lighthouse gave us hope for a truly historic weekend. Due to depressed bands, while over 160 contacts were made, only 19 lights were confirmed with

an additional 4 not listed, all bar one being within Australia, the odd one out was a New Zealand lighthouse at Manukau South Head. The only other contacts overseas were two from the States and one from Vanuatu.

The lighthouse tours attracted an ongoing stream of visitors; several took the time to visit our setup and were suitably impressed by the quality of the contacts and appeared truly interested in our description of the virtues of Amateur Radio. The club's youngest members Jessica VK2FJES and Walter VK2FAZ arrived Sunday and were only too pleased to pick up the microphone and could be heard drumming up several contacts. Westlakes impressed the crowd, not only with their radio expertise but by a mono cycle demonstration by John VK2FJKG. The culinary exploits of Allan VK2JED successfully keeping those game enough to partake in the offerings well fed. Alec our resident BBQ chef had better look to his laurels in future.

Contacts almost dried up by Sunday midday. Bearing in mind that many of our operators had a distance to travel home, we broke camp and spent a couple of hours packing the various pieces of gear away, dismantling the antenna and making the van ready for towing, ensuring that the site was left as tidy as when we arrived. Overall, a very successful exercise, with both members and the public playing their part in making for a very pleasant weekend.

I would like to thank those who assisted, not only over the weekend, but also during the preceding weeks. These events do not just happen; many hours of planning and co-ordination by dedicated members are required. Members that Westlakes Amateur Radio Club is indeed fortunate to have in abundance. Members like Allan VK2JED, who arrived Friday afternoon and stayed over for the whole weekend and in my opinion was the backbone of the event.

I'd also like to thank The Norah Head Lighthouse Trust, particularly Jim Smith and caretaker Todd for their assistance and tolerance, The Central Coast Tourism's Horst Endrulat and Joy Groves for their part in making the public aware of the event.

Let us hope we can do it all again next year.

## PERSONALISED QSL CARDS

**Operator's name**

**Westlakes Amateur Radio Club Inc.**

# VK2ATZ

PO Box 8001  
Teralba NSW 2284  
Australia

ITU Zone 59  
CQ Zone 80

**Confirming Contact with...**

	Date	Time	Freq	Mode	R.S.T	

**Rig:**  **Antenna:**

**Pre-QSL via Bureau**

Personalised QSL cards bearing your callsign, Club's name and supplied logo. White gloss card, full colour with WIA logo watermark if a WIA member. Alternative microphone if not. 25 cents per card. Orders in batches of 4, Minimum order 40 cards. plus postage. Email: flusa@optusnet.com.au with details

This Is a Westlakes Amateur Radio Club Project



# ORARC Inc. 2006 Lighthouse Weekend Operation at Tacking Point

**Bill Brooke VK2ZCW**

Members gathered at 0830 local to load up equipment from the Clubroom before proceeding to Tacking Point lighthouse site. Getting the tent up was a challenge and created lots of fun, due to winds of up to 30 knots, which blew throughout the

operating period. Visiting the site during the day were Charlie Vella VK3TCV and Des Thompson from Lord Howe Island. Des has since joined ORARC, sat and passed his Foundation Licence assessment and awaits his Call. In spite

of the windy conditions, all enjoyed a great day. A total of 82 contacts was made including 22 lighthouses round Australia and New Zealand.

*Contacts were 40 m = 64, 20 m = 10, 2 m = 6, 70 cm = 2.*



Jim Neil VK2VIV, Alan Nutt VK2GD and Neil Sandford VK2EI in the operation nerve centre.



Des Thompson, Bruce Walker VK2HOT, Arthur Monck VK2ATM with the Tacking Point Lighthouse in the background.

# East Gippsland Amateur Radio Group goes to Point Hicks

**Linda Stanford VK3VLS**

Continuing from previous years, the East Gippsland Amateur Radio Group travelled to Point Hicks Lighthouse on Friday 18th August to participate in the annual International Lighthouse/Lightship Weekend. This is becoming somewhat of a tradition for the group now, as this is the fourth year that the group has travelled to Point Hicks to participate. Enthusiasm for this event is strong, ensuring plenty of future participation.

Point Hicks Lighthouse is on the southern coast of Australia, in the East Gippsland part of coastal Victoria. It was here that the first sighting of Australia was made during Captain Cook's voyage to the great south lands in 1770. It was named Point Hicks in honor of Lieutenant Zachary Hicks who first saw it. The area

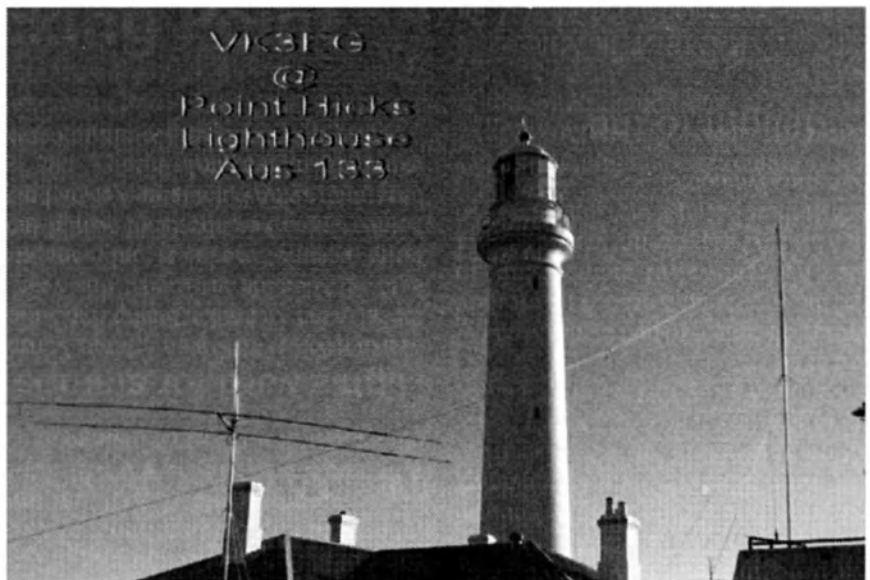

# INTERNATIONAL LIGHTHOUSE & LIGHTSHIP WEEKEND

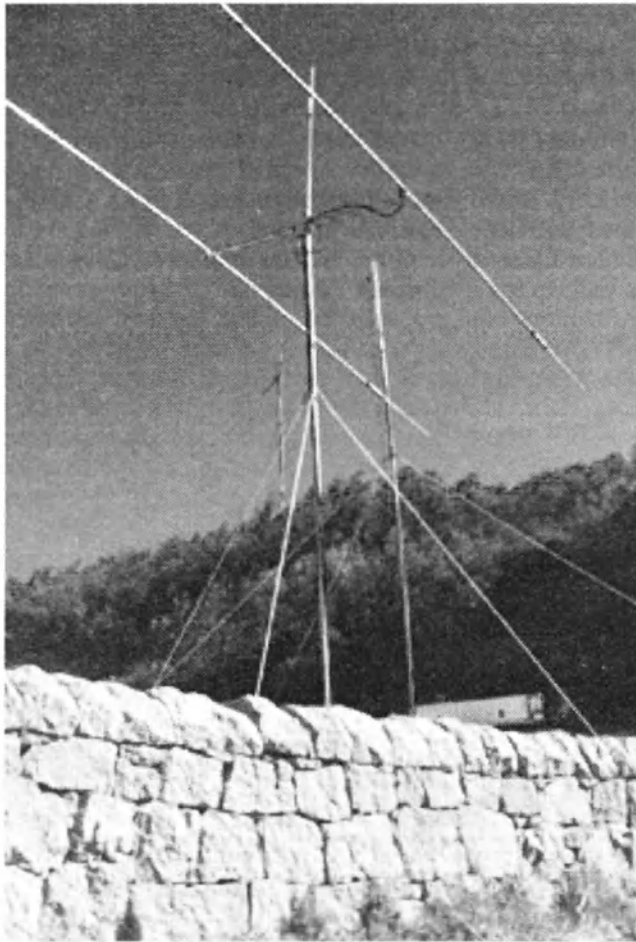

This shows the antenna's set up the Inverted Vee's set up in the background



Rhett VK3VHF operating under the group call sign of VK3EG at Point Hicks



Up it goes! Rhett VK3VHF and Mark VK3MOA preparing to erect a 2 element Triband Yagi 10 m 15 m and 20 m

became known as Cape Everard, and the original name of Point Hicks was restored in 1970 for the Bi-centenary of Captain Cook's voyage.

The lighthouse was built in 1887-1888, together with its accompanying wooden lighthouse keepers' houses and the surrounding sturdy granite walls. It was built of cast concrete, an innovation at a time when most lighthouses were built of stone, and at 38 metres (130 feet) is believed to be the tallest concrete lighthouse ever built in Australia.

Arriving Friday gave the group members plenty of time to set up an 80 and 40-metre Inverted Vee Antenna. A 2-element Tri-band Yagi Antenna for 10 m 15 m and 20 m was set up as a second station.

The group HF radio was set up in the cottage, as well as a 2 m FM radio was set

up to keep in contact with late comers, as some got away from Bairnsdale at around 2 pm and some had to work till 5 pm. A few calls were put out to test the waters and all was in readiness for an active weekend. The group members selected beds and rooms for the night (or decided which was the most sheltered place for the swag) and retired for a well-earned rest.

No one reported any sightings of the resident ghost but everyone was eager to see a whale, as has happened on previous occasions.

Saturday began in fine style with contacts flowing thick and fast. The VK3EG group made over 130 contacts, which included 32 lighthouse stations.

The rest came from people wanting to contact a lighthouse and find out information about it. Countries contacted included Australia, New Zealand, USA,

England, France, Austria, Russia, Germany, Greece, Italy, Switzerland and Norway. The group had contacts with Lighthouses in all states of Australia.

Rob VK3EK had taken on the task of catering for the group. However, old habits die hard, and he just had to grab that mike for a few chats and contacts. After the wonderful meals prepared by Rob and eagerly consumed by the rest, it was amazing that anyone was awake enough to speak to anyone in the rest of the world.

Saturday continued late into the night as conditions changed and paths opened up or died away. Eventually Point Hicks closed down for the night and all members retired.

Sunday found everyone up and eager to continue making contacts, fuelled

# INTERNATIONAL LIGHTHOUSE & LIGHTSHIP WEEKEND

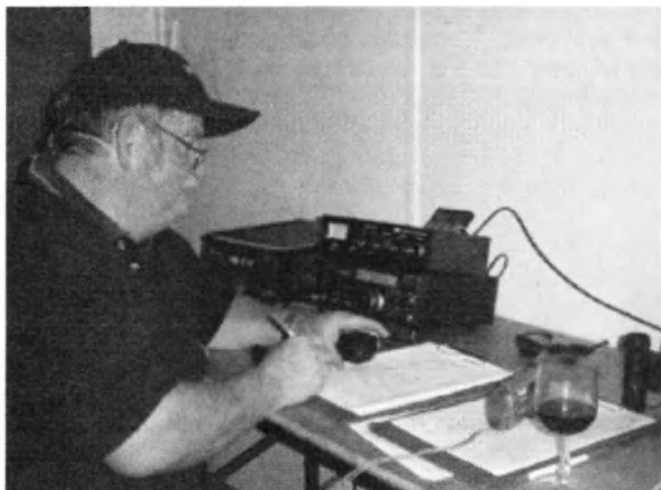

Rob VK3EK taking a break away from the kitchen to add a few more entries to the log



Mark VK3MOA making contact with other lighthouses.

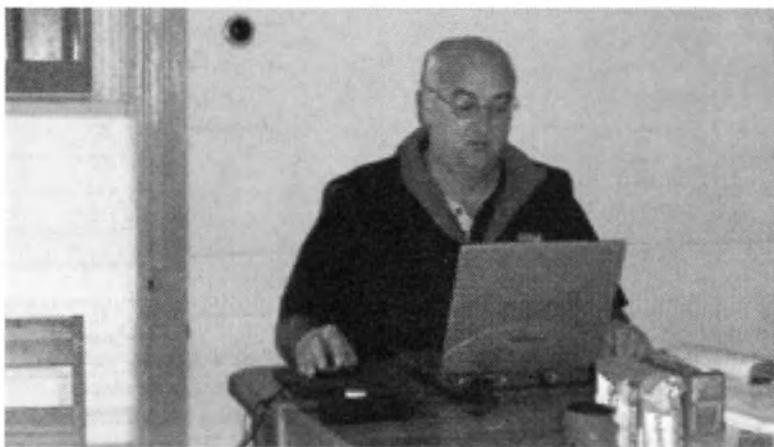

Col VK3BLE updating details of contacts



This was the second station on 10 m 15 m and 20 m  
L/R Rhett VK3VHF and Rob VK3EK

by lots of breakfast. In spare moments, binoculars were used frequently to scan the horizons in search of whales and other interesting sights. No whales were spotted but much time was spent watching the antics of the resident seal group who are to be found floating in the sea just off the point, mostly holding one flipper aloft and often surfing the waves. Ships were also observed and members spent some quality "me" time walking, reading and snoozing. There was time for everything!

In conclusion, it was a great weekend: great contacts, great companionship and great food.

We're all looking forward to next year.



Mark VK3MOA Col VK3BLE  
Rhett VK3VHF Marnie VK3MFB  
Linda VK3VLS Rob VK3EK

# ILLW 2006 and VK3WI

By Jim Linton VK3PC

Amateur Radio Victoria activated the Williamstown Lighthouse and Timeball Tower (AUS-170) for the second year in a row; however, this year it saw Foundation Licensees readily responding to an invitation to join the fun.

Coordinating the event was Terry Murphy VK3UP and while he was blessed with good weather, an operational challenge was radar-type QRM, suspected to be coming from the adjacent Naval dockyards.

The picturesque Point Gellibrand is at the head of Hobson's Bay in Melbourne's inner west. Williamstown played an important historical role having Victoria's first permanent settlement and becoming a trading port.

The current lighthouse began in 1852 replacing earlier navigation aids. The timeball (a large copper sphere) would fall at 1.00 pm and ship's captains would set their chronometers by it.

On arrival on the Saturday morning to set up for the VK3WI station, Terry VK3UP noted the serenity of the area.

After unpacking the station equipment, antennas and supplies, he ambled over to the nearby foreshore to gaze out into the harbour and reflect on the original role of the lighthouse to help mariners.

Then a quick coffee and a snack, it was back to the business of getting the station on air. Terry said, "I noticed on the mobile transceiver a lot of noise emanating from the vicinity of the Naval dockyards which is less than 200 metres away.

"There were all sorts of noises. I knew radar-type hash was going to be a problem on receive but that just makes it all the more interesting and challenging," said Terry.

"Unpacking the 80 metre dipole, I grabbed the extension ladder from the roof-rack and put it up against the flagpole before zip-tying the feed point of the dipole at about 10 metres up."

Then the operating table was set up immediately outside of the lighthouse door, power was connected and the Kenwood TS-440S turned on.

Immediately noticed was a solid strength nine noise level. "OK, first thing was to see what I could do about it.



Moving one leg of the Inverted Vee made the noise louder in one direction and quiet in another," he said.

"This further proved my theory that the noise was indeed coming from the dockyards. Placing the dipole end on to the dockyards there was at least a 3 dB drop in the noise level."

Another well-earned cup of coffee was consumed while a show-board of colourful QSL cards and a brief explanation of the International Lighthouse and Lightship Weekend were put up.

The activation began at 1109 hours local time. Putting out a call resulted in contact with Bob Battistuzzi VK2JUB at Evans Head Lighthouse (AUS-175).

Next was home station Tony Middleditch VK3CAT who popped up for a chat, followed by operator Norman at the Bayside District Amateur Radio Society VK4BAR activation at Cleveland Point (AUS-130).

Moving down to the 40 m band, Tim Hunt VK3IM jokingly put in a claim for a new needle for his S-meter as a result

of the 60 dB over S9 signal coming from VK3WI. Tim, who lives in Footscray, not far away, opted to bring his Morse paddle to the site and give CW a try.

Michele Grant VK3FEAT who made contact from the other side of Melbourne was very interested in the ILLW activity. She offered to assist on the Sunday. Another Foundation licensee, John Sargeant VK3FJAS, also volunteered to operate the station on both days.

On day one, the team managed to work a dozen lighthouses in VK2, VK3, VK4, VK7 and NZ as well as the special events call VI2MI on Montague Island (AUS110), plus several home based or mobile radio amateurs. It was unfortunate that Tim VK3IM could not get any takers on CW.

Around dusk on the Saturday the station closed, but was back on air the next morning.

"I was met with an even louder noise level on 40 metres. Time to try something different with the antenna," said Terry.

After surveying the tower, entering it

## INTERNATIONAL LIGHTHOUSE & LIGHTSHIP WEEKEND

## KVK Antenna Systems

Best value books in VK.

The VK Antenna Handbook for Restricted Spaces

Best value antennas in VK.

The NuBeam

The Vertical-LR-dipole multiband vertical

As seen at Wyong

Check out the latest revision to the web site - more info, more antennas, more value.

For direct purchases

[www.grimshaw.net.au](http://www.grimshaw.net.au)

For credit card purchases:

[www.kvkantennas.com.au](http://www.kvkantennas.com.au)

or ph 07-3216 8060 or

fx 07-3216 8075

under the permit issued by Parks Victoria by its Williamstown ranger Edena Critch, who was extremely helpful, he climbed the internal ladders to the fourth level at about 15m above ground.

This became the new anchor point for the antenna and while Terry secured a leg of it to a fence post, Michele VK3FEAT ambled across from the foreshore car park.

"I'm planning to only stay for a couple of hours," she told Terry. "My immediate task was to answer questions from a few locals wondering what we were doing."

Passers-by had a look over the station and were impressed by the quality of the contacts, particularly from ZL land, and they learned something about amateur radio.

Soon after receiving operating instructions, Michele was down to business operating on HF, with the first contact being John operator of VK7OTC (Radio and Electronics Association of Southern Tasmania) at Bruny Island Lighthouse (AUS-024). After a spell on HF, it was QSY to the F-Troop Net on the Mt Macedon 2-metre repeater VK3RMM to invite others to attend.

When more curious members of the public stopped by to ask what was happening, it was time to demonstrate IRLP with both Terry and Michele making contact with Peggy KC7GZT and

Brian KA7KUZ in Tacoma Washington, USA.

Terry was well prepared with a BBQ and while Michele operated, he cooked lunch and made a cuppa. Shortly after John VK3FJAS and Brendan Trott VK3OY joined the team.

The operation was in full swing with sharing of the mike and logging duties. The 40-metre band worked fine before switching to 80 metres after 1800 hours local. As it was getting a bit chilly, the team sought shelter inside the Lighthouse where the operating continued until about 2010 hours.

Reluctantly all stopped for the day, with Michele clocking up nearly 11 hours. "Personal highlights were operating a field station and my first maritime mobile station near Perth," she said.

"The experience has certainly whetted my appetite for portable operation which I'm very keen to pursue.

"I would certainly recommend Foundation Licensees join in on activities like this whenever they have the opportunity. Not only will you enjoy yourself, it will boost your confidence and you'll also learn a lot."

Michele is typical of many among the new breed of radio amateur eager to explore what the hobby has to offer, which augers well for the future of amateur radio.



[www.pca.cc](http://www.pca.cc)  
Email from anywhere  
via Winlink  
2000  
Use FACTOR-3  
on HF to send  
Mail, Grib Weather,  
Weatherfax & Images  
Contact [marc@pca.cc](mailto:marc@pca.cc)  
Sydney 02 8902 0107

Got something to say  
about amateur radio?

**Share it!**

Tell Amateur Radio's editor. We  
always welcome suitable material.

## Cover story

# Radio Clubs combine for Lighthouse Weekend at Cape Jaffa Lighthouse

Tony Hutchison VK5ZAI

Members from the Riverland Radio Club combined with members from South East Radio Group to take part in the International Lighthouse & Lightship weekend on the 19th and 20th August. The meeting place was the Cape Jaffa Lighthouse, AUS-033 located on the foreshore at Kingston SE in South Aust.

The Clubs applied some months ago to ACMA for the special call of V15CJ for the event.

In order to get a 9:30 am start on Saturday, Tony VK5ZAI, with the help of XYL Jill, decided to setup the antennas the day before. This was a relatively simple matter as the lighthouse has two

halyards hanging from the top, which are normally used to hang flags. An open wire centre fed dipole was raised on one side of the lighthouse and matched to the FL-2100Z linear amp with a tuner, and an inverted V fed with RG-213 was raised on the other side.



David VK5HDW



Main setup



Andy VK5LA



Mai VK5MJ

## History of the Cape Jaffa Lighthouse

Mal VK5MJ and AndyVK5LA experimented with end fed long wire antennas, Mal using his Codan portable rig.

The Lighthouse itself has six triangular shaped rooms on two levels within its structure, which were used to house the two keepers and their families during its working life on the reef.

Three separate stations were set-up in two rooms and tried to work simultaneously. However, this became a challenge with the FL-2100Z linear amp the Mt. Gambier boys brought proving too much for Andy VK5LA, who was trying to run QRP in the adjoining room. Eventually the team reached a compromise. Despite poor propagation and noisy powerlines, everyone enjoyed the weekend. Bands worked were 80, 40, 20, and 2 m.

Numerous lighthouses in Australia and New Zealand were contacted along with some good QSOs made with stations further afield. Those helping to make the weekend a success were VK5DJ, VK5WCC, VK5GA, VK5LA, VK5MJ, VK5EE, VK5DK, VK5DG, VK5ZAI, VK5HDW, and VK5KJ/4UH who flew down from Brisbane to attend.

The weekend attracted numerous visitors who were shown through and escorted up to the light room at the top.

Those wanting to QSL can go through the Bureau or direct to VK5ZAI. Tom VK5EE organised the printing of the Special VISCJ QSL cards.

This is the second time the Cape Jaffa Lighthouse has taken part in the event and the Radio Clubs involved would like to thank the Kingston National Trust for making the Lighthouse available to them for the weekend.

Originally built in the 1870s on the Margaret Brock Reef, seven kilometres off the coast, the Cape Jaffa Lighthouse, AUS-033 stood for one hundred years protecting ships from the treacherous seas that had seen the demise of many ships in the area.

The original multi-wick oil burner was replaced in 1909 by a pressurised kerosene light. This light was turned off and decommissioned in 1973 and is believed to have been the last of its type to operate in Australia.

The National Trust of South Australia (Kingston Branch) successfully lobbied for the lighthouse to be dismantled and re-erected at Kingston where it could be preserved as a museum to show what life was like on the platform.

Dismantling of the lighthouse on the reef began in February 1974 and it was rebuilt on the foreshore at Kingston SE, the work being

completed in December 1976. That year, the Lighthouse was officially handed over to the National Trust of South Australia (Kingston Branch), who now operate it as a museum. It is open to the public during most school holidays and weekends.

The original platform the lighthouse was erected on still stands today on the Margaret Brock reef and is now the nesting place for a large colony of gannets. Fishermen also use the landmark to negotiate their way through the channels in the reef.

Those wishing to learn more of the history can find it on the web at :-

<http://www.lighthouse.net.au/Lights/SA/Cape%20Jaffa/Cape%20Jaffa.htm>



At its present home in Kingston



Cape Jaffa Lighthouse in 1974



The old platform has not gone to waste!

## The Contest

This year's ALARA Contest was one of the best ever. Great conditions, lots of competitors, a number of Foundation licensees with good scores, and there were many OMs taking part as well. A most satisfactory state of affairs!

It was very good to hear Norah VK5NYD and her OM David VK5AYD on the air again after quite a number of years. Their QTH in Coober Pedy had more advantages than just the electronically quiet location. Their antenna is mounted on a pole immediately above their operating room – 40 feet above! With an underground house the feedline goes up the air vent. What is more they can never have complaints about the noise from their neighbours. The neighbour's house is far enough away that no noise can be heard at all.

We are also pleased that by the Monday after the Contest, Norah had already posted her renewal of membership. In fact, ALARA has probably gained several new members because the Contest was so successful. Welcome!

## A sidelight to the Contest

At the ALARAMEET in Mildura, a plaque was presented to Pat VK3OZ for winning the Florence McKenzie Trophy four times. This trophy is awarded for CW contacts in the ALARA Contest because Florence McKenzie taught thousands of men and women to be able to send and receive CW during WW2, so, of course, it has a Morse key mounted on it.

This year, in the ALARA Contest Pat used this Morse key. We understand it was her OM Peter VK3VB, now an SK, who suggested Pat use that key in the Contest. Both Pat and Peter have been CW operators all their radio lives and usually have four keys (not always the same ones) in circuit so it was not too difficult to connect up a new one, but we are very pleased indeed that Pat did so.

We hope there were at least one or two other YL CW operators to keep Pat company, though most of the contacts will probably have been with her regular 'buddies'.

## Gwen VK3DYL is the only 3 band DXCC YL

How well do you read your Amateur Radio? Did you see that, in the latest list of DXCC, Gwen VK3DYL is the only YL in the 3-band DXCC part of the list?

ALARA members all send congratulations, proud to be able to brag about the things our friends achieve.

Gwen has organised several DXpeditions to interesting Pacific Islands. Perhaps people seeking to gain particular countries for their DXCC chase, also gave Gwen some of her unusual countries.

Gwen has become a member of a very exclusive group with DXCC on three different bands. Maybe she will inspire others to try for the same high goal.

## High award for stamps

Marilyn VK3DMS won a large Vermiel medal in the Australian Stamp Exposition, held in Adelaide in August this year. A large Vermiel medal is only one step below Gold. Yes, the Gold would have been nice again but a large Vermiel is an extremely high award.

Marilyn's theme is Communication,

as you would expect and the pages make very interesting reading as they tell the story of the way man has communicated across distances, through the years. Radio is only one method used but all methods have been recognised in stamps.

In today's amateur radio climate, with the number of young people joining our ranks, one particular picture was captured by the camera: The young lass talking into a microphone should touch a chord with most of us.

## It does pay to go to these hamfests!

From Dot VK2DB

*OM John VK2ZOI and I wanted to attend the Blue Mountains Winterfest, Saturday 19th August so I decided to ask, and was invited to take the "ALARA table".*

*We arrived in plenty of time on a glorious sunny day to set up and meet the members of BMARC. As soon as the ALARA table was set up, John left to check out the trash and treasure tables.*

*Only a few ladies came to the table to talk to me, but some stopped at the hall door, peered at the laden tables then turned and left. One of those who did*

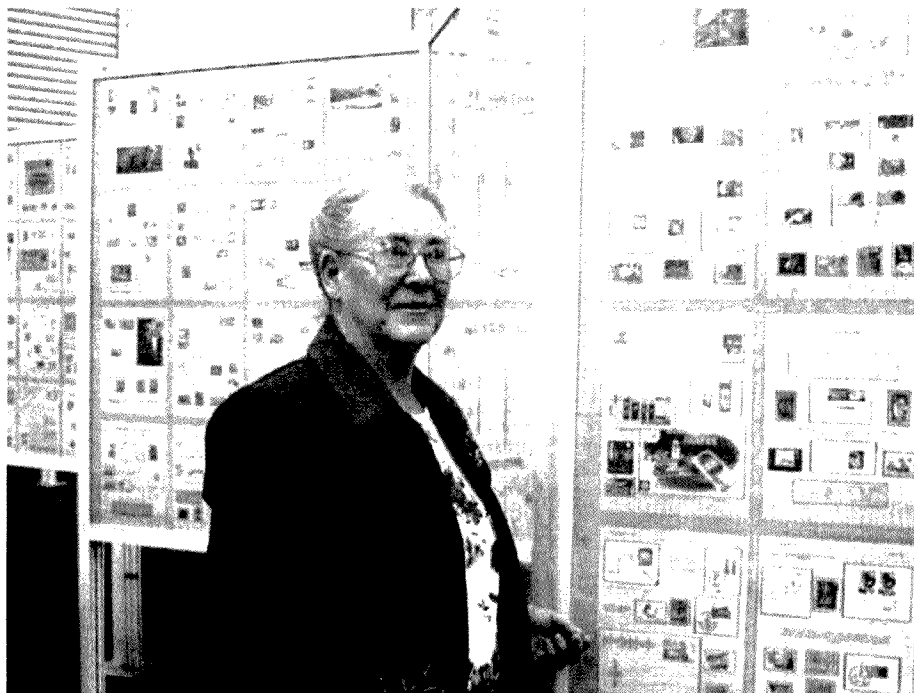

Marilyn VK3DMS beside her stamp display



## EDUCATION



1989 - Amateur journal and display. School of the Air.

Yellowish has transferred the scope of education much further.



The Red Hats

## Visiting Sydney recently

Maria VK5BMT, whom you heard about a while ago when she and OM Keith VK5MT managed to speak to their daughter from the top of the only hill around, as they trekked across the wilds of Northern Australia, has now been to see the new baby. No doubt, she will have many photos to show at the next VK5 luncheon.

She also had time to spend a night with Dot VK2DB (just in time to help fold and count 1,500 newsletters for the Hornsby Radio Club!) and to see a little of the area where Dot lives. Lots of talk and lots of good "me" time, for them both.

With the membership of ALARA scattered from one end of Australia to the other, any face-to-face time is valued.

## ALARA was represented at the funeral of Chris VK2ZDD

Dot and John VK2ZOI made the 100 km trip across Sydney to attend Chris' funeral, as did so many others. Dot wore her ALARA nametag and State Rep badge to represent us and to add our sign of appreciation for all the work Chris (and the rest of the WIA executive) has done on behalf of the amateurs of Australia.

## ALARA luncheons

In VK5, we have the occasional Red Hat day. A photo illustrates what this means! It means we are being a bit silly and having fun. The VK6 YLs who have a regular luncheon on the last Thursday of each month might like to copy the idea. If you were in Mildura, you have read the poem about reaching the age of red hats. Have Fun!

The picture of the young operator - one of the pages in Marilyn's display

stop was Betty VK2MSB from Dapto, near Wollongong. She hasn't 'done' a lot of radio yet, but her amateur son is overseas and they hope have a contact soon. I showed her the ALARAMEET photos and talked about sponsorship. I was never without company with the talk mainly being about the Foundation Licence or aerials / antennas.

Some people examining the photo album were surprised by the number of ladies in the ZL 2000 International Meet. Of the photos, the men enjoyed the photo of Mildura ALARAMEET 'men's group' and the photos of the group taste testing glasses of enjoyment on one of our fact finding trips. Many people took leaflets about ALARA and the Contest rules.

Everyone received a lucky door ticket and I put our two away very safely. Later in the day, John came rushing in saying they'd just drawn our ticket and if I didn't find it soon they would re-draw it. Yes!

John and I won the prize and you can see what a fantastic prize it was. I did not even look at the prize when I bought the tickets so was flabbergasted and so excited.

The photo shows BMARC Secretary Daniel VK2DC presenting it to me, VK2DB. Straight after the photo was taken, I was still bubbling with excitement and managed to knock John's half-litre mug of coffee over the ALARA table, the floor, everything in my bag, etc. Cleaning up my mess brought me back to earth. Must admit, John and I had a wonderful evening unpacking the basket and admiring all the goodies, and yes we did start on them.

## An interesting table at the same hamfest

Herman VK2IXV staffed this table for the Royal Naval Amateur Radio Society (RNARS). The Morse keys were interesting, the information about skeds may be of more immediate interest.

Skeds are held every Saturday afternoon from the warship Vampire, which is stationed permanently at the Maritime Museum in Sydney.

There is a CW sked from 13.30 to 14.00 EST on 7020 kHz (40 metres).

And a voice sked from 14.00 to 15.00 EST on 7090 kHz.

Whether you served in the Naval forces or not, it could be interesting to make contact with the station. I am sure they would welcome everyone.



ar

# Awards update

Malcolm K. Johnson VK6LC

WIA Awards Manager

PO Box 196 Cannington. 6987 WA

email: awards@wia.org.au website: <http://www.wia.org.au/awards/>

Australia Post advises that the current IRC will expire 31 December 2006. The new IRC was published on page 52 of the August 2006 issue of AR Magazine. Current IRC coupons held may be returned to a Postal Outlet for exchange for a new IRC prior to 31 December 2006 only.

The new IRC expires on 31 December 2009 and the purchase price is Aus\$2.60.

National Awards postage from the 1st September 2006 has risen again, for example, we have now lost all "economy mail" for overseas postage, and we now

front the cost of "Airmail charges". Cost to Europe increased from Aus\$8.00 to Aus\$9.75. The award fees will be deemed to rise September 2007, for this period they will stay as indicated on the Awards Website.

Updating old Federal Awards is continuing slowly: we are currently looking at new graphic designs to replace the WAVKCA-HF, Grid Square, Antarctic, VHF-CC Awards. A new award that is not far away is the long over due "Satellite Award"; all of these are subject to funding, always a consideration. For this

period, the National Awards are managing and we thank many members and some sponsors who have assisted.

Conditions being down have slowed the awards tally also, just as it did last sunspot minima. Many claims are now being received by this office for the two new DXCC entities Montenegro and Swain's Island. Our next DXCC update for AR Magazine and our website will be November 2006, so try to place your updates by the first week in October 2006.

ar

*"Hey, Old  
Timer..."*



If you  
have been  
licensed for  
more than 25 years  
you are invited to  
join the

## Radio Amateurs Old Timers Club Australia

or if you have been licensed for less than 25 but more than ten years, you are invited to become an Associate Member of the RAOTC.

In either case a \$5.00 joining fee plus \$8.00 for one year or \$15.00 for two years gets you two interesting OTN Journals a year plus good fellowship.

Write to  
RAOTC,  
PO Box 107  
Mentone VIC 3194  
or call Arthur VK3VQ on 03 9598 4262 or  
Bill VK3BR on 03 9584 9512,  
or email to [raotc@raotc.org.au](mailto:raotc@raotc.org.au)  
for an application form.

## RAOTC 30th Anniversary QSO party

- Date:** Saturday, 21 October 2006.  
**Open** to all Amateur Radio operators  
**Bands:** 160, 80, 40, 20, 15, 10, 6 and 2 m and 70 cm  
**Category:** Single Operator  
**Modes:** CW, SSB, FM  
**Times:** 0600 – 0800 UTC (1600 – 1800 EST)  
**Calling:** "CQ OT"  
**Scoring:** A valid QSO requires exchange of call sign and name for all operators, plus member number for RAOTC members.  
10 points per QSO with non-RAOTC members  
20 points per QSO with any RAOTC member.  
50 points per QSO with either VK6OTN or VK3OTN.  
Stations may be worked on more than one band, each contact scoring one point.
- Award:** A Certificate will be available to any operator who scores a total of 250 points or more. Endorsements will be given for operators who score 200 points or more on both Phone and CW separately.
- Send Logs to:** Secretary,  
RAOTC,  
PO Box 107,  
Mentone, 3194;
- or via email to:** [vk3js@bigpond.com](mailto:vk3js@bigpond.com)

by 31st October to claim a certificate.

## Contest Calendar October – December 2006

Oct	7	PSK31 Rumble	(PSK)
	7/8	Oceania DX Contest	(SSB)
	14/15	Oceania DX Contest	(CW)
	9	10-10 International Day Sprint	(All Modes)
	15/15	JARTS WW RTTY Contest	(RTTY)
	15	Asia-Pacific Sprint Contest	(CW)
	15	RSGB 21/28 MHz Contest	(CW)
	21	RAOTC QSO Party	(CW/SSB/FM)
	21/22	JOTA/JOTI	(all modes)
Nov	28/29	CQ WW DX Contest	(SSB)
	11/12	Japan Intl. DX Contest	(SSB)
	11/12	Worked All Europe DX Contest	(RTTY)
	11/12	Spring Field Day	(VHF+)
	25/26	CQ WW DX Contest	(CW)
Dec.	26	Ross Hull Memorial VHF Contest	(VHF+)

(to mid-Jan 06)

## Results CQ RTTY WPX 2006

(VKs only CallCat.\Score)

VK6GOM	SOAB High Power	124,509
VK3FM	SOAB High Power	10,325
VK2KM	SO 40 metres	193,052

## Do you know this man?

Every organisation has its “notable characters” and Australian contesters are no exception. There are some operators in our midst who have done well – really well – over the years. Here is a snapshot of one of them.

John Nieuwenhuizen VK5NJ is a resident of Mt. Gambier in southeastern South Australia. He is a frequent user of the bands and can often be heard taking part in Australian contests. John uses both CW and phone modes, and when he is on he has an excellent signal.

John has won the President’s Cup associated with the John Moyle Field Day on three or four occasions in recent years. He is a strong supporter of the local radio club.

Attached is a photo of John and his wife Tanina. John works in the court system in South Australia, principally as a Sheriff and no doubt in other capacities as well. He said that he had seen some amazing people

pass through the courts – some deservedly so and others unfortunately so.

John is one of the success stories of VK contesting. Are you? Do you know someone similar? Could you persuade them to let their successes be known in this magazine? If so, Ian Godsil VK3JS would be very happy to hear from you ([vk3js@bigpond.com](mailto:vk3js@bigpond.com)).



*Ed: As mentioned in the last edition of AR, Ian is stepping down from his AR Contesting role. Thanks Ian for your valuable input over the years. Ian's replacement is Phil Smeaton VK2BAA. Phil can be contacted via [vk2baa@wia.com.au](mailto:vk2baa@wia.com.au), so why not drop Phil a line and make some suggestions for column content - after all, it's your column!*

ar

## Silent key

### Russell Meyers VK3PCN

Russell Meyers VK3PCN, who died in April this year, was licensed over twenty years ago. His main interest in later years was in 10 metres and the 10-10 net.

He amassed a good collection of QSL cards, mainly from South Africa.

He leaves a wife, Marj, a son, Danny, and two grandchildren

# Spotlight on SWLing

Robin L. Harwood VK7RH  
vk7rh@wia.org.au

## DRM delivers some surprises

I recently was able to listen to DRM via an online receiver in Sweden. I was pleasantly surprised at both the quality and the number of available stations. There were few dropouts and the audio quality seems superior to that of the conventional AM mode. These signals were within Europe and likely a single hop and I believe that these dropouts increase with extra hops. This is why DRM does have its limitations on long haul propagation.

Radio Luxembourg is one station that primarily uses the 49-metre band with several different program feeds. For example, there is a German service on 6095 at 1100 and another one lower down but from a totally different sender in Britain.

The BBC World Service had excellent audio on 7320 and on 9410 and Radio Netherlands had a program feed on 7210. Deutsche Welle also had an excellent feed on 13640. I got a list of current stations using DRM from Google.

The only broadcaster in this region employing DRM is Radio New Zealand International and ironically it was on 6195 at the same time as Radio Luxembourg (1100Z), but there were no collisions as I was using a European remote receiver. I do also note that RNZI often alternates between DRM and the conventional AM mode on some channels.

DRM receivers are still not in sufficient commercial quantities. I expect that Europe will be the main target for the marketing of receivers, as that is where most of the DRM activities originate.

Radio HCJB in Ecuador has had a partnership program with several radio ministry groups in Russia and other CIS nations. Program feeds were uplinked by Russian satellite from Moscow to over 200 stations throughout the former Soviet Union. However, at the end of July, these organisations had to scramble as the satellite was taken over by the Russian government. Unfortunately, most studios had their dishes fixed to this satellite and it would take quite some time to find a replacement satellite. Also, broadband is not a viable option as this is mainly

confined to St. Petersburg and Moscow, yet an Alaskan relay station was able to get a broadband connection. This station serves the far eastern tip of Siberia. Alaska was a Russian colony until 1867 and is of course the 49th State of the USA.

If satellites are prone to takeover by commercial and/or political forces, DRM is therefore a suitable economic alternative for audio feeds. RNZI are doing this now to feed Pacific Island stations. However, to work satisfactorily, both senders and receivers should be within a single hop.

Deutsche Welle in Bonn recently announced that VT Merlin would be responsible to transmit DW programming on shortwave. This comes as no surprise, as Deutsche Telekom (DT) sold their shortwave senders in Julich and Werchental to Christian Voice out of Maroochydore QLD! Therefore, in 2007

DW will be coming from VT Merlin transmitters throughout the World but not from Germany itself. Rather ironic. VT will probably take over management of the DW Relays in Kigali, Rwanda and Sri Lanka.

Do not forget that the major frequency changeover for shortwave stations occurs on October 29 from 0100. This coincides with the Northern Hemisphere reverting to Standard time. This year also should be the last time that Tasmania will be out of step with those mainland states with DST, as I believe they may be extending daylight saving as from Spring 2007.

Note that NZ has DST from October 8th.

Well that is all for this month. Good monitoring and 73 – Robin L. Harwood VK7RH vk7rh@wia.org.au

ar

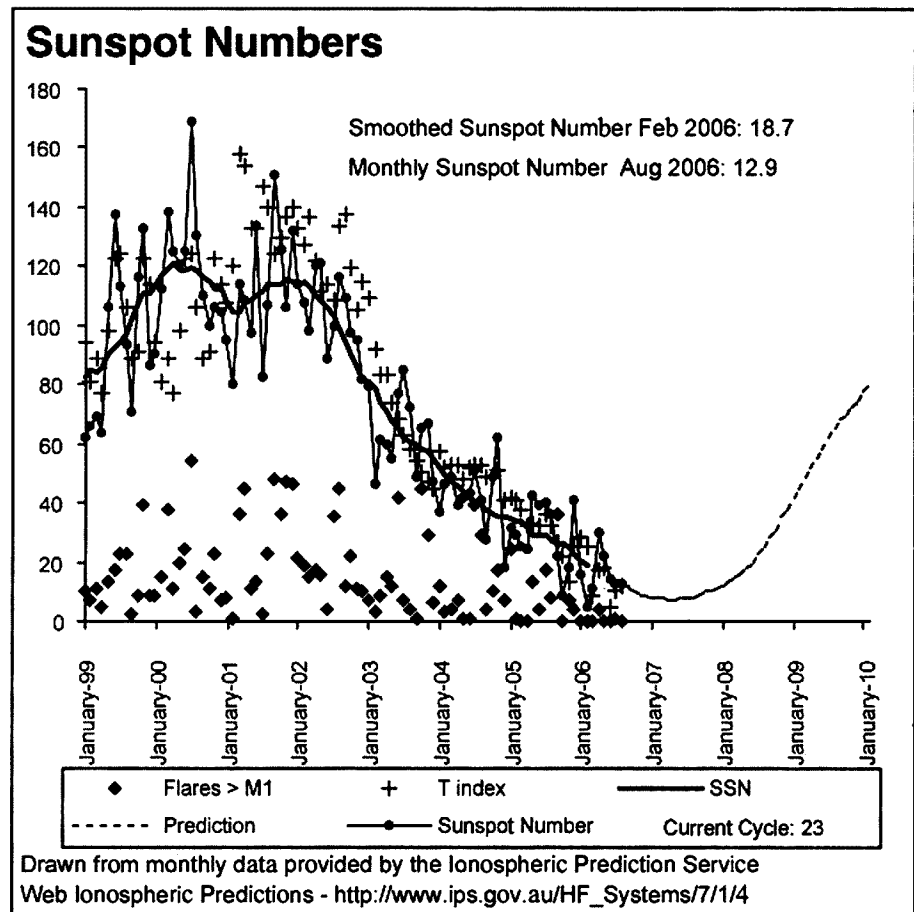

## Weak Signal

David Smith - VK3HZ

Spring has finally arrived and the weather has shown a marked improvement in this neck of the woods. It's time to dust everything off, check that all is working OK, fix those minor (or major) things that you've been putting off due to the cold weather and generally prepare for the busy summer DX period.

## Spring VHF-UHF Field Day

One of the main season-opening events is the Spring VHF-UHF Field Day, this year to be held on the weekend of November 11th and 12th. Full details were published in last month's magazine. The event is open to both portable and home stations. For those going portable, please advertise your plans on the VK-ZL logger ([www.vklogger.com](http://www.vklogger.com)) and the VK-VHF email reflector (<https://mail.une.edu.au/lists/cgi-bin/listinfo/vk-vhf>) to encourage others to either go portable or be active from their home station to provide some contacts. Let's have some record levels of activity this year, and use those precious VHF/UHF and microwave frequency allocations that we are privileged to have access to.

## Tropo opening in the Southeast

On August 28th, a slow-moving high-pressure cell was again responsible for a period of good propagation across the southeast corner of the country between VK3, 5 and 7.

That evening, Peter VK5ZLX was a big signal on 2 m into central Gippsland, easily working Rhett VK3VHF and Jim VK3II (S9). Brian VK5UBC also worked VK3II, although signals were nowhere near as strong. The following morning (August 29th) on 2 m, VK3HZ worked VK5ZLX (5/3), VK5UBC (5/1), Garry VK5ZK (5/2).

That evening, the Geelong 2 m and 70 cm beacons were being heard by both VK5UBC and VK5ZLX. Brian VK5UBC reports: "I worked Dion VK7YBI (950

km) on 146.5 FM and then a little later, I called on the Mt William 2 m repeater and Paul VK7BBW came back. We QSY'ed to 144.1 SSB and completed a contact (994 km) with Paul's signal peaking to 5/3 here. Following this contact Peter VK5ZLX worked Paul at 5/9. Paul then worked several VK3s, including VK3II". Later, Bill VK5ACY on Kangaroo Island worked Charlie VK3NX in Lara on 2 m and reported hearing the Geelong 2 m beacon at S4.

The following morning (August 30th), the opening appeared to have moved to particularly favour the Adelaide to Melbourne path. The Mt Lofty beacons on 2m and 70cm were both around S3 in Melbourne. Garry VK5ZK in Goolwa worked Kevin VK3WN and Ian VK3AXH in Ballarat (both 5/9+), David VK3HZ in Melbourne (5/9++) and Jim VK3II near Phillip Island (5/7). VK3HZ then worked VK5UBC on 2 m (5/9) and 70 cm (5/1) and Les VK5JL in Adelaide (5/2).

## Beacons

As part of the spring clean in readiness for the summer period, it would be good to have an up-to-date list of active beacons around the country. One such list is provided on the VK-ZL Propagation Logger ([www.vklogger.com](http://www.vklogger.com) and click on Beacons at the bottom). However, the list is only as good as the information it contains. If you click on the "Report" heading, the list will be sorted into date order with the oldest reception reports at the bottom. Some of these reports are over 18 months old (e.g. Dural 23 cm beacon). Could people have a listen for beacons in their local area and, if necessary, provide an updated reception report, even if there is no change in the beacon status. That way, we can be more certain that the status information is correct.

Don VK6HK reports that both the Esperance and Albany 2 m beacons are off-air at the moment. Hopefully they will be restored to operation shortly, as they provide a very valuable service to

the eastern states, indicating the state of the path across the Bight. The 70 cm beacon at Albany (Mt Barker) is fully operational and, in fact, often provides a much stronger signal to the east than the co-located 2 m beacon.

## EME

Further to last month's report, Charlie VK3NX has managed to break the world distance record for 5.7 GHz EME. On August 28th, he worked Philippe F2TU - a distance of 16421.8 km.

The wind was blowing a gale and bouncing Charlie's dish around causing much QSB, and at the critical moment when "73" was expected, Murphy appeared and a fuse blew in Charlie's rig. So, although Philippe was happy that he'd received everything, there was some small doubt in Charlie's mind. So, the following day, the wind had disappeared and Charlie again worked Philippe, sending a 539 report and receiving 529. Congratulations Charlie.

Charlie reports that he has had several 5.7 GHz EME QSO's since then, working RW1AW (St Petersburg, Russia), W5LUA (Texas) and OE9ERC (Austria).

## VK-ZL on 2.4 GHz

During summer, the ZL to VK2/4 path opens up fairly regularly with contacts on 2 m, 70 cm and even 23 cm becoming relatively common. However, the path has not been worked on any higher bands. Recently there has been a push for stations well positioned at each end to become operational on 2.4 GHz in a common frequency band. One small problem has been that the VK and ZL band plans allocate different frequency segments for weak signal operation for the 2.4 GHz band - 2403 MHz for VK and 2424 MHz for ZL. However, many of the ZL stations are able to work in either segment.

Steve ZL1TPH is pushing for more stations to become active:

*Over the last two years, there have been a number of unsuccessful attempts to VK from ZL on 2.4GHz, between Brian*

ZL1AVZ, Nick ZL1IU and myself to Ross VK2DVZ and Adrian VK2FZ. At the time signals were weak on 1296.

There is interest here in ZL in working VK on 2.4 GHz, brought about no doubt by the first contacts on 432 to VK by ZL1TAB many years ago, and at a later

date with Brian ZL1AVZ to VK on 1296. Twenty years separated these two firsts.

Steve goes on to say that there are at least seven ZL stations that have good coastal sites with elevation and are active on all bands, 144, 432, 1296 and 2.4 GHz – Brian ZL1AVZ, Ralph ZL1TBG, Ian

ZL1AOX, Ted ZL2IP, Nick ZL1IU, Steve ZL1TPH and Ray ZL2TAL.

Let's hope that the VK/ZL path can be conquered on 2.4 GHz this season, and on to higher frequencies.

Please send any Weak Signal reports to David VK3HZ at vk3hz@wia.org.au.

## Digital DX Modes

### Rex Moncur – VK7MO

Sam, RN6BN, with his massive 1920-element array, is capable of working very small stations on 2 meters EME using JT65B and worked LZ1BB who was using only 40 watts and a 4 element Yagi. This result indicates that EME is now within reach of very small 2 meter stations with a few tens of watts and a small Yagi or even a medium gain omni-directional vertical. Sam can switch polarization to accommodate Faraday rotation and Spatial polarization changes and work stations with either vertical or horizontal polarization.

Rhett, VK3VHF, reports on his EME results with 100 watts and a single seven-element Yagi. "I only received Sam, RN6BN, at -20 dB last night, I've heard him in the past down to -12 dB. But pretty cool report from him at -17 dB." Rhett has worked, W5UN, RA3AQ, RU1AA, RN6BN and EA6VQ. He says "So certainly you can have some fun with EME using a small station like mine. Just takes time, as I've spent hours trying. There are plenty of 'Big Gun' stations which I haven't worked yet, so my little station still provides me with plenty of interest."

Alan, VK4EME, using 80 watts and a single 10 element Yagi on 144 MHz, completed his first EME contact with HB9Q.

Jim, VK3II, reports making JT65B EME contacts on 2 meters with a single 14 element Yagi fixed on the horizon with HB9Q, DL8GP and DF2ZC. He also copied S51ZO, OE6IWG, YU7AA and JS3CTQ. Jim says "I hope I can get a good 2 metre array together that can be tilted up so I can get a bit serious about EME work."

Ian, VK3AXH, has made significant progress with 2 meters EME, since completing a four bay 18 element array and reports as follows: "My 1st EME contact was with W5UN on 21 August 2004 using a single 12el Yagi and no

elevation. A further 14 contacts were made using the single Yagi until use of the new array began on 3 April 2006. The array is by DJ9BV and optimized by Lionel VE7BQH with all 18 elements of each Yagi insulated from the boom. Only horizontal polarization is employed.

Total contacts to the end of August 2006 on 144 are as follows:-

	JT65B	CW	SSB
Grid Squares	84	2	1
Total Contacts	112	2	2
DXCC	24	2	1

Included in the above there are 2 CW and 2 SSB QSO's. Both SSB contacts were with RN6BN using his famous 1920 element array with Vertical and Horizontal Polarization. The initial SSB contact was tried after receiving signal levels of -6dB at both ends using JT65B on Saturday 26th August. Sam called me and I received him at 5x1 and he received me 4x4. We had 3x1 minute overs each. Sam's log show this as the longest distance of 13,918 km in his list of 162 SSB contacts. On Sunday 27th August at around 0640 UTC, Sam began calling CQ using JT65B alternating between Vertical and Horizontal Polarity. He was 8dB stronger on Vertical Pol to me. When I saw a level of -6dB I called him on SSB and was surprised to hear him come back with a 5x1 report. I gave him 4x1. Its great fun and I look forward to many more EME contacts in the future on 2 metres and eventually some of the higher bands."

Jim VK3II has been experimenting with QRP JT65 over a 518 km troposcatter path to Rex VK7MO. Signals are consistent at 5 watts and contacts can be completed more than 50% of the time at 2 watts. Comparison tests were made with SSB at 300 watts where copy is marginal indicating that there is around 20 dB performance improvement with JT65B. Des VK3CY, using JT65B, has

been consistently working Rex VK7MO, at 780 km with 50 watts and around 50% of the time can get through on 25 watts.

On 6 September, Trevor VK4AFL and Rex VK7MO achieved their goal of a 5 watt QRP EME QSO on 1296 MHz. Trevor uses a 3.7 metre dish and Rex a 2.3 metre dish. This follows earlier success at 10 watts with the new version of WSJT, version 5.9.5. The further improvement from 10 watts down to 5 watts seems to be largely a result of good moon conditions with the degradation close to the best possible, but an additional factor could be a new "Super VE4MA feed" with a circular waveguide and Septum Polariser that Rex was using. This design of feed was recently announced by W1GHZ ([www.w1ghz.org/antbook/conf/VE4MA\\_Chaparral\\_septum\\_feeds.pdf](http://www.w1ghz.org/antbook/conf/VE4MA_Chaparral_septum_feeds.pdf)) as a result of theoretical analysis and should give around 0.5 dB improvement over the standard VE4MA feed. The use of a Septum polariser also makes it far simpler to tune. Following the success at 5 watts, tests were conducted at 3 watts and while a QSO was not completed, several syncs were achieved both ways with one correct decode in the average.

**Operating Hint:** Sometimes when operating JT65 on 2 meters a meteor ping with just the right frequency offset for a shorthand RO, RRR or 73 will cause the program to incorrectly decode the shorthand message. The problem is readily identified by watching the waterfall display, but it still overrides the correct message. There is an option under the Decode menu to set JT65 so that it does not decode shorthand messages when you are using line one and by using this option you will often be able to decode the correct message in the presence of meteors.

Please send any Digital DX Modes reports to Rex VK7MO at rmoncur@bigpond.net.au.

# The Magic Band – 6 m DX

Brian Cleland – VK5UBC

August has been a very quiet month on 6m. There have been very few reports of band openings from anywhere in Australia. Only openings I'm aware of are on the 21st August there was a opening between southern VK4 & VK5 and on the 2nd September Norm VK3DUT worked Steve VK5ZBK.

I've received requests for information of where to listen to assist newcomers to 6m. Below is a list of Australian, New Zealand and New Caledonian 6m beacons that are presently operational.

## Australia

50.046	VK8RAS	Alice Springs	CW
50.058	VK4RGG	Gold Coast	CW
50.066	VK6RPH	Perth	CW
50.087	VK4RTL	Townsville	CW
50.288	VK2RHV	Hunter Valley	CW
50.289	VK2RSY	Sydney	CW

50.293	VK3RMV	Wannon	CW
50.297	VK7RST	Hobart	FSK
50.304	VK6RSX	Dampier	CW
50.306	VK6RBU	Bunbury	CW
50.315	VK5RBV	Barossa Valley	CW
50.345	VK4ABP	Longreach	CW
52.438	VK3FGN	Mildura	CW
52.450	VK5VF	Adelaide	CW

## New Zealand

50.040	ZL3SIX	Christchurch	CW
51.030	ZL2MBH	Napier	FSK
52.275	ZL2MHF	Upper Hutt	FSK
52.490	ZL2SIX	Blenheim	FSK

## New Caledonia

50.080	FK8SIX	Noumea	FSK
--------	--------	--------	-----

There are other beacons either planned or not operating at present, and I will advise

of any updates. If your equipment has the capabilities it is worth programming the above frequencies into memories and regularly scanning them. It is surprising how often you will find the band opens and you hear a beacon. It is also useful to listen for Channel 0 TV, in particular, Toowoomba sound on 51.672 and Wagga sound on 51.740. The International call frequency is 50.110 and the Australian calling frequency 50.200 with most SSB operation taking place between 50.110 and 50.200. For more information check the Australian Amateur Callbook.

Hopefully 6 m will start coming to life during September.

Please remember to send any 6 m information to Brian VK5UBC at [bcleland@picknowl.com.au](mailto:bcleland@picknowl.com.au).

ar

## Silent key

### Reginald Albert (Curly) Moger VK1MV

Curley Moger passed away after a short illness on Thursday 27 July 2006, four days short of his 83rd birthday. Curly will be remembered mainly for his love of amateur radio in general and telegraphy in particular. He gained an interest in telegraphy as a telegraph messenger in 1937, his first job after leaving school. In 1938, he then passed the examinations for promotion to Telegraphist.

At the outbreak of World War II, he decided that he needed a change and enlisted; however, the change did not last long as his telegraphic skills were soon put to work. At the cessation of hostilities, Curly returned to the Postal Telegraphy environment.

His love of telegraphy attracted him to the Morsecodians and later in life moved laterally into amateur radio, specialising

in CW. On completion of his radio exams, he obtained the callsign VK1MV reflecting the callsign of his original Post Office posting at Moss Vale.

His wife Sue, his sons Gary, Craig and Graeme, and grandchildren will sadly miss Curly. He will also be missed by his old workmates, neighbours, and fellow amateurs. He was well represented at his Celebration of Life Ceremony at Gungahlin Crematorium and he was farewelled with the following Ode, telegraphed with a sounder key:

*For them no more the Morse code sound,*

*Now their line has gone to ground,*

*And as the shades of evening fall,*

*We will remember them. GN*

GN Curly

Submitted by John Clare VK1CJ

FEATURE TECH



### AT3000

Automatic Tuner  
1.8-30MHz, 200W

*Smart Tuning* No need for control cable  
*Rapid Tuning* 2s fist tune, 0.5s memorized

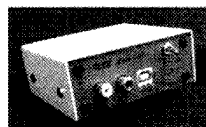

### USB Link-All

Fully Isolated  
Radio-PC Interface

Connecting rig to PC soundcard  
USB port to control PTT and frequency

### Pocket Frequency Counter

Frequency Range:  
10Hz ~ 50MHz  
1MHz~2.6GHz  
Stability: 1ppm (VCXO)  
Battery: Rechargeable Li-Ion

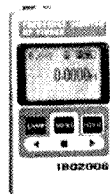

For More Products Visit:

<http://featuretech.co.nz>

Ph: 64-9-630 5078 Fax: 64-9-630 5038

Email: [sales@featuretech.co.nz](mailto:sales@featuretech.co.nz)

Featuretech Limited

# JOTA

**21-22 OCTOBER**  
**Lend a hand locally**

## VK2

Tim Mills VK2ZTM

### Clubs

In mid August, the Blue Mountains ARC conducted their second "Winterfest" field day. Over 200 turned up on a nice fine day to the Glenbrook Scout hall, their meeting venue. There were many traders present, as well as boot sales. WICEN and the Home Brew Group mounted displays and everybody was well fed with the sausage sizzle from the food van. Many are waiting for next year. Other than the Central Coast in February, this is currently the only field day event close to Sydney.

A few days ago, the Oxley Region celebrated their 35th anniversary with a lunch and ragchew. The Mid South Coast ARC will hold their final quarterly gathering on the first Saturday in November, the 4th. Early next year, the Coffs Harbour and District ARC will have their annual field day at a new venue - on Sunday 21st January.

Interest has been expressed from the Snowy Mountain region for the possible forming of a local club.

### ARNSW

This month it is planned to conduct a club conference. As these notes were prepared it was scheduled for Saturday 18 November, at the Ryde Eastwood Leagues Club to start at 10 am. This is where the recent AGM was held. Details will be on VK2WI News and clubs will have been notified by mail.

At mid August, the membership of ARNSW stood at 661 with many joining each month. There has had to be a change of venue for ARNSW exams. The temporary office location, where past exams were conducted since the move from Amateur Radio House, is no longer available at weekends.

Noting that Victoria is coming up to its 95th Anniversary, NSW is 20 months ahead of them.

It will be 50 years next May since the formal opening of the VK2WI transmission site.

Formal permission to conduct Sunday 'broadcasts' was granted in June 1939.

At recent AGM's, there have been various motions to alter the 'Articles' to adapt to changing circumstances.

It has become evident that the current 'Articles' have become outdated. Rather than patch up the edges, it has been decided to seek out a 'model' constitution which is compliant with the current Acts applicable to the Company structure of ARNSW's holding company and adjust it to our requirements. This could result in the calling of an EGM before the end of this year.

In a note from our NTAC committee. They would like to remind groups that while repeater and beacon applications can go direct to the WIA Coordinator, it is beneficial for all to use local assistance in their preparation. We have had a case where the application had insufficient details, particularly with the location, for the interstate Coordinator to process. The VK2 Coordinator is Brian VK2WBK, whom you can contact direct or via the ARNSW office.

### Exams

ARNSW currently conducts monthly exams. Several clubs are also known to conduct courses and exams: Hornsby and District ARC, Waverley ARS, Central Coast ARC, Westlakes ARC, Oxley Region ARC, Karuah Valley RG and Hunter Radio Group. Contact points for these groups can be obtained from the ARNSW web site. This is a call to other clubs and groups to contact ARNSW by the addresses above or telephone 02 9689 2417. The office receives inquiries and it would be nice to have on hand details about your region. Please advise.

### Who said Morse was dead?

Now the interest seems to be even greater. VK2WI recently received a request from VK1 for higher speeds on the 3699 kHz transmission. At present, the highest speed is 15 wpm and their request was for 20 and 25 wpm to be added. This is possible but is it what the users want? At present it steps up a speed every five minutes first from 5, then 8, 10, 12 and 15 wpm when it returns to 5 wpm. Should the extra speed just be added on or should a different format be adopted? Opinions can be sent to the Dural Committee

via the AR-NSW email address of vk2wi@ozemail.com.au or mail to PO Box 9432 Harris Park 2150. To find out more about the 3699 operation, go to the web site [www.arnsw.org.au](http://www.arnsw.org.au)

There, you can also check your copy against the text used.

While on the Morse topic, the Central Coast ARC also operate a training transmission. They have been operating on 439.950 MHz. Repeater Officer Don VK2ZCZ reported in their newsletter of some changes. It is to be moved to a repeater pair on 439.725 MHz, where it will transmit 5 & 10 wpm without any CTCSS (subtone). Its receiver on 434.725 MHz will require a 123.0 Hz CTCSS tone to be activated and when activated, the Morse transmission will cease and a 123.0 Hz CTCSS tone will be added to the transmitted audio so that receivers with CTCSS decode function will not hear the Morse (without the 123 Hz tone) but will hear voice transmissions sent to the repeater receiver with a 123.0 Hz tone.

This means that the repeater can be monitored, using full (transmit and receive) CTCSS and the Morse transmissions will not be heard, unless the user's receiver CTCSS decoder is disabled allowing reception of the Morse Practice code.

Approximately 5 minutes after the last received signal with 123.0 Hz tone, the repeater transmitter will revert back to a Morse Beacon without CTCSS tone.

Don concluded his report by saying - when this new Repeater is installed at the site, the existing 439.950 MHz Morse Beacon Transmitter will be removed and [the channel] used for the "Local Chat without CTCSS or links" repeater.

### VK2WI

VK2WI is the site where ARNSW now conducts the bi monthly Trash and Treasure events. Mark VK2XOF, who coordinates the event, is seeking equipment or stock. If you are having a clean out, have industrial electronic stock for disposal, or a Deceased Estate to process, contact ARNSW. Once the proposed storage facilities have been



constructed, it will be an expanded area to half of the existing shed. The next and final event for this year will be Sunday 26 November.

The weekly VK2WI news has needed to utilize all its transmission facilities as we scrape across the bottom of the cycle. 80 metres has been doing sterling service both morning and evening, helped we believe by the reflector below the dipole.

40 metres has been on a long skip, not helped by a 'broadcaster' across the Tasman who started operating on an adjacent frequency when one of their antennas on another band developed faults.

Our manual relay stations have done a major service for us by providing relays via local repeaters. In the far north, there is the team with Summerland who are

usually at the right distance to get an HF signal. Closer in at Tamworth John VK2YGV struggles for a signal for their VK2RTM on 6750. Recently he had also provided a signal to VK2RCC 6800 which serves Dubbo and the Central West. We are also grateful to the unknown groups providing signals to their regions. Please let us know for the record.

73 - Tim VK2ZTM.

## VK3

### Amateur Radio Victoria News

Website: [www.amateurradio.com.au](http://www.amateurradio.com.au)

Email: [arv@amateurradio.com.au](mailto:arv@amateurradio.com.au)

Jim Linton VK3PC

### Super September Update

The decision to double Amateur Radio Victoria's education effort in September proved to be a success, with 20 enrolled for the two weekend training and assessment sessions.

Thank you to those members who recommended that people enrol. Word of mouth is a powerful marketing tool.

The upcoming Foundation Licence sessions at Box Hill North are 14-15 October, 11-12 November, and 9-10 December.

So, is there a limit on the number of new people who can be attracted into amateur radio through the Foundation Licence?

It does seem it is time to test the market. There is no shortage of WIA accredited assessors with experience under their belts and more soon to be accredited, following a recent assessor training session.

Before the licence restructure just 12 months ago, there was not a lot that could be said about the hobby that would have encouraged people to seriously consider joining it in large numbers.

With those qualifying for the Foundation Licence nationally at around 800 and 300 in Victoria, we have something proven interesting and attractive. Let us now go and sell it!

A proposed public relations exercise to be run by Amateur Radio in the Greater Melbourne area has enlisted

about 15 radio amateurs who will be 'Ambassadors' for the hobby.

In making the call for volunteers, it was not surprising that Foundation Licensees were among the first to put their hands up. The exercise demands a large preparatory effort and we will report on its outcome.

### Changes to Planning Laws

The Victorian Government has decided to remove a number of relatively minor matters from the requirement to have a planning permit.

Amateur Radio Victoria is monitoring this development to see if it is going to change the way in which municipalities approach the issue of amateur radio masts.

In the past year, four members received assistance in relation to radio mast matters. Most of them were straightforward, while one took considerable effort to achieve an acceptable result.

While generally a planning permit has not been required in Victoria for a standard radio mast up to 14 metres in height, they do require a building permit.

### Repeaters Report

The Mt St Leonard VK3RMU site northeast of Melbourne now has a 2-metre repeater on 147.375 MHz in addition to its long-standing 70 cm repeater.

The use of the new Amateur Radio

Victoria repeater requires CTCSS of 91.5 Hz.

In other repeater upgrading, the Bendigo City repeater VK3RBO at Specimen Hill is on-air using a frequency of 438.025 MHz.

The contributions made by Amateur Radio Victoria to the repeater include providing the power supply, diplexers and standby battery. ARV has supplied a new antenna that is awaiting installation by an authorised rigger.

The Midland Amateur Radio Club paid for the repeater plus its controller. Plans include making VK3RBO an IRLP node.

### ILLW 2006

In the true spirit of the International Lighthouse and Lightship Weekend, those who joined the Amateur Radio Victoria VK3WI activation this year had a great time.

Terry Murphy VK3UP coordinated the event at the Williamstown Lighthouse and Timeball Tower (AUS-170). A number of radio amateurs joined Terry. They included Tim Hunt VK3IM, Michele Grant VK3FEAT, John Sargeant VK3FJAS and Brendan Trott VK3OY.

The VK3WI logbook scored many other lighthouses in VK and ZL, and put on a very good show for the general public who stopped to find out what was happening.

## VK5

Christine Taylor VK5CTY

### Adelaide Hills Amateur Radio Society

Keith VK5OQ addressed the August meeting, held at the new venue. He spoke about the over-the-horizon radio system with which he had been involved. This is one of the developments in which Australia leads the way.

Keith explained how the beams are 'bent' over the horizon and showed us some of the aerials used and the results obtained. The difference between a ship and a plane even if the sizes are similar is very obvious to see when you have been shown the difference.

Even though the original system was initially developed to warn of invading enemy missiles etc rather than for peacetime use, the system is extremely useful today for protecting Australia's vast continental shelf from intruding fishing boats.

Keith had a number of amusing stories to tell, of course, of the things that can happen in the bush, so overall the evening was very interesting.

AHARS has had another project night. This time multi-band dipoles were constructed (we were not allowed to call them G5RV aerials because strictly speaking they are multi-band wire dipoles).

There were ten people there that evening and five of them went away

happily draped in wire antennas and ladder lines to feed them, as the photo shows.

The new venue was proclaimed a success, although there was a problem with public transport, as the meeting went rather late, which will no doubt be sorted out eventually.

If you are visiting Adelaide on the 3rd Thursday of the month, please contact Jim VK5NB or John VK5EMI for information about the meeting and the new venue. All are welcome, as were the two from VK3 and one from G-land at the above meeting.



The successful aerial makers (L to R): Sasi VK5SN, Jenny VK5FJAY, Graham VK5GW, and Greg VK5XGH

### The Fleurieu Peninsular Group

There were 24 at the luncheon venue and most of them repaired to the QTH of Garry VK5ZK for coffee and chatter.

Tony VK5ZAI and his XYL Jill were staying overnight with Garry and Cecily, so their round-Australia van was inspected before most of the OMs descended on Garry's shack to see his latest projects.

A presentation was made to Garry and Cecily to show our appreciation of their hospitality for these luncheons. We expect to be shown the 'fabulous' growth of the giant palm each time we visit in future. We may also be shown all the marvellous things Garry can do with a PDA.

As usual, these get-togethers are very pleasant, even though the amount of amateur radio talk varies from time to time.



Graham VK5KGP, Cecily, and Garry VK5ZK (The palm is out of sight on the floor in front of them!)

## VK7

Justin Giles-Clark, VK7TW

Email: vk7tw@wia.org.au Regional Web Site: reast.asn.au

Congratulations to the Northern Tasmania Amateur Radio Club for receiving \$1,900 as one of five successful WIA Club Grants for 2006. The grant is to go toward the purchase of a commercial diplexer to allow mounting of a single Tx/Rx antenna for VK7RAA on Mt Barrow. 160 m AM is alive and well in VK7 again thanks to Dave VK7DM, who is now also relaying the WIA National News and VK7 Regional News broadcasts each Sunday morning from 0900 on the MF band (1840 kHz, who said steam powered radio was dead, HIHI). A search of the ACMA Radcomm database shows that there are now 66 Foundation licensees in VK7. With approximately 560 licensed amateurs in VK7, less the beacons and repeaters, Foundation licensees account for 12 percent of amateurs in Tasmania.

Congratulations to all involved in training and assessing, and keep up the great work!

### North West Tasmanian Amateur Radio Interest Group

On 18 August 2006, students from Devonport and Reece High Schools made contact with Astronaut Jeff Williams aboard the International Space Station at around 1040 UTC. Students were able to ask six questions before some technical difficulties cut the contact short. However, the contact was proclaimed a success. Thanks to NASA and Australian ARISS Co-ordinator Tony Hutchison VK5ZAI.

WIA Assessor Peter Rumble VK2IY/VK4KX now lives in South Riana and is available for training and conducting assessments for all classes of amateur licences. Anyone interested in these training and assessment sessions in the N/West Area should contact Tony VK7AX on 6425 2923 or Ron VK7RN on 6424 6366 or email: nwtarig@spamex.com.

### Northern Tasmania Amateur Radio Club

NTARC's August meeting was a very interesting talk on antennas given by Stuart and Phil and this has stirred up much enthusiasm in the club. Bill VK7MX has been coordinating the bulk purchase of 2 m and 70 cm Chinese handhels and is doing a great deal so,

## Precision Frequency Counter



**\$119  
DELIVERED**

MODEL VC3165

• 8-digit LED display, clear reading

- Range and gate time adjustable continuously (100ms - 10s)
- Selective range
- High stability
- Frequency measurement: 0.01Hz - 2.4 GHz
- Period measurement
- Power: AC
- Input sensitivity: 30mV(rms)

**Geoff White (VK6NX) 08 9498 1157**

(Please leave a message if unavailable, I'm at home looking after a 1 year old future ham)

116 Amethyst Cres, Mt Richon, WA 6112

**cityonline@wdsi.com.au**

## Handhelds 2m or 70cm

LOCKED OUT FOR HAM BAND ONLY

144 TO 148 MHz (VHF)(2M) OR  
420 TO 450 MHz (UHF)(70CM)

**\$99**  
delivered in AUS

### SPECIFICATIONS:

- 1) Voice Prompt on Keypad
- 2) CTCSS with 39 codes
- 3) 99 Storage channels
- 4) Auto scan
- 5) Large screen LCD
- 6) Back Lighting
- 7) VFO programmed (input freq. from keypad)
- 8) Hi & Lo Power select
- 9) Channel spacing: 5KHz, 10KHz, 12.5KHz, 25KHz
- 10) Keypad lock
- 11) Monitor function (input frequency)
- 12) Low-battery warning
- 13) Frequency Modulation
- 14) Auto power save
- 15) Output power: 4 - 5W
- 16) Large-capacity battery
- 17) Ear/microphone auto-charger connections

**SIMPLEX & DUPLEX**

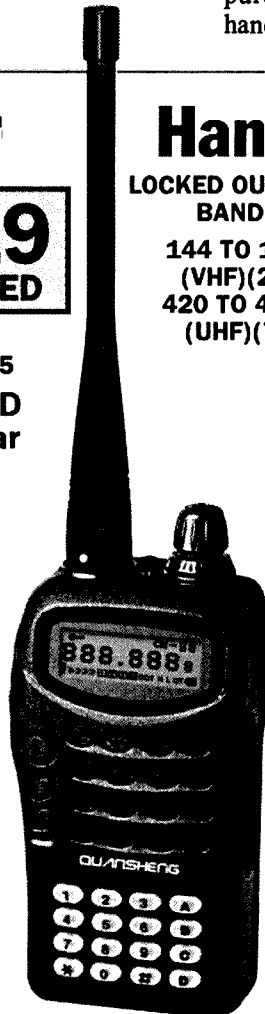

### Extras

- |  |      |
|--|------|
| Extra Battery (1100mah)                                  | \$10 |
| Speaker Microphone                                       | \$12 |
| Car Charger  | \$12 |
| (can charge spare battery and handheld at the same time) |      |
| Headset/Microphone                                       | \$8  |
| SMA to BNC Converter                                     | \$5  |

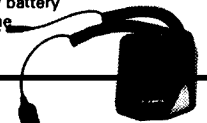

## News from...

if you are interested then contact Bill on 6398 6100, or mobile 0409 608 183 or e-mail: [wmaxwell@bigpond.com](mailto:wmaxwell@bigpond.com) or on VK7RAA.

### Radio and Electronics Association of Southern Tasmania

WICEN was involved in providing communications for the Southern Tasmanian Endurance Riders Event on the weekend of 12/13 August. VK7s ARN, BW, FDNA, HAW, JGD, MBD (and Essie), NXX and ZZ were all involved in the successful deployment. Congratulations to Steve VK7FSRC, Peter VK7FTAZ, and Greg VK7FGGT, who qualified for a foundation licence and Harvey VK7HLE and John VK7HJS for a standard licence recently. The International Lighthouse Lightship Weekend saw VK7s ARN, FAME, FRAE, MBD, TPE and ZZ with support crew Maureen and Essie activate VK7OTC at Cape Bruny lighthouse AUS-024. The group contacted 28 Australian lighthouses, three in New Zealand and many other contacts. Special thanks to Andy VK7WS and his XYL Beth and to Parks and Wildlife Tasmania.

The Wednesday ATV Experimenters' Nights are very popular with many people regularly involved in putting to air video and audio material. Recently, several live interviews went to air, with Mike 7MJ, Graham 7ZGK and Ken 7DY receiving great audio and video reports.

REAST's September visit was a guided tour of the National Foods milk processing facility at Lenah Valley by Dale VK7DG, the facility's engineer. The amount of process control technology throughout the facility was overwhelming. Thanks to Dale for showing us through.



ILLW 2006 participants at AUS-024 Cape Bruny. L to R – Roger 7ARN, Bruce 7MBD, Essie, John 7ZZ. Photo courtesy of Chris 7FCDW.



VK7WI – VK7 Regional News Broadcast on ATV  
L to R - Barry 7RS, Tom 7FTAA, Ken 7DY and Rod 7TRF.

## VK4

The Redcliffe & Districts Radio Club are conducting the annual Red Sun Rally on Sunday 19th November, starting from their clubrooms at MacFarlane Park in Klingner Road, Kippa Ring.

The day will start at 10 am with the Red Sun car rally, followed by a BBQ lunch around midday. This will be followed

by the official unveiling of their newly renovated clubrooms at 1 pm with a local foxhunt also organised for 1:30 pm.

All are welcome to attend what will be an enjoyable day. The club will provide sausages and bread for the BBQ and people are asked to supply their own salad.

The day will wrap up at 3pm with presentations and coffee.

For more information check the clubs website <http://vk4rc.we.net.au> or contact the club secretary Peter Richardson VK4TAA.

ar

# Preparing your station for the High Earth Orbiters

## Part 3

Most of the material I intended to cover has been dealt with in the first two parts of this 3-part series. This will be a short discussion of the equipment options. I will not be recommending any particular brand or model, you need to make that judgement yourself. I will just be offering some suggestions regarding what to look for in the way of specifications and features.

### A word on transceivers

Most modern radios feature transceiver format. Most satellite modes operate with the uplink and downlinks on different bands, sometimes even in differing modes. This has led to the evolution of the multi-band, multi-mode, duplex, satellite transceiver that can theoretically do anything. Read the fine print. Make sure your beaut new transceiver will actually do what the brochures claim. There have been notable lemons in this regard in the past and one or two success stories that have managed to stand the test of time.

### Transceiver requirements

Here we need to take into consideration the caution at the start of last month's column. You will remember it dealt with the increasing noise floor world wide resulting from the proliferation of all kinds of "wireless" computer and domestic telecommunications technology. Projections over the life of the next generation of HEOs has led the Eagle design team to believe that our most favoured bands will succumb to this march of technology leaving our only option to move further into the microwave region.

This will necessitate a complete design rethink, both for the satellite and for earth stations. That represents a complete spanner-in-the-works and it is difficult to move on with such a Sword of Damocles hanging over the future of HEOs.

However, move on we must. I can see a faint hope, a light at the end of the tunnel perhaps, it is this; we are already seeing wireless connectivity devices moving from the 2.4 GHz band into the 5.8 GHz

region. Marketing gurus are exploiting Joe Public's collective view that more is better and soon we may find that 2.4 GHz wireless gizmos may be so far out of fashion that no-one who's anyone would be seen to have one in their thoroughly modern home. If that trend continues – and of course, it's only an 'if', we may again have the 2.4 GHz band and perhaps even the 5 GHz area relatively to ourselves.

Notwithstanding this, dish/feed design is already far enough advanced to allow operation in quite noisy situations. I feel sure we can do better if required. Maybe we just leave time for the march of gizmo technology to leapfrog over us. We already know how fickle Joe Public is concerning his toys. In the meantime, we can take solace from the German P3E spacecraft, which is far enough advanced in design and preparation to virtually guarantee us HEO operations on the "U", "V", "S", "L" and "C" bands well into the next decade.

So (deep breath) after all that, let us again consider your emerging HEO station. It will need to cover the 2 m band, the 70 cm band and, if you have the resources left, the 23 cm band. You will need to have the capability of unhooking the in-band transceive function and have the transceiver receive on any one of these bands and transmit on any other – at the same time.

Even this may not be enough. Sometimes the radio may be pressed into service as an IF strip for a downconverter on some other band, typically 13 cm. It cannot be emphasised too much, that special precautions are needed to prevent blowing up your down-converter. The accidental application of RF for even a moment can destroy such precious gear. Masthead

pre-amps require the same kind of consideration.

A much safer method, and one used by many experienced HEO operators in the past is to consider a separate receiver for that function. If the set does not transmit anything, your up-line gear should be

### The AMSAT group in Australia

The National Co-ordinator of AMSAT-VK is Graham Ratcliff VK5AGR. Contact Graham if you wish to be placed on a mailing list for breaking news and net reminders. As a forum for members AMSAT-VK operates two monthly nets.

### AMSAT-Australia Echolink Net

The "Echolink" net meets on the second Sunday of each month. Anyone with an interest in Amateur Radio Satellites is welcome to join the net. Graham VK5AGR acts as net controller. The net starts at 0500UTC during summer time periods and 0600UTC during winter standard time periods. Connect to the AMSAT conference server on Echolink a few minutes before these times.

### AMSAT-Australia HF net

The HF net meets informally on the second Sunday of each month. In winter (end of March until the end of October) the net meets on 3.685 MHz at 1000 UTC. In summer (end of October until end of March) the net meets on 7.068 MHz at 0900 UTC. Start listening 15 minutes before these times.

All communication regarding AMSAT-Australia matters can be addressed to:

AMSAT-VK,  
9 Homer Rd,  
Clarence Park, SA. 5034

Graham's e-mail address is:  
vk5agr@amsat.org

# Amateur Radio Bookshop

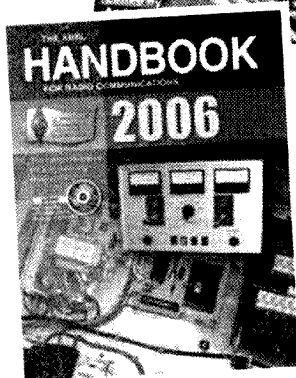
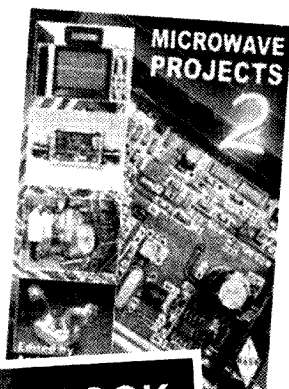

Download our catalogue at

<http://www.wia.org.au>

Amateur Radio Bookshop

PO BOX 3084

EAST BLAXLAND

NSW 2774

Office: WIA National Office

Tel 03 9528-5962

Fax 03 9523-8191

[bookshop@wia.org.au](mailto:bookshop@wia.org.au)

**ARRL – RSGB  
publications  
books  
magazines  
CDROMs - DVDs**

safe. Many regular users of the HEOs in the past have added one or more single band transceivers or receivers to the shack gear to cater for all circumstances. Despite what some advertising material implies, we are still a long way from the universal satellite radio. Whatever radios you decide upon, they should have SSB, CW and FM modes as standard. The developing noise situation world wide on our most favoured bands has potential to alter radically the shape of our satellite stations. But – lacking a crystal ball and considering that the next satellite, P3E should be around for quite a while, it would be reasonable to build your HEO station around a 2 m and a 70 cm transceiver or one of the multi-band, multi-mode jobs now on the market. However, you must read the fine print, particularly concerning duplex operation. You can add suitable down-converters as needed.

## Data Modems

Data rates up to at least 9600 baud operations and possibly 38k4 should be part of normal activities on P3E. You may never be concerned with digital operations but it adds to the fun. The idea of a return to the heady days of the UoSats with the added challenge of a HEO orbit is enough to send a chill up one's spine. High-speed modems are expensive if you are so moved, but they are not essential to get the show going. They can be added later at your whim.

## Antennas

As discussed in earlier parts, you should really consider a tracking system with at least 2 metres and 70 cm on board and perhaps room for a small dish. It would be quite legitimate to bypass this requirement and concentrate on building your station around the higher frequency bands and a single dish with multiple patch feeds. Designs are freely available whether you decide to build your own Yagis, dish or whatever. Aside from surplus dishes, you can easily make most of the rest in the shack workshop. Whether bands U, V, L, S or C, try to give your two most favoured bands your best shot. High gain, switched CP, pre-amps, the lot. This HEO thing is not something you can approach in a sneaky fashion. You can add to your station as time goes on – but – you need to start out with a capable station, whatever your preferred mode or bands of operation.

## Rotators

There is not a wide range here. You will just need to make a commitment, bite the bullet and do it! I was fortunate in finding an AZ/EL rotator on sale at a hamfest about 15 years ago. It is still performing perfectly. Unfortunately, the thought of putting together a working AZ/EL auto-track system is what puts many people off the HEOs – or serious satellite operation of any kind if it comes to that. Remember though that a ground mounted, manually operated dish will give good results when the HEOs are way out there near apogee. They move very slowly across the sky giving you plenty of time for long QSOs with DX stations. My 2.4 GHz dish is ground mounted and manually steered. Most of my 2.4 GHz contacts came with the radio and laptop out on the back veranda.

## Computer and Software

A good computer is an essential part of a HEO station. You will need it for orbital predictions, for downloading Keplerian data from the internet, for running the software to control your antenna pointing and to handle any data decoding that might take your fancy. Strictly speaking, you do not need the latest and flashiest computer, but pricing is so competitive these days, you will most likely already have a machine far more capable than required for amateur radio satellite purposes. My old clunker has barely enough resources to support Windows98se, yet it does everything required.

## Feedlines.

Quite simply, buy the very best you can afford. Get a good soldering outfit, learn how to solder properly and fit brand new connectors everywhere.

I will leave it there. I hope the last three columns have gone some way to help those who may be considering the jump from LEO to HEO. Good luck with your efforts. Consider all the above before you commit yourself. It is not an easy road but it leads to heaps of fun and satisfaction. Remember the AMSAT-NA web site. Go to Eaglepedia to read and consider the latest design thoughts from the Eagle design team. Details of the P3E craft are available from the AMSAT-DL web site.

ar

## Telecommunications policy:

### RBR could wipe out HF comms

A proposed U.S system to protect satellites from solar storms or high-altitude nuclear detonations could cause side effects that lead to radio communication blackouts on the High Frequency bands. The following is a report from Jim Meachen ZL2BHF.

According to new research in New Zealand and elsewhere, the "Radiation Belt Remediation" or RBR system as proposed by the United States military, could significantly alter the upper atmosphere. It could also seriously disrupt high frequency radio transmissions and degrade GPS navigation around the world.

"Science Daily" broke the story in its on-line news service. It says that the RBR system is designed to protect hundreds of low earth-orbiting satellites from having their onboard electronics ruined by charged particles when the Van Allen Radiation Belts are super-energized by high-altitude nuclear explosions or naturally occurring but powerful solar storms.

The United States Air Force and the Defense Advanced Research Projects Agency are pursuing the technology. It involves the generation of very low frequency radio waves that are expected to flush particles away from the radiation belts and dump them into the upper atmosphere over one day or possibly several days.

At least in theory, it sounds as if it might protect the satellites, but at a significant cost to High Frequency spectrum users including radio amateurs. A scientific team from New Zealand, the United Kingdom and Finland has been studying the effect of the proposed RBR satellite protection system. It calculates that Earth's upper atmosphere could be dramatically affected by such a system.

The team says that sustained and unusually intense High Frequency blackouts would be common around most of the world. For hams, international broadcasters and other users of long range High Frequency communications it would be as if the United States government had thrown a switch and

turned off those bands.

Dr. Mark Clilverd, who is with the British Antarctic Survey, says that aircraft and ships that rely on High Frequency communications could also lose radio contact. He also says that some remote communities that depend on HF could be isolated for as long as six to seven days each time the system is used.

In addition, just as worrisome is the effect of RBR on the Global Positioning System or GPS. The researchers say that signals between ground users and satellites would be disrupted as they pass through a highly disturbed RBR controlled ionosphere.

Those investigating the proposed system suggest that if the super charge of the radiation belts resulted from a rogue nation detonating a nuclear device in the upper atmosphere, using Radiation Belt Remediation technology would probably be acceptable to the international community. However, using the system to mitigate the lesser risk to satellites from charged particles caused by naturally occurring solar storms should be considered more closely. The researchers say that the impact of the disruption to global communications needs to be weighed carefully against the potential gains.

This study was published in the August edition of the international journal *Annales Geophysicae*. Those conducting the research suggest that national leaders and their telecommunications policy-makers must carefully consider the rather severe implications of Radiation Belt Remediation before it is ever used. (*Space Daily*, others)

(ARNNewline 180806)

## UK

### 5 MHz extension

UK telecommunications regulator Ofcom and the Ministry of Defence have agreed to extend the 5 MHz experiment that started at the end of July 2002 until June 2010. This extension follows discussions between Ofcom

and the RSGB. 5 MHz NoV holders will also be permitted to use an additional two frequencies.

The RSGB is also lobbying Ofcom for use of 501 and 504 kHz. This is in dedication to the memory of the maritime services that no longer use the 500 kHz frequency.

(RSGB)

## New Zealand

### 5 MHz operation

Whilst on the subject of the UK and their 5 MHz operation, NZART advise that effective 24th August 2006 two frequencies, namely 5.3214 and 5.3964 MHz are available on a temporary basis to licensed amateurs in New Zealand. All modes are permitted with a bandwidth maximum of 2.8 kHz and subject to non-interference to other services. NZART have developed rules approved by the R.S.M. These frequencies cannot be used for contests or radio award activity.

(NZART)

ar

## OzSpid Rotators

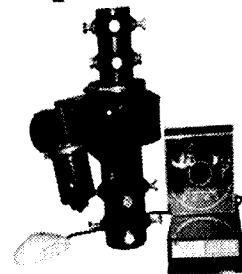

Oceania - New Zealand - Australian Distributors.

Australian Enterprise Industrial

P.O. Box 1013

Browns Plains, QLD. 4118.

Ph. 0414 254 080.

Fax. 07 3800 8003.

aceutower@spin.net.au

# DX - News & Views

VK40Q,

P.O. Box 7665, Toowoomba Mail Centre, QLD 4352.

Email -john.bazley@bigpond.com

Well it certainly was good to see the Sunspot numbers rising and a corresponding improvement in band conditions, though unfortunately only for a few days, but sufficient to make us realise what a small improvement can do to propagation.

With the recent DXpeditions having taken place (at the time of writing Mayotte and Lestho), the participants have obviously managed to cope with the new rules and legislation introduced by the Airlines - but undoubtedly they will have had some difficulties - their reports should make interesting reading. Certainly, in recent months there has been a move towards a reducing the amount of equipment taken, particularly linears, with possibly more attention made to antenna systems.

The following addition to the DXCC Accreditation Criteria was issued on the 11th August by Wayne Mills N7NG:

*For a number of years, it has been accepted practice to post DXpedition QSO information on a DXpedition Web site. Although this information is generally limited to callsign, band and mode, it has been useful in reducing the number of duplicate contacts in the DXpedition log. Publishing complete QSO information, or information from which full QSO information can be derived, on the other hand, threatens the integrity of the QSLing process, and is unacceptable. There must be some information that the station claiming the QSO provides based solely on actually being there when the QSO was made. If complete QSO information can be derived from information based on the DXpedition log, the QSL manager's job can be much more difficult if busted calls are involved. To help minimize potential difficulties, therefore, the following restriction has been approved by the Programs and Services Committee, and added to the DXCC Accreditation Criteria, Section III.*

*The presentation in any public forum of logs or other representations of station operation showing details of station activity or other information from which all essential QSO elements (time, date, band, mode and callsign) for individual contacts can be derived creates a question as to the integrity*

*of the claimed QSOs with that station during the period encompassed by the log. Presentation of such information in any public forum by the station operator, operators or associated parties is not allowed and may be considered sufficient reason to deny ARRL award credit for contacts with any station for which such presentations have been made. Persistent violation of this provision may result in disqualification from the DXCC program. (My highlighting)*

This is worth reading carefully, and in future, for those DXers using a DX Cluster, it is worth considering, when putting 'up' a spot, whether or not to include such information as:

"Tnx - at last after 3 hours!" "tnx for the new one", "Tnx Fred - good to be in the log!" etc. All these indicate the actual time of a QSO - the only data missing is the report.

The following operation has been approved for DXCC credit:

**KH8SI - Swains Island.** Also, K1ER/KH8, KS6FO/KH8, WH7S/KH8, K8YSE/KH8, AH7C/KH8 and KH6BK/KH8 from July 28, 2006 through August 2, 2006. The above team have released the following statistics of their recent operation:

**Band QSOs:** 160 metres 227 QSOs. 80metres 266 QSO's, 40 metres 1595 QSOs, 30 metres 2426 QSOs, 20 metres 7096 QSOs, 17 metres 3657 QSOs, 15 metres 800 QSOs, 12 metres 323 QSOs.

**Continent QSOs:** Africa 53, Asia 5132, Europe 1655, N. America 8810, Oceania 603, S. America 137.

**FH - Sam Serge,** F6AML will be active as TX6A from Mayotte (AF-027) from 5th until 17th October. He plans to operate CW and SSB on 80-10 metres (suggested frequencies: 3514, 7014, 10115, 14014, 18071, 21014, 24892 and 28014 kHz; 3785, 7057, 14266, 18140, 21266, 24966 and 28444 kHz) and to pay special attention to North America and Japan. QSL via home call, direct or bureau.

**VQ9LA QSLs:** Larry Arneson VQ9LA, says that after 1st September 2006 he will no longer accept IRCs. Diego Garcia has no place to redeem them and his contact stateside no longer will buy his coupons. All QSL cards with IRCs for VQ9LA, VQ9X and VQ9IO received after 1st

September will be placed in the outgoing QSL bureau.

**3X - Valery RA3AJ** reports that Serge UA6JR (3XM6JR) and Alex RW3AZ (3XD2Z) will be active again from Boke, Guinea starting on 29 August "for the few next years". They certainly have started well with a lot of activity on RTTY and PSK and extended periods of activity. They intend to operate on 160 - 6 metres CW, SSB and RTTY, plus PSK and SSTV (3XM6JR). Serge also plans to operate from IOTA groups AF-096 and AF-051 during his stay, while a special callsign (3XY3AZ) is supposed to be used in contest activities. QSL via UA6JR, direct or bureau.

**YTICS - Miki** is planning a trip to Africa in October, to activate some IOTAs and countries. He plans stops in Tanzania, Kenya, Burundi, Ethiopia, Comoros, and Mayotte. From Kenya and Tanzania, he will activate AF-040, AF-067, AF-032 and AF-063. He is looking for sponsors. Contact him at yt1cs@ptt.yu.

**HK0GU, San Andres.** Gerd DL7VOG will be back on the air as HK0GU, San Andres, in November. To begin with, between November 9th and November 14th, he will be on from Isla Pirata, SA-040, signing HK0GU/1. This will count as the Colombian mainland. Then, from November 15th to December 1st, he will be on Providencia Island, NA-049, which does count for "HK0," San Andres and Providencia. He will be QRV on all bands including 160M, using CW, RTTY, and some SSB, using an Icom IC-706MKIIG, 100 watts, to a Butternut HF9V vertical and a "fishing rod" vertical for 160 m. Gerd says he does not think this will be his last visit to HK0 either, and in the future he may occasionally be able to be there at a good time of year for a 6 m opening. For more details go to [www.qslnet.de/hk0gu](http://www.qslnet.de/hk0gu) QSL via DL7VOG, direct to Gerd Uhlig, P.O. Box 700 332, D-10323, Berlin, Germany, or through the bureau. You may also request a bureau QSL reply by asking for one, with all the QSO details, to [hk0gu@dl7vog.de](mailto:hk0gu@dl7vog.de).

Special thanks to the authors of The Daily DX (W3UR) and 425 Dx News (IIJQJ) for information appearing in this month's *DX News & Views*.

ar



# Hamads classifieds **FREE**

## WANTED NSW

Geloso band switched Pi-Coupler. Would if necessary purchase equipment which includes this piece of gear. Ken North VK2ZAN 02 6331 3335.

## FOR SALE VIC

FT-200 & FT-200PS in original packing. Little used. 50 ft wind up tower & tilt over section, excellent order. 2 x Honeywell mainframe terminals and keyboards. Large selection of those hard to obtain valves to restore that old equipment. Send list of your needs QTHR VK3APB 03 5442 1693 or 5443 3601.

FREE to pickup: 1 Marconi B28 X-Royal Navy Receiver. Complete but needs work to restore. Email mewdav@netcon.net.au QTHR VK3AXT.

CODAN Model 8525 radio. 99 channels 100 watts output. Good working reliable radio. Eprom programmed with 5 VKS 737 channels plus 80/40/30/20 metre frequencies. \$485. VK3IQ QTHR Ph 03 5672 2563

## WANTED VIC

I am trying to restore/complete my AN/TRC24 Radio system and I am looking for the following parts/units:- Transmitter, T-302/TRC Power Supply, PP-685/TRC Receiver, R-417/TRCA Band Plug-in AM-1180/GRC Amplifier/converter, AM-2537/TRA-25 and any other bits and pieces for this radio. Thanks for reading this. Regards, John Eggington, VK3EGG johne@telpacific.com.au Mobile 0409 234 672

## FOR SALE QLD

Icom IC-746 HF/VHF transceiver Pro plus Power Supply PS-125 (25 Amps) with books \$2000. FM Transceiver IC-2000 with DTMF mike, with 2 mobile whips, Book \$600. Power Supply (25Amp) home brew \$200. Terlin Antenna good condition \$300. What offers for the following: Icom IC-720A transceiver with fault, book. Beam 3 element Cushcraft. Rotor and Controller. Beam 10 element 2 metre Yagi. Contact Lyne; 07 5442 6027

## WANTED QLD

TS-660 All Mode Quad Bander transceiver or YAESU FT-620, must be in working order. Price to VK4KAL QTHR or email donvk4kal@bigpond.com

## FOR SALE TAS

Handheld transceiver 1.2 GHz IC-12A/AT/E 1 watt FM \$300. Mobile transceiver 1.2 GHz FT-2311R 10 watt FM \$250. 4 relays 12V UHF coax \$10 ea. QTHR VK7ZAL Robert.

## MISCELLANEOUS

From my grandfather's estate, there is a quantity of magazines from the 1950/60s and a number of manuals, and a 78 rpm standard Marconi signals disk and various other items. We wish to know if these would be of interest to WIA members. Madeleine, email madals@bigpond.net.au.

## THE WIA QSL COLLECTION REQUIRES QSLs

All types welcome, especially rare DX pictorial cards, special issue. Please contact the Hon Curator, Ken Matchett VK3TL, 4 Sunrise Hill Road, Montrose Vic 3765, tel. (03) 9728 5350

## About hamads....

- Submit by email (preferred) or on the form on the reverse of your current Amateur Radio address flysheet. Please print carefully and clearly, use upper AND lower case.
- Separate forms for For Sale and Wanted items. Please include name, address STD telephone number and WIA membership number if you do not use the flysheet.
- Deceased estates Hamads will be published in full, even if the ad is not fully radio equipment.
- WIA policy recommends that the serial number of all equipment for sale should be included.
- QTHR means the address is correct in the current WIA Call Book.
- Ordinary Hamads from those who are deemed to be in general electronics retail and wholesale distributive trades should be certified as referring only to private articles not being re-sold for merchandising purposes.
- Commercial advertising on these pages Contact Newsletters Unlimited.
- Copy typed or printed clearly please, and received by the deadlines shown on page 1 of each issue of Amateur Radio.

Email: [newunltd@bigpond.net.au](mailto:newunltd@bigpond.net.au)

Postal: Newsletters Unlimited, PO Box 431, Monbulk Vic 3793. Fax: 03 9756 7031

### TRADE PRACTICES ACT

It is impossible for us to ensure that the advertisements submitted for publication comply with the Trade Practices Act 1974. Therefore, advertisers and advertising agents will appreciate the absolute need for themselves to ensure that the provisions of the Act are strictly complied with.

### VICTORIAN CONSUMER AFFAIRS ACT

All advertisers are advised that advertisements containing only a PO Box number as the address cannot be accepted without the addition of the business address of the box-holder or seller of the goods.

## AHARS BUY & SELL November 18th

Westbourne Park RSL Hall  
Doors open 9.00

### The Biggest Buy and Sell in VK5

Everyone will be there.  
*Make sure you are, too*

# B.A.R.G.

BALLARAT AMATEUR RADIO GROUP

## HAMVENTION

SUNDAY 5TH. NOVEMBER  
2006

AT  
THE GREAT SOUTHERN WOOLSHED  
WESTERN HIGHWAY  
8 K EAST OF BALLARAT  
IAN VK3AXH 03 5341 3012

EMAIL:  
[IGM@NETCONNECT.COM.AU](mailto:IGM@NETCONNECT.COM.AU)  
[VK3BML@BARG.ORG.AU](mailto:VK3BML@BARG.ORG.AU)

### ADVERTISERS INDEX

AEL.....	53
Amateur Radio Bookshop .....	52
Andrews .....	16
Com-an-tena.....	29
G & C.....	9
Icom .....	OBC
Ozgear .....	23
Rippletech .....	17
TTS.....	8
Small ads.....	55
KVK.....	35
TET-Emtron .....	22
Vertex.....	IFC
Westlake.....	30
White.....	49
Winlink.....	35

# VKHAM.COM

## AUSTRALIAN AMATEUR RADIO

Hundreds of pages and links related to Amateur Radio and radio in general

Home of:

- VK Classifieds
- VK Auctions
- VK's on the Internet

Repeater Maps, Software, Prefix Maps and more ...

## AMIDON FERROMAGNETIC CORES

For all RF/electronic applications.

See our website for complete data on all cores.

[www.catchnet.com.au/~rjandusimports](http://www.catchnet.com.au/~rjandusimports)

### RJ & US Imports

PO Box 431, Kiama NSW 2533.

A 3.5" PC disk containing all data is available for \$5.00 incl. post.

#### Agencies

Active Electronics, Tas  
TTS Systems, Tyabb (VIC)  
Tower Communications, Perth  
Ozhelp Services, Brisbane  
MiniKits, Adelaide

## RM Products Italy

are now available in Australia after the appointment of Hamak Electrical Industries Pty Ltd as distributor for RM products

Visit the Hamak website at [Hamak.com.au](http://Hamak.com.au) for

**Linear amplifiers,  
Power supplies  
and accessories**



## JACKSON BROS

JACKSON OF THE UK IS BACK

Highest quality products made by UK craftsmen

[www.jacksonbrothers.com.au](http://www.jacksonbrothers.com.au)

Full range now off-the-shelf in Australia

Variable and trimmer capacitors, reduction drives, dials, ceramic standoffs

CATALOGUES, PRICE LISTS AVAILABLE

CHARLES I COOKSON PTY LTD

11-13 Port Rd

Queenstown SA 5014

Tel: (08) 8240 3200 Fax: (08) 8240 3233

FreeFax 1800 673355 within Australia

Email: [sales@jacksonbrothers.com.au](mailto:sales@jacksonbrothers.com.au)

ALL MAJOR CREDIT CARDS ACCEPTED

SOLE AGENTS AUSTRALIA AND NEW ZEALAND



## Tunable Loop Antenna enhances AM

### Reception

AM radio reception (530 to 1900KHz) enhanced. Reception where none existed before; works indoors, even in interference-polluted areas. High value — low cost.

Simple, no connections or batteries. Ideal for touring, caravan, boat and fringe areas. Use anywhere.

[www.amradioantennas.com](http://www.amradioantennas.com)

[pkloops@bigpond.net.au](mailto:pkloops@bigpond.net.au)

Paul 0412 302 939

**PK's Loop Antennas**

## HF, VHF, UHF ANTENNAS & ACCESSORIES

Aluminium towers, guys etc

Diamond VSWR/PWR meters.

HD copper antenna wire & insulators,  
TX tubes & pwr transistors,  
full range Create Rotators

Quality coax cables & connectors.  
Free advice & catalogue.

### ATN Antennas

Ph 03 5492 2224 Fax 03 5492 2666,

email [atnant@iinet.net.au](mailto:atnant@iinet.net.au)

PO Box 80, Birchip Vic 3483

## VIDEOEMAIL.

Also Live Video Messenger and Conferencing for Teaching, Talks and Tutorials.

Do away with websites.

Brand your Videoemail and watch your business skyrocket.

Put video on your eBay ads.

FREE 30 day trial

Email to: [arecibo@bigpond.com](mailto:arecibo@bigpond.com)

*Have you  
recruited a  
new member  
this year?*

DIRECTORY WILL RETURN NEXT MONTH

## Are you managing the estate of a 'Silent key'?

Please save any QSLs for the National QSL collection, but first contact:

The Hon. Curator,

Ken Matchett VK3TL

on (03) 9728 5350

or email: [jeandawson@iinet.net.au](mailto:jeandawson@iinet.net.au)

Rare DX, special call-signs prefixes and suffixes, pictorials and pre-war QSLs are needed.

*Let us save something for the  
history of amateur radio.*



## RADIO & ELECTRONICS SCHOOL

### Become a radio amateur

Check out the courses on offer from Australia's premier training institution for radio amateurs and hobbyists.

### Already licenced?

Upgrade to the Standard licence using our self paced multi-media CD ROM course. The easiest way to become a licenced radio experimenter.

Discover digital communications, get more power and more bands

### Still want more?

Be guided by one of our experienced facilitators using our proven on-line study methods and get your Advanced licence.

### Visit

<http://www.radioelectronicschool.com>

for more information,

or email the course manager at

[info@radioelectronicschool.net](mailto:info@radioelectronicschool.net)

Telephone 07-5573-2795 12-5PM AEST

Amateur radio – a bridge to careers in radio communications technology

# INTERNATIONAL LIGHTHOUSE & LIGHTSHIP WEEKEND

19th & 20th August

Many VK Clubs participated in one of the most picturesque and photogenic events on the 2006 calendar.

*See their full stories and more pictures in the centre pages.*

*Right: QSL card from Operation Grassy Hill lighthouse at Cooktown*

*Below right: David VK5HDW at Cape Jaffa*

*Below: The Pine Islet lighthouse at Mackay*

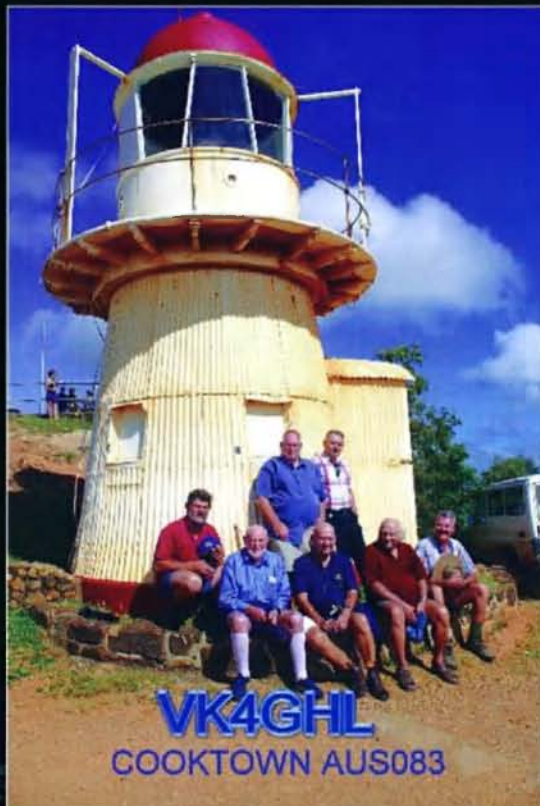

# ICOM's price break through

## most affordable prices ever



### IC-7000

HF/VHF/UHF All mode Transceiver • 100W HF/50MHz, 50W/2m, 35W/70cm • I.F DSP for improved noise rejection • Digital IF filter for Dial up selectivity • 2.5" TFT colour display for bright easy reading • Remote control DTMF Mic for fingertip control & IRLP access PLUS • digital voice storage • 2 mode band scope • Multi function meter 7 SWR display • Built in RTTY modulator



### IC-756PRO III

HF\*6m • Sharp & soft IF filter shape • New receiver gives +30dBm third-order intercept point • One-touch record/play • Digital voice memory • Extended 1/4 Tuning step & BPF functions for SSB-D mode • 32-bit floating-point DSP and 24-bit AD/DA converter • SSB/CW synchronous tuning • 5-inch colour TFT LCD • Built-in antenna tuner • Customisable filter shape • No optional filters to buy

Amateur



### IC-7800

HF\*6m • Four 32-bit floating point DSP units • +40dBm ultra high intercept point • Automatic tracking pre-selector • Two completely independent receiver circuits • 200W output power at full duty • Ultra high frequency stability • 7-inch wide color TFT LCD • Multi function spectrum scope • RTTY / PSK31 operation without PC connection • Professional 6m receiver • Digital Voice Recorder • CF memory card.



### IC-2200H

FM Dual Band Transceiver • VHF High (65W) Power Output • DTCS & CTCSS Tone Squelch • DTMF Encode & Decode (with optional UT108) • Digital Voice & Data Communication (with optional UT118) • 207 Alphanumeric Memories



### IC-P7A

VHF/UHF (2m/70cm) Dual-band FM Handheld Transceiver • Ultra compact body, light weight 47x81x28mm, 160g • Mini-power VHF/UHF dual bander with wideband receiver 0.495-999.990MHz • 1800mAh large capacity Li-Ion battery allows 20hours operating time (Tx:Rx:Standby=5:5:90) • 1.5W output power on 2m & 1W output power on 70cm • Simple operation • 1000 memory channels with flexible memory bank system • Oversize LCD for clear display of function information



### IC-T90A

A new 5W Triband handheld • VHF/UHF FM 2M, 6M, & 70CM Wideband receive 495KHz - 1GHz 555 Alphanumeric memories • 13 Scan modes DTCS & CTCSS encode & decode DTMF encoder (10 memories) Wide/narrow transmit capability.

ICOM

ICOM 142

Call your local ICOM dealer [www.icom.net.au](http://www.icom.net.au) or (03) 9549 7500

The magazine for AUSTRALIAN radio amateurs

Volume 74 No 11  
November 2006

# Amateur Radio



\$7.00  
incl GST

## Foundation Licensee

Number  
**1000**



**VK3FBDW**

featuring

GPS software for your computer  
WICEN Tasmania (South) tries a  
new approach for the 2006 Safari



A Vertical Whip  
for a Caravan



## 2 Bands in Your Pocket ...

### VX 2R/E

World's smallest dual band handheld  
 Wide band receive; Listen to radio and TV  
 WiRES™ internet linking for global communication  
 Versatile scanning for easy frequency management  
 Received Coverage; 500kHz 999MHz AM,FM,WFM  
 Tough aluminum diecast chassis

**\$ 344**  
RRP



### FT 8900R

Dual receive; Talk on one band, listen to another  
 Cross band repeat; Turn your car into a mobile repeater station  
 VFO tracking for satellite operation  
 Hyper memory feature for preset actions

**\$ 853**  
RRP



## 4 Bands in Your Car ...



### New FT 2000

Elite class HF/50 Mhz Transceiver with a powerful 100w RF output  
 Built on FT-DX 9000 technology, setting a new benchmark for DX'ers  
 Dual receive; Listen to both sides of the pile up or,  
 watch a frequency on the same band for activity  
 Optional DMU 2000 with extensive display capabilities  
 Digital signal processing for both transmit and receive

**\$ 3,989**  
RRP



## Every Band in the World

*... well HF anyway.*



**YAESU** *Now with manufacturer support*  
Choice of the World's top DX'ers

For your nearest dealer please visit [www.vxstd.com.au](http://www.vxstd.com.au) or call 03 9518 2100





# Amateur Radio

Volume 74, Number 11  
November 2006

The Journal of the Wireless  
Institute of Australia  
ISSN 0002-6859

## Editorial

**Editor:** Peter Freeman VK3KAI  
editor-armag@wia.org.au

**Technical Editor:** Peter Gibson VK3AZL

**Publications Committee Members**

Brenda Edmonds	VK3KT
Ron Fisher	VK3OM
Evan Jarman	VK3ANI
Tom Potter	VK3UBS
Bill Roper	VK3BR
Ernie Walls	VK3FM

## All circulation matters

[nationaloffice@wia.org.au](mailto:nationaloffice@wia.org.au)

## How to submit material

### General and Technical articles

Secretary  
AR Publications Committee  
PO Box 2175,  
Caulfield Junction Vic 3161  
or [armag@wia.org.au](mailto:armag@wia.org.au)

### Columns and letters to Editor

Editor  
AR Magazine  
PO Box 273  
Churchill, Vic 3842  
or [editor-armag@wia.org.au](mailto:editor-armag@wia.org.au)

### Hamads

"Hamads" Newsletters Unlimited  
PO Box 431  
Monbulk VIC 3793  
Fax 03 9756 7031  
[newunltd@bigpond.net.au](mailto:newunltd@bigpond.net.au)

### Advertising

All enquiries to  
Newsletters Unlimited  
PO Box 431  
Monbulk Vic 3793  
Phone: 03 9756 7797  
Fax: 03 9756 7031  
[newunltd@bigpond.net.au](mailto:newunltd@bigpond.net.au)

### Registered Office

10/229 Balaclava Road,  
Caulfield North VIC 3161  
Australia  
Phone: 03 9528 5962  
Fax: 03 9523 8191

## Production Deadlines

General articles, columns and  
advertising booking 10th day of  
previous month.

Hamads and advertising material 15th  
day of previous month

The contents of Amateur Radio are Copyright  
Wireless Institute of Australia © 2006

## GENERAL

- WICEN Tasmania (South) tries a new approach for the 2006 Safari Tasmania** .....17  
Roger Nichols VK7ARN
- Barry Whittle VK3FBDW, Number 1,000**..... 15  
Robert Broomhead VK3KRB
- Two Australian ATV records in three days!**.....20  
Dan Joyce VK2GG
- ANVDG 2005/2006 Long Distance Competition**.....52  
Leigh Rainbird VK2KRR

## TECHNICAL

- GPS software for your computer** .....5  
Ian Glanville VK3AQU
- The difference between three and five elements** .....6  
Felix Scerri VK4FUQ
- Transmitting Baluns for 1.8-30MHz**.....7  
Ron Sanders VK2WB
- A 4-125 Linear Amplifier for 160 m - Part 2 – construction**.....12  
Drew Diamond VK3XU
- A Vertical Whip for a Caravan** .....22  
Ian Cowan VK1BG
- A "sewer pipe" balun** .....26  
Rob Gurr VK5RG

## COLUMNS

- |                   |    |                              |            |
|-------------------|----|------------------------------|------------|
| ALARA             | 34 | VK2                          | 30         |
| AMSAT             | 35 | VK3                          | 31         |
| Beyond our shores | 37 | VK5                          | 32         |
| Contests          | 41 | VK7                          | 33         |
| Directory         | 56 | Over to you                  | 48         |
| DX – News & Views | 47 | Silent Key                   | 16, 38, 48 |
| Editorial comment | 2  | Spotlight on SWLing          | 46         |
| Hamads            | 54 | VHF/UHF – an expanding world | 49         |
| IARU News         | 39 | WIA comment                  | 3          |
| News from...      | 30 | WIA News                     | 4          |

## Our Cover this month

Barry Whittle of Gembrook, Victoria, now Barry VK3FBDW, is the 1,000th person to have his qualification for an Amateur Operators Certificate of Proficiency (Foundation) certified by the WIA Exam Service. A great achievement by Barry. 1000 new Foundation licensees certified in less than one year is a great achievement for amateur radio. Story on page 15.

### Contributions to Amateur Radio

Amateur Radio is a forum for WIA members' amateur radio experiments, experiences opinions and news. Manuscripts with drawings and/or photos are always welcome and will be considered for publication. Articles on disc or email are especially welcome. The WIA cannot be responsible for loss or damage to any material. A pamphlet, 'How to write for Amateur Radio' is available from the National Office on receipt of a stamped self-addressed envelope.

### Back Issues

Back issues are available directly from the WIA National

Office (until stocks are exhausted), at \$4.00 each (including postage within Australia) to members.

### Photostat copies

When back issues are no longer available, photocopies of articles are available to members at \$2.50 each (plus an additional \$2 for each additional issue in which the article appears).

### Disclaimer

The opinions expressed in this publication do not necessarily reflect the official view of the WIA and the WIA cannot be held responsible for incorrect information published.

## Amateur Radio Service

A radiocommunication service for the purpose of self-training, intercommunication and technical investigation carried out by amateurs; that is, by duly authorised persons interested in radio technique solely with a personal aim and without pecuniary interest.

## Wireless Institute of Australia

The world's first and oldest National Radio Society  
Founded 1910

### Representing

The Australian Amateur Radio Service

### Member of the

International Amateur Radio Union

### Registered Office of the WIA

10/229 Balaclava Road, Caulfield North Vic 3161

Tel: (03) 9528 5962 Fax (03) 9523 8191

email: nationaloffice@wia.org.au

http://www.wia.org.au

### All mail to

PO Box 2175 Caulfield Junction VIC 3161

Business hours: 10am – 4pm weekdays

### National Office staff

Margaret Williams	Administration Officer
Dianne Ashton	Examination Officer
Brenda Edmonds	Office Volunteer

### Board of Directors

<b>President</b>	Michael Owen	VK3KI
<b>Vice-President</b>	Ewan McLeod	VK4ERM
	Robert Broomhead	VK3KRB
	Glenn Dunstan	VK4DU
	Trevor Quick	VK5ATQ
	Robyn Edwards	VK6XRE
	Phil Wait	VK2DKN
<b>Secretary</b>	Ken Fuller	VK4KF
<b>Treasurer</b>	Bruce Bathols	VK3JUJ

### Coordinators

<b>AMSAT</b>	Graham Ratcliff	VK5AGR
<b>ARDF</b>	Jack Bramham	VK3WWW
<b>Australian ARISS</b>	Tony Hutchison	VK5ZAI
<b>Awards</b>	Mai Johnson	VK6LC
<b>Club Coordinator</b>	Ted Thrift	VK2ARA
<b>Contests</b>	Ian Godsil	VK3JS
<b>John Moyle Memorial</b>		
<b>Field Day Manager</b>	Denis Johnstone	VK3ZUX
<b>Editor 'AR'</b>	Peter Freeman	VK3KAI
<b>EMC/EMR</b>	Gilbert Hughes	VK1GH
	Keith Malcolm	VK1ZKM
<b>Standards</b>	Gilbert Hughes	VK1GH
	David Wardlaw	VK3ADW
	John Bishop	VK2ZOI
<b>NTAC</b>	John Martin	VK3KWA
<b>Historian</b>	Will McGhie	VK6UUJ
<b>IARU Region 3</b>		
<b>Liaison Officer</b>	Michael Owen	VK3KI
<b>Intruder Watch</b>	Glenn Dunstan	VK4DU
<b>International</b>		
<b>Travel Host</b>	John Miller	VK3DJM
<b>ITU Conference &amp; study group</b>	Gilbert Hughes	VK1GH
	David Wardlaw	VK3ADW
	Keith Malcolm	VK1ZKM
<b>QSL Curator</b>	Ken Matchett	VK3TL
<b>QSL Bureau Coordinator &amp; VK9/0 QSL Manager</b>	Neil Penfold	VK6NE
<b>Repeater Coordinator</b>	Peter Mill	VK3ZPP
<b>Webpage co-ordinator</b>	Colin Thompson	VK2TRC
<b>WICEN</b>	Ewan McLeod	VK4ERM

## Editorial comment

### One year of the new licence structure

This editorial was written 12 months after the formal announcement and commencement of operation of the revised licensing conditions in Australia.

In the months leading up to the formal announcement, the WIA and many of its members committed large amounts of time and effort in preparing for the introduction of the Foundation Licence. With all the systems and materials in place, the task of training and accrediting Assessors commenced.

The outcome was a new system for the training and assessment of candidates for the new Foundation Licence. The first trial training and assessment event occurred just before the official release of the Licence Conditions Determination Amendment, if I remember correctly. As a result, the licensees were on air very soon after the formal commencement of the new system.

There are now over 1000 persons qualified. Of course, much of the credit for this must go to the clubs, as Michael Owen VK3KI rightly identifies.

Congratulations to all involved in the development of all stages of this new system. Significantly the ACMA was sufficiently confident of the new assessment regime to allow a change in the assessment system for the higher levels of licence – Standard and Advanced.

Gone are the exams with the immediate sealing of the papers, forward the package off to the WIA Exam Service and waiting for the results to be returned. The assessment system now allows for immediate feedback to the candidate. Even better, the Exam Service has refined their systems, with a more rapid turn around of paperwork which will allow a Licence to be issued.

Whilst some individuals consider that there may be improvements that can be made to the entire training and assessment system, I am certain that the majority will agree that we have come a long way in the last two years. Well done to all involved.

There still remains some possible fine tuning of our Licence Conditions, as a result of the period of consultation and the publication of the Outcomes paper. At the very least, we should see the various regulatory documents combined into a single comprehensive document.

Peter Freeman VK3KAI

### Vale June Fox

For many years, a visit or call to the WIA Office would be welcomed by June Fox (or her friendly voice). Much of my interaction with June involved Examination Events, as an Accredited Invigilator under the old assessment system. June was always bright & cheerful, always helpful. June passed away peacefully on 15 October. June will be missed by all who interacted with her. An SK for June appears in this issue.

### Systems

The AR magazine production system is complex. The AR Publications Committee guides and assists me in the processing and review of material submitted for publication.

Our many regular contributors send in columns and news from clubs or the state-based organisations. Most editorial material comes through me for review. Ordinary articles are acknowledged on receipt but can take some time to move through the registration and review process. Each article is reviewed by a technical editor and images and diagrams brought to publication standard if required.

The articles are then forwarded to me for a further review before joining the pool of articles ready for publication. I will then forward the article to the publication house for the next issue being prepared. Then we have a small team of proof readers, to find those niggling little things missed along the way.

This entire process is just one of the systems in place to deliver your magazine. We also have the maintenance of the membership database and mailing list, the production house, the 2 printers – one for the cover and another for the internal pages, the packaging of the final magazine, the mailing house/distributor and then finally Australia Post.

The teams have been aiming to have the magazine in the majority of members' mailboxes early in the first week of each month. We finally achieved that with the October issue, except for some members. A system error at distribution occurred, and some received their copy only after we printed additional copies. Please accept everyone's apology for this delay. The appropriate team has resolved that particular error – let us hope that we do not find any more gremlins.



## “That Was the Week that Was” one year on

“That Was the Week that Was” was the headline for the WIA Comment published in the November 2005 issue of Amateur Radio.

It was written around the fact that the new Australian amateur licence structure came into effect on 19 October 2005.

Let me quote a couple of extracts from that Comment.

“The Foundation Licence is the new gateway to amateur radio.

The ACA, in its “Outcomes of the Review of Amateur Service Regulation” May 2004, reported that over two-thirds of all submissions were in favour of the introduction of a foundation licensing option, similar to the Foundation licence in the United Kingdom.

The Foundation qualification places emphasis on the safe operation of radio equipment, and includes the assessment of a practical element involving the operation of transmitters and receivers and a multiple choice written paper covering safety, operational and regulatory matters.

To meet the requirement for a practical element, the WIA has introduced a new system of assessment of competency for the qualifications for the new licences, relying on qualified, accredited and registered WIA Assessors, who can undertake the practical assessment and also mark the examination papers.”

It is now one year on.

Let me focus again on the Foundation licence. Have the changes been successful? Do we have more amateurs because of the new entry-level licence? Are we better off?

On 29 September 2006, just 3 weeks short of a year from the coming into force of the new licence structure, the WIA issued the 1,000th certification of qualification for an Amateur Operator Certificate of Proficiency (Foundation).

That figure of 1,000 qualifications may be broken down by location as follows:

Australian Capital Territory	38
New South Wales	277
Victoria	353
Queensland	87
South Australia	111
Western Australia	50
Tasmania	74
Northern Territory	10

A year ago, in the November 2005 WIA Comment, I said that over 70 people had qualified as WIA Assessors. We now have 141 WIA Assessors and 15 Nominated Assessors across the country. And so in the year the number of Assessors has doubled.

Some of those Assessors have conducted many assessments, some have yet to conduct an assessment.

What does all of that tell us?

It probably tells us that initially, and at least in some parts of Australia, the resource to assess candidates was much more limited than today.

It highlights the fact that so much depends on the clubs. Those clubs that make sure they have the right number of WIA Assessors to do the job, and those that promote and conduct the courses determine how successful the whole program is in their area. A small number of clubs have been responsible for many of the new licensees, with many clubs each responsible for a smaller number of the new “F” calls

We cannot complain about how this has worked, as if all the clubs had promoted courses and conducted Foundation courses with the same enthusiasm, I have no doubt that the WIA Exam Service would have been overborne and unable to deliver the service that it is now delivering.

It also tells us that the clubs have been more active in some states than in others in establishing, promoting and conducting Foundation courses. It means that we have every reason to look forward to a further 1,000 new “F” calls in the second year of the entry level licence as clubs in new areas commit to establishing, promoting and conducting courses.

Looking at the figures on a state basis, it is clear that there is a real opportunity in Queensland, as an area that has not yet been fully exploited.

At the Conference of Queensland Clubs in Brisbane (conducted on 14 October 2006 by the WIA Queensland Advisory Committee for the WIA), I pointed to the very low figures for Queensland. Whilst I acknowledged the real contribution

of some clubs, I suggested that an opportunity to attract new amateurs must exist in Queensland. It was agreed that the opportunity was there and I am sure that many clubs, perhaps with some clubs combining to do so, will be giving a priority to attracting new amateurs and conducting courses to qualify them.

We have been lucky that different clubs have picked up the challenge at different times. If there had not been a gradual coming on stream by the clubs and Assessors, the WIA Exam service would not have been able to give the service it now delivers.

One person who was anxiously waiting for the 1,000th Foundation licensee was the late Chris Jones VK2ZDD, who had done so much to encourage everyone involved in the establishment of the WIA accreditation system, the course conducted by the clubs and their promotion and the assessment of candidates.

The success of the Foundation licence and the new WIA system of assessment of competency for the qualifications for the new licences is due to the effort and commitment of very many people, but no-one more than Chris.

I should also repeat what I said at the IARU Region 3 Conference in Bangalore: that the WIA does not presume to say that the Foundation licence would have the same success in other countries. All we will do is share our experience as best we can, and leave it to those who know their own environment to judge whether our experience can help them.

I believe the Foundation licence has been successful in Australia. It has increased, in a year, the total number of amateurs by around 1,000. It has introduced new people into amateur radio and into the clubs, and the WIA membership has grown significantly with the new “F” call members.

And, importantly, I believe we can look forward to a continuation of the success over the next year.

ar

# WIA News

## WIA Director on ABC radio

WIA Director Robyn Edwards VK6XRE promoted amateur radio and the WIA during an appearance on the ABC Goldfields breakfast program, hosted by Christina Morrissey on 4 October 2006.

The topic was really International 10-4 Day but as the program host wanted to discuss the codes used on radio, Robyn was able to discuss all radio codes including Morse code, the Q code and the fact that "SOS" is now 100 years old.

The tiers of "recreational radio", CB, Amateur Foundation, Standard and Advanced licences were discussed, and Echo Link demonstrated by connecting to a repeater in Kent, England and listening to its identification introduction.

The WIA web site and a local contact number were also mentioned.

## National Contest

### Coordinator

Contests are an important aspect of the WIA's activities. For some years Ian Godsfil VK3JS, as the WIA Contest Coordinator, has promoted and coordinated WIA contests. Ian has also contributed a regular Contest column to Amateur Radio.

Ian advised the WIA Board that he wished to step down from this role. The Board is very grateful for Ian's long and valuable contribution to amateur radio and to the WIA, and has extended the WIA's thanks to him.

The Board has appointed Phil Smeaton VK2BAA as National Contest Coordinator to replace Ian.

Phil has quite a history in contesting. An avid tester when living in the British Isles, Phil has also worked under a string of call signs with contest teams where he has used every mode possible. Today, as an Australian resident, Phil does not have an antenna farm advantage, yet still has a high presence in many contests.

As noted in the October edition, Phil will also take over the Contest column in AR, continuing to provide information and contest dates.

## October AR

The October issue of *Amateur Radio* was received by most members very early in the month, thanks to a real effort by Editor Peter Freeman and everyone involved to avoid the delays that have led to regular mid month deliveries.

The October AR delivered to some members had a wrong membership 'paid to' date on the address sheet. This can be disregarded. The correct date will be shown in future.

## New BPL Trial Switched On in Mount Beauty, Victoria

A new BPL trial by SP-Ausnet has recently been activated in Mount Beauty, Victoria. The service provider is SP Ausnet, with Schneider Electric, with providing all hardware components. Schneider Electric is an owner of Clipsal Australia.

Mount Beauty is a town 339 km northeast of Melbourne in the Victorian high country. The population is about 1,700, swelling to many times more in the snow season.

The trial covers about 8 streets over 1-2 square km, and the access BPL service is to be provided free for 6 months to any residents within that area.

Power distribution within the trial area is overhead and BPL equipment has been installed on every second or third pole. It is believed that many BPL modems have already been installed.

Radio amateurs within the BPL trial area are suffering BPL interference and the WIA is currently assisting them and closely monitoring the trial.

## New 40 m broadcast channel for VK4

The 7 MHz WIA news broadcast channel for southern VK4 shifted in frequency from 7118 kHz into the new broadcast segment at 7130 kHz on 22 October 2006.

"The change is in accordance with the new WIA 40 metre band plan, and also removes the interference caused by the PNG broadcast station on 7120 kHz", commented WIA Director, Glenn Dunstan VK4DU.

## New Measurements Show Aurora BPL's Susceptibility to Interference

Justin Giles-Clark VK7TW and his team at the Radio and Electronics Association of Southern Tasmania (REAST) have measured the susceptibility of the Aurora Energy BPL trial in Hobart to nearby radio transmissions.

Their Mt Nelson RF Susceptibility Report shows a very high degree of disruption from very low power transmitters

([http://reast.asn.au/2006/VK7\\_BPL\\_RF\\_Susceptibility\\_Tests.pdf](http://reast.asn.au/2006/VK7_BPL_RF_Susceptibility_Tests.pdf)).

Less than 5 Watts power output from a mobile station within 60 to 80 metres of a modem seemingly adversely affects the BPL service. This represents an effective radiated power (EIRP) of less than 1 Watt due to the inefficiency of the mobile antenna. Mobile HF radio equipment normally operates with an output power of 100 Watts.

## QLD Clubs Conference

WIA Affiliated Queensland clubs attended a Conference of Queensland Clubs in Brisbane on 14 October by the WIA Queensland Advisory Committee.

WIA President Michael Owen VK3KI gave a report on recent activities, and sought feedback on the progress of the Foundation licence qualification program and also sought opinions on the way the Board should proceed in setting up the Advisory Committees for the future.

WIA Vice President Ewan McLeod VK4ERM talked about emergency communications, particularly from a Queensland view-point.

Both Ewan and Michael attended a meeting of the Sunshine Coast Amateur Radio Club the next day.

## ARRL Appeals FCC BPL Rules to Federal Court

The American Radio Relay League (ARRL), the US national amateur radio society, has notified the US District Court of Appeals-DC Circuit that it is appealing certain aspects of the FCC's Part 15 rules governing broadband over power line (BPL) systems. The ARRL Executive Committee ratified plans to go forward with the Petition for Review when it met on 7 October 2006. The ARRL is asking the court to review the FCC's October 2004 Report and Order establishing Part 15 rules to govern BPL systems as well as its August 2006 Memorandum Opinion and Order that dealt with various petitions for reconsideration of the 2004 Report and Order, including one from the ARRL.

Several reconsideration petitions of the initial FCC proceeding - including one from ARRL - called on the FCC to strengthen rules aimed at protecting licensed radio systems from BPL interference. Instead the ARRL says that the FCC has limited the extent to which an unlicensed, unintentional radiator has to protect a licensed mobile station.

ar

# GPS software for your computer

Ian Glanville VK3AQU  
lorian@netc.net.au

Sometime ago I came across an article about GPS software for your computer. GPSS from Sunninghill, as it is known, is a programme written by Robin Lovelock.

Although it won't give you turn by turn directions without a great deal of detailed work, it is still a powerful programme and one that I felt would interest many radio amateurs. The beauty of this programme is that it speaks, allowing you to concentrate on driving. With suitable software added it will even respond to spoken commands. You can add your own voice and maps to give it that personal touch.

The web site for this GPS software is: <http://www.gpss.co.uk/>. Or just type "GPS Software" into Google.

This web site is extensive and there is no need for me to go into great detail. Go to Robin's homepage above and download the help file as well as Help from Dave Gehman. Print these out to use as your instruction manual. Follow the links and download the two files GPSSA and GPSSB as well as maps for Australia. Place all these files into one directory

and execute them. The GPSS program runs from GPSS.exe. If you don't have a GPS receiver or GPS mouse, don't worry, because the programme goes into a demonstration mode if no GPS receiver is detected.

To get GPSS working in your area, you will need a GPS receiver or mouse. I chose the BU-303 shown in Fig 1 (available on eBay). This is a small device with a metre or so of cable and a USB plug for connection to the PC/laptop. It has a very strong magnetic base for placement on the car roof, but I've found the dash to be just as effective, as long as it can receive a satellite signal. The small LED on the side will blink to indicate signal lock. Before running GPSS with the mouse, go into the gpss.cfg file and change the com port setting to suit the port the GPS mouse plugs into, and the home location to your own. My GPS mouse came with a programme on a small CD which can be used to detect the port allocated to the mouse, if needed.

It goes through a start up routine and

if receiving a signal, it will change to the best map it has for that area.

The program can be configured to display an instrument panel over your map as shown in Fig 2 and announce speed and distance in kilometres and metres, or miles and feet. How often to speak? What to say? Where you are? In fact, a whole host of things are at your control via simple WordPad files. You can even record your trip for later replay.

Just look at how much information is available from the instrument panel. The top dial is direction and distance to your destination. The centre one your current direction and the bottom one your speed. Also displayed are distance travelled, minutes to destination, heading, altitude, and rate of climb. As soon as you start to move, GPSS will announce your speed, direction and distance, and estimate the time of arrival at your destination, if programmed. The destination can be pre-programmed for entry by a single key press or by placing the mouse pointer over the destination and clicking. A small icon on the screen shows your current position. Once you change the gpss.cfg file to your home co-ordinates, pressing "H" will automatically make home your destination.

In the first two years since release in 1995/96, several million copies were



Fig 1 The BU-303 takes little room on the dash

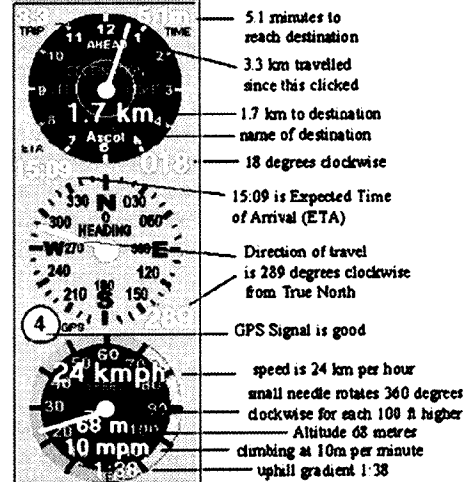

Fig 2 The instrument panel is comprehensive

# The difference between three and five elements

Felix Scarri VK4FUQ

This article might alternatively be titled, "what is antenna gain, and what does it really mean, in practice?" These questions may sound a bit philosophical but ongoing testing between two antennas has made me wonder about these questions.

The comparison is between two 2 m VK4FUQ "strip" Yagi style designs that are proven consistent high performance Yagi antennas. I noted in an earlier article on small Yagi beam maintenance, that the (slightly) longer five element was consistently better than its smaller three element counterpart overall.

This may be the expected result, though, in theory, the "gain" difference should be "only" in the order of 2.5 dB. It has often been stated that "3 dB" is the minimum "level" difference that can be discerned. Well, at least when it comes to antennas on VHF, I'm not really sure about that! Over the last couple of months the comparisons between the two 2 m Yagis have shown that the theoretical 2.5 dB means quite a lot in practice!

One of the really interesting things noted during the comparisons has been shown up by "low power" testing. My 2 m hand-held has two RF power levels. "High" power is about seven watts (FM) and low power is nominally one watt. Using our "local" 2 m repeater in Townsville (about 100 km road distance away) as reference, with the little three-element Yagi on a six metre pipe mast.

Access at the high power setting was good, as was expected.

But it was almost impossible to access the repeater at the low power setting. Occasionally the repeater could be "keyed" up, but was impossible to "hold it" reliably at the one watt power level.

In contrast, the five element "strip" Yagi (same mast and fed with the same coax) had absolutely no trouble in keying and holding the repeater at the low level, 100 percent of the time. Such is the difference between three and five elements!

In the end, the degree of "difficulty" and loss over any given radio path will determine just how much antenna gain will be required for consistent success over that path. The same sort of thing applies to RF power level. Recent observations on a local 40 m "ragchew" net, where the radio path is consistently excellent, have shown up the same sort of observations. One test, going from 100 watts SSB down to three watts peak, the received signal only went down from S9 + 10 to an indicated S7 on the "S" meter with no deterioration in overall readability. Yet I have observed the reverse situation on 20 m, where, on a bad propagation day, two stations running large Yagis and maximum allowable power could not make a reliable contact on a path that was normally quite reliable.

Back to my observations with 2 m beams, the difference in "gain" between

the three and five element Yagis allowed good access into the "local" repeater on low power with one Yagi and not the other. In many contact situations a slight gain difference will go unnoticed; however, here is where it definitely will be noticed! Perhaps it comes down to a considered analysis of what is achievable in terms of physical antenna size and overall construction difficulty, matched against the intended radio path loss and, of course, the signal strength profile one would be happy with.

There are some modes that do require a lot of antenna gain, such as EME and weak signal VHF/UHF DX working being two obvious examples. In these scenarios, as much antenna gain as possible, along with judicious power, is almost mandatory for good consistent results!

My 6 m pipe mast could easily hold up either beam, although the five element is almost twice as long as its smaller brother (an interesting observation in terms of achievable gain). It is still physically very manageable, and given the improved performance into our local repeater the five element is now atop the 6 metre pipe mast and the little three element has "gone portable".

Ending with a little home spun philosophy; it's almost like everything else in life. There are tradeoffs and conflicting demands existing everywhere!

ar

## GPS software from previous page

distributed on CD. In recent years, over 80 people download a copy of GPSS each day. GPSS has been used for over 10 years for both "navigation", where the Laptop PC computer and GPS are carried in a car, and for "remote tracking", where the GPS is at the end of a communications link such as mobile 'phone or satellite comms. In fact, the first radio amateur users of GPSS were in Australia. Radio amateurs also use GPSS for Radio Direction Finding or "Foxhunting". Checkout the details on: <http://www.gpss.co.uk/radio.htm>.

GPSS is now available for the Pocket PC and Smartphone, and Robin is about to put both remote tracking and Direction Finding into the package.

The program has a great many features. Just how detailed it becomes is entirely up to you. To help you find your co-ordinates you might like to try: <http://www.csu.edu.au/australia/latlong/index.html>; Google Earth; or even the RACV VicRoads directory or equivalent for your state.

ar

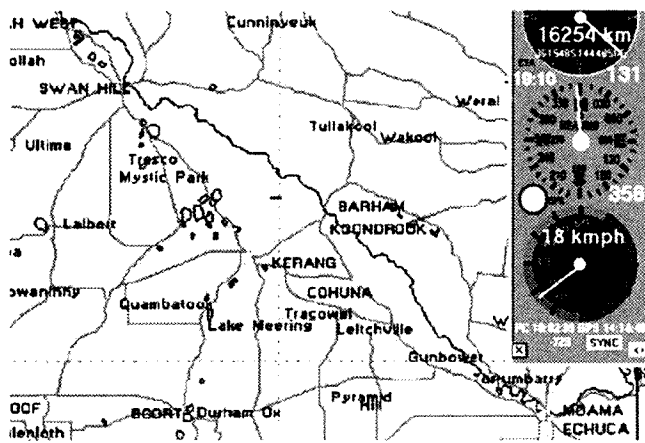

Fig 3 What you see is where you are

# Transmitting Baluns for 1.8-30 MHz

Ron Sanders VK2WB

*Amateur Radio* magazine had an interesting series of articles on connecting amateur equipment to antennas in the April, May, June, and July 2005 issues. The articles covered the theory behind making matching transformers for the HF amateur bands using transmission line techniques. The following article uses that information and provides plots of various arrangements to show the different effects due to transmission line characteristics and ferrite material. Here is additional information on using ferrite rods instead of toroid cores.

## Test setup

All measurements were made with the Autek VA1 antenna analyser. This versatile instrument can measure the SWR of a load at any frequency between 0.5 and 32 MHz for various matching impedances between 25 and 450 ohms. Fig 1 shows the setup with a toroid transformer connected to the VA1 input and having a pure resistive load (small carbon trimpot) on the transformer secondary. This trimpot is set to a value which reflects the impedance selected on the VA1 via the transformer ratio - eg with a 4:1 transformer and the VA1 set to 50 ohms, the trimpot is set to 200 ohms on the secondary side.

The reading errors inherent in the VA1 were subtracted from the actual measured SWR values via a spreadsheet and the corrected SWR values are then plotted against frequency from 1.8 to 30 MHz.

## Transmission line winding techniques

The windings all consist of twin-wire transmission lines. These lines will have a characteristic impedance ( $Z_0$ ) depending upon the wire diameter, spacing between the wires, and any separating material between the wires. To achieve good matching (SWR near 1.0:1), the  $Z_0$  should be close to the optimum for the chosen transformer impedance ratio. This is covered in the Amateur Radio articles referred to above.

As enamelled copper wire (ECW) is the most common wire available for winding, I chose three different sizes which are all generally available in Australia. Some configurations have used a common polyethylene spacing twine (Kinnears 504TEX, available from craft shops) to get an acceptable match. I have placed a layer of PTFE insulating tape (plumbers thread sealing tape) on each core before winding.

Figures 2, 3, 4 and 5 show the different bifilar winding and spacing methods.

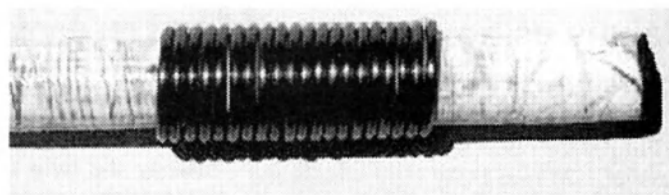

Fig 2 - All bifilar pairs and turns close-spaced.

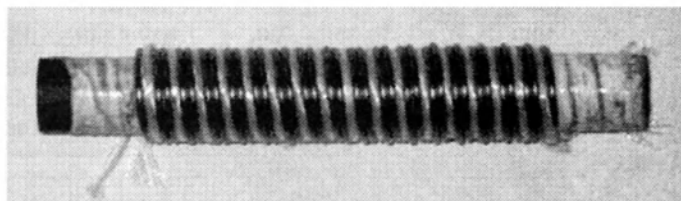

Fig 3 - Each bifilar pair separated by twine.

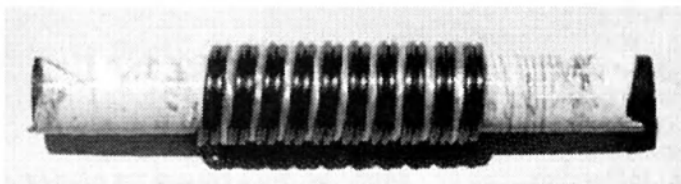

Fig 4 - Bifilar turns separated by twine.



Fig 5 - All turns separated by twine.

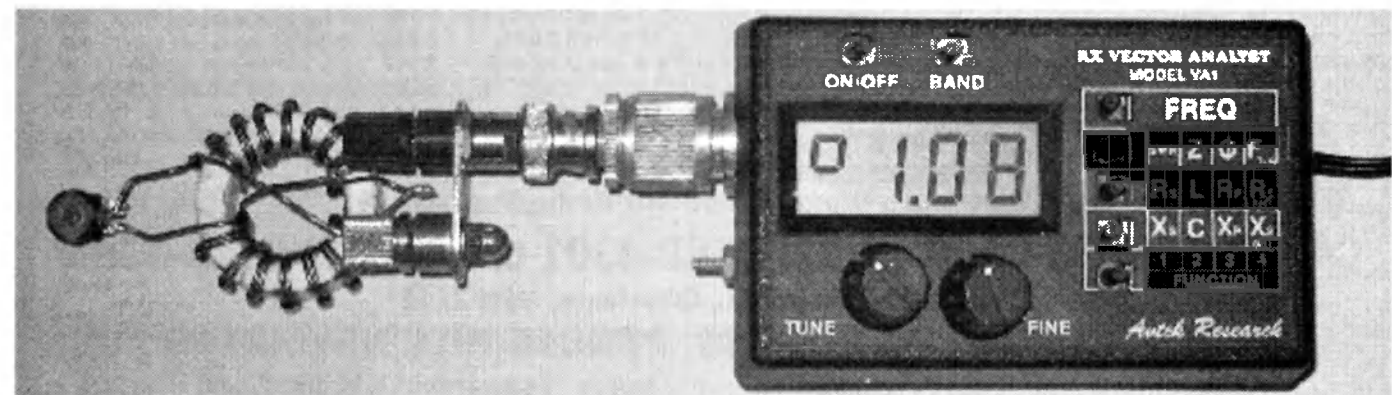

Fig -Set-up of analyser

## Baluns

All baluns use #61 ferrite as rods (R-61-037-300) or toroids (FT-140-61 or FT-240-61). This material is best for transmitting applications in the 1.8 - 30 MHz range. All windings are centred on the rod or evenly spaced around the toroid as shown in the pictures. Rod dimensions are 9.4 mm diameter x 75 mm long.

## Toroid dimensions:

FT-140-61 35 mm od x 23 mm id  
x 12.7 mm height  
FT-240-61 61 mm od x 35 mm id  
x 12.7 mm height

## Baluns using rods

### 1:1 Balun

See Fig 6 for the schematic. The plot in Fig 7 is the result in winding 17 bifilar turns of 1.25 mm ECW all close-spaced around the ferrite rod. Now compare this with the plot in Fig 8 that has 17 bifilar turns of 1.0 mm ECW on the same rod, but with spacing twine between some or all wires. The combination of spacing twine and wire gauge has improved the

n turns bifilar winding

• start

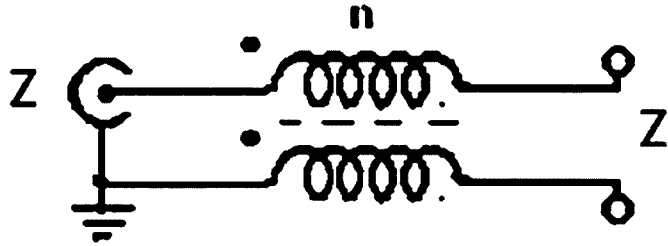

## 1:1 Nonisolating Balun

Fig 6 - Schematic

SWR for 75:75 and 50:50 baluns, by making the twin transmission line  $Z_0$  closer to the optimum in each case.

### 1:4 Balun

I have called this arrangement a 1:4 balun to differentiate it from the 4:1 balun shown in Figs 12 and 13.

This balun transforms 50:12.5: this

is useful for feeding a three element Yagi beam from coax. This design is based on one in the Transmission Line Transformers Handbook by Jerry Sevick and cannot be duplicated with a toroid core. The balun schematic is shown in

continued page 10

# Andrews Communications Systems

### ICOM DISCOUNTED

IC-756 Pro III HF+6m **\$4,999**  
IC-V8000 2m 75W **\$399**  
IC-746 Pro or IC-7000 **\$2,499**  
IC-706 Mk 2G HF-70cm **\$1,399**  
IC-718 HF SSB **\$999**  
IC-910H 2m+70cm SSB **\$2,299**  
IC-208H 2m+70cm **\$579**  
IC-2200h 2m 60W **\$399**  
IC-T90A Triband h/h **\$449**  
IC-2720H Deluxe D/bander **\$699**  
IC-P7A New tiny D/bander... **\$389**  
IC-V82 2 m H/H **\$369**

**\*3 YEAR WARRANTY\***  
**ALINCO**

### Factory Direct Importer

NEW DJ-V17 5W 2m H/H **\$249**  
NEW DR-635T Twinbander **\$699**  
DR-135T Mk2 2m 50W **\$299**  
DR-435 UHF 35W **\$369**  
DJ-V5E Dualband handheld **\$499**  
DJ-X2000E Hi-tech scanner **\$679**

**\*3 YEAR WARRANTY\***

Spectrum Analysers from **\$999**

### ICOM IC-7000 \$2199



### HF-70cm COLOUR TFT DISPLAY

IF DSP, Twin PBT, 508 channel memory + more

### bhi DSP NES10-2

Amazing DSP speaker

Hundreds sold!



**\$249**

### KENWOOD DISCOUNTED

TS-570SG HF+6m+ ATU **\$1,999**  
TS-480HX HF 200W+6m **\$1,999**  
TS-2000 HF-70cm + ATU **\$2,799**  
TS-570DG HF + ATU **\$1,799**  
TM-271A K 2m mobile **\$379**  
TM-D700A Dualband Mob **\$899**  
TS-480SAT HF+6m+ ATU **\$1,899**  
TM-G707A 2m/70cm mob. **\$499**  
TM-V708A Dual band Mob. **\$799**

**\*3 YEAR WARRANTY\***

**NEW**

### YAESU DISCOUNTED

FT-1802M 2m 50W Mob. **\$289**  
FT-7800R Dualband **\$449**  
FT-8900R Quadband **\$799**  
FT-8800R Dualband **\$699**  
FT-897D HF-70cm **\$1,399**  
FT-857D HF-70cm **\$1,299**  
FT-2800M 2m 65W **\$299**  
FT-60R Dualband h/h **\$369**  
FT-817ND HF-70cm Port. **\$999**  
VX-1R H/held 2 batts **\$249**  
VX-2R Tiny Dualband **\$319**  
VX-170 2m H/held **\$269**  
VX-6R Dual H/H **\$449**  
VX-7R Deluxe H/H **\$549**

**\*YAESU ROTATORS DISCOUNTED\***

**\*3 YEAR WARRANTY\***

**Australia's Biggest Amateur Radio Stockist**

### HF VERTICAL ANTENNAS

CUSHCRAFT R8 40m-6m **\$899**  
CUSHCRAFT A3 WS WARC Yagi **\$999**  
DIAMOND CP-6, 80m-6m **\$499**  
DIAMOND BB7V Broadband **\$499**  
COMET CHA-250B B/band **\$599**  
MALDOL HVU-8, 80m-2m... **\$499**  
18 AVQ Mk II **\$449**  
HY-GAIN DX-88, 80m-10m... **\$799**

THP, LDG, MFJ, ALINCO, ICOM, YAESU

Automatic antenna tuners in stock  
TET-EMTRON HF Antennas in stock  
AVAIR POWER METERS, T' LEADS, ETC.  
MFJ Antennas, Tuners, Analysers, etc.  
ANDREWS AMPS...160m-10m 500W+  
w/protect. \$999, 2m 120W \$329,  
2m 200W \$449, 2m 300W \$999.  
ANDREWS YAESU, PALOMAR,  
TE SYSTEMS, AMERITRON, ICOM linears

### ANDREWS AMATEUR BASE ANTENNAS

BF-2M2 Fibreglass 2m 6.7dB **\$69**  
BF-2M3 Fibreglass 2m 7.8dB **\$99**  
UVS-200 Fibreglass 6dB/8dB **\$149**  
UVS-300 F/glass 8.3dB/11.7dB **\$199**  
CBS18 Fibreglass 5.7dB 10m **\$179**  
Discones from \$99, Coax switch \$29  
Hustler HF Verticals From \$349

Massive stocks MFJ Antennas,  
Tuners, Digital Analysers

**CALL (02) 9636-9060 or (02) 9688-4301 or FAX (02) 9688-1995**

**WHY PAY MORE?**

Shop 8, 41 Bathurst St., Greystanes, NSW 2145

**MAIL ORDER to PO Box 240 PENDLE HILL NSW, 2145**

<http://www.andrewscom.com.au>

email: [lee.andrews1@bigpond.com](mailto:lee.andrews1@bigpond.com)

Some items indent.  
Prices subject to change without notice.  
Limited stock some items  
E&OE 8/06

Visit us at  
[www.gccomm.com.au](http://www.gccomm.com.au)  
for new product updates

Proudly supported by Vertex Standard Australia  
Come along, chat to Yoshi  
and the Vertex Crew!

# G&C COMMUNICATIONS

Authorised dealer for • YAESU • Icom • Kenwood • Barrett RFDS • GME Electrophone • Uniden

See us for CAR Stereo too! - 'Cranbourne Car Sound'

## YAESU

### Visit G&C Communications For the Yaesu Open Day

VX 150 2m H/Held  
Special Buy  
Only \$249!



Saturday December 9  
9am to 1pm

Free!

FT 2000



FTDX 9000



Free Vertex watch  
with any Yaesu HF  
transceiver purchase\*



Free Yaesu cap with  
any Yaesu handheld  
transceiver purchase\*



Free Vertex T-Shirt  
with any Yaesu mobile  
transceiver purchase\*

See the new FT 2000 and  
the FTDX 9000 in the metal!

**Come in for great specials  
on our full range!**

**Food and beverage available  
for purchase next door.**



on all Yaesu gear

207 High St. Cranbourne VIC 3977  
Ph: 03 5996 3298 Fax: 03 5995 0184

\*While stocks last.

Email: [gccomm@bigpond.net.au](mailto:gccomm@bigpond.net.au)  
[www.gccomm.com.au](http://www.gccomm.com.au)

Proudly Supporting Australian Business

Fig 9 and the actual balun is shown in Fig 10.

The plot in Fig 11 is restricted at the low frequency end as the transformer is usually used to feed a Yagi beam antenna.

**Baluns using toroids**

**4:1 Balun**

The bifilar pairs are all held together by PVC sleeving (Fig 13b) and the interconnections are correctly phased as shown in Fig 12. The input (low impedance) connection is on the left in Fig 13a.

The plot in Fig 14 shows an unacceptable SWR below 5 MHz for both 50:200 and 75:300. This indicates insufficient inductance in the winding causing unwanted loading at the low frequency end. The remedy is to increase the turns or use a higher permeability core. Fig 15 shows the result when using the same size core made from #43 ferrite ( $\mu$  800), but only using 2 x 8 bifilar turns. I have included this plot only to show how the different ferrite improves the low frequency SWR and is not a recommendation to use #43 ferrite in high power baluns. The result of increasing from 8 to 12 bifilar turns per winding is shown in Fig 16 and is the recommended solution.

Fig 17 shows the SWR response of a 4:1 balun using a large FT-240-61 toroid core.

**Power ratings**

All these baluns have been tested with resistive (ideal) loads whereas practical use means that loads are not ideal and will affect power capabilities.

Under normal operation the baluns shown here should all be able to handle 600 W of peak power.

The baluns shown in Figs 11 and 17 could operate up to 1 kW.

**Conclusion**

These baluns are easily made from materials readily available in Australia. The characteristic impedance ( $Z_0$ ) of the bifilar line is important in getting good matching and is determined by the wire size and spacing material. Most amateurs will be more interested in the 50 ohm plots than the 75, but I have included both to give some idea of the difference in SWR vs. frequency for a given winding when it is terminated in 50 and 75 ohm resistances.

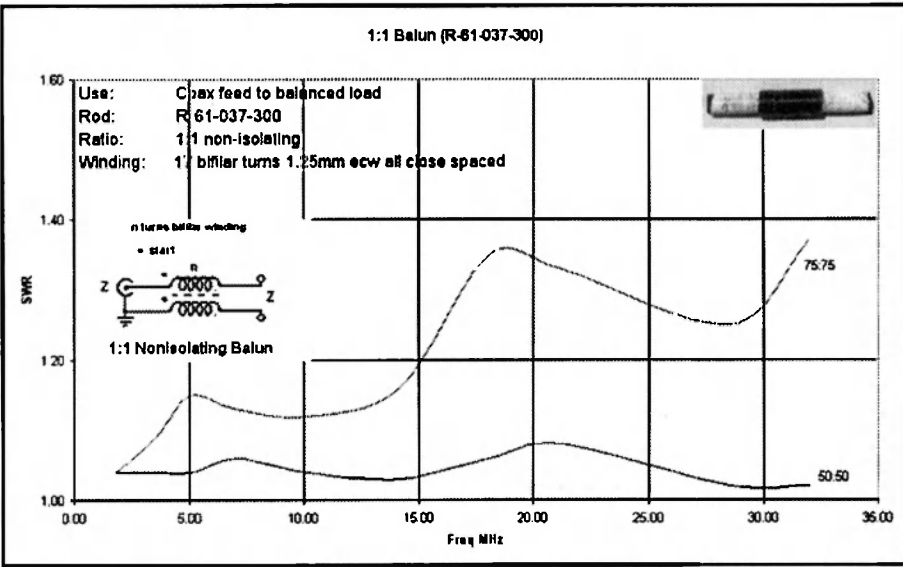

Fig 7 - Plot for all close wound

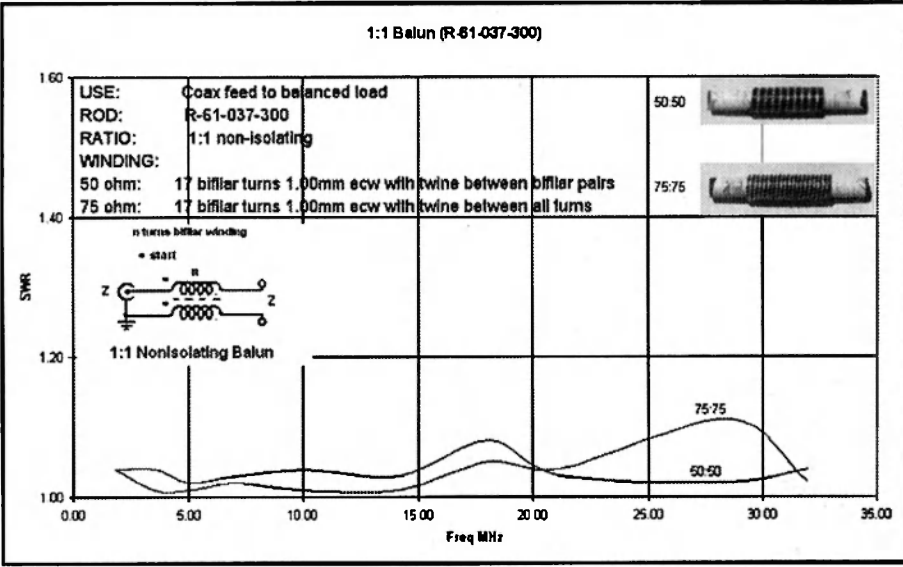

Fig 8 - Plot. Same turns, same rod, but with spacing twine between some or all turns

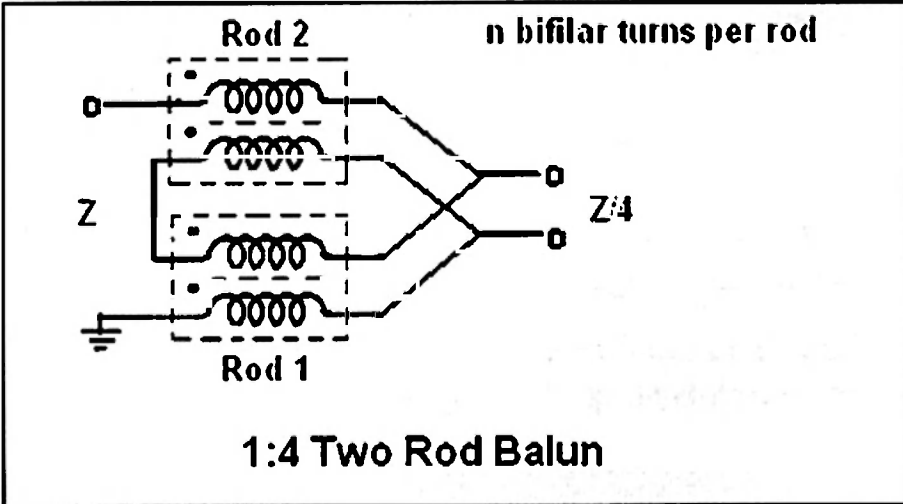

Fig 9 - Two rod balun schematic



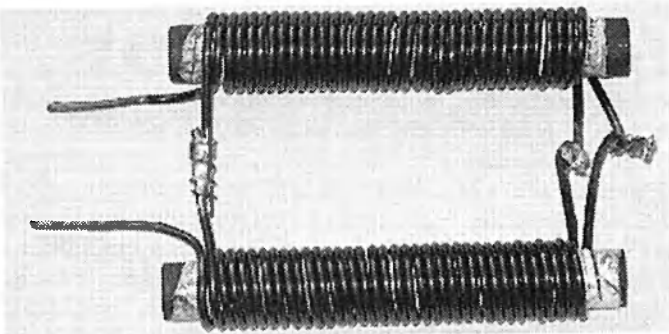

Fig 10 Two rod balun

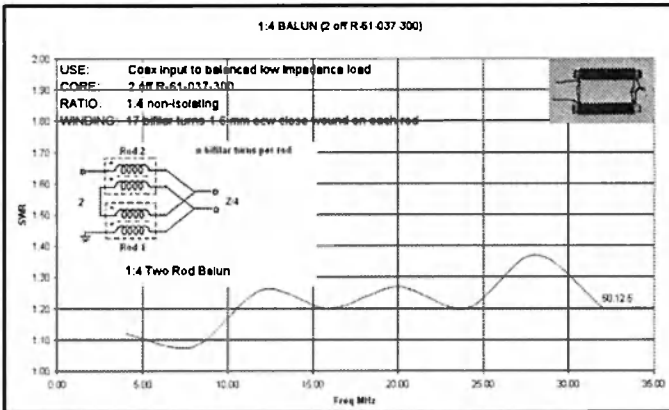

Fig 11

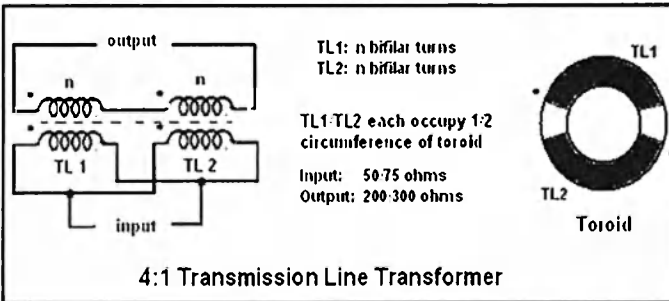

Fig 12

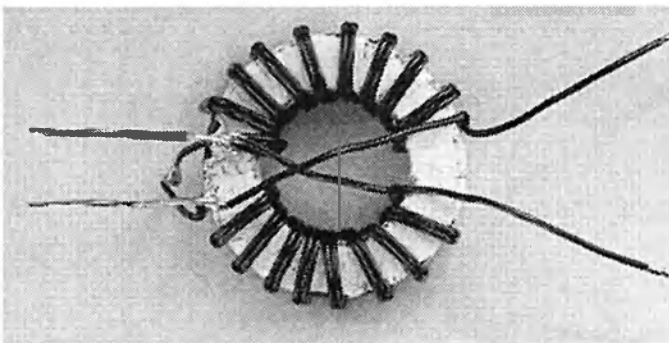

Fig 13a

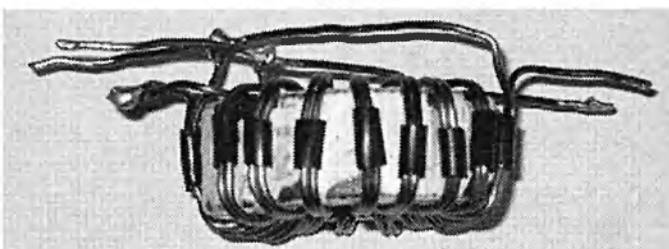

Fig 13b

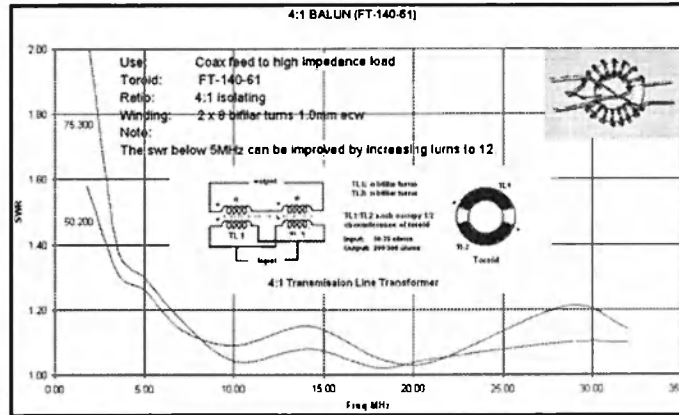

Fig 14

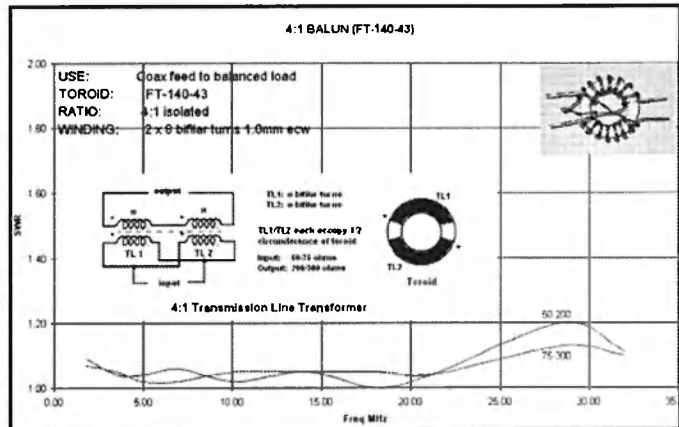

Fig 15

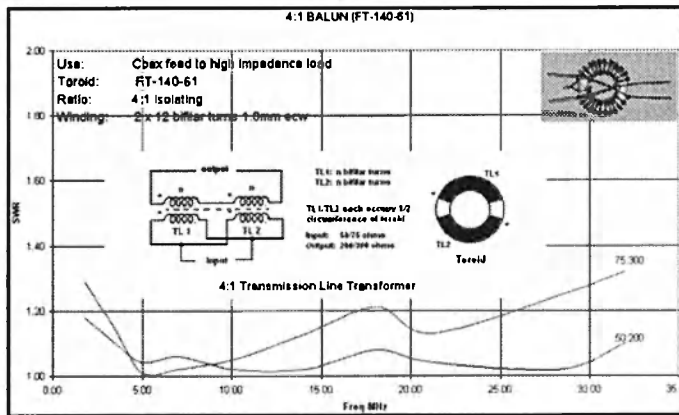

Fig 16

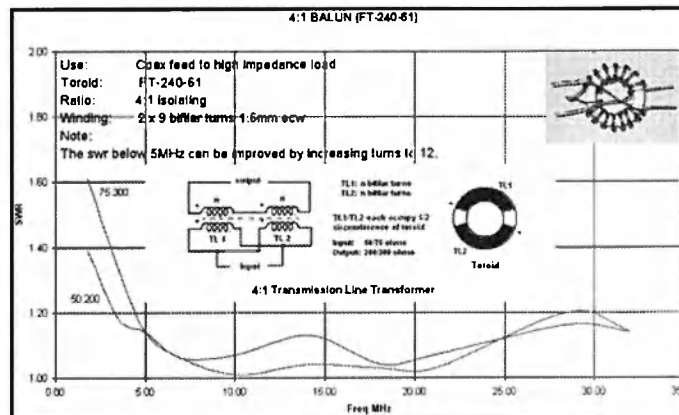

Fig 17

# A 4-125 Linear Amplifier for 160 m

## Part 2 – construction

Drew Diamond VK3XU

The first part of this article appeared in the October 2006 edition of *Amateur Radio*

In order to keep harmonics “at home”, an amplifier of this class must be fully enclosed in an RF-tight box.

The all aluminium home-made chassis/cabinet assembly shown in Photo 1 (p12 Oct AR) measures 410 x 315 x 230 mm WDH, and was constructed very much along the lines of that suggested in Reference 11.

Six 12 mm square-section aluminium rods, which support the front and rear panels, are end drilled and tapped to accommodate 5/32” Whitworth or 5 mm countersunk screws. Additionally, a 12 mm square aluminium rod supports the chassis at a height of 90 mm along the front and rear panels (Photo 2).

The panels and the chassis are made from 3 mm aluminium sheet, which results in a rigid construction. Top, side and bottom covers are made from 1.3 mm perforated aluminium sheet.

According to References 4 and 8, valves that have a metal skirt base should be mounted at chassis level, so that they may ventilate properly by air movement from beneath the base (which exits the holes provided in the valve’s skirt).

“All-glass” valves, like the QB3/300 and RSI007, should be mounted below chassis using suitable spacers (as in the prototype) with the internal ground ring at chassis level, and with sufficient clearance for air to circulate up past the valve’s envelope (Eimac 4-125s were tested in the prototype model by fitting extension prongs to each valve pin). Install fibre washers each side of the mounting screw-holes to prevent cracking the ceramic socket.

The above chassis view in Photo 3 shows a suggested layout for the major components. HT transformer T3 creates a fair amount of leaked magnetic flux. To avoid de-magnetizing the front-panel-mounted moving-coil meters, the transformer should be mounted well towards the rear of the chassis. The top cover must clear the valve top connectors

by a good margin - at least 20 mm is suggested.

For HT transformer T3, find a discarded microwave oven - the bigger (often brown) appliances from the 1980s ordinarily have larger transformers of about 450 to 500 VA. The (usual) 2 kV winding has one side grounded to core. However, the insulation is almost always of a high standard, and so the winding wire may be carefully lifted from the core, a new wire attached, and the connection and surrounding area siliconed, as described fully in Reference 5. When disassembling the appliance, save the HT wires and the special HV fuse (if fitted - sometimes hidden inside a length of spaghetti tube).

Altronics and Jaycar can supply a 160 VA toroidal transformer with two 18 V ac windings, which is ideal for T2. Using 1.9 mm enamelled copper wire (ecw), wind on 24 turns initially, with perhaps 300 mm

each end for spare. Carefully power the primary from 240 V ac, and measure the winding voltage, which should read about 5.2 or 5.4 V ac. If less than 5.2 V ac, wind on one or two more turns and test again. You will need a winding voltage just a tad over 5.0 to allow for drop along the wires that supply the heaters.

The toroidal transformer must be mounted with suitable insulating hardware such that the winding is adequately spaced from the chassis. Circular fibre or ABS plastic end washers are suggested. The transformer may be mounted upon the chassis with a ¼” Whitworth bolt and nut, as shown in Photo 2.

You can test the loaded voltage by applying the 5 V to your two socketed valve heaters; check that you have close to 5 V right at the valve pins. Note that each heater should be wired individually with 41/0.3mm insulated automotive wire to the 5 V winding (not “daisy-chained”).

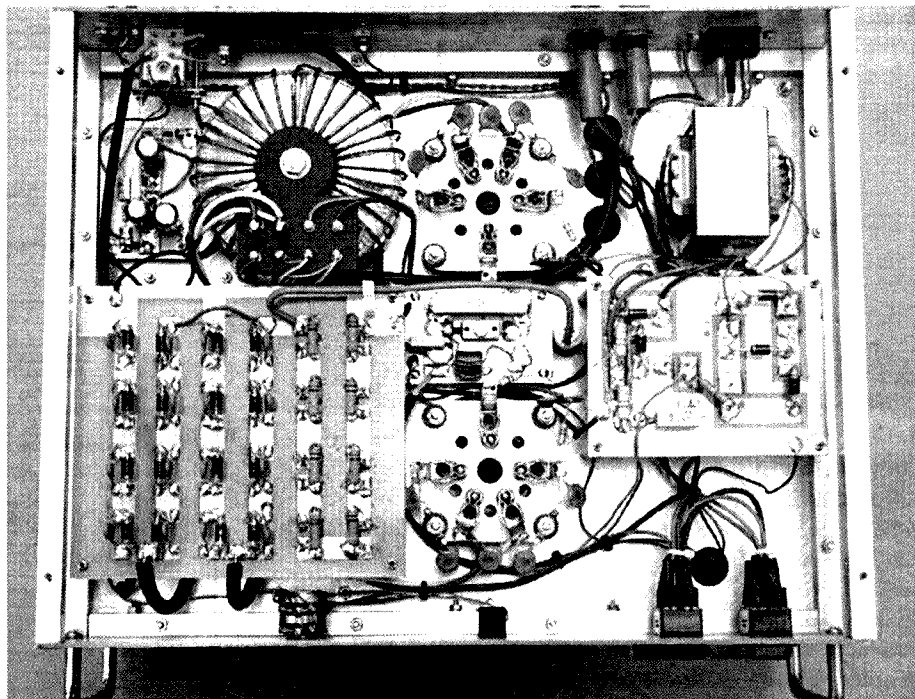

Photo 2 – Under chassis view of the 4-125 160 m linear amplifier.

Electrical centre for the centre tap (ct) may be found by hooking your ac voltmeter to one end of the winding, then, using a sharp pocket knife connected to the other meter lead, carefully nick into the ecw and locate the 2.6 V point.

The HT rectifier bridge, noise suppression capacitors, filter capacitors and bleeder resistors are accommodated upon a single-sided circuit board measuring 165 x 145 mm, visible in Photo 2. Holes are only needed for the pins of the 220  $\mu$ F capacitors, which are mounted on the fibre side of the board (not visible, but directly under each of the 100 k bleeder resistors on the RHS of the board).

Provide plenty of clearance around all components on the HT board. Diodes, 4.7 nF capacitors and bleeder resistors are all soldered directly to the copper side of the board, thus easing any future service work. Note the careful routing of the wire carrying the +2500 V across to the feed-through insulator that in turn takes the HT from below to above chassis.

The only "off-the-shelf" wire that I could readily find for connection between the 2 kV ac transformer and rectifier board (visible at the lower left hand side in Photo 2) turned out to be "ignition-wire", purchased from a local auto parts supplier.

Bias and screen supplies are accommodated on another separate 90 x 120 mm circuit board in a manner similar to the HT board. This circuit board is visible to the right in Photo 2, immediately beneath transformer T2.

The signal input transformer may consist of 12 turns of #22 (0.63 mm) ecw, or hook-up or telephone wire (which I prefer) for the secondary, and four interleaved turns of the same wire for the primary (that is, the primary is wound so that it fits between the turns of, and in about the middle of, the secondary winding).

The signal input components may be fitted upon a 'paddyboard' style 50 x 80 mm circuit board (Reference 12) positioned neatly on stand-offs between the valve sockets, as shown in Photo 2.

To keep losses to a minimum, the pi tank output coil should be mounted upon insulated posts and positioned reasonably clear of other objects (Reference 13). The 37  $\mu$ H coil consists of 32 turns of 1.9 mm ecw close-wound upon an 80 mm length of 50 mm inside diameter (marked "50 mm", but actually 55.5 mm outside diameter) white PVC pipe.

The output filter (Photo 4) may be accommodated 'paddyboard' style upon a circuit board measuring 120 x 50 mm. Take care winding the 1.9 mm ecw on to the T130-2 toroidal cores - they are rather brittle and may break if excessive force is applied. Use 500 V (or higher) mica capacitors. Ceramics can be used at a pinch, but they are rather lossy in RF filter applications (although fine for by-pass and coupling duties).

The voltage tripler for the relay may be a 50 x 70 mm circuit board assembly similar to that of the input circuit, and positioned near the relay (upper left hand corner, Photo 2). The relay itself (Jaycar P/N SY4065) may be positioned snugly between the coax input and output connectors (don't fall for the c/o contact pin-outs trap as I did - check!).

Plate top cap connectors were home-made from 16 mm diameter aluminium rod, axially bored to slide fit the cap. Some cooling of the valve plates occurs through the top caps, so they should have some heat radiating capacity. Mine are fixed to the connector with a grub-screw, which bears upon the side of the top cap to assure a good electrical connection.

The parasitic suppressor consists of three parallel 150 ohm, 3 W metal-film resistors fitted inside a four-turn coil of 1.9 tinned or ecw. They are connected to the top of the 1.1 mH plate choke with braid wire extracted from RG-58 coax.

The HV fuse and 22 ohm current limit resistor are mounted above chassis upon ceramic stand-off insulators.

The plate and grid current meters are each enclosed at the rear in a shield pot made from sheet copper, which in turn is grounded right there with solder lugs fitted under each meter mounting nut.

The Safety/dc return choke on the output side of the pi tank may be any well-made, pie wound radio frequency choke of about 2.5 mH. The dc resistance should measure less than 30 ohms.

Test its current handling ability by passing 1 amp from a power supply through the choke for a minute or so - it should not over-heat or fuse. Remember, should the pi coupling capacitor fail, we need to blow the fuse in the HT dc supply line.

During construction, the power supplies may be tested as they are completed. T1 may be fitted and the primary side wired. All connections should be insulated to prevent accidental contact, and fused as shown.

The heater winding may be tested as previously described. Check that the bias supply is working, and that it may be adjusted between (about) 100 and 120 V. Then T2 may be wired and the 500 V screen supply measured.

Take extra care when measuring the 500 V and 2500 V supplies. Connect your voltmeter test probe with all power

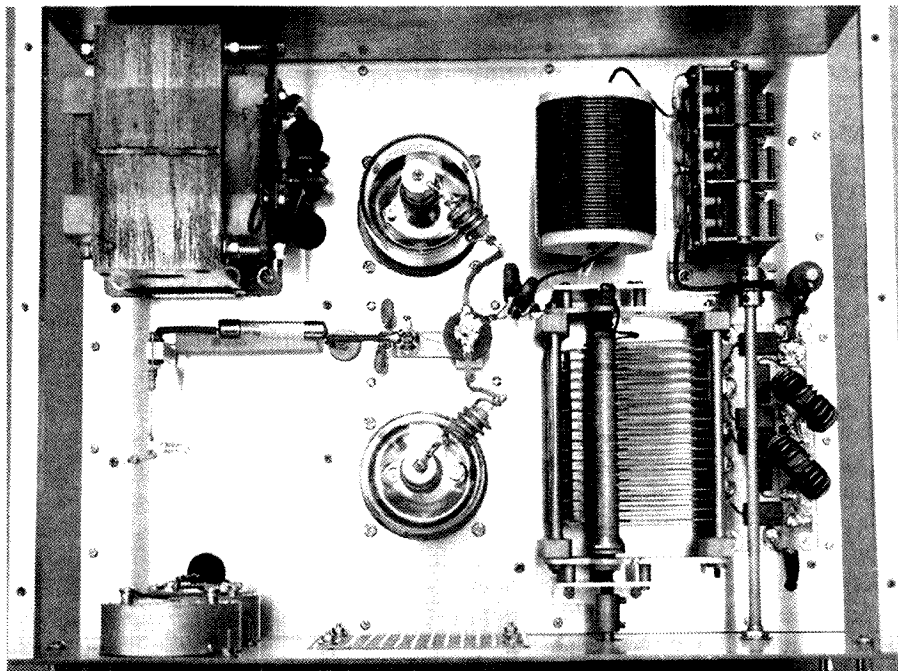

Photo 3 - Top view of the 4-125 160 m linear amplifier showing the layout of the major components.

removed, making sure that meter leads do not pass over or near other metal parts (2500 V would almost certainly "blast through" the insulation of ordinary test leads).

Adopt a strict "hands-off" policy when measuring the HT voltage.

It is suggested that you power-up the HT supply initially with a 100 W, 240 V lamp in series with the primary of T3 (as described in Reference 5) to check for any faults before applying "full" mains to T3.

On switch-on, the lamp will briefly glow brightly, then fade to about half brilliance, thereby indicating that all is probably well.

## Operation

It is first necessary to establish the amplifier's input impedance at 50 ohms by adjustment of the compression trim capacitor. No mains primary power need be applied but the valves should be installed. Connect the exciter (transceiver, or low power transmitter) to the amplifier input using short lengths of 50 ohm cable. Insert a sensitive SWR meter between. Using an external dc power supply, feed 12 V to the relay coil (observe polarity).

Now apply a 5 W, 1.850 MHz carrier signal to the input, and adjust the trim capacitor for minimum SWR. It should be possible to reduce it to a very low value. If not, find out why. Alternatively, if you have access to an antenna analyser or similar instrument, then you will know what to do.

Connect a suitably rated dummy load/power meter to the amplifier's output. Also connect an oscilloscope (of sufficient bandwidth) to the output using a through-line coupler (Reference 14). The PTT line from the transceiver must be correctly connected (relay is operated by pulling the PTT line to ground).

Set the 'Bias' pot for maximum voltage. With no input signal applied (receive mode), power-up the amplifier, heaters only at first. Note that there should be little or no plate current indicated. When the heaters have warmed up (about 10 seconds), apply HT. Adjust the Bias pot for a no-signal standing plate current of about 25 mA.

Set the output 'Tune' capacitor at about 2/3<sup>rd</sup> mesh, and 'Load' at about half mesh. Switch to transmit, and observe about 120 mA plate current. Quickly adjust 'Tune' for maximum output. You should have about 100 W output power indicated.

Briefly increase the drive carrier signal to about 20 W, then promptly re-adjust Tune and Load for maximum output, which should be about 400 W. Plate current will be about 250 mA. Driving up to about 2 or 3 mA of grid current (AB2) does not appear to cause serious distortion.

Without re-adjusting Tune and Load, drop the carrier back to 5 W input, then apply a 100% modulated AM signal of known good quality (by switching HT off, the exciter's signal is routed around the amplifier, and may thus be viewed directly).

Observe that the peak voltage level doubles (representing 400 W PEP), and should have nice text-book bullet-shaped peaks and well-defined troughs, indicating that the amplifier is working in a linear manner.

If the valves are not graphite plate types (eg 4-125s), they may glow dull red at the 100 W output carrier level. This is to be expected, as overall efficiency (at that level) is only about 45% (which accords with other similar published patterns). Of course, efficiency is much higher at full output.

You may observe a faint blue glow upon the inside glass envelope. This indicates a good "hard" valve.

Moreover, for brand new valves, you may find, as I did, that power output increases a smidgen after several hours

"burn-in". Conversely, tired valves with low emission may not deliver full 400 W PEP output.

## Parts

Mention has been made of two local electronics vendors who can supply the ordinary components, such as low-voltage power transformers, resistors, capacitors, 1 kV/3 A diodes, neon-illuminated rocker power switches, 12 V relay (Jaycar P/N SY4065), etc. Additionally, the HV ceramic capacitors for the HT power supply, and the heater/screen by-passing, were ordered from Altronics.

Electronic World (tel. 03 9723 3860) supplied the 2.2 nF/6 kV and 1 nF/15 kV ceramic capacitors, 3 W metal film (mf) resistors, 220  $\mu$ F/400 V electrolytic caps (\$2 each at writing) and 15 k/5 W wire-wound resistor.

The 1.9 mm ecw for the 5 V ac heater winding, pi tank coil, parasitic chokes and filter coils may be purchased from "magnet wire" suppliers and/or "transformer manufacturers" - see your local Yellow Pages.

The more "difficult" parts were mail-ordered from Surplus Sales of Nebraska ([www.surplussales.com](http://www.surplussales.com)), including ceramic sockets for 4-125s; P/N TUA-122-275 (used, but like new) and a National 5-pie plate choke, P/N ICH-R-154.

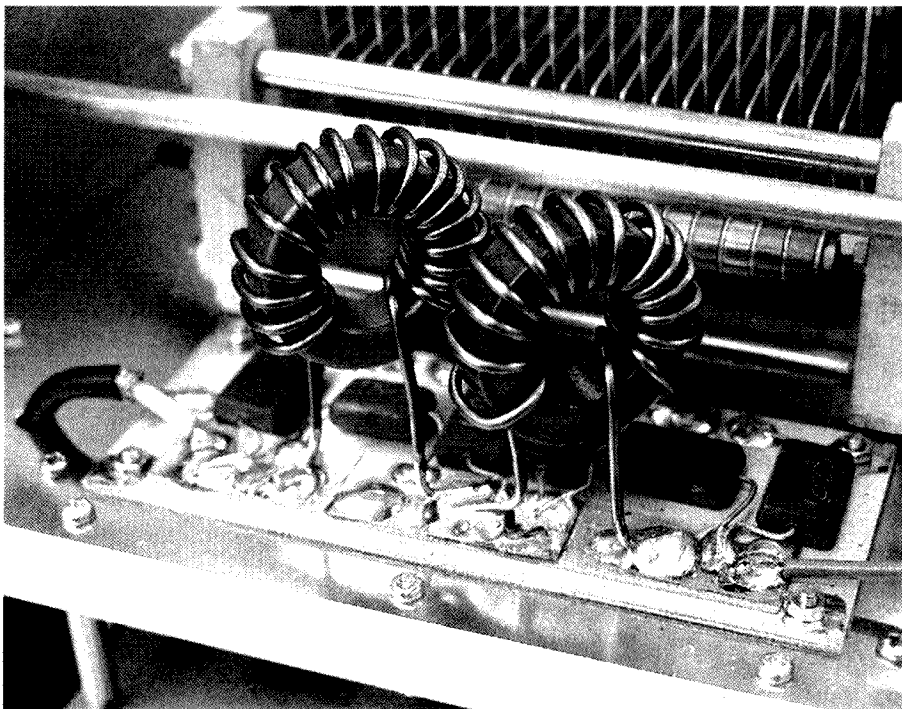

Photo 4 - The output filter constructed 'paddyboard' style upon a circuit board.

The 500 V mica, HV ceramic, 150 pF mica compression and three-gang variable capacitors may be mail-ordered from Antique Electronic Supply ([www.tubesandmore.com](http://www.tubesandmore.com)).

My AWA 350 pF variable capacitor was obtained at a local ham-fest. I have seen plenty of these, or similar units, at local swap-meets, and something like it should not be difficult to find. Plate spacing must be at least 1.5 mm, and maximum capacitance must be at least 300 pF.

The loading capacitor may be any well-made broadcast receiver type three-gang with a capacity of 400 or 500 pF per section. Before installing, check that no grit or other matter is caught between the plates. Clean and lubricate as necessary.

The T130-2 toroidal cores for the low-pass filter are obtainable from any of the Amidon stockists - see Hamads in *Amateur Radio* for your local supplier.

The high-voltage (5 kV) 600 mA, fuses - P/N MWF60 (intended for microwave ovens) - may be ordered from Wes Components, tel 02 9797 9866.

## Acknowledgment

My thanks to the friendly 160 metre fraternity (too many to name, but they will know who they are) for their technical advice, loans of valves, and gifts of parts.

## References and Further Reading

4. *Care and Feeding of Power Grid Tubes*; Varian Publication, 3<sup>rd</sup> edition., 1978.
5. "Re-using Microwave Oven Transformers for HV Supplies"; *Amateur Radio*, March 2006.
8. *Radio Handbook*; Wm Orr, W6SAI, Sams, 23<sup>rd</sup> edition and recent previous editions.
11. "From Circuit to Chassis"; *Amateur Radio*, December 2000.
12. "Paddyboard" Circuit Construction - Revised"; *Amateur Radio*, May 2005.
13. "Notes on HF Transmitting Coils"; *Amateur Radio*, September 2005.
14. "An Oscilloscope in the Shack"; *Amateur Radio*, September 2003.

**Photographs:** Andrew Diamond (photos may be viewed in greater detail on Andrew's web site at:

[www.andrewdiamond.net](http://www.andrewdiamond.net) - click on "gallery", then "technical").

# Barry Whittle VK3FBDW, Number 1,000

Robert Broomhead VK3KRB

**The 1,000th person to have his qualification for an Amateur Operators Certificate of Proficiency (Foundation) certified by the WIA Exam Service to enable him to obtain a Foundation licence is Barry Whittle of Gembrook, Victoria.**

The fact that Barry happens to be the 1,000th person to have his qualification certified is, of course, very much a matter of chance.

But how he became a radio amateur is not.

Barry is a 38 year old mechanical engineer, with a 16 year old son. He says he has been interested in radio since he was 16, and operated on the CB frequencies over many years. Some of his friends were licensed amateurs, and they told him what was required to obtain a Novice licence. From this Barry had a perception that a Novice licence would be far too hard.

Then, earlier this year, Barry was visiting amateur radio retailer and AR advertiser G & C Communications in Cranbourne and was looking at the amateur equipment on display. Craig of G & C told him that it was now very much easier to get a first amateur licence, and so he heard about the Foundation licence.

He purchased a copy of the WIA's 'Your Entry Into Amateur Radio', the Foundation Licence Manual from G & C, read it, decided it didn't look too hard, and decided to take it further.

He telephoned the WIA national office, and was told that his nearest club conducting training courses was the Healesville Amateur Radio Group, and was given the telephone number of the club's contact person, Brian Andrews VK3YBJ, the club president. Brian put Barry into contact with Steve Tregear VK3TSR, the club's Group Leader and a WIA Assessor, who told him that the club was going to conduct a weekend training course in a couple of weeks and invited him to join it.

Previous courses at the club had



WIA President Michael Owen VK3KI presents Barry Whittle VK3FBDW with his certificate

been conducted under the supervision of Fred Swainston, the WIA's RTO and a professional in every way. This course was conducted by Steve with the club's other WIA Assessor and trainer, Ken Taylor VK3TKQ assisted by club President Brian.

Barry describes the course this way; "I found the whole experience interesting and the instructors were more than patient the way they delivered the course and the class all passed on the Sunday."

Before he had even received his new callsign, VK3FBDW, Barry had started the upgrade course being conducted by the Healesville Amateur Radio Group, a 10 week course of 3 hours a week.

WIA Director Robert Broomhead VK3KRB and WIA President Michael Owen VK3KI joined Steve, Ken and Brian at the Healesville Amateur Radio Group's rooms behind the Telstra Exchange in Healesville on 17 October 2006 to meet Barry and, on behalf of the WIA, to present him with a certificate and a copy of the ARRL Handbook.

ar

ar

# OzGear

www.OzGear.com.au

Radio Communications & Electronics  
Ozhelp Services Pty Ltd T/as Ozgear

Suppliers of radiocommunications,  
electronics and computer products  
and electronic test equipment

**Ph 07 3114 2506**

**sales@ozgear.com.au**  
**Brisbane QLD**

Manager: Doug Hunter VK4ADC

**WE HAVE MOVED!**

**Unit 2**

**139 Beenleigh Rd**  
**Acacia Ridge 4110**

**Ozgear yagi antennas**  
**for 6m, 2m and 70cm**  
**now available**

**ICOM &**  
**YAESU**

**Australian-sourced radios with**  
**Australian-based manufacturer**  
**warranties**

Authorised Aust Icom and Yaesu dealer

Antenna, cable, interface, tuner and  
general accessory products from...

Amidon, Andrews USA, Austek,  
Benelec, Bushcomm, Comet, Dalwa,  
Diamond, Garland, GeoSensory, GME,  
Icom, Kingray, LDG, Lutron, Mobile  
One, RFI, Sangean SSGC, TET-Emtron,  
Tigertronics, Yaesu, ZCG Scalar plus  
ARRL and RSGB publications

**ALTRONICS**

Many products stocked

**Product & pricing info?**

Phone, email or visit us on the web at

**www.OzGear.com.au**

for the latest info plus on-line ordering. Our latest  
price list can be downloaded at any time

Payment?



## Silent key

### June Fox

#### The voice heard by most WIA members

Brenda Edmonds VK3KT

June Fox was a significant part of the WIA for many years.

With her passing, we have lost a valuable resource, a lot of knowledge, and an ambassador.

She joined the WIA as a bookkeeper in July 1987 and did a fine job of managing the books and finances.

Later, as she assumed responsibility for the functioning of the office, she was the voice at the end of the phone to the many queries, complaints, and appeals that came from all over Australia and sometimes overseas. Few of our members would have met June 'in the flesh' but many would recognise her voice.

June was always cheerful and efficient, and quick to suggest a further approach if she was not able to satisfy at the outset. She had the rare ability of being able to break off what she was doing, attend to one or more phone calls, and then return to the original task without losing the place. Her ability to find a sought reference, phone number or note was legendary.

On many occasions, her work did not stop when she left the office. Work was taken home when the pressure was on, or she came in on a weekend to ensure that arrangements were completed for some event.

The change to the structure of the WIA came at a time when her health was starting to cause problems, but she wholeheartedly embraced the changes and did all that she could to make it a success. She worked hard to make the lot

of her replacement as easy as possible, and was available on request for advice or explanations.

June was a very private person. She talked little of her personal life, her pleasures or problems, but was always interested in the persons around her and the more distant members of the WIA.

When June retired the esteem in which she was held was evidenced by the sum subscribed by members and clubs to help her realise her dream of returning briefly to Darwin. It was a trip very much enjoyed.

The photo was taken at her well-attended retirement party in July 2005.

The WIA extends its condolences to her daughter Lauretta (who on occasions also has been a member of the WIA team) and her brother Earle Russell VK3BER.

Vale June. It was a pleasure to know and work with you.



# WICEN Tasmania (South) tries a new approach for the 2006 Safari Tasmania

Roger Nichols VK7ARN  
WICEN Coordinator Tasmania (South)

The southern Tasmania WICEN group provides results communications for the Tasmanian round of the Australian Rally Championship. Competitor car numbers and times are sent by voice from Special Stage Start and Finish controls back to Rally Command. This year, we successfully trialled APRS tracking of a Course Car, co-habiting the APRS packet traffic with phone traffic on the same network.

For the past three years, the Subaru Safari Tasmania has been held over two days in the Southern Forests around Geeveston in the Huon Valley region.

The topography is rugged with valleys and ridges predominantly at right angles to the path between the rally Special Stages and Command in Geeveston. Stations vary in elevation between 40 and 500 metres (see Fig 1).

Heat 1 is run in the southern of two areas. Heat 2 is mainly in the north, but with one long stage in the south.

Two VHF repeaters were used each day. One, operating above 150 MHz, situated on Bruny Island at a low elevation, took advantage of available paths down the river valleys and across the D'Entrecasteaux Channel, a distance of 20 to 30 kilometres. The return path was up the Huon River estuary (see Fig 2).

The second VHF repeater, on 2 m, had separate locations for Heats 1 and 2. Both sites were at elevations of approximately 600 metres to reach over the ridges to Geeveston. Initially this repeater was cross-band linked into a UHF repeater to Rally Command.

It was sited in a fire tower on a hilltop above the town, but suffered interference from a pager transmitter at the same location. The link proved to be redundant; and better than adequate results were achieved with direct comms between Rally Command and the field repeater.

The link and UHF repeater remained in place, providing access to the system by handheld radio and a "chat" facility around town after hours. All field station sites had been surveyed and, in the main, adequate communication was possible with vehicle mounted whip antennae.

Portable masts were used at the hill top repeater sites and some station sites on Stages, where desirable.



Figure 1 - Looking over the rally ground. Photo John VK7ZZ



Figure 2 - The Huon River Estuary. Photo John VK7ZZ

Over the two days, twenty stations were operated, plus Command and repeaters. 38 WICEN personnel were deployed.

Other nets included Rally Command, utilising three permanent, linked, mid-band VHF Forestry repeaters. Course Cars were on two linked Huon Council mid-band repeaters and emergency services on the mid-band Fire network. Each stage had its own net utilising Targa Tasmania mid-band radios and portable repeaters.

In addition, a UHF 'SkyNet' system with airborne repeaters tracked and timed competition cars as they passed Starts, SOS points and Flying Finishes. The primary role of the WICEN network was to give a reliable back up to the weather and multiple-component-dependant 'SkyNet' system.

The WICEN system again proved to be totally reliable throughout. The odd need for adjustment was dealt with on the run with no interruption to services.

This year's event also provided an opportunity for the APRS enthusiasts to play with their favourite toys! The Clerk of the Course was sold the idea of tracking the "Zero" car, the passing of which is the go ahead for competition to start on each Stage. Rally time management is critical and the whereabouts of the "Zero" car plays a major part in decision making.

The problems faced included topography, hard enough to reach the start and end of each stage, let alone all points between, RF congestion and limited hardware availability. The concept of cohabiting APRS packet and voice traffic on the same network was promoted by repeater enthusiast Brian VK7BW. Working with the group's APRS specialist Scott VK7HSE, various approaches were explored, trialed and fine-tuned.

The "Zero" car was equipped with a Laipac G10-1 "mouse" GPS receiver, Byonics TinyTrack3 and Phillips PRM8010.

Because the car travels at competition speed and is subject to full competition safety requirements, the unit was enclosed in a foam-padded box and securely mounted in the car boot. The fitting of the boot lid quarter wave antenna and roof mounted magnetic base GPS unit was also given special attention with a liberal application of "racing tape".

Unfortunately, although the unit was well tested prior to fitting, there was little time between installation and "Go". On the Stages, the car crew wear helmets



Figure 3 - VK7BW with his Icom IC-FR3000 Repeater. Photo Andrew VK7HAW

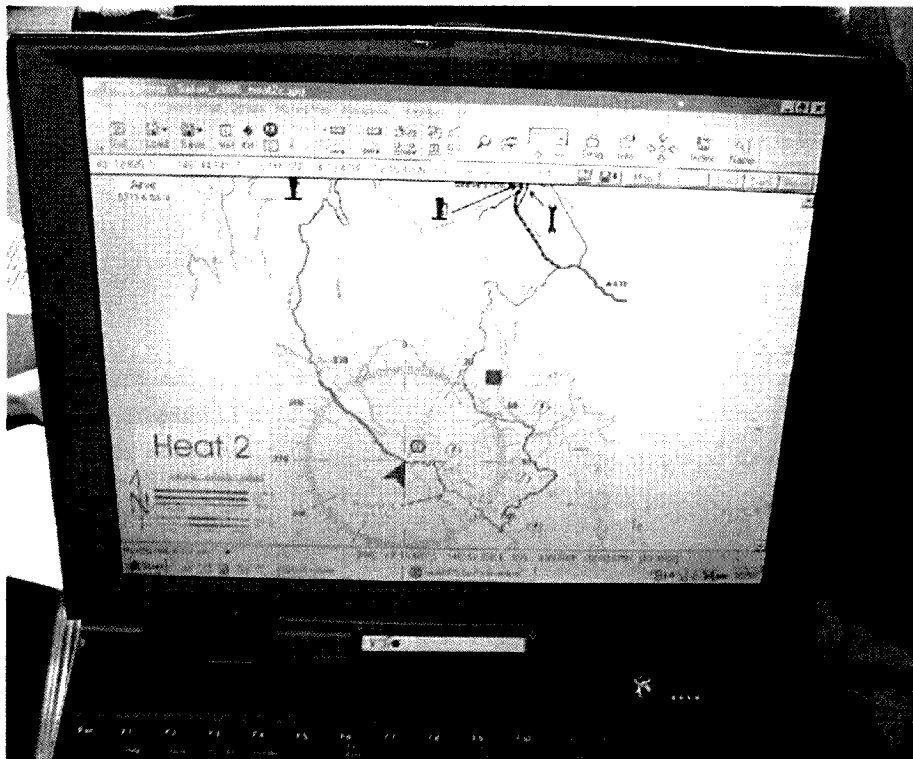

Figure 4 - Monitoring at Heat 2 Digipeater. Photo Roger VK7ARN

with inbuilt intercom units connected by 'curly cord'. They were plagued by packet squawks!

Ferrite sleeves were not available locally and the guys did a terrific job to put up with it for the two days.

The hill top repeater was a 50 W Icom IC-FR3000, capable of CTCSS driven channel sharing operation. Both voice and APRS packet operated on Rx 147.950

MHz and Tx 146.150 MHz. Voice traffic was allocated CTCSS 151.4 Hz and packet 173.8 Hz to avoid audible interference.

The TinyTrack was configured to give priority to voice traffic by requiring a three second break in carrier modulation before transmitting. Smart beaconing was enabled with a slow speed rate of 10 minutes, to minimise packet transmissions whilst the Zero was waiting at a Start line, rising to



a fast rate of 15 seconds at 70 kph. The TinyTrack configuration is shown in Fig 5.

Back at Rally Command, a GST3 antenna fed a Yaesu FT-5200 dual band radio and a PK-232MBX TNC. UI-View ran on a PC with a flat panel display showing the Special Stages and transport roads.

Given the limited infrastructure and competition for air time, coverage was reasonable. On Heat 2, with the long southern stage remote from the repeater in use, a digipeater was established at the Heat 1 repeater site, transmitting on a separate 144.700 MHz frequency.

Local monitoring showed an almost 100% stage APRS coverage (see Fig 4). After competing with voice traffic, approximately 80% of the telemetry made it though to Command.

The main concern from the start of the project was packet interference to voice traffic. This system configuration had the desired result and it was not an issue during the event, leaving the way open for further developments ready for next year.



Figure 6 - Roger VK7ARN's new mobile tower. He is now working on the Mk II version following an incident at Big W's underground car park. Photo John VK7ZZ

ar

Primary		Secondary	
Callsign: ZERO			
Digi Path: WIDE3-3			
Symbol: > Table / Overlay: /			
Timing			
Auto TX Delay: 1000 milliseconds		Auto Transmit Rate: 10 seconds	
Manual TX Delay: 1000 milliseconds		Manual Transmit Rate: 30 seconds	
Quiet Time: 2998 milliseconds		Calibration: 128	
Status			
Text: de VK7HSE			
Send every: 10		<input type="checkbox"/> Send Separate	
Configure			
COM1		Read Configuration	
Read Version		Write Configuration	
Tone Test			
Send 1200 Hz		Send Both	
Send 2200 Hz		Stop Sending	
Save		Load	
Exit		www.byonics.com	

Figure 5 - TinyTrack Configuration.

# Two Australian ATV records in three days!

Dan Joyce VK2GG

**After starting the gas stove with a spark from jumper leads,.....rain cleared enough for P3/P4 pictures to be received over the 194 km path,**

The saga had a number of different but related facets!

After a gestation period of the usual nine months, the plan was completed, and the journey began. It was a complicated plan, involving the record attempt on a weekend, followed by a journey by all concerned to Lismore to take part in the ARISS contact by the Tevan-Tintenbar School.

The ARISS schedule eventually presented by NASA made the details of the plan very tight indeed! However, we proceeded, intending to utilise the week between the record attempt and the ISS schedule for surveying of future ATV sites.

Jack VK2TRF had taken possession of some WR-90 waveguides with flanges that very week, so Dan VK2GG took out his hack saws and files, and had a penny feed ready to go in less than half an hour - with a genuine Australian penny!

After pizzas and a bottle of wine, followed by an early night, Jack and Dan travelled north to Dorrigo with the not-very-promising weather forecast of rain for the whole weekend.

The weather in Dorrigo was cold, with occasional showers, but the pub provided a ham-friendly motel room, albeit basic. The meals and other consumables provided by the pub were also quite acceptable!

The first day of the record attempt was windy and wet. The day began quite early, with Jack adjusting the Terlin Outbacker for 80 m, for the "Stone the Crows" net on 3.588 kHz at 6.00 am. We were at a very quiet HF location, and finally managed to be heard by Ted VK2UI at Raymond Terrace, and by Allan VK3ASB who was mobile on his way to an Air Show at Temora.

By about 12.00 pm, VK2TRF and VK2GG had managed to get themselves lost in an (absent) farmer's paddock looking for a site near Ebor, and were at least an hour from the scheduled ATV



Photo 1 - Garry VK2UNI with 10 GHz dishes.

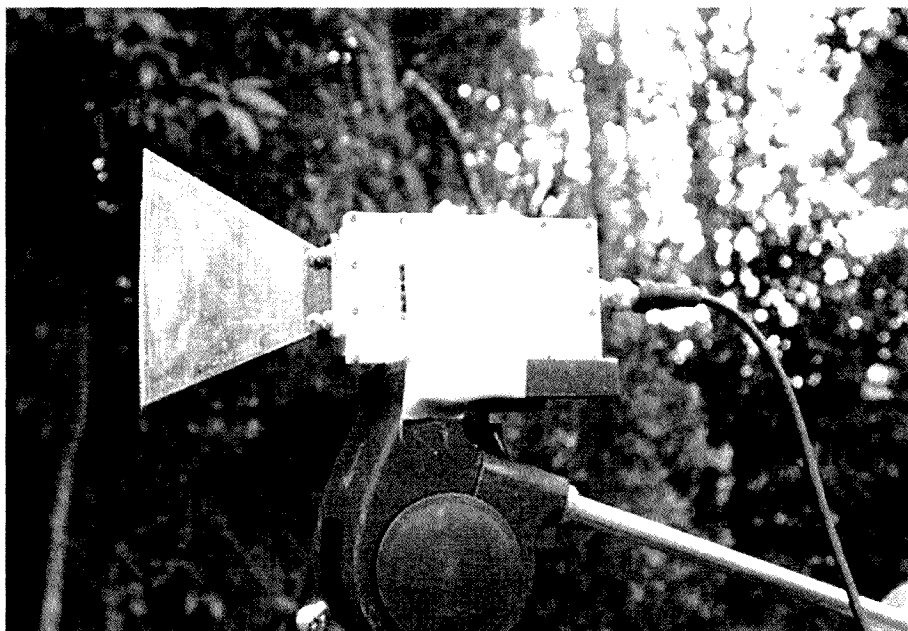

Photo 2 - Jack VK2TRF's receiving 10 GHz horn.

spot. Of course, we had the GPS and trusty laptop displaying moving map!

Finally, nearly an hour later, we were able to erect a serviceable shelter at the lookout near Ebor, west of Dorrigo, under which dishes were set up for both 2.4

GHz and 10 GHz. We then settled down to await Nick's domestic duties (of soccer, etc) to be completed, and for him to set up the Mt Nardi end of the link.

After starting the gas stove with a spark

from jumper leads, we enjoyed soup, coffee and then heard Nick VK2ZTY SIMPLEX on 70 cm as he set up (195 km away!). This HAD to be a ripper path, and so it was on 2.4 GHz, with lovely P5 pictures from Nick firing through some small sapling trees in the rain!

Note Jack's test card with callsign for ID written by hand on the back window of his Range Rover! 10 GHz was not at all a goer, not surprisingly; obviously 10 GHz does not like rain! The return 2.4 GHz video was also P5, and we achieved the record of 194 km at 3.30 pm. Whew! What a day!

Now came the convoluted part of the programme!

Nick was unavailable for weekday ATV playing, so Jack VK2TRF drove solo to Lismore, as there was better weather being forecast for later in the week. Meanwhile, Dan VK2GG waited in Dorrigo while Garry VK2UNI drove up from Wingham in Dan's truck.

The plan was for a further attempt at 10 GHz on the Monday, from the same location near Ebor. The weather in Dorrigo remained fine and sunny nearly all day, while Dan and Garry waited for Jack to survey a likely spot north of Mr Nardi.

This proved unsuitable, and Jack then proceeded up the slippery slopes of Mt Nardi, near Lismore. Comments such as the melting state of the "Tim Tams", and the impending sunburned state of both

Garry VK2UNI and Dan VK2GG were not greeted with much enthusiasm by Jack VK2TRF! Some people just have no sense of humour!

Luckily, the rain cleared enough for P3/P4 pictures to be received over the 194 km path, with a small horn at Jack's end, and a combination of 60 cm and 1.2 m dishes at Dan's end. What a thrill! 200 mW over nearly 200 km! Imagine what we can achieve with dishes at each end! Congratulations and thanks to Jack VK2TRF, Nick VK2ZTY, and Garry VK2UNI.

### Equipment details:

**2.4 GHz:**  
G1MFG exciters with ex-commercial 30 W PAs at both ends; 24db Gridpack antennas; and G1MFG receivers with home-brewed signal strength meters.

**10 GHz:**  
G1MFG 2400 MHz exciters with Khune MKU 10X (4 x multipliers); G1MFG 23 cm receivers with 9 GHz LO LNBS; MA-86551 X-Band Horn with 17dB gain; Kuhne 1 W amp at one end; and 60 cm/1.2 m parabolic dishes with penny feed at the other end.

A packet of Tim-Tams (or is that a carton?) is on offer to anyone who can point out elevated sites which exceed 200 km apart, and which UKW Tools say is LOS.

## FEATURE TECH



**AT3000**  
Automatic Tuner  
1.8-30MHz, 200W

Smart Tuning No need for control cable  
Rapid Tuning 2s fist tune, 0.5s memorized

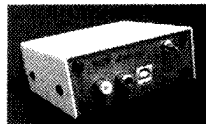

**USB Link-All**

Fully Isolated  
Radio-PC Interface

Connecting rig to PC soundcard  
USB port to control PTT and frequency

### Pocket Frequency Counter

Frequency Range:

10Hz ~ 50MHz

1MHz ~ 2.6GHz

Stability: 1ppm (VCXO)

Battery: Rechargeable Li-Ion



For More Products Visit:

<http://featuretech.co.nz>

Ph: 64-9-630 5078 Fax: 64-9-630 5038

Email: [sales@featuretech.co.nz](mailto:sales@featuretech.co.nz)

Featuretech Limited

**"Hey, Old  
Timer..."**

If you have been  
licensed for *more  
than 25 years* you  
are invited to join



the  
**Radio Amateurs  
Old Timers Club  
Australia**

or if you have been licensed for *less than  
25 but more than ten years*, you are invited  
to become an Associate Member of the  
RAOTC.

In either case a \$5.00 joining fee plus \$8.00  
for one year or \$15.00 for two years gets you  
two interesting OTN Journals a year plus  
good fellowship.

Write to  
RAOTC,  
PO Box 107  
Mentone VIC 3194

or call Arthur VK3VQ on 03 9598 4262 or  
Bill VK3BR on 03 9584 9512,  
email to [raotc@raotc.org.au](mailto:raotc@raotc.org.au)  
for an application form.

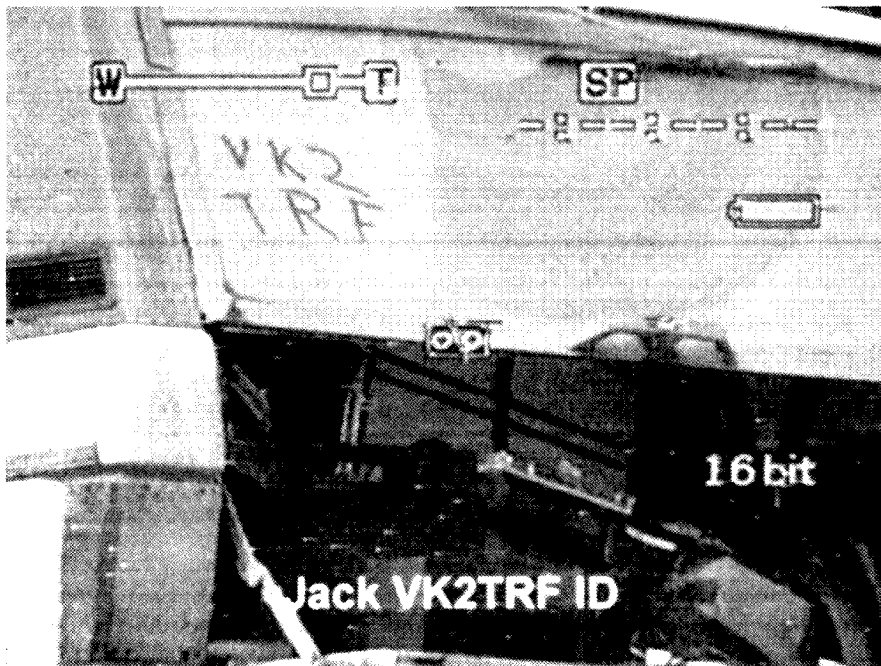

Photo 3 - Jack VK2TRF's test card with callsign for ID written by hand on the back window of his Range Rover!

# A Vertical Whip for a Caravan

Ian Cowan VK1BG

On a previous occasion, I have written about the portable G5RV antenna that I have carried around the country for HF operation from my caravan. Well, the trusty G5RV has now been pensioned off and in its place I use the four metre base loaded whip that is the subject of this article.

The G5RV was a very good antenna for general field work, but it did depend on there being some conveniently placed trees around for supports, and it was sometimes a bit messy to put up. These factors make it less than ideal for a one-night-stand. To simplify matters, I decided to see what I could get out of a simple loaded vertical that could be clipped to the roof of my pop-top van, using the van roof as the ground plane.

There are numerous whips designed for mobile use available commercially and, indeed, I have a set of Hustler whips with loading coils for 80, 40, and 20 metres. These seem to work well when working against the van roof, but the fact that the loading coils become warm after a few minutes of operation shows that the efficiency of antennas such as these could be better. And it is certainly harder to get a

contact with the Hustler than it is with the G5RV. While I was ready to try a vertical in lieu of the G5RV, I did not want to sacrifice too much ERP along the way.

Unfortunately, this is a big ask. There are several factors that are working against efficiency in a short vertical antenna. The first is the very low radiation resistance of such antennas. This represents the radiating component of the antenna, and is the one into which we need to deliver as much transmitter power as possible. Typically, the radiation resistance is below one ohm for short antennas on 80 metres.

The second factor is the loss in matching the radiation resistance to the 50 ohm output of our transceivers. This is done using a loading coil somewhere along the radiator, usually with a few other components as well. Ideally, the effective

resistance of the coil should be small compared with the radiation resistance of the whip, but the ideal is unattainable at or below 80 metres because the coil has to be large and hence effective loss resistances above an ohm are almost inevitable.

The third adverse factor is ground resistance. This, too, is almost inevitably more than one ohm, though my ARRL Antenna Handbook suggests that the effective value of ground resistance falls as the height of the base of the antenna is raised. On my caravan, the antenna base is about three metres above ground, somewhat higher than in most mobiles. There are other lesser losses such as matching network losses also affecting efficiency but these are of less importance than those above. In summary, the unwanted loss resistances can be several times greater than the radiation resistance, especially on 80 metres.

## TET-EMTRON Antenna Manufacturers

### New Tet-Emtron Vertical Range TEV-4      TEV-3      TEV-3Warc

#### New Tet-Emtron Vertical Range Features

- All Aluminium with Stainless steel hardware.
- No adjustment needed to main antenna.
- Light.
- Free standing-no guy wires.
- 1 kW PEP power rating.
- Can be ground mounted or elevated.

The new TET-Emtron Vertical range is designed with ease of use in mind. Tuning is done by the radials when the antenna is in its final position (where possible). The radials can either lay on the ground, be buried or hang from the elevated antenna. The antenna comes with a set of radials that has a resonate radial for each band. Further sets can be ordered from TET-Emtron if desired. See the web site for more info and a complete dealer list.

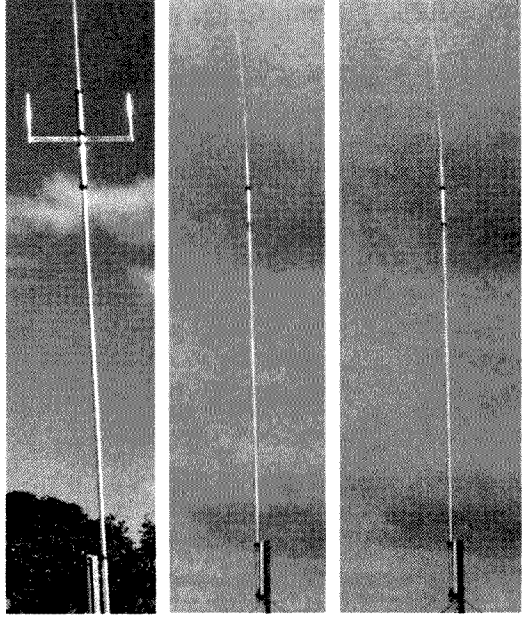

40 Blackburn Street  
STRATFORD  
Victoria 3862 AUSTRALIA  
www.tet-emtron.com  
Email: rawmar@hotmail.net.au

Ph: 61 3 5145 6179  
Fox: 61 3 5145 6821  
ABN: 87404541761

Antenna	TEV-4	TEV-3	TEV-3 Warc
FREQUENCY	7, 14, 21, 28 MHz	14, 21, 28 MHz	10, 18, 24 MHz
ELEMENT HEIGHT	4090 mm	3800 mm	5025 mm
FEED IMPEDANCE	50 ohm	50 ohm	50 ohm
Max. RADIAL LENGTH	10.7 metres	5 metres	7.5 metres
SWR	1.5 or less	1.5 or less	1.5 or less
POWER RATING	1 kW	1 kW	1 kW

The upshot of all this, according to the ARRL Handbook, is that the best efficiency I can expect in the 80 metre band is about 15%, and 45% on 40 metres. However, a well designed antenna should be about 8 dB better than an ordinary mobile whip on 80 metres, and this is worth the effort (mind you, it will still be, at best, about 8 dB below the G5RV!). On 40 metres and above, the situation is much better.

## Evolution

My requirement is for an antenna which is quick to erect at a fixed portable location and which can be used on the HF bands between about 3.5 and 21 MHz. A vertical radiator somewhat longer than the usual mobile whip would be desirable. I chose four metres as being reasonable in terms of it being manageable and of being not too sensitive to winds. On a whip this long, centre loading did not seem practical, so I settled on base loading as the best option. The loading coil would have to be of high quality (i.e. have a high Q factor) to minimise losses, and this means large.

Obviously, the 80 metre band would require the greatest base loading inductance to bring the whip to resonance. I consulted an old Basic A program on my PC, and found that the coil would have to be of about 50  $\mu$ H. It so happened that I had a pretty large roller inductor on the shelf. This coil uses a 75 mm ribbed ceramic former. It is wound with 27 turns of 2 mm silver plated wire, with a winding length of about 95 mm. Unfortunately, the total inductance works out to be about 30  $\mu$ H. I determined to use this coil anyway,

and gave it a thorough clean up, and mounted it in an Acrylic box I made for the purpose.

The coil is rotated by means of a shaft which passes through the bottom of the box, and on which I have mounted a mechanical counter to show the position of the pick up on the inductor as the coil is rotated. I think the coil would have a Q (quality factor) better than 400, and this would imply a loss resistance of less than 3 ohms on 80 metres - just acceptable!

I decided to use a shunt capacitor directly across the coil to artificially increase the effective coil inductance to the 50  $\mu$ H required for 80 metres. It might have been possible to install a top hat at the top of the whip to achieve the desired effect, but I ruled this option out on mechanical grounds - ie the whip is too flimsy. Again I consulted the old computer program, and found that a capacitance of about 27 pF placed directly across the inductor would be needed to make it look like 50  $\mu$ H. A high voltage capacitor would be required as the voltage across the coil on transmit could be several kilovolts. Sitting on the same shelf as the roller inductor was a 30 pF wide spaced variable transmitting capacitor, so I decided to use that. This also saved having to fiddle up a switch to disconnect the capacitor on the bands above 80 metres, as the coil can manage alone on these bands.

At this stage I have a four metre whip with a loading network which can resonate the whip on any frequency in the desired range. The next problem to solve is matching to the 50 ohm coax connecting the transceiver to the antenna. Here, my 1990 ARRL Handbook came to

# Australian made ANTENNAS Setting a new standard COM-AN-TENA

(formerly a j and j coman)

115 John Street  
GLENROY 3046

23 cm 36 ele slot fed Yagi beam	\$190
2 ele delta loop 10/11 metre	\$249
2 ele quad 10/11 metre	\$249
10/11 beams comp opt 5 ele	\$327
10/11 5/8 vert 4 rad 1/4 wave	\$185
Tri band IIB 35 C 10/15/20 m	\$745
3 ele 20 m comp opt	\$460
log periodic 9 ele 13 30 8.4 boom	\$990
MBV 6-12-15-17-20-40-80	\$390
40 m linear loaded 2 ele beam	\$595
M B Vert auto switch 10/80 m	\$330
6 m 7 ele Yagi beam 60 mm boom	\$387
6 m 5 ele comptr opt beam	\$275
Top loaded 160 m vert	\$430
10 ele high gain 2 m 3.9 m boom	\$149
17 ele high gain 70 cm 3m boom	\$129
Rotable dipole 40 m	\$250
80 m top loaded vertical	\$239
dual band 2 m & 70 vert	\$140

## Guyed Masts

**21 metres**                      **13 metres**  
Winch-up & tilt-over. Aluminium and stainless steel  
three-sided construction. Auto-brake winches.

## Free Standing Masts

9.5 metres

**New Baluns**  
1-1 to 16-1 to 3kW



Our Masts meet Australian Standards. We supply all the computations and data you will need for a permit.

**03 9773 3271**  
**Mob: 0419 542 437**

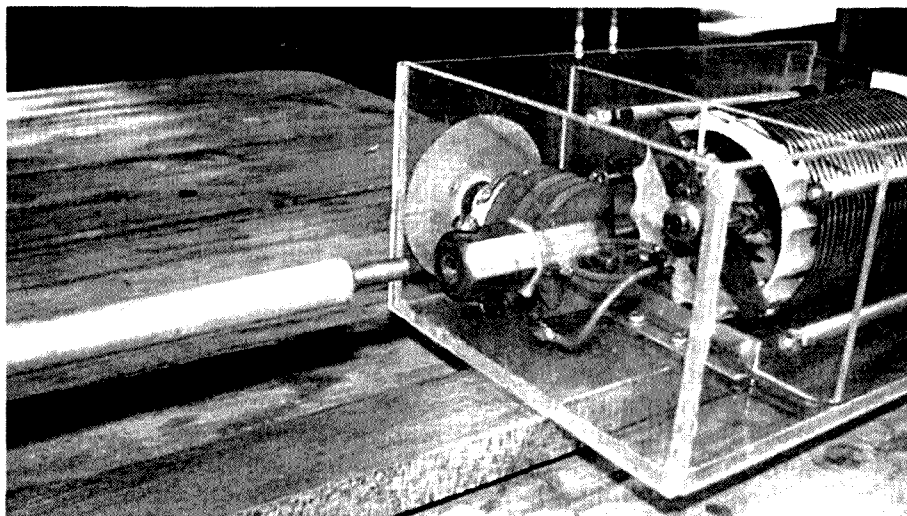

Photo 1 A front-on view of the acrylic box, shown lying on a table. The whip connects to the left hand end of the box as depicted.

the rescue. It suggested the use of an L match, which in this case boiled down to using a shunt capacitor across the input coax feedline.

By trial and error techniques I found the required values to be 1600 pF for the 80 metre band, and 400 pF for the 40 and 30 metre bands. For the higher bands above 30 metres, the SWR is well within the matching range of my FT897 transceiver, so no further shunts are necessary. These capacitors use silver mica blocks that I found in my junk box. There is nothing particularly onerous about their working conditions. The voltage across them is only about 50 volts, although the current through them is fairly high. Silver-mica capacitors are a good choice as they have low loss in the HF area.

## Construction

The circuit diagram at Fig 1 shows the electrical layout around the roller inductor. In fact, the circuit is that of a pi coupler. The common return is connected to the caravan roof by means of a hand-made catch which hooks over the hold-down clip on the caravan roof. This quick and simple connection has proved reliable so far, though every now and again I give the contact surfaces a bit of a clean with fine sand paper or steel wool just to be sure. SW1 is used to switch in the required matching capacitor at the input. It is an ordinary miniature toggle switch, single pole, double throw with centre off.

The photographs show aspects of the construction. The whole assembly is built on to a piece of nominal 2 x 1 inch timber about 1.5 metres long, properly painted for weather protection. A piece of 6 mm acrylic with a 13 mm hole in it sits at the top of the timber. This provides lateral support for the whip that would otherwise surely bend at the slightest provocation.

The roller inductor and associated circuits are housed in a box made from 6 mm acrylic sheet. This is a nice material to work and has good RF properties at HF. Joints in the box are made with the appropriate solvent cement which, along with the sheet, is available from plastics retailers. When set, the joints are very strong. The box assembly is designed to be weatherproof and has little effect on the Q of the inductor, wet or dry.

The whip has a 6 mm brass rod driven into it at the bottom, and this connects to the top of the coil box via a brass fitting which was once part of a valve radio tuning drum. The first photo is a front-on

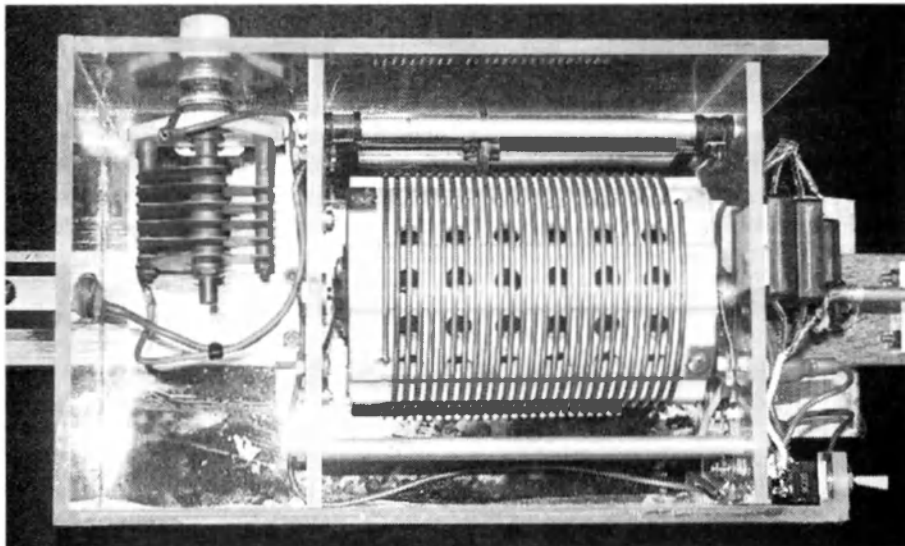

Photo 2 The underside of the box and showing the roller inductor drive shaft as it exits the box, the counter on the shaft, the input connector, and the input matching capacitors with their selector switch. It also shows the ground return wire for connection to the van roof.

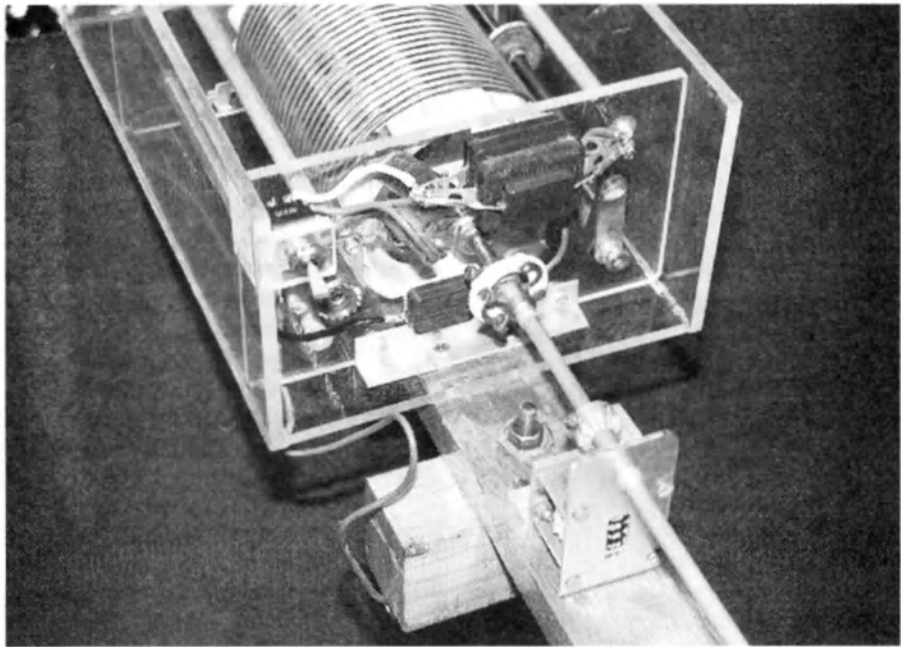

Photo 3 The brass fitting on the top of the acrylic box into which the whip is connected. As can be seen, the high voltage components are at the top of the box, and the lower voltage bits are at the bottom.

view of the acrylic box, shown lying on a table. The whip connects to the left hand end of the box as depicted.

The second photo details the underside of the box and shows the roller inductor drive shaft as it exits the box, the counter on the shaft, the input connector, and the input matching capacitors with their selector switch. It also shows the ground return wire for connection to the van roof.

Photo 3 details the brass fitting on the top of the acrylic box into which the

whip is connected. As can be seen, the high voltage components are at the top of the box, and the lower voltage bits are at the bottom.

Photo 4 details the control knob and dial for the HV coil shunt capacitor required for 80 metre operation. Once the correct position for this has been found it can be readily reset on subsequent occasion.

The whip itself is in two sections, joined using a sleeve of aluminium that is permanently secured to the bottom length of tubing using dimples from a centre pop

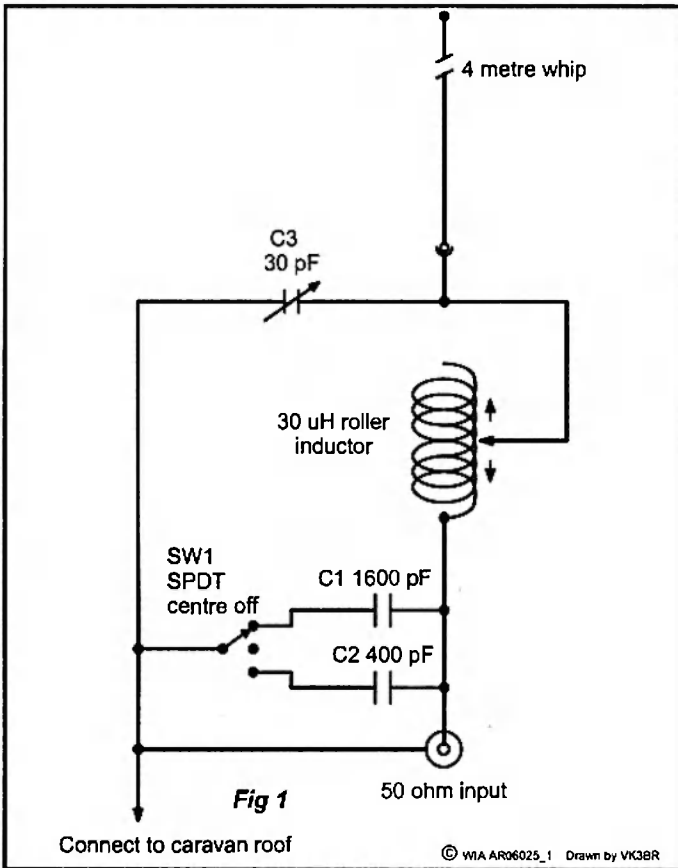

Fig 1 – Schematic of the antenna matching components.

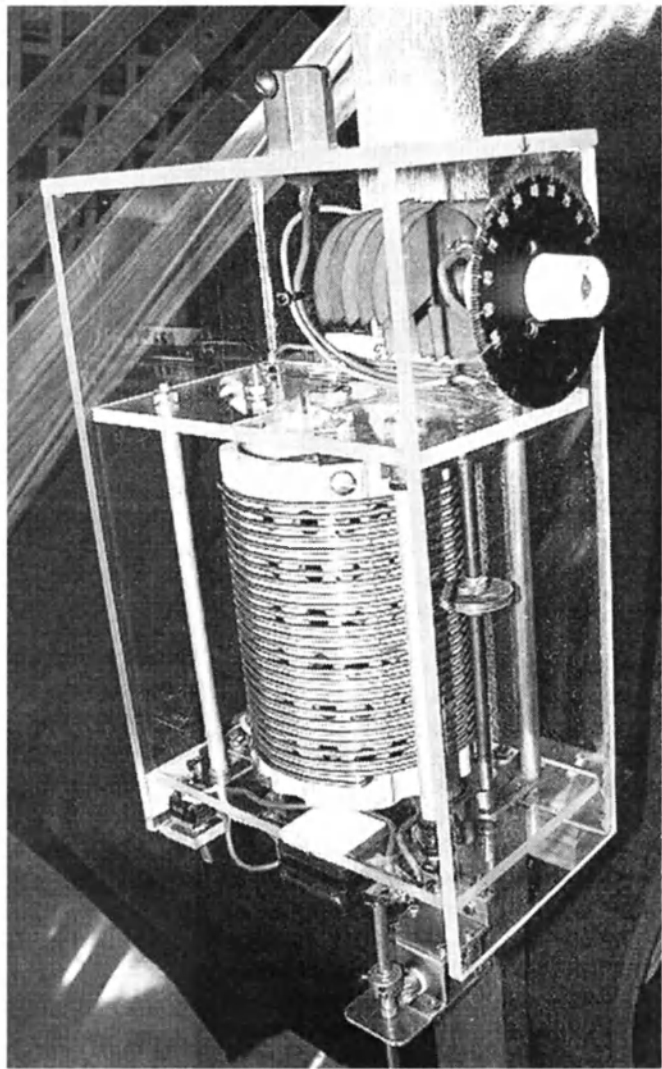

Photo 4 Details of the control knob and dial for the HV coil shunt capacitor which is required for 80 metre operation.

punch. The top section of tube slides into this sleeve, and is secured by a hose clamp that tightens over a longitudinal hacksaw cut in the top of the sleeve.

As the roller inductor assembly is about three metres above ground when the antenna is clipped to the van roof, it has a long drive shaft so it can be easily be rotated from ground level. This drive shaft has a crank handle at the user end. It also drives a mechanical cyclometer counter so the position of the inductor can also be monitored from the ground.

## Tuning

Tuning is very simple when the antenna is assembled and clipped to the caravan. I use an FT897 for HF portable work, and this has a handy 3.5 mm jack into which can be plugged a remote 0-1 milliamp meter. What the meter reads is software selectable, and I have set mine to mimic the S meter on receive, and the SWR indicator on transmit. I have the meter on a cable long enough to allow the meter to be taken outside the van.

The first move is to set C3, the high voltage variable capacitor that shunts the roller inductor. Above 80 metres, this is set to minimum capacity, but the first

time the antenna is used on 80 metres, the position has to be established by trial and error. This does not take long, and is only done once, when the position of the capacitor is noted for future reference.

Having set C3 according to the band in use, the input capacitor is set, also according to band - 1600 pF for 80 metres, 400 pF for 40/30 metres, and zero above that.

Initial tune is accomplished by rotating the inductor for highest noise in the receiver, as shown on the S meter. Then a low-level carrier is keyed on, and fine tuning is set by tweaking the roller inductor a little, one way or the other. SWR can be set by this means to quite low levels on all bands but, as I am a purist, I allow the automatic ATU in the FT897 to clean up any rough edges.

## Performance

I set out to produce a high efficiency portable antenna for my caravan. This goal seems to have been achieved, albeit at the cost of the mechanical complexity

and bulk of the roller inductor I used. On 40 metres and above, the antenna is reasonably efficient, and on 80 metres it is quite OK for local working.

The main drawback is the very narrow bandwidth of the antenna, especially on 80 metres. This is an unfortunate and inevitable consequence of designing a low loss short antenna. The antenna is not as convenient to use as a modern mobile whip with automatic ATU, but this is the price I am prepared to pay in pursuit of efficiency. I believe that my antenna will cut the mustard when most of the more modern automatic types will not. It is certainly not too far behind the trusty G5RV that it replaced and, unlike the G5RV, it can be used on 30 metres!

Finally, the antenna is almost entirely built from junk box components, so it cost almost nothing to build. Viva la junk box!

# A "sewer pipe" balun

Rob Gurr VK5RG

Over many years in amateur radio, I have used both coaxial cable and open wire line to feed the many antennas in use. Both have their advantages. However, the open line is most suitable to multi-band coverage. Feeding an open wire line into a radio room may be generally achieved without complication, and direct connection of the line to an Antenna Tuning Unit (ATU) can be made.

I once needed to bring such a feedline into a reinforced concrete building, where it was impossible to use open wire line and the use of coaxial cable appeared more appropriate.

An early method to overcome this challenge was to use two short lengths of coaxial cable, with the open wire line terminating on the coaxial cable inner conductors, outside the building, and connected to two coaxial sockets mounted on the ATU inside the building. The ATU was tuned up in the normally accepted method for balanced line, and operated quite efficiently.

When moving to my present home, it appeared that I may need to once again use the above method, due to the house construction. However; my attention was drawn by Phil Williams VK5NN to an article in Radio Communications for August 1992, where the use of one coaxial cable and a simple 4 to 1 balun

achieved the same purpose. The balun was wound on a piece of PVC sewer pipe, as may be obtained from a building site (with permission). This 4:1 balun was manufactured, tried on all bands from 3.5 MHz to 28 MHz, and loaned to friends and members of the Adelaide Hills Amateur Radio Society, with remarkable success.

The balun was also tested at full amateur power levels on these bands, without signs of overheating. The unit was mainly mounted on a fascia board or other fixture, outside the building, with a short length of coaxial cable (RG213) connecting to an ATU inside. The ATU in most cases was a standard "Z" Match.

While the balun has been used successfully on 1.8 MHz, no definitive tests have been conducted. Other methods of coupling may be more desirable on this band.

## Theory of operation

The impedance seen at the bottom of the feed-line, when using a centre-fed multi-band antenna (centre fed Zepp), may vary from very low to perhaps a few thousand ohms. The generally accepted output impedance from an ATU is 50 ohms, and as few ATUs are capable of performing over such a large range, it becomes convenient to reduce the upper

impedance requirement to a lower value. This can be done with a 4 to 1 impedance transformer. The coaxial cable may be either 50  $\Omega$  or 75  $\Omega$ , as its impedance is not important, but both windings must be the same.

The balun thus is performing a dual purpose - reducing the impedance range and also providing the required balance to unbalance function.

It is the purpose of this article to describe the use of the balun; the detailed theory of operation may be found in Reference 1 listed below.

## Circuit diagram

Fig 1 is a simple drawing of the balun. It consists of two, eight turn windings of coaxial cable laid up in opposite directions of lay. See Fig 2 of the complete balun for fine detail.

## Parts required.

- 190 mm long x 110 mm OD (100 mm ID) PVC sewer pipe former.
- 2 only 3.3 m lengths of 50  $\Omega$  or 75  $\Omega$  small diameter coaxial cable (typically RG58CU or UR67). Ensure the screen wire is copper, not aluminium.
- 1 only SO239 socket
- 2 only terminals for connection of the open wire feed-line.
- Quantity of fixing screws, instant glue, solder and suitable iron.
- 1 only 150 mm length of approximately 1.5 mm diameter bare/tinned copper wire.

## Construction

First determine the centre point on the former, drill holes and mount the coaxial socket, including washers and copper bonding wire as shown in Fig 3. Drill and fit the two line terminals, 15 mm apart, near the coaxial socket but on the other side of the socket to the two cable holes. Refer to Fig 2.

Near the coaxial cable socket, and in line with the outer edges, drill 2 x 5 mm diameter holes, approximately 30 mm apart.

Drill another two holes, in line, a further 50 mm away to allow for the eight turns of cable.

Insert one end of each of the two

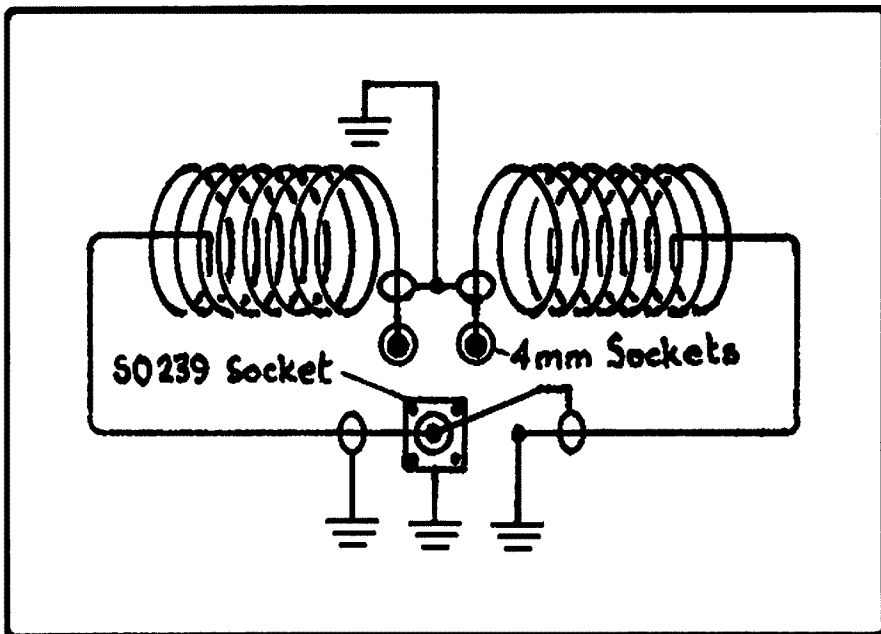

Fig 1 - Circuit of the balun.



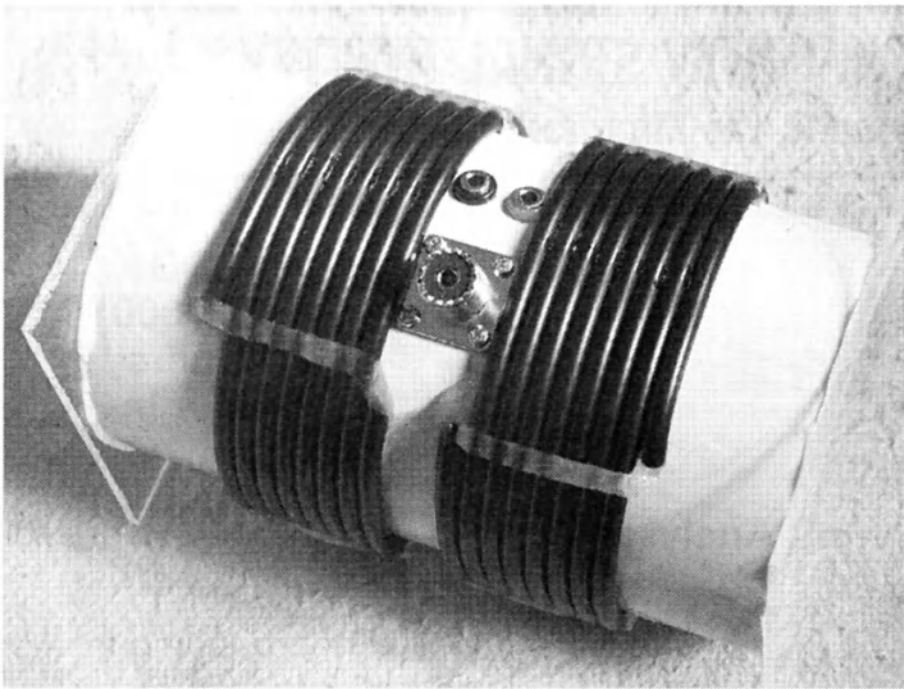

Fig 2 – External view of the balun.

### Mounting

One method that may be used is to screw or bolt the balun under the eaves of a house to give some water proofing, holding the former away from metal, etc with a couple of cotton reels. It is really your choice how to mount it, as long as the feed-line is clear from conducting material, and there is a drip loop to keep water away from the balun and coaxial cable, and prevent entry of the water to the building.

There is no problem mounting additional terminals on the end surface of the former, in parallel with the original, to allow the use of much wider spaced lines. The balun described was used with 300 ohm open wire line when constructed.

### References

1. Radiocommunication August 1992, Page 51 - RSGB
2. ARRL Antenna Handbook any edition, 1942 to 2006

#### Acknowledgements

1. Photography by Lyle Whyatt VK5ZNB.
2. Initial tests by VK5NN Phil Williams.
3. Adelaide Hills Amateur Radio Society for extensive testing of demonstration models.
4. Editing suggestions by Lyle Whyatt VK5ZNB and Jim Tregellas VK5JST.

ar

coaxial cables through the centre two holes. Terminate the inners to the two open wire line terminals, and the outers (braid) to the copper wire bonding ring around the socket.

Tightly wind eight turns of two coaxial cables, one in each outwards direction, and pull the two loose ends tightly through the end holes. These windings are now in opposite lay on the former.

Next while the windings are held secure, fix them with instant glue so they will not spring apart when the terminations on the socket are made.

The two outer ends of coaxial cable may now be terminated. Note from Fig 3, that the centre conductor of one cable end is terminated on the centre spigot of the coaxial connector, and the braid to the earthing ring. The centre conductor of the other cable end, is connected to the earthing ring, and the braid to the centre spigot

The balun is now complete.

Note that Fig 2 shows the balun with the ends sealed to keep unwanted life from making it their home.

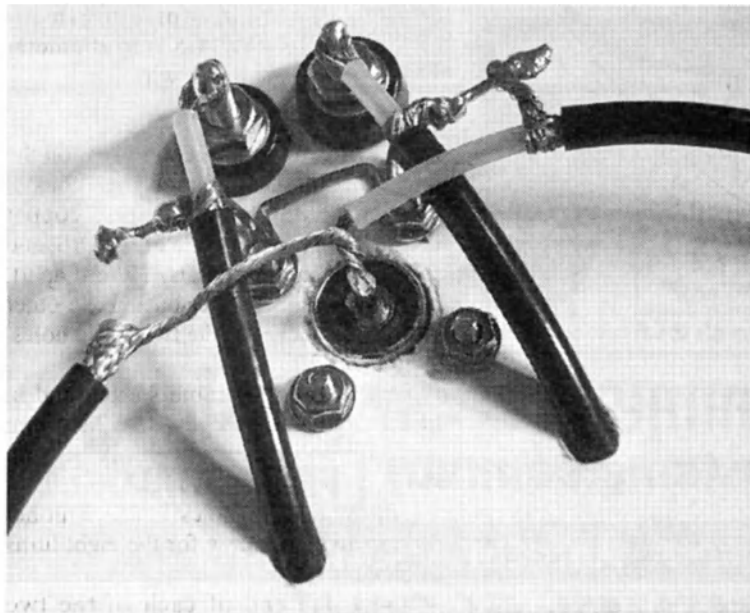
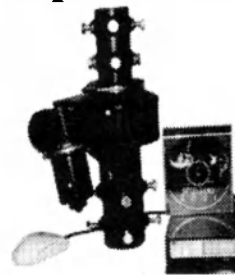

Fig 3 – Internal connections to the balun.

## OzSpid Rotators



Oceania - New Zealand - Australian Distributors.

Australian Enterprise Industrial

P.O. Box 1013

Browns Plains, QLD. 4118.

Ph. 0414 254 080.

Fax. 07 3800 8003.

[aitower@spin.net.au](mailto:aitower@spin.net.au)

# TEN-TEC'S MIGHTY SIGNAL HUNTERS

Led by Orion II, the Mightiest Hunter of all



**Model 566  
 Orion II**  
 Ultra High-End  
 HF Transceiver

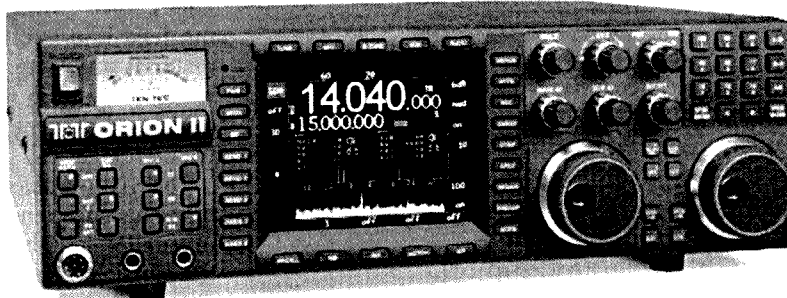

**LDG  
 AT 7000  
 Tuners  
 Now In  
 Stock**

## Model 6000 Vector Network Analyser

Turn your PC into a VNA

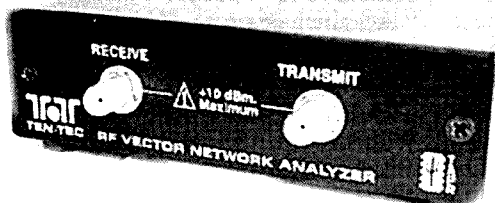

We now stock Diamond  
 Antennas & Accessories

### BUDDIPOLE

Dipole — vertical... Fits in travel bag! Optimised for transmit power, proven for DX work. Ultra light materials, High-Q coils. Zero-loss balun with Quick-Connect feedpoint.

Standard Comes with—

- Two 22" black aluminium arms.
- Two multi-band coils (40- 10m), adjustable coil tap pre-marked system
- Two SS telescopic whips, VersaTee™ w 3/8" x 24 adaptors
- BNC/PL259 coax connector, 25' of RG58 coax
- Carry bag

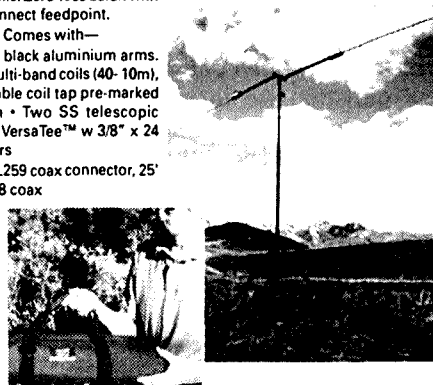

**Model 538 Jupiter**  
 An enduring favourite

Check us out  
 for  
 Solar Panels,  
 Regulators and  
 Deep Cycle  
 Batteries

## We also supply

- LDG DTS-4 & DTS-6 Coax Switches
- Amidon Iron Powder & Ferrite Coil Forms
- AUTEK WM1 Computing Power/VSWR Meter
- Buddipole Antennas
- Professional RF Cables and Connectors

**KITS**  
 for all  
 levels  
 of DIY  
 Amateur



See you all  
 at Miena on  
 December 2

**TTS Systems Communications Equipment**  
 www.ttssystems.com.au **FREE CATALOGUE**

**HF and VHF Transceivers, Autotuners and Kits**

Phone 03 5977 4808. Fax 03 5977 4801 [info@ttssystems.com.au](mailto:info@ttssystems.com.au)



# PALSTAR INC

## Now available in Australia

Palstar manufacture a range of amateur products of outstanding quality. Superbly engineered and robustly built in the USA

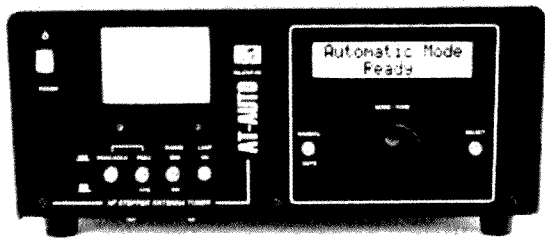

**AT-AUTO -- A 1500 WATT HF AUTOMATIC ANTENNA TUNER.**

A pair of stepping motors provide smooth control of a heavy-duty roller inductor and a 5KV split stator variable capacitor to form the heart of this superb ATU. No clunky relays rattling away in this one!

3 year warranty

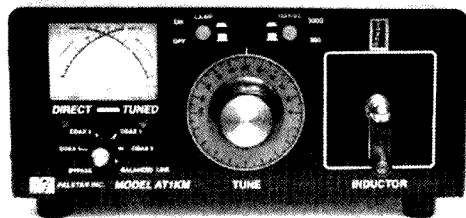

**AT1KM MANUAL ANTENNA TUNER**

A well designed HF tuner using a roller inductor and a split stator variable capacitor rated at 1200 watts PEP.

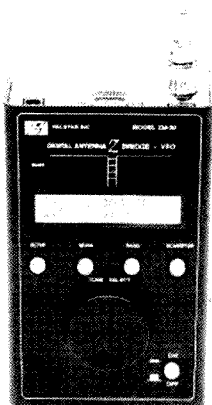

**ZM-30 ANTENNA ANALYSER**

A compact DDS (Direct Digital Synthesis) based antenna analyser. 1 to 30 MHz normalised for 50 ohms. The ZM-30 has some nice features not seen on other units.

3 year warranty

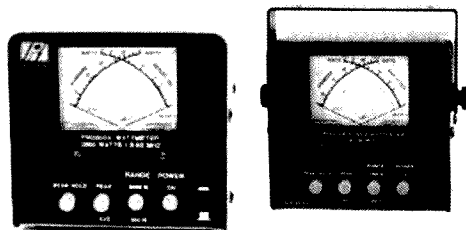

**PM2000A & PM2000AM WATT-METERS**

The PM2000A (Bench top) and the PM2000AM (Mobile/Portable) watt meters feature cross-needle meters, peak and peak hold with backlighting. Switchable power ranges are 300 and 3000 watts.

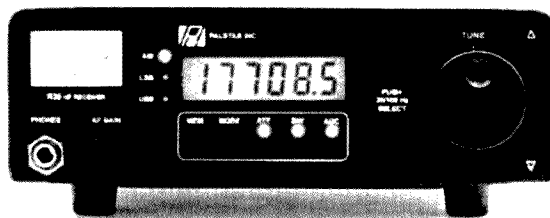

**R30C & R30CC SHORTWAVE RECEIVERS**

These high performance double conversion receivers tune 100KHz to 30MHz Modes USB, LSB and AM. Portable battery operation with compact size. The R30CC includes Collins torsional mode filters for AM and SSB. 3 year warranty

### OTHER PALSTAR PRODUCTS

Manual antenna tuners up to 3500 watts

1500 watt balanced antenna tuner

High power dummy loads – with and without metering

Low pass and high pass filters.

Active antenna

Roller inductors and variable capacitors

Turn counters for roller inductors

4kW baluns. Both 1:1 and 4:1



# TTS Systems Communications Equipment

[www.ttssystems.com.au](http://www.ttssystems.com.au)

**FREE CATALOGUE**

## HF and VHF Transceivers, Autotuners and Kits

Phone 03 5977 4808. Fax 03 5977 4801 [info@ttssystems.com.au](mailto:info@ttssystems.com.au)

## VK2

Tim VK2ZTM.

### Clubs

On Saturday 7th October, the Oxley Region ARC celebrated the 35th anniversary of their formation - in 1971. Like many clubs, Oxley Region was formed so that a repeater could be developed. Club members and invited guests assembled about noon for a chin wag and light lunch. A meeting was then convened with Vice President Bruce VK2HOT in the chair. Many apologies were noted, including that of President Alan VK2GD. Three surviving Foundation members were present and introduced to the gathering. They were Henry VK2ZHE, Arthur VK2ATM and Graeme VK2ZIS. The drawing of 'lucky numbers' then followed, until everybody in attendance had received a gift. Time was then devoted to conduct the monthly meeting and the formal event concluded with the cutting of the anniversary cake.

The WIA was represented by Director Phil VK2DKN and ARNSW by Councillor Brian VK2WBK. Many club members had worked behind the scene to prepare

for the day. Wendy, XYL of VK2ATM, produced a vast range of food for both the lunch and afternoon tea and in her spare time had assembled many display boards of photos and memorabilia about the Club over its 35 years.

The Oxley Region club has a regular newsletter - known as Oxtales - which was started in early 1980 by the late Lester VK2BFP. With a few other editors over the years, it has been produced for the last 16 years by Trevor VK2TT. The September 2006 issue was number 99 and all have now been reproduced in a PDF format on a CD, available from the club. Copies are \$5 collect or \$7 posted. Write to the Oxley Region Secretary at P.O. Box 712, Port Macquarie 2444.

Oxley Region hosts two repeater sites with 2 and 70 voice systems serving Port Macquarie and the Hastings Valley. Check out 6700, 7000 and 8525. The monthly meeting is on the first Saturday afternoon of the month, with informal gatherings on the second and fourth Friday evenings. If you are visiting the area there is a net on 6700, Sunday at 0830 and Wednesday at 1900 hours. They have been active in Foundation Licence assessment. A recent successful club member was Des from Lord Howe Island, who is now providing signals from the Island, as time permits. Look out for VK9FLHI. Several others have already upgraded from the Foundation.

### ARNSW

At the end of this month, Sunday the 26th, will be the final Trash and Treasure and Home Brew gathering for the year. Details will be in VK2WI news. With summer almost upon us, don't forget a hat and sunscreen. By early next year it is hoped that the new shed, with plenty of covered space, will provide shelter from the elements. The September event had a good range of ex-commercial equipment which had been made available by communication company Vertel. It included rack cabinets, cavity filters, transmitters and receivers and other items which form a communication facility. One station wagon was seen leaving with three cabinets, one inside and two on the roof

racks and all available space was filled with other purchases. Some equipment remained and will be available this month. Check out the ARNSW tender section on their web site [www.arnsw.org.au](http://www.arnsw.org.au).

As these notes were being prepared, the status of the proposed club gathering was not known, as many clubs were still to reply. Keep an ear on VK2WI news or check the web site. As indicated in previous notes, there has been a change of venue for ARNSW exams. Currently it is in Baulkham Hills. There is still plenty of interest and if you know of anyone wanting to undertake any of the exams, have them contact the office by telephone 02 9689 2417, FAX 02 9633 1525, email [vk2wi@ozemail.com.au](mailto:vk2wi@ozemail.com.au) or post to P.O. Box 9432, Harris Park, NSW 2150. Get an application form from the ARNSW web site, or the office.

### VK2WI

A new transceiver is being prepared for 30 metres on 10.125 MHz. The old equipment has provided over 20 years of faithful service but has grown tired in recent times. It is time to move forward a couple of generations in transceivers. There will be no transmission on 30 for a few weeks. During this period of low sunspots, 80 metres continues to be the mainstay of the State-wide HF coverage. 40 is being patchy in the morning and has difficult adjacent channel signals in the evening. VK2WI will most likely adopt the usual practice over the holiday period of a morning-only session. Further details will be provided next month. Good reports are still coming in about the 3699 VK2WI Morse transmission and the interest many show in its operation. If you are still looking to learn the Code, don't forget the VK2BWI operator sessions a couple of nights a week on 3550 at 8 pm. If you like sending code - why not join the team and help spread the load. Contact Coordinator Ross VK2ER. Mentioned last month was that the Central Coast 70 cm Morse transmission was moving. It is now on the new channel of 439.725 MHz which doubles as a voice mode repeater by the addition of 123 Hz on the 434.725 input.

73 - Tim VK2ZTM.

## Coffs Harbour and District Amateur Radio Field Day

Sunday 21st January,  
St Johns Church Hall,  
Mc Lean Street, Coffs Harbour  
8.30am to 3.30pm

### ON! Rain Hail or Shine!

*Commercial Traders, Disposals,  
RF Scrambles, Lucky Door Prizes,  
Trivia Quiz, Home Brew Comps*

Entry \$5.00 per person

Hot and Cold food available,

\*\*\*Free parking\*\*\*

More Info: Call Gary Ryan,  
Field Day Coordinator,

02 6655 2990 or

email: [radiosupply@bigpond.com](mailto:radiosupply@bigpond.com)

## VK3

### Amateur Radio Victoria News

Website: [www.amateurradio.com.au](http://www.amateurradio.com.au) Email: [arv@amateurradio.com.au](mailto:arv@amateurradio.com.au)  
Jim Linton VK3PC

#### Promoting amateur radio

A series of newspaper articles initiated by Amateur Radio Victoria has been published, giving the hobby and the Foundation Licence positive publicity.

It was felt important to not only publicise the new attractiveness of amateur radio, but also raise public awareness and understanding of the activity.

The first article appeared in *The Senior* (Victoria) newspaper to target those already retired and those intending to retire in coming years.

Featured in the article are Rob Carmichael VK3DTR and Gary Thompson VK3FGAZ. It discusses how Rob, 87, was bitten by the wireless bug when aged five and his father put a set of headphones on him to listen for a broadcast from 3LO.

Gary is reported as taking up amateur radio in preparation for his intended retirement in a few years; He describes it as a really friendly hobby.

About five Melbourne weekly suburban newspapers have also run stories. The first

was the Hume Star that reported on the activities of Graeme Koch VK3FTTG.

Then followed the Northcote, Preston and Melbourne Leader newspapers with a half page story on Mick Ampt VK3CH and his daughters Janice VK3FIRE, 10, and Michelle VK3FAME, 7.

Michael Boudreaux VK3XZ was next in the Brimbank Leader. These stories resulted from a campaign that enlisted volunteer Amateur Radio Victoria members who became 'ambassadors for amateur radio'.

There are about ten other willing 'ambassadors', including, not surprisingly some enthusiastic Foundation licensees. However, the suburban newspapers have generally been slow in responding to the reporting and pictorial opportunities.

Efforts are continuing to get them interested. 'Ambassadors' in some municipalities including Glen Eira, Knox, Maroondah, Kingston and Stonnington are still needed. Volunteers from those areas willing to be interviewed are invited

and photographs would be welcome. The promotional campaign may spread to regional newspapers if there is support for it.

The published stories can be found on the Members Only section of our website.

#### Schools radio project

Students at Grovedale Secondary College near Geelong are receiving Foundation Licence training, thanks to John Collins VK3TKH.

To support that activity, Amateur Radio Victoria has donated ten Foundation Licence Manuals as part of its 'getting amateur radio in schools' project.

Under that scheme, any Amateur Radio Victoria member who confirms that they are running Foundation Licence training and assessments at a school, will receive up to ten handbooks free.

#### Cordless phone pulled

The ACMA has acted very quickly to stop the use of a long-range cordless telephone operating on the 2-metre band.

The presence of the device was initially detected by a nearby radio amateur who then asked Amateur Radio Victoria to advise the ACMA.

This was the latest incident with imported cordless phones that illegally operate on various VHF frequencies including the exclusive amateur 2-metre band. Earlier this year, another cordless phone caused severe interference to the Kinglake repeater VK3RMN.

#### Membership renewals sent

All members whose membership renewals for 2006-08 which were due should have now received a renewal notice. The membership fees are unchanged at \$30 (radio amateur and unlicensed radio hobbyist) and \$25 (full time student or pensioner).



Rob Carmichael VK3DTR and Gary Thompson VK3FGAZ chat on air, as featured in *The Senior* (Victoria) newspaper

# News from...

## VK3 continued

New members are always welcome and a membership application form is available on the Amateur Radio Victoria website or can be provided on request.

Thanks to Rob Hailey VK3NC, who updated the database software that now fully accommodates the 7-character Foundation Licence callsigns, plus brings in other refinements, and Peter Mill VK3APO, who burnt the midnight oil checking the records and filling envelopes.

## New Councillor

This month we welcome Terry Murphy VK3UP, who joins the Amateur Radio Victoria Council for 2006-09.

He has been warmly welcomed by the existing councillors, Jim Linton VK3PC, Barry Robertson VK3JBR, Ross Pittard VK3FCE, Peter Mill VK3APO and Keith Proctor VK3FT.

## Foundation Licence training and assessments

Upcoming dates: 11-12 November and 9-10 December. Know someone who could be interested? Contact Barry Robinson VK3JBR 0428 516 001 or arv@amateurradio.com.au

# VK5

## Adelaide Hills Amateur Radio Society

Graham VK4ZFZ had much of interest to share with the nearly 60 members who gathered at the new venue in September.

Graham spoke about some of the new (and not so new) developments in the world of amplifying, in particular AM, both normal and digitised, amplifying.

The topic struck a chord with many members who had started their interest in amateur radio through an interest in building and fixing amplifiers, however, there are many new applications of old ideas in use today.

Do you remember the technique called ampliphase? This is one of the old/new principles in use today in modern amplifiers

At the end of the talk, Graham illustrated

the band-space savings that can be made by digitising, not only FM commercial broadcast stations, but doing the same to the AM broadcast signals, too. There is room for ten times as many stations within the normal broadcast bands than we have now.

Whether we need or want more, or whether we would or could listen to more radio stations was not the question addressed!! But we were left with the feeling that there are likely to be changes within the next few years, though probably it is the more populated countries which will see these changes first and most.

By the time you see this column, the AHARS "Buy and Sell" will be over but I hope everyone went away with lots

Christine Taylor VK5CTY

of treasures and maybe some bargains. Come again next year!

The AHARS committee is working to encourage the new licensees to join AHARS and also to join the WIA.

The committee is offering to refund the examination fee for any member who upgrades to the next level. (They have already refunded the examination fee for the members who passed at the previous examination. This is a new offer.)

In addition to the examination encouragement, the committee would like to see more members also members of the WIA. To help this happen, the committee is offering to subsidise the first year's fee by 50% for any club member who joins the WIA for the first time.

## The Riverland Radio Club welcomes UK visitor

The Riverland Radio Club members welcomed Norman Williams M0CRM/VK5ATJ to the Riverland. Norman spent a week in the area enjoying some

of the local attractions including the Loxton Historical Village guided by Robert VK5TRM. Norman was also treated to a tour of the Murtho and Renmark area by Doug VK5GA.

Norman lives in Whitehaven, a port on the West coast, which is in the North West of England, about 60 km from the Scottish border. A retired civil engineer married to a very understanding wife who encourages him to travel.

Norman M0CRM/VK5ATJ attended the Riverland Radio Club's monthly meeting on Monday the 9th October and addressed the meeting on the Foundation Licence in the UK.

Norman pointed out that although the Morse code is no longer a requirement for the Foundation Licence in the UK, candidates are still required to know the principles of Morse code. He also made reference to the many callsigns used by amateurs in the UK.

Norman leads a very busy life back in the UK, being active on HF and

VHF, static and mobile, and often uses Echolink.

He founded the Whitehaven ARC and the Workington ARC and put 60 plus through the Foundation course with several carrying on to take the Intermediate licence.

Norman M0CRM is Deputy Chairman of the RSGB (Radio Society of Great Britain) Planning Advisory Committee and Deputy RSGB Regional Manager responsible for District 31, Cumbria and part of North Lancashire. As he pointed out, it sounds grand but it is all voluntary and unpaid.

The club held a BBQ at the Berri Caravan Park prior to Norman returning to Adelaide.

Doug Tamblyn VK5GA  
Riverland Radio Club



Norman M0CRM at Heading's Cliff

## VK7

Justin Giles-Clark, VK7TW  
Email: vk7tw@wia.org.au  
Regional Web Site: reast.asn.au

### Great Tassie Hamfest 2006

Next month, December 2, will see the great Tassie Hamfest 2006 in the Miena Community Hall in the Central Highlands. This event will again be proudly hosted by the Central Highlands Club of Tasmania and all are welcome. Many suppliers will be attending including Benelec, Icom, TTS Systems plus many more. Entry fee is \$5.00 per person or family and will include free tea & coffee. Food will also be available at very reasonable prices. Starting time is 10.00 am. There will also be sales of pre-loved gear and a lucky door prize along with other prizes throughout the day. See you there.

### BPL - RF Susceptibility Testing

With the help of Harvey VK7HK, tests have been undertaken in the Mt Nelson BPL trial area to research if it is possible for HF amateur radio to co-exist with the BPL system being trialled in VK7. Observations of the latency time, signal level and link LEDs on the BPL modem were recorded with and without RF signal being present. The key conclusion is that the BPL system observed is severely disrupted by ingress of low intensity (2-5 watts, estimated <1 W EIRP) RF energy from nearby radio transmitters. The report can be viewed at <http://reast.asn.au/vk7bplwatch.php>.

### NW Tasmanian Amateur Radio Interest Group

The VK7RMD 2 m repeater on Mt. Duncan has been repaired thanks to Peter VK2IY and Winston VK7EM who scaled the mountain and tower. The new antenna is a Moonraker Type MD/HS with gain in the order of 2.2 dBi and its sturdy construction should be able to withstand the rigours of this location. Tony VK7AX has installed a SSTV Live Web Cam that is available via the internet and also puts the picture out on 147.4 MHz. Take a look at: <http://www.vk7ax.tassie.net.au/sstv/>.

### Northern Tasmania Amateur Radio Club

Wednesday 13 September was a NTARC dinner meeting with guest speaker David Murray from CentreLink. David gave us a great presentation that cleared up a few grey retirement areas. Repeater VK7RAB on Mt Arthur has been repaired thanks to VK7YBG, VK7ZJA, VK7HAM and VK7NKT.

### Radio and Electronics Association of Southern Tasmania

Sunday September 24 saw torrential rain but this did not deter about 20 people in 7 teams compete for the running of the great Foxhunt in the Southern Forests around Nugent. Congratulations to Murray VK7ZMS who won the Jing Tong 2 m hand held that was donated by Ken VK7DY and Wendy VK7FWJS.

The Wednesday night ATV Experimenters nights have been great fun

with a variety of ATV programs broadcast and many ATV viewers providing reports from all over Hobart. If you would like to become a part of the ATV group come up to or point your antenna toward the Queen's Domain and tune your TV to 444.25 MHz (low UHF) and give us a report on VK7RAD/RHT.

We also congratulate our latest five Foundation licensees – Gordon VK7FGFH, Robert VK7FRTH, Derek VK7FINE, Alan VK7FWAG Alan and Robbie VK7FROB. The REAST October meeting saw about 15 people hear a very interesting and helpful talk by Dr. Michael Boxhall on a broad range of men's health issues. Prostate symptoms and treatments, erection problems and, yes, there were the obligatory questions about Viagra! Dr. Michael then covered bowel cancer, kidney stones, diabetes and finished off with osteoporosis and joint problems, etc. There were many questions asked and myths dispelled; thanks to Michael for giving us the time. **ar**



Intrepid (& wet) fox hunters await the final scoring!

Healesville Amateur Radio Group Inc.  
C/o P.O. Box 346, Healesville, Vic, 3777



Sunday 25th February, 2007  
10am to 2pm

For booking of trestles  
and further information  
Gavin VK3TLN 5968 8482  
Steve VK3TSR 0418 103 487  
email: hamfest@harg.org.au  
Healesville Memorial Hall  
Maroondah Highway, Healesville  
website: www.harg.org.au

# ALARA

Christine Taylor VK5CTY

## ALARA Contest – WOW!

This year's ALARA Contest was one of the best ever. Thank you to everyone who participated. Our Contest Manager, Marilyn VK3DMS, was thrilled with the total number of logs submitted, the high scores and the number of F call licensees who enjoyed the experience of contesting, perhaps for the first time. Propagation was kinder to us this year than it has been for the last couple of years, too, which was a help.

Congratulations to Diane VK4KYL. Not only was her score very high, in fact one of the highest ever, but she was closely followed by Catherine VK4FRED with another very high score.

Because this is the first year Foundation licences have existed, the committee decided to award a one-off special award to the top F call scorer, who is, of course, Catherine VK4FRED.

The full results are printed elsewhere in this issue of AR.

## An ALARA Plaque awarded for service

At varying intervals, the committee of ALARA gives a plaque to a member who has been an active contributor to the association. Such a plaque was sent to Judy VK3AGC recently. Judy served on the committee for many years and was a regular on the Monday Night Nets.

She was President of ALARA up to and during the ALARAMEET in Brisbane, and in many ways has helped to make ALARA work as well as it does.

Plaques like this are given only after unanimous endorsement by postal votes of all the members of the current committee.

Unfortunately, due to geographical difficulties, we had to send the plaque to Judy rather than present it to her at a public function, but we hope it has pride of place in her home now.

Congratulations, Judy.

## Monday Night Nets

It has been great to have more and more F call YLs joining the Monday night Nets. VK4FGAY is becoming a regular, although she cannot always hear us from Bundaberg, and Pam VK4FABB from

the Gold Coast has joined us from time to time. Catherine VK4FRED and Michelle VK3FEAT are often heard.

Perhaps the best evening recently was when we had three F calls, five or six regular full calls and two YLs calling in mobile. Leslie VK5HLS was mobile in VK2, while Jeanne VK5JQ was calling in from VK6. What is more, they could all be heard by someone who was able to relay their information.

For those of you who have not previously called into a Monday Net, look for us on 3,580 +/- 5 kHz at 1030 Zulu. We usually manage to squeeze in there, though the band is much busier than it used to be.

As soon as daylight saving comes in, the time will change to 1000 Zulu, so it may not be until close to the end of the net that the VK4 stations will be able to hear or be heard.

The conversations are always varied apart from usually starting with a weather report from around Australia. It seems that someone always has a special tale to tell which sparks other stories of similar experiences. We know there are quite a few regular "listeners-in" but that is quite OK.

When there is a station from a different state, it may help you to gain your ALARA Award. We are always happy to wait till the end of the Net to give you a formal QSO if it will help. Just call in and ask.

## Have you heard Andaman Island recently?

*(This item taken from BYLARA magazine, written by Babs, translated by Christine GM4YMM)*

*We will all remember with pride the amazing job the DXpedition group led by Bharathi VU2RBI did in the aftermath of the tsunami in December 2004. As a consequence of that effort, the NIAR (National Institute for Amateur Radio) issued a general invitation for a Hamfest on Andaman Island in June this year.*

*If we also remember that the first DXpedition, which ended so dramatically, was the first one allowed on those islands for many, many years, this was a special invitation. It recognises the assistance*

*given by worldwide amateurs during that terrible time. We can be proud of our hobby, indeed.*

*Again, Bharathi was the leader of the DXpedition but she was not the only YL involved this time.*

*Babs DL7AFS, Claudia K4LEO, Mio JR3MVF (also an ALARA member), and Jeanie WA6UVF were among the 50 Indian and 25 International amateurs on the islands for the Hamfest.*

*If you made contact during the Hamfest, we can be sure you will treasure the QSL card. Unfortunately the DX YLs were not among the contacts except for a few, but it is great that so many were able to be part of the DXpedition.*

## Special award for F calls

The information is not exact but the rumour is that VK3 is running a special award called WAFL (waffle!!) aimed at the F calls. Listen out for it; I'm sure it will be interesting for all concerned.

## JOTA

As usual, there will be many young voices heard over the weekend of 21-22 October. Do help them and help to encourage more young people into our great hobby.

If there are YLs out there assisting at a JOTA station, please let Dot VK2DB and/or me VK5CTY know so we can tell everyone else about it. Photos are welcome, too.

We can't know if you don't tell us.

ar

www.pca.cc  
Email from anywhere  
via Winlink  
2000  
Use PACTOR-3  
on HF to send  
Mail, Grib Weather,  
Weatherfax & Images  
Contact marc@pca.cc  
Sydney 02 8902 0107



# AMSAT

Bill Magnussen VK3JT

## SSETI GTO satellite project

The SSETI GTO satellite project is still on track for a launch from Kourou in November 2008.

The planned AMSAT-UK U/S linear transponder is a critical part of the project. The transponder is expected to have: 50 kHz bandwidth, 10 watts of RF output, selectable DSP/SDX and analogue signal paths, a 400 bps beacon and linear polarised antennas with unity gain.

The satellite may not have good, long term, attitude control therefore the antennas are being designed to work well even if the satellite is tumbling. The link budget may not be as good as AO-40 was nor as P3E will be and it is anticipated that circular polarisation and full tracking of ground station antennas will be needed.

Before the system is operated as an

## The AMSAT group in Australia

The National Co-ordinator of AMSAT-VK is Graham Ratcliff VK5AGR. Contact Graham if you wish to be placed on a mailing list for breaking news and net reminders. As a forum for members AMSAT-VK operates two monthly nets.

## AMSAT-Australia Echolink Net

The "Echolink" net meets on the second Sunday of each month. Anyone with an interest in Amateur Radio Satellites is welcome to join the net. Graham VK5AGR acts as net controller. The net starts at 0500UTC during summer time periods and 0600UTC during winter standard time periods. Connect to the AMSAT conference server on Echolink a few minutes before these times.

## AMSAT-Australia HF net

The HF net meets informally on the second Sunday of each month. In winter (end of March until the end of October) the net meets on 3.685 MHz at 1000 UTC. In summer (end of October until end of March) the net meets on 7.068 MHz at 0900 UTC. Start listening 15 minutes before these times.

All communication regarding AMSAT-Australia matters can be addressed to:

AMSAT-VK,  
9 Homer Rd,  
Clarence Park, SA. 5034

Graham's e-mail address is:  
vk5agr@amsat.org

amateur transponder, it will be used as the initial main communications package for the reception of telecommands to the satellite and for the transmission of telemetry and mission data from the satellite. The U/S transponder is therefore a critical part of the whole project. The Preliminary Design Review will be completed during next month and an engineering model of the satellite should be under construction early next year. This process should be visible using the same webcam system as the SSETI Express construction. The website <http://www.sseti.net/> has lots of info about the SSETI program. Click on "missions" and ESEO for more details about their plans for their GTO satellite. AMSAT-UK is again to be congratulated on another joint engineering project of great potential to satellite users around the world.

This information was provided by Graham G3VZV via the AMSAT-BB.

## Potentially bad news regarding PoSAT.

Martin Sweeting G3YJO posted the following to the AMSAT News Service recently. Bad news for those anticipating the return of PoSAT to amateur service now that its commercial job is done.

"Following the recent kind agreement of Consórcio SAT, the owners of PoSAT (PO28 or 1993-061D) which was launched on the Ariane V59 from Kourou on the 26th September 1993, work has been progressing at SSTL and the Surrey Space Centre to switch transponder frequencies to the amateur satellite service to serve as a voice FM transponder for use by all radio amateurs worldwide. Unfortunately, recent investigations now indicate that the PoSAT on-board NiCd batteries are showing the effects of 12 years in orbit and the approximately 100,000 charge/discharge cycles to which they have subjected and are no longer holding sufficient charge to operate the downlinks. This may mean that, sadly after all, it will not be possible for the satellite to be made available for amateur use. We fully understand the benefits that PO-28 would offer radio amateurs and work is continuing at Surrey to see if there is any way to revive this 'old lady'. AMSAT-UK will provide updates when further information becomes available".

# Rippletech Electronics

## HIGH PASS FILTERS FOR TVI PROBLEMS

Most TVI problems are due to the inability of the TV set to reject strong out-of-band signals - i.e. those from a local HF transmitter. Rippletech High Pass Filters are designed to reject all HF signals, not merely optimised to reject CB. The HPF-50/55 has a cut-off frequency of 50 MHz and better than 55dB of attenuation on 10m and at least 80dB of attenuation on 80m.



TZ-1840	1:1 1kW 160-10m Balun	\$ 59.00
TZ-330-4	4:1 1kW HF Balun (3 - 30 MHz)	\$ 59.00
TZ-SL8	80m Sloper (use tuner on 17 - 30m)	\$ 99.00
TZ-SL16	160m Sloper (fits a suburban lot!)	\$ 110.00
TZ-D-4080	40m/80m Trapped Wire Dipole	\$ 176.00
TZ-V-3	10/15/20m Trapped Vertical	\$ 189.00
TZ-V-4	10/15/20/40m Trapped Vertical	\$ 289.00
TZ-V-3L	20/30/40m Trapped Vertical (NEW)	\$ 220.00
TZ-V-3w	12/17/30m Trapped Vertical	\$ 199.00
TZ-V-3x	12/17/40m Trapped Vertical	\$ 209.00
	Radial kits (1 radial per band)	\$ 33.00
TZ-RD-3	10/15/20m Trapped Rotary Dipole	\$ 279.00
TZ-RD-3w	12/17/30m Trapped Rotary Dipole	\$ 289.00
TZ-RD-3x	12/17/40m Trapped Rotary Dipole	\$ 309.00
TZ-RD-40	17/40m or 20/40m Rotary Dipole	\$ 289.00
TZ-1000RC	FT-1000mp remote controller	\$ 55.00
HPF-55/5C	High Pass TVI Filter (available now)	\$ 39.00
	Mobile base & 2 bracket combo	\$ 11.00

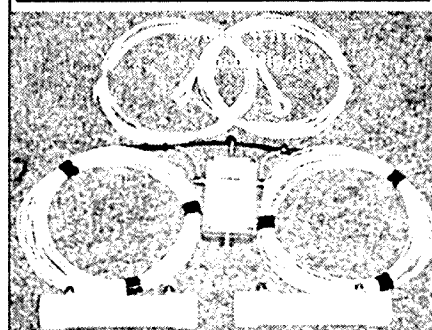

## The Innovator - not the imitator

Our tri-band, quad-band and tri-band WARC verticals have been big sellers for several years now, so good imitations are starting to appear! Compliments abound - check out buyer satisfaction on our ebay sales. We couldn't be more flattered. The verticals are perfect for the ham with limited space, field days, mini expeditions or travellers. With a packed length of only 1m, they fit in your boot or on a plane. Using the same high Q, sealed coaxial traps exhibiting 40 dB of isolation at resonance you get really great performance & ultra wide bandwidth. Even better is the ease of set-up, comprehensive and detailed instruction manual and no compromise construction.

## Need something special?

Make a call and we'll see if we can meet your needs.

[www.rippletech.com.au](http://www.rippletech.com.au)

Contact Tony - VK3TZ B Eng (comms) MBA

0402 622 562 or 03 9887 4936

email:

[sales@rippletech.com.au](mailto:sales@rippletech.com.au)

Mastercard, Visa and Bankcard accepted

**Still nothing from Oscar-11**  
Clive G3CWV again reports that nothing has been heard of Oscar-11 for yet another month. We may have heard the last of this old timer. UoSat-Oscar-11 or UO-11 is a veteran of an earlier glorious period of AMSAT activity when the collection, decoding and correlation of engineering data from the Oscars reigned supreme.

It was built at the University of Surrey in England and launched on March-1 1984. It was the first Oscar to demonstrate the feasibility of digital store and forward techniques. A veritable army of electronics and engineering teachers around the world made UO-11 part of their lab classes. I even managed to spur interest by the mathematics staff at school and UO-11 was woven into our school senior curriculum for a number of years. Student prac projects included tracking antennas and recording sessions on the school sports ground and further afield, with many such data collection sessions taking place late at night or early in the morning. These were the days before sound card decoders; you had no alternative but to build your own hardware decoder. Who knows how many G3RUH demodulators were built. AMSAT-VK alone sold dozens of etched circuit boards.

UO-11 was originally a morning satellite, the orbit designed to take it over every part of the earth during morning school classes between 8 am and 11 am. It held this orbit for many years but has long since lost its sun synchronicity. It began to falter a few years ago when the "S" band beacon partially failed but even then it was put to great use by the satellite microwave gang in testing and calibrating their receivers. If we have heard the last of UO-11, as seems likely, it will mean the passing of an era in the educational use of amateur radio satellites. Thank you UoS and thank you UO-11.

## Lots of activity on the ISS

In the last month or two there has been a flurry of ARISS activity. Even the Space visitor Anousheh Ansari has been part of the fun. She has reportedly made many contacts even though her heavy training schedule prevented her from obtaining her own licence prior to departure for the ISS. Many school contacts have been scheduled and a very high success rate has been achieved.

It is particularly pleasing to see the amount of reported 'random' activity from ISS too. Keep your Keps up to

date and keep a listening watch. You never know when you might just hear an Astronaut calling CQ from the ISS.

## "L" and "S" band debate continues.

It is difficult to remember when a topic has created such a furore on the AMSAT-BB. The announcement was made more than a month ago that the "L" band uplink and the "S" band downlink were to be dropped from the design of the new high orbiter "Eagle".

Since that time, a steady stream of questions and objections have been aired on the BB. There have been a number of attempts by design team members to allay the fears but still the questions come. "Eaglepedia" is being regularly updated on this topic on the AMSAT-NA web site. It seems the concern won't go away. Like many others, I was looking forward to using my (now aging) "S" and "L" band gear on Eagle.

It will be useful on P3E, so I'll have the opportunity to blow the cobwebs out when that satellite is launched. Hopefully a lot of others will too. For those with deep concerns my only suggestion is to get into the habit of watching the latest information come to "Eaglepedia".

ar

# Inter-club BBQ strikes gold

A social gathering of radio amateurs in central Victoria resulted in a very enjoyable day with much food for thought in terms of possible future events.

The Central Goldfields, Ballarat and Midland clubs held a barbecue at the Laanecoore Hall, between Bendigo and Maryborough, on Sunday 8, October.

It attracted 60 people, including four Councillors from Amateur Radio Victoria who had responded to an invitation by the three clubs to join the BBQ.

A topic of discussion, initially among the club presidents, Peter Rafferty VK3CC (Goldfields), Bob Pitcher VK3NBV (BARG) and Mark Harris VK3EME (Midlands) was a possible joint hamfest type activity in the region. This was formally raised when those at the BBQ met for a brief meeting inside the Laanecoore Hall.

Jim Linton VK3PC, President of Amateur Radio Victoria, told the meeting that the state-wide organisation would aim to provide support and backing for such an event.

After the meeting, the club presidents found that there was much enthusiasm for the idea and they will return to their committees with the aim of developing the possibility even further.

Some suggestions on the weekend included using a country racecourse,

making it a two day event and attractive not only to radio amateurs but for those who can come and see what the hobby is about. A lot of work is needed to make what is now a dream, into a reality.

ar

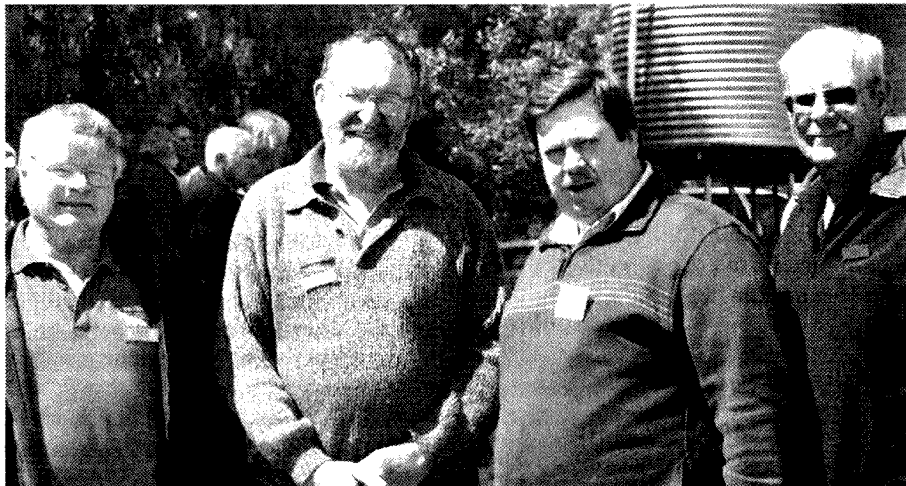

The President's line up - Peter Rafferty VK3CC (Goldfields), Bob Pitcher VK3NBV (BARG), Jim Linton VK3PC (ARV) and Mark Harris VK3EME (Midlands).

# Beyond our shores

David A. Pilley VK2AYD

## UK

### No licence fee

Latest news about UK Licences & Ofcom:

Of special interest to those that also hold a U.K. licence. The following applies to U.K. residents. The new online lifetime licensing system will be available from 1st Dec. 2006 when Ofcom will deliver a simplified service to existing and new licensees, and to allow for a smooth transition of the licensing processes from the Radio Licensing Centre to Ofcom. If you need to renew your U.K. licence or apply for a new licence in September 2006: Contact the RLC as usual at [www.radiolicensingcentre.co.uk](http://www.radiolicensingcentre.co.uk). If you need to renew your licence during October, November or December 2006: you will automatically be sent a new annual licence to temporarily replace your old licence (which you will not have to pay for).

If you have a Direct Debit set up to pay for your licence, this fee will not be collected. Ofcom urge you to cancel any Standing Orders or BACS payment set up to pay for your annual licence. The new annual licence will cover the short period until your new lifetime licence is issued through the post. If a new licence is needed during October or November 2006, you should contact the RLC (see above). You will be sent an annual licence which you will not be required to pay for - this will cover the short period until your new lifetime licence is issued through the post.

From 1 December 2006, free online licences will be available. However, those applying via a paper-based application will be subject to a £20 charge. For more information look at <http://www.ofcom.org.uk/radiocomms/ifi/licensing/classes/amateur/>

For FAQ about it all see: <http://www.ofcom.org.uk/radiocomms/ifi/licensing/classes/amateur/faq/>

(RNARS)

## Saudi Arabia

### Licensing requirements

Not many of us will be seeking a licence from 'HZ', however Peter Saunders VK6APW, is back in Jeddah with civil aviation. Peter explained:

The radio amateur licence in Saudi Arabia involves sitting for a written theory and regulations exam and a practical Morse test. There are two classes of licence. Class 1 (HZ1) is for HF and VHF and class 2 (HZ2) is VHF only. This allows the holder to operate at class level, but not to erect a station or antenna system! For this you require a separate application. Equipment must be certified and the power limit is 200 watts. Linears are not allowed. Peter is active on HF using a TS-50 with the call HZ1PS. More information on licensing can be obtained from [www.citc.gov.sa](http://www.citc.gov.sa).

(VK6APW)

## Space

### ISS and SSTV

Astronauts on the International Space Station can now transmit slow scan TV images of themselves to Radio Amateurs on Earth thanks to the installation of a new software package called SpaceCam1. They can send still or moving images using standard SSTV formats. Transmissions from the International Space Station take place on 145.800 MHz FM. You will need some tracking software to determine when the station's footprint is in your area. Check the web site [www.marx.org](http://www.marx.org).

(RadCom)

## New Zealand

### Repeater fees

Radio Amateurs in New Zealand have rebelled against a plan by the country's regulator, MED, to impose a \$50 annual fee on repeaters and beacons. Members of the NZART unanimously passed a resolution refusing to pay the charges. In New Zealand, the NZART holds the licences for most of the repeaters and beacons they could be faced with a bill for \$16,000 a year. As the frequency planning and disciplines associated with repeaters are determined by the NZART, they are at a loss to understand the charges being forced upon them.

## USA

### Jailed amateur

A former ham will spend the next 7 years in prison. This, after a federal judge

in Los Angeles hands down one of the harshest sentences in history against a convicted radio communications jammer. It happened on Monday, September 18th. United States District Judge R. Gary Klausner minced no words when he told Jack Gerritsen (ex KG6IRO) that he would spend the next 84 months confined to a Federal prison. Gerritsen's lawyer appealed to the court to be lenient and give him no more than two years in jail. The Federal Prosecutor had asked the court to impose a harsher 46 month jail term. Before learning his fate, Gerritsen even offered a formal apology to the government, to the FCC, and the Amateur Radio community. However, Gerritsen was a repeat offender who, after previous appearances at court, continued to jam both amateur and commercial radio networks including the police.

(ARNewsline)

## Christmas Island

### US hams to set up Em-Comms system

A pair of United States hams is heading off to Christmas Island on a mission to establish medical emergency communications on that remote island. Making the almost 8000 mile trek are Texas businessman Carlton Smith KE5EUL and 2006 Radio Amateur of the Year Gordon West WB6NOA. West says it's a voyage well worth making:

"We found out from those on the island that they needed eyeglasses. They needed medical supplies, and they needed a lot of medical type equipment for their small hospital and their outlying clinics. As a humanitarian effort, another friend and I are going over there to help them to set up their communications, as well as to add to what medical supplies they already have on hand."

West and Smith will depart on Monday October 2nd and should be on the island by the 3rd in United States time zones. The pair will set up a new non-ham radio, solar powered short range radio communications system to link the atoll's only small hospital to three very remote clinics on the Island. They will also put in a High Frequency SSB system operating from the same hospital to Fanning Atoll and Washington Island. Both are several

hundred miles to the North.

Smith said "Gordon and I are going to install radios - SSB Marine radios - at the very small hospital on Christmas Island and the three outlying medical clinics, as well as in a recently donated ambulance, so that the nurses on this island at the various clinics can communicate with the doctor at the small hospital."

In addition to the radio gear, Smith and West will also be taking with them close to a thousand pounds of medical supplies and reading glasses that will be distributed to the residents. Providing assistance to the residents of Christmas Island has been an ongoing project for Smith. It began after a cruise he was on made an unscheduled stop at the atoll. Smith commented "About two years ago, my wife and I happened to visit Christmas Island and learned that they were very isolated and quite medically needy. Their central government often does not supply them with any medicines. There are 9000 people living on these three isolated islands of Christmas Island,

Fanning Island and Washington Island -- all within a couple hundred miles of one another, but these three islands are collectively isolated from the rest of their country. The capital is Tarawa which is over 2000 miles away. So these three islands are very isolated and only visited by a government supply ship once every three or four months."

So Smith decided to get his ham radio licence as a means of assisting in communications to the island group. In doing so, he met West and invited him to join the project. Gordon told Amateur Radio Newsline that this is work he has done before. In fact, it was a part of his life at a very young age:

West: "Well, I grew up with my parents aboard a boat off Mexico long before Mexico even had phone lines to some of the places we went. I am used to working with those in need of supplies and communications. So this is taking me back probably 50 years from when I was working down in Mexico to now be able to work for this country."

While their primary mission is humanitarian work, West and Smith hope to find time to get on the ham bands and hand out some contacts. They will be there for a week and have been given permission to operate T32GW by the Telecommunications Authority of Kiribati. Hams needing a T32 QSL or a contact for the Islands On The Air awards program should keep an ear open for the two operators during evening hours on 14.275.

That's when they will likely be looking for state-side contacts.

West told Newsline that he will also explore the Pacific tropo ducting VHF/UHF paths that were first observed years ago. He will be on 144.170 MHz upper sideband listening for beacon reception of the KH6HME beacon several thousands miles to the North. QSL your contacts with WB6NOA and KE5EUL at their respective callbook address.

(Sept 22 ARNewsline™)

ar

## **Silent Keys**

### **Ken Assender VK7ASN**

It is with sadness that I announce the death of Ken Assender VK7ASN on 10th September 2006.

Ken was a RAAF pilot and was involved with early Australia National Antarctic Research Expeditions (ANARE), now the Antarctic Division at Kingston, in the late 1950s and early 1960s and wintered at Mawson base in 1960.

1960 was also the last year of RAAF operations in Antarctica, due to particularly harsh blizzards in both 1959 and 1960

which destroyed aircraft.

In June 1998, Ken was awarded a medallion for expeditioners whose valuable service had not previously been formally recognized, especially in the early years of ANARE. Ken was president of the Tasmanian branch of the ANARE Club for many years and organized the mid-winter ANARE Club dinners until his death.

Ken even has a glacier named after him

in Antarctica that flows westwards into Spooner Bay, Enderby Land.

Ken was involved with the Royal Yacht Club of Tasmania and Mike VK7FB remembers that for a number of years Ken was associated with the Sydney to Hobart yacht race communications.

In the past he was a regular on the broadcast callbacks until his health deteriorated.

Vale Ken.

submitted by Justin Giles-Clark, VK7TW

### **Peter Waterhouse VK3CWP ex VK7ZPW (The Prickley Whisker).**

Where does one start?

I have to inform you of the sudden death of a long time friend.

Peter died recently at the young age of 57 in a plane crash on his much loved Flinders Island.

He lived life on the edge and in the fast lane. In earlier times, from racing his speed boat Locomotion to flying his plane VH-DET. I first met Peter as a teenager before the days of repeaters

and transistor two-way radios were in their infancy. Peter did his apprenticeship with Harry VK7AR at Mobile Radios in Devonport then moved to Melbourne where he eventually established his own TV service business in Croydon. During his shortened life, he achieved more than some men would in a lifetime.

Rest in peace, Peter.

From Joe VK7JG ex VK7ZGJ

### **Ross Cuttle VK4VL**

I wish to advise that Ross Cuttle VK4VL, passed away on 19 July, 2006, aged 88 years.

Ross's first callsign, VK4ZAT, was issued at the end of the war. He subsequently applied for and was granted VK4VL.

He leaves wife Jess VK4VMK, and five sons and their families.

Prior to his passing, he had requested of ACMA that his son Terry VK4CTC, the only one in the family to follow his father into the hobby, be granted his callsign, and this has been effected.

Submitted by Jess Cuttle VK4VMK

The following material has been extracted from The IARU E-letter, Number 1 & 2.

## IARU prepares for next round of ITU Working Party meetings

One of the most important functions of the IARU is to ensure that the amateur and amateur-satellite services are properly represented whenever decisions are made that affect our frequency allocations. The next major international event of this kind is the World Radiocommunication Conference (WRC-07) that will be held in Geneva next October and November.

Delegates do not just show up at a WRC and make up their minds on the spot. Years of preparation are behind every WRC decision. Most of this work is done within the framework of the Working Parties of the ITU Radiocommunication Sector. For example, Working Party 8A is responsible for studies related to the land mobile service (excluding IMT-2000) and to the amateur and amateur-satellite services.

Working Party 8A will meet at ITU Headquarters in Geneva September 6-14. Other Working Party meetings will be taking place in the same general time frame, including 8B (maritime and aeronautical mobile), 9C (fixed service below 30 MHz), and 6E (terrestrial broadcasting). The timing of these meetings is not coincidental. All four of these Working Parties have a stake in WRC-07 Agenda Item 1.13, which deals with spectrum between 4 and 10 MHz. Delegates with an interest in this issue will hold a joint meeting during the week of September 11.

The IARU will be represented at these meetings by Ken Pulfer VE3PU, and Secretary David Sumner K1ZZ. Other amateur service representatives will be present as members of their national delegations.

More information about the ITU Radiocommunication Sector is available on-line at: <http://www.itu.int/ITU-R/>. For information on individual Working Parties, go to "Study Groups" and then to "Structure." Access to some documents is restricted, but there is a wealth of information available to the public.

## IARU resources on-line

Many IARU member-societies maintain excellent Web sites for the benefit of their members, other radio amateurs around the world, and anyone else who is interested in amateur radio. Did you know that each of three IARU regional organizations has its own Web site? They are:

Region 1: <http://www.iaru-r1.org>

Region 2:

<http://www.iaru-regionii.org/>

Region 3: <http://www.jarl.or.jp/iaru-r3>

The IARU Web site is at [www.iaru.org](http://www.iaru.org). We plan significant improvements to this site in the coming months.

## WRC-07 preparations reach important milestone

September 15 was the deadline for the submission of draft text for the Conference Preparatory Meeting (CPM) Report to the 2007 World Radiocommunication Conference (WRC-07). The CPM will take place in Geneva from February 19 to March 2, 2007, to complete a report of several hundred pages concerning the regulatory, technical, operational and procedural matters to be considered at WRC-07, which in turn will be held in Geneva from October 22 to November 16.

Working Parties of the ITU Radiocommunication Sector (ITU-R) have been hard at work drafting the text for which they are responsible. One of the more complex tasks has been the preparation of text for Agenda Item 1.13, concerning spectrum between 4 and 10 MHz, because – as noted in IARU E-Letter Issue 1 – four different Working Parties were responsible for various parts of the task.

The four Working Parties – 6E, 8A, 8B, and 9C – held overlapping meetings in Geneva during the period of September 5-15. This enabled the drafting work to be completed by a joint group chaired by Pekka Länsman of Finland. IARU

representatives in the joint group were Ken Pulfer VE3PU and David Sumner K1ZZ.

During the meeting of WP 8A, its Working Group 1 chaired by Paul Rinaldo W4RI (representing the ARRL on the US delegation) worked on several matters related to the amateur services. Draft CPM text was completed for Agenda Item 1.15, concerning a possible secondary allocation to the amateur service at 135.7-137.8 kHz. A Draft New Report on the role of the amateur and amateur-satellite services in disaster mitigation and relief was completed, approved by WP 8A and then adopted by Study Group 8 at its meeting September 20-21. Its temporary designation is Report ITU-R M.[AM-DISCO]. Some work also was done on a new ITU Handbook for the amateur services; it is hoped that work on the Handbook can be completed at the next meeting of WP 8A in June 2007.

## IARU participates in ITU Development Sector

Another significant ITU meeting held in September was that of Study Group 2 of the ITU Telecommunication Development Sector (ITU-D). There is ongoing work in ITU-D SG 2 on communications in the event of disasters, including alerting and notification as well as mitigation after the fact. The IARU is recognized as a partner with the ITU in providing disaster communications; for example, see the brochure "Telecommunications Save Lives" at

<http://www.itu.int/ITU-D/emergencytelecoms/publications.html>.

IARU Vice President Tim Ellam VE6SH/G4HUA represented the IARU at this year's meeting of SG 2. He notes, "The opportunity to participate in studies relating to disaster communication and to liaise with ITU staff made this a worthwhile meeting to attend."

*Continues next page*

## IARU Region 2 EC visits Buenos Aires

Over the years, the members of the IARU Region 2 Executive Committee have found it useful to hold their annual meetings in different countries in order to see for themselves how amateur radio is faring throughout the Americas. On September 4-5 the Region 2 EC met in Buenos Aires, Argentina and took the opportunity to meet with officials of Radio Club Argentino. The EC heard that problems with the Argentine economy in recent years have affected everyone in the country, but they also saw that enthusiasm among active radio amateurs remains high.

Support for IARU participation in WRC-07 occupied much of the EC's attention during the meeting. Region 2 has been active in CITEL's preparations for WRC-07 and will provide financial support for a member of the IARU WRC-07 team from Region 2. IARU President Larry Price W4RA, attended the EC meeting on behalf of the IARU officers

and International Secretariat, and thanked Region 2 for its support.

Plans for the next IARU Region 2 General Assembly, to be held in Brasilia on September 10-14, 2007, also were reviewed. More information will be forthcoming from Region 2 as the event approaches, but in the meantime all member-societies in Region 2 should "save the dates" and plan to attend this important regional conference!

## Administrative Council Summary Record available

The IARU Administrative Council meets annually to coordinate the representation of the interests of amateur radio, provide liaison between the three IARU regional organizations and the International Secretariat, and conduct long-range planning. In 2006, the Council met in Bangalore, India, right after the Region 3 Conference held there.

The Summary Record of the meeting is now available at

<http://www.iaru.org/ac-0608min.html>.

The Summary Records of all Administrative Council meetings since 1996 are available at <http://www.iaru.org/admin-council-summaries.html>.

## ITU marks 100 years of international radio regulations

In 1906, the first International Radiotelegraph Conference gathered 29 maritime states in Berlin to sign the "International Radiotelegraph Convention" establishing the principle of compulsory intercommunication between vessels at sea and the land.

The annex to that Convention contained the first regulations governing wireless telegraphy. Those regulations, which since have been expanded and revised by numerous radio conferences, are now known as the Radio Regulations of the International Telecommunication Union (ITU), or simply as the Radio Regulations.

Originally occupying just 12 pages, the Radio Regulations now apply to frequencies ranging from 9 kHz to 400 GHz and incorporate more than 1,000 pages of information describing how the radio spectrum may be used and shared around the globe.

The ITU notes that some 40 different radio services now compete for spectrum allocations to provide the bandwidth needed to extend services or support larger numbers of users.

In a release announcing celebrations in honour of the 100th anniversary of the Radio Regulations, to take place in Geneva on October 30, the ITU Radiocommunication Bureau observed: "In 2006, the ITU membership has good reason to celebrate the centenary of the Radio Regulations.

The World Radiocommunication Conference (WRC) process has been instrumental in providing for timely and effective international regulatory frameworks for the establishment of advanced new wireless services and applications, while safeguarding the interests and rights of existing radiocommunication users.

One hundred years after 1906 we are witnessing innovative technological solutions using radio transmission setting the grounds for a wireless world."

### Editorial comment (K1ZZ):

Even in those early days, the delegates recognized that the radio spectrum was a unique international resource and that the privilege of access carried with it great responsibilities.

Radio - then known as wireless telegraphy - was a technological marvel at the beginning of the 20th Century and in new forms continues to amaze at the beginning of the 21st. The fact that the radio spectrum remains so useful is testimony to the success of the international regulatory regime that was inaugurated in Berlin.

It didn't just happen; without the original guiding vision and the dedicated stewardship of subsequent generations of delegates to innumerable ITU conferences, the radio spectrum today might well be chaotic, polluted, and practically useless. The ITU and its Member States, and especially the Radiocommunication Bureau, are well deserving of accolades on this important anniversary.

More information on this historic observance may be found at <http://www.itu.int/ITU-R/information/promotion/100-years/index.html>.

Until next month, 73, K1ZZ

ar

## KVK Antenna Systems

Best value books in VK.

The VK Antenna Handbook for Restricted Spaces

Best value antennas in VK.

The NuBeam

The Vertical-LR-dipole multiband vertical

As seen at Wyong

Check out the latest revision to the web site - more info, more antennas, more value.

For direct purchases

[www.grimshaw.net.au](http://www.grimshaw.net.au)

For credit card purchases:

[www.kvkantennas.com.au](http://www.kvkantennas.com.au)

or ph 07-3216 8060 or

fx 07-3216 8075

## Contest Calendar for November 2006 – January 2007

Nov	11/12	Japan Intl. DX Contest	(SSB)
	11/12	Worked All Europe DX Contest	(RTTY)
	11/12	Spring VHF/UHF Field Day	(CW, SSB, FM)
	25/26	CQ WW DX Contest	(CW)
Dec.	2	RTTY Melee	(RTTY)
	9/10	ARRL 10 Metres Contest	(CW/SSB)
	16	OK DX RTTY Contest	(RTTY)
	26	Ross Hull Memorial VHF Contest	(VHF+)
(to 14 Jan 07)			
Jan	6/7	ARRL RTTY Roundup	(RTTY)
	13/14	Summer VHF/UHF Field Day	(CW, SSB, FM)
	27/28	REF Contest	(CW)
	27/28	BARTG RTTY Sprint Contest	(RTTY)
	27/28	UBA DX Contest	(SSB)

Greetings and welcome from your new columnist, Phil Smeaton VK2BAA. I'm sure that you will join me in thanking Ian Godsil VK3JS for the years of sterling work he has provided both to AR magazine and VK contesting in general. He has been a stalwart supporter of contesting in Australia and I've got big boots to fill, but let's get started by means of an introduction.

I've been contesting for quite a while, but mainly from the British Isles. I am keen on both domestic and international contesting regardless of mode or frequency. It's not been often that I've used my own UK callsign for contesting, occasionally on UHF for portable contests using my own call G0HSS, but mainly

as part of a Team using the following calls; MD4K, GD0EMG, G0KPW (a.k.a. M6T), G0FBB and G3GRS to name but a few. I intend to give a little more detail on some of these activities in future AR issues to add a little European flavour every now and then, if people have an interest to know. I've enjoyed SSB, CW, RTTY, HF, VHF, QRP or QRO contesting - you name it.

I've been in Australia for a couple of years now and I've participated in a mixture of domestic and international contests during my time in VK. Antenna space is somewhat restricted at my rental QTH, but that's par for the course nowadays for most hams (space-wise that is, not necessarily renting!) and its part

of the challenge to muster as best as one can and do your best on the air. A contest station does not necessarily require a huge array of towers with multiple stacked beams and legal limit linear amplifiers, as the majority of contests allow for similarly equipped stations to compete against each other at whatever level of equipment provision, facility or even output power. I've been fortunate enough to do reasonably well in QRP sections for CQWW and CQWXP within Oceania, with just a few watts of power and simple wire antennae with a trapped vertical covering 40, 20, 15 and 10 m (I've no permanent antennae for 160 m or 80 m) all within a suburban backyard, so if I can do it, anyone can!

## Results CQ WW CW Contest 2005

(VKs only Call|Cat|Band|Score)

### Single Operator Unassisted

VK2GC	SOAB	2,267,245 (Op. K5KG)
VK7GN		879,612
VK2NU		464,512
VK2GWK		10,374
VK4AN	SO7	271,579
VK2IMM	SOAB	652,790
VK2GR		210,888
VK4TT		170,754

VK6HG	112,665
VK4BUI	111,826
VK2AR	77,736
VK4VFX	54,096
VK6HZ	23,250
VK4EJ	22,008
VK2PN	4,745
VK2WL	2,812

### QRP

VK2BAA	SOAB	56,810
--------	------	--------

### Single Operator Assisted

VK4XY	SOAB	58,293
VK3KE		40,392
VK6DU		21,730
VK9AA		6,878,488 (Op. VK2IA)

# Team Contesting

## VK Contest Club Team

### Australis

VK9AA (Op. VK2IA), VK2IMM, VK2BAA, VK2NU, VK2GC (Op. K5KG) 10,320,345

## VK Contest Team Southern Lights

VK6HZ, PA0MIR, VK7GN, VK4AN 1,538,928

Amongst others, two particular major international contests are due to take place around this time of year; the CQWW Phone Contest at the end of October and the CQWW CW Contest at the end of November. Both contests are well supported around the globe and are excellent for getting on the air and having some fun. Whether you are a serious 'dyed in the wool' contester trying to improve on last year's personal score or against others, or intend a more casual time on the bands to bag that juicy DX that usually accompanies these events, there's plenty for everyone during the CQ Magazine's radiosport events.

There are usually many VK stations active during the CQ contests, either as

an individual effort or as part of a team – see results extract for CQWW CW for 2005. The contests themselves feature 'sub sections' within the contest for such entries, so that stations of similar attributes can effectively compete against each other on as level a playing field as can be provided. However, even a single operator can be an effective member of a team! How? Well, the contests allow for Club Teams to compete and VK has such a Club.

The VK Contest Club (VKCC) has been operating for a couple of years now, with a dedicated group of people around Australia 'grouping' together to maximise their overall score. Since the Club inception in 2004, VKCC members have entered most of the major international contests on CW, SSB and of course RTTY and have achieved some superb results. Maybe this approach for a Club entry could be incorporated into the results of some VK domestic contests – any comments anyone?

As overall Teams, VKCC Australis achieved a world ranking of 4th, VKCC Southern Lights achieved a world ranking

of 20th and as a Club overall, a world ranking of 19th – not bad at all for a fledgling Club effort! At this time of the sun spot cycle, 'all band' entries tend to have a significant leaning towards activity on the lower bands, so imagine what can be done when the cycle progresses a bit further and the higher bands come back into play a bit more. Having me in the QRP section getting a comparatively lower score doesn't add much to the total achieved, but the more the merrier!

The VKCC group comprises of a myriad of highly capable people willing to share their knowledge for the greater good, with an impressive knowledge range covering antennae, RTTY, operating techniques – you name it. Everyone with an interest in contesting is heartily welcome – either old hand at contesting or a newbie dipping a tentative toe into the contesting world. VKCC operate a Website which is worth a visit, so have a look at [www.vkcc.com.au](http://www.vkcc.com.au) to register and join in the fun. No question is ignored or thought-of as 'stupid', so ask away – I certainly have! It would be great for VKCC to put-in an expanded number of Teams for 2006 and beyond.

An ever increasing number of contesters pack their bags and head for exotic parts of the world in order to maximise their score during the contest with rare prefixes from rare islands, etc. Your humble scribe participated a few months ago in such a DXpedition to Norfolk Island as part of the international VI9NI team, to help celebrate the 150th anniversary of the arrival of the Bounty from Pitcairn Island in 1856. With 170 kg of equipment to transport, plus personal luggage, it was no mean feat to organise and full credit goes to Bill VK4FW and Eddie VK4AN for making the numerous arrangements required to make things run as smooth as possible. Bill and Eddie had amassed sufficient gear to allow simultaneous operation on multiple HF bands and on 6 m. We had a huge amount of help from the locals who made us feel very welcome and came to our aid to connect our network linkage and even a local archer to fire a couple of arrows into the top of nearby palm trees to erect our 160 m dipole! With a set-up such as this, technical issues are always likely to arise, and this trip was no exception. One of the rigs refused to be keyed for CW by the laptop, so an interface was constructed

## Norfolk Island Airp



VI9NI Team: Standing from L to R; Bill VK4FW, John VK5PO, Merv VK4DV, Phil VK2BAA. Kneeling L to R: Gary ZL2IFB, Eddie VK4AN. Photo: VK4AN



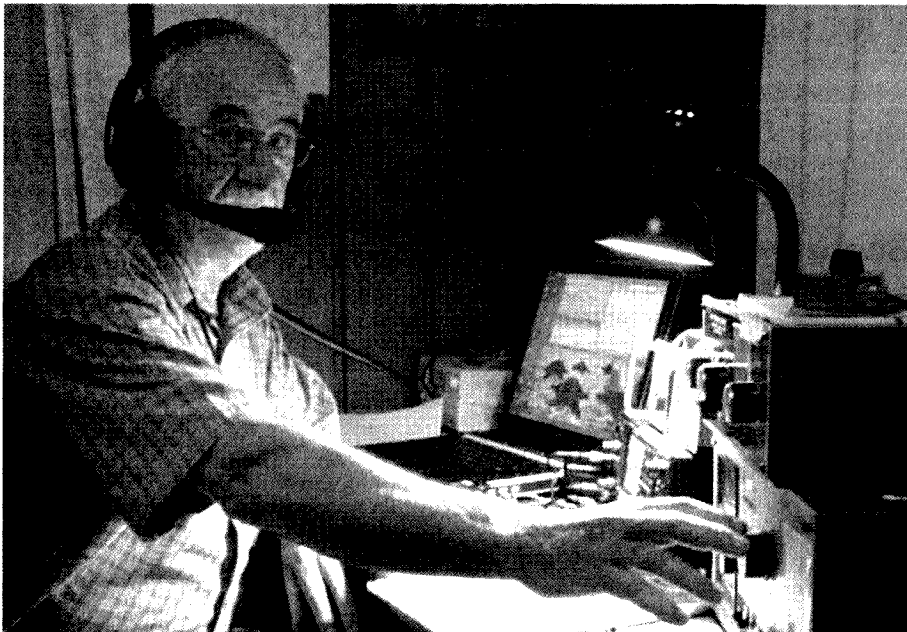

Ron VE7NS, during the VI9NI DXpedition. Photo: VK5PO

Contest take place at the end of the month and I've just got back from ZL6QH for the Contest, but more of that another time. This month sees the CQWW CW Contest (plug in your key and send some CW – it's what your right hand is for – and not for drinking lager!), and Spring VHF/UHF Field Day Contest. Late December and early January has the Ross Hull Memorial VHF Contest to offer and then the Summer VHF/UHF Field Day in January. The Ross Hull Contest rules are unchanged from last year so no need to be confused with scoring to hold you back from submitting a log. Why not get some kit ready and try a contest over the coming months for yourself – there's HF, VHF, CW, RTTY, SSB – something for everyone. Suitable logging software has been covered previously in this column for domestic contests and there are several more packages covering international contests also available. Some cost a few bucks and others are free, so have a try and select your favourite for a given contest and get on the air. Pen and paper can still be used of course!

If you have any contest related material for inclusion within the column, topics that you'd like covered or even some experiences and pictures you'd like to share, then please feel free to get in touch via vk2baa@wia.org.au. See you on the bands.

73 de VK2BAA Phil Smeaton

from the available components to affect a cure. Try finding resistors etc on an island that generally likes to close its shops at 1 pm on a Saturday afternoon – no mean feat! A simple single transistor switching circuit was quickly assembled from parts salvaged from the contents of Bill's 'we might need these' box and we got on the air to test everything out and ensure that the network and logging software all functioned properly.

The island trip coincided with the CQ WPX CW contest, so four of us took full advantage and wasted no time in setting-up a 'Multi 2' (multiple operators, two transmitters) all-band station within our accommodation. We applied for and were fortunate to be allocated a special callsign, VI9NI, and the combination of an exotic Pacific island location and a unique callsign helped us to promote Norfolk Island to people all over the globe – after all, it's a special event so a special callsign seemed appropriate. We operated for the full 48 hours of the contest on a rotating basis, taking advantage of propagation wherever we could. The wonderful thing about operating from a location such as Norfolk Island is that the background noise is exceptionally low, making weak signal reception much easier on the ears – except for the static crashes of course!

As an ad-hoc team (generally, we'd not met one another previously) we managed to put just over 1,600 QSOs and 586 multipliers into the log for a claimed score of 3,344,302 points. Very pleasing and great fun.

We also wrote an article for the local newspaper while we were on the Island, so that we could capitalise on as much positive publicity for the hobby as we could. We had a ball, and I'd thoroughly recommend such a trip to anyone.

Members of the Team hailed from VK, ZL and VE – see photos. Missing from this particular picture is Ron VE7NS, but he can be seen in the next picture, in full flight.

October just saw the CQWW SSB

## PERSONALISED QSL CARDS

**W.A.R.C.**  
Progress through Activity

**Westlakes Amateur Radio Club Inc.**

**VK2ATZ**

PO Box 3001  
Teralba NSW 2284  
Australia

ITU Zone 69  
CQ Zone 30

Your supplied Club logo here

Operator's name					
Confirming Contact with..					
Rig:	Date	Time	Freq	Mode	R.S.T
Antenna:				Pse. QSL via Bureau	

Personalised QSL cards bearing your callsign, Club's name and supplied logo. White gloss card, full colour with WIA logo watermark if a WIA member. Alternative microphone if not. 25 cents per card. Orders in batches of 4, Minimum order 40 cards. plus postage.

Email: flusa@optusnet.com.au with details

This is a Westlakes Amateur Radio Club Project

# Ross Hull Memorial VHF-UHF Contest 2006 - 2007

John Martin (VK3KWA), contest manager

The next Ross Hull Contest will run from December 26 to January 15. Logs will be due by February 5. The rules are the same as for last year. After the next contest, there will be a further review of the rules with significant changes likely for 2007 - 2008.

## The Contest

The WIA maintains a perpetual trophy in honour of the late Ross A. Hull and his pioneering achievements in VHF and UHF operation. The name of each year's contest winner is engraved on the trophy, and other awards may be made in the various divisions of the contest. The contest is open to all amateurs.

## Duration

0000 UTC Sunday December 26, 2006 to 2400 UTC Sunday January 14, 2007.

In Eastern Summer Time, that is 11 a.m. on December 26 to 11 a.m. on January 15.

## Sections

A: VHF - UHF (50 MHz through to 1296 MHz), non-digital modes.

B: Microwaves (1296 MHz and above), non-digital modes.

C: Digital Modes, all bands.

Digital modes are defined as those in which the decoding of the received signal is done by a computer. Entrants may submit logs for one or more sections.

## General Rules

One callsign and one operator per station. You may claim one contact per station per band per UTC day. Repeater, satellite and cross band contacts are not permitted. No contest activity is permitted below 50.150 MHz. In Sections A and B, entrants making contact on recognised DX calling frequencies should not occupy these frequencies for prolonged periods. All rulings of the contest manager will be accepted as final.

## Valid Contacts

For Sections A and B, entrants must exchange RS (or RST) reports plus a serial number. Serial numbers need not be consecutive. For difficult propagation modes such as meteor scatter, exchange of callsigns plus two further digits is

sufficient. For Section C, exchange callsigns plus two further digits that cannot be predicted by the other station.

## Scoring

Scoring will be based on the best 7 UTC days nominated by the entrant. Each contact will be scored as follows:

For 2 metres and above, one point per 100 km or part thereof (i.e. up to 99 km: 1 point, 100 - 199 km: 2 points, etc).

For 6 metres only, contacts below 1000 km: as above. Contacts from 1000 km to 2400 km, 2 points regardless of distance. Contacts over 2400 km, 20 points regardless of distance.

The band multipliers are:

6 m	2 m	70 cm	23 cm	Higher
x 1	x 3	x 5	x 8	x 10

## Logs

Logs must cover the full contest period and contain the following for each contact:

- Date and UTC time.
- Station location (if operating portable).
- Frequency and callsign of station worked.
- Reports and serial numbers sent and received.
- Approximate location or grid locator of station worked.
- Estimated distance worked and points claimed, including the band multiplier.

Separate scoring columns for each band would be helpful.

## Cover Sheet

Logs must be supplied with a cover sheet containing:

- Operator's callsign, name and address.
- Station location (if different from the postal address).
- Section(s) entered, and a list of the UTC days to be scored.
- A scoring table set out as the example.
- A signed declaration that the station has been operated in accordance with the rules and spirit of the contest, and that the contest manager's ruling will be accepted as final.

Please use the following format for

your scoring table. If you wish you can cross-check by adding the daily totals across the table, but please make sure that you include the separate band totals.

Date	6 m	2 m	70 cm	23 cm	etc
Day 1	xxx	xxx	xxx	xxx	xxx
Day 2	xxx	xxx	xxx	xxx	xxx
etc.					
Total	xxx + xxx + xxx + xxx + xxx				
	= xxx (GRAND TOTAL)				

A sample cover sheet and scoring table has been included in the postings on WIA web sites and the VK-VHF e-mail reflector. Copies can also be obtained from the e-mail address given below.

## Penalties

Minor errors in distance estimates or calculations may be corrected and the score adjusted. Prolonged use of recognised DX calling frequencies (especially when the reports indicate strong signals) may incur a scoring penalty. Inclusion of any false log entries will lead to disqualification.

## Entries

Paper logs may be posted to the Manager, Ross Hull Contest, 3 Vernal Avenue, Mitcham, Vic 3132. Electronic logs can be e-mailed to vhf-contests@wia.org.au. The following log formats are acceptable: ASCII text, Office 97 or Office 2000 RTF, DOC, XLS or MDB.

Logs must be received by Monday, February 5, 2006. Early logs would be appreciated.

## Note on Calculating Distances

Absolute accuracy is not required. You just need to know whether each station is above or below the nearest multiple of 100 km, so you can use a compass to draw 100 km circles around your location on a map. A more accurate method is to use six-digit Maidenhead locators and a computer program that can be obtained by emailing the address given above. (The program has just been updated to version 3.)

**WIA ROSS HULL MEMORIAL VHF-UHF CONTEST**

Dec 20\_\_ - Jan 20\_\_

Contest data:

Call sign:  
Section entered:

Operator's name:

Station location:

Postal address:

Postcode:

**Declaration**

The station was operated in accordance within the rules and spirit of the contest. I agree to accept the Contest Manager's decision as final.

Signature:

**SCORING TABLE**

Date	50 MHz	144 MHz	432 MHz	1296 MHz	2.4 GHz	3.4 GHz	5.7 GHz	10 GHz	Other	Day Total
1										
2										
3										
4										
5										
6										
7										

**BAND TOTALS**

**TOTAL CLAIMED SCORE FOR BEST 7 DAYS**

**COMMENTS OR SUGGESTIONS:**

# 26th ALARA Contest Results

Marilyn VK3DMS

## 26/27th August, 2006

Diane VK4KYL	1169	Top overall, Top phone, Top VK YL non-member
Catherine VK4FRED	911	Top VK ALARA member, Top Foundation licensee, Top VK4 ALARA member
Pam VK4FABB	735	
Nora VK5NYD	685	
Pat VK3OZ	514	Top VK YL CW, Top VK3 ALARA member
Rose VK2HOP	466	Top VK2 ALARA member
Gerald VK2HBG	455	Top VK OM
Rosanne VK7NAW	416	Top VK7 ALARA member
Chris VK2LCD	407	
Michele VK3FEAT	398	Top VK SWL
Gwen VK3DYL	381	
Leanne VK4PKT	286	
Mike VK3AVV	260	
Dot VK2DB	248	
Robyn VK3WX	247	
Susan VK7LUV	240	
Mal VK2HSV	235	
Alan VK8AV	234	
Kate VK4XYL	226	
David VK5AYD	220	
Marilyn VK3DMS	188	CHECK LOG
Margaret VK4AOE	167	
Brian VK3FIDX	151	
Bev ZL1OS	141	Top DX ALARA member
Jenny VK5ANW	137	Top VK5 ALARA member
Christine VK5CTY	136	
Shirley VK5JSH	114	
Allen VK5FD	107	
Kathy VK3XBA	85	
Gerard VK2IO	83	
Alan VK7JAB	77	
Dana VK3HHL	73	
Mavis VK3KS	58	
Bron VK3DYF	49	
Elizabeth VE7YL	35	Top VE ALARA member
Elva ZL1BIZ	30	
Philip VK2XPL	15	
<b>SUMMARY:</b>	<b>ALARA</b>	
	<b>YL non-members 4</b>	
	<b>Oms 11</b>	
<b>TOTAL LOGS</b>	<b>37</b>	

This year was an even better year than 2005. Conditions were excellent, with most of the activity taking place on 40 and 80 metres, and we had the greatest number of participants since 1993! Everyone seemed to thoroughly enjoy the Contest, with many comments about how friendly it was. After all, that's how we want it to be. One big change this year was the number of logs received by email – 26 out of the total of 37! As usual, unfortunately, there were quite a number of calls

Continued next page

# Spotlight on SWLing

Robin Harwood VK7RH.

This year is rapidly coming to a close. So much has happened to me personally and I have recently been under quite a deal of pressure that I have not been able to pay much attention to what has been going on shortwave.

Apparently a new sunspot cycle commenced in mid September and I expect that propagation will slowly climb back up. Already the higher frequencies are opening up in the evening hours.

You may recollect that Radio St. Helena made a few shortwave broadcasts on a disused point to point channel a few years ago. Propagation to this area was virtually non-existent. Because of personnel changes and the sender being dismantled, Radio St. Helena in the South Atlantic went silent. Many missed out and a band of DX enthusiasts were keen to reactivate this rare station on HF. Radio St. Helena, naturally, continued on FM and MW yet they were motivated to obtain suitable senders and a rotatable antenna to put Radio St. Helena back on shortwave.

Here is the official information about the "RSD REVIVAL" broadcasts from Radio St. Helena.

RSH will transmit on 11092.5 kHz in Upper Side Band mode on Saturday, 04. November 2006 at the following times:

1800 - 1930 UTC to New Zealand (via short path)

2000 - 2130 UTC to JAPAN (via short path)

2200 - 2330 UTC to Europe

2330 (Sat.) - 0100 (Sunday) UTC to North America

I personally wonder if there will be propagation to this area, judging by these times. We can only hope! "There will be a new and interesting QSL card for this "Revival" broadcast. It will take several months to process the reception reports, so please be patient. Only reception reports sent by regular mail will be accepted. Email-reports will NOT be accepted. Return postage is absolutely required and is "at least" three IRC's or "Greenstamps". All reports should be addressed to the Station Manager of RSH."

Warfare in Lebanon ceased and an international peace keeping force moved into the border regions, facing northern Israel. An uneasy truce exists. I have been hearing those spy number stations all over the lower HF bands and many are targeting the Middle East. As well, tensions have escalated in the Caucasian regions between Georgia and Russia with official and clandestine stations engaged in propaganda. This region has been extremely unstable for centuries with frequent ethnic based conflicts. The

present Arab-Israeli conflict is only recent history compared to the long running ethnic and cultural feuds that have been there forever.

Is shortwave dead and has it passed its use by date? More organisations are opting out for internet delivery and especially pod-casting. However, it is apparent that the internet is prone to censorship and some now are questioning if they may have been too hasty to write shortwave off.

The recent coup in Thailand when the military turned off domestic relays of foreign radio and television stations and the closure of the community based broadcasters saw the hurried re-establishment of shortwave broadcasts beamed to Thailand. The BBC must have been regretting their decision to close Thai language services. The VOA was scheduled to close Thai but hurriedly increased their output following the coup. Also the HF relay stations of the BBC and VOA in Thailand were briefly closed.

Well that is all for this month. Please send me your comments to vk7rh@wia.org.au or snail mail to 20/177 Penquite Road, Norwood Tas 7250.

73 de VK7RH

ar

## 26th ALARA Contest Results *continued*

heard for which no log was received. It doesn't matter how small the number of contacts, the log is welcome.

Some of the comments made this year: "Most enjoyable"... "I had a ball"... "A really great ALARA Contest"... "A great time on air"... "So pleasing to hear so many ALARA members and great to work the new call signs too"... "Good to hear so many people contesting"... "It was great to hear the foundation licensees in the thick of it"... "Just a mini log but still enjoyed the opportunity"...

I am sure that those Foundation licensees who took part can be very proud of their efforts. As can be seen,

an ALARA Foundation licence member had the second top score – well done Catherine VK4FRED! You will be receiving a special trophy to celebrate your achievement. The top score of 1169 points was truly terrific – congratulations to Diane VK4KYL. We welcome a new OM winner this year – Gerald VK2HBG – hope you try again next year. Unfortunately there was very little participation from DX members, but much of this is probably due to the bands, which are not brilliant for DX.

However Elizabeth VE7YL, Elva ZL1BIZ, Celia ZL1ALK and Bev ZL1IOS

were heard and we all welcomed our contacts with them.

The earlier closing date of September 30 does not seem to have inconvenienced anybody, and it certainly means that I can get the results out much sooner than before.

Now we all hope that 2007 will be as good if not better than 2006, with even more taking part. The 2007 Contest will be held on August 25/26, so mark it in your diary, and we'll all catch each other again then. Until then, best wishes to all, and thank you for taking part this year.

ar

John VK40Q,

P.O. Box 7665, Toowoomba Mail Centre, QLD 4352.

Email: john.bazley@bigpond.com

Well we really have got some exceptional DXpeditions to look forward to at the end of this year and the early part of next year. Probably the most wanted entity is LAKSHADWEEP ISLANDS due to take place in December 2006.

The National Institute of Amateur Radio (NIAR) has announced that the Lakshadweep Islands (VU7), the #2 Most Wanted DXCC Entity, will be activated from 1st December to the 10th. Approximately 70 multinational and 30 Indian operators are expected to travel from Kochin, India, by boat to Lakshadweep. Plans are to operate as VU7RG (requested call, in memory of the late Rajiv Gandhi, VU2RG, former Prime Minister of India) from three "excellent and well organized sites". An International Advisory Committee (IAC) is constituted under the chairmanship of Mr. S. Suri VU2MY to organise the event. A Sub-Committee - including Frank Rosenkranz DL4KQ (Chairman), Kyoko Miyoshi R3MVF, Martti Laine OH2BH and Glenn Johnson W0GJ (members) and S. Ram Mohan VU2MYH (convenor) - will deal with the requirements and coordination of the international participants. Further information will be released exclusively by NIAR ([www.niar.org](http://www.niar.org)).

The official VU7 Lakshadweep webpage is now online at <http://www.vu7.in/>.

**XF4** - A large group of operators from Mexico (XE1AY, XE1FRF, XE1FXF, XE1FXM, XE1FXZ, XE1GRR, XE1HBU, XE1MMB, XE1UN, XE2K) and Germany (DF7TH, DJ5IW, DK2WV, DL1YFF, DL3DXX, DL8LE) will operate on all bands and modes (EME and satellite included) as XF4DL from Isla Socorro (NA-030), Revillagigedo from 17 October to 3 November. They plan to have up to five stations operating simultaneously, and to focus on the WARC and low bands, and on digital modes (RTTY and PSK63). Further information can be found at <http://www.xf4dl.xedx.org/>. Weather permitting, at the end of the operation they will be active "for several hours" as XF4K from Clarion Island (NA-115). QSL via XE1KK (Mexico only), N6AWD (rest of the Americas) or DL9NDS (rest of the world). Contributions to help defray the significant costs of this DXpedition will

be gratefully accepted; please contact DL8LE or XE2K for details.

**S2 - DXpedition project BANGLADESH 2007**, which has been in the planning stage over the last two years, will now take place in mid-January 2007. A group of Spanish Amateur Radio operators will be QRV as S21EA between January 10th and 16th. They are Josep EA3BT (team leader), Tony EA2PA, Nuria EA3WL (YL), Fer EA5FX, and Juan EA8CAC. Plans are for activity on 6 through 160 metres on CW, SSB and RTTY. "Our aim is to give the new one to the maximum number of station(s), and that's why we will have 3 station(s) on the air simultaneously" says team leader Josep EA3BT. A DXpedition Web page is in the plans and will eventually be posted at <http://www.ea3bt.com/s21ea.html>. QSL via EA3BT either direct or via the bureau.

**SV2ASP/A - Monk Apollo** has been away for most of his summer and it is not exactly clear when he will be going back to Mount Athos. Kostas SV1DPI has now sent him a homemade interface for use on RTTY and PSK31. Apollo used to be active on RTTY, but has not been over the last three years due to a faulty TNC. NCDXA donated a new one but unfortunately Apollo has not been able to get it running. He likes using RTTY and can manage the pileups better, which may mean more activity from Mount Athos as it causes less noise for the other monks. Tony LZ1JZ (lz1jz1@gmail.com) has donated a new QSL design, which is a four sided folded card and can be seen at <http://www.dailydx.com/sv2asp.htm>. If you work SV2ASP/A and need confirmation, make sure you QSL via Monk Apollo's QRZ.COM address. It does work and he is very reliable at confirming contacts.

**ZL9** - For those of you who worked ZL9BSJ/P (ZL2BSJ) we have good news: he was genuine! However, for those who missed Bert, it could be a while before the next ZL9 operation. Bert works for New Zealand's weather service and sails to the Campbell Island area once or twice a year. If he is lucky, and has some spare time, he operates from the wharf for a few hours before heading back out to sea. Lee ZL2AL said that when ZL9BSJ/P was QRV recently, he made 133 QSOs.

The QSOs were all hand logged as Bert's battery on his computer had failed. The weather cut the operation short. The bad news is that future operations, by weather service personnel, are going to be more difficult as they will probably only be spending one day in the area.

**FO - Pierre F5JFU** will operate holiday style on 10, 15 and 20 metres (maybe also 40 m) CW, SSB and maybe RTTY as FO/F5JFU from French Polynesia from 21 October to 19 November. He will visit three islands: Tahiti (OC-046, DIFO FO-002), Moorea (OC-046, DIFO FO-010) and Bora-Bora (OC-067, DIFO FO-003). QSL via home call, direct or bureau.

**C6** - During the CQ World Wide CW DX Contest at the end of November, N3DXX will be operating from the Bahamas. He'll use C6/home call or possibly a full C6A call. QSL via KN5H.

**TT8 - Philippe F4EGS** will once again be QRV as TT8PK from Chad from September 20th until November 20th. Look for activity on 10 through 40 metres on SSB and the digital modes. For possible skeds send an email to [cocheese@laposte.net](mailto:cocheese@laposte.net).

**XU - Tony KM00** will be on his way to Cambodia. He plans to start up on November 20th and be QRV as XU7MWA including the CQ WW CW Contest. He'll be single-op all-band. QSL route is yet to be announced.

**J3 - Bill Nelson VE3EBN** plans to be QRV as J37LR/J37T from Grenada from October 19th to November 26th. He'll be on all bands on CW, SSB and PSK31.

**V51 - Klaus DJ4SO** will spend three weeks at the Hohewarte Guestfarm in Namibia. While there, he will be QRV as V51/DJ4SO on 6 metres through 160 metres on CW and RTTY/PSK31. Klaus will put a special emphasis on the low bands. Look for activity from November 11th to December 1st, including the CQ WW CW DX Contest. QSL via DJ4SO direct, via the bureau or LOTW.

Special thanks to the authors of *The Daily DX (W3UR)* and *425 Dx News (1I1QJ)* for information appearing in this month's *DX News & Views*.

For interested readers you can obtain from W3UR a free two week trial from [www.dailydx.com/order.htm](http://www.dailydx.com/order.htm).

ar

---

# Over to you

---

## Communications

The title of this letter is 'Communications' because today, 23 September 2006, is my 91st Birthday; my name is Stan, my callsign is G3XON and my QTH is Shalford, England.

Now I will explain the really interesting part of this message: While cruising round 20 metres on 21st February 1990 I heard VK7KH on 14.139 MHz and gave a call. Back he came and we exchanged reports in the usual way followed by a nice first time 18 minute QSO, learning that his name was Ken and his QTH was Burnie, Tasmania.

Just before we signed off, I happened to mention that I was born in the month of September. To my amazement Ken came back and said that he was also born in September - the 23rd in fact! Wow! It may be hard to believe but I was also born on the 23rd September, and from that day on our friendship was cemented!

Thus, from February 1990 to this very day, Ken and I have kept in contact one way or another on a regular basis,

certainly within a week or so, sometimes more frequent. Communication is what this is all about and our friendship has now grown to include our families. I cannot overrate the pleasure this aspect of amateur radio has meant to us!

Needless to say that we NEVER forget the 23rd September! As each year comes round we usually exchange something or other for the occasion. Today, my birthday, I have received from Ken nothing less than a splendid copy of the August issue of your *Amateur Radio* magazine - The Journal of the Wireless Institute of Australia.

This issue of the *AR* magazine is particularly appropriate inasmuch that it features The Centenary of Australia's first overseas wireless transmission in 1906, and some splendid pictures. I am currently preparing a fairly exhaustive Power Point slide presentation lasting about 60 minutes, covering historical interests of telegraphy and early wireless

from the 19th Century to the 1930s and of course Guglielmo Marconi.

I plan to give the above presentation at our newly formed Wey Valley Amateur Radio Group, Guildford, in November this year. I am a founder member of this Group and I feel that I owe them quite a lot! I will be exhibiting crystal and valve wireless sets, loudspeakers and associated items of the 1920s. To mention that my Uncle Chris worked for Marconi is perhaps why I have always had an interest in wireless. I helped to build my first one valve set in 1924.

Please forgive this rather long message that has become an article, but it suddenly occurred to me that you or some of your readers may be interested. With Amateur Radio, one can never be sure what excitement is in store, and reading your *AR* Magazine and making Communications is foremost!

**Stanley Casperd, G3XON,**  
Shalford, Surrey GU4 8DD, ENGLAND.  
23 September 2006

---

# Silent Key

---

## James Mourilyan Swan VK2BQS

I wish to advise of the passing of my husband James Mourilyan Swan VK2BQS, aged 84 years, on Monday 18th September, 2006.

Jim was cremated at Newcastle Memorial Park with a celebration of his life, and with the local branch of the R.S.L. giving a moving 'Tribute'.

Jim was a loving honourable man who took pride in his family, friends, community and his country. His love of 'radio' gave him much pleasure.

He will be sadly missed by many.

**Submitted by Helen M. Swan**

Jim Swan ex-VK2BQS became a Silent Key on 18th September 2006 at age 84, after a long illness resulting from several strokes. He was cremated on 21st September at Beresfield.

Jim was born 1922 in Parramatta NSW. Shortly after, his family moved to Girraween near Parramatta, where he lived for 73 years before ending his days at Karuah, north of Newcastle.

Jim joined the Royal Australian Air

Force the day he turned 18 and shortly afterwards he had commenced training as a pilot. He remained in the service until the last day of the wartime Air Force. The RAAF experience ranged from Coastal Search and Surveillance, through Test and Ferry to Operational Recce and Bombing Strikes in the East Indies area.

By late 1946, Jim had joined Trans Australia Airlines as a Pilot (First Officer) becoming a Captain (Training Captain) by 1954. At that time he transferred to East West Airlines to assist them in their expansion program. He retired in 1975 as Chief Pilot, after being responsible for the pilot standards on the various operated by the company. He had over 21,000 hours and had flown 18 types of aircraft.

When Jim retired, he found he still missed a component of his flying days, and that was the continuous use of radio communications where he had a Flight Radiotelephone Operators Licence with a 20 wpm Morse endorsement.

After a short stint on CB radio, Jim was first licensed in December 1977 as

VK2NNG, and upgraded in June 1978 to the Full Call VK2BQS.

Jim's favourite mode was radio teletype, which he commenced using in 1981. He became a member of the Australian National Amateur Radio Teleprinter Society, or ANARTS. He later moved into AMTOR, using that mode to transfer ANARTS broadcast material to relay officers, and also acted as a relay station on 20 metres. This was very rewarding for Jim, as he developed a large following and had call-backs from every state and some DX stations regularly.

Jim also assisted Col VK2CTD with the running of the ANARTS RTTY Contest where he could, and so helped keep ANARTS thriving.

For a much fuller report on Jim's life, go to:

<http://users.bigpond.net.au/ctdavies/Jimspage.htm>

Vale Jim ex-VK2BQS

**submitted by Pat Leeper VK2JPA**  
ANARTS Secretary

## Weak Signal

David Smith - VK3HZ

The weather gurus are making dire predictions for the coming summer. It looks like we're in for a long, hot, dry period and indications are that it has already started, with one of the hottest and driest Septembers on record. However, for VHF/UHF enthusiasts, there is a positive aspect to all this. We could be in for a very good DX season with lots of slow-moving high pressures cells and associated ducting. Keep an eye on the Hepburn Tropo Ducting Forecast site: [www.dxinfocentre.com/tropo\\_au.html](http://www.dxinfocentre.com/tropo_au.html) And, almost on cue, the first VHF opening across the pond to New Zealand occurred on September 24th. At about 0700Z, Nick ZL1IU worked Ross VK2DVZ (5/5) in Taree and Steve VK2ZT (5/5) near Newcastle, both on 2 m.

On the morning of October 4th, conditions were generally good from the Adelaide region across Victoria and up into northern NSW. Mark VK2EMA and Leigh VK2KRR both reported hearing the VK5VF 2 m beacon at S5. Leigh worked Brian VK5UBC (5/6) on 2 m, and Phil VK5AKK on 2 m (5/9+), 70 cm (5/9) and they could hear each other's carriers on 23 cm, but no contact was made. Brian VK5UBC reports working VK2KRR, VK3WN, VK2EMA, VK3HZ, VK3VG, VK3ANP, VK3RW and VK3II on 2 m and VK3VG and VK3YLV on 70 cm.

## Spring VHF-UHF Field Day

A reminder that the Spring VHF-UHF Field Day is on the weekend of November 11th and 12th. Even if you do not intend to go out portable, please take the time to provide contacts for those who do.

## 13 cm Band

Anyone who is active on the 13 cm band (2.4 GHz) would be well aware that it is becoming less usable day by day. The interference resulting from the insidious spread of WiFi, cordless phones, AV senders, microwave ovens ... and on the list goes ... is gradually filling the weak signal end of the band with spurious and noise. I even have a problem at the home QTH with 2.4 GHz consumer items interfering with each other - the WiFi gets

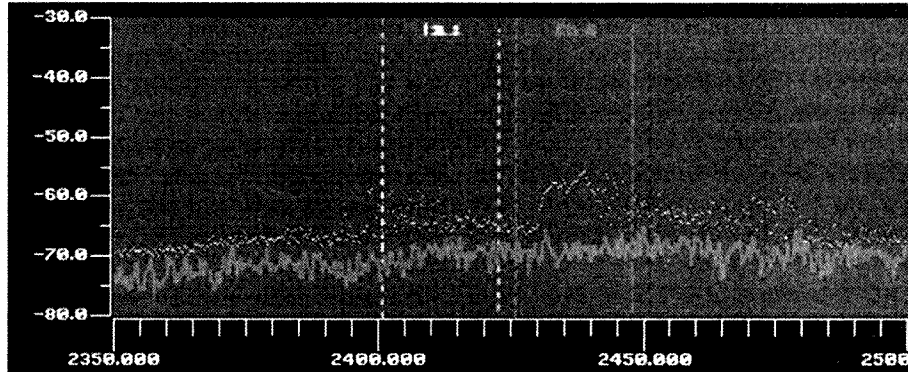

into the AV sender, and don't microwave anything while trying to make a call on the cordless phone! One of our American brethren hooked his spectrum analyser up to an antenna and recorded the spectrum in the picture above.

The "grass" is probably WiFi, cordless phones and the like, while the broadband interference is probably an AV sender. It clearly shows that the area in which we operate for weak signal operation - 2403 MHz - is being swamped with interference.

Going back a few years, our allocation covered the range 2300 to 2450 MHz. The advent of microwave Pay TV systems like Galaxy and Austar in that frequency band saw our portion drastically reduced to 2400 to 2450 GHz. However, one little-known fact is that we still retain a small allocation from 2300 to 2302 MHz. The Pay TV systems now seem to have largely self-destructed, so the bottom end of our old allocation may be relatively free of interference. Perhaps it would be more logical for us to operate in the 2.3 GHz area, well away from the chaos at 2.4 GHz. I'd be interested to hear from anyone who has any knowledge of the state of the 2300 to 2302 MHz portion of the band.

*(Editor's Note: On the Summer VHF/UHF Field Day this year, contact from the area around Neerim South was impossible anywhere around 2403 MHz, due to Wireless LAN traffic. I did have success using 2400.1 MHz. This was possible as our transverters have the local oscillator set for 144.1 MHz coming out at 2400.1 MHz. We normally operate with the IF*

*at 147.1 MHz, giving 2403.1 MHz as the input/output frequency. This also allows the system to be used for receive on the S-band downlink from amateur satellites.)*

## Aircraft Enhanced Propagation

Barry VK3BJM near Kyneton in central Victoria writes about some interesting AEP efforts:

*A few notes on contacts from Saturday morning (26/11/05). The normal AEP shindig was nearly finished, when Peter VK5ZLX asked me (via the VK Logger) if I wanted to have another go with the AEP "window" we'd observed back on the 28th of October. I agreed, and checked the on-line arrivals schedule for Melbourne Airport. The Virgin flight 536 (from Adelaide to Melbourne) was due to land at 2300Z (1000 EDST), so assuming that it would start to be in position 30-35 minutes before landing, I started calling at 2222Z. We had a weak troppo path to start with (51 each way) but after about 2 minutes flutter became apparent on the signals before they became more solid as they built to the 56 report I gave Peter, and the 58 he gave me. That strength of signal stayed until about 2234, when it dropped sharply to the normal troppo level at 2235.*

*By chance, I called CQ again at 2239Z, and Peter came back at 55, giving me another 58! We had another aircraft in the path, so I went back to the Melbourne Airport website to find which one it could be. I checked the domestic flights, neither QANTAS or Virgin (or anyone else) had anything due that would be travelling that*

route. I then checked the international arrivals board, and found a Singapore Airlines flight (SQ237 from Hong Kong) due to land about 10 minutes after the Virgin flight.

I went back to the arrivals — QANTAS had a flight from Adelaide due in Melbourne at 2350Z. I suggested via the Logger that we should try 70 cm. We got established on 2 m at 2309Z (55/58 again) before QSY'ing to 70 cm - unfortunately nothing was heard at either end. Signals on 2 m held up until 2317Z.

Seems like the Adelaide - Melbourne flight path can provide regular and predictable 10-minute AEP windows between Kyneton and the Barossa. My next intention is to see if the path will provide enhancement further south from Peter's QTH (to Brian VK5UBC in Gawler, for instance), and if so determine the difference in the time calculation.

Peter and I also need to have a few more goes at AE on 70 cm.

The path won't provide enhancement into Adelaide proper; the only place the path will intersect with my beam heading to Adelaide is somewhere near the northern end of the Adelaide Airport runway...

My apologies to Barry that this item was waylaid for so long. Perhaps the next

section on ADS-B could be of interest to him for prediction of AEP events.

## ADS-B

In the June issue, I spoke about the ADS-B system where aircraft regularly transmit data packets containing such items as their position and identification, on 1090 MHz. A UK company — Kinetics — makes a decoder box with software to turn your PC into a pretend air traffic control display.

Now a Sydney-based enthusiast has set up a web site to merge data from decoder boxes around the world and present the result on a Google Earth display: [www.openatc.com](http://www.openatc.com)

In Australia, there are currently semi-permanent data feeds from Sydney, Melbourne and Brisbane with a temporary one (sometimes offline) around Hobart. There are more to come. The range seems to be up to about 400 km, so coverage between Hobart, Melbourne and Sydney is almost continuous.

ADS-B-enabled aircraft are still few — mostly big internationals and those less than 3 years old. So there can be times when not a lot of aircraft can be seen. This will improve as ADS-B becomes mandated on all aircraft in 2009.

So next time there's a huge Aircraft-

enhanced signal, check Google Earth to see if it's due to an aircraft with ADS-B.

## VK-ZL Propagation Logger

Finally, another plug for what I consider one of the most valuable Internet resources for the VK VHF/UHF enthusiast — the VK-ZL Propagation Logger: [www.vklogger.com](http://www.vklogger.com)

The logger provides valuable real-time information about the state of the bands, as well as a wealth of useful background information on beacons, events, VHF operator information, etc.

Adam VK4CP is the creator, administrator and general dogsbody behind the site, and somehow also finds time to operate his radios. Adam also funds the site, which resides on a commercial server in order to provide the reliability, bandwidth and rapid response time expected of such a resource. Although he doesn't publicise the fact, contributions to the running costs of the site are very welcome. If you find the site useful, consider helping Adam out with the costs. There is a Donate button on the main page that provides more information.

Please send any Weak Signal reports to David VK3HZ at [vk3hz@wia.org.au](mailto:vk3hz@wia.org.au).

## Digital DX Modes

Rex Moncur — VK7MO

The EME echo mode on the older versions of WSJT (Version 4) can be a useful indicator of system performance but there are some issues relating to EME one must take into account to achieve best results.

1. Faraday rotation
2. Amplitude variations due to libration
3. Frequency spreading due to libration

The way the echo mode works is that it transmits a signal for 2 seconds, waits for 0.5 second when the signal is about to return from the moon, receives and records this signal for 2 seconds, averages the signal for as many periods as desired, reports the results and keeps repeating this process. The program also provides a spectrum that shows the spread of the signal which might for example be due to libration frequency spreading. Through the use of the averaging process and the spectrum display one can detect average echoes at low as -38 dB on the

WSJT scale. It is possible to reset the average manually after each echo if one is interested in studying the variation of the signal amplitude and frequency spreading of individual echoes. All these separate echoes are recorded in the decode.cum file and can be copied into a spreadsheet for more detailed processing.

Version 4.9.8 of WSJT, which includes the echo mode, can be downloaded at: <http://pulsar.princeton.edu/~joe/K1JT/Download.htm>

The echo mode has not yet been included in the later versions of WSJT, although this is intended.

On the lower EME bands such as 50, 144 and 432 MHz, most stations use linear polarization and the strength of the returned echoes vary depending on whether the polarization of the returned signal is the same as your antenna. This variation cannot readily be predicted and can take from a few minutes on 50 MHz, to half an hour or more at 432 MHz to go through a peak. Variations due to this

effect can be up to 20 dB. The best one can do is to wait for the echoes to peak and take that as the measurement on which to base system performance. At 1296 MHz most stations use circular polarization and this avoids the problems of Faraday rotation.

Libration amplitude variations affect returned signals on a shorter times scale of seconds at 50 MHz, about a second at 144 down to one tenth of a second at 1296 MHz. These amplitude variations can be up to 10 dB or more between successive echoes at 1296 MHz and are still significant on the lower EME bands. The best one can do to overcome the libration amplitude variations is to average the amplitude over a number of echoes, but this does of course make it more difficult to find the peak if Faraday rotation is also involved. WSJT allows one to average the echoes for any period and typically at 1296 MHz an average of 50 readings gives results that are consistent to within plus or minus 1 dB.



WSJT measures echoes in bins of about 0.66 Hz bandwidth, but the signal can be spread due to libration over one or two bins at 144 MHz and up to ten bins at 1296 MHz. As WSJT reports the echo level in the peak bin, this can dramatically underestimate the echo energy if it is spread over many bins – by as much as 10 dB at 1296 MHz. To help overcome this problem, WSJT provides a “W” reading which represents the approximate width of the signal in Hz and thus gives an indication of the number of bins over which it is spread. For example, if the W is 6.6 Hz, then most of the signal is spread over ten 0.66 Hz bins. If all the energy was equally spread between these bins, the reported power would be one tenth of the actual and thus down by 10 dB. Now in practice the energy is not spread equally but more in a bell curve shape with more energy inside the closer bins but still some energy in the bins outside the reported W reading. However tests show that the W does give a reasonable indication of the average spread of the signal and thus can be used to calculate the actual average echo level.

Width “W” Hz	Correction dB
0.7	0.0
1.3	3.0
2.0	4.8
2.7	6.0
3.3	7.0
4.0	7.8
4.7	8.5
5.3	9.0
6.0	9.5
6.7	10.0
7.3	10.4
8.0	10.8
8.7	11.1
9.3	11.5
10.0	11.8

The table gives the correction one should

add in dB to the reported signal level for various values of reported W.

A typical example at 1296 might be:  
 Average echoes over 50 samples = -30 dB  
 W = 4.7 Hz, correction 8.5 dB  
 Corrected echo = -21.5 dB

Having measured a corrected echo, one needs a means of comparing this with the expected system performance. The WSJT program provides a calculator that can be used to estimate the expected echo for any particular equipment set up. The calculator gives the estimated echoes with reference to the noise in both a 2.5 kHz and 50 Hz bandwidth. Note the echoes are measured on the WSJT scale which applies to a nominal SSB passband of 2.5 kHz, so this is the reference to be used.

Doug VK3UM has produced a calculator (EMECalc3) that provides for a wider range of station parameters. If you use Doug’s program you need to set the bandwidth to 2.5 kHz to achieve comparable results. Doug’s program was recently updated and is available at:

[www.sm2cew.com/download.htm](http://www.sm2cew.com/download.htm)

Tests show that both calculators give similar results and at 1296 are within 2 or 3 dB of the measured

results. This is not too far off and the difference might reflect the fact that W does not fully measure the spread of reflected energy at 1296 MHz.

There is a question as to the optimum number of samples to use in the average when running linear polarization. This is a compromise between making the number too small and not having enough samples to get a good average due to libration amplitude variation, or making it too large and not finding the peak as Faraday varies. Fortunately, the variation of libration amplitude tends to drop with lower frequency while the speed of Faraday increases and there is the opportunity for reasonable compromises. While I don’t have enough data to determine the best compromise I think a reasonable starting point would be as follows when using linear polarisation:

50 MHz	10 samples
144 MHz	25 samples
432 MHz	50 samples
1296 MHz	50 samples

When using linear polarisation, the approach is to measure the echo over the desired number of samples and then reset the average on the WSJT program and make repeat measurements until one finds the best average which should result from the peaking of Faraday.

Please send any Digital DX Modes reports to Rex VK7MO at [rmoncur@bigpond.net.au](mailto:rmoncur@bigpond.net.au).

## The Magic Band – 6 m DX

Brian Cleland – VK5UBC/BC

There haven’t been any reports of openings during September.

On the morning of 6th October tropo conditions on 2 m and 70 cm were very good from my QTH to central Victoria, so 6 m was tried and, although signals were only S1, contacts were completed with Trevor VK3VG at Cobram (600 km) and David VK3ANP at Wangaratta (700 km) on 6 m tropo.

Further to the beacon listings in last month’s notes, it is pleasing to note that the Darwin beacon VK8VF is now back on air on 50.310 CW. Look forward to hearing the beacon and hope that there is some activity from Darwin during the coming summer.

In the Barossa Valley, Peter VK5ZLX has finished erecting his antennas with the last one to go up being a 9-element

40 foot long-boom 6 m Yagi (M2 antenna).

Pictured are Peter’s very impressive antennas, at the top a 32-element 70 cm Yagi, in the middle an 18-element 2 m Yagi with the 6 m Yagi at the bottom.

Hopefully, in November we will start to see the beginning of the summer DX season. Although it is the bottom of the sunspot cycle, we should still experience a good sporadic-E season with many openings around Australia and to our near Pacific neighbours. It is hoped all 6 m operators support and take part in the local DX and not wait for the sunspot

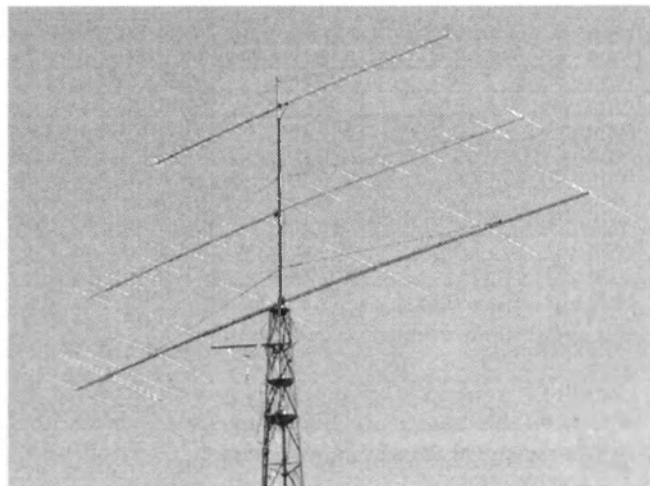

cycle to increase and the international DX to appear.

Please remember to send any 6 m information to Brian VK5UBC/BC at [bcleland@picknowl.com.au](mailto:bcleland@picknowl.com.au).

ar

# ANVDG 2005/2006 Long Distance Competition

Leigh Rainbird VK2KRR

Starting the 1st of July 2005 and finishing on the 30th June 2006 was the initial Australian National VHF DX Group (ANVDG) Long Distance Competition.

It was quite an interesting season and some big contacts were made by those with the right propagation knowledge, the right equipment, in the right locations and who were listening at the right times. Or perhaps just a bit of good luck?

The competition has two sections, a Weak Signal mode section and a FM DX section. Each section then has separate divisions (VK1, VK2, VK3 etc) and the top National contacts. Then sub categories. The top 4 contacts are listed in each category.

The FM DX section has two different categories, FMS (FM Simplex) and FMR (FM Repeater) and two bands only, 2 m and 70 cm. Contacts in the FM sections must be made with vertically polarised antennas to keep in the spirit of the FM section. FMS is a direct simplex two way

radio (not IRLP or repeater etc) contact between two stations. While the FMR contacts are paths from an operators QTH to a repeater station only, this does not include the distance to the station being worked via the repeater only the distance of one station to the repeater.

The Weak Signal mode section covers bands from 144 MHz to 10 GHz. There are many different Propagation mode categories. These are:

- Tropo B = Tropo Bight Path
- Tropo I = Tropo Inland
- Tropo T Sea = Tropo paths over the Tasman to ZL.
- Tropo BS = Tropo paths to VK7 over Bass Strait.
- TEP = Trans-Equatorial Propagation
- EME = Earth Moon Earth
- Aurora = Aurora Scatter
- Sporadic E = Sporadic E
- Meteor D = Digital Meteor Scatter
- AE = Aircraft Enhancement
- ATV = Amateur Television

Categories ending in D suffix are made digitally. For example, Tropo TD would be a Tropospheric contact over the Tasman Sea using a mode such as JT65b or similar.

Contacts with an (\*) at the end of the category designation means the contact was claimed by both stations. Otherwise the first callsign listed has claimed the contact for the contest.

Listed below is the list of all National best distances for all bands in which contacts were submitted. For the 1296 MHz section I have included the divisional contacts also. Divisional contacts for other bands can be viewed on the ANVDG website at <http://www.users.bigpond.com/anvdg/> and look for the link from the main page.

Whet your DX appetite on some of these beauties. Congratulations to all involved and let us see what comes our way in the 2006/2007 season.

## 144 MHz Weak Signal

Division/Category	Distance	Stations	Date
<b>NATIONAL</b>			
Top Overall Distance	2933 km	TropoB.VK2KRR, Lee, The Rock -- VK6JR, Wayne, Dunsborough, OF76mi	02.01.06
Top Overall Distance	2155 km	TropoB.VK5UBC, Brian, Gawler -- VK6AO, Cec, Perth OF77vw	06.03.06
Top Overall Distance	2102 km	Es.VK4MIK, Mike, Butchers Ck. -- VK3VG, Trevor, Kyabram	18.12.05
Top Overall Distance	1989 km	Es*. VK2KRR, Lee, The Rock -- VK4MIK, Mike, Butchers Ck.	18.12.05
Tropo - B	2933 km	VK2KRR, Lee, The Rock -- VK6JR, Wayne, Dunsborough, OF76mi	02.01.06
Tropo - B	2155 km	VK5UBC, Brian, Gawler -- VK6AO, Cec, Perth OF77vw	06.03.06
Tropo - B	1911 km	VK5UBC, Brian, Gawler -- VK6BE, Bob, Albany, OF84ww	05.03.06
Tropo - B	1900 km	VK5UBC, Brian, Gawler -- VK6WG, Wally, Albany	06.02.06
Tropo - BS	1126 km	VK5UBC, Brian, Corny Point -- VK7AC, Norm, QE38lp	10.01.06
Tropo - BS	1036 km	VK5UBC, Brian, Gawler -- VK7AC, Norm, QE38lp	27.02.06
Tropo - BS	1034 km	VK5UBC, Brian, Corny Point -- VK7YBI, Dion, QE28ww, Burnie	10.01.06
Tropo - BS	679 km	VK7HDX, Karl, Launceston, QE38nm -- VK5DK, Colin, Mt Gambier, QF02je.	08.01.06
Tropo - I	975 km	VK5UBC, Brian, Gawler -- VK2TWR, Rod, QF43pl	22.12.05
Tropo - I*	914 km	VK5UBC, Brian, Corny Point -- VK2KRR, Lee, The Rock, QF34mr	24.08.05
Tropo - I	894 km	VK2KRR, Lee, The Rock -- VK5ZPG, Peter, Quorn	16.04.06
Tropo - I	890 km	VK5AKK, Phil, Upper Sturt, PF94ix -- VK2TWR/p, Rod, QF44fb	13.01.06
Tropo - ID	894 km	VK2KRR, Lee, The Rock -- VK5ZPG, Peter, Quorn, PF97aq	24.09.05
Tropo - ID*	757 km	VK2KRR, Lee, The Rock -- VK5UBC, Gawler, Brian, PF95ji	10.08.05
Tropo - ID	750 km	VK2KRR, Lee, The Rock -- VK5ZK, Garry, Goolwa, PF94jl	18.09.05
Tropo - ID	735 km	VK2KRR, Lee, The Rock -- VK5ZLX, Peter, Barossa Valley, PF96mk	24.09.05
Sporadic E	2102 km	VK4MIK, Mike, Butchers Ck. -- VK3VG, Trevor, Kyabram	18.12.05
Sporadic E*	1989 km	VK4MIK, Mike, Butchers Ck. -- VK2KRR, Lee, The Rock	18.12.05
Sporadic E	1849 km	VK5UBC, Brian, Corny Point -- VK4TZL, Glen, OG64jq	02.01.06
Sporadic E	1804 km	VK2KRR, Lee, The Rock -- VK8GF, Jeff, Alice Springs, PG66wg	15.12.05
Aurora	627 km	VK2KRR, Lee, The Rock -- VK5DK, Colin, Mt Gambier	11.09.05
Aurora	552 km	VK2KRR, Lee, The Rock -- VK3ZQB, Russell, Port Fairy	11.09.05
Aurora	387 km	VK2KRR, Lee, The Rock -- VK3AXH, Ian, Ballarat	24.08.05
Aurora	379 km	VK2KRR, Lee, The Rock -- VK3ll, Jim, Coronet Bay, QF21rn	11.09.05
AE	456 km	VK4CDI, Phil, Hodgsonvale, OG52xh -- VK2DVZ, Ross, Port Macquarie	26.07.05
Meteor D	1739 km	VK4CDI, Phil, Hodgsonvale, OG52xh -- VK7MO, Rex, Hobart, QE37pc	31.07.05
Meteor D	1438 km	VK5PO, John, Eden Valley, PF95mo -- VK4CDI, Phil, Hodgsonvale, OG52xh	23.07.05
EME	17794 km	VK2KRR, Lee, The Rock -- EA1YV, Augustin, Spain.	10.01.06
EME	16601 km	VK2KRR, Lee, The Rock, QF34mr -- ON4GG, Geert, Belgium, JO20ar	05.09.05
EME	16295 km	VK4CDI, Phil, Hodgsonvale -- ON4GG, Geert, Belgium, JO20ar	10.08.05
EME	15993 km	VK2KRR, Lee, The Rock, QF34mr -- DL9MS, Joe, Germany, JO54wc	08.08.05

## 146 MHz FM Simplex & Repeaters

Division/ Category	Distance	Stations	Date
NATIONAL			
FMS - 1	1919 km	VK5UBC, Brian, Gawler -- VK6DM, Frank, Albany, OF84va	27.02.06
FMS - 2	1023 km	VK2KRR, Lee, The Rock -- VK5AEP, John, Port Lincoln	24.01.06
FMS - 3	947 km	VK2KRR, Lee, The Rock -- VK5AJW, Jim, Cowell	23.04.06
FMS - 4*	923 km	VK4MIK, Mike, Butchers Ck -- VK4JOO, Mike, Gladstone.	01.10.05
FMR - 1	2817 km	VK2KRR, Lee, The Rock -- VK6RMS, Boddington, Mt Saddleback	02.01.06
FMR - 2	2192 km	VK5UBC, Brian, Gawler -- VK6RMW, Mt William, Mandurah	06.03.06
FMR - 3	2086 km	VK4ABW, Gary, Bluewater -- FK8ZHA, Mount Do, New Caledonia	07.10.05
FMR - 4	2062 km	VK5UBC, Brian, Gawler -- VK6RMS, Mt Saddleback, Boddington	06.03.06

## 432 MHz Weak Signal

Division/ Category	Distance	Stations	Date
NATIONAL			
Tropo - B	1900 km	VK5UBC, Brian, Gawler -- VK6WG, Wally, Albany	27.02.06
Tropo - I	1004 km	VK5UBC, Brian, Corny Point PF85mc -- VK2EMA, Mark, Tottenham, QF37qs	04.10.05
Tropo - I*	914 km	VK5UBC, Brian, Corny Point PF85mc -- VK2KRR, Lee, The Rock, QF34mr	04.10.05
Tropo - I	894 km	VK2KRR, Lee, The Rock -- VK5ZPG, Peter, Quorn	16.04.06
Tropo - I	890 km	VK5AKK, Phil, Upper Sturt. PF94ix -- VK2TWR/p, Rod, QF44fb	13.01.06
Tropo - ID	387 km	VK2KRR, Lee, The Rock -- VK3AXH, Ian, Ballarat, QF12wi	10.09.05
EME	16197 km	VK4CDI, Phil, Hodgsonvale -- HB9Q, Dan, Switzerland, JN47cg	12.11.05
EME	15122 km	VK4ABW, Gary, Bluewater -- HB9Q, Dan, Switzerland, JN47cg	17.01.06

## 439 MHz FM Simplex & Repeaters

Division/ Category	Distance	Stations	Date
NATIONAL			
FMS - 1	204 km	VK5UBC, Brian, Gawler -- VK5AJW, Jim, Cowell	02.02.06
FMS - 2	153 km	VK5UBC, Brian, Corny Point -- VK5AKK, Phil, Adelaide PF94ix	15.02.06
FMS - 3	139 km	VK2KRR, Leigh, The Rock -- VK3VL, David, Wangaratta	22.04.06
FMS - 4	121 km	VK2KRR, Leigh, The Rock -- VK2XB/m, Ian, Coleambally	22.04.06
FMR - 1	324 km	VK2KRR, Leigh, The Rock -- VK3RMM, Mt Macedon	22.04.06
FMR - 2	308 km	VK5UBC, Brian, Gawler -- VK3RRU, Merbein, Mildura	09.09.05
FMR - 3	244 km	VK4MIK, Mike, Butchers Ck -- VK4RAT, Townsville	01.10.05
FMR - 4	215 km	VK2KRR, Leigh, The Rock -- VK3RTC, Mt Wombat, Euroa	30.04.06

## 1296 MHz Weak Signal

Division/ Category	Distance	Stations	Date
NATIONAL			
Tropo - I	890 km	VK5AKK, Phil, Upper Sturt. PF94ix -- VK2TWR/p, Rod, QF44fb	13.01.06
Tropo - I	861 km	VK5AKK, Phil, Upper Sturt. PF94ix -- VK2EMA, Mark, Tottenham, QF37qs	13.06.06
Tropo - I	770 km	VK2KRR, Lee, The Rock -- VK5NY, Roger, McLaren Flat	20.02.06
Tropo - I*	760 km	VK2KRR, Lee, The Rock -- VK5AKK, Phil, Upper Sturt. PF94ix	19.12.05
VK1 DIVISION			
VK2 DIVISION			
Tropo - I	770 km	VK2KRR, Lee, The Rock -- VK5NY, Roger, McLaren Flat	20.02.06
Tropo - I*	760 km	VK2KRR, Lee, The Rock -- VK5AKK, Phil, Upper Sturt. PF94ix	19.12.05
Tropo - I	627 km	VK2KRR, Lee, The Rock -- VK5DK, Colin, Mt Gambier	04.01.06
Tropo - I	333 km	VK2KRR, Lee, The Rock -- VK3HZ, David, Balwyn, Melb.	14.01.06
VK3 DIVISION			
VK4 DIVISION			
Tropo - I	255 km	VK4ABW, Gary, Bluewater -- VK4BEG, Russell, Lake Eacham	12.11.05
Tropo - I	58 km	VK4CDI, Phil, Hodgsonvale, QG52xh -- VK4OE/p, Doug, Warwick, QG51xs	12.11.05
VK5 DIVISION			
Tropo - I	890 km	VK5AKK, Phil, Upper Sturt. PF94ix -- VK2TWR/p, Rod, QF44fb	13.01.06
Tropo - I	861 km	VK5AKK, Phil, Upper Sturt. PF94ix -- VK2EMA, Mark, Tottenham, QF37qs	13.06.06
Tropo - I*	760 km	VK5AKK, Phil, Upper Sturt. PF94ix -- VK2KRR, Lee, The Rock	19.12.05
VK6 DIVISION			
VK7 DIVISION			
VK8 DIVISION			

## 2.4 GHz Band

Division/ Category	Distance	Stations	Date
NATIONAL			
Tropo - ATV	175 km	VK2TAS, Johnathon, Mt Gibraltar -- VK2TRF, Jack, Watagan Ranges.	18.12.05
Tropo - ATV	150 km	VK2TAS, Johnathon, Mt Gibraltar -- VK2TRF, Jack, Central Mangrove	05.11.05
Tropo - ATV	110 km	VK2TRF, Jack, Beacon Hill -- VK2TAS, Johnathon, Mt Gibraltar	29.09.05

## 10 GHz Band

Division/ Category	Distance	Stations	Date
NATIONAL			
Tropo - ATV	76 km	VK2GG, Dan, Dobroyd Point -- VK2TRF, Jack, Wybung Head.	18.06.06

# Hamads classifieds **FREE**

## FOR SALE NSW

RF output tube 4-125A with socket. \$15 plus postage if required. Ron VK2WB 02 4232 1794.

Kenwood TS-140S HF transceiver S/N 40600089. purchased Jan 1993 for \$1495. Offers around \$700. Peter Cohen, 25 Davis Ave, Davistown NSW 2251

HF BEAMS, 1 WERNER WULF 20 metre, 1 W/W 10/15 metre, complete new in box with instructions, never been assembled. \$250 each or will swap one for a quality 2 metre mobile radio. Ted VK2ARA, QTHR, 02 4272 9521, vk2ara@wia.org.au

ICOM IC706 Mk11G with DSP Unit. Rarely used, in original box with manual, supplied accessories. Mint condition, no marks, non smoker, as new. \$1000. VK2AYC. 02 9583.2056.

## FOR SALE VIC

WERNER WULF 5 element, beam not trapped, \$250. VK3CMS Phone 03 97492748. email otterburn@netspace.net.au

ITEM 1: R-390A COLLINS designed communication receiver. Ex US Navy with repainted black etched front panel. This receiver -(hollow state) just been reconditioned, cleaned, with all valves (tubes) checked, - realigned and control knobs baked enamel and restriped. Best described in excellent condition. Manufactured by Stewart Warner Electronics. Price \$990 plus freight and packing case. ITEM 2: COLLINS 51-X2 VHF aircraft receiver with control box, wired plugs to suit. This sample has the mechanical filter in lieu of the LC filter in the IF. Fully operational. Price \$200. Plus freight ITEM 3 Dynamotor for the 14 V version of the BC-348 ( BC-224 ) DM-24-C. Price \$70 plus freight ITEM 4 Audio Output transformer for the BC348 series Q. , N or J, Not compatible with models E-/M /O/P or S series. Price \$ 45 plus postage Pete Williams VK3IZ QTHR. Email jupete@bigpond.net.au. Phone 03 5156 2053

## WANTED VIC

I am trying to restore/complete my AN/TRC24 Radio system and I am looking for the following parts/units:- Transmitter, T-302/TRC. Power Supply, PP-685/TRC. Receiver, R-417/TRC. A Band Plug-in AM-1180/GRC. Amplifier/converter, AM-2537/TRA-25. Amplifier/Converter, AM-3204/TRC-24. Oscillator/Multiplier, 0-903A/TRC-24. Transformer, TF-167/TRC. and any other bits and pieces for this radio. Thanks for reading this. Regards, John Eggington, VK3EGG johne@telpacific.com.au Mobile: 0409 234 672

## WANTED QLD

Counter Unit for YAESU FT101Z(D). Either early or late model acceptable as either can be fitted. Name your price. Would also consider complete FT101Z(D) with the digital counter working even if rest not, as could use for spares. VK4BMV QTHR or 07 3260 5776

## FOR SALE SA

VK5JST Antenna Analyser kits. [see AR article May 2006] Build yourself an extremely useful item for your shack, and improve your HF antenna efficiency. For more details see www.scarc.org.au; contact SCARC PO Box 333 Morphett Vale SA 5162, or email: kits@scarc.org.au submitted by Graham Thomas VK5HGT 5 Beechwood Grove Seaford SA 5169 ph: 08 8386 3344

ICOM IC718 HF transceiver serial no 0802936 built in UT-106DSP noise reduction unit mike handbook cables little use \$700.00 vk5 BVJ QTHR Phone 08 8723 1001

## WANTED SA

Wanted Dead or Alive (Reward). Circuit diagram and layout of board for AWA test set VHF/UHF type A412 FM test set F/VK5ZJB. Jacques Brunet, 993 Route des Gallinières Commelle Vernay "Polichon" 42120 France

## FOR SALE WA

KENWOOD HF TS 440s s/n 7060326 \$750  
YAESU 2M 290 R s/n1L081295 \$300  
PHILLIPS 70 CM FM 321 s/n121 \$10  
Power Supply 13.8V 20 A home brew fully protected \$200  
EMOTOR Beam Rotator complete with handbook & cables \$250  
LOTS MORE for complete list contact :- VK6AMG D Graham 59 Wilderness Drive Dawesville W A 6210 Phone 08 9582 1984 email montrose@southwest.com.au and a copy of the list will be forwarded.

## MISCELLANEOUS

CLARK Mast wanted, 10-12 metre Clark Mast, in any condition. Destef1@optusnet.com.au or 0408 559 555

## THE WIA QSL COLLECTION REQUIRES QSLs

All types welcome, especially rare DX pictorial cards, special issue. Please contact the Hon Curator, Ken Matchett VK3TL, 4 Sunrise Hill Road, Montrose Vic 3765, tel. (03) 9728 5350

# AHARS

# BUY & SELL

## November 18th

Westbourne Park RSL Hall  
Doors open 9.00

## The Biggest Buy and Sell in

# VK5

**Everyone will be there.**  
**Make sure you are, too**

## About hamads....

- Submit by email (preferred) or on the form on the reverse of your current Amateur Radio address flysheet. Please print carefully and clearly, use upper AND lower case.
- Separate forms for For Sale and Wanted items. Please include name, address STD telephone number and WIA membership number if you do not use the flysheet.
- Deceased estates Hamads will be published in full, even if the ad is not fully radio equipment.
- WIA policy recommends that the serial number of all equipment for sale should be included.
- QTHR means the address is correct in the current WIA Call Book.
- Ordinary Hamads from those who are deemed to be in general electronics retail and wholesale distributive trades should be certified as referring only to private articles not being re-sold for merchandising purposes.
- Commercial advertising on these pages Contact Newsletters Unlimited.
- Copy typed or printed clearly please, and received by the deadlines shown on page 1 of each issue of Amateur Radio.

Email: [newunltd@bigpond.net.au](mailto:newunltd@bigpond.net.au)

Postal: Newsletters Unlimited, PO Box 431, Monbulk Vic 3793. Fax: 03 9756 7031

### TRADE PRACTICES ACT

It is impossible for us to ensure that the advertisements submitted for publication comply with the Trade Practices Act 1974. Therefore, advertisers and advertising agents will appreciate the absolute need for themselves to ensure that the provisions of the Act are strictly complied with.

### VICTORIAN CONSUMER AFFAIRS ACT

All advertisers are advised that advertisements containing only a PO Box number as the address cannot be accepted without the addition of the business address of the box-holder or seller of the goods.

## ADVERTISERS INDEX

AEL.....	27
Amateur Radio Bookshop .....	15
Andrews .....	8
Com-an-tens.....	23
G & C.....	9
Fsaturatech .....	21
Icom .....	OBC
Ozgear .....	16
Rippletech .....	35
TTS.....	28-29
Small ads.....	55
KVK.....	40
TET-Emtron .....	22
Vertax.....	IFC
Westlake.....	45
Winlink.....	34

## JACKSON BROS JACKSON OF THE BK IS BACK

Highest quality products made by UK craftsmen

[www.jacksonbrothers.com.au](http://www.jacksonbrothers.com.au)

Full range now off-the-shelf in Australia  
Variable and trimmer capacitors, reduction drives, dials, ceramic standoffs  
CATALOGUES, PRICE LISTS AVAILABLE

CHARLES I COOKSON PTY LTD

11-13 Port Rd  
Queenstown SA 5014

Tel: (08) 8240 3200 Fax: (08) 8240 3233

FreeFax 1800 673355 within Australia

Email: [sales@jacksonbrothers.com.au](mailto:sales@jacksonbrothers.com.au)

ALL MAJOR CREDIT CARDS ACCEPTED  
SOLE AGENTS AUSTRALIA AND NEW ZEALAND

## AMIDON FERROMAGNETIC CORES

For all RF/electronic applications.

See our website for complete data on all cores.

[www.catchnet.com.au/~rjandusimports](http://www.catchnet.com.au/~rjandusimports)

RJ & US Imports

PO Box 431, Kiama NSW 2533.

A 3.5" PC disk containing all data is available for \$5.00 incl. post.

Agencies

Active Electronics, Tas

TTS Systems, Tyabb (VIC)

Tower Communications, Perth

Ozhelp Services, Brisbane

MiniKits, Adelaide



## Tunable Loop Antenna enhances AM Reception

AM radio reception (530 to 1900KHz) enhanced. Reception where none existed before; works indoors, even in interference-polluted areas  
High value — low cost.

Simple, no connections or batteries  
Ideal for touring, caravan, boat and fringe areas. Use anywhere.

[www.amradioantennas.com](http://www.amradioantennas.com)

[pkloops@bigpond.net.au](mailto:pkloops@bigpond.net.au)

Paul 0412 302 939

PK's Loop Antennas

## RM Products Italy

are now available in Australia after the appointment of

Hamak Electrical Industries Pty Ltd

as distributor for RM products

Visit the Hamak website at

[Hamak.com.au](http://Hamak.com.au) for

**Linear amplifiers,  
Power supplies  
and accessories**

## VKHAM.COM

AUSTRALIAN AMATEUR RADIO

Hundreds of pages and links related to Amateur Radio and radio in general

Home of:

- VK Classifieds
- VK Auctions
- VK's on the Internet

Repeater Maps, Software, Prefix Maps and more ...

# Amateur Radio Bookshop

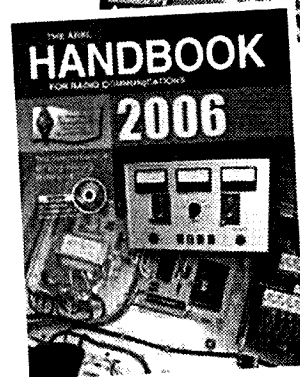
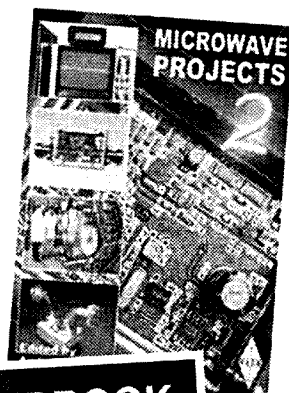

Download our catalogue at

<http://www.wia.org.au>

Amateur Radio Bookshop

PO BOX 3084

EAST BLAXLAND

NSW 2774

Office: WIA National Office

Tel 03 9528-5962

Fax 03 9523-8191

[bookshop@wia.org.au](mailto:bookshop@wia.org.au)

**ARRL - RSGB  
publications  
books  
magazines  
CDROMs - DVDs**

## RADIO & ELECTRONICS SCHOOL

### Become a radio amateur

Check out the courses on offer from Australia's premier training institution for radio amateurs and hobbyists.

### Already licenced?

Upgrade to the Standard licence using our self paced multi-media CD ROM course.

The easiest way to become a licensed radio experimenter.

Discover digital communications, get more power and more bands

### Still want more?

Be guided by one of our experienced facilitators using our proven on-line study methods and get your Advanced licence.

### Visit

[http://www.](http://www.radioelectronicschool.com)

[radioelectronicschool.com](http://www.radioelectronicschool.com)

for more information, or email the course manager at

[info@radioelectronicschool.net](mailto:info@radioelectronicschool.net)

Telephone 07-5573-2795 12-5PM  
AEST

Amateur radio — a bridge to careers in radio communications technology



# Directory

## The Amateur Service:

a radio communications service for the purpose of self training, intercommunication and technical investigation carried out by amateurs, that is, by duly authorised persons interested in radio technique with a personal aim and without any pecuniary interest. 1.56 ITU Radio Regulations.

*The Wireless Institute of Australia represents the interests of all amateurs throughout Australia.*

The WIA offers one year and 5 year membership for all categories except Concession Student. The fees for each category are: Full members \$75 (\$365), Overseas members \$85 (\$403), Concession members (pensioner) \$70 (\$332), Concession members (student) \$70, Full members no magazine \$50 (\$237), Family members \$40 (\$190)

National Office	Contact	News Bulletin Schedule
10/229 Balaclava Road, Caulfield North VIC 3161, PO Box 2175 Caulfield Junction Vic 3161 Australia	Phone 03 9528 5962, Fax 03 9523 8191, 10am to 4pm daily, nationaloffice@wia.org.au http://www.wia.org.au	Subject to change. See www.wia.org.au follow National News prompts. Contact nationalnews@wia.org.au National VK1WIA news is distributed to all states.

Advisory Committees	Contact	News Bulletin Schedule
<b>VK1 Australian Capital Territory</b> VK1WX Alan Hawes VK1ZPL Phil Longworth VK1ET John Woolner VK1GH Gil Hughes	vk1advisory@wia.org.au	Sundays at 11.00 am VK1WIA 7.128, 146.950,438.050 Canberra Region Amateur Radio Club Email newsletter will be sent on request to president@vk1.ampr.org
<b>VK2 New South Wales</b> VK2QV Chris Flak VK2XCD Chris Devery VK2BFN Adrian Clout	Phone 02 9689 2417 vk2wi@ozemail.com.au vk2advisory@wia.org.au	VK2WI - Sunday 1000 and 1930 hours local.1.845; 3.595; 7.146; 10.125; 14.170; 28.320, 52.525; 145.600; 147.000; 438.525; 1273.500 megahertz. Plus regional relays. VK1WIA news included in the morning
<b>VK3 Victoria</b> VK3JJB John Brown VK3PC Jim Linton VK3APO Peter Mill	Phone 03 9885 9261 arv@amateurradio.com.au	VK1WIA, Sunday 11am and 8pm, 3.615 and 7.085 (LSB), 10.130 (USB), VK3RML 146.700, VK3RMM 147.250, VK3RMU 438.075.
<b>VK4 Queensland</b> VK4BY Don Wilchefski VK4ZZ Gavin Reibelt VK4KF Ken Fuller	vk4advisory@wia.org.au	VK1WIA, Sunday 9.0am via HF and major VHF/UHF rpters
<b>VK5 South Australia and Northern Territory</b> VK5OV David Box VK5APR Peter Reichelt VK5ATQ Trevor Quick	Phone 08 8294 2992 boxesdnm@lm.net.au peter.reichelt@bigpond.com vk5advisory@wia.org.au	VK5 South Australia VK5WI: 0900 am local time. 1.843 LSB, 3.550 LSB, 7.095 LSB, 28.470 USB, 53.1 AM, 147.000 FM Adelaide, 146.800 FM Mildura, 146.900 FM South East, 146.925 FM Central North, 439.975 FM Adelaide North. VK8 Northern Territory 0900 local time 3.555 LSB, 7.050 LSB, 10.130 USB, 146.900 FM.
<b>VK6 Western Australia</b> VK6NE Neil Penfold VK6XV Roy Watkins VK6QO Bruce Hedland-Thomas	Phone 08 9351 8873 http://www.vk6.net/ vk6advisory@wia.org.au vk6ne@upnaway.com vk6xv@bigpond.net.au	VK6WIA: 146.700 FM(R) Perth at 0930hrs Sunday relayed on 1.865, 3.564, 7.075, 10.125, 14.116, 14.175, 21.185, 29.120 FM, 50.150 and 438.525 MHz, Country relays 3.582, 147.200 (R) Cataby, 147.350 (R) Busselton, 146.900 (R) Mt William (Bunbury).147.000 (R) Katanning and 147.250 (R) Mt Saddleback. Broadcast repeated on 146.700 at 1900 hrs Sunday relayed on 1.865, 3.564 and 438.525 MHz : country relays on 146.900,147.000, 147.200, 147.250 and 147.350 MHz..Also in "Realaudio" format from the VK6 WIA website
<b>VK7 Tasmania</b> VK7ZAX Phil Corby VK7DG Dale Barnes VK7KK Reg Emmett	Phone 03 6234 3553 vk7advisory@wia.org.au phil.corby@tassie.net.au vk7dg@wia.org.au regemm@ozemail.com.au	VK1WIA Sunday 9am on VK7WI network: 3.570MHz LSB, 146.700 MHz FM (VK7RHT South), 53.825MHz FM (VK7RAD South), 147.000MHz FM (VK7RAA North), 146.750 FM & 53.825MHz (VK7RNW North West), 146.625 MHz FM (VK7RMD North West), UHF CB Channel 15 (Hobart) and 27MHz CB - 27.225MHz LSB (Hobart). Followed at 9:30am with VK7 Regional News Broadcast also on 7.090MHz LSB & 14.130MHz USB

### Notes

1. Only three members of the state advisory committees are listed.
2. All listings are preliminary. They will be updated each month as required.
3. Membership application forms are available from the WIA web site www.wia.org.au or the national office address above.

# NOW AVAILABLE

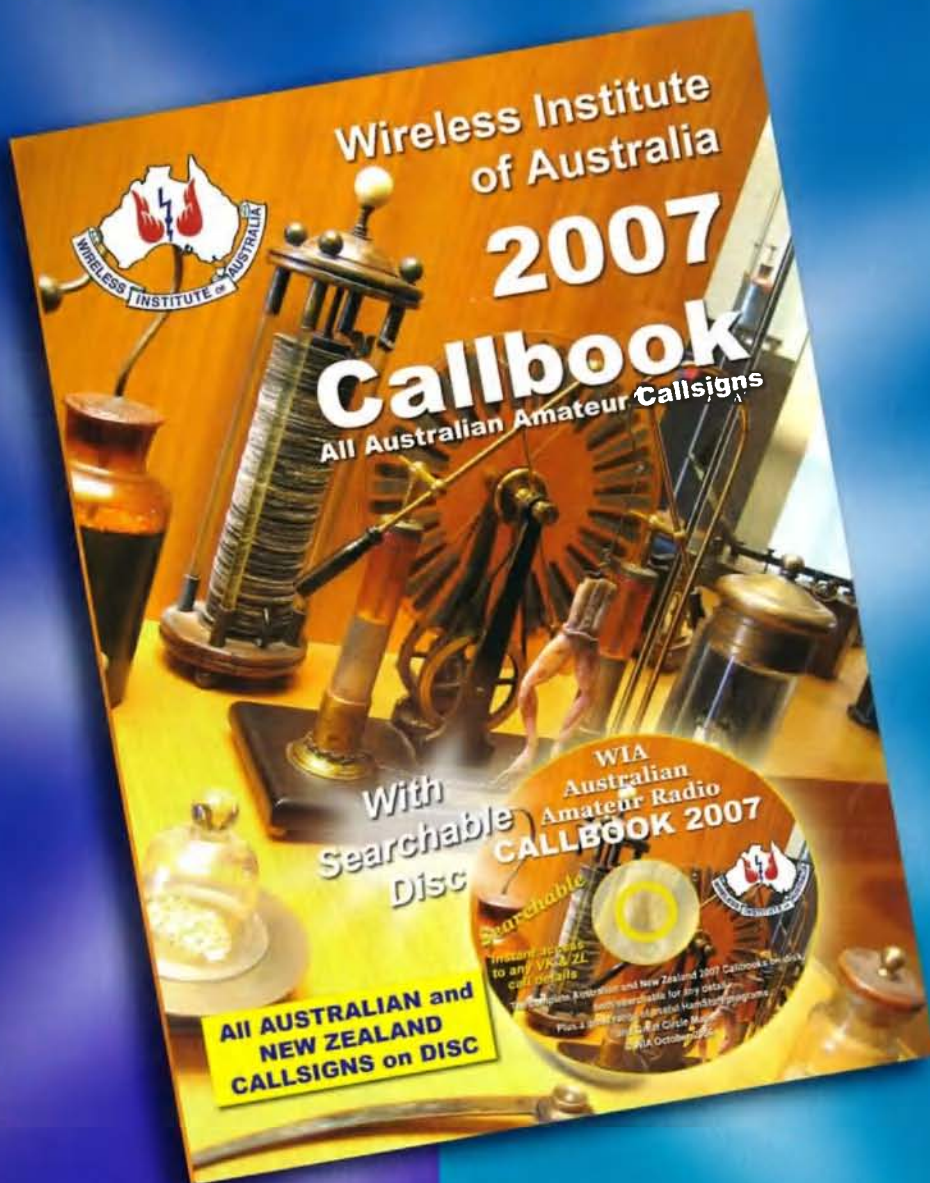

**Contact WIA National Office on  
03 9528 5962 or download an  
order form from the  
website**

**[www.wia.org.au](http://www.wia.org.au)**

\$25 mailed to members  
\$33 mailed to non-members

# ICOM's price break through

## most affordable prices ever



### IC-7000

HF/VHF/UHF All mode Transceiver • 100W HF/50MHz, 50W/2m, 35W/70cm • I.F DSP for improved noise rejection • Digital IF filter for Dial up selectivity • 2.5" TFT colour display for bright easy reading • Remote control DTMF Mic for fingertip control & IRLP access PLUS • digital voice storage • 2 mode band scope • Multi function meter 7 SWR display • Built in RTTY modulator



### IC-756PRO III

HF\*6m • Sharp & soft IF filter shape • New receiver gives +30dBm third-order intercept point • One-touch record/play • Digital voice memory • Extended 1/4 Tuning step & BPF functions for SSB-D mode • 32-bit floating-point DSP and 24-bit AD/DA converter • SSB/CW synchronous tuning • 5-inch color TFT LCD • Built-in antenna tuner • Customisable filter shape • No optional filters to buy

Amateur



### IC-7800

HF\*6m • Four 32-bit floating point DSP units • +40dBm ultra high intercept point • Automatic tracking pre-selector • Two completely independent receiver circuits • 200W output power at full duty • Ultra high frequency stability • 7-inch wide color TFT LCD • Multi function spectrum scope • RTTY / PSK31 operation without PC connection • Professional 6m receiver • Digital Voice Recorder • CF memory card.



### IC-2200H

FM Dual Band Transceiver • VHFHigh (65W) Power Output • DTCS & CTCSS Tone Squelch • DTMF Encode & Decode (with optional UT108) • Digital Voice & Data Communication (with optional UT118) • 207 Alphanumeric Memories



### IC-P7A

VHF/UHF (2m/70cm) Dual-band FM Handheld Transceiver • Ultra compact body, light weight 47x81x28mm, 160g • Mini-power VHF/UHF dual bander with wideband receiver 0.495-999.990MHz • 1800mAh large capacity Li-Ion battery allows 20hours operating time (Tx:Rx:Standby=5:5:90) • 1.5W output power on 2m & 1W output power on 70cm • Simple operation • 1000 memory channels with flexible memory bank system • Oversize LCD for clear display of function information



### IC-T90A

A new 5W Triband handheld • VHF/UHF FM 2M, 6M, & 70CM Wideband receive 495KHz - 1GHz 555 Alphanumeric memories • 13 Scan modes DTCS & CTCSS encode & decode DTMF encoder (10 memories) Wide/narrow transmit capability.

# ICOM

ICOM 142

Call your local ICOM dealer [www.icom.net.au](http://www.icom.net.au) or (03) 9549 7500



The magazine for AUSTRALIAN radio amateurs

Volume 74 No 12

December 2006

# Amateur Radio



\$7.00  
incl GST

**VK30M  
reviews**

*Holiday issue*

**Extra 8  
pages**



**2 articles from  
Drew Diamond VK3XU~  
A jig for punching small holes  
in sheet-metal  
A balanced pi coupler for  
balanced antennas**

**2  
YAESU  
Handhelds**

**BPL Trial at Mt Beauty**





## FT 857D

**World's smallest HF/VHF/UHF Mobile Transceiver**

Digital signal processing for both transmit and receive,  
4 position microphone equalizer to tailor your sound  
Detachable head for easy installation and security

Optional ATAS-120 active tuning antenna system that's fully retractable!  
Optional DTMF microphone

**\$ 1,424**  
RRP



## FT 7800R

**144 MHz / 430 MHz Dual Band Mobile Transceiver**

WiRES™ internet linking for global communication  
Wide band receive with over 1,000 memory channels  
Detachable head for easy installation and security  
Full DTMF Microphone

**\$ 475**  
RRP



## The unbelievable FT 2000

**Elite class HF/50 Mhz Transceiver with a powerful 100w RF output**

Built on FT-DX 9000 technology, setting a new benchmark for DX'ers  
Dual receive; Listen to both sides of the pile up or,  
watch a frequency on the same band for activity  
Optional DMU 2000 with extensive display capabilities  
Digital signal processing for both transmit and receive

**\$ 3,989**  
RRP



## VR 120D with FREE Soft Case!\*

**Hand-held Receiver perfect for the monitoring professional**  
Listen for longer; Typical 20hrs of operation on two AA alkaline batteries!  
Wideband Coverage: 0.1~1299.995 MHz FM/WFM/AM  
Versatile 640 channel memory system

**\$ 287**  
RRP

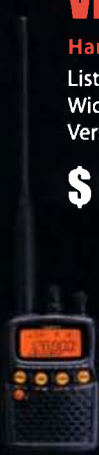

## VX 2R

**with FREE Soft Case!\***

**World's smallest dual band handheld**

Great foundation license radio  
Wide band receive; Listen to radio and TV  
WiRES™ internet linking for global communication  
Versatile scanning for easy frequency management  
Received Coverage; 500kHz 999MHz AM,FM,WFM  
Tough aluminum diecast chassis

**\$ 344**  
RRP



## VR 5000

**with FREE Vertex Watch!\***

**All-Mode Wide-Band Receiver**

0.1~2599.99998 MHz LSB/USB/CW/AM-N/AM/WAM/FM-N/WFM  
Discriminator output; Decode data via your PC  
Spectrum analyzer, world clock, audio wave meter and more  
2000 memory channels  
Optional digital signal processing unit

**\$ 1,298**  
RRP



\*While stocks last.



**YAESU**  
Choice of the World's top DX'ers

**Merry Christmas & a Happy New Year!**

For your nearest authorised dealer please visit [www.vxstd.com.au](http://www.vxstd.com.au) or call 03 9518 2100



When purchased from an authorised dealer

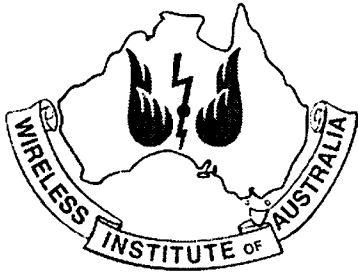

# Amateur Radio

Volume 74, Number 12  
December 2006

The Journal of the Wireless  
Institute of Australia  
ISSN 0002-6859

## Editorial

**Editor:** Peter Freeman VK3KAI  
editor-armag@wia.org.au

**Technical Editor:** Peter Gibson VK3AZL

**Publications Committee Members**

Brenda Edmonds	VK3KT
Ron Fisher	VK3OM
Evan Jarman	VK3ANI
Tom Potter	VK3UBS
Bill Roper	VK3BR
Ernie Waits	VK3FM

## All circulation matters

[nationaloffice@wia.org.au](mailto:nationaloffice@wia.org.au)

## How to submit material

### General and Technical articles

Secretary  
AR Publications Committee  
PO Box 2175,  
Caulfield Junction Vic 3161  
or [armag@wia.org.au](mailto:armag@wia.org.au)

### Columns and letters to Editor

Editor  
AR Magazine  
PO Box 273  
Churchill, Vic 3842  
or [editor-armag@wia.org.au](mailto:editor-armag@wia.org.au)

### Hamads

"Hamads" Newsletters Unlimited  
PO Box 431  
Monbulk VIC 3793  
Fax 03 9756 7031  
[newunltd@bigpond.net.au](mailto:newunltd@bigpond.net.au)

### Advertising

All enquiries to  
Newsletters Unlimited  
PO Box 431  
Monbulk Vic 3793  
Phone: 03 9756 7797  
Fax: 03 9756 7031  
[newunltd@bigpond.net.au](mailto:newunltd@bigpond.net.au)

### Registered Office

10/229 Balaclava Road,  
Caulfield North VIC 3161  
Australia  
Phone: 03 9528 5962  
Fax: 03 9523 8191

## Production Deadlines

General articles, columns and  
advertising booking 10th day of  
previous month.

Hamads and advertising material 15th  
day of previous month

The contents of Amateur Radio are Copyright  
Wireless Institute of Australia © 2006

## GENERAL

Cheaper by the dozen .....	7
<i>Ian Gray VK2ICS</i>	
BPL Trial at Mt Beauty .....	22
<i>Jim Linton VK3PC</i>	
QSL cards from the WIA National QSL Collection .....	25
<i>Ken Matchett VK3TL</i>	
VHF-UHF Spring Field Day 2006 .....	26
<i>Greg Parkhurst VK1AI</i>	
Ulverstone JOTA activities .....	29
<i>Susan Brain VK7LUV</i>	
More JOTA 2006 activity from VK7 .....	31
<i>Roger Nichols VK7ARN</i>	
Saint Anthony's Scout Group Toowoomba VK4SAT: JOTA 2006 .....	34
<i>Matthew Weatherley VK4TMW</i>	
Old Timers in wild QSO Party! .....	48
<i>Ian Godsil VK3JS</i>	

## TECHNICAL

A jig for punching small holes in sheet-metal .....	5
<i>Drew Diamond VK3XU</i>	
Notes on the "drilled Perspex" method of making low-loss transmitting coils .....	9
<i>Drew Diamond VK3XU</i>	
A balanced pi coupler for balanced antennas .....	11
<i>Drew Diamond VK3XU</i>	
Equipment review. The Yaesu VX-6R and FT-60R hand-held 144/430 MHz transceivers .....	16
<i>Ron Fisher VK3OM</i>	
Electrical safety at the workbench .....	20
<i>Kevin B. G. Luxford VK3DAP / ZL2DAP</i>	
Know your second-hand equipment. The Kenwood TS-820S and the Kenwood TS-830S HF transceivers .....	57
<i>Ron Fisher VK3OM</i>	

## COLUMNS

ALARA .....	35	News from... ..	37
AMSAT .....	44	VK2 .....	37
Beyond our shores .....	45	VK5 .....	40
Contests .....	49	VK7 .....	42
Directory .....	64	VK3 .....	43
DX - News & Views .....	58	Over to you .....	52
Editorial comment .....	2	Silent key .....	38
Gridsquare Standings .....	46	Spotlight on SWLing .....	28
Hamads .....	62	VHF/UHF - an expanding world .....	59
IARU News .....	61	WIA comment .....	3
Know your second-hand equipment .....	57	WIA News .....	4

## Our Cover this month

Two Yaesu hand-helds. See Equipment Review on page 16

### Contributions to Amateur Radio

Amateur Radio is a forum for WIA members' amateur radio experiments, experiences opinions and news. Manuscripts with drawings and/or photos are always welcome and will be considered for publication. Articles on disc or email are especially welcome. The WIA cannot be responsible for loss or damage to any material. A pamphlet, 'How to write for Amateur Radio' is available from the National Office on receipt of a stamped self-addressed envelope.

### Back Issues

Back issues are available directly from the WIA National

Office (until stocks are exhausted), at \$4.00 each (including postage within Australia) to members.

### Photostat copies

When back issues are no longer available, photocopies of articles are available to members at \$2.50 each (plus an additional \$2 for each additional issue in which the article appears).

### Disclaimer

The opinions expressed in this publication do not necessarily reflect the official view of the WIA and the WIA cannot be held responsible for incorrect information published.

## Amateur Radio Service

A radiocommunication service for the purpose of self-training, intercommunication and technical investigation carried out by amateurs; that is, by duly authorised persons interested in radio technique solely with a personal aim and without pecuniary interest.

## Wireless Institute of Australia

The world's first and oldest National Radio Society  
Founded 1910

Representing

**The Australian Amateur Radio Service**

Member of the

**International Amateur Radio Union**

Registered Office of the WIA

10/229 Balaclava Road, Caulfield North Vic 3161

Tel: (03) 9528 5962 Fax (03) 9523 8191

email: [nationaloffice@wia.org.au](mailto:nationaloffice@wia.org.au)

<http://www.wia.org.au>

All mail to

**PO Box 2175 Caulfield Junction VIC 3161**

**Business hours: 10am – 4pm weekdays**

### National Office staff

Margaret Williams	Administration Officer
Dianne Ashton	Examination Officer
Brenda Edmonds	Office Volunteer

### Board of Directors

<b>President</b>	Michael Owen	VK3KI
<b>Vice-President</b>	Ewan McLeod	VK4ERM
	Robert Broomhead	VK3KRB
	Glenn Dunstan	VK4DU
	Trevor Quick	VK5ATQ
	Robyn Edwards	VK6XRE
	Phil Wait	VK2DKN
<b>Secretary</b>	Ken Fuller	VK4KF
<b>Treasurer</b>	Bruce Bathols	VK3UV

### Coordinators

<b>AMSAT</b>	Graham Ratcliff	VK5AGR
<b>ARDF</b>	Jack Bramham	VK3WWW
<b>Australian ARISS</b>	Tony Hutchison	VK5ZAI
<b>Awards</b>	Mai Johnson	VK6LC
<b>Clubs</b>	Ted Thrift	VK2ARA
<b>Contests</b>	Phil Smeaton	VK2BAA

### John Moyls Memorial

<b>Field Day</b>	Denis Johnstone	VK3ZUX
<b>Editor 'AR'</b>	Peter Freeman	VK3KAI
<b>EMC/EMR</b>	Gilbert Hughes	VK1GH
	Keith Malcolm	VK1ZKM

### Standards

	Gilbert Hughes	VK1GH
	David Wardlaw	VK3ADW
	John Bishop	VK2ZOI
	John Martin	VK3KWA
	Will McGhie	VK6UU.

### NTAC

<b>Historian</b>	John Martin	VK3KWA
------------------	-------------	--------

### IARU Region 3

<b>Liaison</b>	Michael Owen	VK3KI
<b>Intruder Watch</b>	Glenn Dunstan	VK4DU

### International

<b>Travel Host</b>	John Miller	VK3DJM
--------------------	-------------	--------

### ITU Conference & study group

	Gilbert Hughes	VK1GH
	David Wardlaw	VK3ADW
	Keith Malcolm	VK1ZKM
	Ken Matchett	VK3TL

### QSL Curator

### QSL Bureau & VK9/0

<b>QSL Manager</b>	Neil Penfold	VK6NE
--------------------	--------------	-------

<b>Repeater</b>	Peter Mill	VK3ZPP
-----------------	------------	--------

<b>Webpage</b>	Colin Thompson	VK2TRC
----------------	----------------	--------

<b>WICEN</b>	Ewan McLeod	VK4ERM
--------------	-------------	--------

## Editorial Comment

Peter Freeman VK3KAI

### One year of AR

This issue of *Amateur Radio* represents one year as Editor for me. We still have occasional glitches in our production system and sometimes we fail to meet our goals for having the magazine in members' hands early in each month. However, we continue to attempt to improve our performance and also the quality of your journal.

I must express my thanks to the members of the Publications Committee. They all spend significant amounts of time in reviewing submitted material and in proof reading each issue. They certainly operate as a most supportive team for me. I should also thank the WIA Board for their support throughout the last year and for having the confidence to appoint me to the role of Editor.

### Contributions

We all depend upon those who contribute material to this magazine, be it a regular monthly column or a single article describing some activity or the latest project. Many readers will have noted that some names appear regularly beside technical articles. These contributors provide a steady stream of material for publication and we all applaud their efforts and thank them.

Anyone considering writing for the magazine should feel free to contact me with their ideas. Sometimes it takes a long time before an article is published, due to the various review steps applied. Take heart, the material will eventually move to the front of the queue and appear in AR.

### A bumper issue

This issue will be a 64-page issue, up by eight pages from the normal size. We have also included extra internal colour. The issue may be out a few days later than normal, but this has been unavoidable. I trust that you enjoy reading this issue. We see two equipment reviews – one of handheld radios from Yaesu and an overview of some older equipment from Kenwood. Fans of Drew Diamond should be happy, as we have three of his articles this month. We have reports of a variety of activities, from a Foundation course through to accounts of this year's Jamboree on the Air (JOTA). Everyone should remember that the next issue will

not appear until the start of February and will be a combined January/February issue, as has been the practice for the past few years.

### Interference

Starting on page 22, we have an interesting report from Jim Linton VK3PC on the interference produced by the BPL Trial being conducted in Mount Beauty in north eastern Victoria. In this case, the cause is clear and has been confirmed.

There is almost some degree of paranoia being displayed by some amateurs about the potential threats of BPL. Whilst concern is justified, we should not be making official complaints unless we are certain of the source of the interference. In his investigation of the Mt Beauty Trial, Peter Young VK3MV recorded only normal background urban environment levels of noise outside of the BPL service area. This demonstrates that it is unlikely that anyone located outside a BPL service area will suffer significant interference from this source. His measurements, made with correct technique and reasonably well calibrated equipment, did show significant levels of signals within the service area.

If you need assistance to identify an interference source, try contacting your local club or the WIA. Details about the VK3MV measurements, the WIA BPL Working Group and clubs around Australia, see the WIA website at: <http://www.wia.org.au/>.

### Year's end

The end of the year is almost upon us. I trust you all have a chance to sit back, relax and consider "what next". I am certainly hoping to have some time to play radio and intend to start a significant shack tidy up, followed by moving along on some of the many projects on the "to do" list. Hopefully, we will have some reasonable propagation over the period late December and early January for the Ross Hull Contest and the Summer VHF UHF Field Day.

Make some extra time to enjoy your favourite aspect of this diverse hobby that we share. I wish you all the best for the festive season and hope that you have a safe and prosperous New Year.

## Another year passes

I was wondering what I would write about in this end-of-year issue of *Amateur Radio*.

Another year passes.

Another year to look back on what the WIA has done?

I thought of the many different things done by the WIA. Each depends on one or more people. Do we really acknowledge and appreciate what they do?

It seemed to me that this was the time to recognise some who contribute so much.

But there is a great danger in trying to do that. Almost certainly I will miss someone I should have mentioned by name and so cause offence. But that is why I say "some", as I know I cannot say "all".

But first, in this review of a year, may I do what I have not yet really done; pay a particular tribute to Chris Jones VK2ZDD?

I am very sure that I would not have tackled the task of the "new" WIA if it had not been for Chris Jones. As I said when I told you all of his passing at the end of last August, Chris was the person whose vision and commitment made the WIA what it is today.

It was Chris who talked a group of amateurs in late 2003 into believing that a national WIA was a realistic and better option.

It was Chris who believed fervently that the organisation would grow if it delivered service and avoided conflict.

And it was Chris who persuaded many of us to give a commitment to the WIA.

I returned from overseas in October, after the passing of Chris on 25 August, and because of that the realisation of loss was slow to emerge.

For some 2 years, I had spoken to Chris almost every day, usually first thing every morning, and then during the day, as different issues and problems arose.

From early last year his abiding interest was the amateur qualification system, the qualification and accreditation of the WIA Assessors and then the training and qualification of new amateurs under the new system, particularly the Foundation licence. He was eagerly looking forward to being able say that we had qualified

1,000 new amateurs in a year.

I have never met anyone more persistently anxious to turn an organisation that he believed was necessary into one that attracted the support and membership of as many amateurs as possible, and thus would grow and prosper, doing so without pushing himself forward.

His passing was the loss of us all.

But there are so many, who in so many ways, also contribute.

The WIA QSL service, an important part of the benefits of membership depends on many managers, and ultimately our National Coordinator, Neil Penfold VK6NE, who has gradually been able to provide the support and guidance the managers need.

Then there is Will McGhie VK6UU, who is working to preserve our history, scanning every copy of AR from the first issue, while Ken Matchett VK3TL maintains the wonderful WIA QSL Collection.

There are those who tackle tasks that are very important, but find it hard to get support, such as Glenn Dunstan VK4DU, with the Intruder Watch.

Then there is Mal Johnson VK6LC who has breathed new life into the WIA Awards and does get support!

There are those who contribute to this magazine, firstly, our article authors, then obviously the Editor Peter Freeman VK3KAI, the other members of the Publications Committee, Technical Editor Peter Gibson VK3AZL, Brenda Edmonds VK3KT (who also helps in the office at least one day a week), Ron Fisher VK3OM, Evan Jarman VK3ANI, Tom Potter VK3UBS, Bill Roper VK3BR, Ernie Walls VK3FM and the regular contributors, the DX News from John Bazley VK4OQ, ALARA news from Christine Taylor VK5CTY (and others), AMSAT from Bill Magnussen VK3JT, overseas news from David Pilley VK2AYD, VHF/UHF news from David Smith VK3HZ and SWLing from Robin Harwood VK7RH.

David Wardlaw VK3ADW, John Bishop VK2ZOI and Gilbert Hughes VK1GH represent the WIA at Standards Australia.

The WIA Bookshop is Chris Flak VK2QV.

Ted Thrift VK2ARA is the Clubs Coordinator, providing the basic communication with the clubs.

I think that a successful feature of 2006 was the first year of the Club Grant Scheme, with Rules carefully adopted by the Board to shift the hard decisions to the Grant Committee, Ken Fuller VK4KF, Deane Blackman VK3TX, and Wally Howse VK6KZ.

Until very recently Ian Godsil VK3JS, now Phil Smeaton VK2BAA, coordinate WIA contests and write a regular column for the magazine, with Denis Johnstone VK3ZUX looking after the John Moyle Memorial Field Day, John Martin VK3KWA looking after the Ross Hull VHF/UHF Contest and the Summer and Spring VHF/UHF Field Days and Peter Harding VK4OD taking responsibility for the Remembrance Day Contest.

EMC, ITU/WRC preparation and the like involve Keith Malcolm VK1ZKM as well as David Wardlaw VK3ADW and Gilbert Hughes VK1GH.

John Martin VK3KWA chairs the Technical Advisory Committee, with some 10 amateurs responsible for local liaison, and a technical panel with particular responsibilities including VHF Band Plans and records, the chairman, VHF/UHF Walter Howse VK6KZ, ATV, Peter Cossins VK3BFG, Microwaves Peter Freeman VK3KAI, EME Doug McArthur VK3UM, Packet Barry White VK2AAB, Digital Modes Rex Moncur VK7MO and Satellites Graham Ratcliff VK5AGR while Peter Mill VK3ZPP is the National Repeater Coordinator.

Then there is the team providing BPL assistance, led by Phil Wait VK2DKN.

Yet another team of regular contributors is the Broadcast Team, led by Graham Kemp VK4BB.

Then, the whole WIA Exam Service, our RTO Fred Swainston VK3DAC, Ron Bertrand VK2DQ who contributes so much in relation to the examinations, all the WIA Nominated Assessors and WIA Assessors contribute greatly to the WIA and amateur radio.

# **WIA News**

## **WIA BPL Quick Response Kit**

The WIA has recently assembled a quick response kit for making field strength measurements of BPL interference. The kit is based on the FSM technique developed by Owen Duffy VKIOD and Ed Hare WIRFI. The WIA will make the kit available to enable local radio clubs and others affected by BPL interference to measure the field strength levels with accuracy. Operation of the kit is reasonably straightforward but does require a basic understanding of field strength measurement techniques.

Accurate field strength measurements are important for us to demonstrate to the regulator in a scientific way, the level of interference to radio communications from BPL trials.

Photographs showing the various components of the new WIA BPL quick response kit can be found on the WIA website, [www.wia.org.au](http://www.wia.org.au).

## **Ballarat Club receives Club Grant**

On Sunday 5 November 2006, the Ballarat Amateur Radio Group conducted its popular Hamvention, this year at a new venue, The Great Southern Woolshed, on the Western Highway east of Ballarat.

Over 350 people visited the event, featuring very many items of interest to amateurs on offer, raffles and door prizes.

WIA Treasurer Bruce Bathols VK3UV, Director Robert Broomhead VK3KRB and President Michael Owen VK3KI manned a WIA stand, enrolling 16 new members and selling many of the just released 2007 Callbooks, this year with the special CD featuring the ZL call listing as well as other NZART information and many useful items of amateur software.

During the Hamvention Michael presented the WIA's Club Grant Scheme cheque for \$900 to David Tilson VK3UR, BARG President.

The Ballarat Amateur Radio Group had submitted a proposal to upgrade its club station, allowing remote access. The Grant Scheme Committee said that the project was the most innovative of all submitted to the 2006 Grant Scheme, and that the proposal was very well presented and showed high levels of skill in project design and management.

## **Adelaide Scout Radio Activities Group receive Club Grant**

WIA Director Trevor Quick VK5ATQ presented a cheque for \$770 from the WIA Club Grant Scheme to the Scout Radio Activities Group in Adelaide. The grant was for construction of portable Amateur Position Reporting System (APRS) units that can be used to track groups of people.

Scouts involved in the construction included Gerard Rankin VK5ZQV, Peter Dodd VK5KDO, Sam Adcock VK5KSA and Dean Whitehorn VK5ZDW. Prototype units were on display at the presentation, demonstrating the operation of a position-reporting device.

To avoid the risk of Scouts engaged in remote trail walks and canoeing becoming lost, a GPS is connected to a small radio transmitter communicating to a receiver feeding a computer. The result is an accurate real time record of location of each team or canoe.

The APRS project will also introduce Scouts to amateur radio.

## **ACMA to investigate BPL interference**

The extremely high level of interference experienced by radio amateur Ian Paul VK3FIOP (now VK3LJJ) at Mt Beauty, in northeast Victoria, is now the subject of a written complaint to the Australian Communications and Media Authority. He has exercised his right as the holder of an apparatus licence to lodge a formal written complaint to ACMA about the interference.

Ian claims firm ground for doing so. The interference was confirmed as BPL, its source known and substantial and harmful impact to this licensed amateur service communications well documented.

It has been reported that the BPL system operated by SP AusNet radiates 60dB over S9 signal emissions over the entire 3.5 MHz to 30 MHz spectrum.

Ian VK3FIOP appears to be the first VK radio amateur to actually lodge a formal complaint of interference to ACMA.

Without complaints, BPL operators may be able to claim that the technology is not cited in any formal way to have caused interference to radiocommunications.

It is vitally important that any radio amateur affected by BPL interference

first verify that the interference is in fact caused by a BPL system, and secondly lodge an effective interference complaint with ACMA. Without a valid and effective interference complaint lodged with ACMA, little can be done.

The WIA provides a BPL interference advisory service to all radio amateurs - whether they are WIA members or not.

## **Mt Beauty BPL Trial Report**

Peter Young VK3MV has prepared a report on his observations of the SP Ausnet BPL trial in Mt Beauty. Peter has made the report available for download from the WIA website for all interested parties.

## **Gold Coast Hamfest**

On Saturday 11th November 2006, WIA Secretary Ken Fuller VK4KF, Vice President Ewan McLeod VK4ERM and XYLs Pat and Margaret VK4MEG manned a joint WIA and Gold Coast Amateur Radio Club stand inside the entrance to the Gold Coast Hamfest with Bob Tomkins VK4BT, while XYL Sue VK4ST was busy attending to GCARC matters on the day.

Bob rapidly sold out of Callbooks, the WIA merchandise was very popular and new members joined and were welcomed to the WIA.

## **Northern Tasmanian Amateur Radio Group receives Club Grant**

On Saturday the 11 November 2006, WIA Director Robert Broomhead presented to Northern Tasmanian Amateur Radio Group (NTARG) a cheque for \$1,900 to enable the group to purchase a new diplexer for their VK7RAA repeater. The submission for the grant was amongst the many received by the WIA and was selected by the Grant Committee on the basis of its purpose and benefit to amateur radio.

VK7RAA is located on Mt Barrow, approximately 45 minutes drive from Launceston and the installation of the new diplexer will allow both the transmit and receive antennas to be located on the same tower with increased elevation and better takeoff.

*Continues on page 8*

# A jig for punching small holes in sheet-metal

Drew Diamond VK3XU

When making holes in thin sheet metals using ordinary jobber drills, it is usual for us to get a burred hole. And sometimes, despite our best efforts, the drill wanders out of the centre-punch mark resulting in a hole in the wrong spot.

If you often need to make clean round holes in sheet brass, aluminium and printed circuit board, consider fabricating a simple gadget along the lines offered here.

The jig consists of two parallel bars of ordinary mild steel (MS), held rigid by two high-tensile M8 bolts. A small spacer bar of 3 mm MS bar at the heel end provides a workable separation between.

Tool merchants and auto supply shops (eg Super Cheap Auto) usually sell "pin" or "scroll" punch sets. That shown in Photo 1 consists of a punch for 3, 4, 5, 6 and 8 mm, which should suit many applications in radio/electronics and model work.

## Fabrication

Prepare two identical lengths of 40 mm x 8 mm MS bar of a length to suit the proposed application (300 mm is suggested). It is vital that the top and bottom halves of the jig should register perfectly. In the top half only, carefully mark and centre punch where the two 8 mm bolt holes shall be. Firmly clamp the top and bottom pieces exactly together upon your drill table. Now drill through both bars, first with a pilot of (say) 5 mm, then follow through with 8 mm. De-burr as necessary.

Place the two bars together, then install and tension the two bolts. Arbitrarily mark

out upon the top bar exactly where each punch hole shall be located. Remember that a mounting lug must later be welded upon the underside, so allow room for the lug and a fillet of weld.

Drill an exactly similar diameter hole right through the top and bottom bar for each punch, as required. Suitably mark or stamp (suggest at the heel end) the top and bottom plates to assign congruency upon the final assembly.

Fabricate a spacer from 25 x 3 mm MS bar, 40 mm long, as shown on Fig 1. Using the top bar as a template, mark, and then drill two exactly corresponding bolt holes.

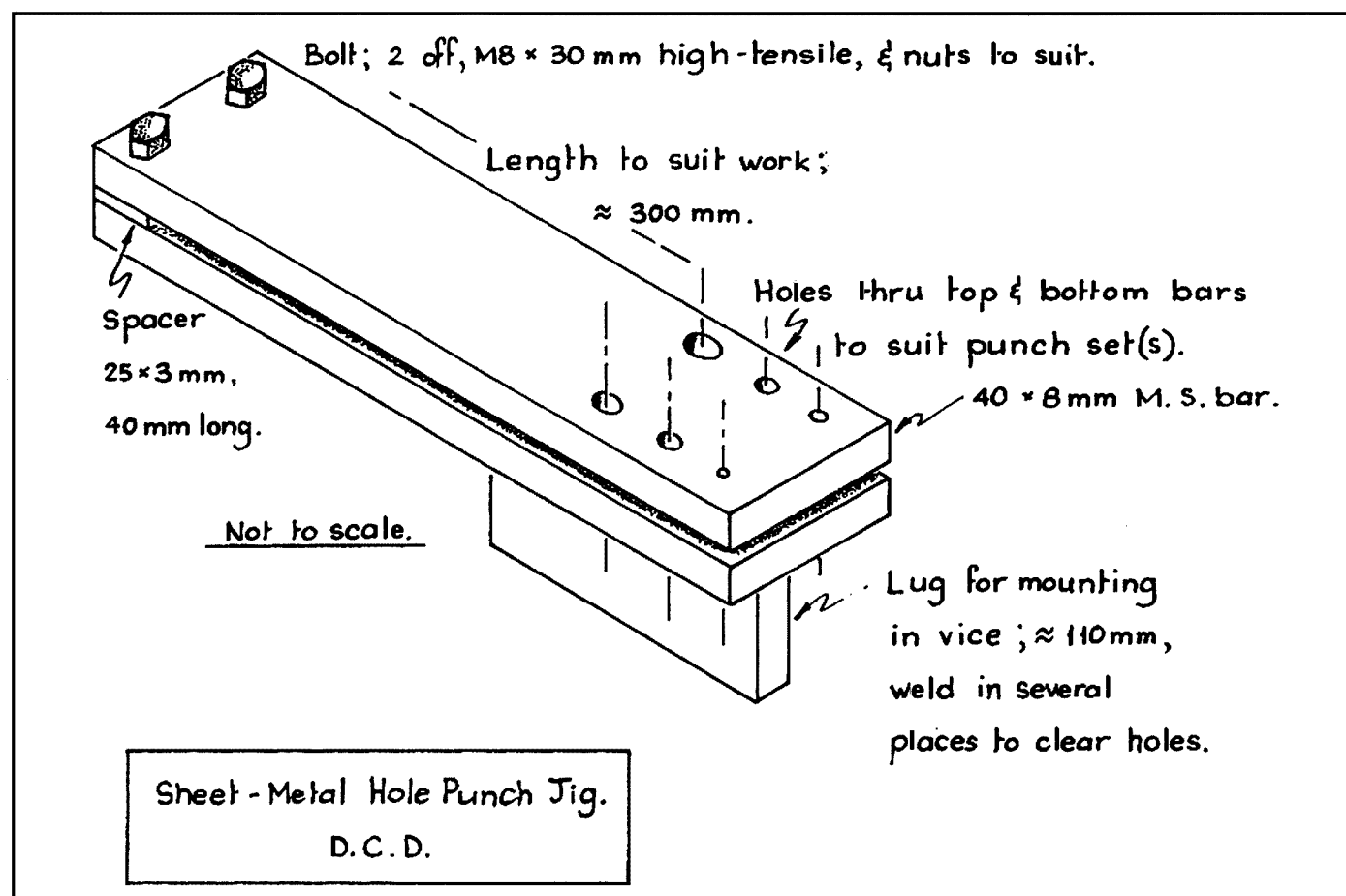

Figure 1



Photo 1

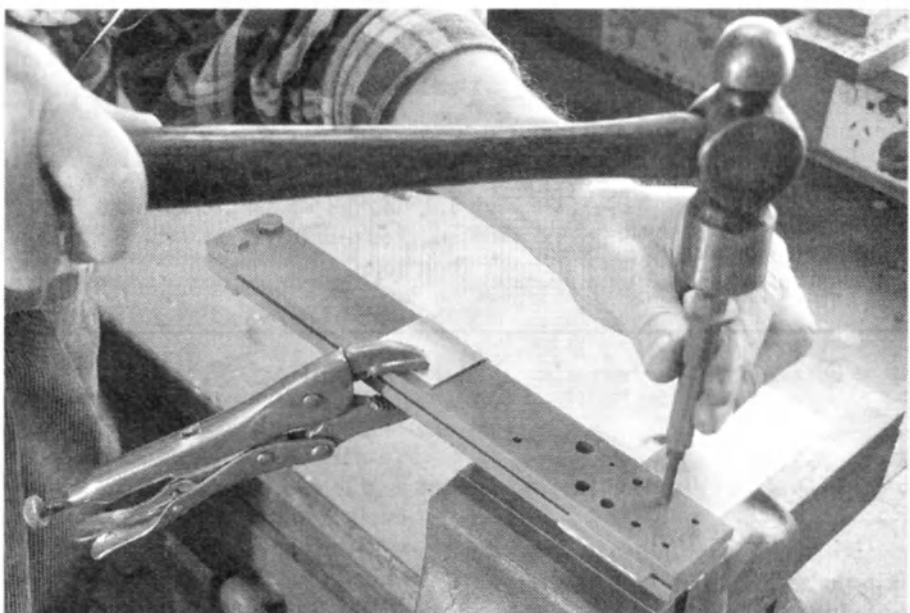

Photo 2

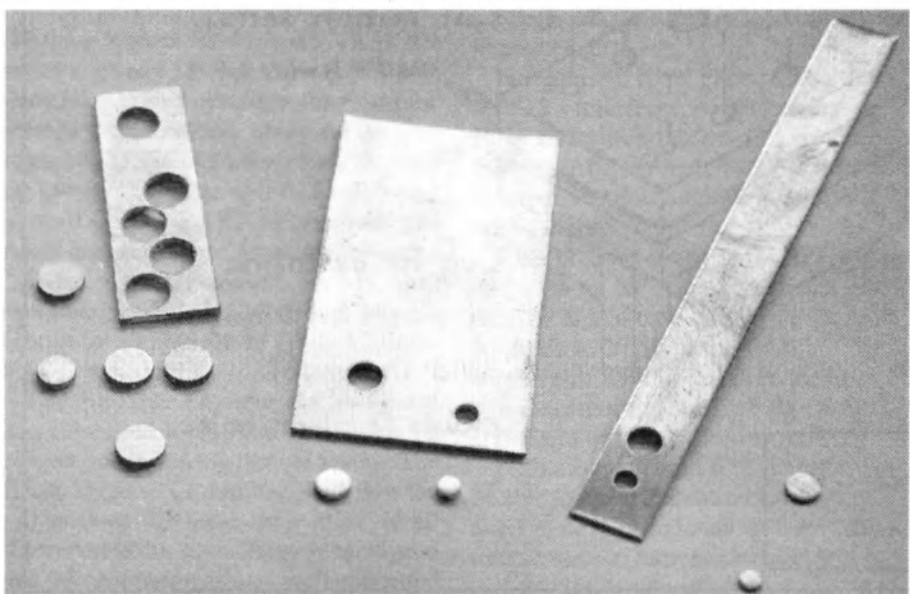

Photo 3

Assemble the jig initially by installing the two bolts and nuts to finger tightness. Insert all the punches in their respective holes and, with these in place (to maintain congruency), finally tension the bolts. The punches should remove easily.

The punch works better if the bottom hole is just a "bee's whisker" larger than the nominal hole size. For example, for the 3 mm enlarge the bottom hole by following through with the next larger drill size, a #31 drill. For 4 mm use a drill size #21; for 5 mm use a #8; for 6 mm use a letter B; and for 8 mm use a letter O. For this operation, the bars should be spaced with a scrap of 25 mm x 3 mm bar inserted near the toe of the jig, drilling the bottom bar only, of course. Take care (use the drill-press depth-stop) that the drill does not enter the top bar. All holes should be de-burred by draw-filing.

A 110 mm length of 40 mm x 8 mm bar must be welded to the bottom bar to act as a vice fixing lug. Avoid welding close to the holes - simply dodge where necessary.

## Operation

The jig is mounted in your vice, as illustrated in Photo 2. The exact hole position is sighted by looking straight down the top hole onto the job. A pair of vice-grip pliers will then be found very handy in bringing the halves of the jig together such that the work is firmly clamped in the exact position required. Any distortion (of the sheet-metal) is thus also prevented.

One or two hammer blows are applied with just sufficient force to punch out a slug, at which point the punch should be withdrawn (if the punch is driven right through, considerably more effort is needed to pull it back up through the work). The sheet metal is then removed, and the slug(s) may then be driven out of the bottom hole with little effort.

Examples of holes (and their slugs) thus made in printed circuit board, aluminium and brass are shown in Photo 3. The slugs obtained from printed circuit board may be saved, and used as "paddyboard" islands.

## Reference

*Electrical Things Boys Like to Make;*  
Sherman Cook, pp 162-3, Lindsay  
Publications.

Photographs: Andrew Diamond.

ar



# Cheaper by the dozen

Ian Gray VK2IGS  
Secretary, Summerland ARC

**Some years ago, there was a movie by the title of "Cheaper by the Dozen". How this relates to what we did at Summerland Amateur Radio Club will soon become apparent.**

For a few months we had been discussing how we could organise a Foundation Licence course considering that we had no Foundation Licence assessors in our club. Fortunately, we have a very good relationship with our sister club, the Gold Coast Amateur Radio Society. This relationship has been built up over the years and many strong personal friendships have developed through this link. The Gold Coast club had a number of recently trained assessors and we felt that they might be able to come to our assistance. One of the members of the GCARS is Ron Bertrand VK2DQ, who is co-author of the Foundation Licence textbook, "Your Entry Into Amateur Radio" [1]. Ron had assisted our club on other occasions, so it was decided to approach him to see if he could assist. That assistance was very readily forthcoming.

At our end, we started word of mouth advertising and soon had around fourteen names on our prospect list. Ron advised that this was more than enough to conduct a course and carry out the assessments. As it was, we wound up with twelve candidates attempting the assessment. This explains my tongue in cheek heading of 'Cheaper by the dozen'. This wasn't meant to disparage the candidates, but we thought, at the time, that it would be easier to instruct and assess that number. In the lead up to, and during the course, all candidates were kept up to date via email.

We decided to run the course over two weekends, as we were unsure as to how long we needed to cover the information in the textbook. Ian Gray VK2IGS wrote the instruction schedule and, along with Leith Martin VK2EA, John Alcorn VK2JWA and Graeme Battistuzzi VK2JUB, we commenced the course on Saturday 25th March. By the end of Sunday 26th March we had covered the whole of the text.

Prior to commencing the course, all candidates had been requested to obtain the textbook through our club treasurer, John

Alcorn VK2JWA. All complied. Ian VK2IGS sent out a seventy-question reading guide, based on the text, which all candidates were asked to complete and bring on the Saturday.

On Saturday 1st April, the candidates were given the answers to the seventy questions reading guide and any problems encountered were dealt with. Then they were given a 'trial' 25 question exam paper. This was marked on the spot and any problems discussed.

The theory exam was written without ever having seen a Foundation Licence examination paper but proved to be fairly close to the real thing. At least it gave candidates some experience at

attempting a multiple choice radio exam. Around 2.00 pm on that Saturday, Kath and Roy Cottrill VK4IG, assessors from the Gold Coast club, arrived and some candidates elected to commence their assessments.

The main assessment day was Sunday 2nd April. A team of six assessors, headed up by Ron Bertrand, arrived at around 10 am and commenced assessments. By 2.00 pm the remainder of the candidates had been assessed and all paperwork had been filled in. Ron then gave an interesting short talk on the Radio and Electronics School [2], which he manages.

Throughout both weekends, the 'troops'



Photo 1 – Graeme instructing on QSOs.



Photo 2 – Ian lecturing from the left side.

had been sustained by sausage sizzles, tea, coffee and slice (this delicious slice being made by one of the candidates, Tracey Battistuzzi). Four of our prospective assessors were able to observe proceedings and they were enthused to attend a training day in May. Many friendships with the OMs and XYLS from the GCARS were renewed and thus the two weekends came to a successful culmination. It must also be stressed that the continuing assistance rendered by Ron Bertrand VK2DQ, prior to and during the course, was invaluable. Thank you Ron!

The results, I hear you ask? Oh, just twelve successful candidates out of



Photo 3 – Ian lecturing from the right side.



Photo 4 – Pat and Roy.



Photo 5 – SARC and GCARS after a successful day.

twelve! Summerland ARC also gained some new members.

What did we learn? Well, we learned that it takes a long time to assess twelve candidates and that it would be better if the numbers were around half of that. We also learned that weekends were not always suitable for candidates because of work and sport commitments. We will be looking at evening courses and a single weekend course.

We also learned that the candidates appreciated the continuing updates via email as the course approached and during the course. We also know that from here on, we will have to come to grips with publicising the course, as this one was simply advertised by word of mouth.

Summerland ARC feels that we have made a contribution to the ranks of amateur radio through this activity. Especially, when one considers the make-up of the course candidates: four female

candidates, two of whom were twelve years of age, the other two female candidates being mothers of the youngsters, together with eight male candidates in their forties.

Summerland ARC would be only too happy to pass on any tips to other clubs who are considering this program.

Just drop the Secretary an email to: [igray@ceinterent.com.au](mailto:igray@ceinterent.com.au).

The photographs for this article were taken by John Alcorn VK2JWA.

1. Your Entry Into Amateur Radio, 1st Edition, Ron Bertrand VK2DQ and Phil Wait VK2DKN, Wireless Institute of Australia, 2005
2. [www.radioelectronicschool.net](http://www.radioelectronicschool.net).

ar

*Continues from page 3*

### WIA Comment

Once you start it becomes a list without end. There are just so many people who contribute in so many ways to making the WIA what it is that even trying to list them is an impossible task.

And that is the point.

There are so many people we should acknowledge and thank.

Recently I was shown the magazine of an organisation structured a bit like the WIA, and there was a piece about those seeking election to the committee. It made the point that there was no point volunteering for the committee unless you had the skills that would contribute to the organisation and the time to contribute those skills.

I am sure that the directors, who on your behalf thank all those who make the WIA what it is, are also very aware of the need for skill and the need for time in what they do to make the WIA worth supporting.

As I said at the outset, it was the late Chris Jones who believed fervently that the WIA would grow and prosper if it delivered service and avoided conflict.

I agree, and I hope I have mentioned, directly or indirectly some of the many who do deliver service on behalf of the WIA and contribute to amateur radio, which is, in the end, what the WIA is all about.

ar

*Continues from 4*

### Delay – 2007 Callbooks

Some clubs and individuals have suffered a slight delay in the delivery of their 2007 Callbooks.

The 2007 Callbook includes a completely new CD, featuring the Australian call list and information, but also the NZART Callbook and New Zealand information, as well as a selection of amateur software.

Unfortunately, when the Callbook was delivered it was discovered that the CDs were defective, and so had to be replaced.

All Callbooks on order have been dispatched, and all CDs sent out before the defect was discovered will have been replaced.

ar

# Notes on the "drilled Perspex" method of making low-loss transmitting coils

Drew Diamond VK3XU

In this, and other amateur journals, we have read about the various techniques that a home-constructor might use to produce low-loss "air-wound" style coils, using wooden jigs and other appliances for the job (References 1 - 5). But, for the builder who may only fabricate the occasional coil, the pre-drilled acrylic sheet (Perspex) method briefly described in Reference 6 has much to commend it.

As with all handiwork operations, the secret to success is measuring, marking and machining accuracy. In the following example, we construct a 12  $\mu\text{H}$  coil (one of two) for a new balanced coupler project. Spacing between turns shall be 5 mm to allow for alligator-clip adjustment.

The oft-quoted (and quite accurate [approximation]) formula for calculating the inductance of a single-layer solenoid coil of reasonable dimensions, wire gauge and turns spacing is

$$L = \frac{r^2 \times n^2}{9r + 10l}$$

where L is inductance ( $\mu\text{H}$ ), r = coil radius, (inches) l = winding length (inches) and n = number of turns.

*{Editor's note: The source of this formula [Reference 7] is not metric. When using the standard metric unit millimetre (mm) instead of inches remember to divide the result by 25.4 to get the inductance in micro Henries}*

Usually, however, we have a pretty good idea as to the inductance required and the physical dimensions of the coil, but we need to know the number of turns necessary, so the formula may be re-arranged to give the number of turns n, thus:

$$n = \frac{\sqrt{L(9r + 10l)}}{r}$$

In the example here, radius (coil axis to wire centre) is 1.25 inches (32mm), winding length l is 3.75 inches (95mm) (please excuse my mixing mm and inches - nevertheless the formula is neater in their original "Wheeler" form). *{Editor's note: When using the standard metric unit millimetre (mm) with micro Henries the result will have to be multiplied by the square root of 25.4 to be meaningful}*. For 12  $\mu\text{H}$ , we need 19 turns. 1.9 mm enamelled copper wire is chosen for two reasons; effective RF resistance

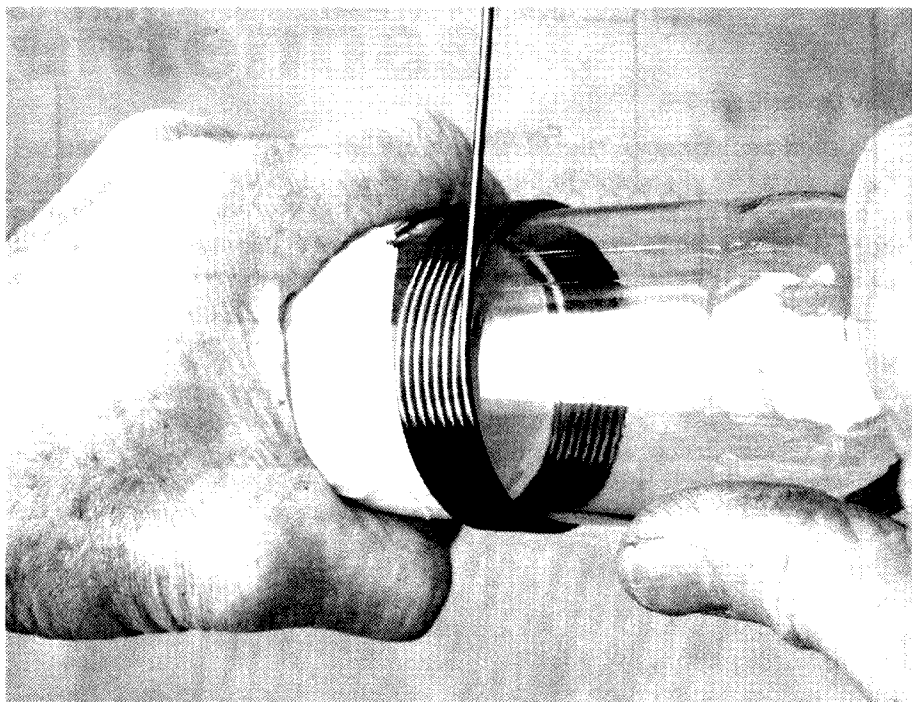

Photo 1 - Winding the helix.

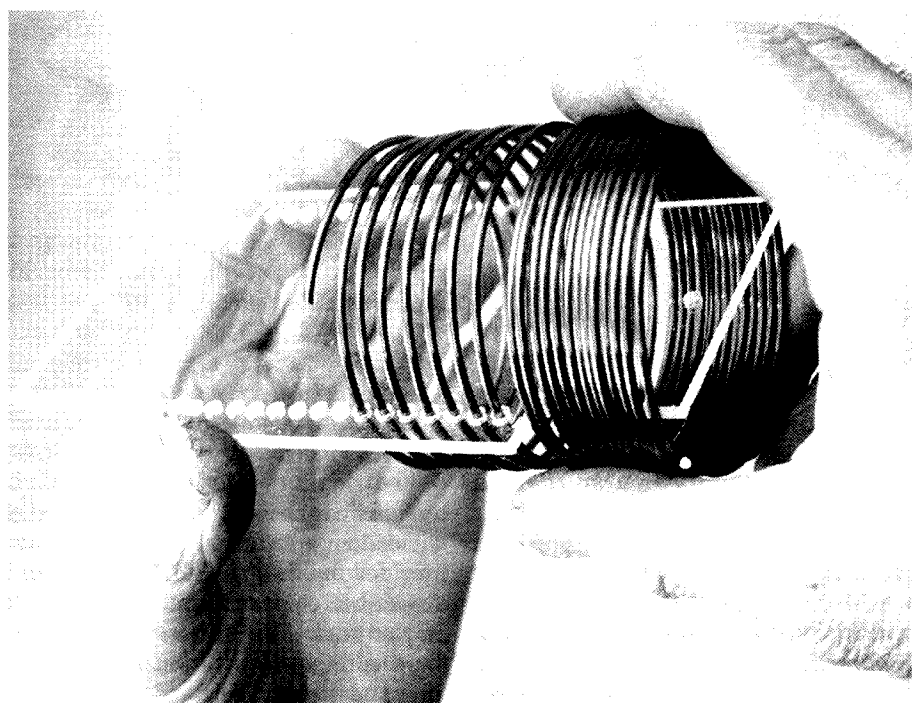

Photo 2 - Winding the helix on to the former.

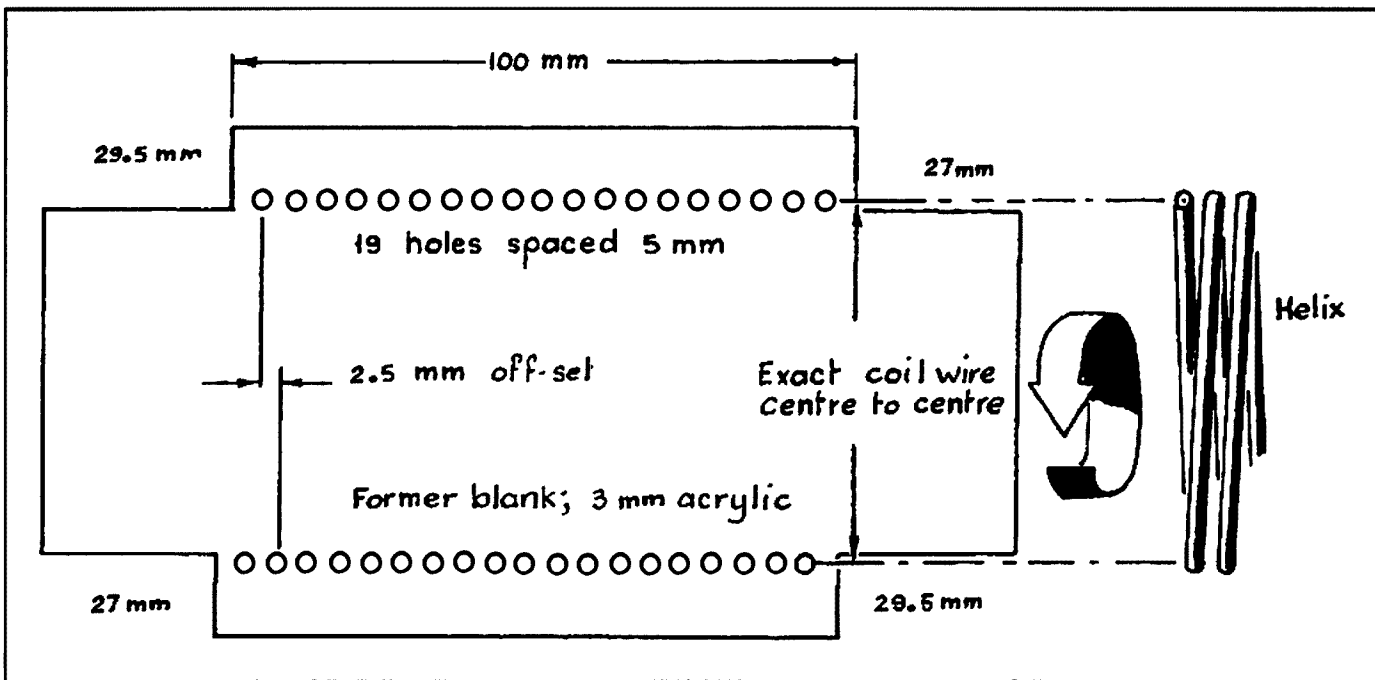

Fig 1 – Details of the former blank.

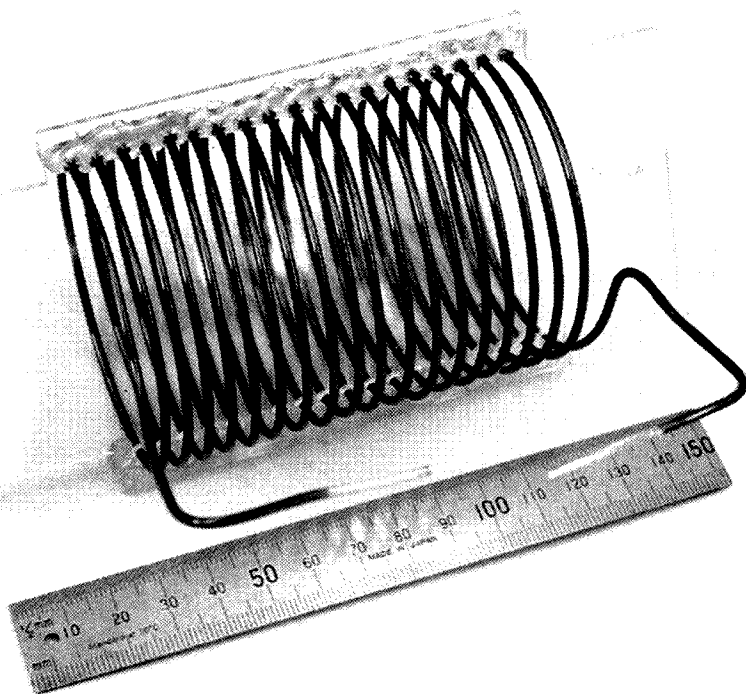

Photo 3 – The completed coil.

drawing serve as a useful lead-in guide when winding the coil, and they provide suitable lugs for mounting the finished coil.

To prevent shattering the Perspex, use a hack-saw blade with 32 teeth-per-inch to carefully cut to size. Square up and smooth rough edges with a second-cut file that has a "safety edge".

Here is an important tip: do not drill the coil holes until the helix (coil) has been initially wound, as described next.

For use as a mandrel, find an exactly cylindrical object, such as a bottle, which has a diameter about 14% smaller than the required coil diameter. In this instance, the final coil diameter is 63.5 mm (2.5"), so the mandrel should be about 55.5 mm in diameter. I had no trouble finding a suitable 275 ml vodka bottle of exactly that diameter upon the road-side, kindly supplied by one of our local hoons.

Calculate the length of wire required;  $\pi \times d \times n = 3.14 \times 55.5 \times 19 = 3,311$  mm. We must wind on at least two extra turns, because about two turns will unwind when the helix is released from the mandrel. And we shall need "tails" for lead connections – so let's make it an even four metres.

Anchor one end of the wire then, with bull-nose pliers, give the wire a firm pull to remove any small wrinkles. Use masking or packing tape to stick one end of the wire on to the mandrel. Whilst maintaining a firm tension upon

White).

A visit to a local plastic sign maker yielded an arm-full of Perspex off-cuts, free for the asking. Fortunately, 3 mm thick sheet appears to be a popular size in that trade. The former blank should be accurately marked out using a ball-point pen, a steel rule and an engineers' square. The extensions shown in the

will be sufficiently low and it is a commonly available size. Such wire may be obtained from "magnet wire" suppliers (eg O H O'Brien) or from "transformer manufacturers". 2 mm plain soft copper wire (quite satisfactory for HF coils - see Reference 8) may be purchased from "non ferrous metal merchants" (eg Geo.

the wire, walk towards the anchor and carefully close-wind the helix such that each new turn touches the last, as pictured in Photo 1.

When the helix is removed, measure the exact wire centre to wire centre diameter of the coil, and mark your former blank accordingly, taking particular account of the winding "sense" of your coil (that is, clockwise or anti-clockwise). Note that the holes must be off-set by exactly half the winding pitch (2.5 mm).

Drill and countersink just a few holes initially, then test that your helix may be easily "screwed" into the holes - there must be little opposition. Adjust the remaining holes accordingly. The wire holes need only be a tad larger than the wire diameter. A  $3/32$ " (2.38mm) drill is about right for 1.9 mm wire. Lightly countersink both sides of each hole to reduce the winding friction.

Carefully screw the helix into the former, as illustrated in Photo 2. You should finish with a spare turn or two at each end. Align any wayward turns, then apply a bead of hot-melt or epoxy glue (both satisfactory for RF work) along the coil holes on both sides, as shown in Photo 3.

## References and Further Reading

1. "Low-Loss, Low-Cost Transmitting Coils"; *Muldoon*, W1FRQ, QST, Dec 1934.
2. "Constructing Air-Wound Coils"; Johnson, W7KBE, *Ham Radio*, Aug 1984.
3. "Making Air-Wound Coils for HF"; *Amateur Radio*, Feb 1994.
4. "Making "Air-Wound" Transmitting Coils"; *Amateur Radio* June 2000.
5. "Another Method of Making "Air-Wound" Transmitting Coils"; *Amateur Radio*, March 2005.
6. *Radio Communication Handbook*; RSGB, 4th Ed, p 13.36.
7. *The Radio Amateur's Handbook*; ARRL (any recent edition).
8. "Notes on HF Transmitting Coils"; *Amateur Radio*, Sept 2005.

Photos: Andrew Diamond  
([www.andrewdiamond.net](http://www.andrewdiamond.net))

ar

# A balanced pi coupler for balanced antennas

Drew Diamond VK3XU

**For perhaps the last 30 years, amateur transmitting amplifiers have been designed to work into a resistive load of nominally 50  $\Omega$ . As far as is known by this writer, no efficient back-yard antenna is capable of providing a perfect 50  $\Omega$  load over the entire width of our eight HF bands. It is often said, "You can't change the laws of physics". True - but you can get around them.**

Where the amount of wire in the radiating part of the antenna, be it loop or dipole, is of sufficient length, interposing an efficient coupling circuit between the transmitter and the station end of the feed-line will usually allow a good match (low SWR) to occur between the transmitter's output amplifier and the line, regardless of the SWR on the line between coupler and antenna.

Popularly called an "ATU" (Antenna Tuning Unit) - or more correctly, Antenna Coupling Unit (ACU), these devices, their application, circuitry, relative efficiency and so on, make a perennially hot topic. An antenna coupler is the sort of device that a reasonably handy person may construct cheaply using ordinary tools, yet achieve results as good as any "bought" one.

A dipole, at least a quarter wavelength long on the lowest required band, or a loop of more than (roughly) a half wavelength and fed with any reasonable length of low-loss "ladder-line", or a home-made open-wire line, or a "dumb-bell/dog-bone", all make a very workable multi-band antenna. Unlike trap dipoles and the like, which effectively disconnect (and therefore waste) wire on higher bands, all of the available antenna wire is used on every band. That the SWR on the line beyond the coupler may be (probably is) quite high, is of no concern to us, because the conductors are low resistance copper, and the dielectric (the material between them) is mainly air (Reference 1).

The usual commercial approach to

feeding a balanced\* antenna is to use a "tee" or "SPC" "transmatch" (Reference 2), that is a very adept circuit, capable of matching a wide range of impedances to our 50  $\Omega$ . However, the "tee" alone is not a naturally balanced circuit, and so a 1:4 "balun" is shoehorned into the box to permit feeding a balanced line. Admittedly, the SWR on the radio/coupler coax connection can usually be adjusted for a low SWR, but that poor balun, which can only operate properly if it "sees" a resistive impedance of 200  $\Omega$ , often has to look into some other complex impedance. The result is poor efficiency, balun core heating, arcing between balun coils and drastically unequal currents in each leg of the line.

Some experimenters have had success in placing a "current" or "choke" balun on the input side of the coupler (Reference 3). My experiments indicate that this approach may only work over our mid-HF bands. Balance is hard to maintain at the high HF end. Furthermore, on 3.5 MHz the choke "balun" may not present sufficient longitudinal impedance, resulting in significant out-of-balance currents flowing over the coax braid back towards the transmitter, thus indicating poor balance and efficiency.

The popular "Z-Match" circuit, promulgated and improved by Lloyd Butler and others (Reference 4), is arguably the simplest, most effective, almost-balanced coupler for the mid-HF range, but it may (in my experience) be a little quirky at the high and low HF end.

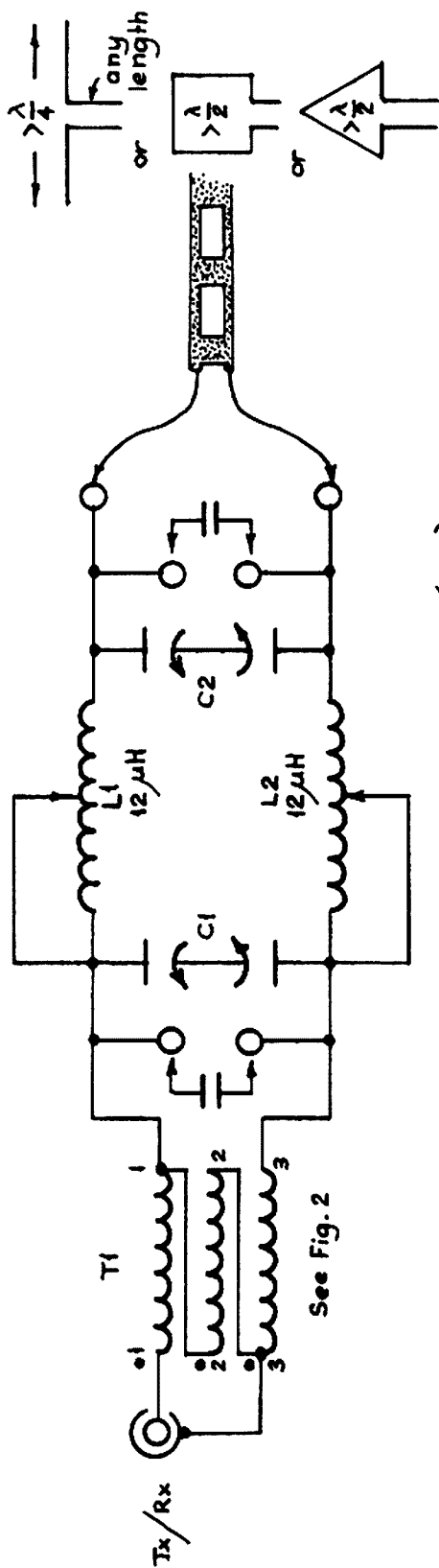

See Fig. 2

L1, L2 : 19 turns 1.9 mm e.c.w, 63.5 mm (2.5") i.d.

C1, C2 : Dual 'H' gang B/C cap, ≈ 440 pF/gang.

T1 : 40 trifilar turns #16 B(S (1.5 mm) e.c.w, close-wound upon 400 mm loop-stick (ferrite rod); Jaycar LF-1010 or similar.



: Set of 3 silver mica caps; 220pF, 500pF, 1000pF, >500V, each fitted to a 2-pin banana connector, or similar.

Balanced Pi Coupler for  
Balanced Antennas  
—VXAXU—

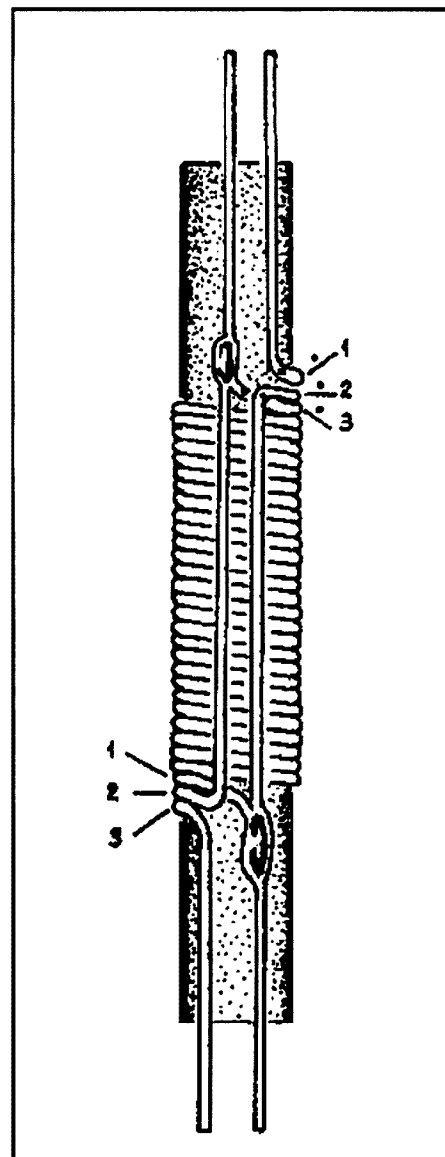

Fig 2 - The balun

Fig 1 - Schematic of the balanced pi coupler for balanced antennas.

Furthermore, under some conditions, the ordinary broadcast gang capacitors normally employed (by most builders) may flashover, even when operated at modest power levels.

Of all the known popular coupler circuits tested, the traditional balanced "link" type remains (in my opinion) the most versatile and efficient (References 5 - 8). But now it seems that many operators demand an ability to change bands quickly, and will not "waste" those few moments needed to optimise the four or five link-coupler variables for each band change.

Recent work by Measures (Reference 9, reported in 10 and 11) and others (Reference 12), upon the "re-discovery" of the balanced pi-network (attributed to Arthur Collins [Reference 13]), has awakened interest in a sadly neglected

circuit configuration. Again, however, Measures has employed, on the input side of the coupler, a "choke" balun, which is a less than satisfactory device. It is not a true balun, and has some limitations, the main one being insufficient series impedance at the low HF end. When a true three-winding transformer type balun is used, the full potential of the balanced pi circuit may be realised, and the coupler performs correctly across the entire HF range.

Tests using the prototype model at the 120 W power level with various antenna configurations indicate that, as far as may reasonably be determined, a good, efficient match between transmitter and line may be had on any HF band between 3.5 and 29 MHz. Moreover, virtually identical currents measured in each leg of the line (feeding a balanced antenna) show that the coupler is operating in a balanced manner.

**Circuit**

See Figure 1. The unbalanced 50 Ω input is converted to 50 Ω balanced by use of the aforesaid 1:1, three-winding balun. By adding a second capacitor on the input (left-hand-side) of the pi, the matching range is considerably increased.

C1 and C2 are ordinary two-gang broadcast capacitors of 440 pF per gang. They each effectively operate in series, so their maximum capacity is 220 pF, which may be insufficient in some circumstances on 3.5 and 7 MHz. If more capacitance is required, additional fixed mica capacitor(s) of 220, 500 or 1000 pF may be connected in parallel with C1 and/or C2 as required. The 500 and 1000 pF capacitors are fitted to dual banana plugs so that they may be "piggy-backed" to obtain an extra 720, 1220, 1500 or 1720 pF.

Ideally, L1 and L2 should be ganged roller inductors. However, a good workable plan is to employ a pair of air-wound inductors, each 12 μH, tapped every turn. In accord with standard practice, the unused portion of the coil is short-circuited to prevent damaging voltages from being produced in the unused portion by step-up transformer effects (Reference 14).

Under certain weather conditions, an antenna may acquire a considerable static electric charge from rain or wind. Fortunately, balun winding number two provides a DC return path to ground, such that both sides of a dipole are

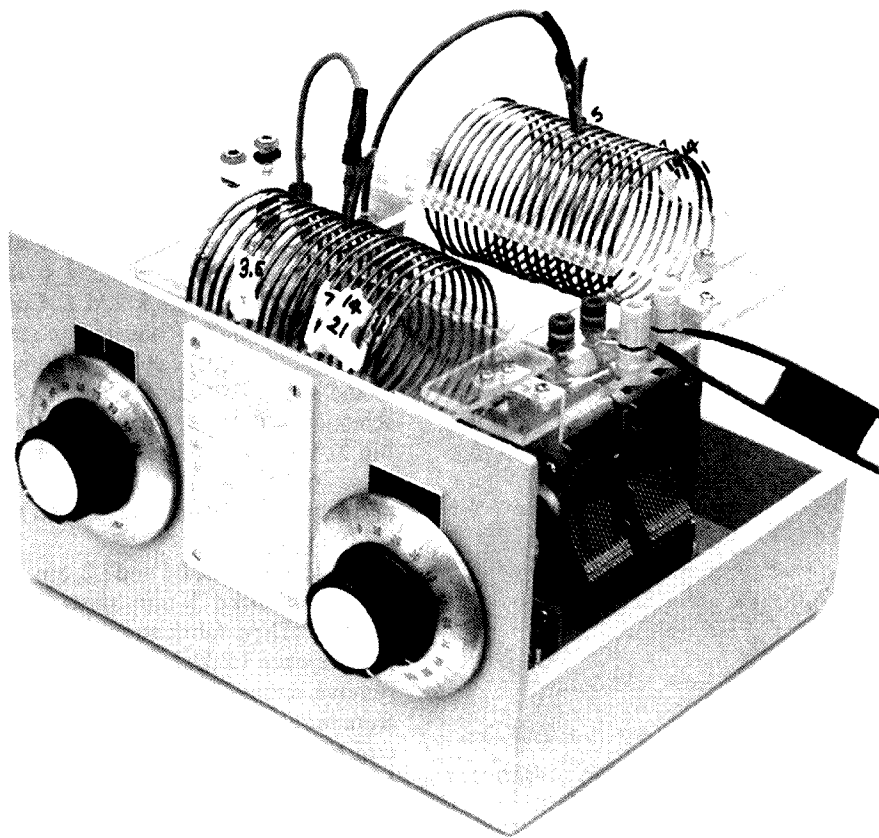

Photo 1 – Balanced pi coupler.

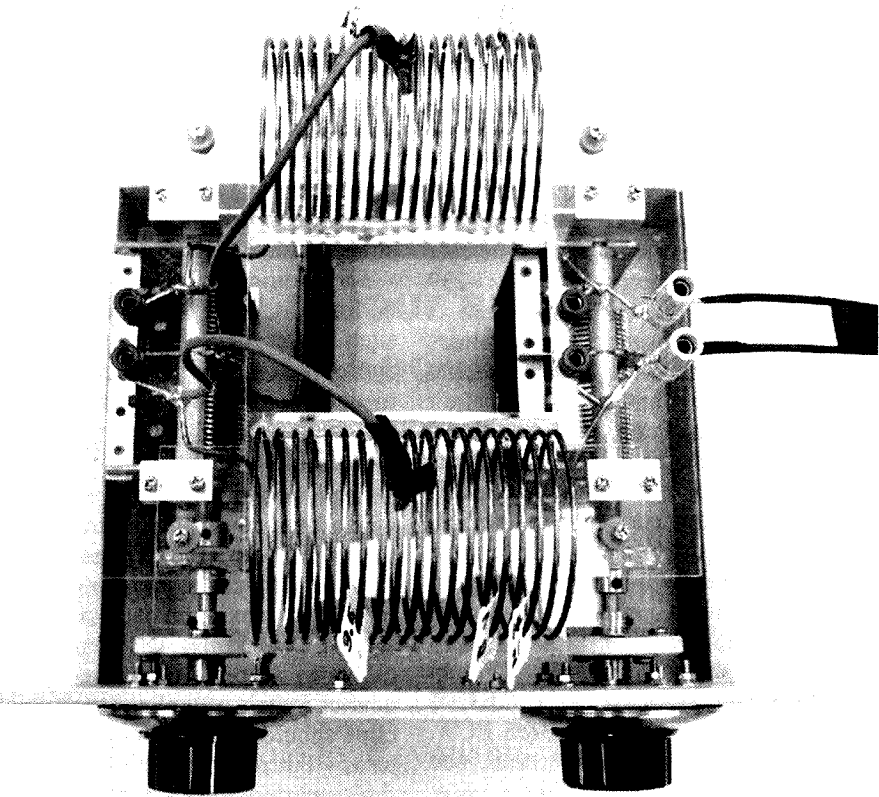

Photo 2 – Plan view of the pi coupler.

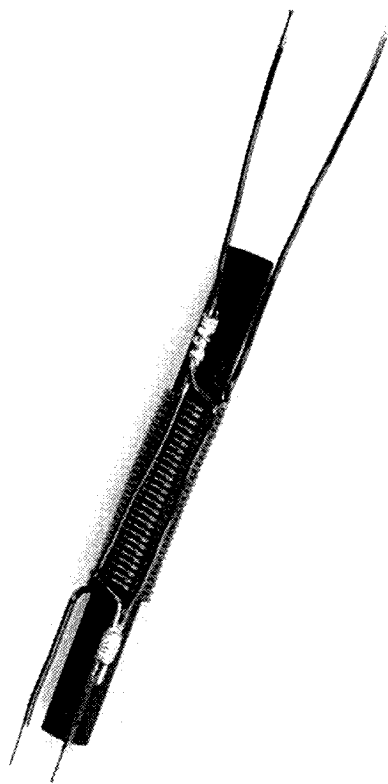

Photo 3 – The balun.

discharged.

## Construction

To circumvent sources of capacitive unbalance to nearby grounded objects, the coupler should be built upon a non-conducting base, or chassis. The assembly shown in Photos 1 and 2 has an MDF baseboard measuring 250 mm x 200 mm. The front panel is of Masonite, and measures 250 mm x 150 mm. The rear panel, which accommodates the SO-239 coax connector, is 60 mm high.

My two-gang broadcast capacitors have home-made aluminium L-section brackets fitted top and bottom to permit mounting 3 mm Perspex plates. These accommodate the banana (f) connectors (spaced 0.75"), and a pair of binding post terminals for connection of the feed-line. Note that the frames of the variable capacitors (although nominally at zero RF potential) must remain insulated from ground and each other.

Balun T1, shown in Photo 3 and Figure 2, may be made as follows. Take three 500 mm lengths of 1.3 mm/16 B&S ECW. Place them side-by-side together, and then fix one end of the group in your vice. Whilst maintaining a constant tension on the triplet, carefully wind 10 turns onto

a 100 mm length ferrite-rod/loop-stick (total, 30 turns). Snip, leaving tails of about 20 mm one end and rather longer tails of 60 mm at the other (the short tails connect to the coax connector, the longer tails should be twisted together to form a 50  $\Omega$  pair for connection to the bottom lugs of C1).

Remove 10 mm of enamel where connections shall be. Winding starts are shown dotted in Figs 1 and 2. Connect the end of winding one to the start of winding two, and the end of winding two to the start of winding three, as shown schematically in Fig 1, and pictorially in Fig 2. You should find it easier to make these connections by coiling a few turns of fine tinned wire around the join before soldering.

The 12  $\mu$ H coils, L1 and L2, are wound into pre-drilled 3 mm sheet Perspex formers. Their fabrication was outlined in Reference 15. Using a sharp penknife, remove/scrape about 25 mm of enamel from around the wire at the crest of each coil turn for connection of the shorting clip jumper lead. The coils may be mounted upon small, insulated spacers directly on to the aforementioned Perspex plates that accommodate the banana sockets and feed-line binding posts.

The shorting jumper leads should be fitted with good-quality alligator clips. The puny little clips normally available, when tested, became rather warm (indicating excessive contact resistance), yet we need clips that fit easily between the coil turns. If you have two of the very good "Utilux" types, use them. The wire for the jumper leads should be at least 32 strand/0.2mm.

The additional plug-in capacitors may be fitted to rectangles of low-loss sheet, such as acrylic/Perspex, together with appropriate banana plugs and sockets in a manner like that pictured in Photo 4.

## Operation

Using appropriate lengths of 50  $\Omega$  coax, connect the output of your transceiver to the coupler with an SWR meter interposed between. Adjust the coupler initially on receive for maximum background noise/signals. On 3.5 MHz, the jumper shorting clip may (typically) connect about a quarter to half way along each coil (the clips should each be at equivalent coil turns - but read on). On 7 MHz, about three-quarters along (that is, five turns in-line, or not shorted); on 14, 18 and 21 MHz, about three turns in-line; and on

24 and 28 MHz, about two turns. Bread bag closers pegged on to coil turns are handy for recording coil settings for each band.

When the coupler appears to be near optimum, and using a clear frequency, apply a low-power CW tuning signal and adjust C1 and C2 for lowest SWR. If the SWR will not come down to a low value, move the shorting clips to an adjacent turn and try again (although they are not at a dangerous potential, do not touch the clips when transmitting). On 3.5 and 7 MHz, you may need to plug in extra capacitance across either C1 or C2 - "piggy-back" where necessary (that is, where the capacitor "bottoms-out" at full mesh on a downward trend in SWR).

Hint: To achieve a very low SWR, it is possible to "fudge" a bit by positioning one clip lead one turn out of step with the other, with little effect on the line balance.

It is suggested that some means of monitoring the current in each leg of the feed-line be installed, such as either a very simple twin-lamp-on-a-loopstick device (like that described in Reference 16), or a twin RF ammeter, such as in Reference 17 (old timers were fond of saying: "It's amps up the stick that does the trick").

## Summary

Amateurs everywhere maintain a keen interest in the many types of antenna coupler, or "ATU" configurations. With up to eight HF bands available, it is usual for us to make one antenna operate on several, or all bands, which makes it necessary to employ an effective, wide-range coupler.

Popular dipole and loop antennas are "naturally" balanced, yet few of the commercially made couplers are capable of properly and efficiently interfacing between the unbalanced 50  $\Omega$  input/output of the radio, and a balanced antenna.

A number of experimenters have been re-discovering the benefits of using a balanced pi configuration. Based upon this work, a more practicable model has been built using locally obtainable parts, and proven to perform very satisfactorily, thus rivalling the traditional "link-coupler" in effectiveness.

## Parts

The ferrite rod/loop-stick for the balun is a Jaycar LF-1010. Similar suitable rods are also available from the other electronics



parts suppliers. The banana plugs and sockets are quite generic. Additionally, Altronics offer a stackable dual banana plug, P-0298.

500 V. silver mica capacitors may be mail-ordered from Antique Electronic Supply ([www.tubesandmore.com](http://www.tubesandmore.com)).

My dual gang variable capacitors (which are not rare items), insulated couplers, and two nice "National Velvet" vernier dials (verniers are not essential, as adjustment of C1 and C2 is not fiddly) were obtained at local swap-meets.

## References and Further Reading

1. Radio Communication Handbook; RSGB, 6<sup>th</sup> Ed., "Practical Feeders", p 12.30 or 7<sup>th</sup> Ed., p 13.30.
2. "ATU Power Ratings"; In Practice, I. White, G3SEK, RadCom June 1997.
3. "On the Quest for an Ideal Antenna Tuner"; Jack Belrose, VE2CV, QST, Oct 2004.
4. "The Simple Z-Match Tuner Simplified"; Lloyd Butler, VK5BR, Amateur Radio, June 2001.
5. "Wide-Range Coupler for Any Antenna"; ARRL Handbook, 42<sup>nd</sup> (1965) Ed, p354.
6. "Coupling the Transmitter to the line"; ARRL H'book, 32<sup>nd</sup> (1955) edn, p313.
7. "A Swinging Link Antenna Coupler"; Diamond, Amateur Radio, July 2000
8. "An Improved coupler for balanced and single-wire antennae"; Diamond, Amateur Radio, Oct 2003.
9. "A Balanced-Balanced Antenna Tuner"; Richard Measures, AG6K, QST, Feb 1990.
10. "ATUs for Balanced Tuned Lines"; Technical Topics, P Hawker, G3VA, RadCom, Aug 1999.
11. "Balanced-Fed Large Loop Antennas"; Technical Topics, P Hawker, G3VA, RadCom, Sep 2002.
12. "A Balanced, Everyday Approach to All-Band Bliss"; K Kleinschmidt, KT0Z, QST, Apr 2002.
13. The "Radio" Handbook; Frank C Jones, Pacific Radio Publishing Co, 1936 Ed., pp 256, 257.
14. "Tapped Inductors"; I White, G3SEK, In Practice, RadCom, Apr 1999, p 37.

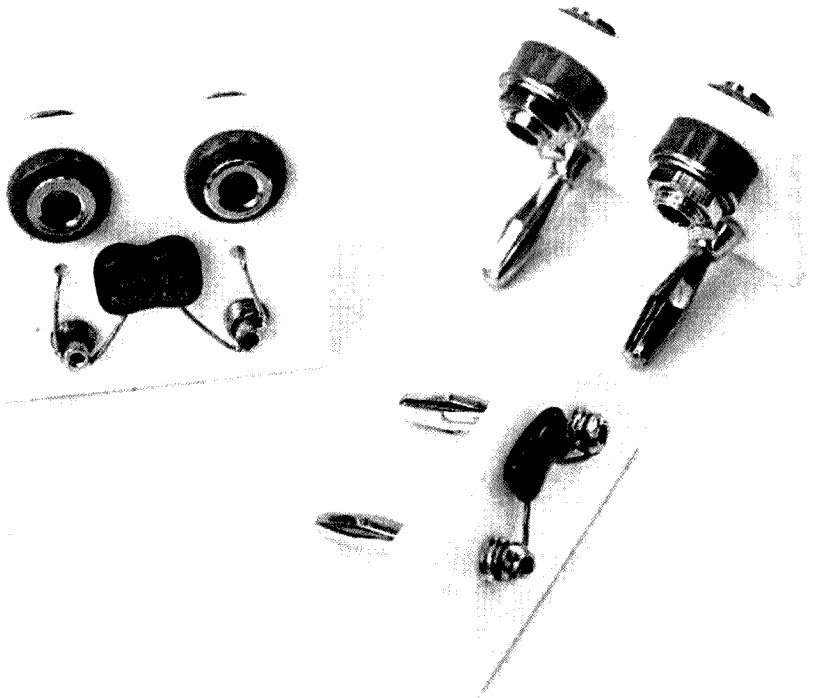

Photo 4 – The plug-in capacitor set.

15. "Notes on the "drilled Perspex" method of making low-loss transmitting coils"; Diamond, Amateur Radio.
16. "A Current Indicator for Open-Wire Transmission Lines"; Diamond, Amateur Radio, Jan 1999.
17. "RF ammeters for high-frequency measurements"; Diamond, Amateur Radio, Nov 2004.

Photos: Andrew Diamond  
([www.andrewdiamond.net](http://www.andrewdiamond.net))

\*A feed-line is said to be operating in a "balanced" manner when the instantaneous current in each leg is of the same amplitude, but flowing in opposite directions, and the voltage on each leg is equal, but of opposite polarity relative to ground. Their respective magnetic and electric fields are then strictly confined to the line, resulting in the highly desired condition of little or no radiation or pick-up from the line.

ar

## Coffs Harbour and District Amateur Radio Field Day

**Sunday 21st January**

St Johns Church Hall, Mc Lean Street, Coffs Harbour

8.30am to 3.30pm, On Rain Hail or Shine

Commercial Traders, Disposals, RF Scrambles, Lucky  
Door Prizes, Trivia Quizz, Home Brew Comps

Entry \$5.00 per person

Hot and Cold food available, Free parking

More Info Call Field day Coordinator Gary Ryan 02 66552990  
or e-mail [radiosupply@bigpond.com](mailto:radiosupply@bigpond.com)

**Australian made**  
**ANTENNAS**  
*Setting a new standard.*  
**COM-AN-TENA**

(formerly a j and j coman)

115 John Street  
 GLENROY 3046

23 cm 36 ele slot fed Yagi beam	\$190
2 ele delta loop 10/11 metre	\$249
2 ele quad 10/11 metre	\$249
10/11 beams comp opt 5 ele	\$327
10/11 5/8 vert 4 rad 1/4 wave	\$185
Tri band IIB 35 C 10/15/20 m	\$745
3 ele 20 m comp opt	\$460
log periodic 9 ele 13 30 8.4 boom	\$990
MBV 6-12-15-17-20-40-80	\$390
40 m linear loaded 2 ele beam	\$595
M B Vert auto switch 10/80 m	\$330
6 m 7 ele Yagi beam 60 mm boom	\$387
6 m 5 ele comptr opt beam	\$275
Top loaded 160 m vert	\$430
10 ele high gain 2 m 3.9 m boom	\$149
17 ele high gain 70 cm 3m boom	\$129
Rotable dipole 40 m	\$250
80 m top loaded vertical	\$239
dual band 2 m & 70 vert	\$140

**Guyed Masts**

**21 metres**      **13 metres**  
 Winch-up & tilt-over. Aluminium and stainless steel  
 three-sided construction. Auto-brake winches.

**Free Standing Masts**

9.5 metres

**New Baluns**

1-1 to 16-1 to 3kW



Our Masts  
 meet Australian  
 Standards.  
 We supply all the  
 computations and  
 data you will need for  
 a permit.

**03 9773 3271**  
**Mob: 0419 542 437**

**Equipment review**

**The Yaesu VX-6R and  
 FT-60R hand-held 144/430  
 MHz transceivers**

**Ron Fisher VK3OM**  
 ronlyrn@nex.net.au

**First the good news.**

You might have noticed on the inside front cover of AR recently that Yaesu, under their new name of Vertex Standard, have set up their own operations in Australia. In fact, right here in Melbourne. A few weeks ago, Ernie Walls VK3FM and I paid them a visit. Firstly, to introduce a couple of faces from Amateur Radio magazine and secondly to see if we could borrow some equipment to review. It was a case of "what would you like to have?"

I thought that a couple of dual-band hand-held transceivers which might be suitable for new Foundation Licence holders would be a good way to go. Ernie

and I were presented with about six of their current range. What to pick? My thought was something with a reasonable power output that could at least access a few local repeaters for those in urban areas and perhaps cover 100 km with an outside antenna for country operators. On that basis, we picked two with five watts output which is about the upper limit for hand held transceivers.

The two chosen were the VX-6R and the FT-60R. Although the designations are similar, they have very different facilities which I will discuss later. For many years, I have used an ancestor of these transceivers, a FT-209RH. This 20-year old transceiver is about three times the size and nearly three times the weight

of these new rigs. However, it puts out 6 watts plus and has all of ten memories. Hand held transceivers have come a long way in 20 years. So, let's start off with the VX-6R.

**VX-6R**

This is the smaller of the two, weighing just 270 g and it has the greater receive frequency coverage. In fact, it has continuous coverage from 500 kHz right up to 999.990 MHz. Before you think you might be able to dispense with your good communications receiver, you need to consider a few things. First, the antenna is only about 19 cm long, not exactly an outside dipole. Next, although it has continuous coverage the tuning steps on the shortwave bands



The VX-6R

*continued on page 20*

# Andrews Communications Systems



**ANDREWS TS-5118**  
**\$99**  
**2 m 2 W HANDHELD**

Factory direct importer

- Commercial quality
- 100 ch. memory
- Scanning searching
- AC plug pack
- NiCad battery
- Compact

★ ONE YEAR WARRANTY ★



**ANDREWS FD-160A**  
**\$129**  
**2 m 5 W HANDHELD**

Factory direct importer

- Commercial quality
- 99 channel memory
- Scanning CTCSS
- DCS Reverse report
- AC plug pack
- NiCad battery, etc

★ ONE YEAR WARRANTY ★

**AUSTRALIA'S LARGEST AMATEUR RADIO DISCOUNTER**

**EST. 1976  
 30TH ANNIVERSARY SALE**

**COMPARE!**



**YAESU FT-857D \$1299**  
**HF + 6 m + 2 m + 70 cm + DSP**

**YAESU**

NEW VX-6R Dual band Handheld	\$439
VX- 2R Dual band Handheld	\$299
FT-1802M 50W 2 m Mobile	\$279
VX-7R Deluxe Tri band Handheld	\$539
FT-60R Dual band Handheld	\$349
VX-170 2 m Handheld	\$249
FT-817ND HF-70 cm Portable	\$949
FT-857D HF-70 cm	\$1299
FT-897D HF-70 cm	\$1399
FT-2800M 2 m Mobile	\$299
FT-7800R Dual band Mobile	\$429
FT-8800R Dual band Mobile	\$649
FT-8900R Quad band Mobile	\$699
VR-120D Handheld Scanner	\$269
VR-500 All Mode Handheld Scanner	\$469
Yaesu antenna tuners & rotators discounted	
FC- 20 ATU \$399.00 FC-30 ATU	\$399
FC-40 ATU \$399.00 FP-30 P/S	\$439

★FIRST WITH THREE YEAR WARRANTY★

**ANDREWS 2780 \$499**  
**Twinband Mobile 50W/35W etc**

- WIRELESS WEATHER STATIONS
- DIGITAL MULTIMETERS FROM \$6
- MASSIVE STOCKS OF ANTENNAS
- OSCILLOSCOPES to 100MHz
- POWER SUPPLIES TO 120A, 30A \$199
- DUALBAND ANTENNA \$39
- SPECTRUM ANALYSERS to 2.9GHz, etc

**BONUS**



**ICOM IC-7000 \$2099**  
**HF + 6 m + 2 m + 70 cm + DSP + colour!**

**ICOM**

NEW IC-P7A Tiny DualBand H/held	\$379
IC-706 MKIIG HF-70 cm	\$1399
IC-718 HF 100 W	\$999
IC-746Pro-or-IC-7400 HF 2m ea	\$2699
IC-V82 NEW 7W 2 m Handheld	\$299
IC-756Pro III HF- 6 m	\$4499
IC-T90A Dual band Handheld	\$419
IC- 208H Dual band Mobile	\$549
IC- 2720 Dual band Mobile	\$649
IC- R5 Handheld Scanner	\$329
IC-V8000 2 m Mobile	\$349
IC-910H 2 m-70 cm All mode	\$2199
IC-R3 Handheld Scanner with TV	\$699
IC-R5 Handheld Scanner from	\$279
IC-R20 Deluxe Handheld Scanner	\$679
IC-R1500, IC-R2500, IC-PCR1500, IC-PCR 2500	
IC-AH4 Automatic Tuner	\$479
IC-AT180 Automatic Tuner	\$599

★FIRST WITH THREE YEAR WARRANTY★

**ANDREWS 808 \$279**  
**Highpower 75W 2m Mobile**

- LINEAR AMPLIFIERS
- AUTOMATIC ANTENNA TUNERS
- TOKYO HY-POWER, ANDREWS, TE, PALOMAR, AMERITRON, YAESU, ICOM
- ALL DISCOUNTED
- YAESU, ICOM, TOKYO, HY-POWER
- BEST RANGE OF SCANNERS IN AUSTRALIA
- BEST PRICES TELESCOPES & BINOCULARS

Factory direct importer

★THREE YEAR WARRANTY★



**ALINCO DR-635T \$699**  
**NEW TWIN BAND MOBILE!**

**ALINCO**

DJ-C7 Mini Dual band Handheld	\$299
DJ-596E MKII Dual band Handheld	\$349
DJ-V5E Dual Band Handheld	\$399
DR-135T MkII 2 m Mobile	\$299
DR-435E UHF Mobile	\$349
DJ-V17 5 W, 2 m H/H with DTMF etc	\$149
DJ-X7 Wideband H/H scanner	\$299
DX-70TH HF-6 m Transceiver	\$1199
DX-77E HF 100 W Transceiver	\$1399
DJ-X3 Tiny Handheld Scanner	\$299
DJ-X10 All mode Handheld Scanner	\$499
DJ-X 2000E Deluxe H/held Scanner	\$679
EDX- Auto Tuner	\$399
DM-330MVZ 3 2 A Power Supply	\$369

**KENWOOD**

TH-FTE Dual band Handheld	\$549
TM-V708A Dualband remote mobile	\$749
TM-D700A Dual band Mobile	\$849
TM-G707A Dual band Mobile	\$499
TS-480HX HF+ 200 W 6 m+100 W	\$1999
TS-480SAT HF-6 m 100 W+ATU	\$1799
TS-570SG HF-6 m 100 W+ATU	\$1999
TS-2000 HF-70 cm	\$2699
TM-271A 2 m 60 W Mobile	\$299

★FIRST WITH THREE YEAR WARRANTY★

**NEW! ANDREWS HIGH CAPACITY REPLACEMENT BATTERY PACKS FOR YAESU, ICOM, ALINCO, KENWOOD!**

**ANDREWS COMMUNICATIONS SYSTEMS**  
**(02) 9636 9060 9688 4301**

SHOP 8 41 Bathurst Street  
 Greystanes NSW 2145  
 Fax 9688 1995  
[www.andrewscom.com.au](http://www.andrewscom.com.au)

**MAIL ORDER SPECIALISTS SINCE 1976**

Keep up with our full product range on [www.gccomm.com.au](http://www.gccomm.com.au)

Proudly Supporting Australian Business

# G&C

## COMMUNICATIONS

Authorised dealer for • ICOM • YAESU • Kenwood • Barrett RFDS • GME Electraphone • Uniden

See us for **CAR Stereo too!** ~ 'Cranbourne Car Sound'

FREE Gift with all Icom's top selling Amateur Radios sold on the day

# ICOM Open Day



Refreshments available from take-away food shop next door.

### 9am–1pm Saturday February 10, 2007

Come and 'Test-Drive' some of Icom's world-beating rigs

at G&C, 207 High St (South Gippsland Highway) Cranbourne (Mel 133J3)

IC-2200H



VHF 2m FM Transceiver. Icom's 'King of the Road' with a green or amber display, large controls, and all that send and receiver power you expect from Icom. IMD keeps pesky pagers at bay, squelch control kills strong interference and the microphone can control everything. And of course we've got memory, GPS compatibility, Hot Keys, scan and external speaker capability.

Talk about your radio needs with Icom's representative.

All radios with Icom Aust. 2 - Year Warranty

More specifications on back cover

IC-T90A



A robust aluminium bodied, big buttoned, compact handheld with 5 watts on 6m, 2m and 70cm. 5 hours operation from the 1300 mAh battery pack. A whopping 555 organisable channels memory storage with DMS makes this a leader in handhelds.

IC-P7A

The go anywhere mini dual bander. VHF/UHF dual bander with 1.5W/1.0W output power (One band at a time). CTCSS and DTCSS tone for repeater access and quiet stand-by. Minimum number of buttons for simple operation. 1000 alphanumeric memory channels with flexible memory bank system. Supplied rapid charger, BC-164, charges the battery pack in 3 hours (approx.)



IC-7000



The advantages of IF DSP found in our leading base station models now goes mobile on HF, 50MHz, 144MHz and 430/440MHz bands. Demountable fascia makes IC-7000 at home in the car or shack. IF DSP from two chips across all amateur bands. Manual Notch Filter lets you capture those weak signals. 1kW of grunt. 503 memory channels and a host of other features

207 High St. Cranbourne VIC 3977  
Ph: 03 5996 3298 Fax: 03 5995 0184

Email: [gccomm@bigpond.net.au](mailto:gccomm@bigpond.net.au)  
[www.gccomm.com.au](http://www.gccomm.com.au)

## Equipment review: The YAESU VX-6R and FT-60R hand-held 144/430 MHz transceivers

*continued*

is a minimum of 5 kHz. Taking all of that into account, with a piece of wire five or six metres long and a few turns around the stubby antenna, I was quite amazed at just what I could hear. The stronger international broadcast stations came in loud and clear. There is, in fact, a pre loaded memory bank with 89 short wave frequencies which cover most of the international broadcast channels. These are identified with the country to which you might be tuned. There are no facilities for SSB reception, so amateur band reception is not really possible. Standard broadcast band reception was reasonable but again a short wire improved performance greatly. Of course, the higher in frequency you tune, the better it gets, so the FM broadcast band is really quite good. The aircraft band is as good as a dedicated receiver that I often use and of course the sensitivity on the 2 m and 70 cm band is as good as, if not better than, many hand-held transceivers. The receive audio quality is better than average. Now, let's look at the operation on the two amateur bands.

First, its memories: How about 900? These are arranged into 24 banks, with two special banks. The first special bank I covered above, the second is programmed for the VHF marine channels. This leaves plenty for normal amateur operation. Memories can be labelled with their frequency or you can give them a name which could indicate location. Maximum power output is five watts, but there are three lower settings. These are 2.5, 1.0 and 0.3 watts.

If you like tuning around your choice of steps is 5, 10, 12.5, 15, 20 and 25 kHz. In most cases, I prefer to set it to 25 kHz, which fits in with the Australian band plan. Audio reports on transmit were very good and the received quality was well balanced with very good high frequency response. Sitting in my shack I was able to access several repeaters with the furthest about 120 km away.

All in, this transceiver was a delight to use. I spent hours just tuning around. If I owned a VX-6R, I'm sure I would spend more time listening than transmitting. As a passing thought, if you are a scuba diving enthusiast, take the VX-6R along with you. It's water proof down to about one metre.

## The FT-60R

This unit is the heavy weight of the pair. It is exactly 100 g heavier than the VX-6R. However, at 370 g, it is certainly not overweight. It is very comfortable to hold and has quite a chunky feel. The full general coverage receiver is not available with a low frequency end starting at the start of the aircraft band at 108 MHz. From there it goes to 520 MHz. Then from 700 to 999.999 MHz. It also has five watts maximum output with two lower power settings. These are 2 watts and 0.5 watts. Memory capacity is an amazing 1000 plus. The 'plus' amounts to 50 band edge memories, and ten weather broadcast channels. These weather channels do not exist in Australia as yet. The normal memories are arranged in ten banks. If you are planning a visit to Europe, 1750 Hz tone burst is included, which will give you access to repeaters in that part of the world.

On-air testing resulted in excellent audio reports on transmit. On receive, I thought that the audio lacked high frequency response. I certainly preferred the sound of the VX-6R. However if you

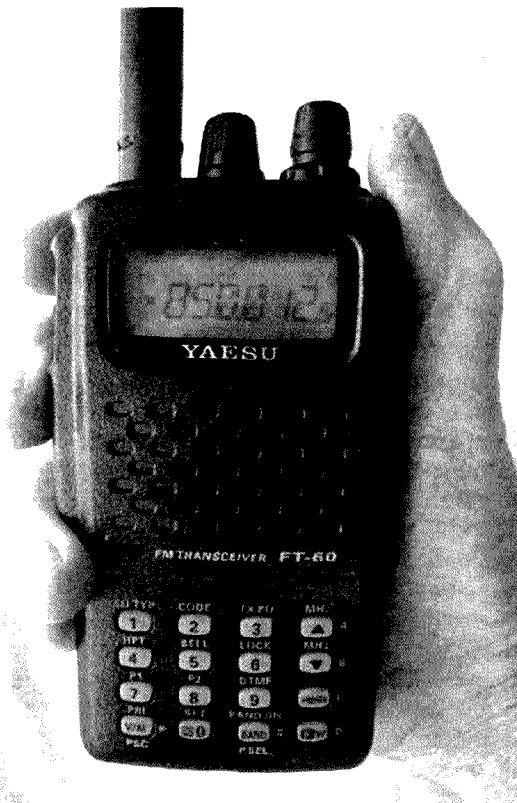

FT-60R

are buying one, have a listen to both, you may have a preference either way.

The batteries supplied with these transceivers are interesting. The FT-60R is supplied with the FNB-83 battery pack, rated at 7.2 volts 1400 mAh. The VX-6R comes with the FNB-80LI, which is rated at 7.4 volts and 1500 mAh. Look at the

*continued on page 27*

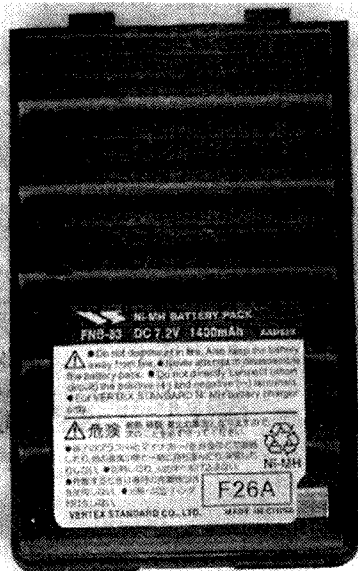

Two battery cases – similar capacity, but very different sizes due to differing battery technology

# Electrical safety at the workbench

Kevin B. G. Luxford VK3DAP / ZL2DAP  
kevinluxford@bigfoot.com

**Electrical safety is something that we should not take for granted. Few amateurs would think that they do, yet how often do we audit the area where we construct, or operate, our gear?**

Some years ago, I asked an electrician to refurbish my electrical supply board at the front of the house. At the time, there had been a number of over-voltage situations in our neighbourhood causing damage to electrical appliances inside the home. The electrician replaced all fuse blocks with circuit breakers, and except for the circuits supplying the refrigerator and stove, these were of the earth leakage detection type. A current differential (between active and neutral) of about 30 mA will cause the circuit breaker to drop out within milliseconds. He also installed on the supply board a large MOV device which clips voltage spikes. At the same time he discovered that sometime within the occupancy of a previous owner, the supply board earth has been disconnected

from the ground stake! After I had paid his bill, I felt that I had done something tangible to improve the safety of myself and my family.

However, two recent incidents caused me again to take stock. My wife and I are almost empty nesters these days, so one end of the old family room inside the house has been converted to an electronic workshop so that I do not have to work in a cold garage. On returning home one day, we thought that we could smell smoke that had 'escaped' from electronic components. We searched high and low, but could find no evidence of overheating in any appliance or piece of equipment. My engineer daughter then gave me a much-deserved serve about ensuring that all equipment has been disconnected from

the mains before you leave the house.

A short time later, Jim Linton VK3PC, got me involved in teaching courses to the new ACMA Foundation and Standard licence syllabi. One of the sections in each course concerns safety. The project described here arose out of the application of that training material to my own situation.

## One switch to disconnect all equipment from the mains

The principle of this project is that there should be just one switch which cuts the power from all equipment in the workshop and which also provides a highly visible indication of its status. Non-amateur family members should be able to see at a glance whether the power is off, and if not, to be able to switch it off should the old man forget to do so before leaving the house. An AC ammeter to monitor total current drawn from the mains is considered very desirable.

Many of us use inexpensive power distribution boards, because of the many items of gear that we use when constructing or operating. Most of these do not draw high currents, but they all require a plug to be inserted into a general purpose outlet or distribution board socket. In my own case, I have a couple of soldering irons, a de-soldering gun, a couple of step-down transformers (see below) for powering equipment from the U.S.A. or Canada, an oscilloscope, a signal generator, a frequency counter, and so on. One distribution board is just not enough.

## Need for organisation

The number of instruments and radios I have near my workbench made a tidier organisation mandatory. A trip to IKEA obtained shelving from their Ivar range which is ideal, as it is relatively inexpensive and very flexible in that the number of shelves and the spaces between them are readily adjustable. This shelving fits nicely on my workbench (which is

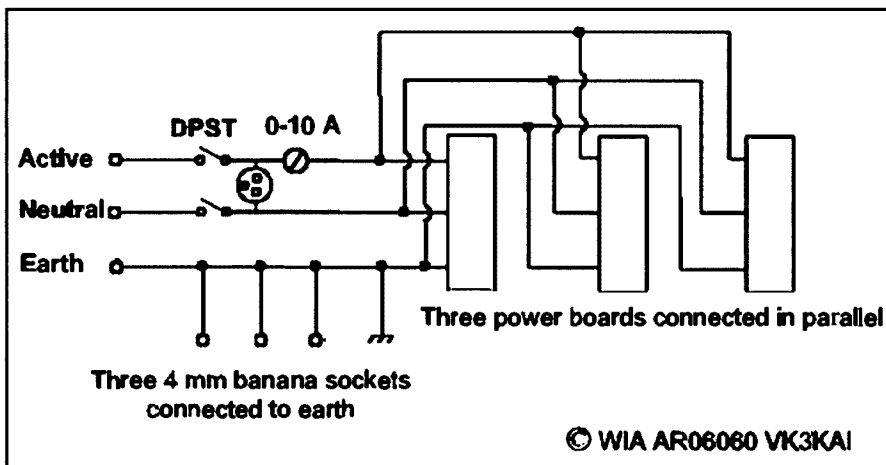

Fig. 1 – Circuit diagram

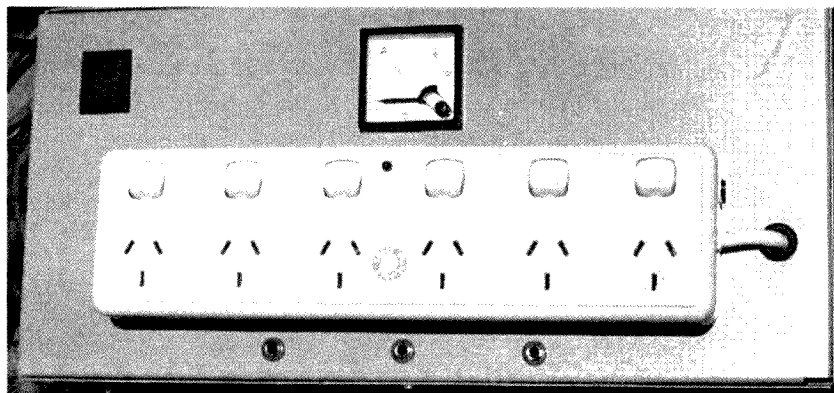

Photo 1 – Front panel

an old half-sized billiard table with a strong wooden cover) and the shelves are attached to wall studs to prevent them from tipping over. Another happy advantage is that there is enough of a gap between shelves on the same level in adjacent sections to allow mains power cords to be routed down from equipment to bench level, so that the cords are both physically protected and practically out of sight. When passing the mains plug between shelves on the same level, one shelf has to be lifted to allow the plug to go through the gap. Some help from a family member may be required.

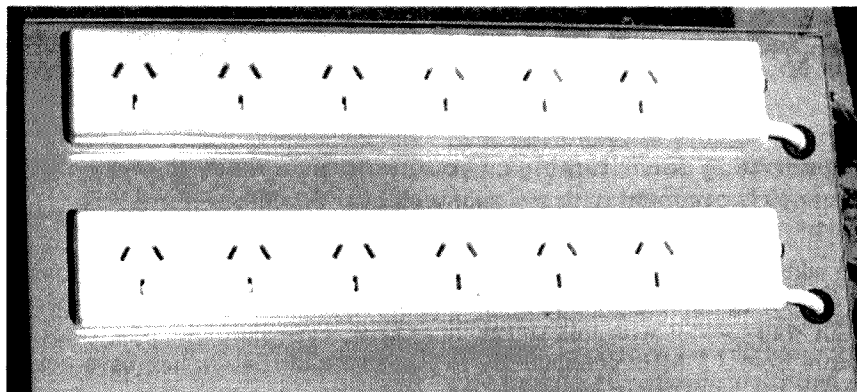

Photo 2 – Rear panel

## Workbench power distribution system

The system makes use of a metal enclosure, three power distribution boards (two without individual outlet switches, the third board with switches), a 15 A double pole single throw rocker switch with inbuilt neon indicator, a 10 A moving iron AC ammeter, heat-shrink tubing, some spade type 'Faston' connectors, grommets and cable clamps. The circuit is shown in Figure 1.

The two boards without switches are attached to the back panel of the metal enclosure. The board with switches is attached to the front panel along with the on/off switch, the ammeter and three green 4 mm banana sockets each connected to mains earth. These sockets are to enable the antistatic workbench mat and wrist strap to be earthed. See Photos 1 and 2.

A general shot of the wiring is shown in Photo 3. Important features of the wiring include the insulation of the 'Faston' connectors with two layers of heat shrink tubing, all connectors being both crimped and soldered, and all wiring being supported mechanically by use of cable clamps and nylon cable ties. Power cables passing through metal panels are protected by grommets.

The distribution system thus has 12 outlet sockets on the back panel and six on the front. The back panel outlets are used for items of equipment which are generally permanently plugged in to the distribution system, each item having its own on-board switch and mains indicator lamp. Some nylon identification cable ties were obtained from Farnell (Order Code 433-998). These are like nylon cable ties with a rectangular identification tag. They were used to label the power cord, just behind its plug, for every item of equipment. The tags were

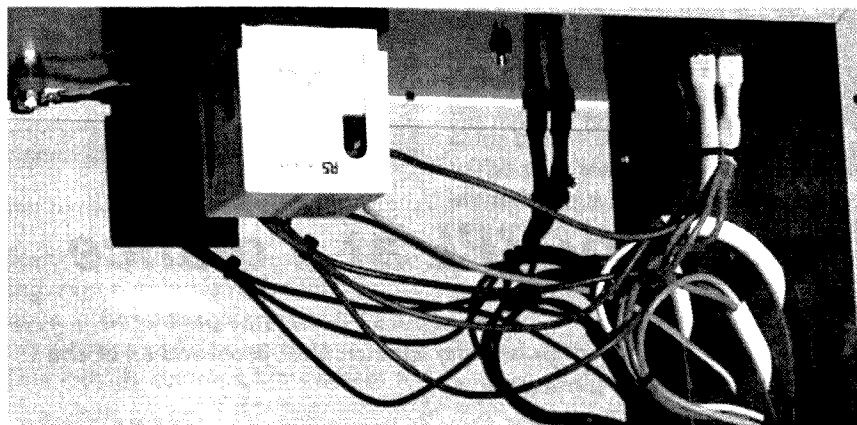

Photo 3 – Wiring

written with a 'Sharpie' felt pen available from Officeworks. So now the workbench is generally free of a tangle of power cords.

## Step-down transformers

Each 230 V AC to 115 V AC step-down transformer was installed in a separate metal enclosure, and fitted with an appropriately rated fuse, and a DPST rocker mains switch with neon indicator. Several USA NEMA standard outlets (with earth) were fitted to the panel of the enclosure and wired in parallel. One side of the transformer secondary (the 115 V winding) was connected to the mains neutral.

## Static electricity risks

The advisability of anti-static measures was amply demonstrated after the distribution system was put into operation. One nice fine Spring day, after working on restoring some old valve Heathkit equipment, I got off my draughtsman's chair (just wonderful for electronic work), and went to switch off the main switch. I inadvertently touched the metal panel and got quite a 'static belt', such as from getting out of a car on a hot day. Had I been working with static-sensitive gear,

it could have been expensive. So make a habit of wearing an antistatic wrist strap connected to mains earth while working!

## A note on enclosures

I used a metal enclosure that I happened to have on hand. However, a perfectly satisfactory substitute can be constructed using two similar sized pieces of aluminium sheet and some timber from which to make a rectangular frame. Screw the aluminium panels to the timber frame so that it is impossible for fingers to get into the space between the panels. Make sure that each panel is connected to mains earth.

The metal panels in this project are steel. Moving iron meters will work OK when mounted in a steel panel, but the accuracy of d'Arsonval (moving coil DC) meters is affected by steel surrounds; however non-metallic or aluminium panels are OK.

## Conclusion

Electrical safety need not be an expensive exercise, but it does require a bit of analysis and organisation. You and your loved ones depend upon it.

ar

# BPL Trial at Mt Beauty

Jim Linton VK3PC

**Imagine sitting down, turning on your transceiver ready to make a pre-arranged 'sked' contact to find the frequency is occupied with a signal well over S9. Never mind.**

Then discover that the entire band has been taken over by this monster signal. Try another band, then another, but they are all wall-to-wall with this signal. It appears from 3.5 MHz continuously to 30 MHz, the entire tuning capacity of the transceiver!

Well that is how Ian Paul VK3FIOP (now VK3LJJ) of Mt Beauty in north-east Victoria learnt that a new Australian trial of Broadband over Powerlines (BPL) had arrived in his neighbourhood, without any prior warning to him.

Other major trials have taken place in Tasmania – Burnie, and Hobart (2 trials), and New South Wales – Moruya, Queanbeyan and Newcastle – plus a few other small trials which have not been publicised.

Ian was hit with immediate disappointment. He thought that his amateur radio operating was now going to be confined to VHF or UHF, even forcing him and his family to move home.

In the first hours and days a lot of emotions were at play, but Ian remained

composed and on track, studying for his Standard Licence assessment.

He telephoned ACMA, which let him know that the BPL operator was SP AusNet. A phone call to the company left their representative somewhat surprised that there was an amateur radio station in the cluster of eight streets targeted for the six month trial of BPL.

Four days after the BPL system was turned on into 'test mode', and after Ian complained, he received a letter from SP AusNet warning him "...there are potential emissions and possible risk of interference from the BPL systems. Our BPL systems will be using frequencies from 1 - 35 MHz."

The system at Mt Beauty is fed via a head-end linked to a fibre optic network and then distributed along the powerlines through full duplex repeaters.

BPL places carriers 1.1 kHz apart across the entire frequency spectrum used. The BPL signal uses blocks of spectrum a few MHz wide, a different block being used for uplink and downlink transmission.

In BPL-speak, these blocks of spectrum are called "modes". Repeaters use different "modes" in and out, and as the range of the signal is severely limited, re-use of the same block of frequencies is possible within a BPL network.

With a multiple repeater network, all of the HF spectrum could be used, possibly a reason why Ian is experiencing interference across the entire HF spectrum.

SP AusNet is Victoria's biggest energy transmission and distribution utility. The company had chosen Mt Beauty in January this year and installed BPL repeaters on every second power pole in an area around eight streets.

In media reports, SP AusNet said that Mt Beauty, being in a valley, was ideal because it gives the company a clear test site for interference because there is very little background noise.

From Ian's point of view, his QTH was a quiet RF location with an ambient noise level of S2-3 before the arrival of BPL. His S-meter is now on full scale deflection. Using a mobile station on three

## Mt Beauty BPL at a glance

**SP AusNet (majority owned by Singapore Power) has partnered with iLevo, a subsidiary of Schneider Electric that provided all of the components for the BPL network.**

A total of 50 residents in the alpine town with a population of 2,300 (much greater during the snow season) are expected to be involved in a six month trial.

In return, they receive free and 'unlimited' broadband as part of the test on the viability of delivering internet and other broadband services over powerlines.

The package includes a dedicated e-mail address, an iLevo SmartBPL Modem including separate ports for Internet, USB (Universal Serial Bus), and VoIP (Voice over Internet Protocol). Encouragement is also provided for those who want to obtain video on demand via broadband.

Ian Paul VK3FIOP was invited by SP AusNet to join its BPL trial. Using the supplied SmartBPL modem, he was successful after several days of trying to connect.

The BPL system at Mt Beauty is being used in a 'last mile rural town scenario', where the BPL equipment in this trial area is linked to a high speed fibre optic network.

More than 20 pole-mounted repeaters have been installed in a cluster of eight residential streets, plus one to serve the Mt Beauty Neighborhood Centre – a community based training facility which includes internet access for residents.

Mt Beauty residents already have broadband and this test, apart from interference measurements, may be useful for a commercial viability comparison with the other non-BPL providers of broadband services.

ar

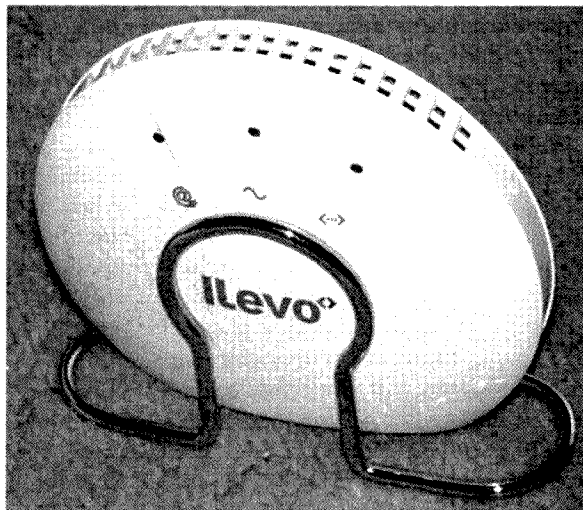

BPL modem.





The on-pole BPL repeater hardware.

80 m and 40 m, but the BPL interference continued to blanket the 10 m and 12 m bands.

The author of this article visited him over three days to provide assistance and verify the situation. Recordings were made of the interference as observed on three transceivers including an 'out of the box' brand new IC-706MKIIG. A battery powered portable shortwave receiver was used to observe the interference while walking.

A mobile HF station patrolled the streets where the BPL hardware had been installed and observed strong signals that continued to be received for about 400 metres outside the area. Radio contact between VK3PC mobile and VK3FIOP was not possible on the affected HF bands at the time.

The next step for Ian was to exercise his right as the holder of an apparatus licence and lodge a formal written complaint to ACMA about the substantial interference.

He has a firm ground for doing so. The interference was confirmed as BPL, its source known and substantial and harmful

days outside the BPL trial area showed ambient noise on the HF bands at Ian's pre-BPL levels.

He sought help from the WIA and Amateur Radio Victoria. SP AusNet

appeared sympathetic to the interference being experienced and undertook to remove amateur frequency bands from the system and reduce its power.

This initially returned Ian's access to

# TET-EMTRON

## Antenna Manufacturers

### New Tet-Emtron Vertical Range Features

- All Aluminium with Stainless steel hardware.
- No adjustment needed to main antenna.
- Light.
- Free standing-no guy wires.
- 1 kW PEP power rating.
- Can be ground mounted or elevated.

The new TET-Emtron Vertical range is designed with ease of use in mind. Tuning is done by the radials when the antenna is in its final position (where possible). The radials can either lay on the ground, be buried or hang from the elevated antenna. The antenna comes with a set of radials that has a resonate radial for each band. Further sets can be ordered from TET-Emtron if desired. See the web site for more info and a complete dealer list.

### New Tet-Emtron Vertical Range

TEV-4      TEV-3      TEV-3Warc

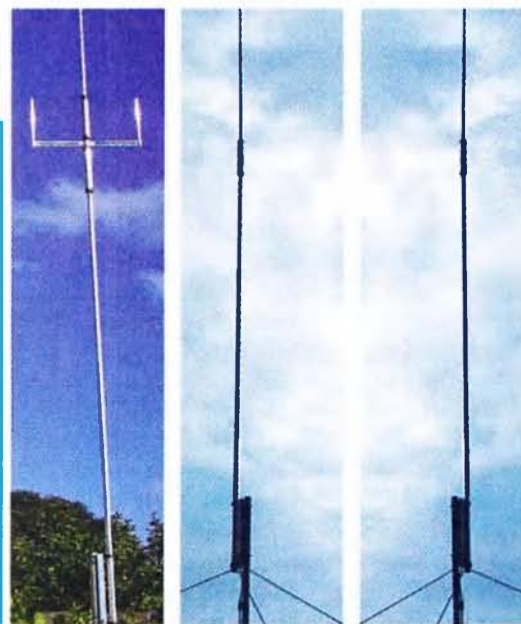

40 Blackburn Street  
STRATFORD  
Victoria 3862 AUSTRALIA

www.tet-emtron.com  
Email: rawmar@hotmail.net.au

Ph: 61 3 5145 6179  
Fax: 61 3 5145 6821  
ABN: 87404541761

Antenna	TEV-4	TEV-3	TEV-3 Warc
FREQUENCY	7, 14, 21, 28 MHz	14, 21, 28 MHz	10, 18, 24 MHz
ELEMENT HEIGHT	4090 mm	3800 mm	5025 mm
FEED IMPEDANCE	50 ohm	50 ohm	50 ohm
Max. RADIAL LENGTH	10.7 metres	5 metres	7.5 metres
SWR	1.5 or less	1.5 or less	1.5 or less
POWER RATING	1 kW	1 kW	1 kW

impact to his licensed amateur service communications well documented.

A few days later Ian sent his formal complaint of substantial interference to ACMA, which received it on a Friday. On that same day, the BPL system returned to radiating emissions over the entire 3.5 MHz to 30 MHz spectrum and it appeared to him to be stronger than ever.

Ian VK3FIOP appears to be the first VK radio amateur to actually lodge a formal complaint of interference to ACMA. The amateur service, being a licensed radiocommunications service, is protected from substantial interference under sections of the Radiocommunications Act.

ACMA is the Authority responsible for administering the provisions of the Act and is required to investigate cases of interference when they are reported. It confirmed with Ian it would indeed investigate his complaint.

Without complaints, BPL operators may be able to claim that the technology is not cited in any formal way to have caused interference to radiocommunications.

It is vitally important that any radio amateur affected by BPL interference



The sound of BPL interference is just too much for Ian Paul VK3FIOP (now VK3LJJ)

first verify that the interference is in fact caused by a BPL system, and secondly lodge an effective interference complaint with ACMA.

Without a valid and effective interference complaint lodged with ACMA, little can be done. The WIA

provides a BPL interference advisory service to all radio amateurs (WIA members and non-members) at [www.wia.org.au](http://www.wia.org.au) or if still unsure of what to do, contact your local radio club.

ar

# **BPL History in Australia**

**Broadband powerline technology attracted the interest of some in the Australian electricity industry in 2004; both as a potential new revenue source, and as a tool to better manage power distribution networks.**

When trials of BPL began, knowing the consequences of similar trials overseas and of the strong possibility of severe interference to HF radiocommunications from its use on the Australia power distribution system, the WIA expressed its concerns in a letter to the then Australian Communications Authority (ACA).

The regulator, by now ACMA, explained its position in these terms: "ACMA is intending to work with affected parties to develop arrangements that do not unnecessarily inhibit BPL deployments but preserve the utility of the radiocommunications spectrum."

As an interim measure, ACMA set up a BPL web portal which contained details of the trial guidelines for both Access and In-House BPL. The guidelines were, and still are, simply 'guidelines' and are not enforceable, although no doubt ACMA would take a dim view of anyone not acting in the 'spirit' of their 'guidelines'.

A rather novel approval to the regulation of BPL was suggested in 2004 by some members of the BPL lobby, although not publicly, that recreational and amateur users of HF radio be treated as 'less significant' users of spectrum, and not be afforded protection against interference.

In April 2005, ACMA issued a discussion paper on the management of interference from BPL applications that attracted more than 270 submissions. ACMA also embarked on a consultation process with the companies trialling BPL and organisations that are potentially affected by BPL deployments including the amateur community.

More recently ACMA said, "ACMA is currently examining the need or potential for regulatory action in respect of BPL services."

ACMA's BPL web portal explains that those conducting trials of BPL equipment where services are supplied to users are

required to seek a 'trial certificate' from ACMA before commencing a trial. These trial certificates allow companies to trial new networks and services for a period of six months without the need to hold a carrier licence.

A trial certificate is not required if the company nominally conducting the trial also holds a telecommunications carrier licence. Carriers are not required to post details of their trial on the ACMA BPL web portal.

However ACMA has said, "Irrespective of whether the person conducting a trial is a carrier or not, all trials are subject to the ACMA regulations and laws concerning radiocommunications interference."

ACMA has taken some interference measurements during BPL trials and plans to publish an outcomes paper indicating its preferred arrangements for future deployment of BPL in Australia....

ar

# QSL cards from the WIA National QSL Collection

Ken Matchett VK3TL  
Hon. Curator

## ZV zero TI – Trindade

This was a special callsign allocated to the ABRA-DX Brazilian expedition to this quite rare DX country. (Listed equal first in the 'most wanted list' from VK DXers in the August 2006 edition of AR.) Often misspelt as *Trinidad*. This country was first listed as Trindade

and Martin Vaz Is. in 1958 with the prefix PY zero. They are two islands in the Southern Atlantic Ocean lying off the coast of Brazil, and are a possession of that country. Such QSLs are eagerly sought by IOTA chasers, this one being SA-010.

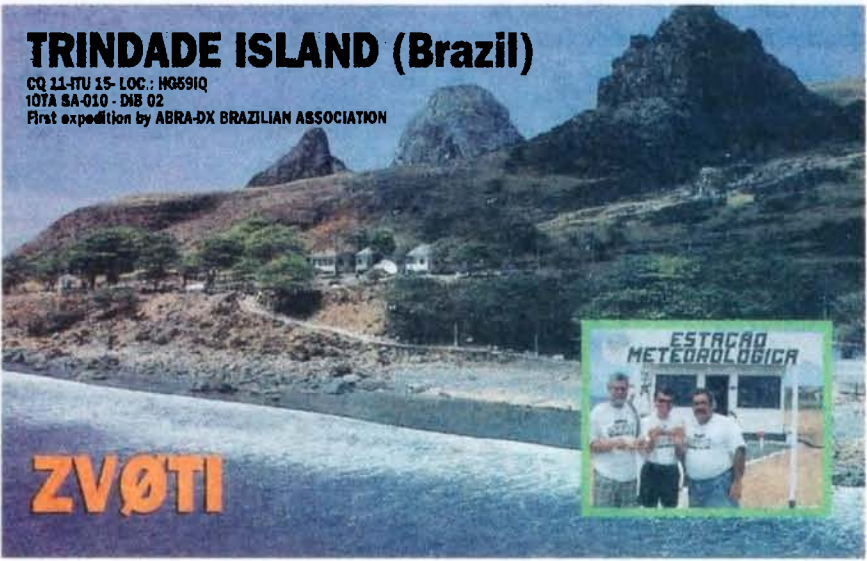

## FO/SP9FIH – Marquesas Islands

This rare DX country was added to ARRL lists in 1998 with the prefix FO/M. It is a French Polynesian island in the South Pacific, north-east of Tahiti. QSLs are valid if dated after March 31, 1998. IOTA OC-027. On the reverse side of the QSL we read that there are big mountains, deep

gorges, forests and waterfalls. Colourful flowers everywhere, but the expeditioner also points out that there is no shade during the hot noon sun and there are plenty of mosquitoes and large-size cockroaches. Nothing is perfect, even in the South Pacific!

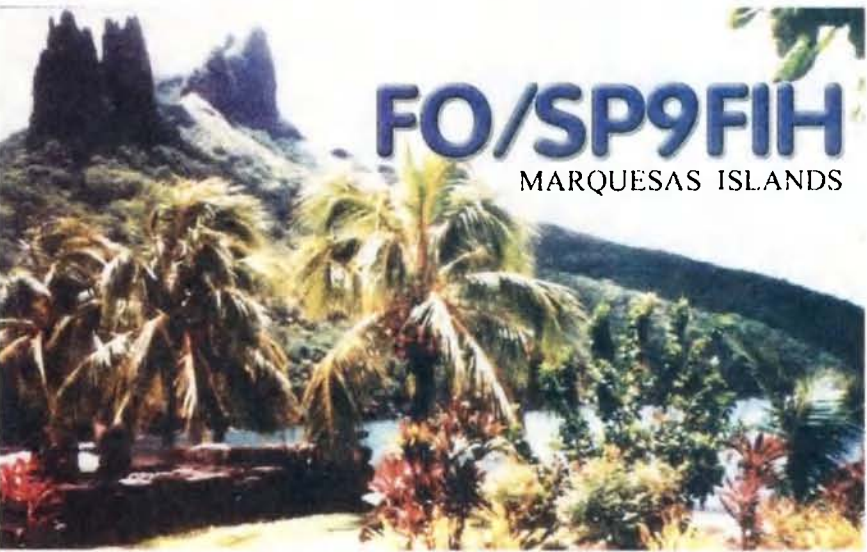

# Rippletech Electronics

**HIGH PASS FILTERS FOR TVI PROBLEMS**  
Most TVI problems are due to the inability of the TV set to reject strong out-of-band signals – i.e. those from a local HF transmitter. Rippletech High Pass Filters are designed to reject all HF signals, not merely optimised to reject CB. The HPF-50/55 has a cut-off frequency of 50 MHz and better than 55dB of attenuation on 10m and at least 80dB of attenuation on 80m.



TZ-1840	1:1 1kW 160-10m Balun	\$ 59.00
TZ-330-4	4:1 1kW HF Balun (3 - 30 MHz)	\$ 59.00
TZ-SL8	80m Sloper (use tuner on 17 - 30m)	\$ 99.00
TZ-SL16	160m Sloper (fits a suburban lot!)	\$ 110.00
TZ-D-4080	40m/80m Trapped Wire Dipole	\$ 176.00
TZ-V-3	10/15/20m Trapped Vertical	\$ 189.00
TZ-V-4	10/15/20/40m Trapped Vertical	\$ 289.00
TZ-V-3L	20/30/40m Trapped Vertical (NEW)	\$ 220.00
TZ-V-3w	12/17/30m Trapped Vertical	\$ 199.00
TZ-V-3x	12/17/40m Trapped Vertical	\$ 209.00
	Radial kits (1 radial per band)	\$ 33.00
TZ-RD-3	10/15/20m Trapped Rotary Dipole	\$ 279.00
TZ-RD-3w	12/17/30m Trapped Rotary Dipole	\$ 289.00
TZ-RD-3x	12/17/40m Trapped Rotary Dipole	\$ 309.00
TZ-RD-40	17/40m or 20/40m Rotary Dipole	\$ 289.00
TZ-1000RC	FT-1000mp remote controller	\$ 55.00
HPF-55/5C	High Pass TVI Filter (available now)	\$ 39.00
	Mobile base & Z bracket combo	\$ 11.00

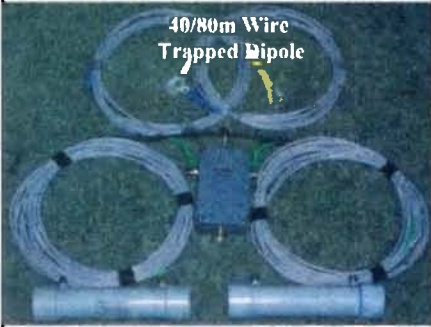

### The Innovator - not the imitator

Our tri-band, quad-band and tri-band WARC verticals have been big sellers for several years now, so good imitations are starting to appear! Compliments abound – check out buyer satisfaction on our ebay sales. We couldn't be more flattered. The verticals are perfect for the ham with limited space, field days, mini expeditions or travellers. With a packed length of only 1m, they fit in your boot or on a plane. Using the same high Q, sealed coaxial traps exhibiting 40 dB of isolation at resonance you get really great performance & ultra wide bandwidth. Even better is the ease of set-up, comprehensive and detailed instruction manual and no compromise construction.

**Need something special?**  
Make a call and we'll see if we can meet your needs.

**www.rippletech.com.au**  
Contact Tony – VK3TZ, B.Eng (comms) MBA  
0402 622 562 or 03 9887 4936  
email:  
**sales@rippletech.com.au**  
Mastercard, Visa and Bankcard accepted

## TVI High Pass Filter with Braid Breaker.



### An inline TVI filter with Braid Breaker.

A large amount of TVI can travel down the outer braid of Coax as well as the centre conductor. The braid breaker isolates the centre conductor and braid from the TV/VCR/DVD. The High Pass filter cuts in at 50MHz. This filter has -80dBm attenuation at 40, 80 and 160 Metres.

### Pager Notch Filter:

A receive filter that can be used in an outdoor housing (Pictured) to be mounted close to your antenna on the mast, or can be used in a diecast box for indoor use near your transceiver or receiver. The filter is set to 148.5 MHz but may be tuned by the user across the 148 to 149 MHz Pager band. A selection of connectors are available including BNC and N Type. Where transmit is required this filter can be switched out of circuit by the use of coaxial relays linked to the PTT switch.

Contact us if you need a special filter, we manufacture here in Australia rather than overseas



[www.vicnet.net.au/~jenlex](http://www.vicnet.net.au/~jenlex)

Email: [jenlex@vicnet.net.au](mailto:jenlex@vicnet.net.au)

Phone: (03) 9548 2594

FAX: (03) 9547 8545

# VHF-UHF Spring Field Day 2006

Greg Parkhurst VK1AI

This year's Spring VHF-UHF Field Day, held on the weekend of 11-12 November, provided the perfect opportunity to take to the hills in search of some DXing on the higher bands, and the propagation conditions didn't let us down.

The VK1BL station escaped the suburbs to the peak of Mt Coree in the Brindabella Ranges, about 25 kilometres north-west of Canberra. Mt Coree, one of the highest peaks in the Brindabellas, rises to

about 1420 metres above sea level, and provides an excellent place for 2 metre and 70 cm operating. We also made some entertaining contacts on 6 metres with low powered equipment.



For 2 metres and 70 cm work, we used a Yaesu FT-847 (about 50 watts PEP) into a 15 element beam antenna for 70 cm and a 10 element beam for the 2 metre band. On the 6 metre band, we used a Kenwood TS-660 running about 10 watts PEP into a 4 element beam. For local 2 metre FM contacts, we also had a Yaesu FT-480R running into a quarter wave ground plane antenna.

We learned early on that you can expect high winds in high places. I lost count of the number of times my hat blew away, and we had to make sure our antennas were guyed strongly. While setting up our station, a particularly strong gust of wind caused a break in one of the guy ropes supporting the mast for the 2 metre and 70cm antennas. Having luckily avoided the falling mast, we then had to spend a few minutes straightening some of the antenna elements before we could raise the mast and start operating. The wind aside, we had a fun time atop the mountain. The trip to the top was worth it just for the fantastic view.

Activity levels on the Saturday

afternoon were disappointing. Between roughly 1500 and 1600 local time, despite making numerous calls on all three bands, we made no contacts at all. This was not long after having worked into the Townsville area on 6 metres, and we began to wonder whether the amateur community had completely forgotten there was a contest happening.

Fortunately, the level of activity picked up in the late afternoon and early evening. A good number of Canberra stations gave us calls on all three bands, particularly 2 metres, and the time seemed to pass more quickly.

We experienced some spectacular and unusual propagation on all three bands late on Saturday evening. Of particular note were our contacts with VK2DAG (Gosford area) on all three bands, VK2KKZ (Forster area) on 2 metres and 70 cm, and VK2FZ (Sydney area) with strong signals on 2 metres and 70 cm. We also had a very pleasing contact with VK2IF (Kempsey area) on 2 metres on Sunday morning.

Until Sunday morning, we were

wondering where all the VK3 operators were. We did hear VK3UHF for a few brief moments on Saturday afternoon, but it was not until early Sunday morning that the first VK3 callsigns entered our log. In future, we hope the VK3s will be looking for us earlier in the contest - they can be sure we'll be calling and listening for them!

The Summer VHF-UHF Field Day will be held on the weekend of 13-14 January 2007. Bushfires permitting, we'll be back on the mountain again, listening and calling on the bands. We're planning to add 23 cm to our current capability, as we heard about other operators making good contacts on this band during the Spring Field day.

Thanks to all stations who made it into our log. We'd be delighted to see you again in January. We'd also like to hear many more new callsigns, including operators from home stations. If the usual summer propagation conditions prevail, we're sure everyone will have a great time.

ar

**Equipment review: The YAESU VX-6R/E and FT-60R/E hand held 144/430 MHz transceivers**  
*continued*

photo of the two battery packs side by side. You will see that one is twice the size of the other. It just goes to show the difference in energy density between Nickel Metal Hydride and Lithium Ion technologies

**FT-60R and the VX-6R conclusions**

The performance of these transceivers on the amateur bands is for all purposes very much the same. If you really need the extra receive frequency coverage then the VX-6R might be your choice. My pick is the FT-60R which provides good performance at a lower price.

It has been a pleasure to have a play with both of these transceivers. Both are excellent performers and if Yaesu quality is as good as it was twenty years ago, they should still be going strong in 20 years time, just like my old FT-209RH.

The current retail price for the FT-60R is \$369 and the VX-6R is \$499. However, as always, shop around. Vertex Standard tells me that when the first shipment of the new FT-2000 HF transceivers arrives, they will make one available for AR to review. Watch this space.



An "old-timer" with two of its modern successors

ar

# Spotlight on SWLing

Robin L. Harwood VK7RH

## A year of SW downturns

Well another year is rapidly coming to a close. This year has seen a downturn in shortwave broadcasts, freeing up channels to reveal stations not normally observed. Stations such as Radio Finland will be departing shortwave on December 31st and we will miss the only news broadcast in Classical Latin, which was axed at the end of October. Radio Slovakia departed shortwave in July but reappeared at the commencement of the current broadcasting period.

Radio Slovakia International is currently broadcasting to Australia as follows:

0700 - 0730	Australia English	13715
	Australia English	15460
0730 - 0800	Australia Slovak	13715
	Australia Slovak	15460

December sees the centenary of the first wireless telephony broadcast by the Canadian experimenter, Professor Fessenden. This was on Christmas Eve

1906, from Brant Rock, near Cape Cod, Massachusetts. However documents have recently surfaced, stating that Fessenden was conducting wireless telephony test transmissions as early as 1905 and on the 12th of December 1906 staged a test broadcast, prior to the Christmas Eve program. These experiments continued into 1907. Interestingly the first mention of this broadcast did not appear until 1923 and certainly was not mentioned in the press in 1906.

Canadian Amateurs are permitted to use special prefixes to mark the 100th anniversary of Reginald Fessenden's first voice broadcast over radio. This authorisation will last for two months from December 1, 2006 until January 31, 2007. VE stations can use CG, VA can sign CF, VY stations can use CY, and VO stations can use the CH prefix. You can check the callsign database at <http://www.callsign.ca/>.

I received a recent query about a broadcasting station appearing within

the 80 metre amateur allocation. I was surprised to observe it myself at 1200 UTC on 3578.9. It was in Indonesian with a relay of the RRI News from Jakarta. The day I first heard it coincided with the end of the Ramadan period and consulting the latest edition of Passport to World Band Radio 2007, there is a listing of a low powered district station at Masohi, wherever that is. It is listed as being irregular and not surprisingly, the signal does not appear daily and often has poor modulation. I assume that the sender was pushed into service for the end of the Ramadan period.

I recently came across a station on 11510 at around 1240, broadcasting in a western Asian language. I initially thought it came from one of the former Soviet republics but PWBR 2007 informs me that it is Radio Deewa or "Light". The language is Pashtoo, which is spoken in the almost inaccessible Pakistani-Afghan border regions. Naturally, the

*continued on page 30*

## Precision Frequency Counter

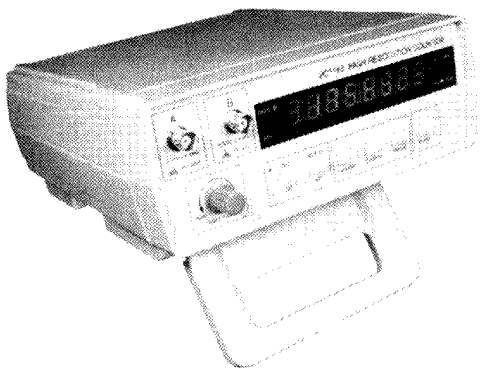

**\$119 DELIVERED**

MODEL VC3165

• 8-digit LED display, clear reading

- Range & gate time adjustable continuously (100ms - 10s)
- Selective range
- Frequency measurement: 0.01Hz - 2.4 GHz
- Period measurement
- Input sensitivity: 30mV(rms)
- High stability
- Power: AC

Geoff White (VK6NX) **08 9498 1157**

(Please leave a message if unavailable, I'm at home looking after a 18 month old future ham)

116 Amethyst Cres, Mt Richon, WA 6112

**cityonline@wdsi.com.au**

Payment via Paypal, Cheque or Bank Transfer.

## Handhelds 2m or 70cm

LOCKED OUT FOR HAM BAND ONLY

144 TO 148 MHZ (VHF)(2M) OR 420 TO 450 MHZ (UHF)(70CM)

**\$99**  
delivered in AUS

### SPECIFICATIONS:

- 1) Voice Prompt on Keypad
- 2) CTCSS with 39 codes
- 3) 99 Storage channels
- 4) Auto scan
- 5) Large screen LCD
- 6) Back Lighting
- 7) VFO programmed (input freq. from keypad)
- 8) Hi & Lo Power select
- 9) Channel spacing: 5KHz, 10KHz, 12.5KHz, 25KHz
- 10) Keypad lock
- 11) Monitor function (input frequency)
- 12) Low-battery warning
- 13) Frequency Modulation
- 14) Auto power save
- 15) Output power: 4 - 5W
- 16) Large-capacity battery
- 17) Ear/microphone auto-charger connections

**SIMPLEX & DUPLEX**

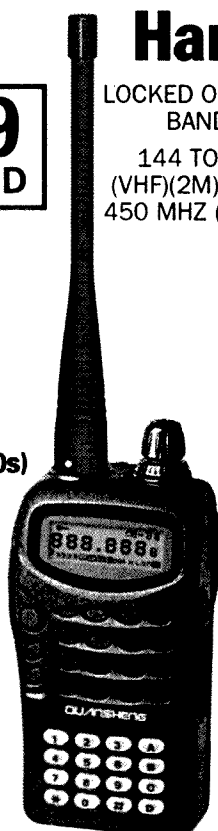

### Extras

Extra Battery (1100mah)	\$10
Speaker Microphone	\$12
Car Charger	\$12
(can charge spare battery and handheld at the same time)	
Headset/Microphone	\$8
SMA to BNC Converter	\$5

# Ulverstone JOTA activities

Susan Brain VK7LUV

Alan VK7JAB and I attended JOTA at the Leven District Scout Camp of Paton Park (which is approximately 15 km from Ulverstone on the banks of the Leven River). The Scouts in attendance were from 1st Penguin, Turners Beach, 1st and 2nd Ulverstone and North Motton troops.

We were fortunate to have a computer room set up for JOTI, which was well used from the Friday evening right through to Sunday lunch time. Our first (and most exciting) JOTA QSO was to HL5NLQ Kang in South Korea on Friday evening. Our keenest Scout, Matthew (who has attended JOTA with us in the past) was in the radio shack as soon as he had set up camp and was delighted to speak with Kang for several minutes. HL5NLQ mentioned that there are not so many Jamboree stations in South Korea nowadays but he was pleased to hear that we are still active in this manner in VK.

We had fantastic QSOs with a number of other JOTA stations, including VK4SMK (Banksia Scout Group), VK1HS (Mt Rogers Scout Hall), VK5ARC (Hackham Scouts) and VK2SBB (at Bateman's Bay). Coincidentally, the OM who prepared the antennas for the station run by VK1HS visited us at Paton Park on the Sunday and was delighted that we had made contact with his home group. The conditions were great for our QSOs, which were all quite lengthy. One of the Scout leaders (Mike Norris) who repairs the wire antennas for us each year for 40 m and 80 m, joined with me in talking to the group about the new Foundation Licence and our Scouts were thrilled to speak with a couple of other Scouts who are now using their Foundation licences - Scott VK7FREK and also Nat VK3FNAT.

The other JOTA operators did a fantastic job and it was a really enjoyable and successful weekend.

33 Susan, VK7LUV



Photo 1. Mike Norris (Ulverstone Scout Leader) repairing the 40 m antenna

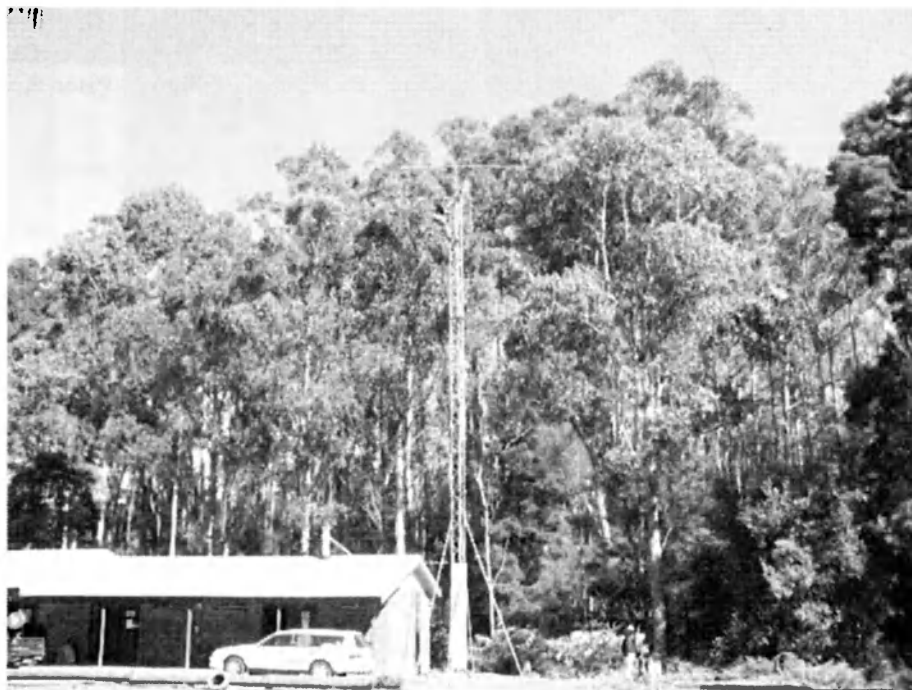

Photo 2. The antenna tower and radio shack at Paton Park Scout Camp

## Ulverstone JOTA activities *continued*



Photo 3 - Scouts in the JOTI shack at Paton Park



Photo 4 - Scouts at Paton Park for JOTA 2006



Photo 5 - In the radio shack at Paton Park - Sandy, Kirralee, Natali, Susan VK7LUV, Matthew (with the mic) and Nicky



Photo 6 - Paton Park Scout Camp, NW Tasmania

## Spotlight on SWLing *continued*

programming is targeting the Taliban guerrillas that are holed up there in the mountains and caves. The station, which is backed by the NATO coalition, is easily heard as it comes from a 250 kW sender in Sri Lanka.

Korea has been in the news of late, following the recent entry of the northern part of the divided nation into the nuclear club. The UN quickly imposed economic sanctions on the Pyongyang regime in an effort to get them back to six-party talks to resolve the crisis. Pyongyang has been operating a string of clandestine stations for many decades and their external broadcasts are extremely boring. They can

be heard in Korean on 6250 and 6398.9 in parallel. Seoul, on the other hand, has actually reduced their shortwave capacity, especially to Europe and North America and they stopped broadcasting to this region about a year ago. KBS World can be heard in English to Asia from 0800 to 0900 on 9570.

Japan also is seriously concerned about the situation on the Korean Peninsula and a station emerged to broadcast programming to highlight the plight of hundreds of Japanese nationals who were abducted to North Korea by intelligence agents in the sixties and seventies. They are using senders in the Russian Far East

and also in Taiwan with programming in Japanese, Korean and English. In addition, the Japanese Government ordered NHK to highlight the plight of these abductees in their external service programming, NHK World (formerly Radio Japan). Tokyo currently has English broadcasts to Oceania at 0300 - 0400 on 21610, 0500 - 0700 and 1000 - 1100 on 21755, and from 2100 - 2200 on 6035 relayed from Singapore.

In conclusion, may I extend season's greetings to you and hope shortwave will continue throughout 2007.

73 from Robin L. Harwood VK7RH

ar

ar



# More JOTA 2006 activity from VK7

Roger Nichols VK7ARN  
sarncon@bigpond.com

Members of the WICEN group of the Radio and Electronics Association of Southern Tasmania Inc. gathered at The Lea Scout Camp, south of Hobart, for the 49th JOTA.

The Wellington District Scouts were in camp over the weekend for JOTA and other activities. More WICEN members catered for the Blackman's Bay Scouts at their hall. There was to be a third group, Cygnet Scouts, working from a camp site on Vines Hill at an altitude of 595 metres. However, forecast snowfalls to the 600 metre level led to a cancellation – not by WICEN though! The “high altitude” team split between the other groups and lessened the load.

JOTA contacts from The Lea were predominately on HF, with additional VHF and IRLP QSOs.

All photos were by VK7ZZ.



Scott VK7FREK oversees on-air activity.



Bruce VK7MBD and Scott VK7FREK on watch.



Three young Scouts enjoy on-air activity

[www.pca.cc](http://www.pca.cc)

Email from anywhere

via **Winlink**  
2000

Use **FACTOR-3**

on HF to send  
Mail, Grib Weather,  
Weatherfax & Images

Contact [marc@pca.cc](mailto:marc@pca.cc)  
Sydney 02 8902 0107

## Silent key

### Robin Powell VK7FRVP

It is with sadness that we announce the passing of a North West Tasmanian Amateur Radio Interest Group club member, Robin Powell VK7FRVP.

Robin will possibly be remembered from years ago when he was well known in the CB arena. He spent several years in the USA and returned in recent times to his home state of Tasmania.

It wasn't long after his return that Robin acquired his Foundation Licence.

He is now at peace following a sustained period of illness.

Farewell Robin, from your CB and amateur mates.

Vale Robin VK7FRVP.

(Tony VK7AX)

# TEN-TEC'S MIGHTY SIGNAL HUNTERS

Led by Orion II, the Mightiest Hunter of all



**Model 566  
 Orion II**  
 Ultra High-End  
 HF Transceiver



**LDG  
 AT 7000  
 Tuners  
 Now In  
 Stock**

## Model 6000 Vector Network Analyser

Turn your PC into a VNA

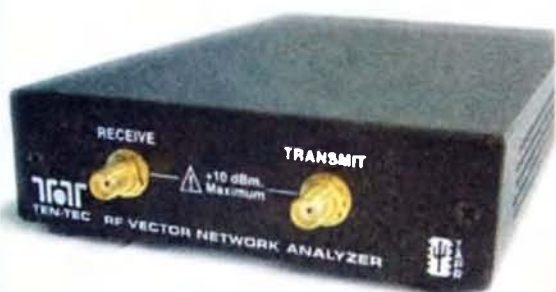

We now stock Diamond  
 Antennas & Accessories

### BUDDIPOLE

#### Dipole – vertical...

Optimised for transmit power, proven for DX work.  
 Ultra light materials, High-Q coils.  
 Zero-loss balun with Quick-Connect feedpoint.  
 Standard Comes with—

- \* Two 22" black aluminium arms. \* Two multi-band coils (40-10m).
- \* adjustable coil tap pre-marked system \* Two SS telescopic whips. \* VersaTee™ w 3/8" x 24 adaptors
- \* BNC/PL259 coax connector, 25' of RG58 coax



**Model 538 Jupiter**  
 An enduring favourite

Check us out  
 for  
 Solar Panels,  
 Regulators and  
 Deep Cycle  
 Batteries

## We also supply

- LDG DTS-4 & DTS-6 Coax Switches
- Amidon Iron Powder & Ferrite Coil Forms
- AUTEK WM1 Computing Power/VSWR Meter
- Buddipole Antennas
- Professional RF Cables and Connectors

**KITS**  
 for all  
 levels  
 of DIY  
 Amateur



# TTS Systems Communications Equipment

[www.ttssystems.com.au](http://www.ttssystems.com.au)

**FREE CATALOGUE**

**HF and VHF Transceivers, Autotuners and Kits**

Phone 03 5977 4808. Fax 03 5977 4801 [info@ttssystems.com.au](mailto:info@ttssystems.com.au)



# PALSTAR INC

## Now available in Australia

Palstar manufacture a range of amateur products of outstanding quality.

**Superbly engineered and robustly built in the USA**



**AT-AUTO -- A 1500 WATT HF AUTOMATIC ANTENNA TUNER.**

A pair of stepping motors provide smooth control of a heavy-duty roller inductor and a 5KV split stator variable capacitor to form the heart of this superb ATU. No clunky relays rattling away in this one!  
3 year warranty



**AT1KM MANUAL ANTENNA TUNER**

A well designed HF tuner using a roller inductor and a split stator variable capacitor rated at 1200 watts PEP.



**ZM-30 ANTENNA ANALYSER**

A compact DDS (Direct Digital Synthesis) based antenna analyser. 1 to 30 MHz normalised for 50 ohms. The ZM-30 has some nice features not seen on other units.

3 year warranty

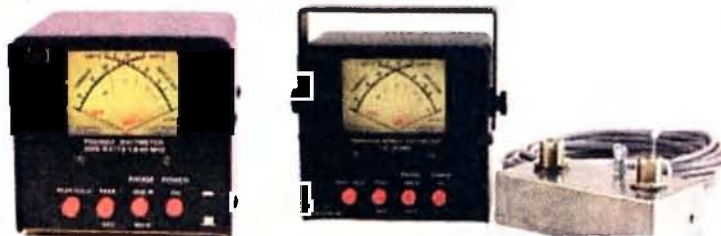

**PM2000A & PM2000AM WATT-METERS**

The PM2000A (Bench top) and the PM2000AM (Mobile/Portable) watt meters feature cross-needle meters, peak and peak hold with backlighting. Switchable power ranges are 300 and 3000 watts.



**R30C & R30CC SHORTWAVE RECEIVERS**

These high performance double conversion receivers tune 100KHz to 30MHz Modes USB, LSB and AM. Portable battery operation with compact size. The R30CC includes Collins torsional mode filters for AM and SSB. 3 year warranty

**OTHER PALSTAR PRODUCTS**

- Manual antenna tuners up to 3500 watts
- 1500 watt balanced antenna tuner
- High power dummy loads – with and without metering
- Low pass and high pass filters.
- Active antenna
- Roller inductors and variable capacitors
- Turn counters for roller inductors
- 4kW baluns. Both 1:1 and 4:1



# TTS Systems Communications Equipment

[www.ttssystems.com.au](http://www.ttssystems.com.au)

**FREE CATALOGUE**

**HF and VHF Transceivers, Autotuners and Kits**

Phone 03 5977 4808. Fax 03 5977 4801 [info@ttssystems.com.au](mailto:info@ttssystems.com.au)

## KVK Antenna Systems

Best value books in VK.

The VK Antenna Handbook for Restricted Spaces

Best value antennas in VK.

The NuBeam

The Vertical-LR-dipole multiband vertical

As seen at Wyong

Check out the latest revision to the web site - more info, more antennas, more value.

For direct purchases

[www.grimshaw.net.au](http://www.grimshaw.net.au)

For credit card purchases:

[www.kvkanennas.com.au](http://www.kvkanennas.com.au)

or ph 07-3216 8060 or

fx 07-3216 8075

# Saint Anthony's Scout Group Toowoomba VK4SAT: JOTA 2006

Matthew Weatherley VK4TMW  
[matthew@t130.aone.net.au](mailto:matthew@t130.aone.net.au)

The Scout leaders of Saint Anthony's Scout Group, Toowoomba (VK4SAT) asked the Toowoomba and Downs Wireless Group (TADWG), based at Highfields, to assist them to participate in the 2006 Jamboree On The Air (JOTA).

Rex Testoni VK4ART provided a 16-metre telescopic antenna pole. On top was mounted a 2 m / 70 cm dual band 'J Pole', a club construction project.

The plans for this excellent 'J Pole', sent to us by Gavin VK7HGO from the Radio and Electronics Association of Southern Tasmania originally came from the Adelaide Hills Amateur Radio Society. It is easy and cheap to construct as a club project.

Hoisted up on a pulley was a G5RV, to give the group a good signal on HF.

The Blackman's Bay Scout Group VK7SBB at Kingston in VK7 were contacted by Matthew VK4TMW, using a Yaesu FT-1500M, via the Gold Coast

repeater (IRLP Node 6702 VK4WIG on Mt. Tamborine), about 132 km direct over two mountain ranges.

The Stroud Scout Group, located about 65 km north-east of Newcastle in VK2, was contacted on 40 m by Ewen Cameron VK4HEC, using an Icom IC-7000. The Stroud operator was Brian VK2BI.

The limited time that the Scout group had on-air, together with the difficult propagation conditions prevailing, prevented overseas contacts; however, because of the enthusiasm generated amongst the twelve Scouts that took part, it is probable the TADWG will have a busy time in tutoring Scouts and leaders in the Foundation Licence in 2007.

## FEATURE TECH



### AT3000

Automatic Tuner  
1.8~30MHz, 200W

Smart Tuning No need for control cable  
Rapid Tuning 2s fist tune, 0.5s memorized



### USB Link-All

Fully Isolated  
Radio-PC Interface

Connecting rig to PC soundcard  
USB port to control PTT and frequency

### Pocket Frequency Counter

Frequency Range:

10Hz ~ 50MHz

1MHz~2.6GHz

Stability: 1ppm (VCXO)

Battery: Rechargeable Li-Ion



<http://featuretech.co.nz>

Ph: 64-9-630 5078 Fax: 64-9-630 5038

Email: [sales@featuretech.co.nz](mailto:sales@featuretech.co.nz)

Featuretech Limited



Some of the Saint Anthony's Scouts who participated. Rear left is Ewen Cameron VK4HEC, the Scout wearing the cap is Peter Boyce, one of the group Leaders, on the microphone is Scout Tom Vonhoff, with Matthew Weatherley VK4TMW supervising.

ar

## Season's Greetings

As this is the December issue and there will not be another *Amateur Radio* till February, please accept Christmas and New Year Best Wishes from all in ALARA and to all in ALARA. The year seems to roll past so quickly that it is not till one looks at the date that one realises how close we are to Christmas.

Here in VK5 we have a special occasion to mark the beginning of the Festive Season, with the Christmas Pageant held on the first Saturday in November. This pageant has been running since 1932 and was started by just one man after he saw a pageant in New York. The main difference between our Christmas Pageant and almost all the other Christmas Pageants is that there is absolutely no advertising or any sponsored floats. All the floats are made in a workshop which runs all year, and the performers are (these days) all employees of the Credit Unions. In the past, all the performers were employees of the store built by the man who started it all, Edward Hayward of John Martins' Store.

Anyone who has ever performed as a clown, a space man or a maypole dancer (or any of the other characters), will never forget the experience. I certainly haven't!

Officially, Father Christmas has arrived. I hope you all have bought all your Christmas presents or put your orders in to Father Christmas!! The latest Yaesu, Icom or Kenwood, maybe??

## JOTA and ALARA YLs

No doubt there are many YLs who participated in JOTA across Australia but only a few of them have passed the details on. If you want your activities reported, you have to tell me, Christine VK5CTY, or Dot VK2DB.

In VK5, at the 3rd Goodwood Scout Hall, Jenny VK5FJAY and her OM Kevin VK5AKZ were operating. They had contacts on 2-metres, 70 cm, and a few on HF. Unfortunately, because of the low propagation level at the moment, the children could not always hear the HF stations, even though the adults, with ears more attuned to listening underneath the noise, could.

Several Scout groups visited the 3rd Goodwood hall, which was well set up



Jenny VK5FAJY with Celia at JOTA

for the event. There were charts with phonetic alphabets and activity sheets for the children to fill in, whether or not they actually spoke to anyone. Sometimes, of course, a station would be contacted but there would not be any children present, at one or the other end.

If you have ever participated in JOTA, you will know that it is not always possible to have both a contact and children present simultaneously!! Frustrating, but quite normal.

However, from the 21 Scouting members at 3rd Goodwood on the day, Celia from 1st Darlington and Megan from 3rd Goodwood had good radio contacts. In particular, Celia (shown in this photo with Jenny) had a long conversation with the Commissioner for Scouts in S.A., who was at Scout Headquarters at Woodside, in the Adelaide Hills.

Stations in Darwin, Tasmania and Victoria were all contacted on HF and quite a number of VK5 groups, on 2-metres. Not marvellous, but there were no DX stations to be found.

Shirley VK5JSH and her OM Jim VK5JST helped to run a station at the Morphett Vale Scout hall, and Susan VK7LUV went to the same group that she has helped out before.

## Kids and Radio

Here is Shirley's report:

*On Saturday of the JOTA weekend I spent a few hours at the local Scout Hall (Hackham) with the South Coast Amateur Radio Club's station, helping young people to talk on the radio and hopefully*

*become interested in amateur radio. Oh boy, did I have fun.*

*The group who were visiting during my shift were a youngish group (7 and 8 year olds - Sea Scouts from the Hallett Cove area). They understood the concept of talking into a microphone, but alas were a little confused as to where the return sound was coming from. I had to remind the odd one that the sound didn't come back out of the microphone (as in a mobile phone) as he held the mic up to his ear. We had fun talking to other Scouts on 2 metres*

*around the Adelaide metropolitan area, finding out about each other's hobbies, sport, brother/sisters, pets and one young chap amazed my group by saying that he had visited America 3 times. That's when the natural enthusiasm for information came to the fore. "Where did you visit?" "Did you see snow (in winter)?" "How long was the plane trip?" This young chap was very popular with lots of my group. I know the 20-metre band in the other room was well patronised by the older kids, but didn't have a chance to listen in as I was so engrossed with "kids and radio". Thank you to the radio group at Glenelg from whom our group borrowed a very effective antenna on a trailer for the weekend. So, to any of you who haven't had the experience of Kids and Radio, give a try. You'll learn something worthwhile and have loads of fun.*

73, Shirley VK5JSH

There were more stations this year using Echolink or IRLP and the specials satellite link set up for the Scouts was kept busy, by all reports. Very likely, as used to be commonly done some years ago, there were Scout halls with ATV stations, as an extra interest. As far as possible amateurs try to expose the Scouts to as many aspects of amateur radio as possible.

Thanks to all, OMs and YLs who participated.

*continued next page*



## The Wireless Institute of Australia

ACN 004 920 745

### Election of Directors

## Call for Nominations



Pursuant to clause 14.1 (c) of the Constitution the WIA Board has determined that the election of directors shall be conducted by postal ballot.

Four directors appointed by clause 12.6 (b) of the Constitution retire at the conclusion of the next Annual General Meeting which will be held at a time and a place to be announced but not later than 31 May 2007, namely Michael Owen, Ewan McLeod, Robert Broomhead and Glen Dunstan. Each is eligible for re-election and Michael Owen, Ewan McLeod and Robert Broomhead have offered themselves for re-election to three of the four vacancies.

Nominations are called for from others also seeking election as a director of the WIA.

A director must be a voting member of the WIA and must hold an Australian amateur radio licence.

Any person wishing to nominate as a candidate for election as director of the WIA must deliver or cause to be delivered to the Returning Officer by not later than 31 January 2007:

- A statement signed by the candidate signifying his or her willingness to be a candidate for election as a director together with;
  - the full name, age, occupation and callsign of the candidate, and
  - such other biographical details or other information as the candidate wishes to accompany the ballot papers, but in all not exceeding 250 words.

Delivery to the Returning Officer may be made by hand when the WIA national office is open at:

Suite 10, 229 Balaclava Road, Caulfield North, Victoria 3161

or by mail to:

PO Box 2175 Caulfield Junction, Victoria 3161.

Nominations received by facsimile or by electronic means cannot be accepted.

**David A Wardlaw, VK3ADW**  
Returning Officer

### **ALARA continued**

## Another VK5 YL/ Foundation Licensees activity

Recently there was a Scout canoe marathon for which amateurs provided the communications. Providing this service and generally assisting there were five F call YLs. Is this a record I wonder, or just a sign of the times? Whatever it is, it is great to see.

## The YL International Meet in Mumbai

This will have been run by the time you read this, and a report will appear in this column in the next few months but I wonder if anyone contacted the Special Event station?

The callsign was AM6MYL. The station was to run from 15th October to 29th October, before and during the MEET. I hope you did make contact and I remind you that if you did, you must not forget to send for the special QSL card to add to your collection.

Gwen VK3DYL attended the MEET where she represented both ALARA and

WARO. Others reported to be going include Eime SM0UQW and Unni LA6RHA. It sounded as though it was going to be a very interesting MEET that would give some of the visitors a chance to see a part of the world they may not have seen before.

## Advanced warning

There will be a special Anniversary Challenge next year to celebrate 40 years of CLARA. The aim is to work 40 YL amateurs between 1st January 2007 and 31st December 2007. The details will follow, but just in case you work a YL before the next AR comes out - make sure you keep an accurate record.

Perhaps you can make some of the YL contacts when you participate in the Midwinter Contest run by the Dutch YL Committee. This is on 13th and 14th January. All HF bands and all modes are allowed but no cross-band operations count. Every worked DX country works as a multiplier (each country to count only once even if it is contacted on more than one band or mode during the contest!). An interesting idea for a multiplier.

For extra points, there is a special club

station to look for, operating on both days.

Logs to go to Chantal PA3GQG, QSL the international callbook or by Email to [jckoeok@home.nl](mailto:jckoeok@home.nl).

## VK5 Luncheon on Friday 13th

This time, as it was Friday 13th, the theme of the luncheon was black cats. There were black cats with green eyes and black cats with blue eyes (for the Siamese cat lovers).

There were also small packets of black cats to eat. Interestingly no one refused them because they were flavoured with aniseed.

In VK5, the regular luncheons are held on the second Friday of the month. In VK6, there is a luncheon on the third Thursday of the month. Get in touch with your local representative. Everyone, including visitors, is welcome.

## Merry Christmas and Happy New Year to everyone!

See you in February

ar

## VK2

Tim Mills VK2ZTM.

### Clubs

The Orana Region ARC, based at Dubbo in the Central West, was one group which recently gained a WIA grant. It will use the grant to help link the region's repeaters into a network extending from Parkes through to Tamworth and taking in Dubbo, Orange and Coonabarabran. Some of the network is already used to carry the morning VK2WI news session. The expansion will help coverage during the bottom of the present cycle.

Mid South Coast ARC deferred the normal November meeting until a combined Christmas luncheon on the first Saturday in December. Will you be on the North Coast in mid January? Keep in mind that the Coffs Harbour and District ARC has its 2007 Field Day on Sunday 21st January at the St. John Church Hall, McLean Street. Further details are available from Gary VK2ZKT, at [radiosupply@bigpond.com](mailto:radiosupply@bigpond.com) or 02 6655 2990. The Hunter Radio Group in Newcastle, which provides a news bulletin on Monday night, will be in recess until the first Monday of February, the 5th. Its first meeting will be on Friday the 9th February. Then it will not be long until the Urunga Convention over Easter.

The Central Coast ARC, with its 2007 Field Day on Sunday 18th February, have an urgent message. It has received several inquiries regarding a rumour that clubs or individuals wishing to organise an exhibit at the event are required to pay a levy if they do not have Public Liability Insurance. The Club wishes to emphasise this rumour is totally incorrect. There is no levy imposed by the Central Coast Amateur Radio Club relating to public liability for Field Day exhibitors. "Check out its web site [www.ccarc.org.au](http://www.ccarc.org.au) for updates as the Field Day approaches," advised Col VK2ZCO, Chair of the CCARC FD committee in a news item to VK2WI News last month.

# WYONG

18 February, 2007

### Morse

I had a note the other day from Ross VK2ER who co-ordinates the VK2BWI Slow Morse panel on behalf of AR-NSW. Ross said: "Operators serving on the VK2BWI Slow Morse panel have, over the years, routinely sent weekly Morse practice sessions for long periods of times, to assist prospective amateurs in preparing for their examinations.

Many VK2BWI operators have served selflessly and with little publicity in this role for 20 to 30 years. There is no doubt that countless amateurs owe their past examination success, in part, to listening to the nightly on-air VK2BWI Morse practice broadcasts. Although the numbers of listeners and panel operators have diminished in past years, it is fitting that we pay tribute to an outstanding operator, Keith Manning VK2NZM, from Adamstown, NSW.

Keith, originally from ZL, sent a weekly slow Morse session on Wednesday evenings, for over 20 years. So skilled was Keith that could exactly sustain an appropriate speed using only a hand key. A very popular operator, Keith's text was invariably well formed and he had many regular callbacks.

We regret to say that Keith suffered a stroke in mid July. He has recovered well, but cannot continue VK2BWI sessions. He has returned to New Zealand, where his family resides. On behalf of your many listeners and friends, thank you Keith, for your years of loyal service to the amateur radio service in Australia."

With Keith's departure, Ross was the only operator, which he does on Thursday. Recently Allan VK2ADB, down in the Snowy region, has taken up the Tuesday evening slot. You can find them on 3550 kHz at 8 pm local. In the past there were interstate operators and VK5WI took over after the VK2BWI session.

There is still the opportunity for anyone in south east Australia to take up a slot, you don't have to be in VK2. If you are interested get in touch with Ross, or advise the AR-NSW office. Don't forget the VK2WI auto transmission on 3699 kHz.

### AR-NSW

On Saturday the 9th December, AR-NSW is scheduling an EGM to get the feeling on some amendments to the Constitution. Following the meeting they will have their Christmas party at the Ryde Eastwood Leagues Club. A recently planned club conference was not held. The AR-NSW office will close from 2pm Friday 15th December until 11am Tuesday 16th January.

The last T&T for the year was held on the last weekend in November. The first for 2007 will be late in January. The Dural-based events have become a good day out, with the T&T in the morning, a sausage sizzle by Brian VK2TOX for lunch and the Home Brew gathering in the afternoon. The evening Home Brew on the first Tuesday of the month continues to be held at McDonalds, North Parramatta.

Season's Greetings to all from Amateur Radio-New South Wales.

### Exams

The AR-NSW Foundation and exams sessions for 2007 are planned to be held on the last weekend of the even months, the first will be over February 24 / 25. When the 1000th Foundation licensee was reached recently, VK2 had produced 277. Between AR-NSW and HADARC, they had 170 of them. There were a further 20 with the Blue Mountains ARC and 20 with Summerland ARC. There are apparently still some regions of VK2, like the South Coast, where there are no exam and course facilities.

VK2WI News and the AR-NSW web site carry details of courses and exams conducted by Hornsby and District ARC, Waverley ARS, Central Coast ARC, Westlakes ARC, Oxley Region ARC, The Karuah Valley Radio Group, Hunter Radio Group, Tamworth ARC and Summerland ARC which you can find at [www.arnsw.org.au](http://www.arnsw.org.au).

Email contact with AR-NSW via [vk2wi@ozemail.com.au](mailto:vk2wi@ozemail.com.au) ; Postal: AR-NSW P.O. Box 9432, Harris Park, 2150.

# News from...

## VK2 continued

Telephone 02 9689 2417. FAX 02 9633 1525. Does your club or group conduct courses? Please advise the AR-NSW office.

## VK2WI

The bottom of the sunspot cycle is finding holes in the HF morning coverage. What a pity we don't have a general 5 MHz band. There is a gap between where 80 m is absorbed and

before the skip on 40 m comes to earth. We are most grateful to the relay stations that fill the gap via their local repeaters. The evening is being well served by the 80 metre transmitters. The 6 metre VK2RSY beacon, now on 50.289 MHz, made itself heard late October into ZL and northern VK4. First reports for some time.

VK2WI will make the last evening transmission for the year on Sunday the 17th December. The evening session will

resume on Sunday 21st January. There will be morning only transmissions on December 24th and 31st and January 7th and 14th. Season's Greetings – 73 – Tim VK2ZTM.

**Coffs Harbour Field Day**  
**Sunday 21 January 0830-1530**  
**St John's hall, McLean Street**  
**Coffs Harbour**

## Westlakes Field Day

Frank VK2FJL

**The well advertised and long awaited Westlakes Major Field Day, Sunday 12th November, is now but a memory. However for the vast majority who attended, well over 200, they will be very positive and pleasant memories.**

The day started for the dedicated few at 7.30 am with volunteers assisting in the food preparation and assembling the trestles, while coming to terms with the myriad sections of the canopy. We will be better educated in future. Barricades were set up along with the sign-in table. All was ready well before the 9 am opening.

The boot sales were rolling in, along with the pantech belonging to the Lemon Tree Passage Coast Guard, closely followed by the local WICEN caravan. Both of these organisations were soon set up ready to display and explain their systems to all those interested. The WICEN State Management Committee had arranged to hold their yearly meeting at Westlakes in the Library and this was underway by 10 am.

The Sales tables, as well as the boot sales, were well underway by that time, with a steady stream of successful buyers trekking from the tables to their vehicles to deposit the booty before returning to the fray. Andrews Communications, as promised, arrived early and Lee soon had a host of the latest radios and accessories on display and was inundated by potential buyers.

Our resident Chef, Alex VK2ZM, had the barbie smoking by that time, while Dianne sat ready to issue the bread rolls to the long line of hungry shoppers. The air was soon filled with the aromas of sizzling steaks, sausages and fried onion.

As advertised, a couple of 2 metre pedestrian Fox Hunts had been planned and we thank Brian VK2BI for arranging and supplying the foxes as well as several

sniffers. The response to this event was less than we would have liked, with only 5 taking part. However, those that did participate went at it with a vengeance. The final points went to Jessica VK2FJES, closely followed by Leyton VK2LI with Walter VK2FWAZ only a point behind.

The Badge prizes went to Col VK2YP and Richard VK2FRKO, while Allan VK2FLTP was successful in getting the closest to the number of Jelly Beans in the jar. The major Raffle, a signed picture of the Socceroos, went to VK2BAR, while Greg VK2CW took home the monster meat tray. Westlakes wishes to thank our sponsors for their generous donation of these prizes.

At midday, with the food petering out, Col VK2YP announced the commencement of the famous Westlakes Auction. The auction found the tables overloaded with a variety of preloved articles, ranging from hotplates, television sets, computer monitors along with both HF, VHF and UHF transmitters and everything in between. Col VK2YP, ably assisted by penciller Greg VK2CW and money man Ali VK2AFZ, soon had a frenzy of bidders clamouring for, and being knocked down, unbelievable bargains. Col, who claims it was his first attempt at auctioneering, managed for the first time in many Field Days to clear the table of goodies, an effort which deserves a big thank you.

Following the auction, with the crowd heading for home, those same dedicated few tackled the task of clearing the leftovers from the bargain tables,

dismantling the canopy and returning the trestles to the storage container in readiness for the next Westlakes ARC event.

As President I would like to thank all those who assisted in this exceptional day including those Amateurs and friends who came in their hundreds to make this yet another successful Westlakes Field Day.

## Silent key

### Terry Detlefsen VK2KTD

Several Westlakes members were among the family and friends who attended the cremation service at Ryhope for Terry VK2KTD Thursday 19th October 2006.

Terry passed a way suddenly at his home on Wednesday 11th October following a heart attack.

Radio was one of his real pleasures and anything associated with our hobby attracted Terry's interest. He took part in many of the clubs on air activities including RTTY and SSTV evenings, being a regular on the callbacks to our weekly broadcasts.

Westlakes was fortunate to have Terry as Secretary for several years; a position to which he gave his all, until ill health forced him to step down. This also meant that his attendance at the club also diminished.

Terry will be sadly missed.

Our sincere condolences to Michelle, Megan, Rebecca and Shayne.

Frank VK2FJL



# Westlakes Field Day



Andrews Communications booth



The auction



Preparing the food



Ready for the foxhunt



The Coast Guard van



The WICEN van

## VK5

### Adelaide Hills Amateur Radio Society

#### Test your Gear

The October meeting of AHARS was a "test your gear" night. Barry VK5ZBQ and several others brought along test equipment so members could see just what the rigs they were using, or the projects they had built up, were actually doing.

Jim VK5JST gave an interesting talk called "RF for Dummies" describing some of the problems you can encounter. He illustrated it with SWR meters, including the wooden boxed model he has designed for our "F" callers to build for themselves.

There were at least two visitors to this meeting. Brian VK5PBL who was there, in particular, to meet Trevor VK5ATW, whom he had met on the phone but not in person. Trevor was one of the amateurs who ran a JOTA station for Brian at Kidman Park for the Seahaven Sea Scouts.

We also had Norman M0CRM, in

Australia from Cumbria. When Norm was in VK5 several years ago, he presented AHARS with a plaque of the badge of the RSGB.

This time AHARS presented Norm with a copy of our Foundation Licence book. Norm had come to VK, in part, to encourage us to run Foundation courses, only to find that we are very active in that area.

Norm visited a number of clubs during his visit, and had seen the book before so, he was pleased to have a copy to show to the RSGB.

Norm also visited the Kidman Park JOTA station during the following weekend.

If you are visiting Adelaide next year, do come to one of our meetings: our speakers are many and varied and our members are friendly.

If you are interested in having a copy of any of the lectures we have run, most of them have been video taped.

For any one interested, we are prepared to copy these onto DVD for other smaller clubs who may not be able to attract the same speakers.

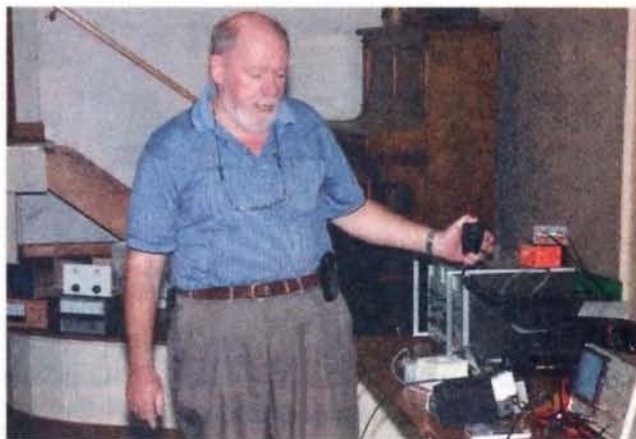

Jim VK5JST with some of the SWR bridges beside him



Phil VK5NN checking his radio's deviation with Greg VK5ZBD's test rig



Norm M0CRM being presented with the Foundation book by Christine VK5CTY



Barry VK5ZBQ with some of the test equipment he brought along

## VK5

### Old Timers' Luncheon In VK5

The Old Timers' Luncheon in VK5 is always held on the last Thursday of October. Over the years, the numbers attending have been falling to the extent that one begins to wonder whether it can continue. This year the tide turned. There were about 40 people present and everyone had an enjoyable time.

The news has been spread that the OTN is not restricted to those amateurs who have been licensed since the year dot. Instead, everyone who has held a licence for 25 years and/or is over 50 may join and attend the luncheons. Noticeably, more and more YLs are coming along, as they too find friends from other years to catch up with and generally because they enjoy themselves.

There was a theme to this year's luncheon. Members were asked to bring along old equipment to show to others. Several were of particular interest.

There was a 'spy set' in a suitcase. We all agreed that we would not have wished to carry the case for too long, as it really was heavy. But it really did look just like a 1940's suitcase.

There was a genuine crystal set with its piece of galena still in place. Some of the rigs brought along are still in use. "If it ain't broke, why mend (or replace) it?" Others were kept by historical radio buffs because they were old.

Jim VK5NB, the current President of the OTN in VK5, had made up a board with old QSL cards. Most of them



Some of the other interesting equipment on display



The Spy set in its suitcase



Darcy VK5RJ, licensed for 80 years

were originally sent out from or to old VK5 amateurs – this prompted some memories!, but a few were there because of their intrinsic interest. One from the station G5RV of antenna fame was especially noted.

We had two amateurs present who could be called old timers in their own right. One, Darcy VK5RJ, has had a licence for 80 years. The other, Frank

VK5LK, has had his for over 75 years. WOW!!

Both gentlemen are fit and well, and Frank is still teaching amateur radio and looking for students!

Darcy made a point of going over to speak to Jenny VK5FJAY when it was pointed out that she was the newest amateur in the room.

## VK7

Justin Giles-Clark, VK7TW

Email: vk7tw@wia.org.au Regional Web

Site: reast.asn.au

### Record Tumbles: VK7 – ZL

In mid-October, there was a large high pressure system in the Tasman that was producing exceptional VHF propagation to New Zealand. Rex VK7MO worked Nick ZL1IU, just north of Auckland, on both 2 metres and 70 cm using the digital mode JT65b for new VK terrestrial digital records of 2431 km on both bands. Congratulations Rex.

### Sewing Circle BBQ 2006

The VK7 Sewing Circle Net happens at 17:00 (local) on 3.589 MHz every day. Once a year the net participants, and many more, get together for the annual BBQ. This year it was in the REAST clubrooms on the Queen's Domain and saw over 50 people gather after the VK7 Regional News Broadcast for a day of amateur radio celebration and friendship. There was pre-loved equipment, fox hunts, homebrew competition, demonstrations of APRS, ATV, SSTV, repeaters, the unveiling of the VK7 Divisional Honour Roll and the Terry Wilson VK7HTW (SK) award to Ben VK7HAH. There was even a VK7 Advisory Committee meeting to finish the day off. Many eye-ball QSOs were established along with the renewal of many friendships. A great day was had by all!

Sewing Circle BBQ getting under way with those eyeball QSOs!



### N W Tasmanian Amateur Radio Interest Group

Congratulations to Stuart VK7FSDB for passing his Advanced examination. This is the first of what is hoped to be many assessments conducted in the North West.

NWTARIG have been trialling the automatic broadcasting of world wide amateur news services on IRLP Nodes 6124 (VK7RMD) and 6616 (VK7RNW) nightly at 7.30 pm from Club Station VK7NW. Automatic Voice Relay System (AVRS) is also being trialled on APRS-enabled repeaters in the North and NW. AVRS will allow any APRS mobile to establish a voice link to any other APRS station anywhere on the planet by simply knowing their call sign.

### Northern Tasmania Amateur Radio Club

October 11 was a mixed-BBQ night at the Mt Barrow Interpretation Centre. Forestry Interpretation Officer David Hamilton gave a most enlightening talk on the local eco-culture.

Thanks to Joe VK7JG and Brian VK7RR, the broadcast link on Barren Tier has been returned after correcting an overheating problem. Repeater VK7RIN is also operating to its full potential and repeater VK7RAB is now also back to full potential.

JOTA 2006 from Scout Island was another great success with 18 amateurs

providing a great amateur radio experience for Scouts and Guides throughout the weekend.

### Radio and Electronics Association of Southern Tasmania

The ATV experimenters' nights are attracting much interest and October 11 saw an on-air interview with the optical world record breaking duo of Chris Long VK3AML/7 and Mike Groth VK7MJ. This led to a trial of digital modes with the optical transceivers on the night of 15 October. Groups were on Mt Wellington and a hill behind Sorell, which is a distance of 29.8km. Starting with voice, we moved to SSTV and then to JT65A, both with some success. JOTA 2006 in the South saw two groups based at the Lea and Blackmans Bay, with 13 amateurs involved.

REAST's November presentation was given by Dave VK7DM and Ron VK7ZRO. Dave covered in detail the 160 m AM transmitter he has recently built and Ron covered the 1929 TRF amateur receiver he has recently restored. A demonstration between the two pieces of equipment completed the night. Thanks Dave & Ron.



Dave VK7DM demonstrating his 160 m AM Transmitter.

## VK3

### Amateur Radio Victoria News

Jim Linton VK3PC

Website: [www.amateurradio.com.au](http://www.amateurradio.com.au) Email: [arv@amateurradio.com.au](mailto:arv@amateurradio.com.au)

#### The year that was 2006

The year is coming to an end and it has been a highly successful one for Amateur Radio Victoria. A highlight was the AX3MCG and AX3GAMES special event activity for the Melbourne Commonwealth Games.

It showed what can be achieved with a team effort and enthusiasm. We are indebted to those who contributed to the success of this activity. More formal recognition of them can be expected at our annual general meeting in May 2007.

Another highlight was the International Lightship and Lighthouse Weekend from the Williamstown Lighthouse and Timeball Tower. It's hoped to be back there with VK3WI in August next year.

This time last year, the first Foundation Licence training courses and assessment sessions had just been held in Victoria. What a huge success it has been since that beginning and for the revival of amateur radio in Australia.

Returning to the field of education was Amateur Radio Victoria. The excitement surrounding the new three-tier licence structure resulted in the building of an effective education team with each member contributing to the ongoing success that has helped 100 candidates in a year. It has also provided hands-on experience for individual assessors who now run their own club-based licence assessment sessions.

Thank you to those radio amateurs who encouraged candidates to attend our training and assessments, and the even larger number who provided a welcome or, where appropriate, friendly guidance to our new radio amateurs.

The promotional campaign for amateur radio, mentioned in this column last month, has had further success. Continued efforts to achieve appropriate publicity for the hobby will continue in 2007. The results can be seen on the Media File page in the Member's Only section of our website.

The celebration of Amateur Radio Victoria's 95th birthday commenced on 30 November, the anniversary date for the foundation of the Amateur Wireless

Society of Victoria in 1911. It will be a year-long celebration so expect more details in coming months.

Changing from highlights to look at a negative aspect of 2006, you can't but feel for the situation of Ian Paul VK3FIOP who had his amateur radio activity all but taken away by BPL pollution.

Various media reports throughout the year had suggested that there could be several BPL trials in Victoria, but they all appear to be more of the familiar hype used to try and support the flawed technology. None have gone ahead to date.

However not announced publicly was a decision made in January 2006 to trial BPL in Mt Beauty in north-east Victoria. We are now witnessing, for the first time in VK3, the adverse impact BPL has on HF radio.

Amateur Radio Victoria continues to assist Ian VK3FIOP, in consultation with Owen Duffy VKIOD who provided his knowledge of the issues surrounding BPL, and Phil Wait VK2DKN the WIA BPL Coordinator.

#### Membership renewal reminder

If your biennial membership anniversary was July-December 2006, you will have been sent a renewal notice for the 2006-08 membership period.

Thank you to those who have already renewed their membership of Victoria's state-wide amateur radio organisation. Welcome also to the new members who have joined during 2006 and are enjoying particularly the e-member services, judging by the email comments being received.

Membership costs \$30 (\$25 pensioner) for two years and application forms are available from our website or on request.

#### Website improvements continue

The Amateur Radio Victoria website has migrated to a new web server. Our Internet Project Development Officer, Gary Furr VK3KKJ, has done an outstanding job with a minimum of disruptions to the availability of the website facilities.

The new server enables an enhancement of membership services, including improved e-consultation or polling of members.

Two new sections have been added: 'BPL watch VK3' which has audio files and the 'Media File' that displays the results of the current publicity campaign. There's even a zany music video – check it out!

#### Season's Greetings

A reminder that the office at 40g Victory Boulevard, Ashburton, will close on Tuesday 19 December and reopen Tuesday 6 February. During the break, urgent matters will be given priority while office-bearers work on financial statements and the annual audit.

On behalf of the Amateur Radio Victoria Council – Barry Robinson VK3JBR, Ross Pittard VK3FCE, Peter Mill VK3APO, Keith Proctor VK3FT, Terry Murphy VK3UP and myself, compliments of the season to all and best wishes for a Happy New Year.

### Eastern & Mountain District Radio Club White Elephant Sale

One of Melbourne's biggest and most popular hamfests, "The Eastern & Mountain District Radio Club White Elephant Sale" will be held on Sunday March 25th, 2007, in the Main Hall at The Great Ryrie Primary School, Great Ryrie St., Heathmont (Melway map 49 K11). Bookings for trading tables are now being taken; tables normally sell out early so we suggest you book your table quickly to avoid disappointment. Tables 6 foot long are available for \$17 each and 8 foot tables for \$20 each. To book yourself a table contact Colin Perger VK3FQL on 0414 879 682 or send an email to [wes2007@emdrc.com.au](mailto:wes2007@emdrc.com.au)

## Mars on a Shoe-string

Peter Ellis VK1KEP has put forward a proposal for a southern hemisphere ground station to support the AMSAT-DL (AMSAT Germany) P5A spacecraft mission to Mars. To this end he presented a seminar "The Dish - Mars on a Shoestring" at the University of Canberra on 13 October 2006.

In the seminar, Peter discussed how the University of Canberra's 10 m and 4.5 m dish antennas and other resources could be used to provide a high capacity ground communications station to support space operations for spacecraft intended

### The AMSAT group in Australia

The National Co-ordinator of AMSAT-VK is Graham Ratcliff VK5AGR. Contact Graham if you wish to be placed on a mailing list for breaking news and net reminders. As a forum for members AMSAT-VK operates two monthly nets.

### AMSAT-Australia Echolink Net

The "Echolink" net meets on the second Sunday of each month. Anyone with an interest in Amateur Radio Satellites is welcome to join the net. Graham VK5AGR acts as net controller. The net starts at 0500UTC during summer time periods and 0600UTC during winter standard time periods. Connect to the AMSAT conference server on Echolink a few minutes before these times.

### AMSAT-Australia HF net

The HF net meets informally on the second Sunday of each month. In winter (end of March until the end of October) the net meets on 3.685 MHz at 1000 UTC. In summer (end of October until end of March) the net meets on 7.068 MHz at 0900 UTC. Start listening 15 minutes before these times.

All communication regarding AMSAT-Australia matters can be addressed to:

AMSAT-VK,  
9 Homer Rd,  
Clarence Park, SA. 5034

Graham's e-mail address is:  
vk5agr@amsat.org

to support education and science, for relatively little cost.

As part of the presentation, he proposed a project time line based on the P5A spacecraft mission to Mars in 2009, and a range of undergraduate and graduate research topics to begin and continue the project, e.g. signal processing by computer, and data warehousing and dissemination. Peter also canvassed current and future Australian and international space research employment for graduates with experience in space research, not just from an Information Sciences and Engineering background, that the University of Canberra project would bring. He discussed the prospects for industry and community involvement, cooperation with other universities and organisations, and grant funding.

Peter explained how a range of AMSAT spacecraft has been supporting education in communication and spacecraft operation for over 30 years, with over 20 currently operational, and some 10 more slated for launch over the next 5 years, including P5A to Mars. See Peter's web site [www.pcug.org.au/~prellis/p5a/](http://www.pcug.org.au/~prellis/p5a/) for links to other papers on P5A and this proposal.

I urge you to follow the progress of this project. If Peter's initiative is successful we could well have a facility here in Australia of the type that spawned the developments in the 1970/80s at Surrey University in England.

Peter recently completed a Masters degree in project management at UNSW-ADFA. His work included studies in facilities management, information systems and satellite communication.

### Interesting development in multi-band dish feeds

To date most attempts at producing viable multi-band dish feeds for U/V/S bands have followed the "patch" principle. These work well and generally don't suffer too much from de-sensing, or can be easily tamed. The helix is probably

the simplest form of dish feed antenna at low microwave frequencies and although many are in use, attempts to build viable multi-band versions have usually met with failure. Charlie G3WDG has designed a dual, concentric helix feed and microstrip filters which reportedly reduce the associated de-sensing to very low levels. Details are on his website:

<http://www.g3wdg.free-online.co.uk/dual.htm>

Even if you prefer the patch antenna or some other multi-band system, the notch filters described on the web site could be useful. The articles deal with practical construction and hint that the filters may soon be available in kit form. If you are putting together a station for the forthcoming high orbiters, you would do well to look at the information on this site.

### Oscar-11 won't go away!

Despite many reports indicating the final demise of this old timer it seems it is back in operation.

It was first heard to reappear by Peter ZL3TC in October, after a silence since August 26. Clive G3CWV is still regularly reporting on the condition of UO-11 and his web site [www.users.zetnet.co.uk/clivew/](http://www.users.zetnet.co.uk/clivew/) can be relied on to contain the latest information.

The satellite is a mere shadow of its former self, of course, after more than two decades in space. Many of the groundbreaking features it once supported have succumbed to the ravages of space and time. Clive's web site lists the features still giving meaningful information. Indications are that it will be in more or less continuous daylight throughout the remainder of this year and into 2007.

The batteries will now not support operation during even short eclipse periods. The watchdog timer now operates on a 20 day cycle. The ON/OFF times have tended to be very consistent. The average of many observations shows this to be 20.7 days, i.e. 10.3 days ON

# Beyond our shores

David A. Pilley VK2AYD

serving approximately 150,000 members. Membership costs approximately A\$82 a year.

## Canada

The Radio Amateurs of Canada (RAC) is quite new in years being formed in 1993; however its history goes back to 1920 when the ARRL formed a Canadian Division which held up until 1979, when the Canadian Relay League (CRRL) was formed. Just prior to this in 1967, a new society called the Canadian Amateur Radio Federation (CARF) was formed. The CRRL and CARF were amalgamated in 1993. The journal of the RAC is "THE CANADIAN AMATEUR" which is successfully written in both English and French languages. International membership costs approximately A\$70 a year.

## Japan

Amateur Radio was somewhat slow arriving in Japan. Unlicensed hams started their experimenting around 1925. In 1926, 37 Radio Amateurs inaugurated The Japan Amateur Radio League and in 1927 ten private experimental radio telegraphy/telephony stations were licensed by the government. By the outbreak of WW II, there were about 300 stations on air; however when hostilities commenced in 1941, all equipment was impounded. It was 1952 before 30 stations were licensed and by 1994 Japan had nearly 1.4 million Radio Amateurs. The journal of JARL is the "JARL NEWS" which is published quarterly and was first issued in 1929.

## New Zealand

The New Zealand Association of Radio Transmitters (NZART) got its start in 1926. It has been well supported by the Amateur Radio community and has a long history of innovation and development in the field of wireless. NZART publishes its journal "BREAK-IN" bi-monthly, as well as a comprehensive call-sign address book every year. Membership costs approximately A\$85 a year (but if you want "Break In" sent by airmail, the cost is about A\$98 a year).

Thanks to QST for most of the information. Back to normal next month!

This month I am writing the column literally 'Beyond Our Shores' - off the coast of Aruba, with very limited Amateur Radio and computer facilities available. Consequently I'm not up to speed on recent happenings in the world of our wonderful hobby, so this month I'll just give a review of a few of the major radio societies around the world. Remembering that our own WIA is the oldest Amateur Radio Society in the world, formed in 1910 (time to plan for a big centennial celebration?).

In 1846, an Englishman named James Maxwell pioneered the theoretical verification of radio waves. 42 years later a German, Heinrich Hertz, demonstrated the presence of radio waves. However, the seed for Amateur Radio was not planted until the 1890's when Guglielmo Marconi began his experiments in wireless telegraphy. He was soon joined by hundreds of others who were enthusiastic about sending messages by wireless.

## U.K.

The Radio Society of Great Britain (RSGB) followed closely on the heels of the WIA and was formed in 1913. With the changes in communication systems and Amateur Radio on the decline, the RSGB pioneered the Foundation Licence that reinvigorated Amateur Radio in Great Britain. This has been the blue print for many other Societies around the world, including our own. Their monthly journal has changed names over the years and today is known as "RadCom". Membership costs approx A\$110 a year.

## U.S.A.

The Amateur Radio Relay League (ARRL) was proposed by Hiram Percy Maxim in 1914. The purpose was to relay messages further using wireless instead of land line. By September 1914, there were some 237 relay stations appointed. The interest in Amateur Radio grew and by 1916 there were 6,000 Amateur Licences issued. The League's emphasis was on the word relay and the general public loved the idea of coast to coast free messages. About this time, the League started to produce a journal called "QST" which today is still one of the most widely read Amateur Radio magazines around the world. ARRL headquarters are at Hartford CT with a staff of 120 people

followed by 10.4 days OFF. However, poor solar attitude may result in a low 14 volt line supply, which could cause the beacon to switch OFF prematurely, and reset the watchdog timer cycle. When this occurs, the beacon is OFF for 20.7 days.

If satellite telemetry excites your imagination, here is a ready made project. Clive is appealing for meaningful, detailed information on UO-11's status and for telemetry recordings from amateurs around the world. He is compiling a compendium of what may be the last days of this beloved old timer. The behaviour of the watchdog timer is of particular interest in trying to predict the reappearance of the satellite after any period of inactivity.

## Keeping up to date.

To say that the satellite scene is dynamic is an understatement and that is part of its attraction. No matter where your interest lies, or which group of satellites grabs you, keeping up to date is paramount.

The updating of Keplerian elements is a problem that's been with us since the earliest phase-1 birds and its importance is self evident.

Many newcomers may be perplexed when confronted with keeping up to date with latest developments, future plans, changes to operating schedules, periodic mode switching, progress of new projects etc. The internet has been a great boon to satellite operators and good, reliable information is available now at the press of a button - if you know which button to press! AMSAT-NA provides "mailing lists" as part of their free service to all satellite operators world wide. Currently, AMSAT-NA supports the following (free) mailing lists:

- \* AMSAT News Service (ANS)
- \* General satellite discussion (AMSAT-BB)
- \* Orbit data (KEPS)
- \* Manned space missions (SAREX)
- \* AMSAT Educational Liaison mailing list (AMSAT-EDU)
- \* AMSAT K-12 Educational Liaison mailing list (AMSAT-K12)

There are more but they are area specific in the USA. A daily digest version is available for each list. To subscribe, or for more list information, visit the following URL: <http://www.amsat.org/amsat/listserv/menu.html> The AMSAT-BB and ANS would be good starting points for newcomers.

ar

ar

# Gridsquare Standings at 3 November 2006

Guy VK2KU

## 144 MHz Terrestrial

VK2FLR	Mike	113
VK3NX	Charlie	104
VK2KU	Guy	102
VK3KAI	Peter	81
VK2ZAB	Gordon	78 SSB
VK2KU	Guy	69 SSB
VK3HZ	David	69
VK3CY	Des	68
VK3PY	Chas	68 SSB
VK2DVZ	Ross	63 SSB
VK2TK	John	62
VK3EK	Rob	62 SSB
VK3QM	David	56 SSB
VK2EI	Neil	54
VK7MO	Rex	54
VK3BJM	Barry	53 SSB
VK3TMP	Max	53
VK3BDL	Mike	51 SSB
VK3ZLS	Les	51 SSB
VK3KAI	Peter	48 SSB
VK2DXE	Alan	47
VK2KU	Guy	47 Digi
VK3WRE	Ralph	46 SSB
VK4TZL	Glenn	45
VK2DXE	Alan	43 SSB
VK3CAT	Tony	40
VK7MO	Rex	37 Digi
VK3KAI	Peter	36 Digi
VK4CDI	Phil	36
VK2TK	John	35 SSB
VK4KZR	Rod	35
VK3ZUX	Denis	33 SSB
VK6HK	Don	33
VK7MO	Rex	33 SSB
VK5UBC	Brian	32
VK3ZYC	Jim	31
VK2KRR	Leigh	28 FM
VK3CJ	Chris	28 SSB
VK4CDI	Phil	28 SSB
VK2KOL	Colin	27 SSB
VK2TK	John	27 Digi
VK2EAH	Andy	26
VK4DFE	Chris	26 SSB
VK5ACY	Bill	26 SSB
VK2TG	Bob	25 SSB
VK3BBB	Brian	25
VK1WJ	Waldis	24
ZL3TY	Bob	24
VK3DMW	Ken	23
VK3YB	Phil	23
VK4EME	Allan	23
VK3HV	George	21 SSB
VK3TLW	Mark	20 SSB
VK3VHF	Rhett	20 SSB
VK6KZ	Wally	20
VK1WJ	Waldis	18 Digi
VK3AL	Alan	18 SSB
VK3BG	Ed	17 SSB
VK4EME	Allan	16 Digi
VK6KZ/p	Wally	16
VK2EAH	Andy	15 SSB
VK3ZYC	Jim	14 SSB
VK3UDX	Geoff	13 SSB
VK2CZ	David	12
VK7ZSJ	Steve	12
VK2EAH	Andy	11 Digi
VK2EI	Neil	11 Digi
VK3VHF	Rhett	11 Digi
VK2DXE/p	Alan	10
VK3ANP	David	10
VK4CDI	Phil	10 Digi
VK4TJ	John	10 SSB
VK4EME	Allan	9 SSB
VK6DXI	Mirek	6
VK6HK	Don	6 Digi
VK1WJ	Waldis	5 SSB
VK2TWO	Andrew	5
VK3ZDR	David	5 SSB
VK1WJ	Waldis	3 CW
VK2DXE	Alan	3 Digi
VK3QM	David	1 Digi

## 144 MHz EME

VK2KU	Guy	219
ZL3TY	Bob	208
VK2KU	Guy	202 Digi
VK7MO	Rex	154 Digi
VK2FLR	Mike	120
VK3AXH	Ian	89 Digi
VK3CY	Des	70 CW
VK2AWD	Dave	52 Digi
VK2KU	Guy	39 CW
VK4CDI	Phil	34 Digi
VK2KRR	Leigh	30
VK3HZ	David	14
VK3NX	Charlie	5
VK3VHF	Rhett	4
VK4EME	Allan	4 Digi
VK2DVZ	Ross	2
VK2DXE	Alan	2
VK3AXH	Ian	2 CW
VK3AXH	Ian	1 SSB

## 432 MHz Terrestrial

VK2ZAB	Gordon	57 SSB
VK3PY	Chas	50 SSB
VK3NX	Charlie	48
VK3QM	David	47 SSB
VK3ZLS	Les	40 SSB
VK2KU	Guy	38
VK2KU	Guy	34 SSB
VK3EK	Rob	34 SSB
VK3HZ	David	34
VK2DVZ	Ross	32 SSB
VK3BJM	Barry	32 SSB
VK3CY	Des	32
VK3KAI	Peter	29
VK3KAI	Peter	28 SSB
VK3BDL	Mike	27 SSB
VK3WRE	Ralph	26 SSB
VK3TMP	Max	25
VK2TK	John	18
VK5UBC	Brian	18
VK7MO	Rex	18
VK2TK	John	17 SSB
VK3CAT	Tony	16
VK3ZUX	Denis	15 SSB
VK3BG	Ed	14 SSB
VK4KZR	Rod	14
VK3TLW	Mark	13 SSB
VK4TZL	Glenn	13
VK6KZ	Wally	13
VK2KRR	Leigh	11 FM
VK3UDX	Geoff	11 SSB
VK3AL	Alan	10 SSB
VK3ANP	David	10
VK3YB	Phil	10
VK4CDI	Phil	10
VK4CDI	Phil	10 SSB
VK2TG	Bob	9 SSB
VK3BBB	Brian	9
VK4DFE	Chris	9 SSB
VK3CJ	Chris	8 SSB
VK3VHF	Rhett	8 SSB
VK6KZ/p	Wally	8
VK2KOL	Colin	7 SSB
VK2FLR	Mike	6
VK6DXI	Mirek	6
VK7MO	Rex	6 Digi
VK2KU	Guy	5 Digi
VK3HV	George	5 SSB
VK4TJ	John	5 SSB
VK3KAI	Peter	4 Digi
VK3PY	Chas	4 Digi
VK3QM	David	4 Digi
VK3ZYC	Jim	4 SSB
VK4EME	Allan	4 SSB
VK1WJ	Waldis	3 SSB
VK2CZ	David	3
VK2TWO	Andrew	3
VK2DXE/p	Alan	2
VK3DMW	Ken	2
VK2TK	John	1 Digi
VK3VHF	Rhett	1 Digi
VK4CDI	Phil	1 Digi

## 432 MHz EME

VK4KAZ	Allan	14 CW
VK7MO	Rex	10
VK7MO	Rex	9 Digi
VK2SN	Sean	6 Digi
VK4CDI	Phil	6 Digi
VK3NX	Charlie	5
VK3HZ	David	4
VK2KRR	Leigh	1
VK3AXH	Ian	1 Digi

## 1296 MHz Terrestrial

VK3PY	Chas	37 SSB
VK3QM	David	37 SSB
VK3NX	Charlie	35
VK2ZAB	Gordon	29 SSB
VK3ZLS	Les	26 SSB
VK2KU	Guy	25
VK2KU	Guy	22 SSB
VK3EK	Rob	20 SSB
VK3KAI	Peter	20
VK3KAI	Peter	19 SSB
VK3KWA	John	19
VK2DVZ	Ross	17 SSB
VK3WRE	Ralph	16 SSB
VK3BDL	Barry	12 SSB
VK3BJM	Barry	12 SSB
VK3HZ	David	11
VK3TMP	Max	11
VK2TK	John	10 SSB
VK4KZR	Rod	10
VK7MO	Rex	10
VK3BG	Ed	8 SSB
VK3TLW	Mark	8 SSB
VK3AL	Alan	7 SSB
VK3UDX	Geoff	6 SSB
VK4TZL	Glenn	6
VK2CZ	David	5
VK3HV	George	5 SSB
VK3ZUX	Denis	5 SSB
VK3ZYC	Jim	5
VK6KZ/p	Wally	5
VK2KRR	Leigh	4
VK3BVP	Shane	4
VK3VHF	Rhett	4 SSB
VK3YB	Phil	4
VK3ZYC	Jim	4 SSB
VK4CDI	Phil	4
VK6KZ	Wally	4
VK2KU	Guy	3 Digi
VK3BBB	Brian	3
VK4CDI	Phil	3 SSB
VK6DXI	Mirek	3
VK2DXE/p	Alan	2
VK2FLR	Mike	2
VK3CJ	Chris	2 SSB
VK3CY	Des	2
VK3KAI	Peter	2 Digi
VK3QM	David	2 Digi
VK4TJ	John	2 SSB
VK3DMW	Ken	1
VK3ZYC	Jim	1 Digi
VK4CDI	Phil	1 Digi
VK5UBC	Brian	1
VK7MO	Rex	1 Digi

## 1296 MHz EME

VK7MO	Rex	18
VK7MO	Rex	16 Digi

## 2.4 GHz

VK3PY	Chas	14 SSB
VK3QM	David	14 SSB

VK3NX	Charlie	11
VK3WRE	Ralph	9 SSB
VK3KAI	Peter	7 SSB
VK3EK	Rob	5 SSB
VK3HV	George	4 SSB
VK3HZ	David	4
VK6KZ	Wally	4
VK3BJM	Barry	3 SSB
VK3KAI	Peter	2 Digi
VK3VHF	Rhett	2 SSB
VK4KZR	Rod	2
VK2DVZ	Ross	1 SSB
VK3BG	Ed	1 SSB
VK3TLW	Mark	1 SSB
VK3ZUX	Denis	1 SSB
VK4TZL	Glenn	1

## 3.4 GHz

VK3NX	Charlie	11
VK3QM	David	9 SSB
VK3KAI	Peter	6 SSB
VK3WRE	Ralph	6 SSB
VK3HV	George	4 SSB
VK6KZ	Wally	4
VK3EK	Rob	3 SSB

## 5.7 GHz Terrestrial

VK3NX	Charlie	12
VK3WRE	Ralph	9 SSB
VK3QM	David	8 SSB
VK3KAI	Peter	7 SSB
VK6KZ	Wally	4
VK3BJM	Barry	2 SSB
VK3EK	Rob	2
VK3HV	George	2 SSB
VK3KAI	Peter	2 Digi
VK6BHT	Neil	2 SSB
VK3ZUX	Denis	1 SSB

## 5.7 GHz EME

VK3NX	Charlie	7
-------	---------	---

## 10 GHz

VK3NX	Charlie	11
VK3QM	David	11 SSB
VK3KAI	Peter	9 SSB
VK3PY	Chas	9 SSB
VK6BHT	Neil	9 SSB
VK3WRE	Ralph	8 SSB
VK3EK	Rob	5 SSB
VK6KZ	Wally	5
VK3HV	George	4 SSB
VK3HZ	David	4
VK3TLW	Mark	3 SSB
VK3ZYC	Jim	3 SSB
VK5ACY	Bill	3 SSB
VK2EI	Neil	2 SSB
VK3BJM	Barry	2 SSB
VK3DMW	Ken	2
VK3ZUX	Denis	2 SSB
VK7MO	Rex	2
VK3BG	Ed	1 SSB
VK4KZR	Rod	1
VK4TZL	Glenn	1

## 24 GHz

VK6BHT	Neil	3 SSB
VK2EI	Neil	2 SSB
VK3NX	Charlie	2
VK6KZ	Wally	2

## 474 THz

VK3CJ	Chris	3
VK3HZ	David	2
VK7MO	Rex	2

Additions, updates and requests for the guidelines to Guy VK2KU, vk2ku@clearmail.com.au, or by mail (QTHR 2005).

The guidelines (and the latest League Table) are also available on the website of the NSW VHF Dx Group at www.vhfdx.radiocorner.net - click on Gridsquares.

Next update of this table will be early February 2007.

Stations who do not confirm their status for more than 12 months may be dropped from the table.



# VK7 Divisional Honour Roll unveiled

Justin Giles-Clark VK7TW.

On November 5, 2006, at the annual VK7 Sewing Circle BBQ, the completed VK7 Divisional Honour Roll was unveiled by the Chairperson of the WIA VK7 Advisory Committee, Phil Corby VK7ZAX. This Roll covers the main office holders from 16 November 1925 up until 8 December 2004, when the Division was unincorporated.

I include below a transcript of the speech that Phil made on the day.

I suppose that one of the final steps after the passing on of life is a memorial, and what I will humbly do today is unveil a memorial to the former Wireless Institute of Australia Tasmanian Division in the form of a record of its main officers. Although formed in 1923, it was incorporated in 1925 and its effective representation of Tasmanian amateurs started then. Before the formal unveiling, I would like to make a few remarks chiefly

from my perspective as the last VK7 Federal Councillor:

The moves toward a National WIA had been gaining momentum a few years before 2004, but the dedication and energy of the late Chris Jones VK2ZDD and his supporters, the return of our highly respected President Michael Owen VK3KI to Federal Institute affairs, and the dedication of many amateurs including David Wardlaw VK3ADW, Ernest Hocking VK1LK and the late Peter Naish VK2BPN saw the decisions in Brisbane in April 2004 leading to our National WIA.

I must admit I had some reservations about the demise of our Division, as it had served VK7 amateurs well over its lifetime. However I need not have been concerned.

So saying, we must compliment most highly the Presidents, officers and founding members of the 3 radio clubs

which have replaced the Branches. Each club has decided for itself the structure and rules appropriate to it, its meeting times and activities, and the growth in membership in 2 years is something for each to be proud of. Each has continued to maintain and improve the repeater systems within its zone, as well as successfully implementing education and assessment of new licensees with the introduction of the Foundation licence and revised licensing system.

After the downturn in the last decade or so of active licensees, I think we must have now turned up from the bottom of the curve, although we cannot afford to become complacent. So saying, the stewardship of amateur radio in Tasmania has passed into capable hands, and the many distinguished old-timers listed on this honour roll should feel most satisfied with their successors, although a few may have been reluctant to admit it.



The completed WIA VK7 Division Honour Roll hanging in the REAST Inc. clubrooms.

# Old Timers in wild QSO Party!

## Club Station makes 36 contacts

Headlines like these would probably not raise much interest if they appeared in a daily newspaper. Will they do so here? Well, we hope so – at least they bring some information about happenings in the AR hobby.

The cause of the above headlines was the QSO Party held on October 21, 2006, by the Radio Amateurs' Old Timers' Club Inc. (RAOTC) to mark the occasion of the Club's 30th birthday which occurred in March.

All active amateurs were invited to take part and many of you took that opportunity. On behalf of RAOTC, thank you most sincerely.

At the time of writing this note, not all details of contacts have been received; however, in Melbourne there was activity on VHF FM, although HF was the popular medium. 20 metres was noisy with a few VK6 contacts. 40 metres was "the one", with both CW and SSB in play. Club station VK30TN worked 36 contacts.

The Club also gives a sincere thank you to Ron Fisher VK3OM, Drew Diamond VK3XU, Ron Cook VK3AFW, Derek McNeil VK3XY and Dennis Muldownie VK6KAD for operating Club Stations VK30TN and VK60TN.

A complete report on the QSO Party will appear in the RAOTC magazine "OTN" next March and on a weekly broadcast early in the New Year.

Who are the Old Timers anyway? A good question, as the popular conception is of someone of very senior years

sitting over old boxes of equipment and wondering why today's young people don't do it that way any more.

A more accurate description of an "Old Timer" is one who is experienced in the radio field, irrespective of age or area of radio communications. The term is an old one which originally carried this latter meaning; therefore an old timer could be anyone who has worked consistently in a radio field for a number of years and has become very proficient. He/she need only be 18 years old if he started at 15 with a real "flair" for the hobby. In other words,

age has nothing to do with it.

Certainly, our Club rules do say that one must be licensed, or qualified to hold a licence, for 25 years; but Associate Membership is open to those in a similar position after ten years. Perhaps this makes you eligible? If so, why not have a look at our web site-- raotc.org.au . You may be pleasantly surprised and certainly would be most welcome as a member.

Again thanks to all who supported us. Happy Christmas and 2007.

Ian Godsil VK3JS,  
Secretary, RAOTC Inc.

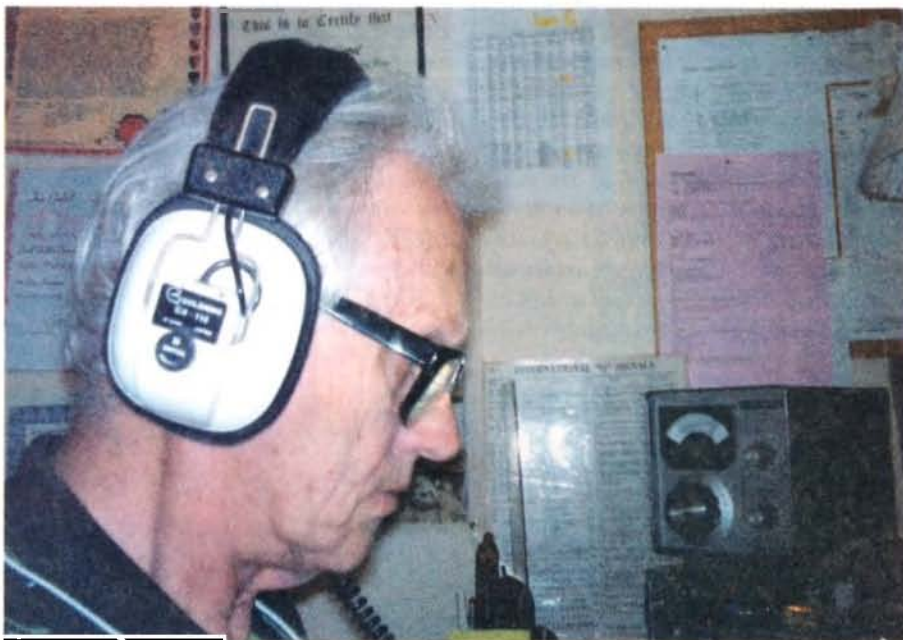

Ian VK3JS operating VK30TN in QSO Party

## VK7 Honour Roll continued

So many of those listed have passed on, but I will mention a few. Phil Fysh VK7PF, who attended the first National Convention in Perth WA in 1925, and on his return convinced Tasmanian amateurs of the need for greater participation in Institute affairs, leading to incorporation of the Division in 1925. The first President, A. Harold Masters, architect, and lecturer in Electrical Engineering at Launceston Tech, is credited with being the first person in Tasmania to demonstrate communication by Wireless Telegraphy. "Pop" Medhurst VK7AH with Mr. Hallam successfully communicated with a visiting warship over distances of up to

60 miles in July 1901. Institute patrons have been "Pop" Medhurst and Len Crooks VK7BQ, described at the time of the Tasmanian Golden Jubilee in 1973 as the "Grand old man of radio".

Tom Allen VK7AL was our longest serving President and H. M. (Chummy) Moorhouse was secretary from 1933 to 1945. Outstanding service to the Division has been recognized by the award of life membership to those so recorded on the roll.

Although the terms of office of some as listed are short, all have contributed to the continuance of the Division as the representative organization for radio

amateurs in Tasmania. We must not forget those many amateurs who have served as Councillors, and our ex-officio officers carrying out many essential tasks, often for many years, which had enabled the Division to support amateurs and their activities for so many years and provide services. We must not forget the ordinary members who may not have taken office, but by their membership and being there maintained the Division.

Thanks to Phil Corby VK7ZAX for sharing his speech. The Honour Roll can be viewed online at:  
<http://reast.asn.au/wiaVK7honourroll.php>

# Contests

Phil Smeaton VK2BAA

## Contest Calendar for December 2006 – February 2008

Dec.	2	RTTY Melee	
	9/10	ARRL 10 Metres Contest	(CW/SSB)
	16	OK DX RTTY Contest	
	26 (to 15 Jan 07)	Ross Hull Memorial Contest (VHF/UHF)	(CW, SSB, FM)
	30/31	'Original' QRP Contest	(CW)
Jan	6/7	ARRL RTTY Roundup	
	14/15	Summer VHF/UHF Field Day	(CW, SSB, FM)
	20/21	BARTG RTTY Sprint	
	27/28	REF Contest	(CW)
	27/28	UBA DX Contest	(SSB)
Feb	10	CQ/RJ WW RTTY WPX	
	17	ARRL INTERNATIONAL DX CONTEST	(CW)
	24/25	REF Contest	(SSB)
	24/25	UBA DX Contest	(CW)

## Season's felicitations to one and all!

### CQ all Contest Managers

Could I ask all VK contest managers to get in contact please, if you haven't already done so? It would be good for me to get up to speed and to enable a smooth exchange of information for inclusion in this column. My email address is vk2baa@wia.org.au . Thanks.

### CW receiving prowess – Go Forth and Practice

As I mentioned last month, your humble scribe participated a while ago in a DXpedition to Norfolk Island as part of the VI9NI team. Operation on the island coincided with the CQWPX CW Contest and we were in much demand on the bands. Being on the receiving end of a sizeable pile-up is sometimes quite a shock to the system when a significant number of stations are calling you simultaneously. High quality receiver

filtering and DSP within the rig no doubt helps greatly, but the ultimate recipient (the operator) is still required to decipher the remaining cacophony into intelligible information.

I've operated from the sticky end of a pile-up on a number of occasions previously, but the VI9NI experience showed me that I have a way to improve to enable me to maximise the success rate in picking-out a call and then completing the QSO with the highest level of accuracy and speed. So the question arises, how can one improve in a 'controllable' manner?

Of course, valuable experience can be gained on the bands under battle conditions during a contest but this is not such a controllable approach and can often result in an operator's perceived confidence becoming eroded instead of bolstered at this end of the personal learning curve. What's needed is a method of being able to control the number of stations calling so as to gradually build-up skills.

# OzGear

www.OzGear.com.au

RadioCommunications & Electronics  
Ozhelph Services Pty Ltd T/as Ozgear

Suppliers of radiocommunications,  
electronics and computer products  
and electronic test equipment

Ph 07 3114 2506

sales@ozgear.com.au

Brisbane QLD

Manager: Doug Hunter VK4ADC

**WE HAVE MOVED!**

**Unit 2**

**139 Beenleigh Rd  
Acacia Ridge 4110**

*Ozgear Yagi antennas  
for 6m, 2m and 70cm  
now available*

**ICOM &  
YAESU**

*Australian-sourced radios with  
Australian-based manufacturer  
warranties*

Authorised Aust Icom and Yaesu dealer

Antenna, cable, interface, tuner and  
general accessory products from...

Amidon, Andrews USA, Austek,  
Benelec, Bushcomm, Comet, Dalwa,  
Diamond, Garland, GeoSensory, GME,  
Icom, Kingray, LDG, Lutron, Mobile  
One, RFI, Sangean SSGC, TET-Emtron,  
Tigertronics, Yaesu, ZCG Scalar plus  
ARRL and RSGB publications

# ALTRONICS

Many products stocked

*Product & pricing info?*

Phone, email or visit us on the web at

**www.OzGear.com.au**

for the latest info plus on-line ordering. Our latest  
price list can be downloaded at any time

Payment?



All is not lost however, as your PC can come to the rescue. Consider this scenario: a practice environment that is lifelike towards on-air contesting but also allows the user to add or remove elements of 'reality' according to their requirements.

Without a controllable Faraday cage of some description surrounding the shack and antennae, this is likely to be difficult to achieve when on the air. However, with seasonal festivities approaching, many more astute contesters have been dropping hints as to their requirements from Santa for a number of months. Requests for a higher sunspot count or some decent propagation on 10 m might be difficult for the old chap to deliver, but other items are possible for Santa to empty his sack and provide - such as CW software packages and best of all - they're free!

By way of an example of such software, have a look at <http://www.dxatlas.com/MorseRunner/> and download a copy of Morse Runner. Morse Runner is a highly adaptable piece of software that simulates 'real life' contest conditions but allows you to add or remove factors such as QRN and QRM.

Another equally splendid piece of software can be found at <http://www.sk3bg.se/contest/sofrufz.htm>. RUFZ is also a CW contest simulation facility that additionally allows the user to compete 'off line' with others by submitting an entry of your results to the website 'Toplist'. The list allows the submission of photos of operators too, but this might not be to everyone's liking! However, take a look at the range of ages of submitted competitors - who says that ham radio contesting is an old bloke's game?! The beauty of this approach is that you can practice CW contesting without the 'usual' hardware of a radio or antennae, without an actual contest, whilst located on a plane, bus, aircraft (unless you're driving/flying it!), in fact wherever you're safely able to.

Another version of RUFZ for use with Windows XP, 2000, NT etc is available too, at <http://www.rufzxp.net/>.

If you download a copy of any of these packages and give it a go I'd be delighted to know how you got on. Maybe there are some other software packages that I'm not aware of? With my antenna restrictions, the software might have more stations to 'work' than I get on air at home!

## Rules and Logs

It is said that familiarity breeds contempt. Many contests receive a periodic tweak to the rules whilst other contests go from year to year without any modifications at all. Most people prefer the latter approach if at all possible but, occasionally, one can run foul of not reading the rules properly.

It's an easy trap to not read the rules and digest them fully for a given contest that you've been participating in for quite a while. For instance, to put effort and time into a contest only to find that the emailed log submission gets rejected by the organisers 'robot' due to a seemingly minor formatting hiccup is annoying to say the least.

But worse still is to be docked a number of points or multipliers due to transgressing a rule that should've been heeded during the contest - exceeding the number of band changes permitted within a given period is often a cause of this type of error.

Contest organisers want you to enter their contest and submit a log. The adjudication process can often be lengthy and it must be as accurate as possible so as to be a meaningful exercise.

To try and speed matters up somewhat, adjudicators often stipulate a particular log format (Cabrillo for instance) for the submission - they're not trying to catch you out and they're not doing it to be awkward.

Adjudicators will often have a given process for efficiently and accurately sorting the vast amount of data received from contest entrants and we can help them in their voluntary task by ensuring that we send them what they want.

If the adjudicator has to modify our log to make it fit into their system, then additional time and effort is needed. Imagine trying to do this for every log received for the CQWW series of contests - possibly thousands of logs at a time - a colossal task.

## Check for Errors

Simple errors often include not specifying the correct category of entry - are you entering the QRP, low power or high power section? Have you included all serial numbers, reports and other exchange information for each QSO? Using a PC is a good way to ensure that life is made easier for both the contester and the adjudicator, as data is entered into the software package in 'real time' during the contest. This can ease matters, but can cause trouble if the software has not been set up correctly prior to the contest!

Make sure that the correct software and possibly the latest version of the software is being used for the relevant contest that you'd like to enter - not all software caters for all contests as each software package often provides for a select range of contests only. Some of the latest versions of software can often contain a bug or two, so be careful!

A simple double check of the log prior to sending will avoid most hiccups. Many adjudicators may email a query to you if you have stated an email address, to allow you to make some alterations to your stated entry classification (if you used Cluster Spotting facilities but mistakenly claimed to be Single Operator as an example), but adjudicators are not obliged to do so and such activities consume quite an amount of time.

If, in the end, the effort required exceeds the time available, then just enter a check log to the adjudicator so that he can use the information for log checking if required, but this also gives an indication to the contest manager of the level of activity for that particular contest.

Some contest organisers have facilities that automatically 'vet' emailed logs as they are submitted, by examining contained data for compliance as some required information might be missing. These mechanisms are often called 'robots' but they consist of hardware/software that checks a given piece of received emailed data against a pre-ordained selection criteria for compliance.

## Results NZ Memorial Contest 2006

From Mrs. Win. Gilbert ZL2GI

VK STATIONS			
VK2LCD	Chris Meagher	SSB	1332 points
	1st Phil. Armstrong	Memorial Plaque/	
VK3JS	Ian Godsil	CW/SSB	576
VK5ZKT	Karsten Thole	SSB	472
VK4XY	George Down	CW	444
			1st VK
			2nd VK
			3rd VK
			4th VK

## Popular Contests

November will no doubt see CQWW CW as a very popular contest once again (at the time of writing this, the Oceania DX CW contest is tomorrow), with many VKs heard on the HF bands. Despite the sun-spot cycle causing hassles on the higher bands, DX should still be prevalent for the avid DXer to snare and get into the log.

Work pressures allowing, with a newly erected vertical quarterwave antenna for 80 m, I shall trawl through the band to see what is achievable with my QRP signal. I intend to spend some time before the contest running as many radials as I can find wire for beneath the antenna, to try and lower the angle of radiation as much as I can for DX.

For the Remembrance Day Contest, a higher angle would probably be better for VK/ZL working, so an antenna which worked well for a particular contest might not be the optimum antenna of choice for all contests. An inverted 'V' is probably best for the RD contest on 80 m, but I'm open to ideas / corrections! The All Asia contest and even Beru require targeted distant areas of the planet to be contacted, which might necessitate a review of antennae at your QTH to enable the best chance of getting the required stations into your log.

## Power and Modes

From personal experience, QRP operation can be difficult at times, as managing to get that multiplier into the log often takes a little longer than QRO, as a 'little pistol' is often beneath the band noise floor for the big guns to hear. Tail-ending a QSO or judicious judgement on when to call are amongst the QRPer's weapons of choice.

As a general rule, if the station is about S5 or greater, I should stand a reasonable chance of being heard in the melee. This philosophy does not always work for me on 40 m however, when the mega-strong Europeans appear cloaked behind some sort of semi-permeable propagation membrane! Try as I might, I probably won't gain a response unless my signal is significantly above the European noise floor.

It doesn't stop me trying though, as I was most surprised to be on the receiving end of a small pile up on 40 m the other week during the CQWW RTTY contest.

It seems to me that a rising star amongst contesting is that of data modes, but particularly RTTY. The need for large lumps of clanking metallic teletype machines has long since past, but some amateurs still choose to get on the air

with vintage equipment and they do exceptionally well in contests.

Personally, I don't have the real estate in the shack for such a mechanical beast and put the PC to good use instead, but whatever equipment you can assemble to get on the air and try a contest, it's worth having a go. Maybe I'll have a focus on data mode contesting in this column at a later date? Would anyone volunteer to be a sounding-block for me to bounce ideas off?

## Commonwealth Contest

Did someone mention Beru?

Beru, otherwise known as the Commonwealth Contest, will be celebrating its 70th birthday next year and will take place on 10 and 11 March 2007 at the same time as the Cricket World Cup 2007. In keeping with cricketing traditions, it is proposed to organise a Commonwealth Team Contest along cricket team lines, to run in parallel with the normal Commonwealth Contest. This is intended as a 'fun' event.

Teams will be drawn from Australia, Canada, New Zealand, United Kingdom and the Rest of the Commonwealth. Sides will comprise eleven members or players, with one designated as Captain. Players are single operator amateur radio stations. Sides will be self-selected. The score of a side will be the sum of the eleven individual player's scores. Each player in the winning side will receive a plaque prize which can be retained as a memento. Yaesu (UK) has agreed to sponsor individual plaques for the winning team in the Commonwealth Team Contest for 2007. See [www.beru.org.uk](http://www.beru.org.uk) for further details.

I'm sure that VK can put in a good appearance in the contest and give 'em a good run for their money! If you are interested in participating then please get in touch. I'm not the designated point of contact for arranging the Team, but we'll need to start somewhere and I'll be delighted to forward all names to the relevant organiser.

## Contributions Invited

If you have any contest related material for inclusion within the column, topics that you'd like covered or even some experiences and pictures you'd like to share, then please feel free to get in touch via [vk2baa@wia.org.au](mailto:vk2baa@wia.org.au). See you on the bands. 73 de Phil Smeaton VK2BAA

ar

## OzSpid Rotators

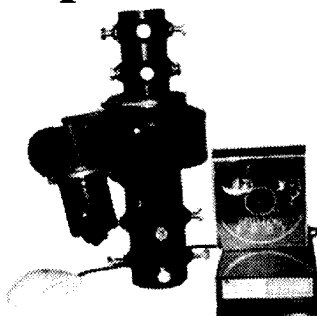

Oceania - New Zealand - Australian  
Distributors.

Australian Enterprise Industrial

P.O. Box 1013

Browns Plains. QLD. 4118.

Ph. 0414 254 080.

Fax. 07 3800 8003.

[aitower@spin.net.au](mailto:aitower@spin.net.au)

# Westlakes Cup Results

Last September Westlakes ARC, after having gained permission from the organisers of the defunct 'Wadda Cup', took over the organisation of that event, renaming it 'The Westlakes Cup'.

This was a first for Westlakes, as it had been many years since the club had involved itself in contests, let alone organising such a prestigious event. Any doubts that may have been in collective minds regarding the wisdom of this action have now been well and truly negated by the response to this contest.

The inaugural contest under the new name was held September 23rd with the deadline for log entries being midnight October 31. The winners and those who took part are listed below.

This year's event was restricted to VK entries only, but this rule may be adjusted in the future. The length of the contest was for one hour with a simplistic list of rules.

As this was a first for the club, Westlakes committee, under the direction of Contest Manager Paul VK2BPL, decided to encourage the newer Foundation Class to try their hand at contesting by making a separate section for the F troops, with appropriate awards being issued for both F calls and combined Standard /Advanced contestants.

Any contestant who indicated participation has already received, or will receive, recognition in the form of a certificate. First places in both sections have been awarded a commemorative 'Westlakes Cup', suitably engraved.

Congratulations to both the winners and place getters in both sections as well as those who helped make this, the first of what we hope will be many 'Westlakes Cups', such an outstanding success.

My personal thanks to Paul VK2BPL for his initiative.

## Confirmed scores and placegetters

### Advanced and Standard class

First:	VK7VH	Vince	37 points
Equal 2nd:	VK2AEA	Vlad	31 points
Equal 2nd:	VK3AAK	Michael	31 points
Third:	VK2VV	Graham	30 points

### Foundation class

First:	VK2FJES	Jessica	25 points
Second:	VK3FIDX	Brian	22 points
Third:	VK2FRKO	Richard	19 points

### Total logs received and station declarations

VK7VH	Vince	37	Cup Winner
VK2AEA	Vlad	31	Major Certificate Winner
VK3AAK	Michael	31	Major Certificate Winner
VK2VV	Graham	30	Major Certificate Winner
VK2LCD	Chris	29	
VK2ATZ/C	Dave	27	
VK2YP	Col	26	*
VK2LEE	Lee	25	
VK3MGZ	John	25	*
VK2FJES	Jessica	25	Cup Winner (Foundation)
VK3JS	Ian	24	
VK2ZEN	Michael	24	
VK3FIDX	Brian	22	Major Certificate Winner (F)
VK3HGA	Alan	19	
VK2FRKO	Richard	19	Major Cert. Winner (F)
VK2OJ	Alan	18	
VK3YXC	Ken	17	
VK3ECH	Rob	13	*
VK4ZJR	Ron	4	*
VK7AN	Al	4	*
VK3FORD/2	Matt	2	*

VK2BPL - Bonus station not eligible for award

\* Indicates no log received but a declaration was made at contest end.

Contributed by Frank Lusa VK2FJL

## Over to you

### RD Contest thoughts

As I understand it the original concept behind the RD Contest was to Honour the fallen amateurs from the 2nd World War. I personally believe that while we have many thousands of Australians on Service in a Foreign Country, we should be honouring any fallen "Australian Radio Amateurs Operators" from any overseas conflict, be it military or civil, as we have put our safe future their hands.

With the reduction in the numbers of the ex-service persons to remember our fallen mates it behoves those of us remaining and the new Amateur Radio Operators to carry on the memories of the operators that have paid the supreme sacrifice.

I would appreciate an email from you with your Brick Bats or Bouquets.

Peter Harding VK4OD  
vk4od@wia.org.au

**PERSONALISED QSL CARDS**



**Operator's name**

**Westlakes Amateur Radio Club Inc.**

# VK2ATZ

PO Box 3001  
Teralba NSW 2284  
Australia

MU Zone 69  
CQ Zone 80

**Confirming Contact with..**

**Rtg:**

**Antenna:**

**Pre-QSL via Bureau**

Personalised QSL cards bearing your callsign, Club's name and supplied logo. White gloss card, full colour with WIA logo watermark if a WIA member. Alternative microphone if not. 25 cents per card. Orders in batches of 4, Minimum order 40 cards. plus postage. Email: flusa@optusnet.com.au with details

This is a Westlakes Amateur Radio Club Project

# 2006 Remembrance Day Contest

RD Contest Manager:- Peter Harding  
 Email:- vk4od@wia.org.au

I would like to thank the Directors of the Wireless Institute of Australia for accepting me as the 2006 RD Contest Manager.

As you may be aware, I attempted to finalise the 2005 results after taking up the Contest Manager role. However, the 2005 RD contest data available was incomplete, preventing the presentation of a complete picture of the results. This year, I have designed software to aid the compilation of scores for the RD contest. This will ensure that no data is lost.

To lessen the error factor, all electronic logs were also copied to 2 others. Having done this and confirmed the accuracy of the presented logs, I am now able to advise the Winning State, the final top scorer for each state and the overall highest winner.

In 2004, a total of 303 logs was processed with a total of 27,441 points. Based on the (what I believe to be incomplete) data for 2005, we had a total of 271 logs with a points total of 36,171. This year, I processed a total of 392 logs amounting to 38,639 points.

While we can see the number of logs received is up on the previous years, I am unable to compare the points, as 2005 had some bonus point factors that were not available in 2004 and 2006. However, this year we welcomed the inclusion of the newly granted Foundation Calls to the contest; this year 13 Foundation Operators submitted logs for consideration.

On assuming the role as the RD Contest Manager, I set about trying to simplify this year's rules and in doing so I set a specified return date by which ALL logs must be received. Unfortunately, some logs were posted well after the closing date, making it necessary to return these unopened with a polite note on the envelope, stating why they were returned.

The total logs from each state are shown in Table 1. Please note that the data for 2004 and 2005 were obtained from sources other than my own; hence I cannot vouch for their accuracy. However, all care has been taken in the compilation.

Over the past 3 contests, VK6 had top overall points (HF and VHF). The modification of the rules for the 2006 contest assured that no one was assisted by extra points for any contacts that were in excess of 1000 km. This assisted in reducing the scoring

errors during the compilation period. I must comment that many operators DID NOT read the 2006 Rules, with some logs still recording invalid extra points for long distance contacts.

The overall top points individual winner this year is VK6WPR with 1216 points, VK7FN with 778 points, followed by VK7VG showing 685 points. The total of the points is a combination of HF and VHF. In the SWL category, the winner was Rex Craig from Western Australia with 674 points. In the overseas logs category, the winner was ZL1BYZ with 204 points.

The table below depicts each state by the highest points allocation:

The individual state winners are:

2006	Logs	Points
VK6	101	13,765
VK3	125	5244
VK2	38	4895
VK7	32	4511
VK4	49	4366
VK5/8	34	4478
SWL	3	832
VK1	7	684
O/seas	3	289

The high score individuals by state are:

VK1WX	with 362 Points
VK2WIA	with 612 Points
VK3BJA	with 492 Points
VK4ARI	with 620 Points
VK8BP	with 674 Points
VK6WPR	with 1216 Points
VK7FN	with 778 Points
SWL Category	R Craig with 674 Points
Overseas Stn	ZL1BYZ with 204 Points

As in the past, any scores for VK0 were aligned with VK7, and VK5 with VK8. This year's revised rules and introduction are available on the WIA website, in the contest area, along with a set of Cover and Log sheets.

Certificates to the winners will be issued as soon as they are printed and signed.

YEAR AREA	2004 Logs	2004 Points	2005 Logs	2005 Points	2006 Logs	2006 Points
VK0	n/a	n/a	n/a	n/a	n/a	n/a
VK1	1	128	15	1198	7	684
VK2	37	2558	14	2478	38	4895
VK3	51	1885	98	8151	125	5244
VK4	51	3274	28	4859	49	4366
VK5/8	44	3487	51	7865	41	4478
VK6	83	13,311	34	15,840	101	13,765
VK7	33	2494	31	4445	32	4511
SWL	n/a	n/a	2	1291	3	832
Overseas	2	304	n/a	n/a	3	289

Table 1. Total logs by Zone

# Individual Results for 2006 RD Contest

## HF CW Single Op

Call Sign	Score
VK5ATU	254
VK3JS	224
VK2BUI	194
VK4XY	178
VK6AFW	116
VK3QB/8	102
VK3KS	56
VK2CTN	54
VK3TX	54
VK5AU	54
VK2EL	52
VK2RJ	46
VK1II	44
VK4RE	42
VK5GO	42
VK7RO	32
VK6UT	19
VK4ARS	17

## HF Phone Multi Op

Call Sign	Score
VK7VG	675
VK5BP	674
VK2WIA	612
VK6WPR	378
VK3BML	370
VK3SOL	321
VK3BJA	252
VK2BOR	151
VK4VJG	115
VK4VV	82
VK3CNE	33

## HF Open

Call Sign	Score
VK2BPL	418
VK3SAY	411
VK1WX	362
VK5ZKT	332
VK5UV	305
VK5ST	277
VK2TS	232
VK1YBQ	224
VK7GDS	201
VK5MFW	186
VK7CK	185
VK5FAKV	116
VK5WO	112
VK5UKK	108
VK3ADW	105
VK5RV	100
VK5DJ	73
VK5AW	61
VK2RD	60

VK4ACB	60
VK3KMB	56
VK5ZFW	55
VK5FPJW	50
VK5XY	46
VK5FAAA	40
VK7JAB	37
VK3FNBL	30
VK6ED	26
VK1EY	25
VK4BSG	20
VK5UE	16
VK6JP	16
VK6AR	13
VK5BWA	12
VK1GS	11
VK2XT	9
VK3KB	4

## HF Phone Single Op

Call Sign	Score
VK7FN	778
VK2LCD	469
VK6VZ	414
VK4GFO	405
VK6LC	390
VK6WPR	378
VK2TZA	360
VK3YXC	354
VK2PBC	352
VK5ZKT	332
VK2GBF	320
VK4FABB	319
VK4FIDX	300
VK2NW	261
VK6SG	248
VK4GTM	243
VK7IF	242
VK3AVV	228
VK6WB	225
VK3FIFF	220
VK6DXA	205
VK2DF	203
VK6YS	195
VK2IT	188
VK6ADI	188
VK7KC	183
VK4ARI	176
VK2ZEN	160
VK3AGY	150
VK6UT	150
VK4TE	149
VK5HBG	147
VK5AJW	128
VK2ZCM	127
VK6ZN/4	127

VK4IZ	119
VK2LEE	114
VK4IFR	113
VK3SC	110
VK4KKN	100
VK4XYL	99
VK7GAG	97
VK4BAY	95
VK6KGD	95
VK4FLR	93
VK4GDX	92
VK3AFW	85
VK4VNE	83
VK3VT	79
VK4BTW	75
VK3FNJB	71
VK3AMW	70
VK4JRO	70
VK6MAC	70
VK6AAL	69
VK3SAT	67
VK2WL	63
VK4JK	63
VK7ZFX	60
VK2IRP	59
VK7ZJA	58
VK6CSW	56
VK6AM	56
VK5AIM	55
VK6TNT	55
VK5CO	54
VK6GV	52
VK6GF	52
VK4JM	50
VK5YX	50
VK2JAV	48
VK2CZ	45
VK2BAA	45
VK3BPN	45
VK4FLC	44
VK5TW	44
VK7LUV	42
VK4RC	41
VK2GLD	40
VK7RM	40
VK4YNF	37
VK3GAF	36
VK4SM	34
VK4DY	31
VK6AB	27
VK3BCZ	26
VK5RK	26
VK2EI	25
VK6NX	25
VK2IO	24

VK6CF	24
VK3XY	23
VK3ECG	22
VK3OW	21
VK5ATQ	21
VK7TAS	21
VK2AYL	20
VK4TFL	20
VK4EGT	20
VK4FFLS	19
VK3BYA	18
VK4SWE	18
VK6BDO	18
VK4OD	17
VK5UE	16
VK8HPB	16
VK5UE	16
VK4JPG	15
VK6RRF	15
VK5OF	14
VK3YAZ	13
VK6AR	13
VK2YW	12
VK3FCLL	12
VK4ACC	12
VK4VD	12
VK3FWF	11
VK7RF/1	11
VK5LZ	10
VK7NFC	10
VK6TTF	8
VK7ZAX	8
VK2JAM	7
VK2FRAY	7
VK2AAB	6
VK7ZMS	4
VK3XG	3
VK6BMW	2
VK6PMY	2
VK6PX	1
VK6SCS	1
VK6KAD	1

## VHF Open

Call Sign	Score
VK6TWJ	179
VK2BO	70
VK3KB	31
VK6SMG	25

## VHF Multi Op Phone

Call Sign	Score
VK6QL	251
VK6AD	251
VK6WK	250
VK6BY	250



VK6QD	249	VK6ADI	189	VK6CN	60	VK3AQ	17
VK3BJA	240	VK6JP	184	VK6PT	60	VK3US	17
VK6WPR	230	VK6MAC	183	VK7RM	60	VK3ZUF	17
VK3CNE	104	VK6SAA	183	VK6PMY	58	VK5AVQ	16
VK3SAT	61	VK6GU	183	VK3XA	57	VK3BYY	13
VK3SOL	9	VK6FJA	183	VK6AR	57	VK6GWF	13
VK6BY	3	VK6MM	181	VK4IFR	56	VK3AFW	12
VK6WK	3	VK3VT	156	VK6KGD	56	VK1GS	11
VK6AD	3	VK6KF	153	VK6BMW	53	VK5HGB	11
VK6QL	3	VK7GAG	146	VK6ZCT	51	VK7VKV	11
VK6QD	3	VK3GAF	141	VK5ATQ	50	VK7RF/1	11

**VHF Single Op Phone**

Call Sign	Score
VK6BDO	556
VK6RRF	541
VK6USB	480
VK7ZBX	380
VK6YS	372
VK4ARI	326
VK6WIA	305
VK6KGZ	302
VK6FIVE	292
VK6TNT	290
VK6CSW	289
VK7DF	276
VK6WIE	275
VK6AGR	254
VK7KEF	252
VK6NX	230
VK6WPR	230
VK6AAL	230
VK6KW	218
VK6KW	218
VK7TW	210
VK6GFR	208

VK6SCS	134
VK6KAD	134
VK3JK	132
VK3ASU	126
VK4AML	120
VK4ARI	118
VK6ZLT	116
VK7RR	116
VK6AO	113
VK6FTIM	111
VK7QF	110
VK7ZFK	108
VK7GDS	107
VK5ZKK	99
VK6ZKK	99
VK6ZLZ	98
VK5AIM	86
VK4ZDX	83
VK6OTN	80
VK4YAR	79
VK5FAAA	72
VK5FAAA	72
VK6YF	68
VK3ZPF	62
VK3SAT	61
VK5APR	60

VK6AR	57
VK4IFR	56
VK6KGD	56
VK6BMW	53
VK6ZCT	51
VK5ATQ	50
VK5XY	49
VK3ZAL	47
VK4ZA	47
VK6XC	47
VK6AB	44
VK4FLC	39
VK6OE	39
VK5KGB	37
VK3OW	35
VK3AVV	34
VK3XJU	32
VK3JWT	32
VK3JS	30
VK6TS	30
VK6WT	30
VK6GK	30
VK7ZMS	30
VK5SE	28
VK3FBAX	27
VK3FANF	25
VK5OF	24
VK2CZ	23
VK5PAV	22
VK3EWM	20
VK6LZ	20
VK3ACR	17

VK5ALX	10
VK7VG	10
VK2JAM	8
VK4OD	8
VK1EY	7
VK4XYL	7
VK2NW	6
VK2GLD	5
VK3BJV	5
VK4ACC	5
VK6TTF	3
VK3ECG	2
VK6ADI	1
VK6GV	1

**Receiving Section**

Call Sign	Score
R Craig VK6	661
VK7XGW	150
M Martin VK6	21

**Overseas Section**

Call Sign	Score
ZL1BYZ	204
ZL4JB	60
ZL2ALJ	25

**Summary of State by State for Logs and Points**

	VK0	VK1	VK2	VK3	VK4	VK5/8	VK6	VK7	SWL	O/S	
VHF Logs	0	2	5	29	11	14	65	14	0	0	140
VHF Points	0	18	112	1562	888	636	10035	1827	0	0	15078
HF Logs	0	5	33	96	38	27	36	18	3	3	259
HF Points	0	666	4783	3682	3478	3842	3730	2684	832	289	23986
Total Logs	0	7	38	125	49	34	101	32	3	3	392
Total Points	0	684	4895	5244	4366	4478	13765	4511	832	289	39064

**Leading State by "Points and Logs"**

State	VK6	VK3	VK2	VK7	VK4	VK5/8	SWL	VK1	O/S	VK0	Totals
Total Logs	101	125	38	32	49	34	3	7	3	0	392
Total Points	13765	5244	4895	4511	4366	4478	832	684	289	0	39064

**WYONG is Sunday February 18, 2007**

# Summer VHF-UHF Field Day 2007

John Martin VK3KWA, contest manager

## Dates

Saturday and Sunday January 13 and 14, 2007.

Duration in all call areas other than VK6: 0100 UTC Saturday to 0100 UTC Sunday.

Duration in VK6 only: 0400 UTC Saturday to 0400 UTC Sunday.

## Sections

- A: Portable station, single operator, 24 hours.
- B: Portable station, single operator, 8 hours.
- C: Portable station, multiple operator, 24 hours.
- D: Portable station, multiple operator, 8 hours.
- E: Home station, 24 hours.

Single operator stations may enter both Section A and Section B. If the winner of Section A has also entered Section B, his log will be excluded from Section B. The same applies to the winner of Section C if the station has also entered Section D.

## General Rules

A station is portable only if all of its equipment is transported to a place which is not the normal location of any amateur station. Operation may be from

any location, and stations may change locations during the Field Day. You may work stations within your own locator square. Repeater, satellite and cross-band contacts are not permitted.

One callsign per station. If two operators set up a joint station with shared equipment, they may choose to enter Section A or B as separate stations under their own callsigns, or Section C or D under a single callsign. If they enter Section A or B, they may not claim contacts with each other. Stations with more than two operators must enter Section C or D. Operators of stations in Section C or D may not make contest exchanges using callsigns other than the club or group callsign.

No contest operation is allowed below 50.150 MHz. Recognised DX calling frequencies must not be used for any contest activity. Suggested procedure is to call on .150 on each band, and QSY up if necessary.

Multiply the total by the band multiplier as follows:

6 m    2 m    70 cm    23 cm    Higher  
x 1    x 3    x 5    x 8    x 10

Then total the scores for all bands.

## Logs

Logs should cover the entire operating period and include the following for each contact: UTC time, frequency, station worked, serial numbers and locator numbers exchanged, points claimed.

## Cover Sheet

The cover sheet should contain the names and callsigns of all operators; postal address; station location and Maidenhead locator; the section(s) entered; the scoring table; and a signed declaration that the contest manager's decision will be accepted as final.

Please use the following format for your scoring table. In this example the operator has operated from one locator

Band	Locators Activated (10 points each)	+	Locators Worked (10 points each)	+	QSOs (1 point each)	x	Multiplier	=	Band Total
6 m	10	+	40	+	40	x	1	=	90
2 m	10	+	40	+	30	x	3	=	240
70 cm	10	+	40	+	20	x	5	=	350
Overall Total =									680

**Make your  
Amateur  
Radio  
hobby  
complete  
Compete!**

## Contest Exchange

RS (or RST) reports, a serial number, and your four digit Maidenhead locator.

## Repeat Contacts

Stations may be worked again on each band after three hours. If the station has moved to a new location in a different locator square, repeat contacts may be made immediately. If the station moves back into the previous locator square, the three hour limit still applies to stations worked from that square.

## Scoring

For each band, score 10 points for each locator square in which your station operates, plus 10 points for each locator square worked, plus 1 point per contact.

and worked four locators on each band:

A sample cover sheet and scoring table has been included in the postings on the WIA web site. Copies can also be obtained from the e-mail address given below.

## Entries

Paper logs may be posted to the Manager, VHF-UHF Field Day, 3 Vernal Avenue, Mitcham, Vic 3132. Electronic logs can be e-mailed to [vhf-contests@wia.org.au](mailto:vhf-contests@wia.org.au). The following log formats are acceptable: ASCII text, MS Office RTF, DOC, XLS or MDB (Format - Office 2000 or earlier).

Logs are requested by Monday, January 29, 2007. Early logs would be appreciated.

ar

# Know your second-hand equipment

## The Kenwood TS-820S and the Kenwood TS-830S HF transceivers

Ron Fisher VK3OM

### TS-820S

This month I want to look at an old favourite, and then the one that took over from it. The TS-820 was the first Japanese transceiver that I ever owned. Prior to that, I had used a few American transceivers, including a National NCX-3, which I still have, and later a Heathkit SB-101. This one has long gone, but I do have the later SB-102 in my collection.

The TS-820 appeared on the Australian market in late 1976. A Dick Smith advertisement in Amateur Radio for September of that year listed them at \$800, with the digital display an extra \$154. An external VFO was \$137. Not cheap. That would equate to well over \$3,000 in today's money.

Even after all these years, I consider the TS-820S one of the best transceivers ever built. Certainly, after the American

ones listed above, it was a revelation. Most 820s you will find around on the second-hand market these days have a digital frequency readout included but, as noted above, many of the early examples sold did not have this included. Watch out for this if you are considering buying a TS-820. Early production models were labeled TS-820; however, later, when the digital display was included, this was changed to TS-820S. Also, the early models did not have the spinner on the tuning control.

Both transmit and receive audio quality were above average, even by today's standards. I used mine with a Shure 444 microphone and have always received top quality audio reports. Kenwood used negative RF feedback on the final stage that produced IMD of around -40 dB, somewhat better than many current solid-state transceivers.

So, what is a fair price for a TS-820S today? First, keep in mind that they are around thirty years old and things can go wrong in that time. But, assuming that it performs to your satisfaction, and that it is in clean condition with not too many scratches on the cabinet and panel, then up to \$300 would be fair.

### TS-830S

The TS-830-S appeared on the market around mid-1981 with an advertised price of \$1,095. The TS-530S ran alongside it, was very similar in design and appearance, but sold for a slightly lower price.

The TS-830S has always been regarded as a top-notch transceiver and amateurs who own them tend to hold on to them.

Improvements over the TS-820S include the addition of the WARC bands of 10, 18 and 24 MHz; an improved RF speech processor; and a variable band-pass tuning which, when combined with the IF shift, gives excellent control of receiver selectivity. Also, the noise blanker was upgraded with a variable level control; and a transmit audio monitor is included. The digital readout is around 50% larger than the 820 but the one kHz calibrations are gone from the analog dial.

The rig was repackaged into a lower cabinet bringing the height down by 50 mm. Also, the overall weight is down by a whopping 2.5 kg that cannot all be put down to the smaller cabinet. I suspect the power transformer is a good bit smaller.

Incidentally, the almost identical looking TS-530 misses out on the band-pass tuning, the audio monitor and the RF speech processor, the latter being replaced with an audio compressor.

While the TS-830S gains a host of extra facilities over its older relation, in some ways I prefer the TS-820S. I like the sound of the received audio and, in particular, the AGC action. I am lucky enough to have one of each.

So what should you pay for a mint condition TS-830S? I would suggest around \$400. Of course, there are many around not in mint condition, in which case it's up to you.

Good luck. See you at the next hamfest.

ar

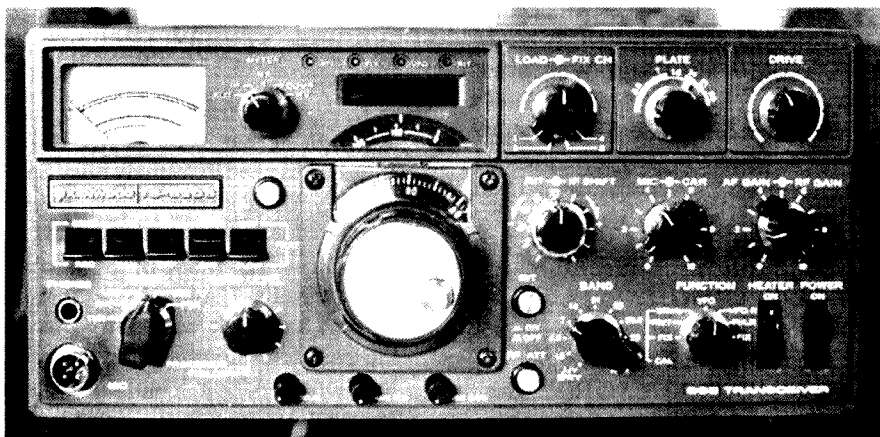

Photo 1 – The TS-820S HF transceiver.



Photo 2 – The TS-830S HF transceiver.

# DX - News & Views

VK4OQ, P.O. Box 7665, Toowoomba Mail Centre, QLD 4352.  
E-Mail — john.bazley@bigpond.com

Looking back over the year, we cannot complain at the DX activity despite the relatively poor HF conditions as we near the bottom of the current sunspot cycle. But it has been an opportunity to take advantage of the improved conditions on the Lower Frequency bands - 160, 80 and 40 metres.

The main problem facing most of us is to get up a reasonably efficient antenna for these Lower Frequencies within the space available to most amateurs.

This year two new entities, Montenegro and Swains Island were added. The former had enormous activity by an international group of amateurs, but Swains Island was a short operation, with more activity promised in 2007 (see below).

Other highlights undoubtedly were the operations from Peter I Island in February and the Andaman Islands in April which enabled many people to 'cross them off' their wanted list.

By the time you are reading this, we will have had both of the major CQ Contests, CW and SSB. Let us hope that conditions were good during those periods. It is an ideal opportunity for those chasing new countries to work them, particularly from dedicated DXpeditions, for the contest DXpedition operators will be looking for every QSO they can get!

December will see one of the biggest DX operations ever to take place from the 'number two' most wanted DXCC Entity - VU7 - Lakshadweep Islands.

Two groups, VU7RG (NIAR) and VU7LD (ARSI), will be active from four different islands with multiple stations being QRV.

The two teams may operate six or more at the same time on the same band and mode! Both teams are aware of the concerns from the DX community and potential DXpedition sponsors about confusion caused by overlapping operating frequencies, which will decrease the efficiency of the operation and the certainty of a reliable log entry.

Frequency management (i.e. strict frequency slots for all modes and bands to each operational site of both groups), will be important to ensure a well-regulated and trouble free operation. Members of both groups (ARSI and NIAR) will need to work out an agreement, before the activities begin.

An international team of twelve experienced operators, lead by Hrane Milosevic (YT1AD) and David Collingham (K3LP) will activate Swains Island from April 3<sup>rd</sup> to April 16<sup>th</sup> 2007, using the callsign N8S. Hrane and David have been in direct contact with Larry Gandy (AH8LG) to get a clear understanding of the island's requirements for permission to operate. Permission was confirmed by Larry Gandy on October 23<sup>rd</sup>, 2006. The N8S DXpedition team will include: YT1AD, K3LP, K1LZ, N3KS, N6TQS, RK3AD, RA3AUU, SV2BFN, UA3AB, RZ3AA, YZ7AA and YZ1BX.

The team will leave from American Samoa on Monday April 2<sup>nd</sup>, 2007, arriving and setting up camps on Tuesday April 3<sup>rd</sup>, 2007. The operation will begin late Tuesday April 3<sup>rd</sup>, 2007 and will end late Monday April 16<sup>th</sup>, 2007, providing 14 days of active operation. There will be a CW Camp, SSB Camp and Digital/6 Metre Camp each using Icom radios, ACOM amplifiers and the necessary antennas. The team will depart on Tuesday April 17<sup>th</sup>, 2007.

The QSL Manager and Web site information will be provided at a later date. At this time, there is no plan for daily on-line logging. The logs will be posted on-line after April 27<sup>th</sup>, 2007.

## Operations approved for DXCC credit.

The following operations are approved for DXCC credit: Democratic Republic of the Congo, 9Q1D, 9Q1TB, 9Q1EK, with current operations beginning September 22, 2006. For those who worked Ghis 9Q1NT just before he left, the DXCC desk is waiting for the necessary documentation to allow for DXCC credit. Knowing Ghis, this will happen in due course. For those readers still needing this entity, 9Q1EK and 9Q1D are regularly on 20 metres, the latter on both CW and SSB.

XT— Members of the F6KOP Provins ARS are heading up a multi-national DXpedition team to Burkina Faso in January 2007. Team members will include N6OX, Bob; N2WB, Bob; F2JD, Gerard; F2VX, Gerard; F5LMJ, Alain; F5TVG, Frank; OE8KDK, Dieter; F9IE, Bernard;

and F4AJQ, Frank. Look for activity on 6 through 160 metres on CW, SSB, RTTY, PSK, SSTV and possibly WSJT for 6 metres. They will have six rigs, two amps, and multiple antennas. Activity is expected between January 6<sup>th</sup> and January 20<sup>th</sup> next year. They do not know their callsign at this time. Plans are to have a Web page. QSL via F9IE, Bernard Chereau, P.O. Box 211, F-85330 Noirmoutier en L'île, FRANCE.

A3 — Mark VK2GND will operate as A35GN from Tonga (OC-049) from 25 December to 3 January. Look for him on or around 7050, 14195 and 14273 kHz. QSL via home call.

YX0A — Several people have asked about the QSL status of the April 2006 Aves Island (YX0A/YX0LIX) DXpedition. The QSL manager is Steve KU9C. YV5EED, Ramon, reports the cards are being printed by Icom America and expect to deliver them to KU9C's QTH by the first week in November. Once Steve gets them, he will begin sending them out.

5H3RK — A note from Ralph said that although he has been in 5H since July, he has been extremely busy and not, as yet, had an opportunity to get any antennas up or start operating.

UA4WHX — As most of us know, world traveller UA4WHX, Vladimir Bykov, has been very active over the past few months from various locations in Africa. Vladimir's QSL assistant Andrei reports "The QSL's for the Africa operations will be answered all together after the trip is over." Vlad was recently in V5 again for a short period following his operation from D2 but it is still not clear if he will activate another entity before returning home.

Special thanks to the authors of The Daily DX (W3UR) and 425 DX News (I1JQJ) for information appearing in this month's DX News & Views.

For interested readers you can obtain from W3UR a free two week trial from [www.dailydx.com/order.htm](http://www.dailydx.com/order.htm)

ar

## Weak Signal

David Smith - VK3HZ

Mid-October produced some good conditions between much of VK and ZL, hosting several record-setting contacts.

On the morning of October 12, conditions were good between Tasmania and central NZ. Rex VK7MO worked Nick ZL1IU on 2 m (5/2). They set two new digital-mode records on 2 m and 70 cm (see Digital DX Modes report below).

That evening, Steve VK2ZT worked Nick ZL1IU (5/1) and Bob ZL3TY (5/1). John VK2TK worked ZL3TY (5/3).

The following morning (October 13), the opening had moved up the coast. Ross VK2DVZ and VK2ZT reported hearing several ZL1 2 m beacons. ZL1IU worked VK2ZT (5/9+20), VK2DVZ (2 m - 5/9, 70 cm - 5/3) and VK4JMC (5/3). ZL3TY worked VK2FZ (5/2). ZL1IU worked VK4JMC, VK4WS, VK4ZQ and VK4AFL in Brisbane, VK2AWD, VK2FZ (5/2), VK4LC, VK2DVZ (5/7), VK2TS (5/9) and VK2GKA (5/5). VK2DVZ worked ZL2TAL (5/1). ZL1BT worked VK2ZT (5/2), VK2DVZ, VK2IF (5/1), VK4LC (5/5), VK2FZ, VK4WS, VK2EI/p, VK4JMC, VK2APG, VK2BZE, VK2MAX, VK2MJS and VK4AFL.

On October 14, Ross VK2DVZ reports working Steve ZL1TPH/P on 2 m (5/8) and 23 cm (5/3). He also worked ZL1SWW (5/7) and ZL1BT (5/7). Steve

ZL1TPH also reports working VK2ZT, VK2IF, VK2ARA, VK2EI, VK2MAX, VK2BA, VK2APG, VK2BZE, VK2FHN, VK2BHO, VK4JMC, VK4LC, VK4APG, VK4WSH and VK4TZL, all on 2 m.

Steve ZL1TPH makes these interesting observations about the VK/ZL path:

'Consistently in mid-October each year the high shearing winds from VK to ZL support good 2 m conditions. The Hepburn Predictions seem to accurately show this. Unfortunately, these good conditions don't reach to the higher band.

From the New Year, stable weather leads to steady openings and 2 m, 70 cm and 23 cm contacts will result. Hepburn once again is normally correct. Thereafter, bits and pieces through to March and April are to be expected.

This runs in cycles every season. What I have noticed is that the Hepburn predictions at the early stages of the season are not accurate."

On the other side of the continent, Tony Mann in Perth reports the first Spring tropo opening to Indonesia. Between 0020-0050 Z and 1100-1800 Z on 10 October, some 18 UHF TV carriers on 12 channels were detectable, originating from central Java.

Peter VK5ZPG at Quorn in central SA reports that on October 15, he had

some relatively good conditions. Quorn is well away from the coast, so most contacts are over purely land paths with no coastal tropo assistance. He worked Leigh VK2KRR at The Rock (893 km) on JT65B (has several times previously) - but also worked him on SSB (5/5). He also worked Brian VK5BC (5/8) and Peter VK5ZLX (5/4), both near Gawler - around 265km.

## Beacons

The Albany (Mt Barker) 144.564 MHz beacon is back on air in time for the summer DX season, thanks to the hard work of Don VK6HK. Don has to make the 820 km round trip from Perth to Albany to effect any repairs.

Rod VK2SMC reports that there is a new beacon running from his QTH at Nimmitabel on 432.414 MHz, with callsign VK2TWR. The beacon is currently using 2 x 28 el Yagis, but there are two Big Wheels from WIMO Germany ready to go up when the weather improves. Thanks to Joe VK7JG, for supplying the beacon, and Rex VK7MO for the crystal heater oven. Reports are requested to Rod at rcollman@bigpond.net.au .

Please send any Weak Signal reports to David VK3HZ at vk3hz@wia.org.au .

## Digital DX Modes

Rex Moncur - VK7MO

The high in the Tasman 10-12 October produced excellent propagation to ZL. Some operators used the extra sensitivity of JT65 when conditions were not up to SSB. From Hobart, Rex VK7MO worked Nick ZL1IU for new VK digital records on 144 MHz and 432 MHz over a distance of 2431 km. Wayne VK4WS worked Dave ZL1BT on 144 MHz using JT65.

Welcome to Wayne VK5APN and John VK2GCN, who have joined the meteor scatter group which operates weekends around 0600 to 0800 NSW local time on 144.230 MHz using FSK441. On Saturdays stations in VK3/5/7 transmit during the first period to VK1/2/4. The second listed area stations transmit in the second period. On Sundays VK1/2/3/5/7

transmit first period towards VK4. Stations in VK4 area transmit in the second period.

With the summer tropo-ducting season here, look for ducting extensions of meteor scatter using FSK441 on paths such as VK5 to ZL whenever there is a high on the eastern side of the Tasman.

Justin VK7TW and Rex VK7MO have been experimenting with JT65a for non-line-of-sight optical communication at 475 Terahertz (red light).

The equipment is designed and constructed by Mike VK7MJ, interfaced to computers running WSJT. Modulation is direct Amplitude Modulation of Light Emitting Diodes (LEDs) which has the advantage of not only simplicity, but the

Difference Frequency (DF) is always zero and you can more readily find a signal in the noise and birdies. The LEDs run at 300 milliwatts output to 20 x 18 cm Fresnel lenses.

Justin was in a valley and shielded by hills from Rex. Solution: Justin beamed down the valley, his signal was weakly scattered from a large white-painted building in line-of-sight to Rex. The direct distance between stations was only 1.2 km, but the light had to travel 8 km.

Signal reports were exchanged at -25 and -28 dB, on the WSJT scale, with 90% decodes at one end and around 50% decodes at the other. One problem is that normal city lights (particularly sodium vapour lights) produce birdies at odd

harmonics of 50 Hz across the frequency range used by JT65a (1270 to 1446 Hz).

However, by using the Freeze and Tolerance facility of WSJT, it is possible to lock on to the JT65 reference tone on 1270 Hz even with a strong birdie on 1250 Hz. While the next odd harmonic at 1350 Hz is within the JT65a band, the strong Forward Error Correcting coding, built into WSJT, is able to give perfect decodes despite such interference.

## The Magic Band – 6 m DX

**Brian Cleland – VK5UBC/BC**

The 6 m band finally came to life in mid-October with openings on most days between VK4, 2 and 3 and VK5, 4 and 2 and trans Tasman openings, VK2 and 3 to ZL.

The highlight was an opening to Japan from VK2, 3, 4 and 5 on Sunday 22nd October, probably the best such opening for some years with many reports of contacts over a very wide area of the country. Here is a summary of those reports:

From Leigh VK2KRR at The Rock near Wagga Wagga: "Just this afternoon (Sunday), I was lucky enough to work 8 stations on 50 MHz from Japan. I'm only running a 1/2 wave dipole orientated east-west for best signal. Stations worked JA6JNF; JA6RJK; JEIOHL; JA5CMO; JA1RJU; JH4ADV; JR2HCB; JG3GNU. This appeared to be a TEP link into Queensland with a Sporadic E extension to southern states. I was working VK4FNQ right before it opened to JA."

"Huge opening to JA this afternoon 22/10 1400 to 1500, worked 23 JA's from Tokyo to Kobe" - regards Bruce VK2AYM, Albury.

From Phil VK2ZZY in Sydney: "Sunday 22/10/06. In and out of the shack all day. At 0125 Z worked VK4ABW - 59+20, then at 0247 Z worked VK4FNQ - 59+15 then at around 0350 Z, I started hearing JA's calling but very weak. At 0406 Z I had a brief contact with JA5CMO. The contact was long enough to exchange calls and signal reports - 5x7 both ways then nothing! For about the next 30 minutes, I was copying video line buzz at strength 6-7 on 50.110. My location is QF56mb - this might give some idea as to the extent of the opening, as I saw on the logger that VK3SIX was also copying JA."

Norm VK3DUT near Bairnsdale reports: "From 0408 to 0434 Z, I worked JAs 1, 2, 3, 4, 5, 6, 7, 8, 9 and 0 for a total of 38 stations, 95% of signals were

A repeat attempt a few days later failed, resulting in only 30% decodes one way and nil the other, so there are still some things to learn about this type of propagation. A possible explanation is that, as it rained shortly before the repeat attempt, perhaps a wet building does not reflect as well. Another possibility is the difficulty of aiming with beamwidths of less than a degree.

S9+, not sure about after that as I had to get back to the job! 49.750 was in during the opening as was the VK4RTL/b which may have indicated an Es extension as the JAs were gone when the VK4 beacon disappeared yet the 49 MHz stuff was still there. Anyway, it's been a long time."

Peter VK5ZPG at Quorn PF97aq, had an opening around 0330 UTC today Sunday 22/10. "I worked Gary VK4ABW 5/8 from Townsville - great copy. Heard VK4BKP but was unable to claim contact by exchange of signal report. Several other VK4 stations and at least 4 JAs heard weakly. Lot of band noise. Good opening, considering I've only got a 6 m vertical - and it's cut for 54 MHz!"

Scott VK4CZ in Brisbane reported that at approx. 0330 Z there were weak JAs calling CQ on 50110.0 CW, mainly RST 419. "I responded to a JA7 (from memory), but signals quickly improved so the next call on SSB was responded to by JE1CUS with 59 reports exchanged. A further dozen JAs were worked over a 20 minute period before I returned to prepare for CQWW. I heard no other VK4's from QG62 during the opening. The most interesting aspect of the opening was the impact that an Es extension provided the southern VK stations. I had a direct TEP path, and had no signs of the southern stations, but the northern VK4's were reporting the southern VKs prior to and during the opening, allowing many VK2, 3 and 5s the chance to work JA at a time when they typically would not have been provided with propagation. Although I had lost the direct path, the Es link still sustained the opening to the southern stations for a while."

Peter VK5ZLX in the Barossa Valley thought he was back in Alice Springs working 14 JAs with signals over S9. Peter even took time out to check the JA beacons and other indicators from the north and reprogram them into his radio.

These experiments open up the possibility of non-line-of-sight optical communications and have the advantage that one can experiment on these frequencies from the comfort of one's home rather than spending freezing nights on hilltops.

Please send any Digital DX Modes reports to Rex VK7MO at rmoncur@bigpond.net.au .

Ivan VK5HS from Renmark reported that he and Larry VK5LA (Riverland area) worked several JA's between 0400 Z to 0445 Z. Signals started at 3/3 and increased up to 5/9. Stations worked included JE1CUS, JK1HCE, JA0JQS, JA1RJU, JH0HZO, JA6RJK, JF1KJC, JA1PVI, JO1ALS, and JH1KYA. Interestingly, both Frank VK4FLR & John VK4FNQ were 5/9 at the same time but they could not hear the JA stations. Ivan is running a FT847, 100 watts & 8-element Yagi at 70feet. Larry is using a FT736 and 5 element Yagi at 70 feet.

As can be seen the opening was very widespread with good strength signals.

Unfortunately, I missed the JA opening but my log indicates several contacts to northern & southern Queensland on 18th, 19th, 20th, 22nd, 24th, and 25th October. I also worked Phil VK2ZZY on the 1st November and John VK4FNQ on the 6th November.

Meanwhile good openings on 22nd October and 3rd November were reported by John VK4FNQ in Charters Towers and Gary VK4ABW north of Townsville. John reports working the following:

**22nd October** - VK3XQ, VK2BJ, VK3IDL, VK3FI, VK2BHO, VK2ZZY, VK5BC, VK5YX, VK2KRR, VK5HS, VK5LY;

**3rd Nov** - VK3DUT, VK5AKM, VK2FAD, VK2BZE, VK3JWZ, VK1AI, VK3KAY, VK3WN, VK2ARA, VK2BHO, VK2APG, VK2ZOM & **6th Nov** - VK5BC.

There have been several reports of hearing the FK8 and VK8RAS (Alice Springs) beacons in VK2, 3, 4 & 5 during late October/early November but no reports of contacts to these areas.

Only report from the west was from Graham VK6RO, who reported that the Dampier VK6RSX beacon was S9 into Perth on the 24 October.

From New Zealand Rod ZL3NW and

## All eyes on Antalya

A big event in telecommunications was the Plenipotentiary Conference of the International Telecommunication Union (ITU), in Antalya, Turkey from November 6 to 24th.

The "Plenipot" is the ITU's ultimate authority. Every four years, the Member States meet to consider changes to the organization's Constitution and Convention, adopt strategic and financial plans, and elect the senior management. Approximately 2,000 delegates attend.

Incumbent Secretary-General Yoshio Utsumi cannot run again so a new Secretary-General will be elected from six candidates. Two of these are current Deputy Secretary-General, Roberto Blois of Brazil, and the Director of the Telecommunication Development Bureau, Hamadoun Touré of Mali. Both are also term-limited and so must move "up or out." Other candidates are Marc Furrer of Switzerland, Matthias Kurth of Germany, Montasser Ouaili of Tunisia, and Muna Nijem of Jordan.

The Director of the Radiocommunication Bureau, Valery Timofeev of the Russian Federation, is eligible for re-election and is unopposed. There are four candidates for each of the other three senior posts: Deputy Secretary-General, Director of the Telecommunication Standardization Bureau, and Director of the Telecommunication Development Bureau.

A candidate for one of the 12 seats on the part-time Radio Regulations Board is Robert W. Jones, VE7RWJ. Bob served two terms as Director of the Radiocommunication Bureau and served as a consultant to the IARU at the 2003 World Radiocommunication Conference.

Also 46 Member States will be elected to the ITU Council, which meets annually to supervise the management of the ITU between Plenipotents.

The delegates in Antalya, and those they elect, face great challenges.

Member States have been unwilling

to increase their financial contributions. Normal increases in expenses and the costs of interpretation and translation of documents into the ITU's six official languages reduced of the ITU to keep up with the rapid pace of developments.

This has led to staff reductions and depressed morale. The outgoing Secretary-General has complained of 'responsibility without authority' as the Bureau Directors are elected by the Member States, not appointed by the Secretary-General.

The delegates will consider a name change for ITU! A Common Proposal submitted by several Arab States propose "International Telecommunication and Information Technology Union", reflecting a growing belief that "telecommunication" no longer covers ITU's responsibilities.

Observers at the Plenipot will be IARU Vice President Tim Ellam VE6SH and International Coordinator for Emergency Communications Hans Zimmermann HB9AQS/F5VKP.

## ITU-R study group 1 working parties meet in Munich

Volunteer IARU Technical Representative Ken Pulfer VE3PU represented the IARU at meetings of the ITU Radiocommunication Sector's Working Parties (WP) 1A and 1B in Munich, Germany October 9-13. WP 1A dealt with two topics of great interest to the Amateur Service: Interference from Power Line Telecommunication Systems (variously known as BPL, PLC or PLT) and a study of possible allocations above 275 GHz. WP 1B considered Software Defined Radio and Cognitive Radio.

Ken reports about BPL: "The updated Working Document towards a Preliminary Draft New Recommendation is a definite improvement over last year, but requires more work. It provides guidance to administrations dealing with domestic BPL installations that may cause

interference to radiocommunications services. The current version includes examples of interference measurements provided by Brazil, the North American Broadcasters Association, and CBS."

Work on the Draft Report will continue in a Correspondence Group, to produce an updated version for WP 1A next June. The IARU will be involved in the Group to protect the Amateur Service.

## IARU represented at Annual CISPR Meeting

The IARU was represented by IARU EMC Adviser Christian M. Verholt OZ8CY at the annual meeting of CISPR: The International Special Committee on Radio Interference, in Stockholm, Sweden September 11-20. CISPR develops (EMC) standards. As one might expect, voices representing industry are heard more frequently than are voices representing radio spectrum users. IARU participation is important to ensure CISPR standards are adequate to protect the Amateur and Amateur-Satellite Services.

IARU concerns at CISPR include:

- Interference from broadband emitters, including but not limited to BPL/PLC/PLT
- Interference from electronic lighting equipment
- Immunity standards for multimedia and information technology equipment (ITE)
- Interference from larger LCD and Plasma video screens

Christian notes a lack of appreciation for the unique nature of the radio spectrum below 30 MHz among CISPR participants. Radio amateurs - indeed, all who rely on the wonderful phenomenon of ionospheric propagation for long-distance communication - face a never-ending challenge to educate others regarding the need to protect this irreplaceable natural resource.

ar

## The Magic Band - 6 m DX continued

Bob ZL3NE report working into VK2, 3 & 4 on the 25th October.

I received a note from Richard VK4YRP to advise that the Sunshine Coast ARC has relocated its 6 m repeater VK4RSN from their clubrooms to Dulong approx. 350

m above sea level. The repeater output is 53.7 MHz and the input is 52.7 MHz. The club holds a net on the repeater every Friday at 7.30pm AEST.

The summer DX season has got off to a good early start and hopefully this

develops into a big sporadic E season in December & January.

Please remember to send any 6 m information to Brian VK5UBC/BC at [bcleland@picknowl.com.au](mailto:bcleland@picknowl.com.au).

ar

# Hamads classifieds **FREE**

## FOR SALE NSW

•Radio valves, all new and boxed. Send SASE for lists. Malcolm Sinclair VK2BMS QTHR Ph 02 9958 1114.

•ICOM IC-751A HF transceiver \$1250. KENWOOD PS30 13.8V 20A DC power supply o/v protect \$200. YAESU FT-227R transceiver \$125. ICOM AH2 all band ATU \$400. SPITIT VIPER 33,600 bps tel/fax modem \$115. All with manuals, all VGC, all ONO. Art Stowar VK2AS 02 9972 3540.

•ICOM IC-718 HF transceiver, new with ICOM PS215 power supply both in mint condition in original boxes with manuals. Serial no 0205295 and serial no 0205561, fitted with DSP \$1300. TenTec Argonaut VHF transceiver, new, in mint condition, model 516, serial no 06C10103 with manuals \$1250. MOTOROLA 8 amp power supply, suits TEN-TEC transceiver, model no APN6003A \$40. DICK SMITH function generator, model FG-30 in new condition. Serial no 20033100 with manuals \$150. Gordon VK2CSS 02 4821 0756 QTHR.

•TEN-TEC 20/6 metres converter, brand new and in mint conditions, 10 watts output \$200.00. YAESU FT-290R MkII with matching YAESU FT-2025 linear amplifier (25 watts), it comes with rubber flexible antenna, NiCads and mobile cradle \$390.00. YAESU FT-1500 2 m. Mobile FM, 50 watts output, in mint conditions, with mike, mobile mounting bracket, etc. Original package, \$300.00. RAMSEY CT-70 frequency counter, goes up to 600 MHz, with rechargeable batteries and manual, in perfect condition \$85.00. KENWOOD SW-100 SWR/Power meter, 140-450 MHz, power range 0-150 watts, in perfect condition \$95.00. Mirel, VK2BOD. Email adslqls8@tpg.com.au. Phone 02 4333 1823.

## WANTED NSW

•TRIO Model JR500S communications receiver data. Any information would be appreciated. Malcolm Sinclair VK2BMS QTHR Ph 02 9958 1114

•Workshop manual for BARLOW WADLEY

XCR-30 receiver. Happy to copy and return immediately. VK2BTT QTHR 02 9608 1935

## FOR SALE VIC

•20 MHz CRO HUNG CHANG VGC \$250 ono. VK3BK QTHR Phone 03 9879 1896. Also FREE Trafo Chassis two cover for 160 m 400 watt linear.

•ALINCO DX-70TH HF 100 W & 6 m 100 W all mode transceiver. Excellent condition in original box with book, \$750.00 Ian VK3XI ph 03 9580 6627.

•Communication receiver R-390A similar to last one advertised. Fully operational and rejuvenated. Photos on request \$900. COLLINS auto antenna tuner 180-L3 with plug as used with COLLINS HF xcvr 618 T or ARC-38 \$150. Avionic receiver R-1021/ARN-30D with control box and plugs. Covers 108 - 127 MHz \$150. LF receiver R-11A similar to the Q5er Command Rx covers 190 - 550 kHz \$ 60. No dynamotor which is same as for Command Rx. TEST STUFF: Navy CRO (new) used for radar checking as well as CRO to 15 MHz operates from 115 V Model OS-4B/AP. Price \$50. HP programmable/manual power supply Model 6624A four outputs at 40 watts; 2 at 0 - 7 or 0 - 20 volts and 2 at 0 - 20 or 0 - 50 volts. It uses the HP programming command set. Price \$150. VINTAGE: Historic AWA Tx/Rx type Z 55670 VHF (converted to 2 metres) used by Vic. Police at D24 back in the 60s A wall mounted unit and used by WICEN operator at that time. Price \$60. ODDS & SODS: Xtals 200 kHz - Calibrator HC-6/U case type CR-47/U Eight available price \$10 each posted. Control box C/605 for the ARC-33 uhf xcvr. Dial mechanism for BC-348 receiver. \$15. All items plus freight or personal collection. Pete Williams VK3IZ QTH R 03 5156 2053. email jupete@bigpond.net.au

## WANTED VIC

•I am trying to restore/complete my AN/TRC24 Radio system and I am looking for the following parts/units: Transmitter, T-302/TRC. Power Supply, PP-685/TRC. Receiver, R-417/TRC.

A Band Plug-in AM-1180/GRC. Amplifier/converter, AM-2537/TRA-25. Amplifier/Converter, AM-3204/TRC-24. Oscillator/Multiplier, 0-903A/TRC-24. Transformer, TF-167/TRC. and any other bits and pieces for this radio. Thanks for reading this. Regards, John Eggington VK3EGG johne@telpacific.com.au Mobile: 0409 234 672

## WANTED OLD

•Information re ICOM IC-PW1 linears. Please phone Alex VK4TE on 07 5547 7817 after 6pm

## FOR SALE SA

•VK5JST Antenna Analyser kits (see AR article May 2006). Build yourself an extremely useful item for your shack, and improve your HF antenna efficiency. For more details see www.scarc.org.au; contact SCARC PO Box 333 Morphett Vale SA 5162, or email: kits@scarc.org.au, submitted by Graham Thomas VK5HGT 5 Beechwood Grove Seaford SA 5169 tel: 08 8386 3344

## WANTED WA

•YAESU FT-680R 6 m all mode transceiver in good working condition. Please contact VK6ZTJ Trevor at QTHR or email to tam.elec@optusnet.com.au

## HF, VHF, UHF ANTENNAS & ACCESSORIES

Aluminium towers, guys etc  
Diamond VSWR/PWR meters.

HD copper antenna wire & insulators,  
TX tubes & pwr transistors,  
full range Croate Rotators

Quality coax cables & connectors.  
Free advice & catalogue.

## ATN Antennas

Ph 03 5492 2224 Fax 03 5482 2686,

email atnant@llnat.net.au  
PO Box 80, Birchip Vic 3483

## THE WIA QSL COLLECTION REQUIRES QSLs

All types welcome, especially rare DX pictorial cards, special issue. Please contact the Hon Curator, Ken Matchett VK3TL, 4 Sunrise Hill Road, Montrose Vic 3765, tel. (03) 9728 5350

## ADVERTISERS INDEX

AEL.....	52
Amateur Radio Bookshop.....	55
Andrews.....	17
cityonline.....	26
Com-ant-ena.....	16
G & C.....	16
Featurtach.....	34
Icom.....	0BC
Jenlax.....	26
Ozgear.....	49
Rippletach.....	26
TTS.....	32-33
Small ads.....	55
KVK.....	34
TET-Emtron.....	24
Vertex.....	IFC
Westlake.....	52
Winlink.....	31

## About hamads....

- Submit by email (preferred) or on the form on the reverse of your current Amateur Radio address flysheet. Please print carefully and clearly, use upper AND lower case.
- Separate forms for For Sale and Wanted Items. Please include name, address STD telephone number and WIA membership number if you do not use the flysheet.
- Deceased estates Hamads will be published in full, even if the ad is not fully radio equipment.
- WIA policy recommends that the serial number of all equipment for sale should be included.
- QTHR means the address is correct in the current WIA Call Book.
- Ordinary Hamads from those who are deemed to be in general electronics retail and wholesale distributive trades should be certified as referring only to private articles not being re-sold for merchandising purposes.
- Commercial advertising on these pages Contact Newsletters Unlimited.
- Copy typed or printed clearly please, and received by the deadlines shown on page 1 of each issue of Amateur Radio.

Email: [newunltd@bigpond.net.au](mailto:newunltd@bigpond.net.au)

Postal: Newsletters Unlimited, PO Box 431, Monbulk Vic 3793. Fax: 03 9756 7031

### TRADE PRACTICES ACT

It is impossible for us to ensure that the advertisements submitted for publication comply with the Trade Practices Act 1974. Therefore, advertisers and advertising agents will appreciate the absolute need for themselves to ensure that the provisions of the Act are strictly complied with.

### VICTORIAN CONSUMER AFFAIRS ACT

All advertisers are advised that advertisements containing only a PO Box number as the address cannot be accepted without the addition of the business address of the box-holder or seller of the goods.





## JACKSON BROS JACKSON OF THE UK IS BACK

Highest quality products made by UK craftsmen

[www.jacksonbrothers.com.au](http://www.jacksonbrothers.com.au)

Full range now off-the-shelf in Australia

Variable and trimmer capacitors, reduction drives, dials, ceramic standoffs  
CATALOGUES, PRICE LISTS AVAILABLE

CHARLES I COOKSON PTY LTD

11-13 Port Rd

Queenstown SA 5014

Tel: (08) 8240 3200 Fax: (08) 8240 3233

FreeFax 1800 673355 within Australia

Email: [sales@jacksonbrothers.com.au](mailto:sales@jacksonbrothers.com.au)

ALL MAJOR CREDIT CARDS ACCEPTED

SOLE AGENTS AUSTRALIA AND NEW ZEALAND



## AMIDON FERROMAGNETIC CORES

For all RF/electronic applications.

See our website for complete data on all cores.

[www.catchnet.com.au/~rjandusimports](http://www.catchnet.com.au/~rjandusimports)

RJ & US Imports

PO Box 431, Kiama NSW 2533.

A 3.5" PC disk containing all data is available for \$5.00 incl. post.

Agencies

Active Electronics, Tas

TTS Systems, Tyabb (VIC)

Tower Communications, Perth

Ozhel Services, Brisbane

MiniKits, Adelaide

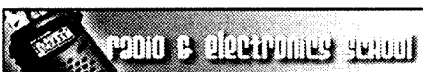

## Become a radio amateur

Check out the courses on offer from Australia's premier training institution for radio amateurs and hobbyists.

## Already licensed?

Upgrade to the Standard licence using our self paced multi-media CD ROM course.

The easiest way to become a licensed radio experimenter.

Discover digital communications, get more power and more bands

## Still want more?

Be guided by one of our experienced facilitators using our proven on-line study methods and get your Advanced licence.

Visit

[http://www.](http://www.radioelectronicschool.com)

[radioelectronicschool.com](http://www.radioelectronicschool.com)

for more information, or email the course manager at

[info@radioelectronicschool.net](mailto:info@radioelectronicschool.net)

Telephone 07-5573-2795 12-5PM AEST

Amateur radio – a bridge to careers in radio communications technology



## Tunable Loop Antenna enhances AM Reception

AM radio reception (530 to 1900KHz) enhanced. Reception where none existed before; works indoors, even in interference-polluted areas

High value — low cost.

Simple, no connections or batteries

Ideal for touring, caravan, boat and fringe areas. Use anywhere.

[www.amradioantennas.com](http://www.amradioantennas.com)

[pkloops@bigpond.net.au](mailto:pkloops@bigpond.net.au)

Paul 0412 302 939

PK's Loop Antennas

## RM Products Italy

are now available in Australia after the appointment of

Hamak Electrical Industries Pty Ltd

as distributor for RM products

Visit the Hamak website at

[Hamak.com.au](http://Hamak.com.au) for

**Linear amplifiers,  
Power supplies  
and accessories**

## VKHAM.COM

AUSTRALIAN AMATEUR RADIO

Hundreds of pages and links related to Amateur Radio and radio in general

Home of:

- VK Classifieds
- VK Auctions
- VK's on the Internet

Repeater Maps, Software, Prefix Maps and more ...

# Amateur Radio Bookshop

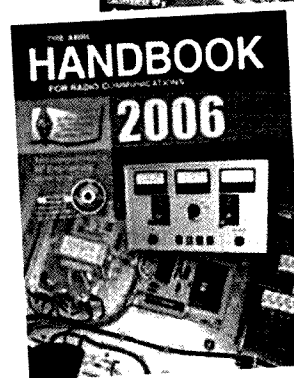
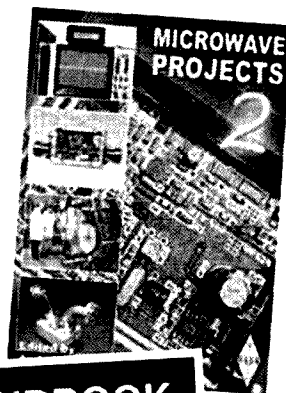

Download our catalogue at

<http://www.wia.org.au>

Amateur Radio Bookshop

PO BOX 3084

EAST BLAXLAND

NSW 2774

Office: WIA National Office

Tel 03 9528-5962

Fax 03 9523-8191

[bookshop@wia.org.au](mailto:bookshop@wia.org.au)

**ARRL – RSGB  
publications  
books  
magazines  
CDROMs - DVDs**



# Directory

## The Amateur Service:

a radio communications service for the purpose of self training, intercommunication and technical investigation carried out by amateurs, that is, by duly authorised persons interested in radio technique with a personal aim and without any pecuniary interest. 1.56 ITU Radio Regulations.

*The Wireless Institute of Australia represents the interests of all amateurs throughout Australia.*

The WIA offers one year and 5 year membership for all categories except Concession Student. The fees for each category are: Full members \$75 (\$365), Overseas members \$85 (\$403), Concession members (pensioner) \$70 (\$332), Concession members (student) \$70, Full members no magazine \$50 (\$237), Family members \$40 (\$190)

National Office	Contact	News Bulletin Schedule
10/229 Balaclava Road, Caulfield North VIC 3161, PO Box 2175 Caulfield Junction Vic 3162 Australia	Phone 03 9528 5962, Fax 03 9523 8191, 10am to 4pm daily, nationaloffice@wia.org.au http://www.wia.org.au	Subject to change. See www.wia.org.au follow National News prompts. Contact nationalnews@wia.org.au National VK1WIA news is distributed to all states.

Advisory Committees	Contact	News Bulletin Schedule
<b>VK1 Australian Capital Territory</b> VK1WX Alan Hawes VK1ZPL Phil Longworth VK1ET John Woolner VK1GH Gil Hughes	vk1advisory@wia.org.au	Sundays at 11.00 am VK1WIA 7.128, 146.950, 438.050 Canberra Region Amateur Radio Club Email newsletter will be sent on request to president@vk1.ampr.org
<b>VK2 New South Wales</b> VK2QV Chris Flak VK2XCD Chris Devery VK2BFN Adrian Clout	Phone 02 9689 2417 vk2wi@ozemail.com.au vk2advisory@wia.org.au	VK2WI - Sunday 1000 and 1930 hours local. 1.845; 3.595; 7.146; 10.125; 14.170; 28.320, 52.525; 145.600; 147.000; 438.525; 1273.500 megahertz. Plus regional relays. VK1WIA news included in the morning
<b>VK3 Victoria</b> VK3JJB John Brown VK3PC Jim Linton VK3APO Peter Mill	Phone 03 9885 9261 arv@amateurradio.com.au	VK1WIA, Sunday 11am and 8pm, 3.815 and 7.085 (LSB), 10.130 (USB), VK3RML 146.700, VK3RMM 147.250, VK3RMU 438.075.
<b>VK4 Queensland</b> VK4BY Don Wilchefski VK4ZZ Gavin Reibelt VK4KF Ken Fuller	vk4advisory@wia.org.au	VK1WIA, Sunday 9.0am via HF and major VHF/UHF rpters
<b>VK5 South Australia and Northern Territory</b> VK5OV David Box VK5APR Peter Reichelt VK5ATQ Trevor Quick	Phone 08 8294 2992 boxesdnm@lm.net.au peter.reichelt@bigpond.com vk5advisory@wia.org.au	<b>VK5 South Australia</b> VK5WI: 0900 am local time. 1.843 LSB, 3.550 LSB, 7.140 LSB, 28.470 USB, 53.1 AM, 147.000 FM Adelaide, 146.900 FM South East, 146.925 FM Central North, 439.975 FM Adelaide North. <b>VK8 Northern Territory</b> 0900 local time 3.655 LSB, 7.050 LSB, 10.130 USB, 146.900 FM.
<b>VK6 Western Australia</b> VK6NE Neil Penfold VK6XV Roy Watkins VK6QO Bruce Hedland-Thomas	Phone 08 9351 8873 http://www.vk6.net/ vk6advisory@wia.org.au vk6ne@upnaway.com vk6xv@bigpond.net.au	VK6WIA: 146.700 FM(R) Perth at 0930hrs Sunday relayed on 1.865, 3.564, 7.075, 10.125, 14.116, 14.175, 21.185, 29.120 FM, 50.150 and 438.525 MHz, Country relays 3.582, 147.200 (R) Cataby, 147.350 (R) Busselton, 146.900 (R) Mt William (Bunbury). 147.000 (R) Katanning and 147.250 (R) Mt Saddleback. Broadcast repeated on 146.700 at 1900 hrs Sunday relayed on 1.865, 3.564 and 438.525 MHz : country relays on 146.900, 147.000, 147.200, 147.250 and 147.350 MHz.. Also in "Realaudio" format from the VK6 WIA website
<b>VK7 Tasmania</b> VK7ZAX Phil Corby VK7DG Dale Barnes VK7KK Reg Emmett	Phone 03 6234 3553 vk7advisory@wia.org.au phil.corby@tassie.net.au vk7dg@wia.org.au regemm@ozemail.com.au	VK1WIA Sunday 9am on VK7WI network: 3.570MHz LSB, 146.700 MHz FM (VK7RHT South), 53.825MHz FM (VK7RAD South), 147.000MHz FM (VK7RAA North), 146.750 FM & 53.825MHz (VK7RNW North West), 146.625 MHz FM (VK7RMD North West), UHF CB Channel 15 (Hobart) and 27MHz CB - 27.225MHz LSB (Hobart). Followed at 9:30am with VK7 Regional News Broadcast also on 7.090MHz LSB & 14.130MHz USB

### Notes

1. Only three members of the state advisory committees are listed.
2. All listings are preliminary. They will be updated each month as required.
3. Membership application forms are available from the WIA web site www.wia.org.au or the national office address above.

# NOW AVAILABLE

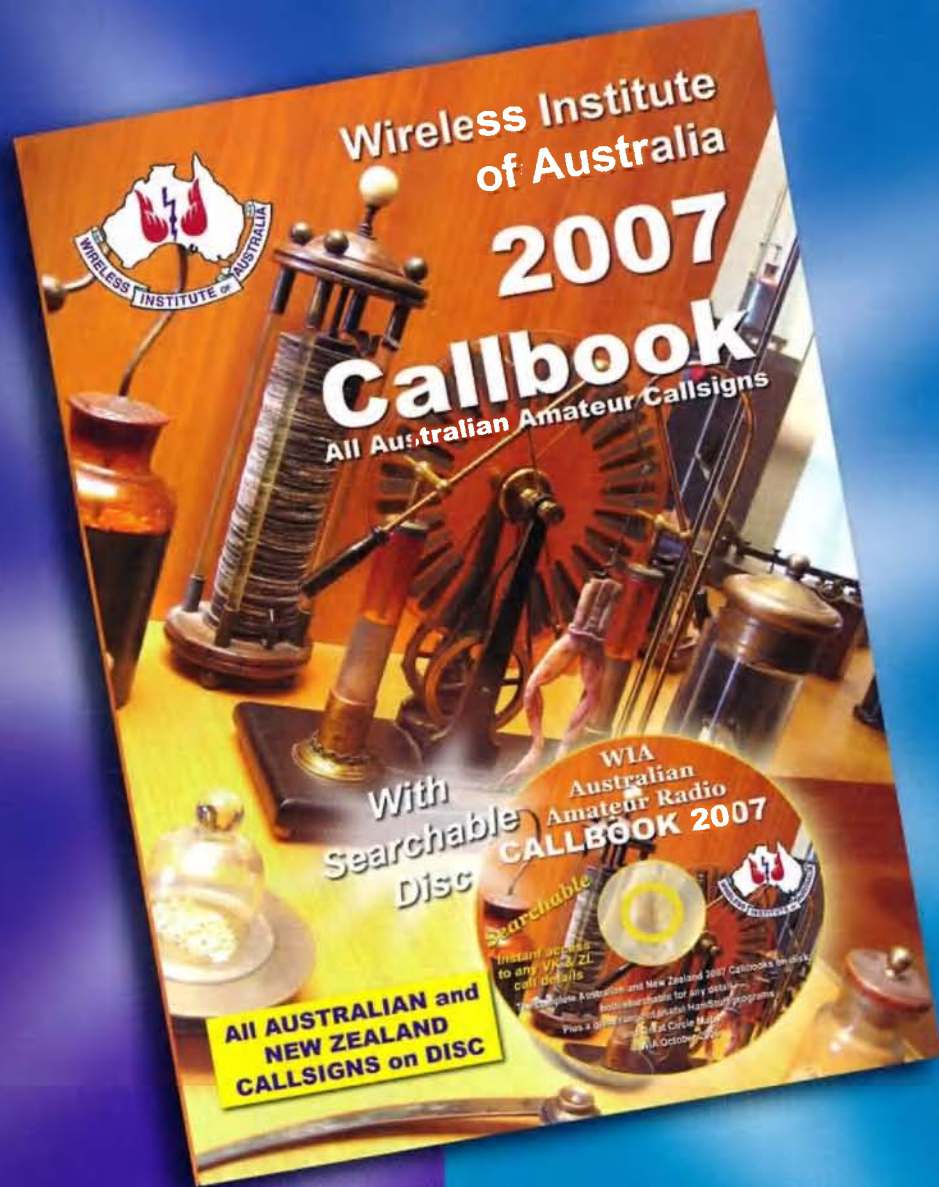

**Contact WIA National Office on  
03 9528 5962 or download an  
order form from the  
website  
[www.wia.org.au](http://www.wia.org.au)**

\$25 mailed to members  
\$33 mailed to non-members

# ICOM's price break through

## most affordable prices ever



### IC-7000

HF/VHF/UHF All mode Transceiver • 100W HF/50MHz, 50W/2m, 35W/70cm • IF DSP for superior noise rejection • User selectable digital filters for enhanced selectivity • 2.5" TFT colour display for bright easy reading • Remote control Mic for simple mobile control • Digital voice storage • 2 mode band scope • Multi-function meter including VSWR display • Built in RTTY modulator



### IC-756PRO III

HF/6m • Sharp & soft IF filter shape • New receiver gives +30dBm third-order intercept point • Built-in antenna tuner • One-touch record/play • Digital voice memory • Extended 1/4 Tuning step & BPF functions for SSB-D mode • 32-bit floating-point DSP and 24-bit AD/DA converter • SSB/CW synchronous tuning • 5-inch colour TFT LCD • Customisable filter shap • No optional filters to buy

Amateur



### IC-7800

HF/6m • Four 32-bit floating point DSP units • +40dBm ultra high intercept point • Automatic tracking pre-selector • Two completely independent receiver circuits • 200W output power at full duty • Built-in antenna tuner • Ultra high frequency stability • 7-inch wide color TFT LCD • Multi function spectrum scope • RTTY / PSK31 operation without PC connection • Four configurable antenna ports • Digital Voice Recorder • CF memory card.



### IC-2200H

VHF 2m FM Transceiver • High (65W) Power Output • DTCS & CTCSS Tone Squelch • DTMF Encode & Decode (with optional UT108) • Digital Voice & Data Communication (with optional UT118) • 207 Alphanumeric Memories



### IC-P7A

VHF/UHF (2m/70cm) Dual-band FM Handheld Transceiver • Ultra compact body, light weight 47x81x28mm, 160g • Mini-power VHF/UHF dual bander with wideband receiver 0.495-999.990MHz • 1800mAh large capacity Li-Ion battery allows 20hours operating time (Tx:Rx:Standby=5:5:90) • 1.5W output power on 2m & 1W output power on 70cm • Simple operation • 1000 memory channels with flexible memory bank system • Oversize LCD for clear display of function information



### IC-T90A

A new 5W Triband handheld • VHF/UHF FM 6m, 2m, & 70cm Wideband receive 495kHz - 1GHz • 555 alphanumeric memories • DTMF keyboard for IRLP operation • Tone encode and decode

ICOM

ICOM 163

Call your local ICOM dealer [www.icom.net.au](http://www.icom.net.au) or (03) 9549 7500